



2.5 intermodulation spurious emissions

For GSM mode:

2.5.1 Input frequency:

1)in lower edge test:f1 is the lower edge frequency +1 channel frequency, and f2 is +2 channel frequency

f1=869.6MHz,f2=870.2MHz

2)in higher edge test:f1 is the higher edge frequency -2 channel frequency, and f2 is -1 channel frequency

f1=892.8MHz,f2=893.4MHz

base the 3rd product frequency F1= 2f1-f2 and F2=2f2-f1, when the f1 and f2 frequency select above,

- c) in lower edge test, F1=2f1-(f1+Δf)=f1-Δf=lower edge frequency;
d) in higher edge test, F2=2f2-(f2-Δf)=f2+Δf=higher edge frequency.

F1=869MHz,F2=894MHz

base the 5th product frequency F1= 3f1-2f2 and F2=3f2-2f1, when the f1 and f2 frequency select above,

- c) in lower edge test, F1=3f1-2(f1+Δf)=f1-2Δf=lower edge frequency;
d) in higher edge test, F2=3f2-2(f2-Δf)=f2+2Δf=higher edge frequency.

F1=868.4MHz,F2=894.6MHz

base the 7th product frequency F1= 4f1-3f2 and F2=4f2-3f1, when the f1 and f2 frequency select above,

- c) in lower edge test, F1=4f1-3(f1+Δf)=f1-3Δf=lower edge frequency;
d) in higher edge test, F2=4f2-3(f2-Δf)=f2+3Δf=higher edge frequency.

F1=867.8MHz,F2=895.2MHz

2.5.2 Input power:-20dBm

Table with 4 columns: measure frequency, product Value (dBm), Limit (dBm), and Magin (dB). It contains data for 3rd, 5th, and 7th order products at lower and higher edge tests.



SGS-CSTC Standards Technical Services Co., Ltd.

Report No.: GZEM130300086303

Page: 57 of 140

FCC ID: OJFGXCPLA-40

	Higher:895.2MH z	-19.53		6.53
--	---------------------	--------	--	------



For CDMA mode:

2.5.3 Input frequency:

1)in lower edge test:f1 is the lower edge frequency +1 channel frequency, and f2 is +2 channel frequency

$f1=871\text{MHz}, f2=873\text{MHz}$

2)in higher edge test:f1 is the higher edge frequency -2 channel frequency, and f2 is -1 channel frequency

$f1=890\text{MHz}, f2=892\text{MHz}$

base the 3rd product frequency $F1= 2f1-f2$ and $F2=2f2-f1$, when the f1 and f2 frequency select above,

- e) in lower edge test, $F1=2f1-(f1+\Delta f)=f1-\Delta f$ =lower edge frequency;
- f) in higher edge test, $F2=2f2-(f2-\Delta f)=f2+\Delta f$ =higher edge frequency.

$F1=869\text{MHz}, F2=894\text{MHz}$

base the 5rd product frequency $F1= 3f1-2f2$ and $F2=3f2-2f1$, when the f1 and f2 frequency select above,

- e) in lower edge test, $F1=3f1-2(f1+\Delta f)=f1-2\Delta f$ =lower edge frequency;
- f) in higher edge test, $F2=3f2-2(f2-\Delta f)=f2+2\Delta f$ =higher edge frequency.

$F1=867\text{MHz}, F2=896\text{MHz}$

base the 7rd product frequency $F1= 4f1-3f2$ and $F2=4f2-3f1$, when the f1 and f2 frequency select above,

- e) in lower edge test, $F1=4f1-3(f1+\Delta f)=f1-3\Delta f$ =lower edge frequency;
- f) in higher edge test, $F2=4f2-3(f2-\Delta f)=f2+3\Delta f$ =higher edge frequency.

$F1=865\text{MHz}, F2=898\text{MHz}$

2.5.4 Input power:-20dBm

measure frequency		product Value (dBm)	Limit (dBm)	Magin (dB)
3 rd	Lower:869MHz	-23.04	-13dBm	10.04
	Higher:894MHz	-23.27		10.27
5 rd	Lower:867MHz	-26.48	-13dBm	13.48
	Higher:896MHz	-27.12		14.12
7 rd	Lower:865MHz	-28.59	-13dBm	15.59
	Higher:898MHz	-29.04		16.04



SGS-CSTC Standards Technical Services Co., Ltd.

Report No.: GZEM130300086303

Page: 59 of 140

FCC ID: OJFGXCPLA-40



For WCDMA mode:

2.5.5 Input frequency:

1)in lower edge test:f1 is the lower edge frequency +1 channel frequency, and f2 is +2 channel frequency

$f1=872\text{MHz}, f2=875\text{MHz}$

2)in higher edge test:f1 is the higher edge frequency -2 channel frequency, and f2 is -1 channel frequency

$f1=888\text{MHz}, f2=891\text{MHz}$

base the 3rd product frequency $F1= 2f1-f2$ and $F2=2f2-f1$, when the f1 and f2 frequency select above,

- g) in lower edge test, $F1=2f1-(f1+\Delta f)=f1-\Delta f$ =lower edge frequency;
- h) in higher edge test, $F2=2f2-(f2-\Delta f)=f2+\Delta f$ =higher edge frequency.

$F1=869\text{MHz}, F2=894\text{MHz}$

base the 5rd product frequency $F1= 3f1-2f2$ and $F2=3f2-2f1$, when the f1 and f2 frequency select above,

- g) in lower edge test, $F1=3f1-2(f1+\Delta f)=f1-2\Delta f$ =lower edge frequency;
- h) in higher edge test, $F2=3f2-2(f2-\Delta f)=f2+2\Delta f$ =higher edge frequency.

$F1=866\text{MHz}, F2=897\text{MHz}$

base the 7rd product frequency $F1= 4f1-3f2$ and $F2=4f2-3f1$, when the f1 and f2 frequency select above,

- g) in lower edge test, $F1=4f1-3(f1+\Delta f)=f1-3\Delta f$ =lower edge frequency;
- h) in higher edge test, $F2=4f2-3(f2-\Delta f)=f2+3\Delta f$ =higher edge frequency.

$F1=863\text{MHz}, F2=900\text{MHz}$

2.5.6 Input power:-20dBm

measure frequency		product Value (dBm)	Limit (dBm)	Margin (dB)
3 rd	Lower:869MHz	-22.55	-13dBm	9.55
	Higher:894MHz	-21.46		8.46
5 rd	Lower:866MHz	-27.42	-13dBm	14.42
	Higher:897MHz	-28.09		15.09
7 rd	Lower:863MHz	-29.64	-13dBm	16.64



SGS-CSTC Standards Technical Services Co., Ltd.

Report No.: GZEM130300086303

Page: 61 of 140

FCC ID: OJFGXCPLA-40

	Higher:900MHz	-29.58		16.58
--	---------------	--------	--	-------



For LTE mode:

2.5.7 Input frequency:

1)in lower edge test:f1 is the lower edge frequency +1 channel frequency, and f2 is +2 channel frequency

f1=874MHz,f2=884MHz

2)in higher edge test:f1 is the higher edge frequency -2 channel frequency, and f2 is -1 channel frequency

f1=879MHz,f2=889MHz

base the 3rd product frequency F1= 2f1-f2 and F2=2f2-f1, when the f1 and f2 frequency select above,

- i) in lower edge test, F1=2f1-(f1+Δf)=f1-Δf=lower edge frequency;
j) in higher edge test, F2=2f2-(f2-Δf)=f2+Δf=higher edge frequency.

F1=869MHz,F2=894MHz

base the 5th product frequency F1= 3f1-2f2 and F2=3f2-2f1, when the f1 and f2 frequency select above,

- i) in lower edge test, F1=3f1-2(f1+Δf)=f1-2Δf=lower edge frequency;
j) in higher edge test, F2=3f2-2(f2-Δf)=f2+2Δf=higher edge frequency.

F1=859MHz,F2=904MHz

base the 7th product frequency F1= 4f1-3f2 and F2=4f2-3f1, when the f1 and f2 frequency select above,

- i) in lower edge test, F1=4f1-3(f1+Δf)=f1-3Δf=lower edge frequency;
j) in higher edge test, F2=4f2-3(f2-Δf)=f2+3Δf=higher edge frequency.

F1=849MHz,F2=914MHz

2.5.8 Input power:-20dBm

Table with 4 columns: measure frequency, product Value (dBm), Limit (dBm), and Margin (dB). It contains data for 3rd, 5th, and 7th order products, showing lower and higher edge frequencies, their product values, a -13dBm limit, and resulting margins.

Remark:



SGS-CSTC Standards Technical Services Co., Ltd.

Report No.: GZEM130300086303

Page: 63 of 140

FCC ID: OJFGXCPLA-40

No other intermodulation spurious emissions of above 7rd have been found,so only record the test data about the 3rd, 5rdand 7rd



3. Downlink: 1930MHz to 1995MHz(GSM,CDMA,WCDMA,LTE)

3.1 GSM Mode:

3.1.1 one signal input —Lower Edge

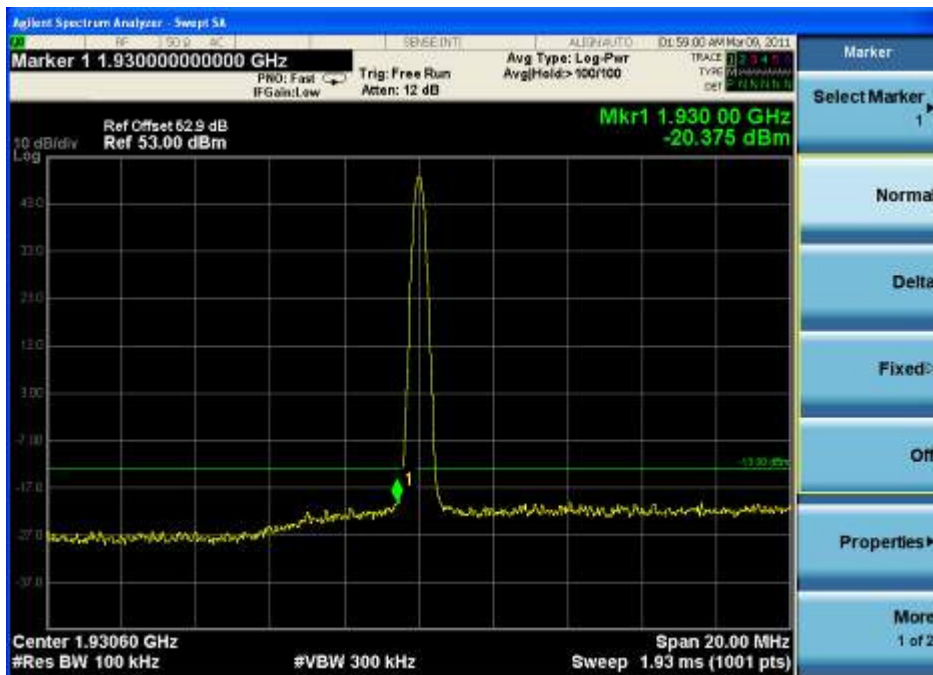

3.1.2 one signal input — Upper Edge

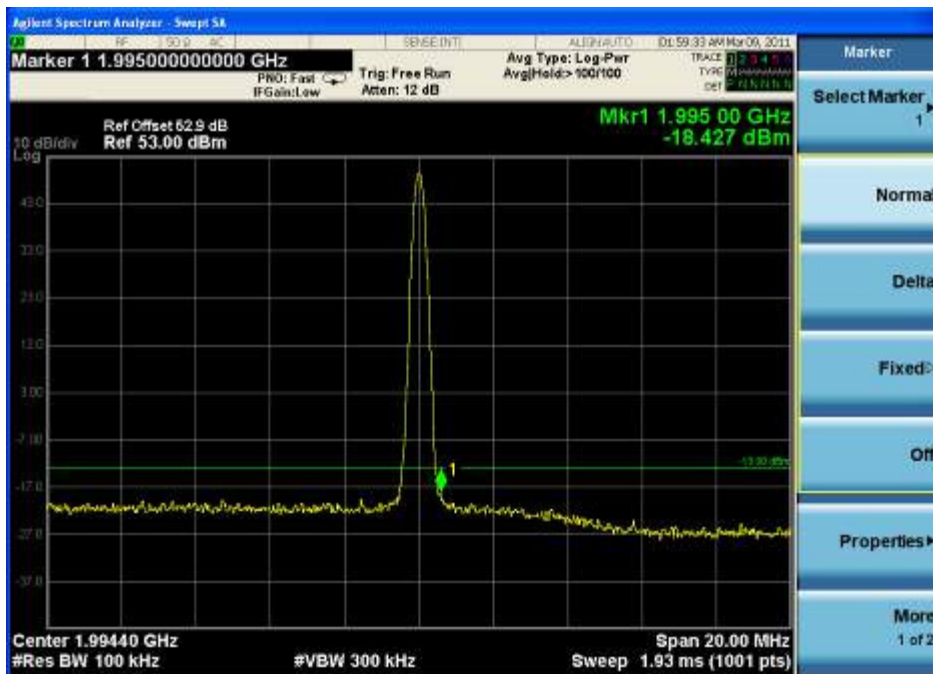

3.1.3 two signal input —Lower Edge

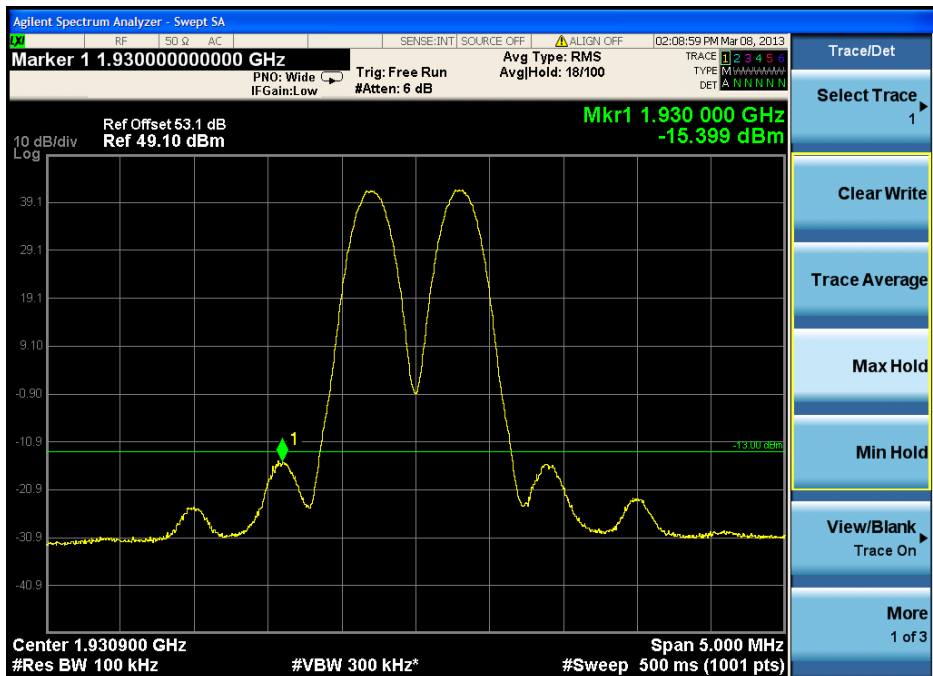

3.1.4 two signal input —Upper Edge

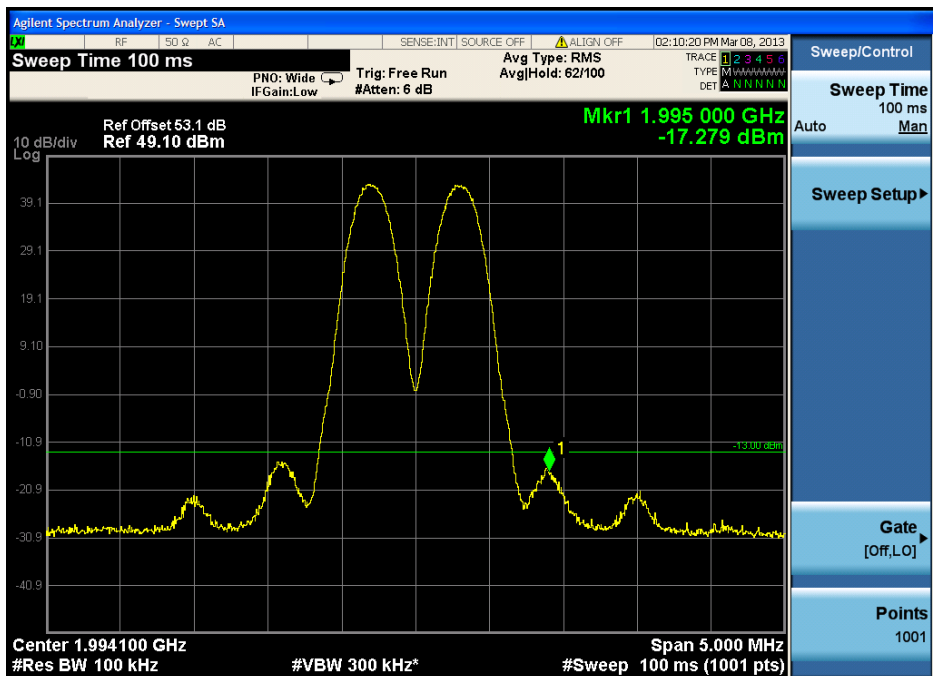



3.2 CDMA Mode:

3.2.1 one signal input —Lower Edge

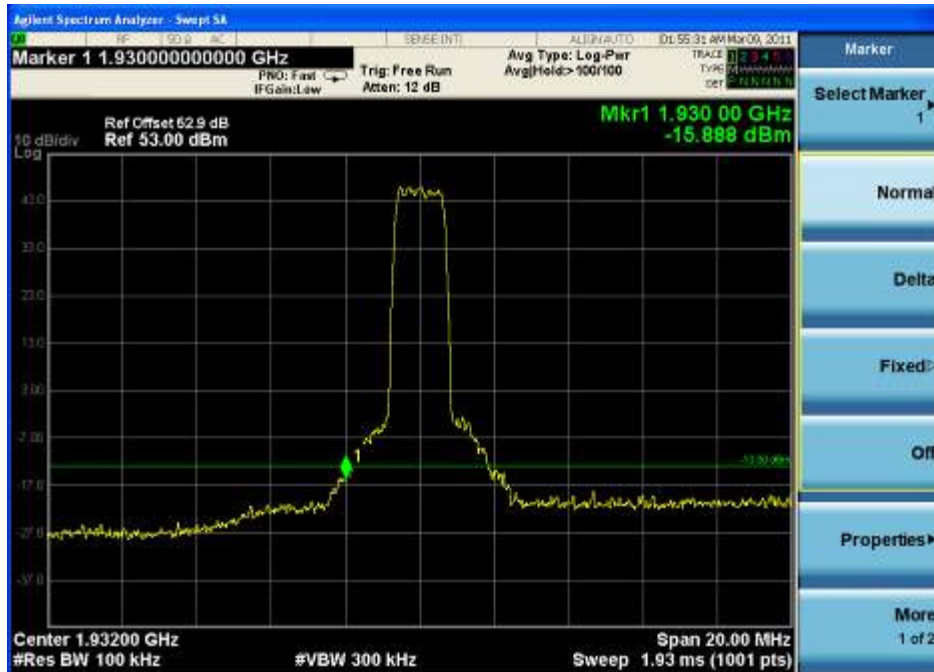

3.2.2 one signal input — Upper Edge

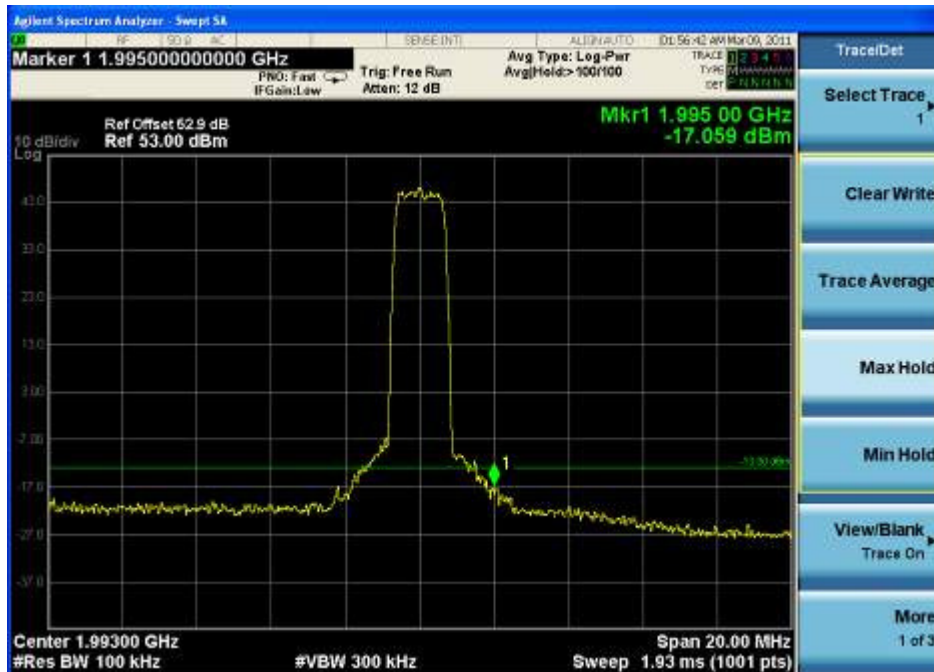

3.2.3 two signal input —Lower Edge

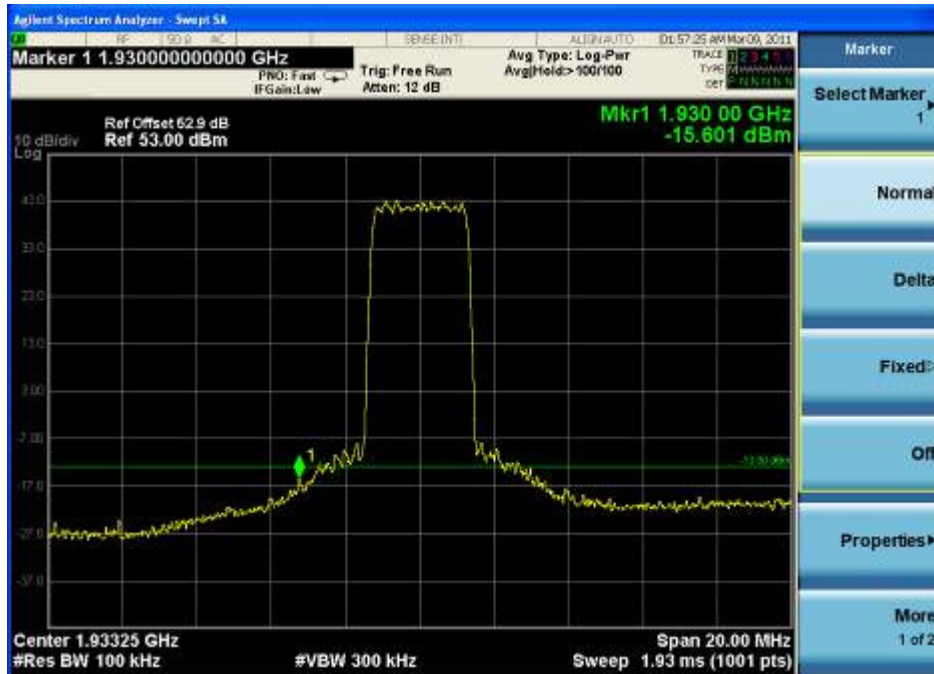

3.2.4 two signal input —Upper Edge

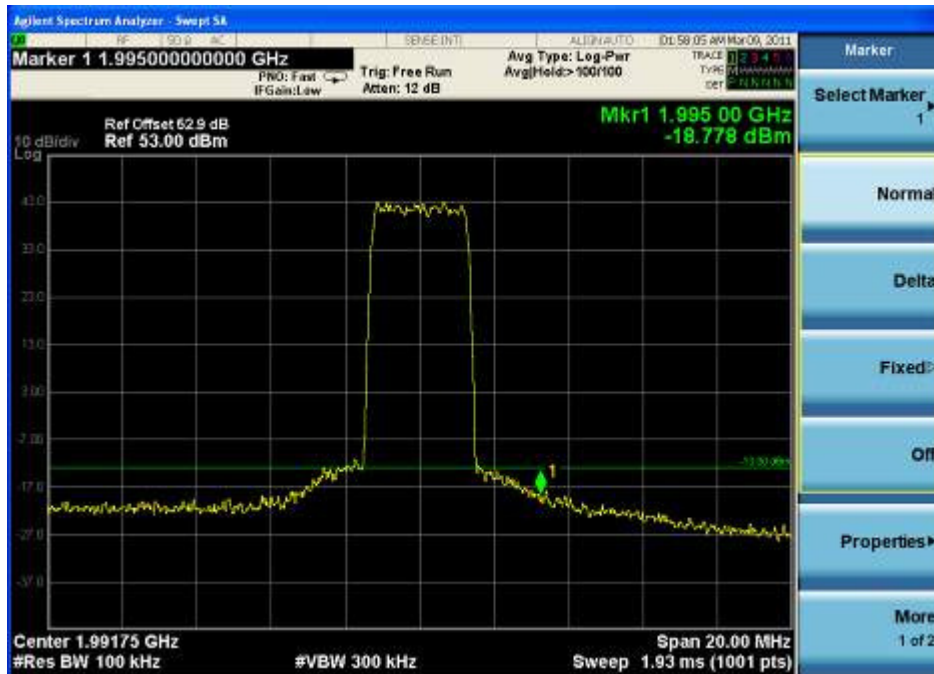



3.3 WDMA Mode:

3.3.1 one signal input —Lower Edge

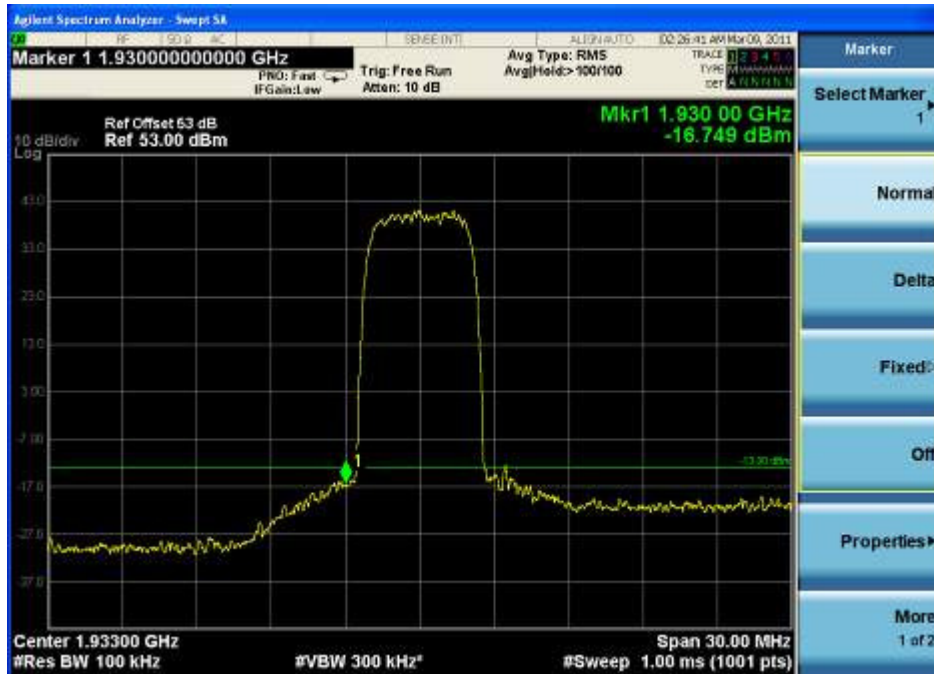

3.3.2 one signal input — Upper Edge

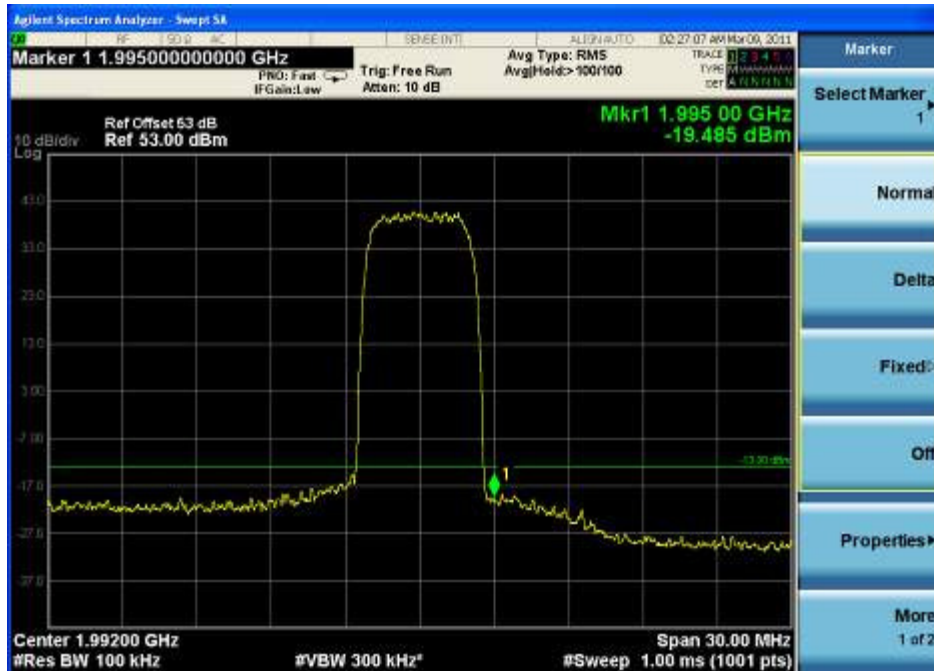

3.3.3 two signal input —Lower Edge

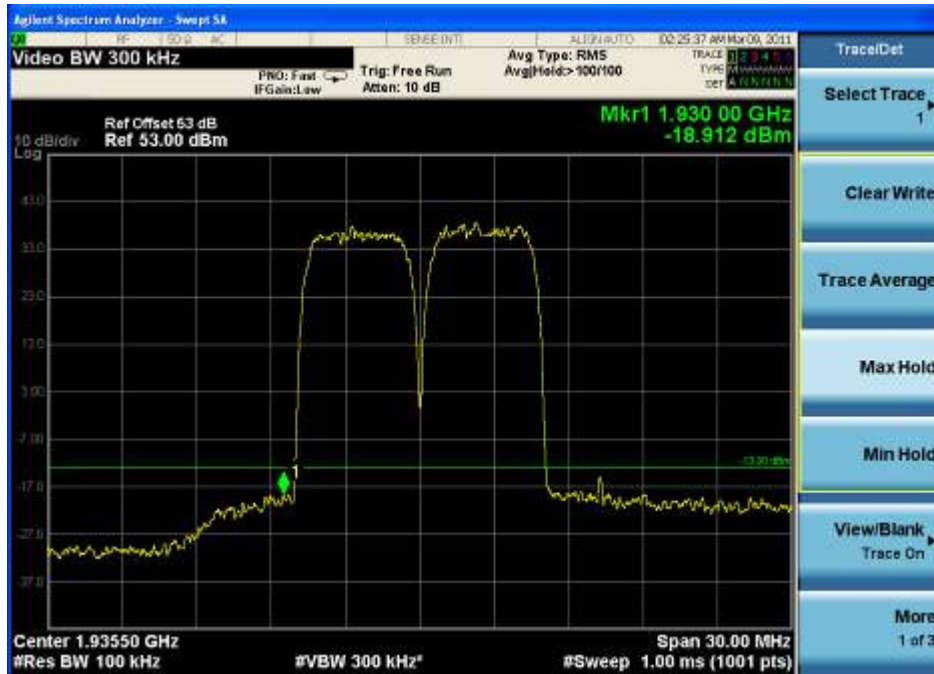

3.3.4 two signal input —Upper Edge

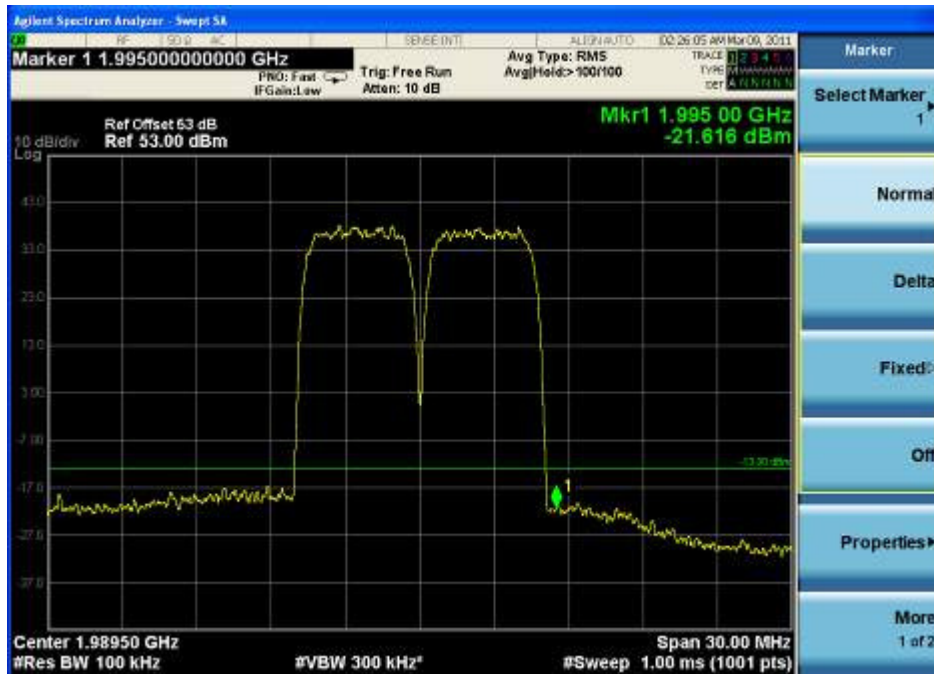



3.4 LTE Mode:

3.4.1 one signal input —Lower Edge

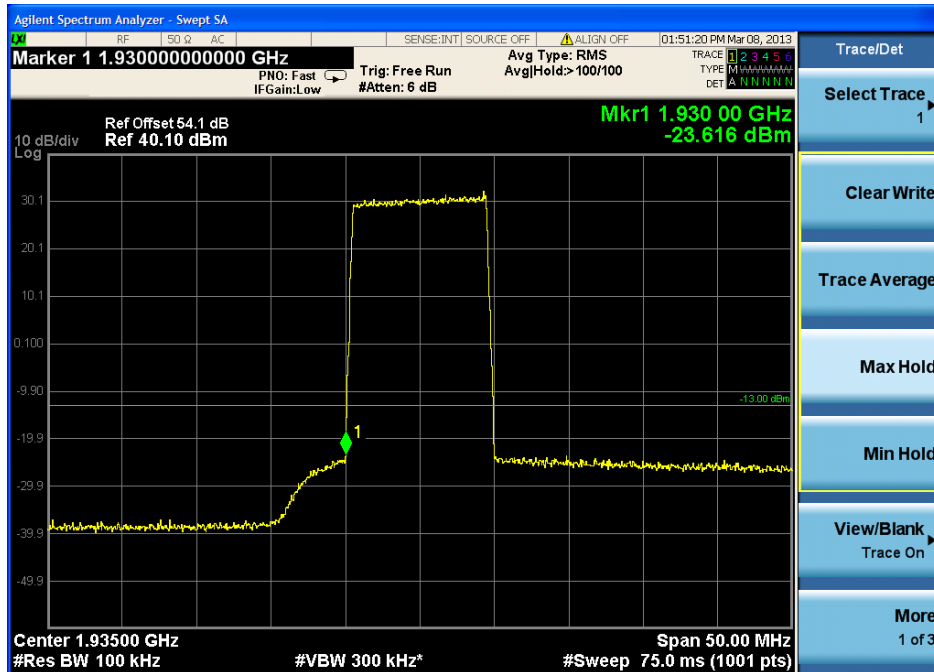

3.4.2 one signal input — Upper Edge

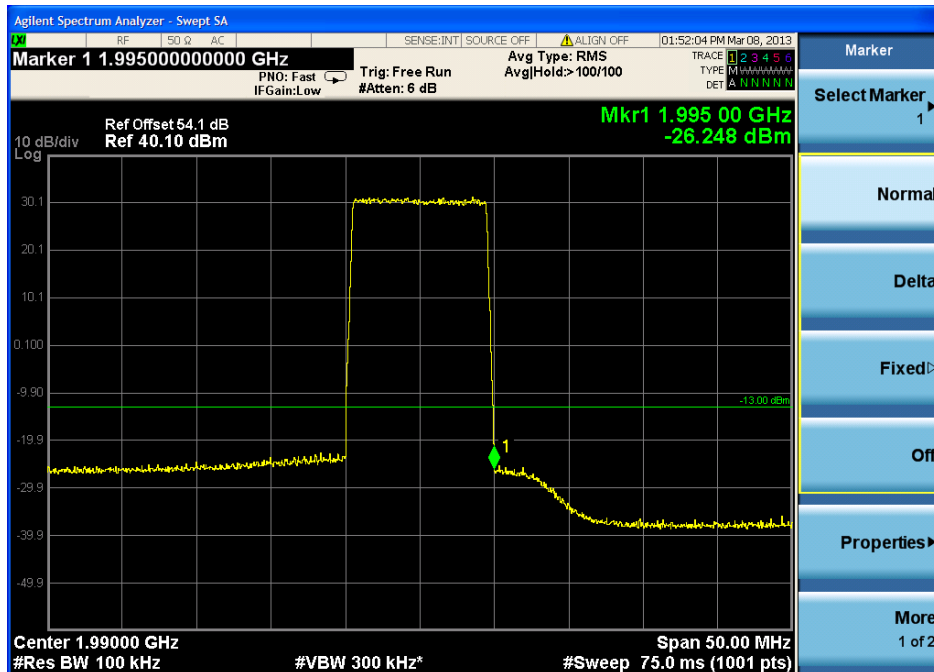



3.4.3 two signal input —Lower Edge

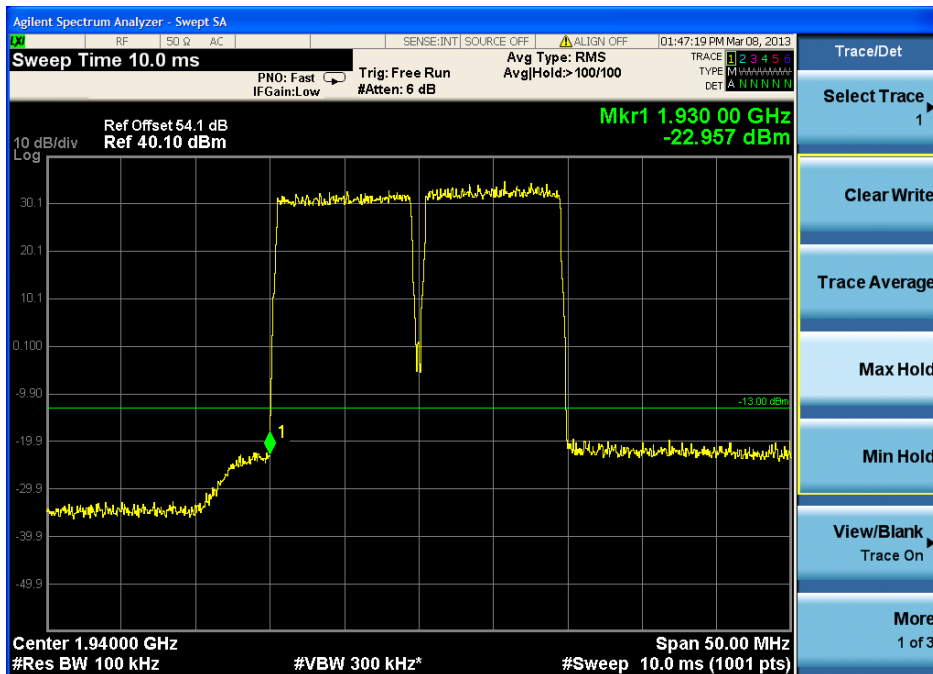

3.4.4 two signal input —Upper Edge





3.5 intermodulation spurious emissions

For GSM mode:

3.5.1 Input frequency:

1)in lower edge test:f1 is the lower edge frequency +1 channel frequency, and f2 is +2 channel frequency

f1=1930.6MHz,f2=1931.2MHz

2)in higher edge test:f1 is the higher edge frequency -2 channel frequency, and f2 is -1 channel frequency

f1=1994MHz,f2=1994.6MHz

base the 3rd product frequency F1= 2f1-f2 and F2=2f2-f1, when the f1 and f2 frequency select above,

- k) in lower edge test, F1=2f1-(f1+Δf)=f1-Δf=lower edge frequency;
l) in higher edge test, F2=2f2-(f2-Δf)=f2+Δf=higher edge frequency.

F1=1930MHz,F2=1995MHz

base the 5th product frequency F1= 3f1-2f2 and F2=3f2-2f1, when the f1 and f2 frequency select above,

- k) in lower edge test, F1=3f1-2(f1+Δf)=f1-2Δf=lower edge frequency;
l) in higher edge test, F2=3f2-2(f2-Δf)=f2+2Δf=higher edge frequency.

F1=1929.4MHz,F2=1995.6MHz

base the 7th product frequency F1= 4f1-3f2 and F2=4f2-3f1, when the f1 and f2 frequency select above,

- k) in lower edge test, F1=4f1-3(f1+Δf)=f1-3Δf=lower edge frequency;
l) in higher edge test, F2=4f2-3(f2-Δf)=f2+3Δf=higher edge frequency.

F1=1928.8MHz,F2=1996.2MHz

3.5.2 Input power:-20dBm

Table with 4 columns: measure frequency, product Value (dBm), Limit (dBm), and Margin (dB). It contains data for 3rd, 5th, and 7th order products at lower and higher edge tests.



SGS-CSTC Standards Technical Services Co., Ltd.

Report No.: GZEM130300086303

Page: 73 of 140

FCC ID: OJFGXCPLA-40



For CDMA mode:

3.5.3 Input frequency:

1)in lower edge test:f1 is the lower edge frequency +1 channel frequency, and f2 is +2 channel frequency

$f1=1930\text{MHz}, f2=1932\text{MHz}$

2)in higher edge test:f1 is the higher edge frequency -2 channel frequency, and f2 is -1 channel frequency

$f1=1991\text{MHz}, f2=1993\text{MHz}$

base the 3rd product frequency $F1= 2f1-f2$ and $F2=2f2-f1$, when the f1 and f2 frequency select above,

- m) in lower edge test, $F1=2f1-(f1+\Delta f)=f1-\Delta f$ =lower edge frequency;
- n) in higher edge test, $F2=2f2-(f2-\Delta f)=f2+\Delta f$ =higher edge frequency.

$F1=1930\text{MHz}, F2=1995\text{MHz}$

base the 5rd product frequency $F1= 3f1-2f2$ and $F2=3f2-2f1$, when the f1 and f2 frequency select above,

- m) in lower edge test, $F1=3f1-2(f1+\Delta f)=f1-2\Delta f$ =lower edge frequency;
- n) in higher edge test, $F2=3f2-2(f2-\Delta f)=f2+2\Delta f$ =higher edge frequency.

$F1=1928\text{MHz}, F2=1997\text{MHz}$

base the 7rd product frequency $F1= 4f1-3f2$ and $F2=4f2-3f1$, when the f1 and f2 frequency select above,

- m) in lower edge test, $F1=4f1-3(f1+\Delta f)=f1-3\Delta f$ =lower edge frequency;
- n) in higher edge test, $F2=4f2-3(f2-\Delta f)=f2+3\Delta f$ =higher edge frequency.

$F1=1926\text{MHz}, F2=1999\text{MHz}$

3.5.4 Input power:-20dBm

measure frequency		product Value (dBm)	Limit (dBm)	Magin (dB)
3 rd	Lower:1930MHz	-15.61	-13dBm	2.61
	Higher:1995MHz	-18.78		5.78
5 rd	Lower:1928MHz	-27.59	-13dBm	14.59
	Higher:1997MHz	-26.84		13.84
7 rd	Lower:1926MHz	-29.04	-13dBm	16.04
	Higher:1999MHz	-29.13		16.13



SGS-CSTC Standards Technical Services Co., Ltd.

Report No.: GZEM130300086303

Page: 75 of 140

FCC ID: OJFGXCPLA-40



For WCDMA mode:

3.5.5 Input frequency:

1)in lower edge test:f1 is the lower edge frequency +1 channel frequency, and f2 is +2 channel frequency

$f1=1933\text{MHz}, f2=1936\text{MHz}$

2)in higher edge test:f1 is the higher edge frequency -2 channel frequency, and f2 is -1 channel frequency

$f1=1989\text{MHz}, f2=1992\text{MHz}$

base the 3rd product frequency $F1= 2f1-f2$ and $F2=2f2-f1$, when the f1 and f2 frequency select above,

- o) in lower edge test, $F1=2f1-(f1+\Delta f)=f1-\Delta f$ =lower edge frequency;
- p) in higher edge test, $F2=2f2-(f2-\Delta f)=f2+\Delta f$ =higher edge frequency.

$F1=1930\text{MHz}, F2=1995\text{MHz}$

base the 5rd product frequency $F1= 3f1-2f2$ and $F2=3f2-2f1$, when the f1 and f2 frequency select above,

- o) in lower edge test, $F1=3f1-2(f1+\Delta f)=f1-2\Delta f$ =lower edge frequency;
- p) in higher edge test, $F2=3f2-2(f2-\Delta f)=f2+2\Delta f$ =higher edge frequency.

$F1=1927\text{MHz}, F2=1998\text{MHz}$

base the 7rd product frequency $F1= 4f1-3f2$ and $F2=4f2-3f1$, when the f1 and f2 frequency select above,

- o) in lower edge test, $F1=4f1-3(f1+\Delta f)=f1-3\Delta f$ =lower edge frequency;
- p) in higher edge test, $F2=4f2-3(f2-\Delta f)=f2+3\Delta f$ =higher edge frequency.

$F1=1924\text{MHz}, F2=2001\text{MHz}$

3.5.6 Input power:-20dBm

measure frequency		product Value (dBm)	Limit (dBm)	Magin (dB)
3 rd	Lower:1930MHz	-18.91	-13dBm	5.91
	Higher:1995MHz	-21.62		8.62
5 rd	Lower:1927MHz	-26.84	-13dBm	13.84
	Higher:1998MHz	-26.95		13.95
7 rd	Lower:1924MHz	-28.56	-13dBm	15.56
	Higher:2001MHz	-29.41		16.41



SGS-CSTC Standards Technical Services Co., Ltd.

Report No.: GZEM130300086303

Page: 77 of 140

FCC ID: OJFGXCPLA-40



For LTE mode:

3.5.7 Input frequency:

1)in lower edge test:f1 is the lower edge frequency +1 channel frequency, and f2 is +2 channel frequency

f1=1935MHz,f2=1945MHz

2)in higher edge test:f1 is the higher edge frequency -2 channel frequency, and f2 is -1 channel frequency

f1=1980MHz,f2=1990MHz

base the 3rd product frequency F1= 2f1-f2 and F2=2f2-f1, when the f1 and f2 frequency select above,

q) in lower edge test, F1=2f1-(f1+Δf)=f1-Δf=lower edge frequency;

r) in higher edge test, F2=2f2-(f2-Δf)=f2+Δf=higher edge frequency.

F1=1930MHz,F2=1995MHz

base the 5th product frequency F1= 3f1-2f2 and F2=3f2-2f1, when the f1 and f2 frequency select above,

q) in lower edge test, F1=3f1-2(f1+Δf)=f1-2Δf=lower edge frequency;

r) in higher edge test, F2=3f2-2(f2-Δf)=f2+2Δf=higher edge frequency.

F1=1920MHz,F2=2005MHz

base the 7th product frequency F1= 4f1-3f2 and F2=4f2-3f1, when the f1 and f2 frequency select above,

q) in lower edge test, F1=4f1-3(f1+Δf)=f1-3Δf=lower edge frequency;

r) in higher edge test, F2=4f2-3(f2-Δf)=f2+3Δf=higher edge frequency.

F1=1910MHz,F2=2015MHz

3.5.8 Input power:-20dBm

measure frequency		product Value (dBm)	Limit (dBm)	Magin (dB)
3 rd	Lower:1930MHz	-22.96	-13dBm	9.96
	Higher:1995MHz	-23.12		10.12
5 rd	Lower:1920MHz	-34.58	-13dBm	21.58
	Higher:2005MHz	-29.94		16.94
7 rd	Lower:1920MHz	-35.36	-13dBm	22.36
	Higher:2015MHz	-34.85		21.85

Remark:



SGS-CSTC Standards Technical Services Co., Ltd.

Report No.: GZEM130300086303

Page: 79 of 140

FCC ID: OJFGXCPLA-40

No other intermodulation spurious emissions of above 7rd have been found,so only record the test data about the 3rd, 5rd and 7rd



4. Downlink: 2110MHz to 2155MHz(CDMA,WCDMA,LTE)

4.1 CDMA Mode:

4.1.1 one signal input —Lower Edge

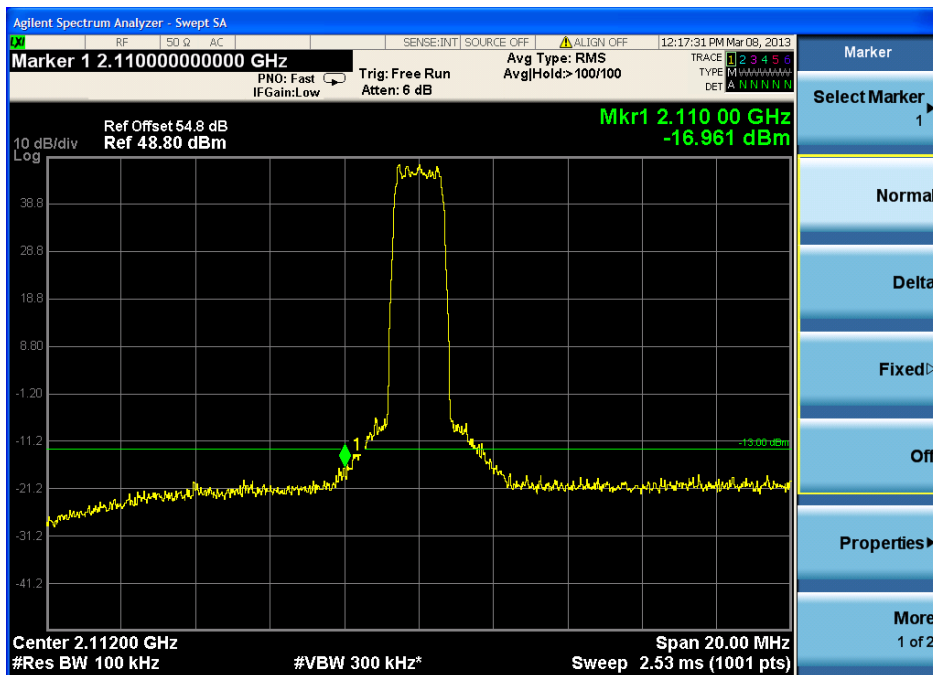

4.1.2 one signal input — Upper Edge

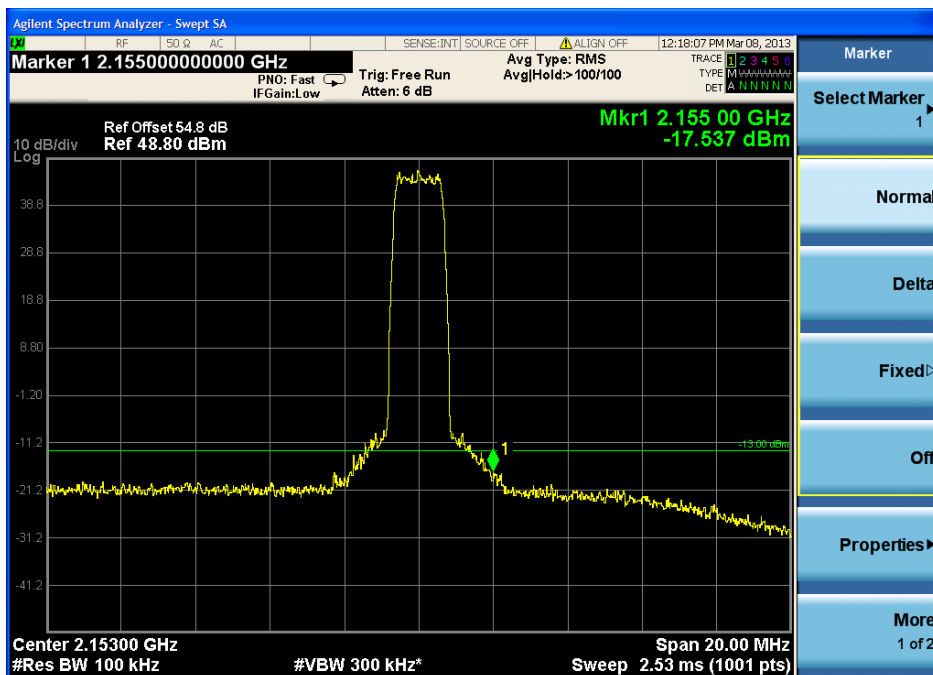



4.1.3 two signal input —Lower Edge

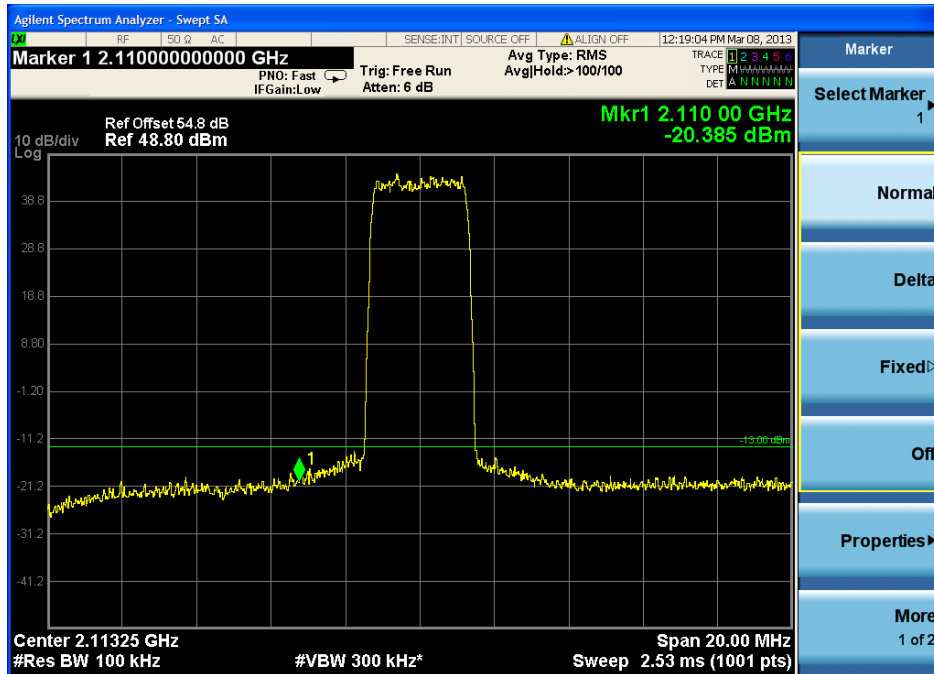

4.1.4 two signal input —Upper Edge

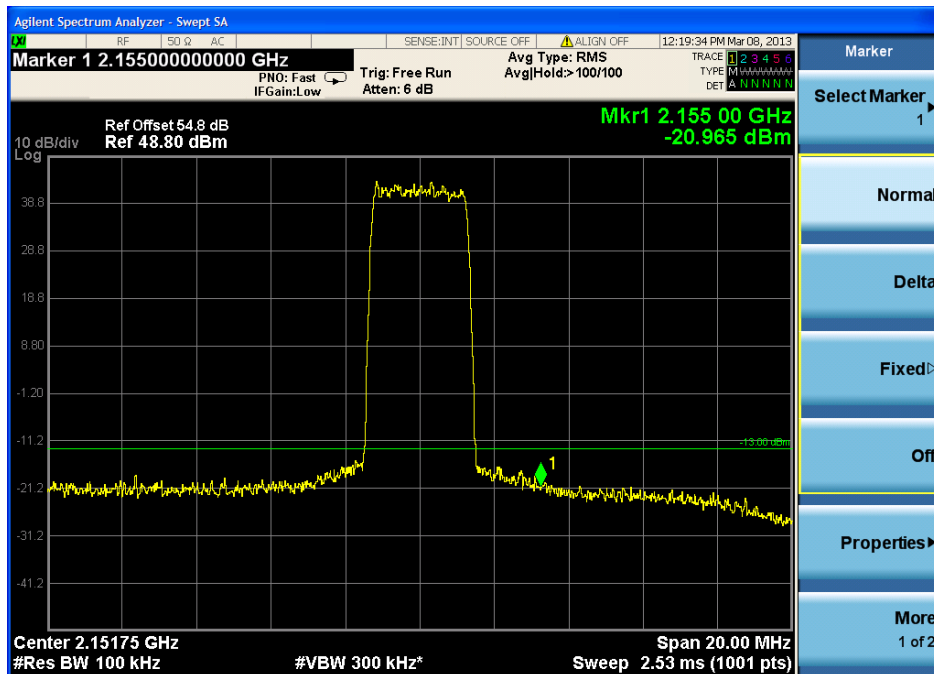



4.2 WDMA Mode:

4.2.1 one signal input —Lower Edge

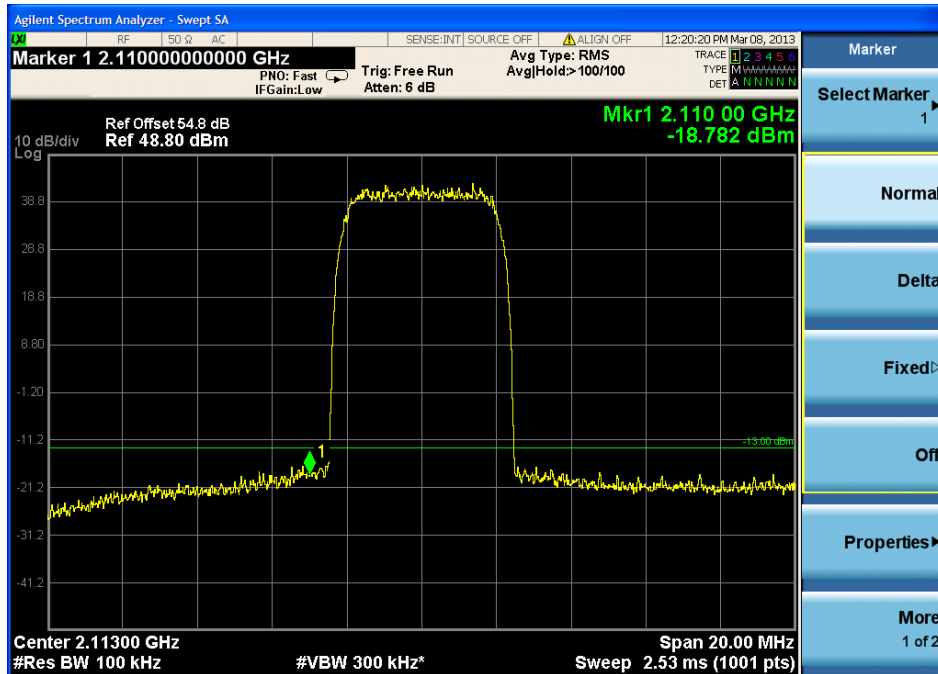

4.2.2 one signal input — Upper Edge

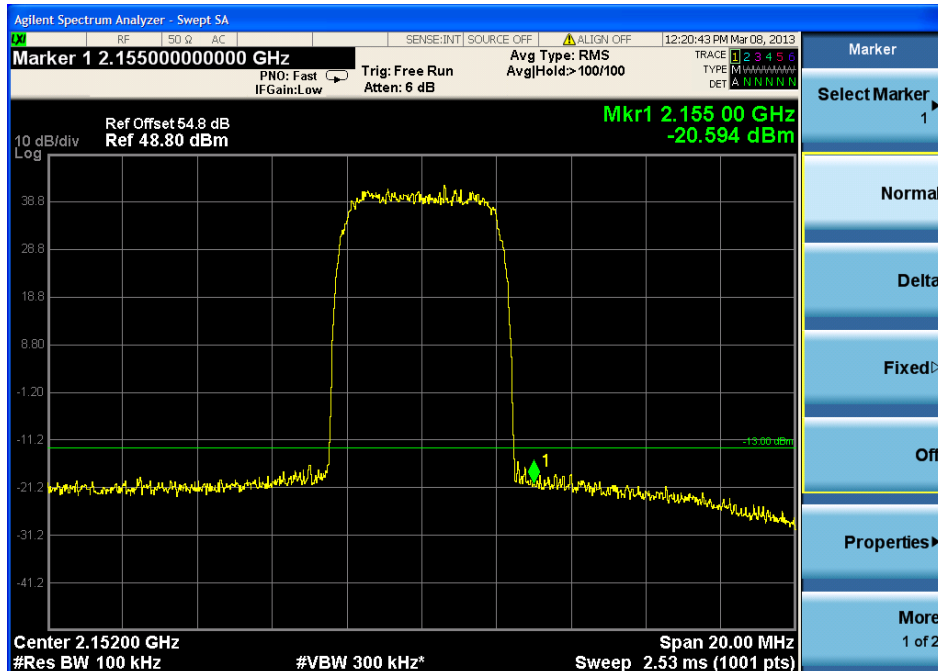



4.2.3 two signal input —Lower Edge

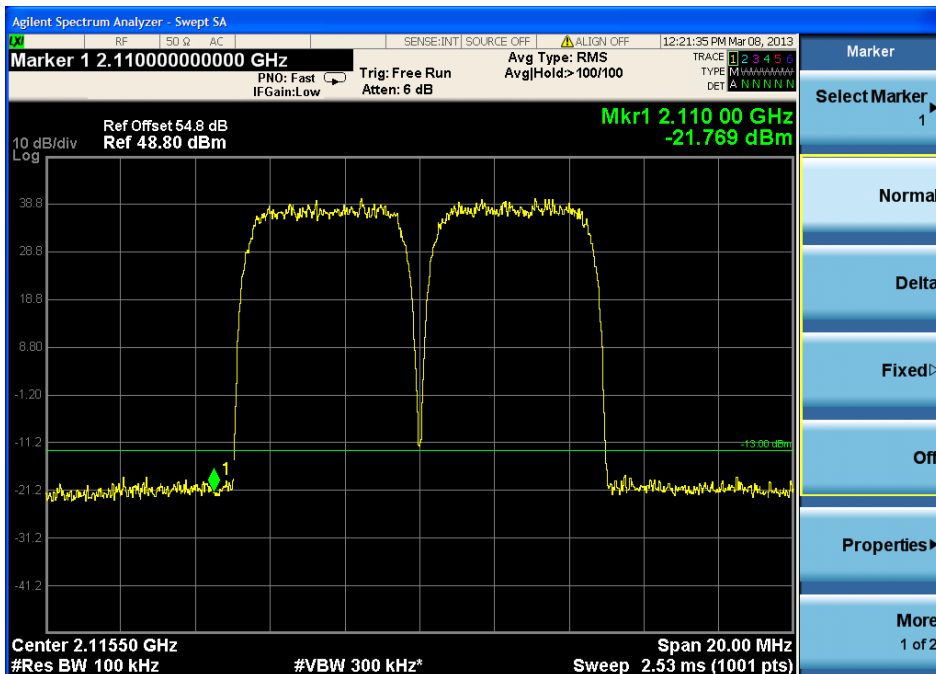

4.2.4 two signal input —Upper Edge

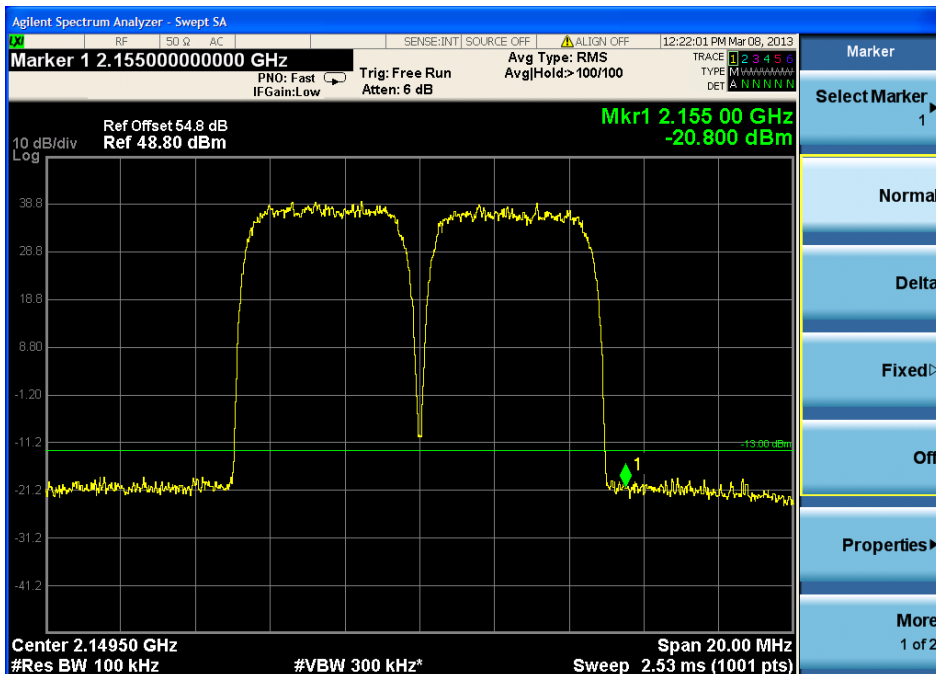



4.3 LTE Mode:

4.3.1 one signal input —Lower Edge

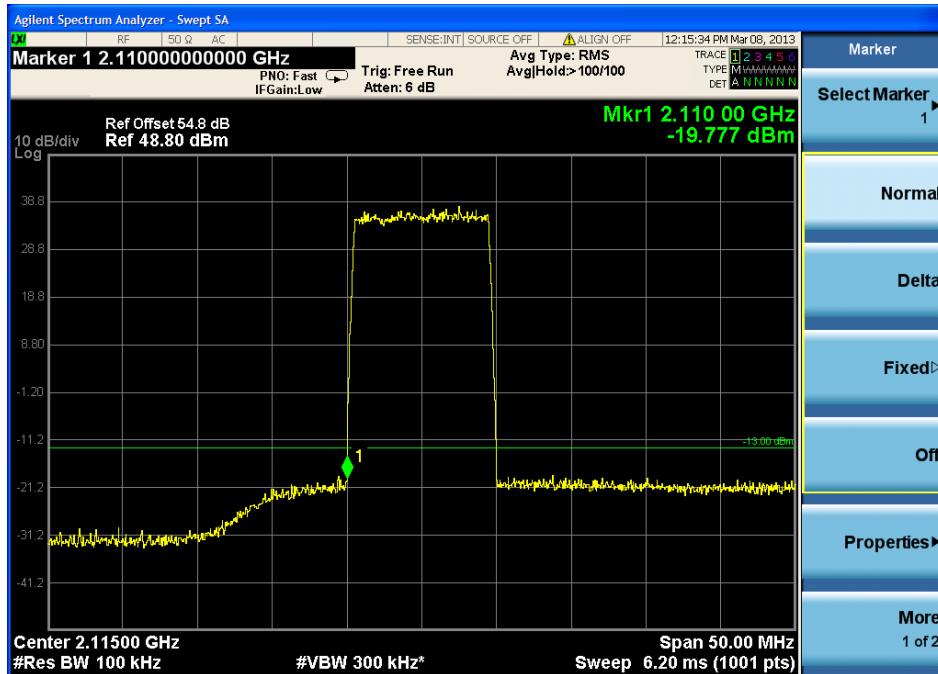

4.3.2 one signal input — Upper Edge

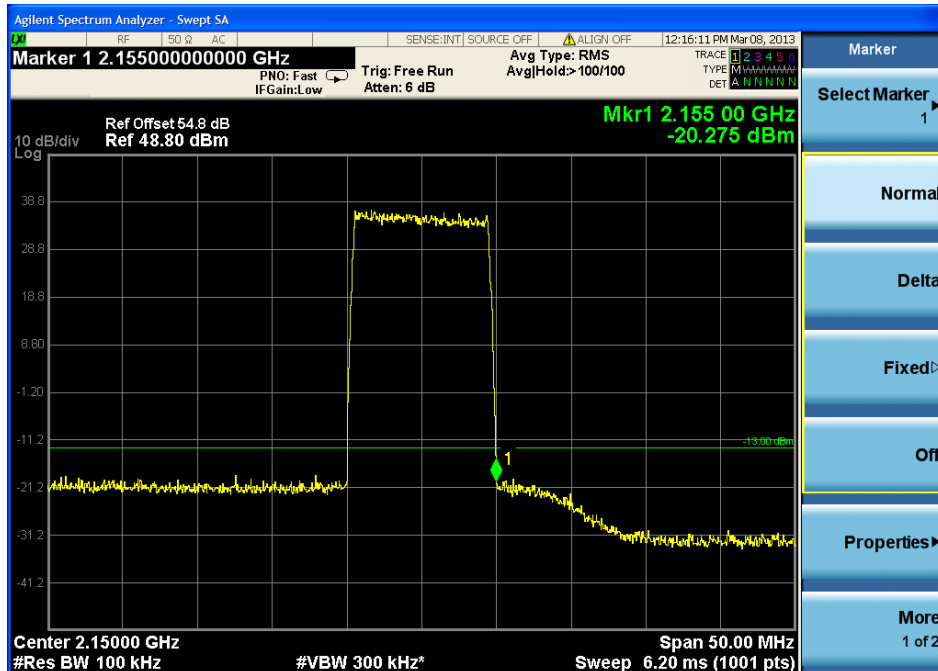



4.3.3 two signal input —Lower Edge

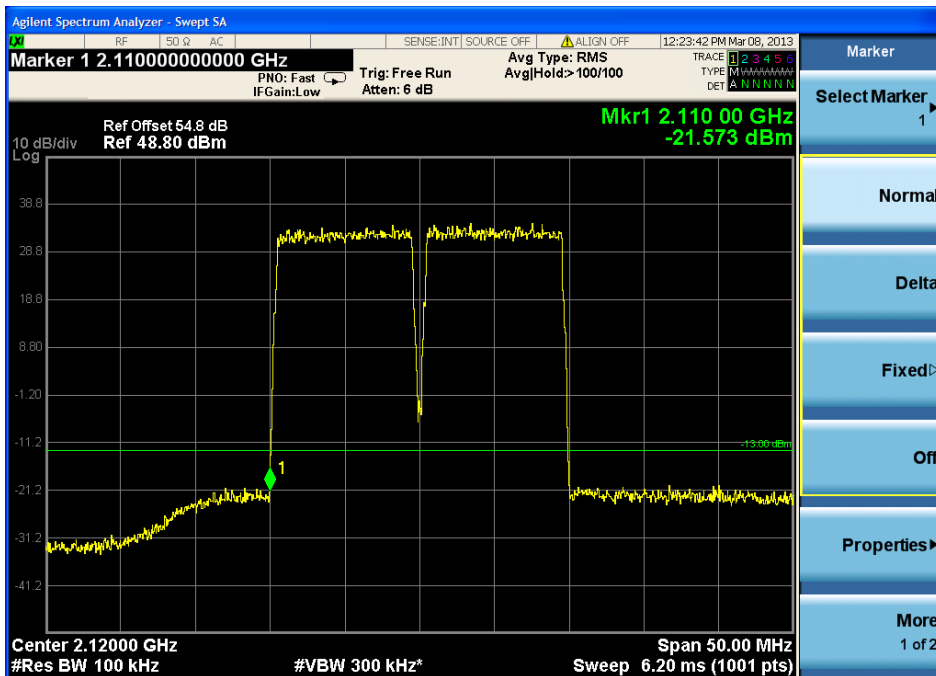

4.3.4 two signal input —Upper Edge

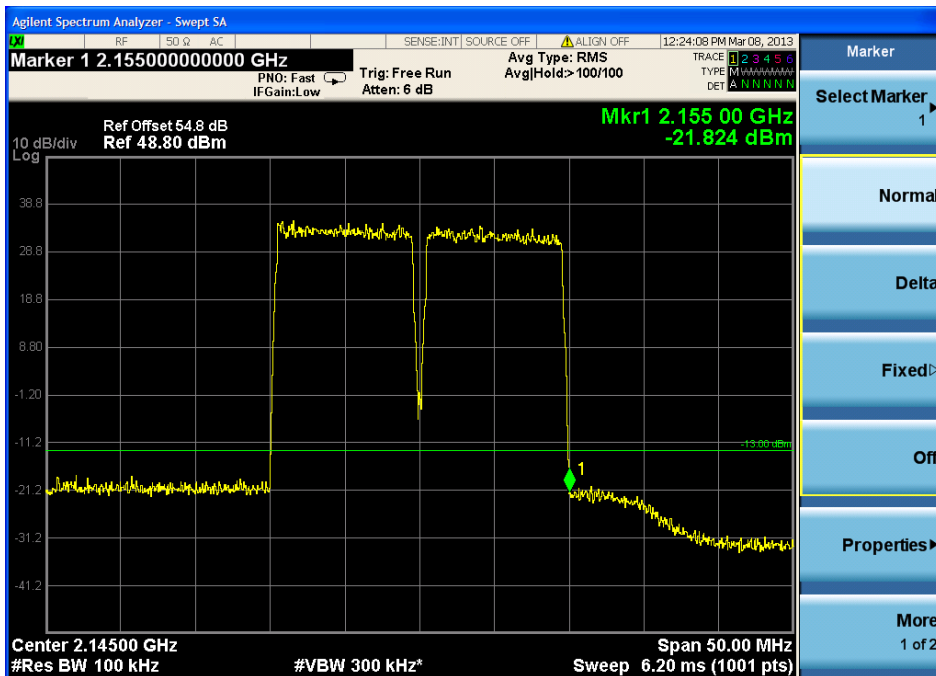



4.4 intermodulation spurious emissioins

For CDMA mode:

4.5.1 Input frequency:

1)in lower edge test:f1 is the lower edge frequency +1 channel frequency, and f2 is +2 channel frequency

$$f1=2112\text{MHz},f2=2114\text{MHz}$$

2)in higher edge test:f1 is the higher edge frequency -2 channel frequency, and f2 is -1 channel frequency

$$f1=2151\text{MHz},f2=2153\text{MHz}$$

base the 3rd product frequency $F1= 2f1-f2$ and $F2=2f2-f1$, when the f1 and f2 frequency select above,

- s) in lower edge test, $F1=2f1-(f1+\Delta f)=f1-\Delta f$ =lower edge frequency;
- t) in higher edge test, $F2=2f2-(f2-\Delta f)=f2+\Delta f$ =higher edge frequency.

$$F1=2110\text{MHz},F2=2155\text{MHz}$$

base the 5rd product frequency $F1= 3f1-2f2$ and $F2=3f2-2f1$, when the f1 and f2 frequency select above,

- s) in lower edge test, $F1=3f1-2(f1+\Delta f)=f1-2\Delta f$ =lower edge frequency;
- t) in higher edge test, $F2=3f2-2(f2-\Delta f)=f2+2\Delta f$ =higher edge frequency.

$$F1=2108\text{MHz},F2=2157\text{MHz}$$

base the 7rd product frequency $F1= 4f1-3f2$ and $F2=4f2-3f1$, when the f1 and f2 frequency select above,

- s) in lower edge test, $F1=4f1-3(f1+\Delta f)=f1-3\Delta f$ =lower edge frequency;
- t) in higher edge test, $F2=4f2-3(f2-\Delta f)=f2+3\Delta f$ =higher edge frequency.

$$F1=2106\text{MHz},F2=2159\text{MHz}$$

4.5.2 Input power:-20dBm

measure frequency		product Value (dBm)	Limit (dBm)	Magin (dB)
3 rd	Lower:2110MHz	-20.39	-13dBm	7.39
	Higher:2155MHz	-20.97		7.97
5 rd	Lower:2108MHz	-21.36	-13dBm	8.36
	Higher:2157MHz	-22.48		9.48
7 rd	Lower:2106MHz	-25.48	-13dBm	12.48
	Higher:2159MHz	-24.96		11.96

This document is issued by the Company subject to its General Conditions of Service printed overleaf, available on request or accessible at www.sgs.com/terms_and_conditions.htm and, for electronic format documents, subject to Terms and Conditions for Electronic Documents at www.sgs.com/terms_e-document.htm. Attention is drawn to the limitation of liability, indemnification and jurisdiction issues defined therein. Any holder of this document is advised that information contained herein reflects the Company's findings at the time of its intervention only and within the limits of Client's instructions, if any. The Company's sole responsibility is to its Client and this document does not exonerate parties to a transaction from exercising all their rights and obligations under the transaction documents. This document cannot be reproduced except in full, without prior written approval of the Company. Any unauthorized alteration, forgery or falsification of the content or appearance of this document is unlawful and offenders may be prosecuted to the fullest extent of the law. Unless otherwise stated the results shown in this test report refer only to the sample(s) tested and such sample(s) are retained for 90 days only.



SGS-CSTC Standards Technical Services Co., Ltd.

Report No.: GZEM130300086303

Page: 87 of 140

FCC ID: OJFGXCPLA-40



For WCDMA mode:

4.5.3 Input frequency:

1) in lower edge test: f1 is the lower edge frequency +1 channel frequency, and f2 is +2 channel frequency

f1=2113MHz, f2=2116MHz

2) in higher edge test: f1 is the higher edge frequency -2 channel frequency, and f2 is -1 channel frequency

f1=2149MHz, f2=2152MHz

base the 3rd product frequency F1= 2f1-f2 and F2=2f2-f1, when the f1 and f2 frequency select above,

- u) in lower edge test, F1=2f1-(f1+Δf)=f1-Δf=lower edge frequency;
v) in higher edge test, F2=2f2-(f2-Δf)=f2+Δf=higher edge frequency.

F1=2110MHz, F2=2155MHz

base the 5th product frequency F1= 3f1-2f2 and F2=3f2-2f1, when the f1 and f2 frequency select above,

- u) in lower edge test, F1=3f1-2(f1+Δf)=f1-2Δf=lower edge frequency;
v) in higher edge test, F2=3f2-2(f2-Δf)=f2+2Δf=higher edge frequency.

F1=2107MHz, F2=2158MHz

base the 7th product frequency F1= 4f1-3f2 and F2=4f2-3f1, when the f1 and f2 frequency select above,

- u) in lower edge test, F1=4f1-3(f1+Δf)=f1-3Δf=lower edge frequency;
v) in higher edge test, F2=4f2-3(f2-Δf)=f2+3Δf=higher edge frequency.

F1=2104MHz, F2=2161MHz

4.5.4 Input power:-20dBm

Table with 4 columns: measure frequency, product Value (dBm), Limit (dBm), and Margin (dB). It contains data for 3rd, 5th, and 7th order products, showing lower and higher edge frequencies, their product values, a -13dBm limit, and resulting margins.



For LTE mode:

4.5.5 Input frequency:

1)in lower edge test:f1 is the lower edge frequency +1 channel frequency, and f2 is +2 channel frequency

$f1=2115\text{MHz}, f2=2125\text{MHz}$

2)in higher edge test:f1 is the higher edge frequency -2 channel frequency, and f2 is -1 channel frequency

$f1=2140\text{MHz}, f2=2150\text{MHz}$

base the 3rd product frequency $F1= 2f1-f2$ and $F2=2f2-f1$, when the f1 and f2 frequency select above,

- w) in lower edge test, $F1=2f1-(f1+\Delta f)=f1-\Delta f$ =lower edge frequency;
- x) in higher edge test, $F2=2f2-(f2-\Delta f)=f2+\Delta f$ =higher edge frequency.

$F1=2110\text{MHz}, F2=2155\text{MHz}$

base the 5rd product frequency $F1= 3f1-2f2$ and $F2=3f2-2f1$, when the f1 and f2 frequency select above,

- w) in lower edge test, $F1=3f1-2(f1+\Delta f)=f1-2\Delta f$ =lower edge frequency;
- x) in higher edge test, $F2=3f2-2(f2-\Delta f)=f2+2\Delta f$ =higher edge frequency.

$F1=2100\text{MHz}, F2=2165\text{MHz}$

base the 7rd product frequency $F1= 4f1-3f2$ and $F2=4f2-3f1$, when the f1 and f2 frequency select above,

- w) in lower edge test, $F1=4f1-3(f1+\Delta f)=f1-3\Delta f$ =lower edge frequency;
- x) in higher edge test, $F2=4f2-3(f2-\Delta f)=f2+3\Delta f$ =higher edge frequency.

$F1=2090\text{MHz}, F2=2175\text{MHz}$

4.5.6 Input power:-20dBm

measure frequency		product Value (dBm)	Limit (dBm)	Magin (dB)
3 rd	Lower:2110MHz	-21.57	-13dBm	8.57
	Higher:2155MHz	-21.83		8.83
5 rd	Lower:2100MHz	-27.36	-13dBm	14.36
	Higher:2165MHz	-25.34		12.34
7 rd	Lower:2090MHz	-33.47	-13dBm	20.47
	Higher:2175MHz	-31.98		18.98



Remark:

No other intermodulation spurious emissions of above 7rd have been found,so only record the test data about the 3rd, 5rdand 7rd



Remark:

For the test in two signal input or intermodulation, test input signal f1 and f2 will consider as follows conditions:

- 2) EUT frequency band span and the amount of channels;
- 3) f1 is the frequency lower, f2 is the frequency higher, Δf is the channel spacing;
- 4) in lower edge test, f1 is the lower edge frequency +1 channel frequency, and f2 is +2 channel frequency;
- 5) in higher edge test, f1 is the higher edge frequency -2 channel frequency, and f2 is -1 channel frequency;
- 6) according to the amplifier characteristic, the 3rd product will appear when two signals input;
- 7) base the 3rd product frequency $F1=2f1-f2$ and $F2=2f2-f1$, when the f1 and f2 frequency select above,
 - a) in lower edge test, $F1=2f1-(f1+\Delta f)=f1-\Delta f$ =lower edge frequency;
 - b) in higher edge test, $F2=2f2-(f2-\Delta f)=f2+\Delta f$ =higher edge frequency.
- 8) base the 5rd product frequency $F1=3f1-2f2$ and $F2=3f2-2f1$, when the f1 and f2 frequency select above,
 - a) in lower edge test, $F1=3f1-2(f1+\Delta f)=f1-2\Delta f$ =lower edge frequency;
 - b) in higher edge test, $F2=3f2-2(f2-\Delta f)=f2+2\Delta f$ =higher edge frequency.
- 9) base the 7rd product frequency $F1=4f1-3f2$ and $F2=4f2-3f1$, when the f1 and f2 frequency select above,
 - a) in lower edge test, $F1=4f1-3(f1+\Delta f)=f1-3\Delta f$ =lower edge frequency;
 - b) in higher edge test, $F2=4f2-3(f2-\Delta f)=f2+3\Delta f$ =higher edge frequency.

7.2.4 Radiated Spurious Emissions

Test Date: 2013-03-19 and 2013-08-13

Test Requirement: FCC part 22.917(a) & FCC part 24.238(a) & FCC part 27.53(h)
 22.917(a) Out of band emissions. The power of any emission outside of the authorized operating frequency ranges must be attenuated below the transmitting power (P) by a factor of at least $43 + 10 \log(P)$ dB.

24.238(a) Out of band emissions. The power of any emission outside of the authorized operating frequency ranges must be attenuated below the transmitting power (P) by a factor of at least $43 + 10 \log(P)$ dB.

27.53(h) For operations in the 1710–1755 MHz and 2110–2155 MHz bands, the power of any emission outside a licensee's frequency block shall be attenuated below the transmitter power (P) by at least $43 + 10 \log(P)$ dB.

Test Method: FCC part 2.1053
 ANSI/TIA-603-C-2004

EUT Operation:
 Status: Drive the EUT to maximum output power.
 Conditions: Normal conditions
 Application: Enclosure

Test Configuration:
 9 kHz to 30 MHz emissions:

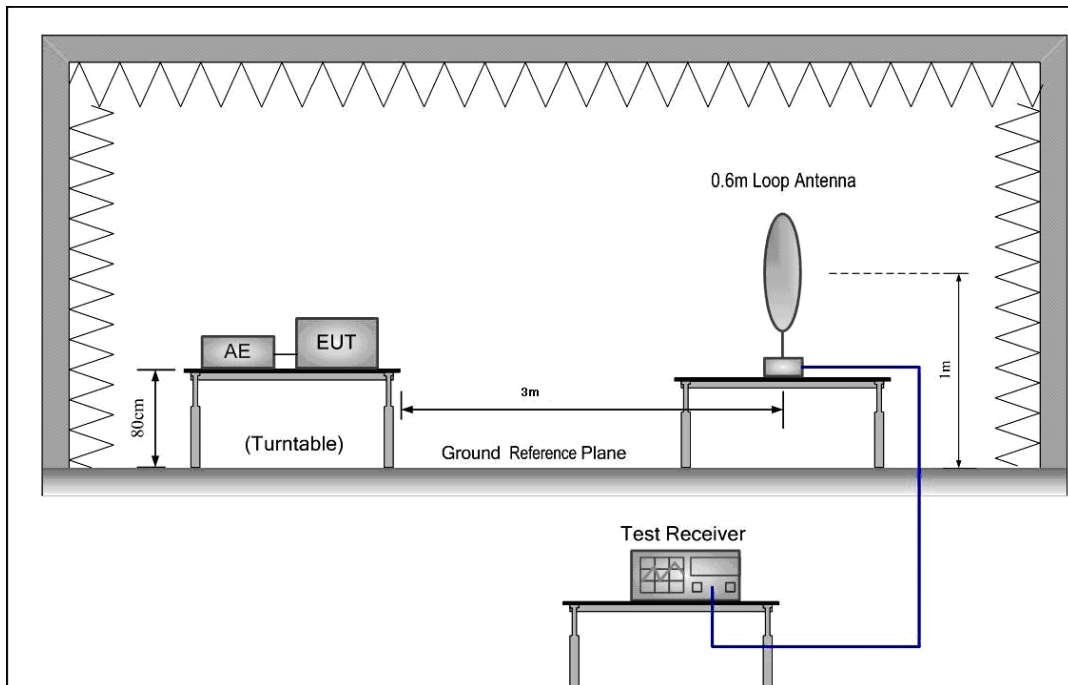

30MHz to 1GHz emissions:

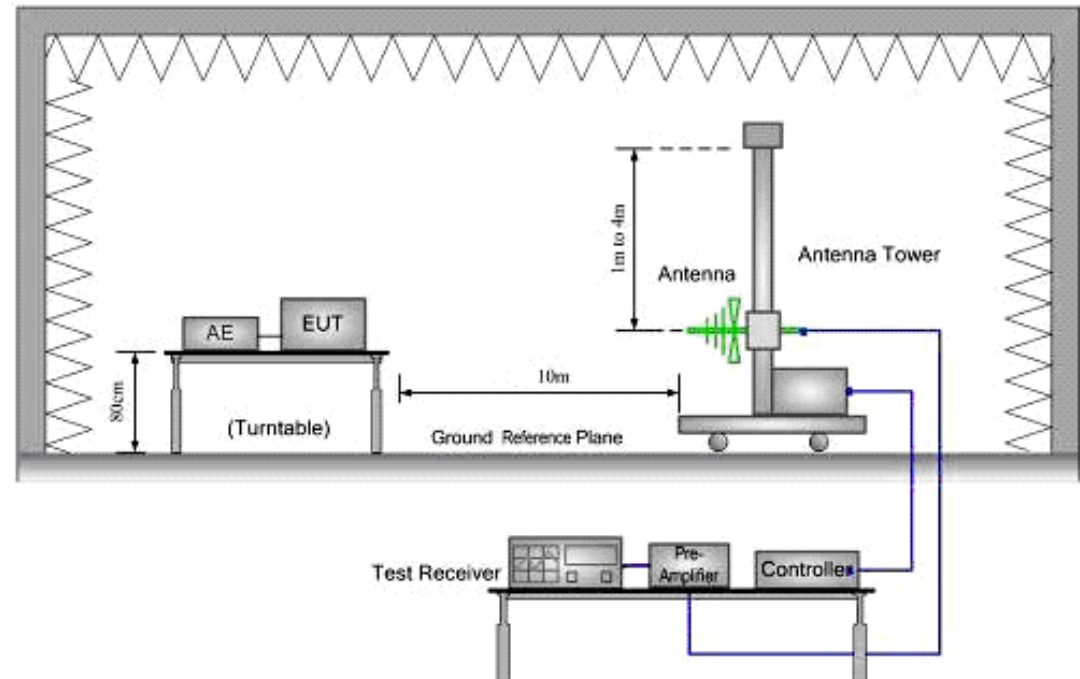

1GHz to 40GHz emissions:

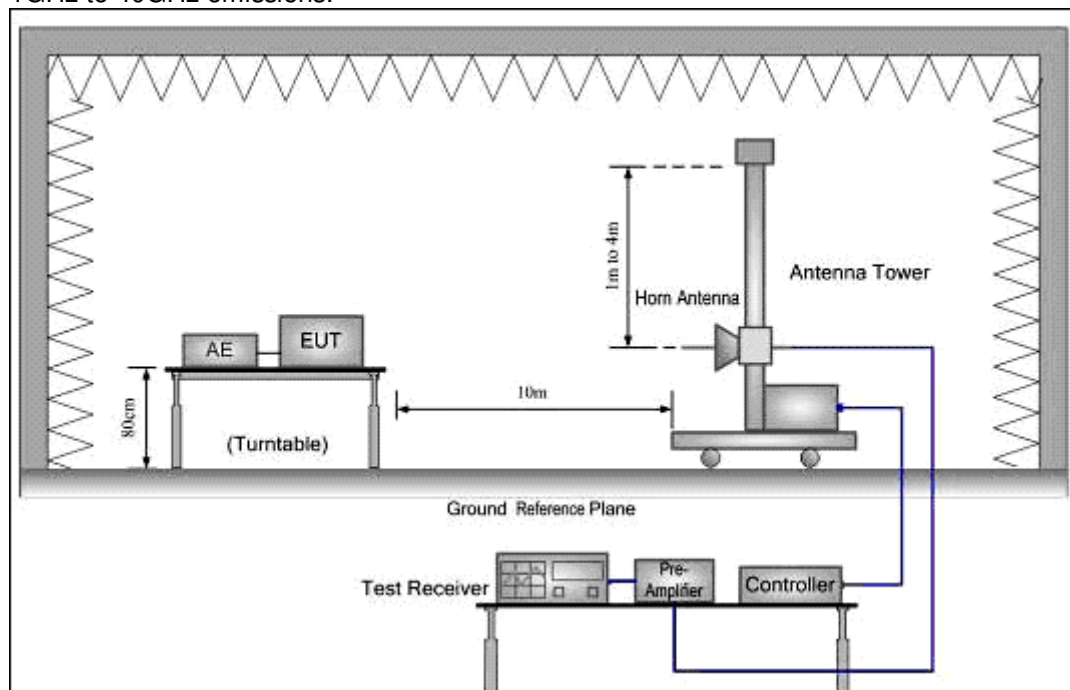

- Test Procedure:
1. Test the background noise level with all the test facilities;
 2. Keep one transmitting path, all other connectors shall be connected by normal power or RF leads;
 3. Select the suitable RF notch filter to avoid the test receiver or spectrum analyzer produce unwanted spurious emissions;
 4. Keep the EUT continuously transmitting in max power;
 5. Read the radiated emissions of the EUT enclosure.

Radiated Emissions Test Procedure:

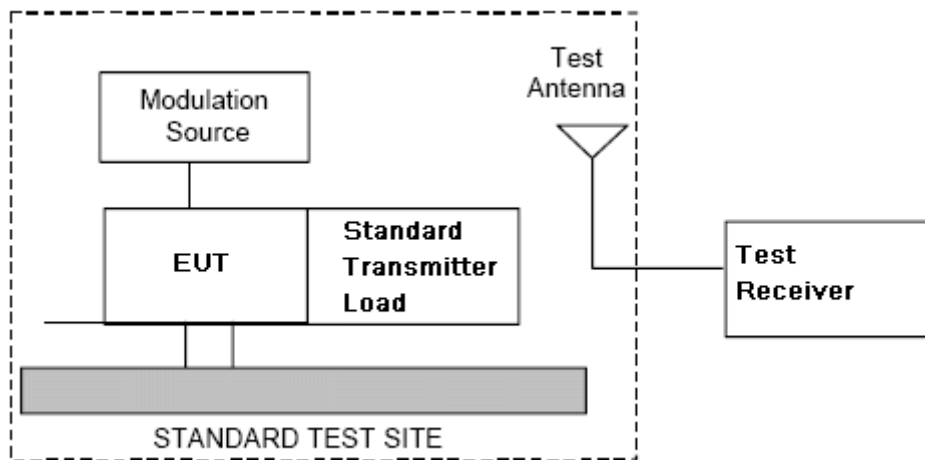

- a) Connect the equipment as illustrated.
- b) Adjust the spectrum analyzer for the following settings:
 - 1) Resolution Bandwidth = 100 kHz for spurious emissions below 1 GHz, and 1 MHz for spurious emissions above 1GHz.
 - 2) Video Bandwidth = 300 kHz for spurious emissions below 1 GHz, and 3 MHz for spurious emissions above 1 GHz.
 - 3) Sweep Speed slow enough to maintain measurement calibration.
 - 4) Detector Mode = Positive Peak.
- c) Place the transmitter to be tested on the turntable in the standard test site, The transmitter is transmitting into a nonradiating load that is placed on the turntable. The RF cable to this load should be of minimum length.
- d) Measurements shall be made from 30MHz to 10 times of fundamental carrier, except for the region close to the carrier equal to \pm the carrier bandwidth.
- e) Key the transmitter without modulation or normal modulation base the standard.
- f) For each spurious frequency, raise and lower the test antenna from 1 m to 4 m to obtain a maximum reading on the spectrum analyzer with the test antenna at horizontal polarity. Then the turntable should be rotated 360° to determine the maximum reading. Repeat this procedure to obtain the highest possible reading. Record this maximum reading.
- g) Repeat step f) for each spurious frequency with the test antenna polarized vertically.

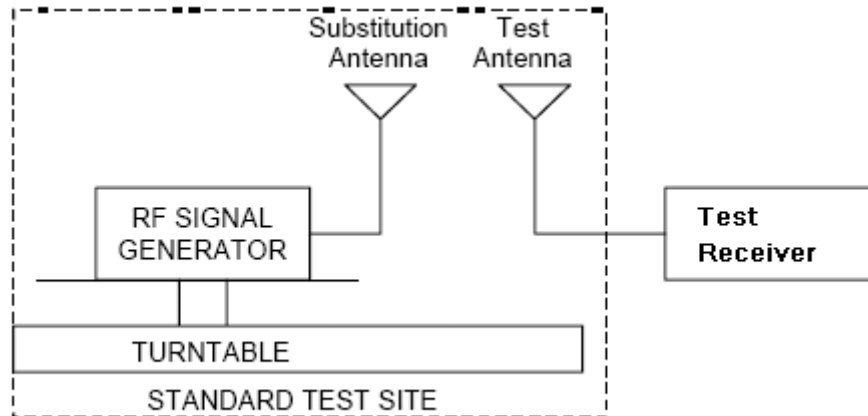

- h) Reconnect the equipment as illustrated.
- i) Keep the spectrum analyzer adjusted as in step b).
- j) Remove the transmitter and replace it with a substitution antenna (the antenna should be half-wavelength for each frequency involved). The center of the substitution antenna should be approximately at the same location as the center of the transmitter. At the lower frequencies, where the substitution antenna is very long, this will be impossible to achieve when the antenna is polarized vertically. In such case the lower end of the antenna should be 0.3 m above the ground.
- k) Feed the substitution antenna at the transmitter end with a signal generator connected to the antenna by means of a nonradiating cable. With the antennas at both ends horizontally polarized, and with the signal generator tuned to a particular spurious frequency, raise and lower the test antenna to obtain a maximum reading at the spectrum analyzer. Adjust the level of the signal generator output until the previously recorded maximum reading for this set of conditions is obtained. This should be done carefully repeating the adjustment of the test antenna and generator output.
- l) Repeat step k) with both antennas vertically polarized for each spurious frequency.
- m) Calculate power in dBm into a reference ideal half-wave dipole antenna by reducing the readings obtained in steps k) and l) by the power loss in the cable between the generator and the antenna, and further corrected for the gain of the substitution antenna used relative to an ideal half-wave dipole

antenna by the following formula:

$$Pd(\text{dBm}) = Pg(\text{dBm}) - \text{cable loss (dB)} + \text{antenna gain (dB)}$$

where:

Pd is the dipole equivalent power and

Pg is the generator output power into the substitution antenna.

NOTE: It is permissible to use other antennas provided they can be referenced to a dipole.

NOTE: Effective radiated power (e.r.p) refers to the radiation of a half wave tuned dipole instead of an isotropic antenna. There is a constant difference of 2.15 dB between e.i.r.p. and e.r.p.

$$\text{e.r.p (dBm)} = \text{e.i.r.p. (dBm)} - 2.15$$



7.2.4.1 Measurement Record:

No emissions were detected within 20dB below the limit for the Downlink direction.

Remark:

The cabinet radiation was measured with the equipment transmitting a CW signal into a non-radiating 50 Ohm load at maximum output power on a signal frequency .

Measured were performed in the lowest, middle and highest frequency for : the Downlink.

The spectrum was searched from 9KHz to 26GHz (10th Harmonic) for downlink;

7.2.5 Occupied Bandwidth

Test Date: 2013-03-13 to 2013-03-19

Test Requirement: 2-11-04/EAB/RF

Test Method: FCC part 2.1049, 2-11-04/EAB/RF

The spectral shape of the output should look similar to input for all modulations.

EUT Operation:

Status: Drive the EUT to maximum output power. .

Conditions: Normal conditions

Application: Cellular Band RF output ports

Test Configuration:

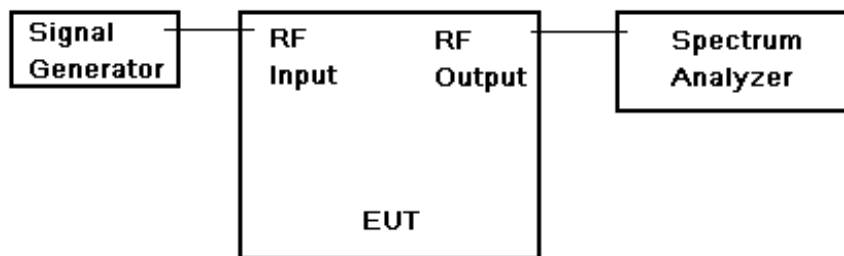

Fig.2. Conducted Spurious Emissions test configuration

- Test Procedure:
- a) Set the spectrum analyzer RBW 300 Hz or $>1\%$ & $<2\%$ emission bandwidth of carrier.
 - b) Capture the trace of input signal;
 - c) Connect the equipment as illustrated;
 - d) Capture the trace of output signal;



7.2.5.1 Measurement Record:

1. Downlink: 728MHz to 757MHz(LTE mode)

1.1 lowest frequency -- Input

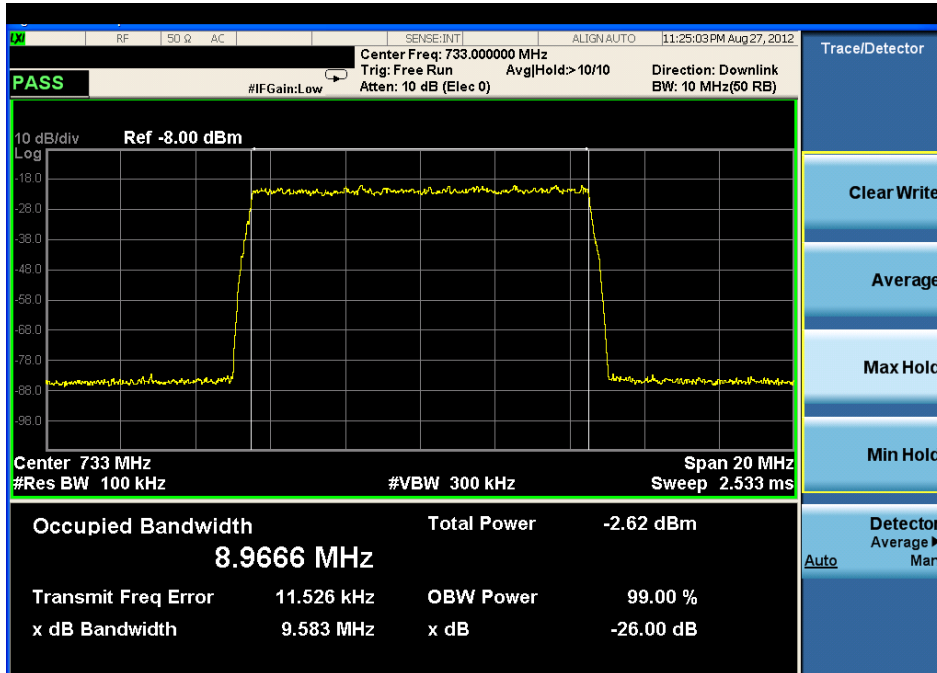

1.2 lowest frequency-- Output

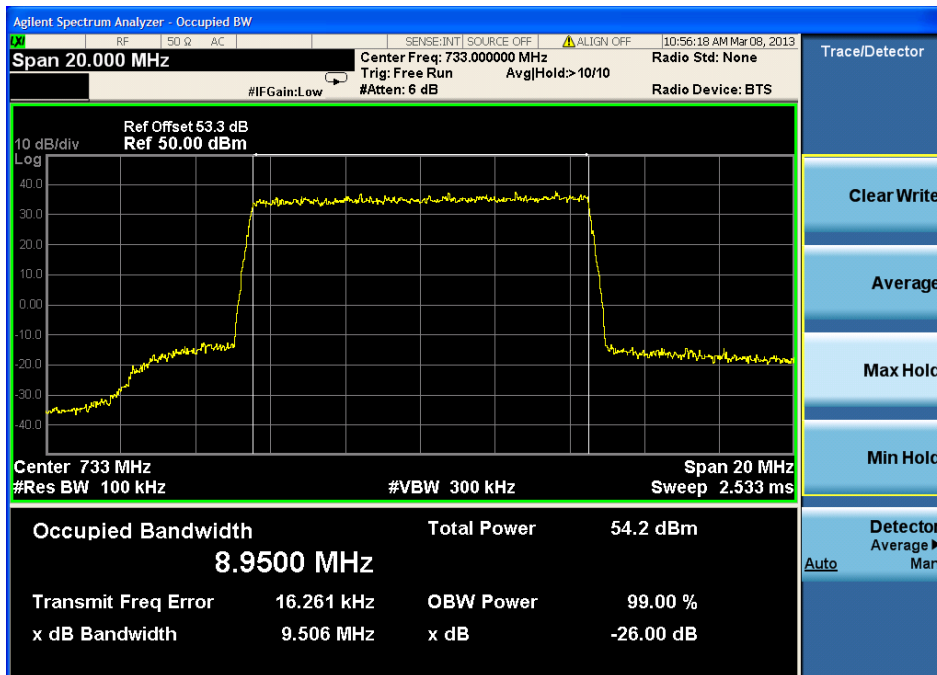



1.3 middle frequency-- Input

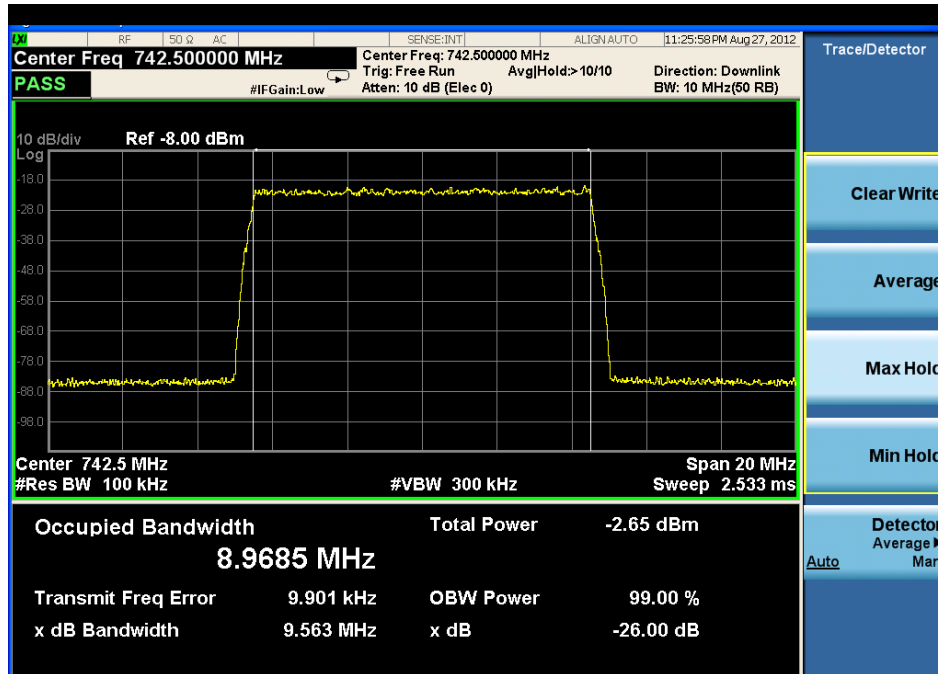

1.4 middle frequency-- Output

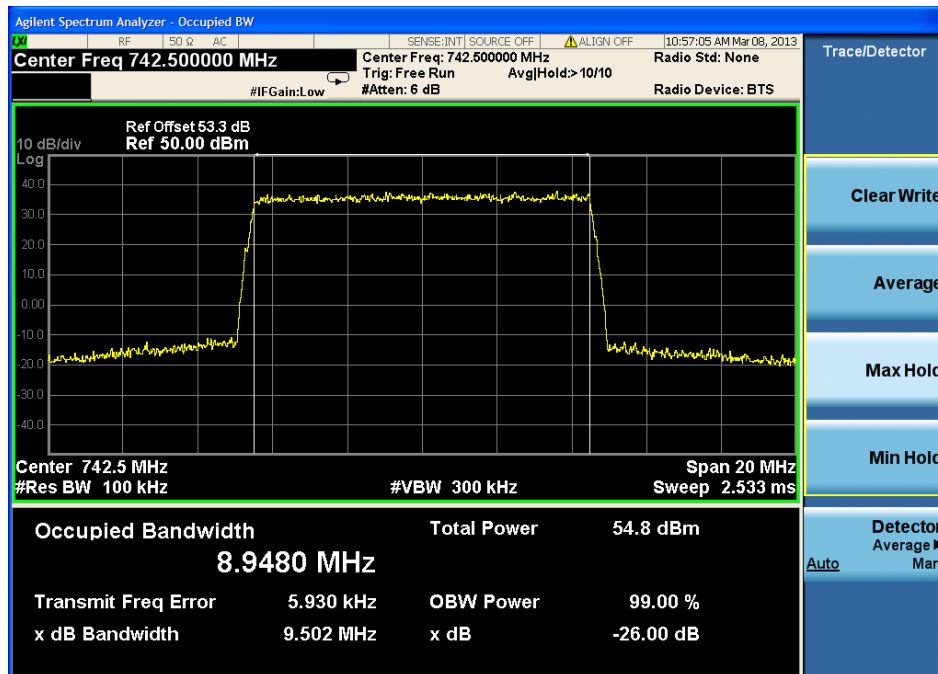



1.5 highest frequency—Input

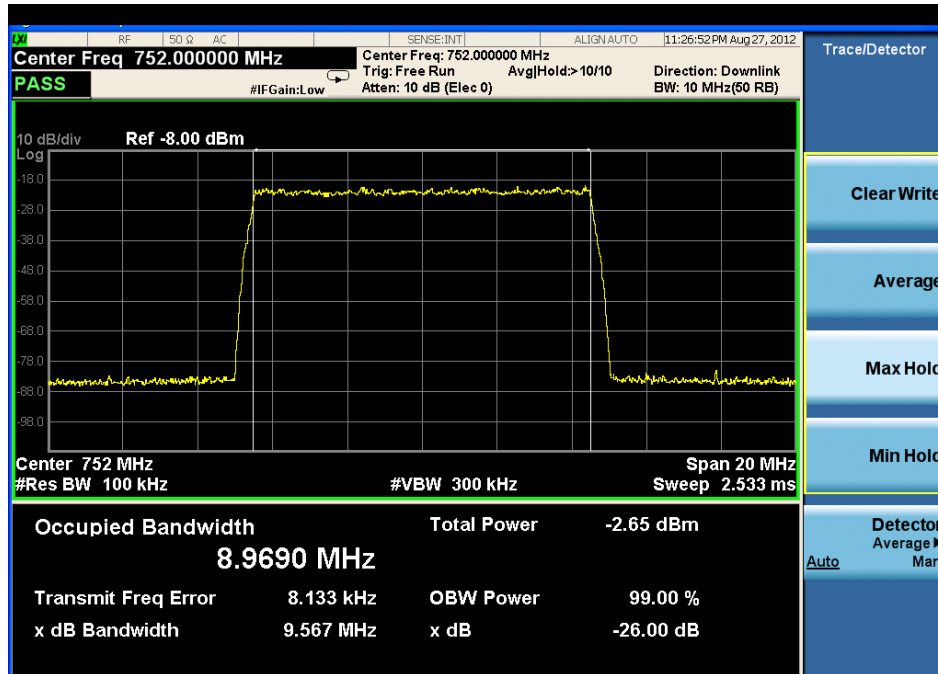

1.6 highest frequency--Output

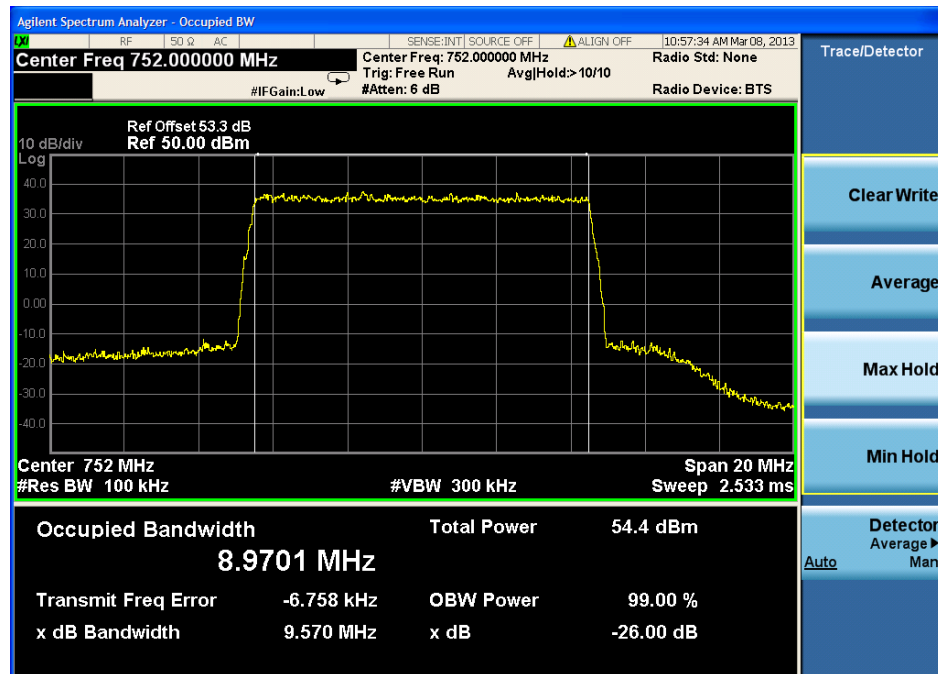



2. Downlink: 869MHz to 894MHz(GSM,CDMA,WCDMA,LTE)

2.1 GSM Mode:

2.1.1 lowest frequency-- Input

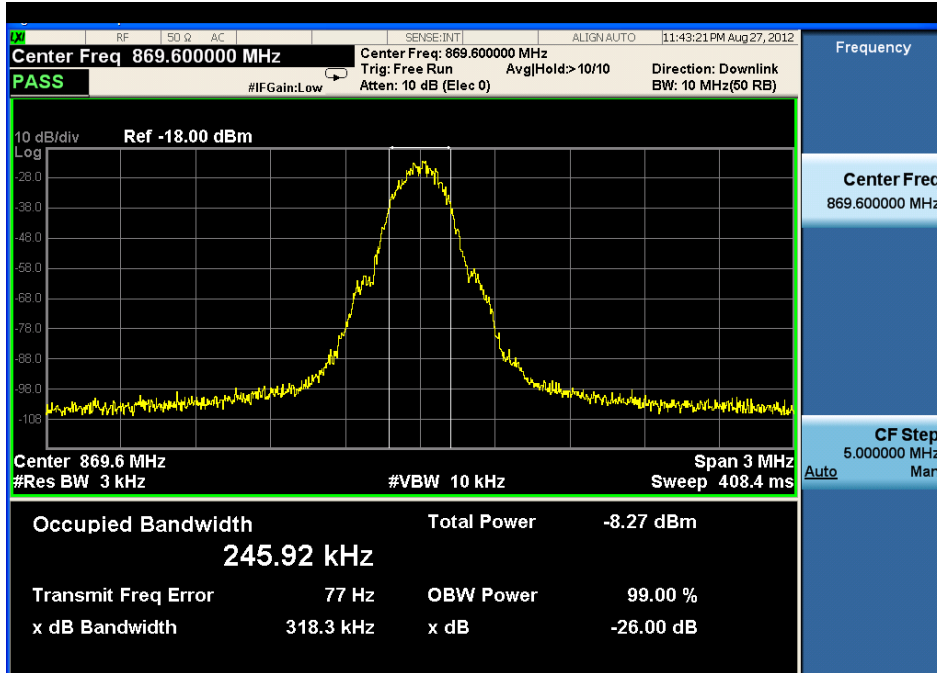

2.1.2 lowest frequency-- Output

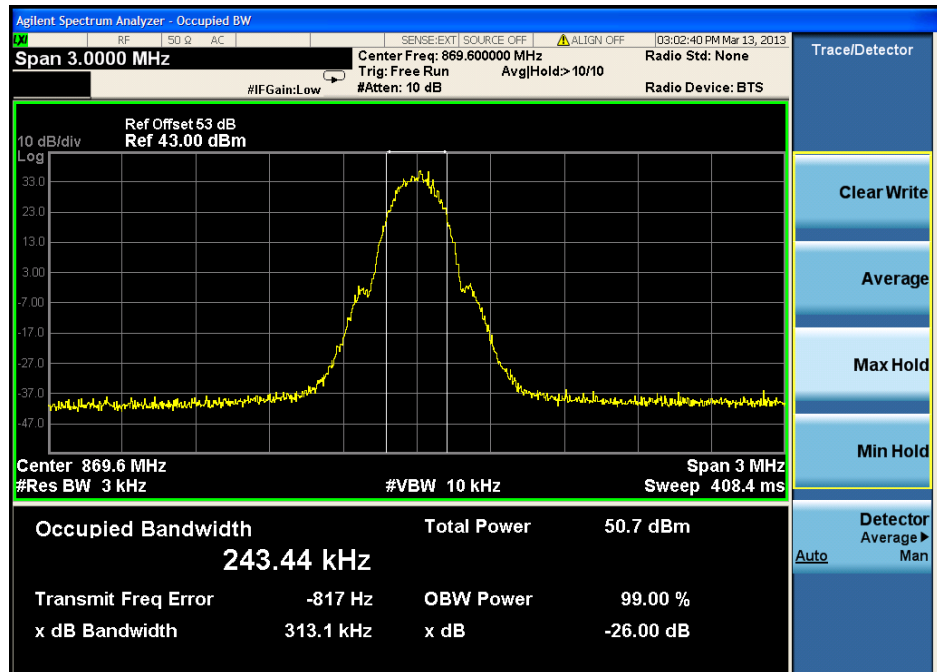



2.1.3 middle frequency-- Input

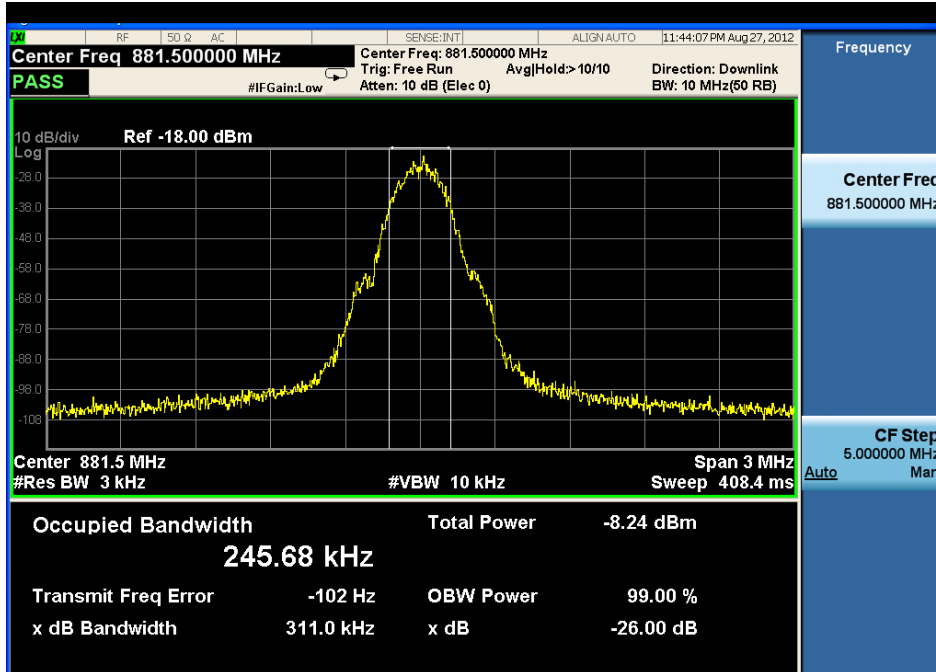

2.1.4 middle frequency-- Output

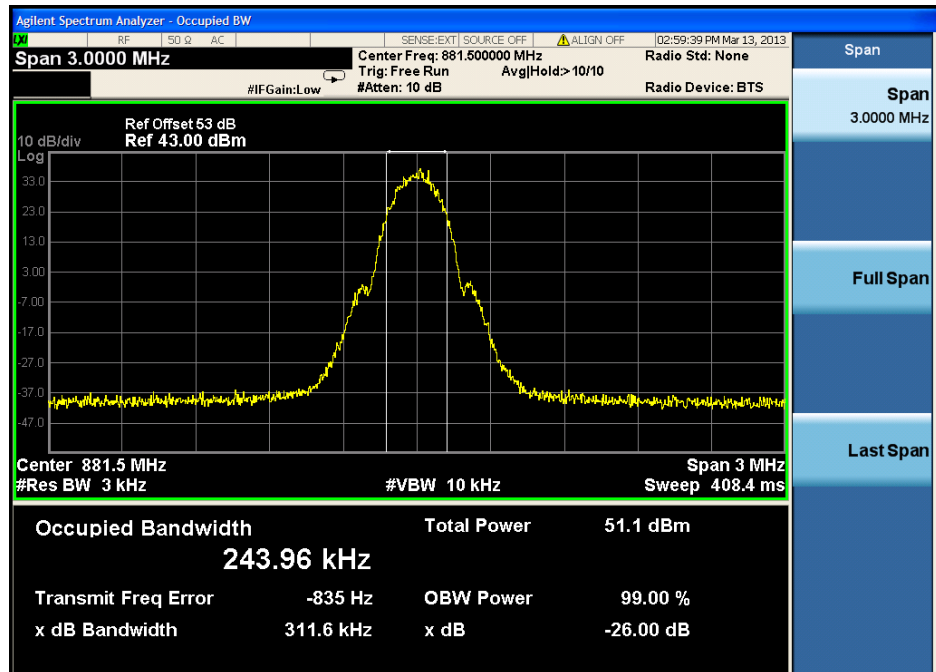



2.1.5 highest frequency—Input

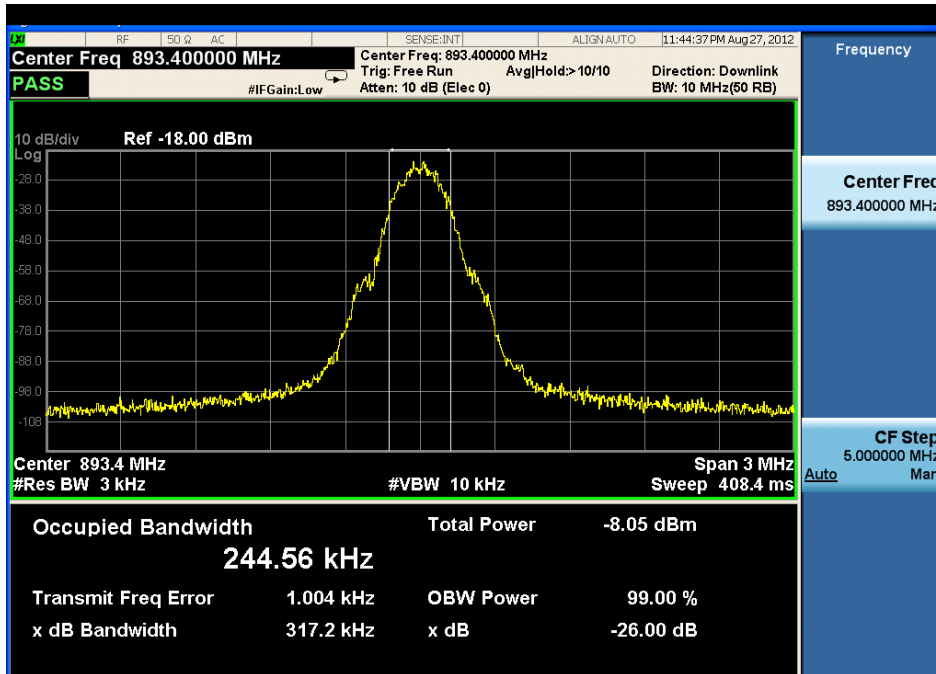

2.1.6 highest frequency--Output

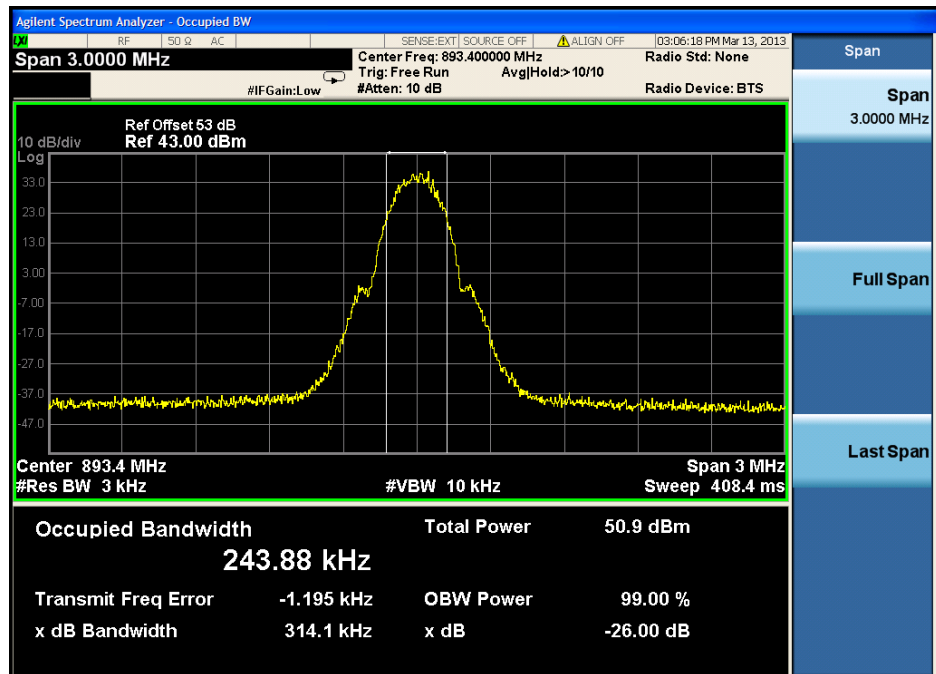



2.2 CDMA Mode:

2.2.1 lowest frequency-- Input

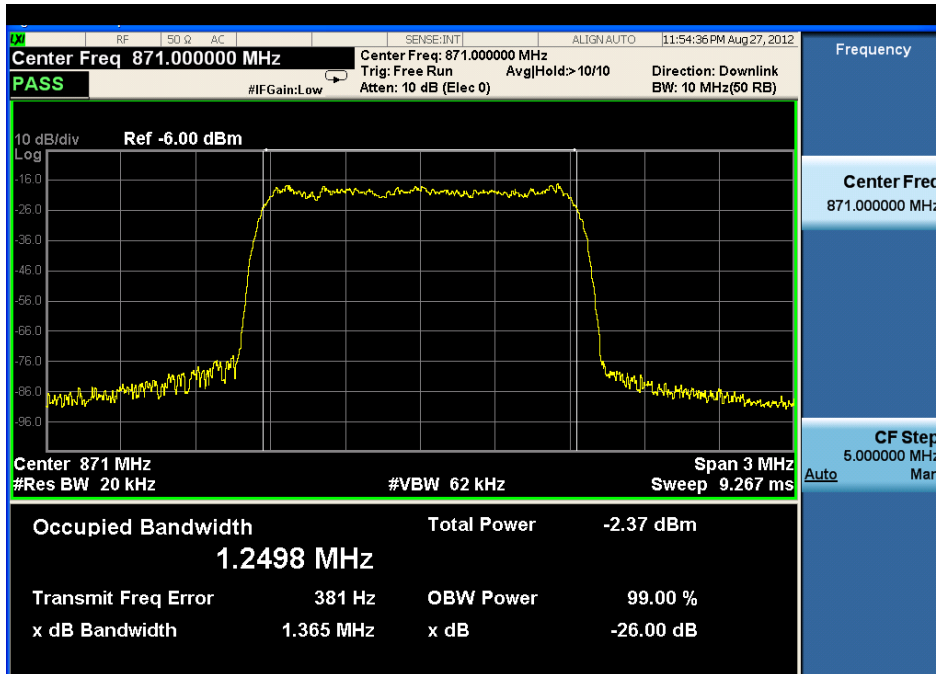

2.2.2 lowest frequency-- Output

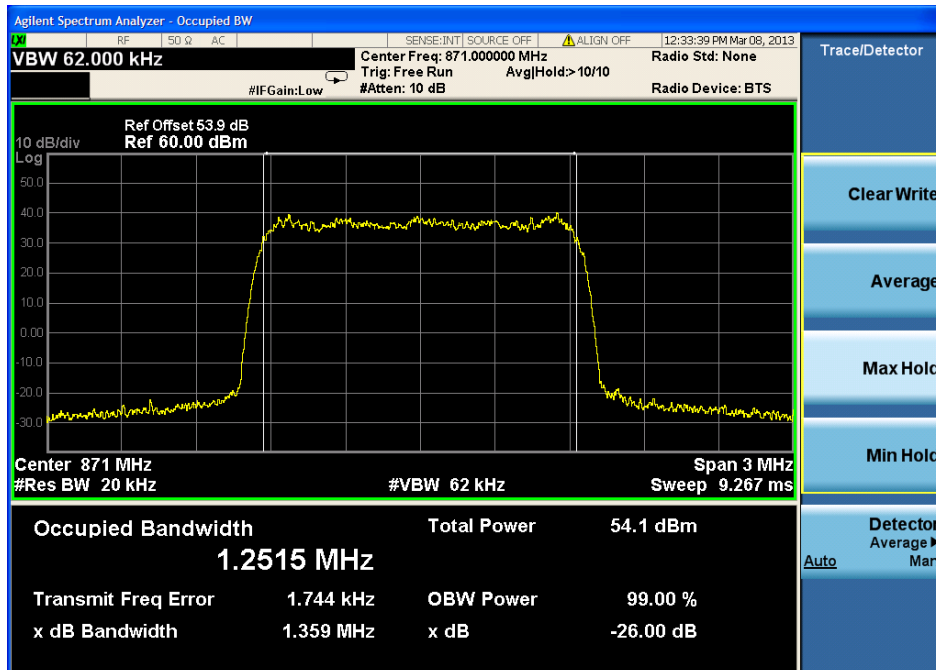



2.2.3 middle frequency-- Input

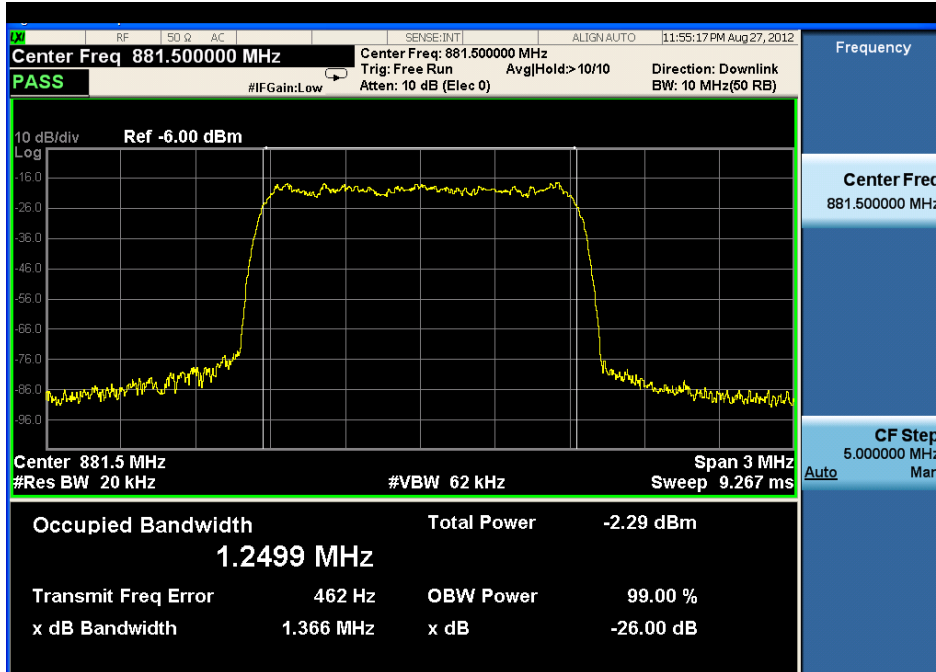

2.2.4 middle frequency-- Output

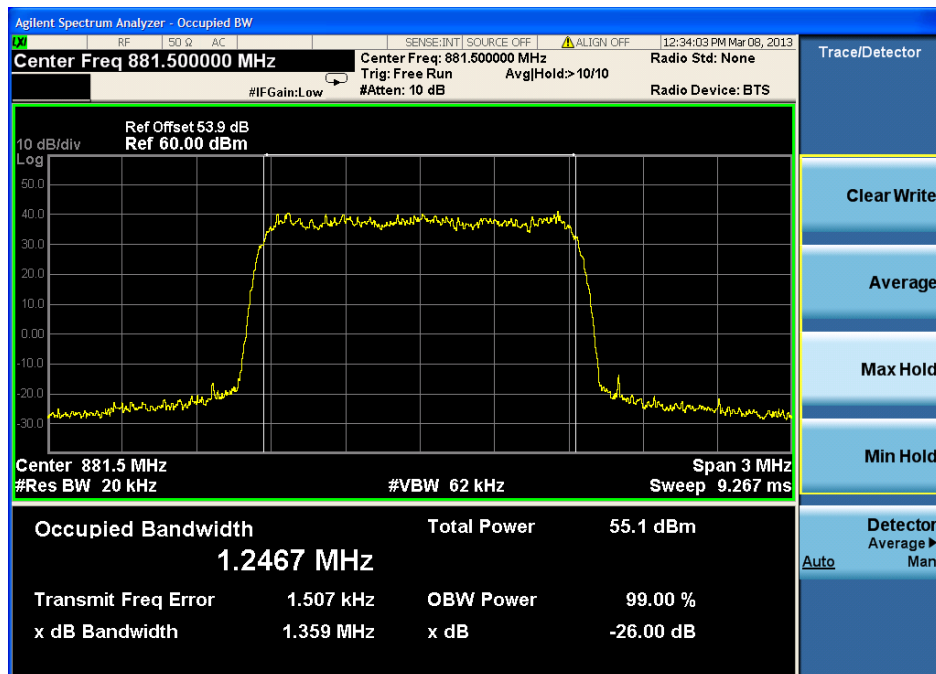



2.2.5 highest frequency—Input

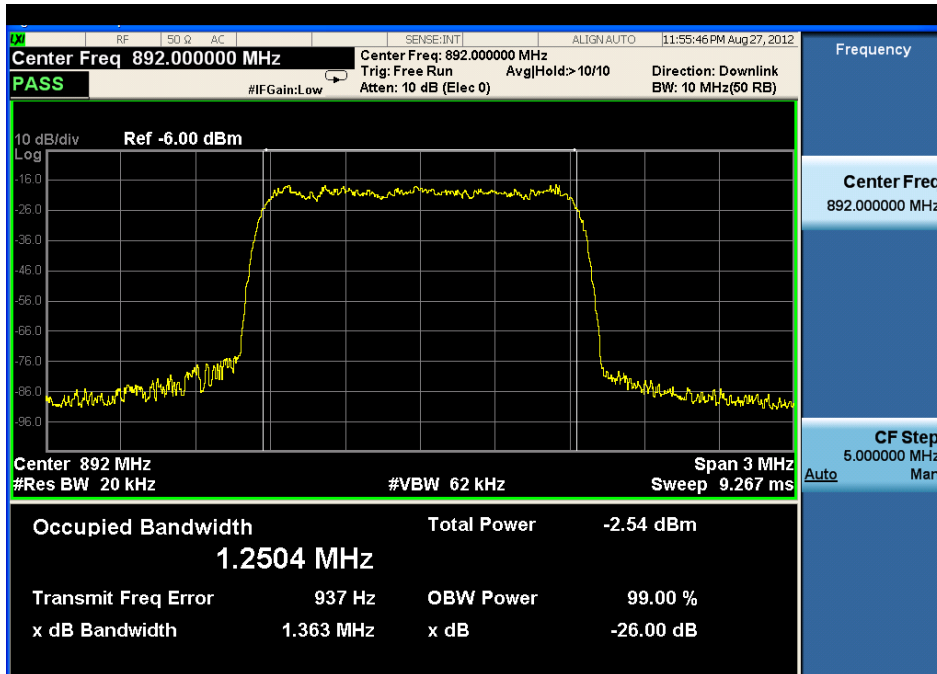

2.2.6 highest frequency--Output

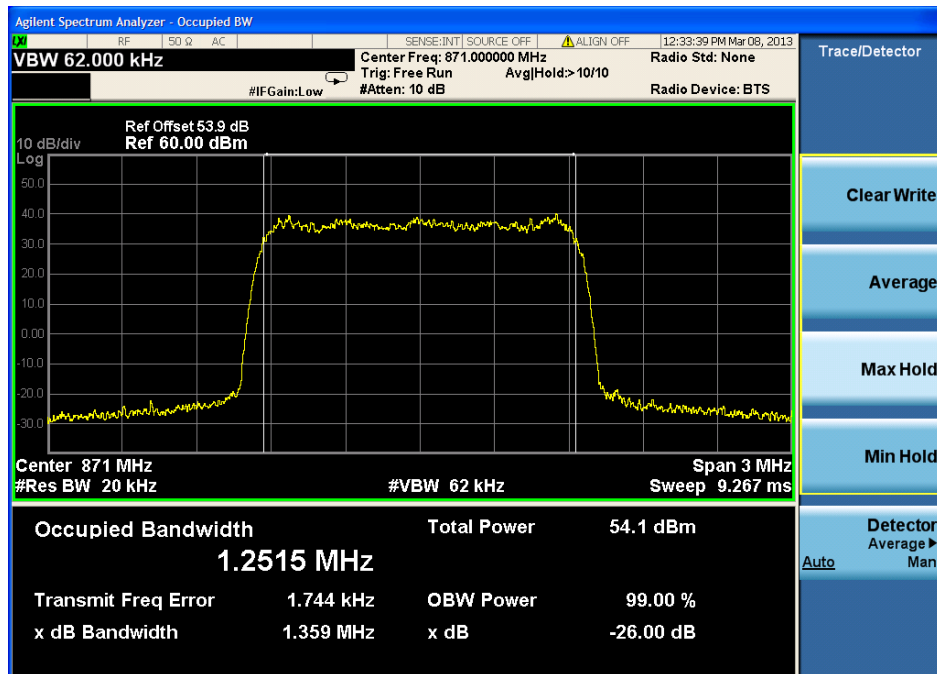



2.3 WCDMA Mode:

2.3.1 lowest frequency-- Input

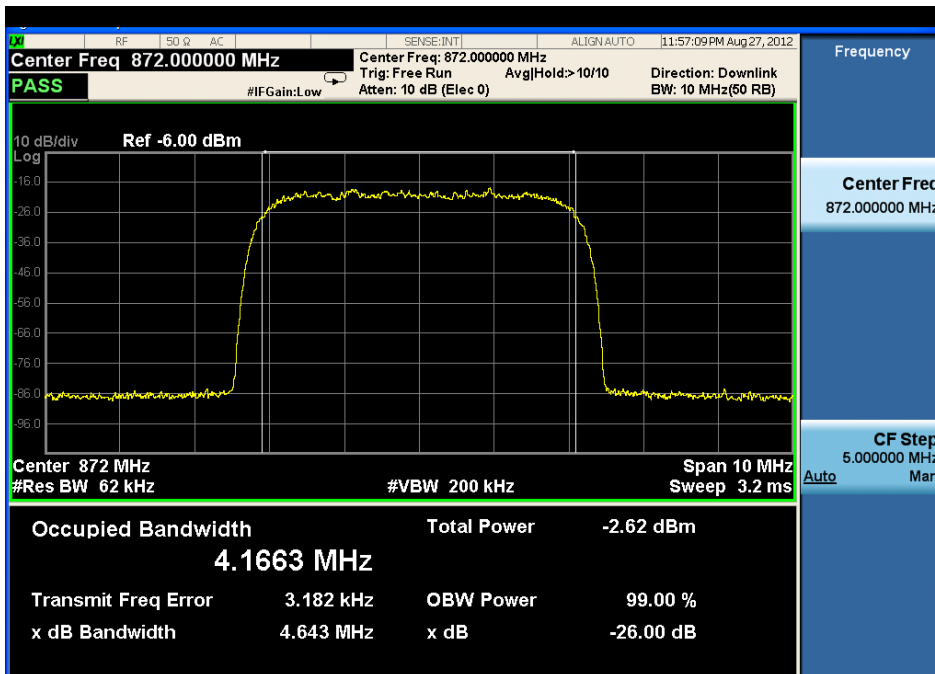

2.3.2 lowest frequency-- Output

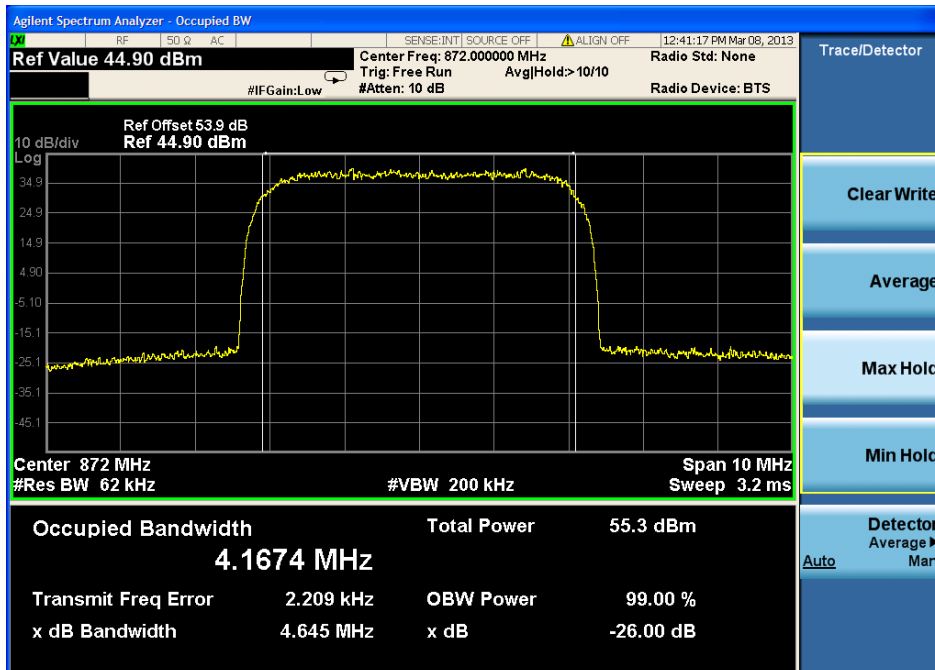



2.3.3 middle frequency-- Input

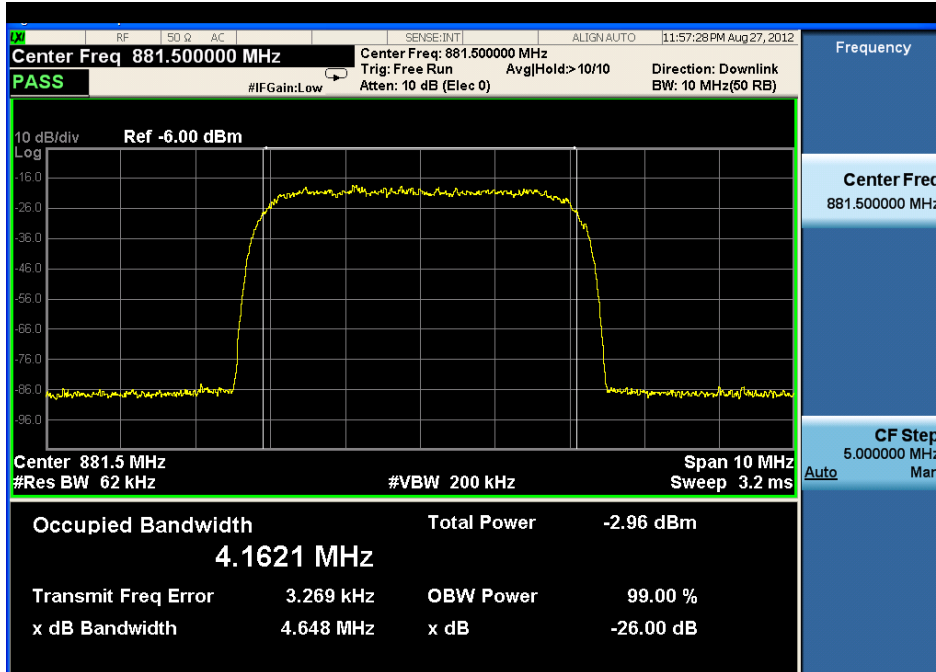

2.3.4 middle frequency-- Output

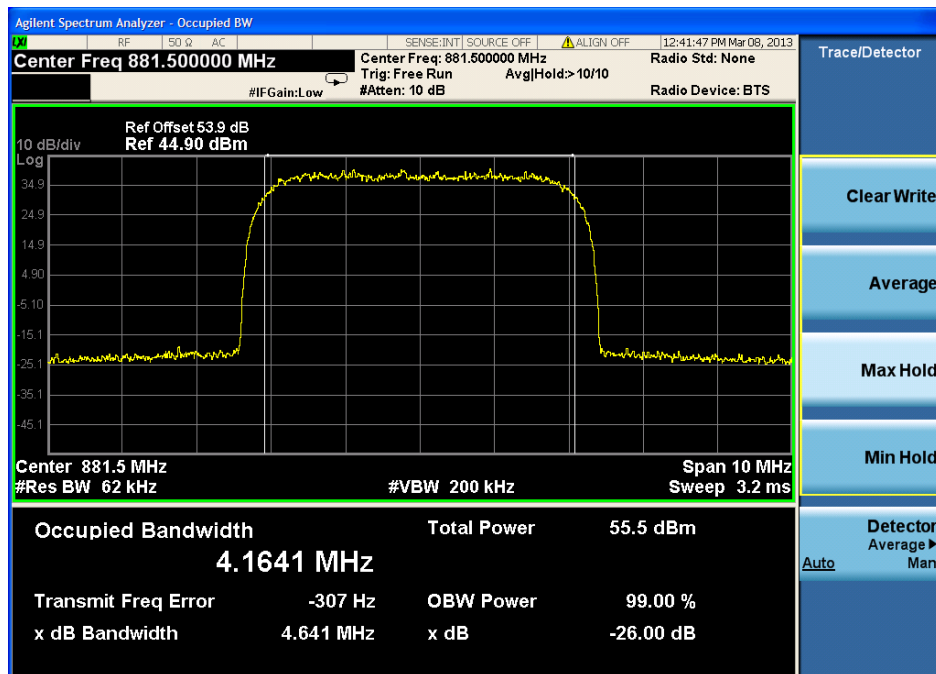



2.3.5 highest frequency—Input

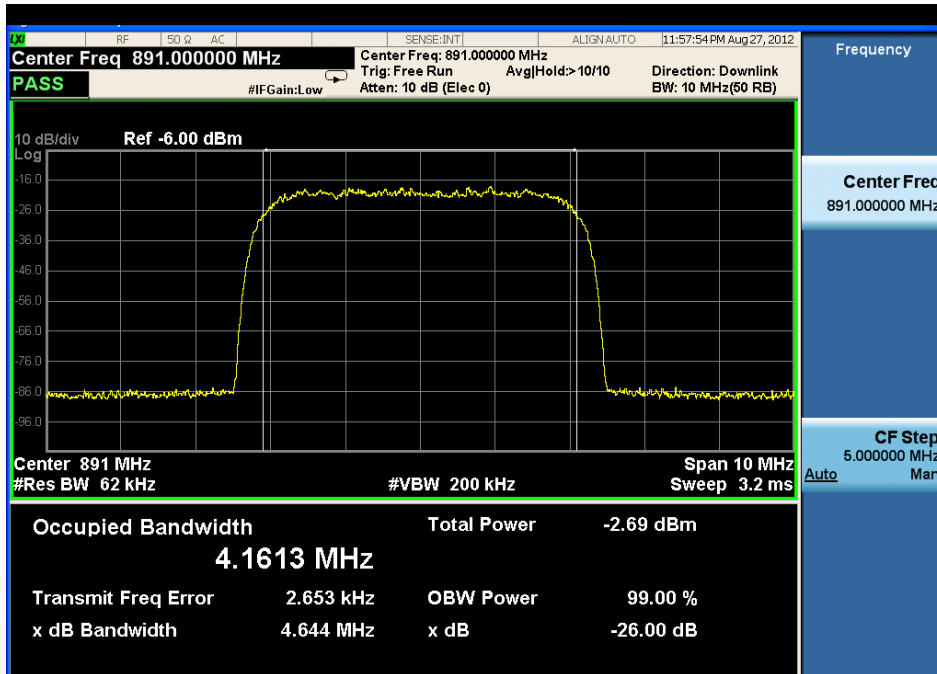

2.3.6 highest frequency--Output

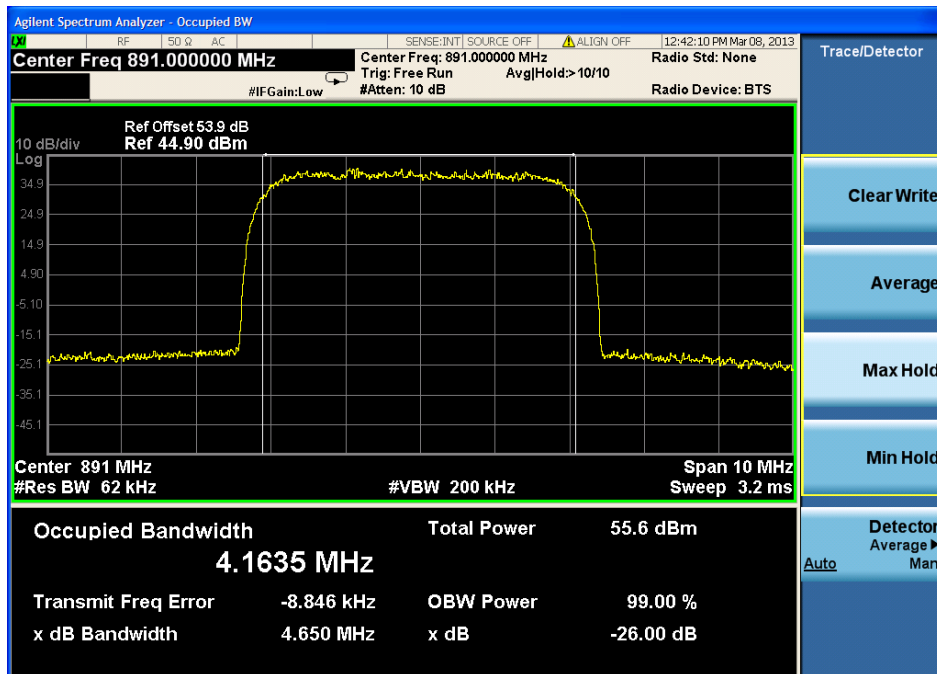



2.4 LTEMode:

2.4.1 lowest frequency-- Input

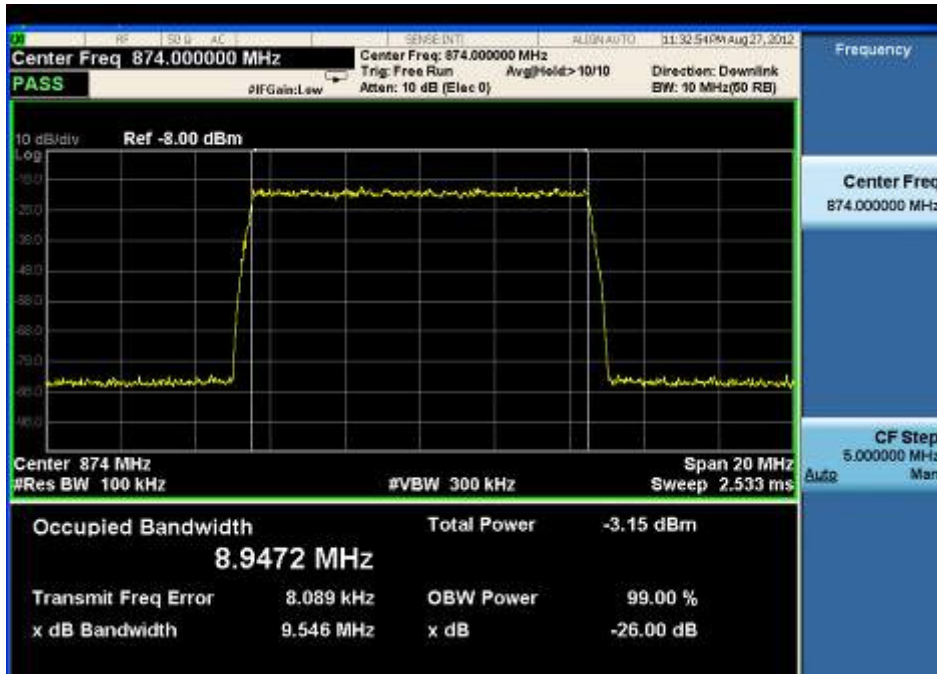

2.4.2 lowest frequency-- Output

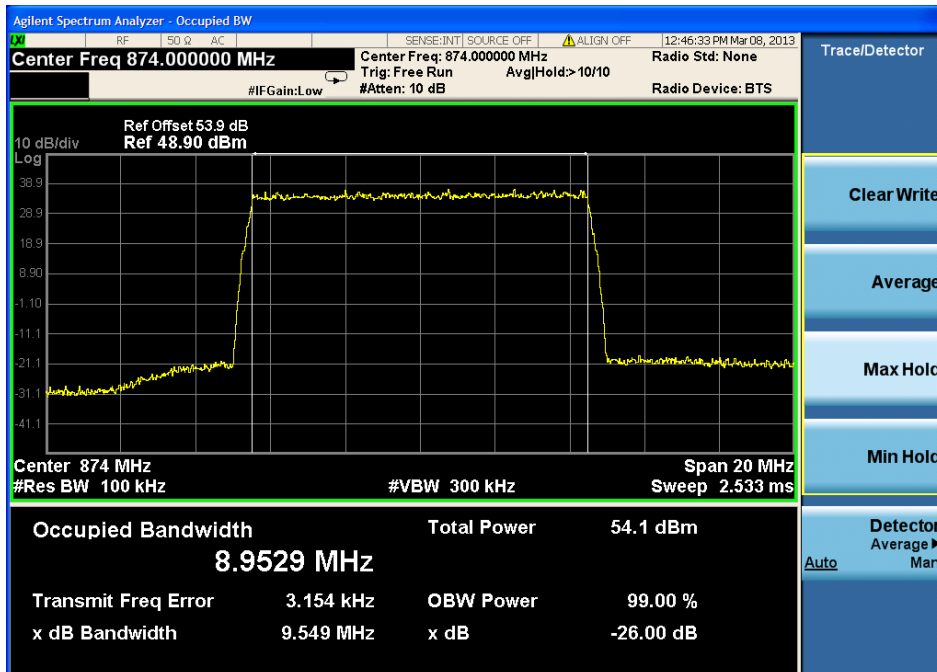



2.4.3 middle frequency-- Input

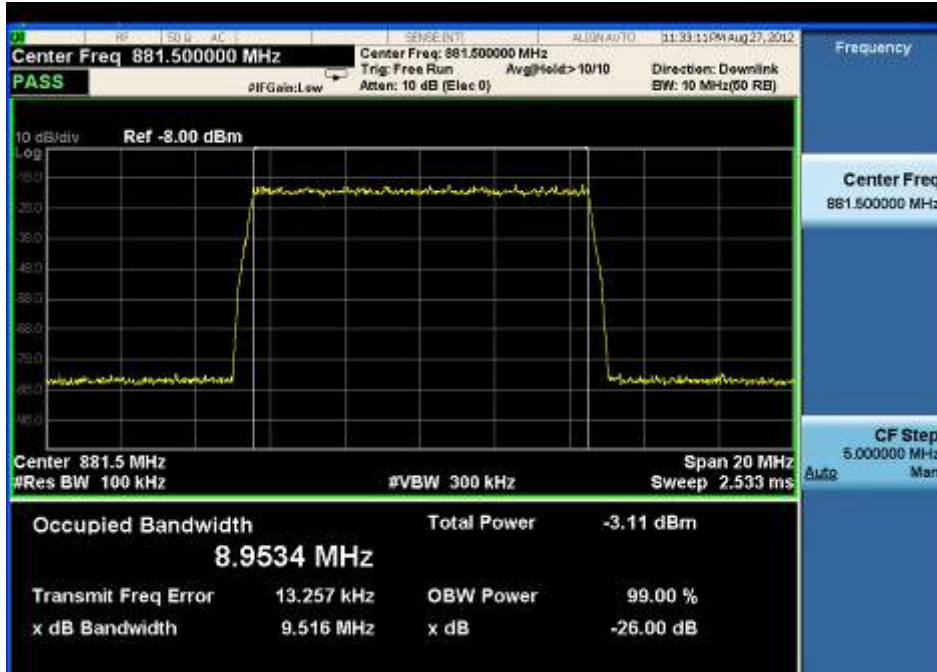

2.4.4 middle frequency-- Output

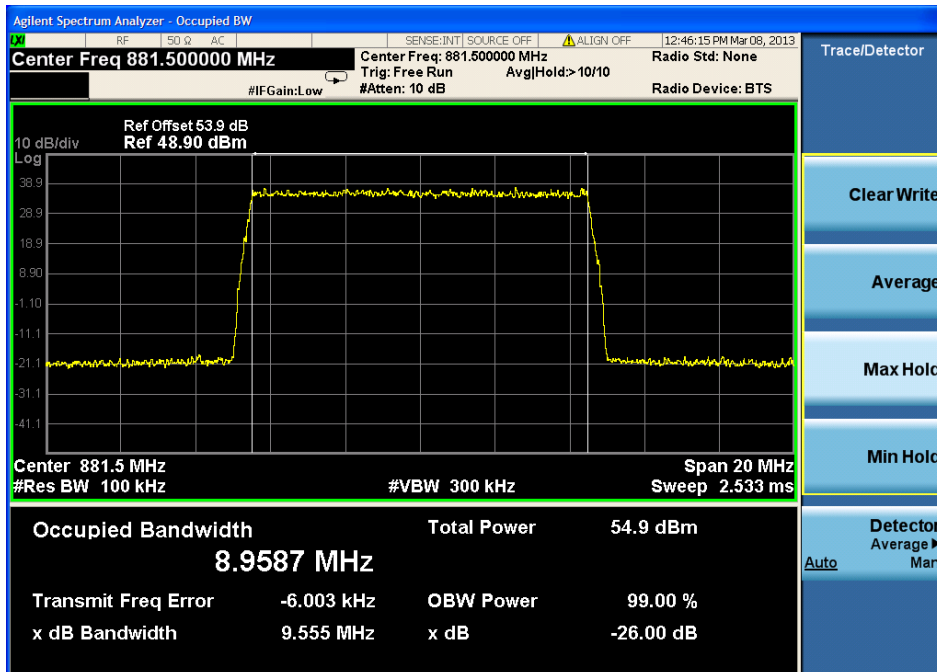



2.4.5 highest frequency—Input

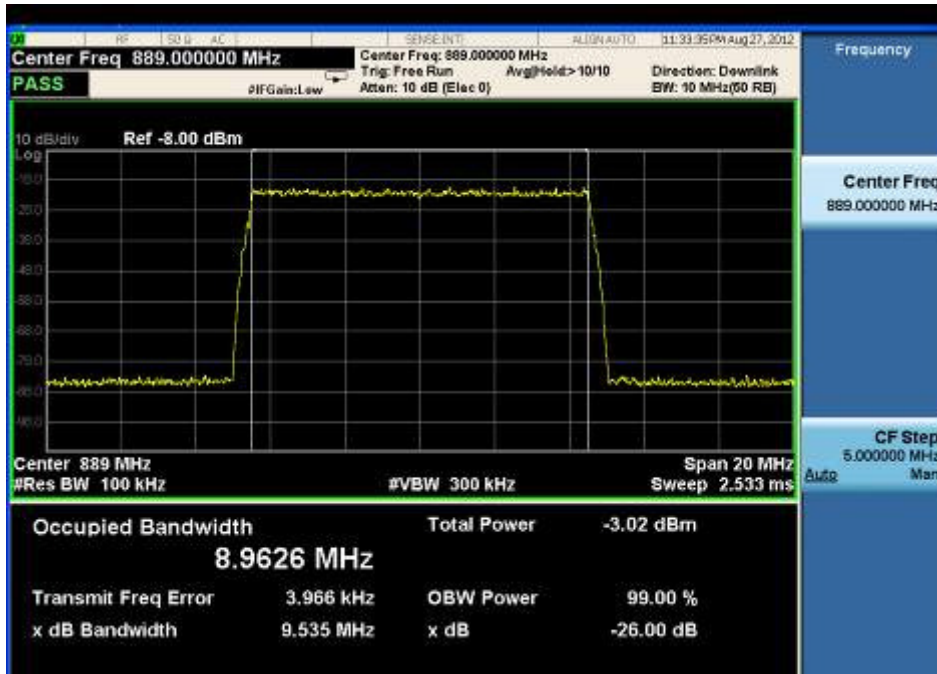

2.4.6 highest frequency--Output

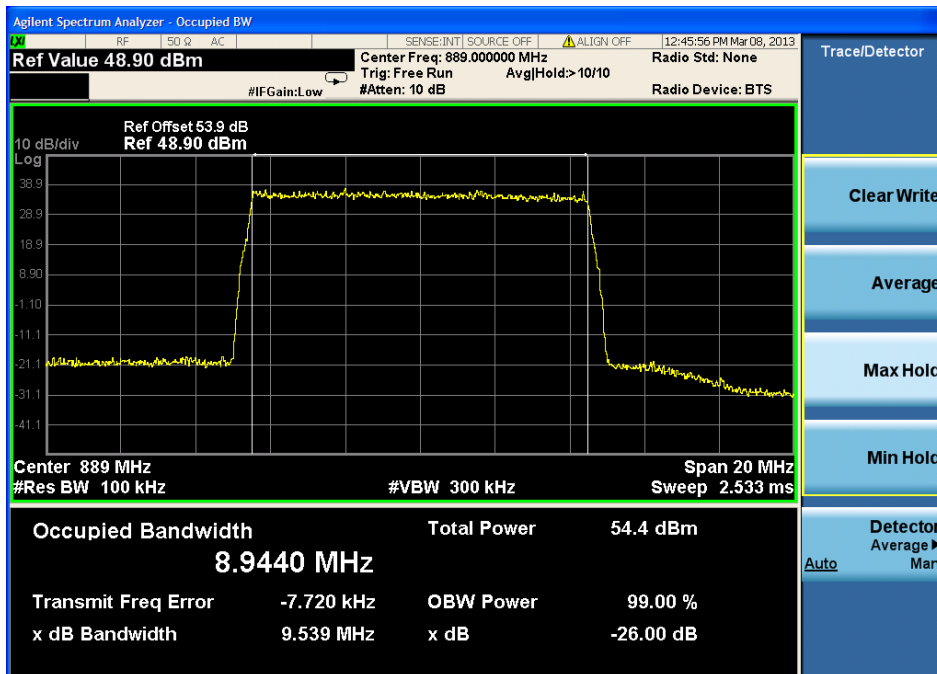



3. Downlink: 1930MHz to 1995MHz(GSM,CDMA,WCDMA,LTE)

3.1 GSM Mode:

3.1.1 lowest frequency-- Input

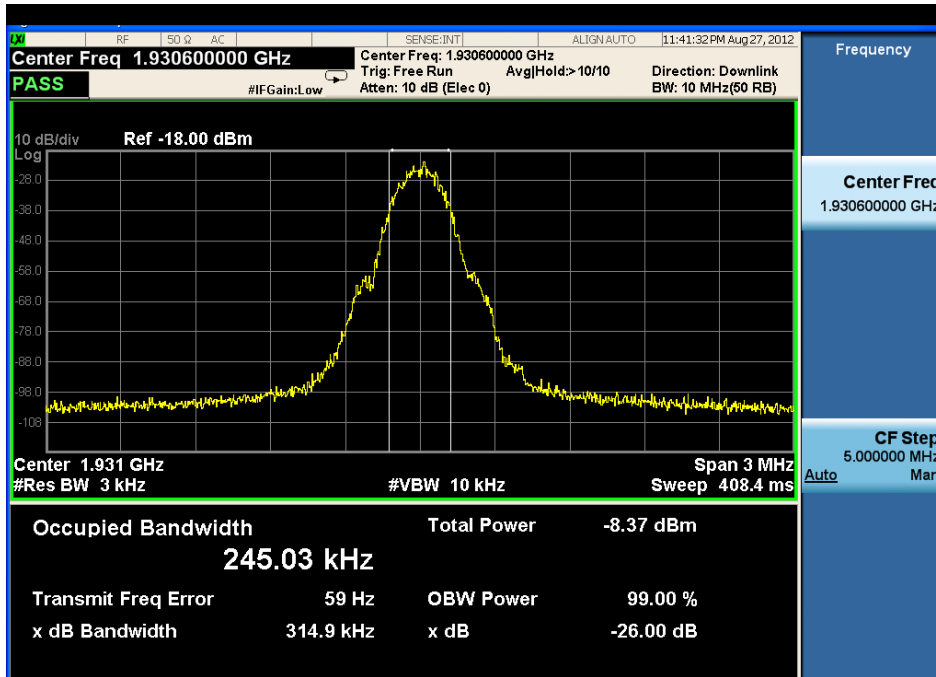

3.1.2 lowest frequency-- Output

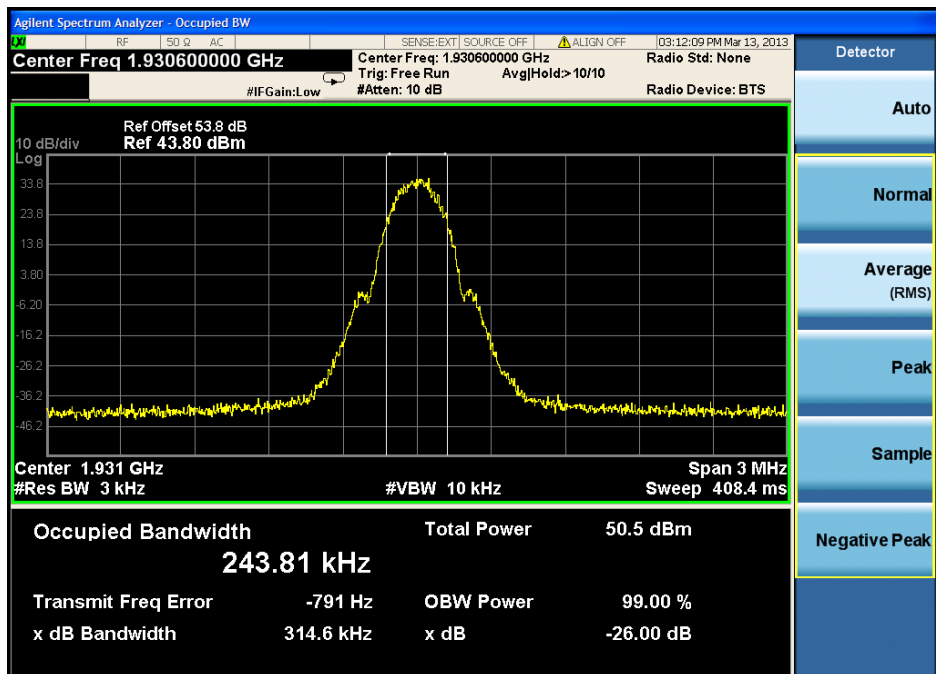



3.1.3 middle frequency-- Input

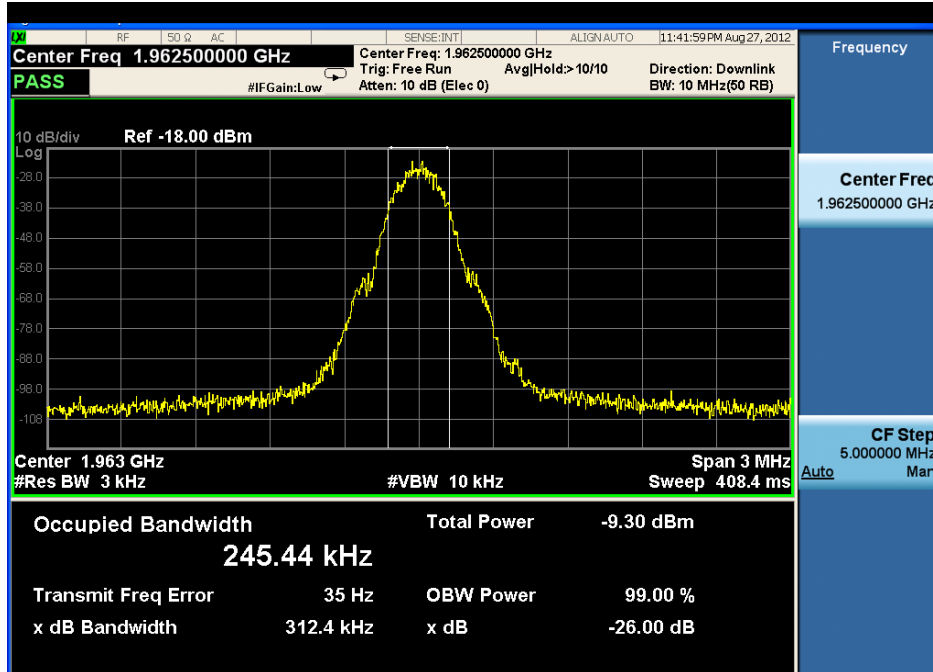

3.1.4 middle frequency-- Output

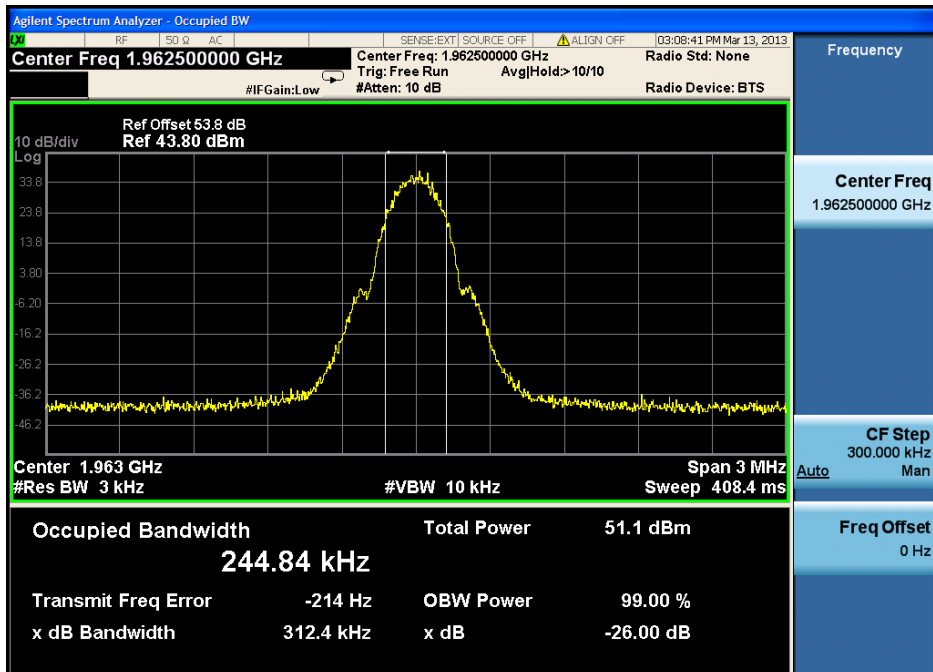



3.1.5 highest frequency—Input

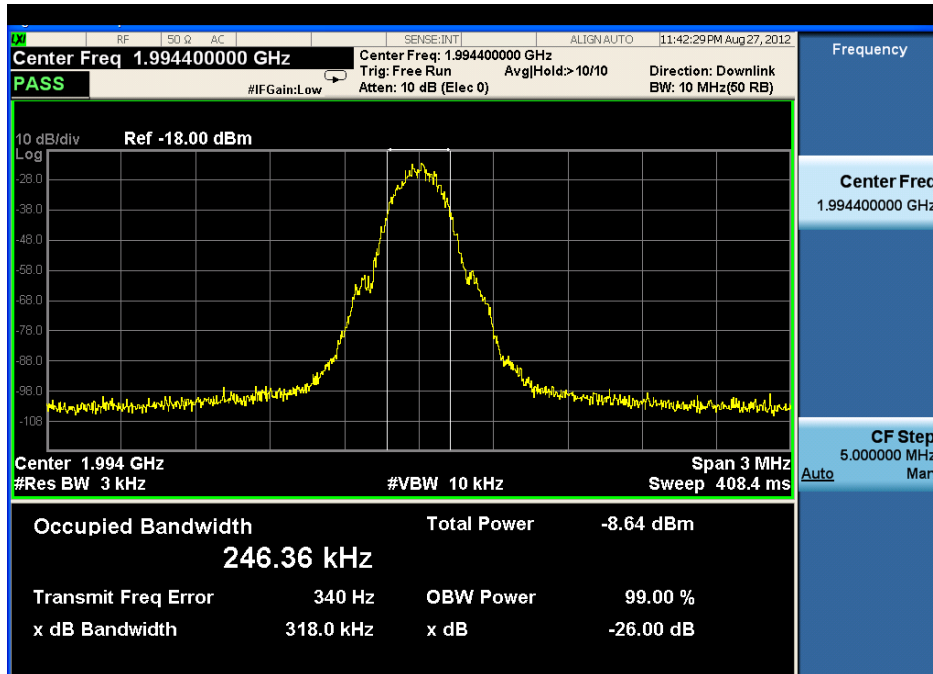

3.1.6 highest frequency--Output

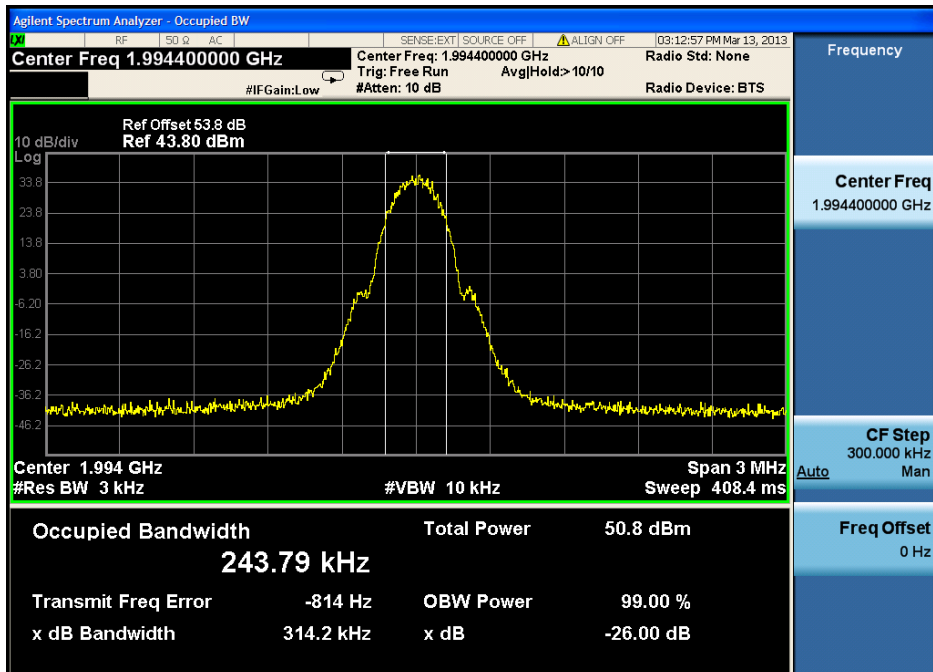



3.2 CDMA Mode:

3.2.1 lowest frequency-- Input

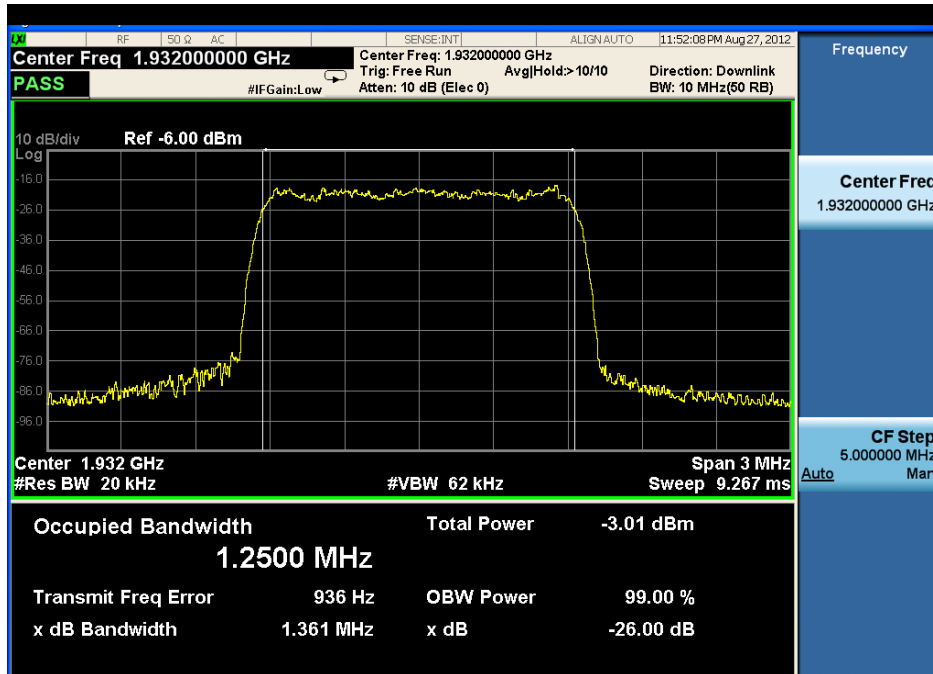

3.2.2 lowest frequency-- Output

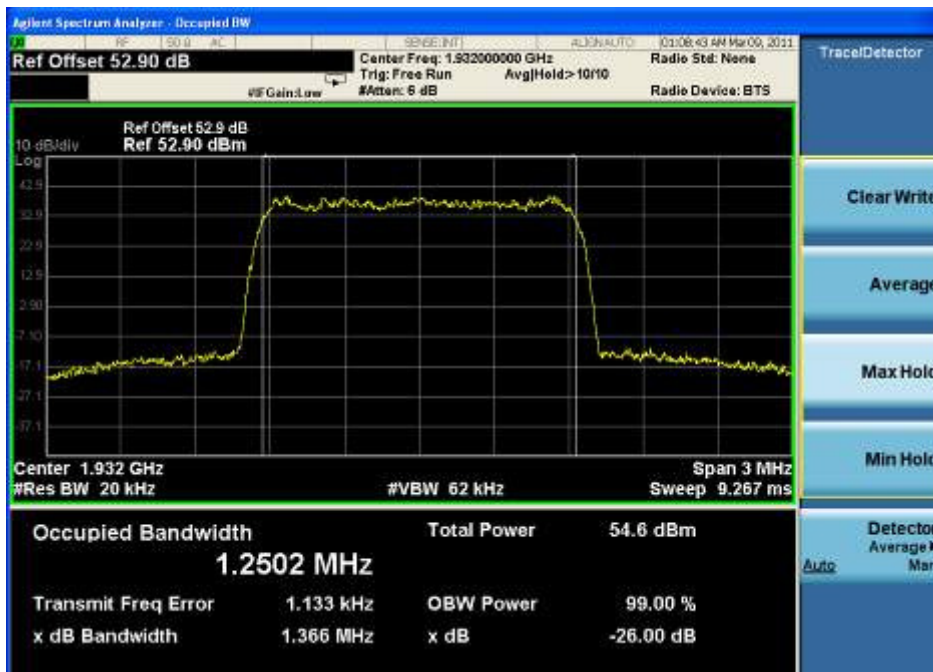



3.2.3 middle frequency-- Input

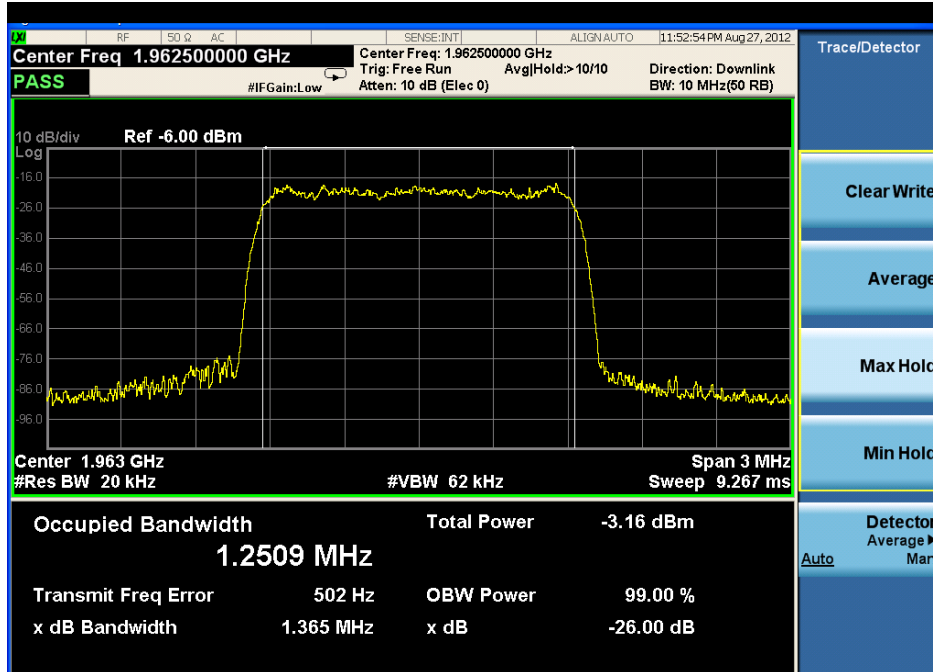

3.2.4 middle frequency-- Output

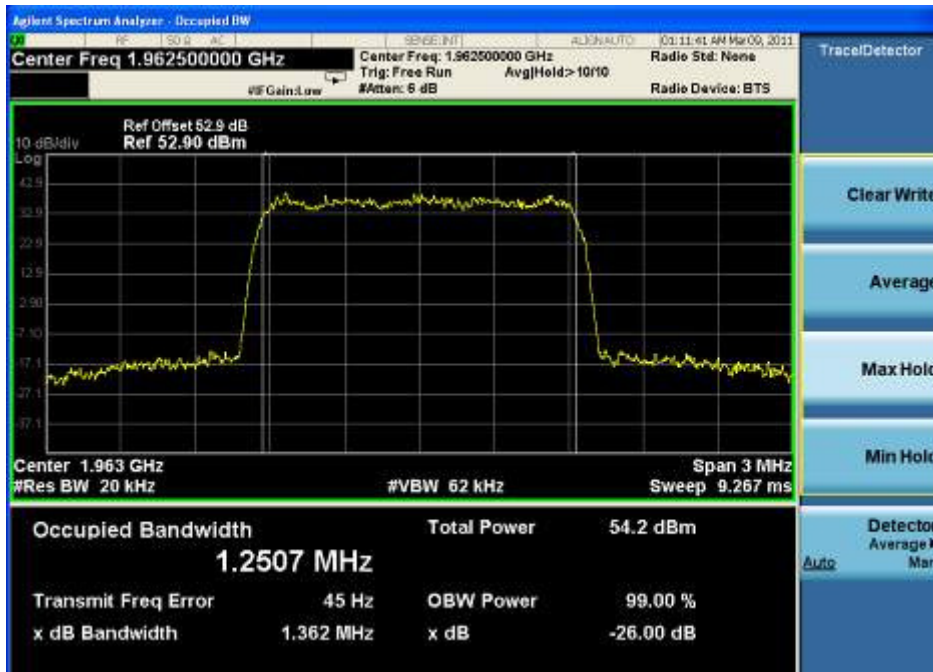



3.2.5 highest frequency—Input

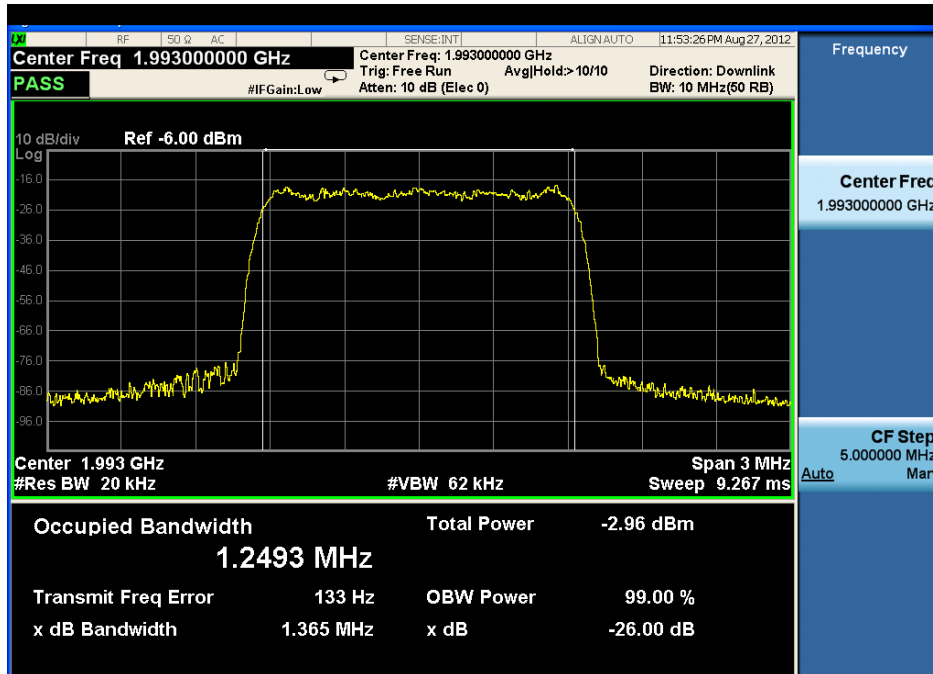

3.2.6 highest frequency--Output

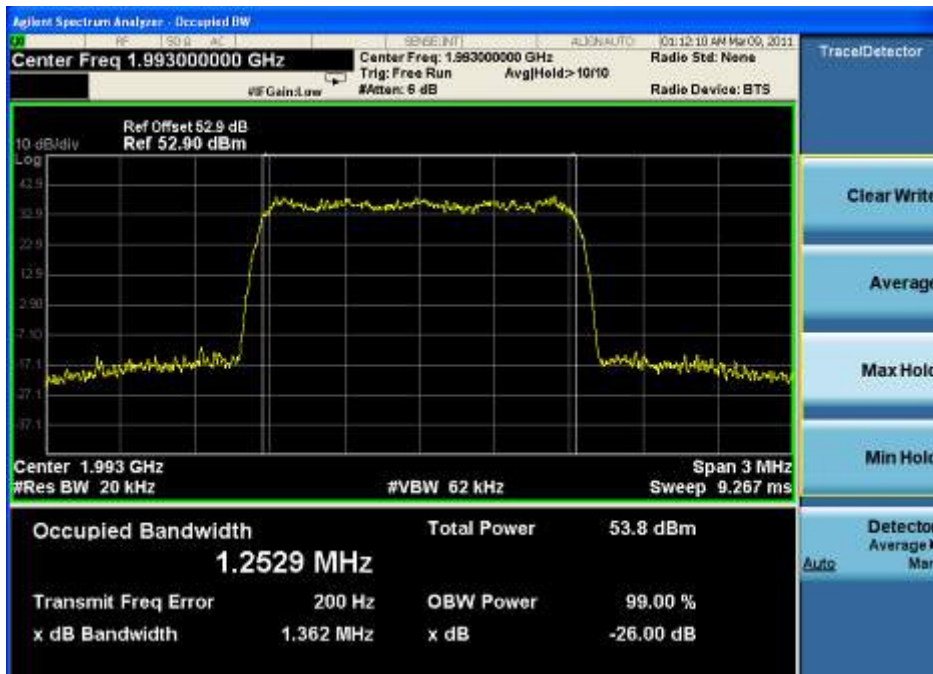



3.3 WCDMA Mode:

3.3.1 lowest frequency-- Input

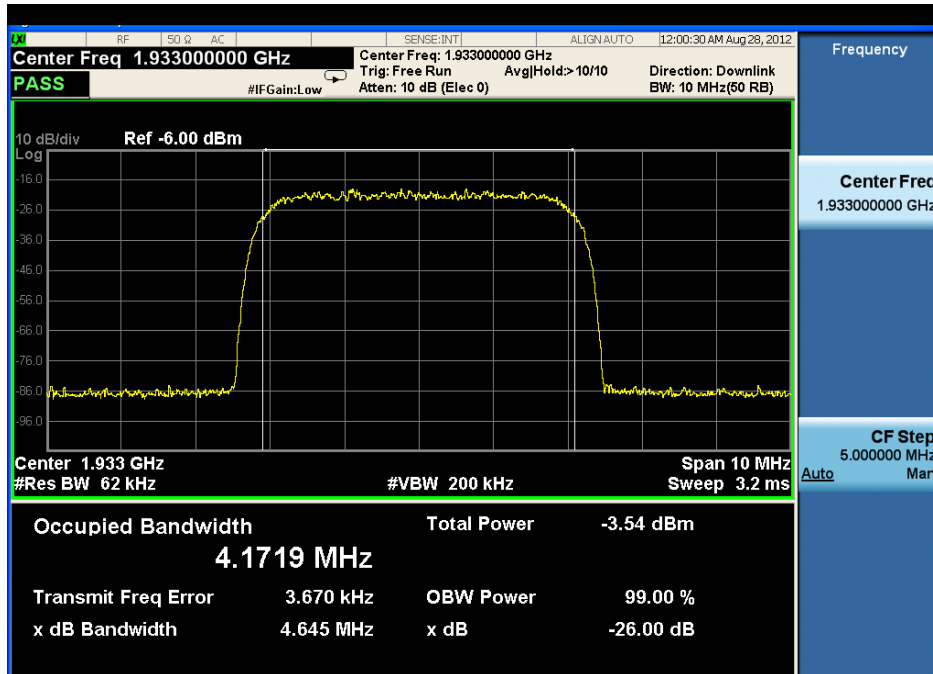

3.3.2 lowest frequency-- Output

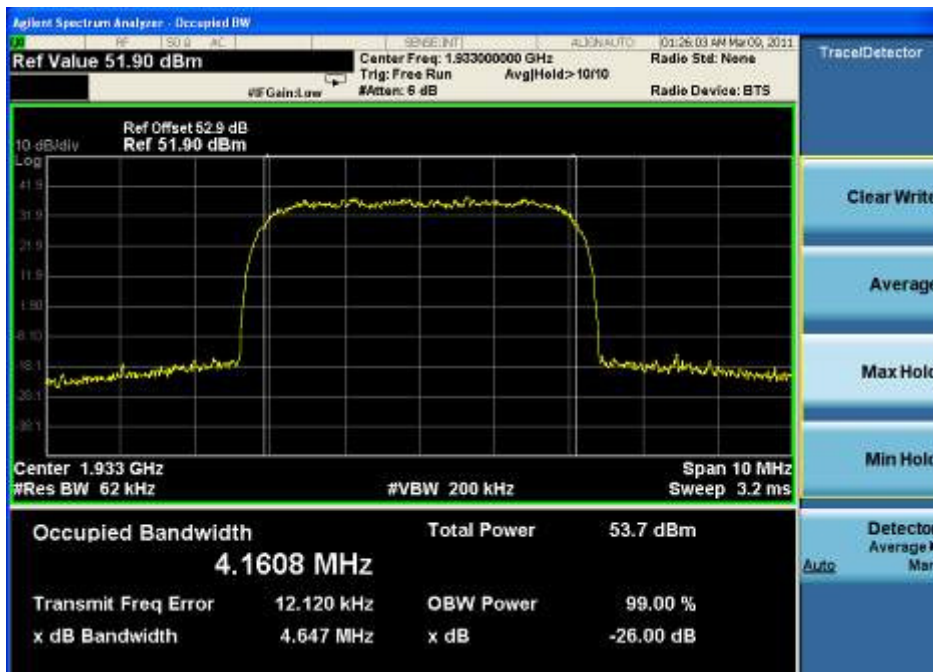



3.3.3 middle frequency-- Input

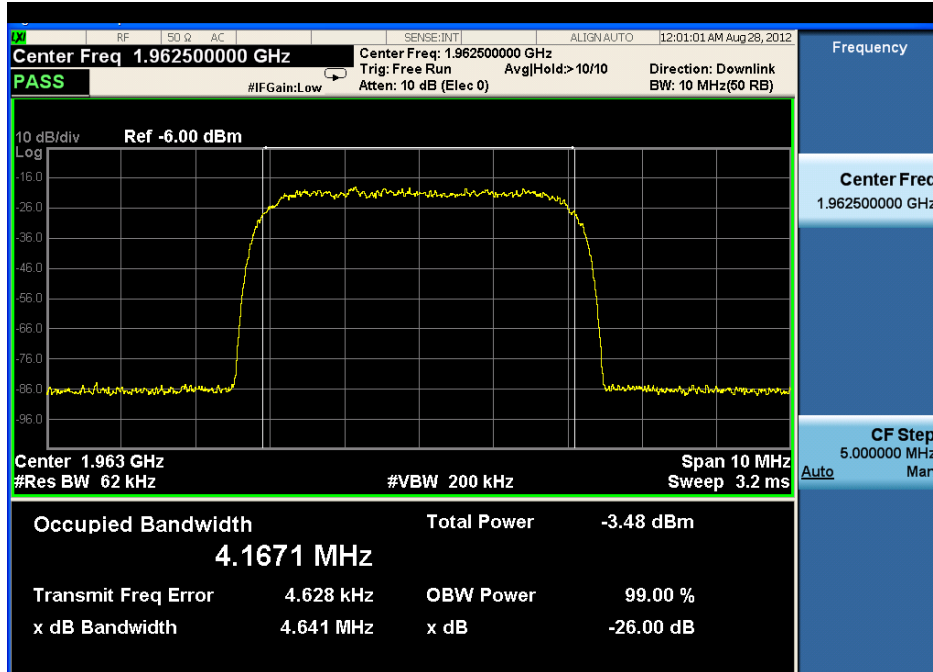

3.3.4 middle frequency-- Output

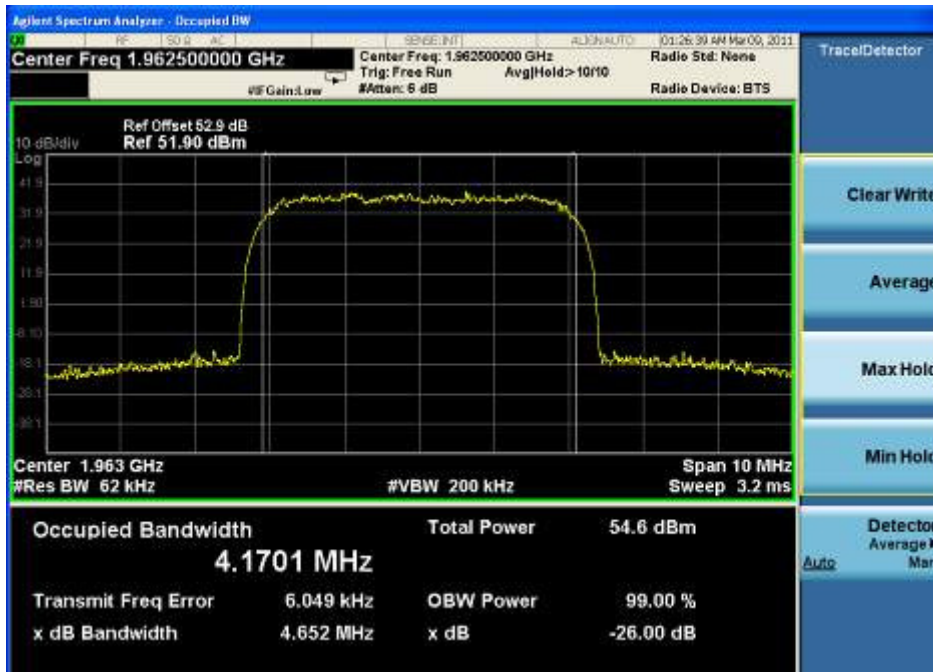



3.3.5 highest frequency—Input

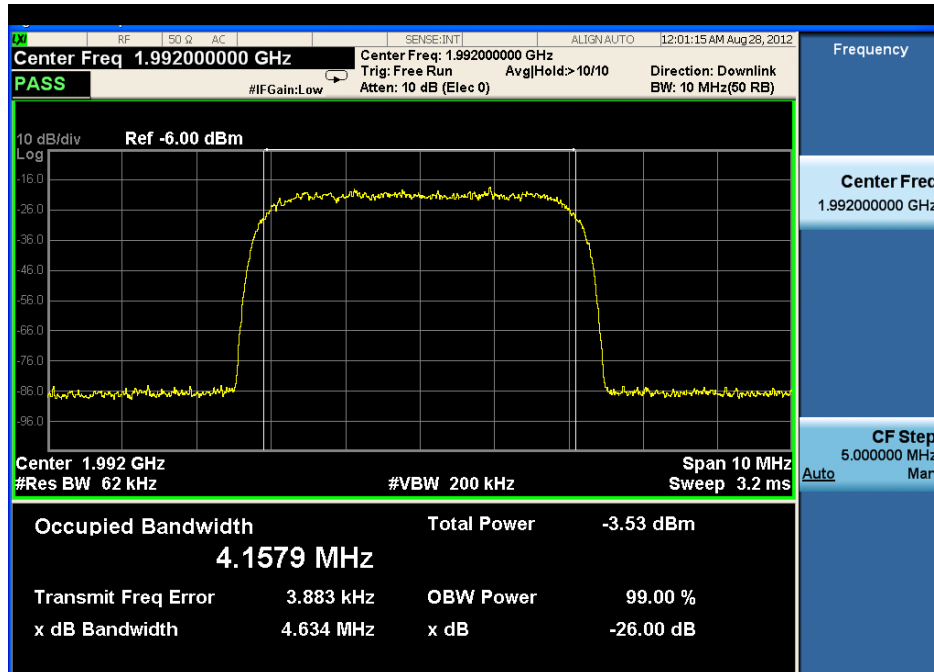

3.3.6 highest frequency--Output

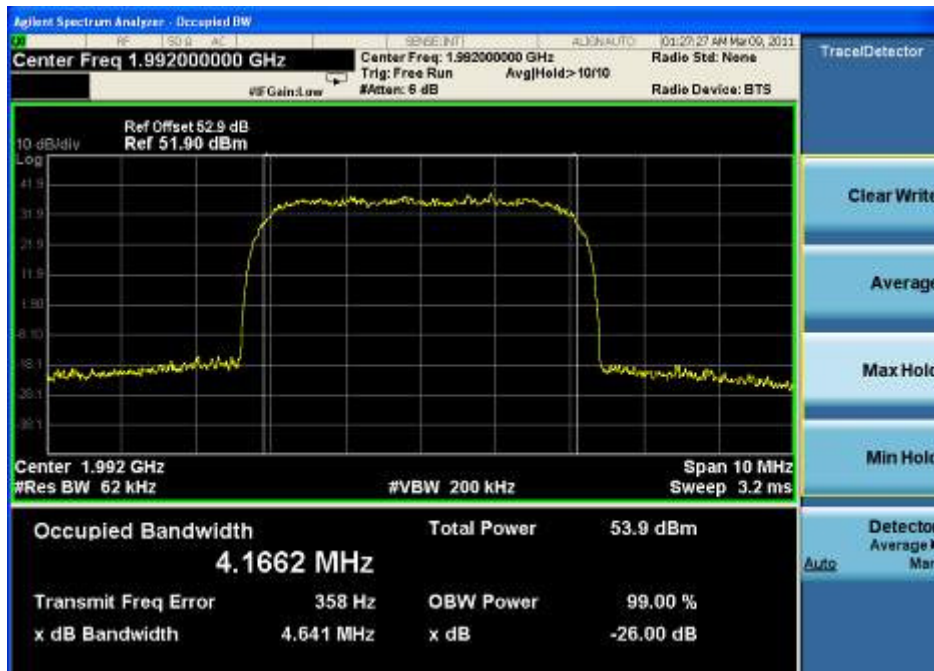



3.4 LTE Mode:

3.4.1 lowest frequency-- Input

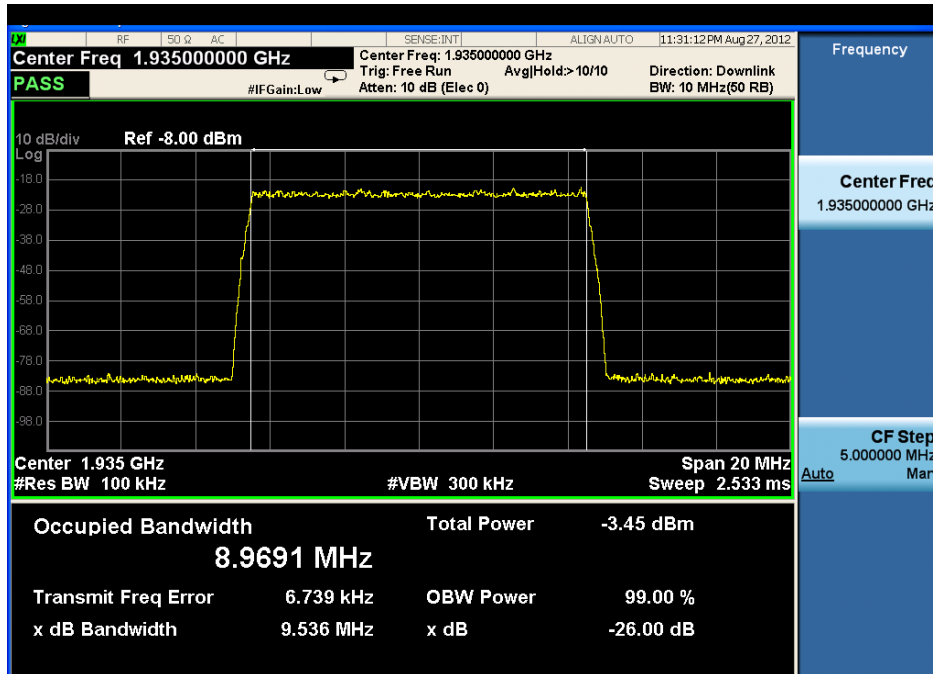

3.4.2 lowest frequency-- Output

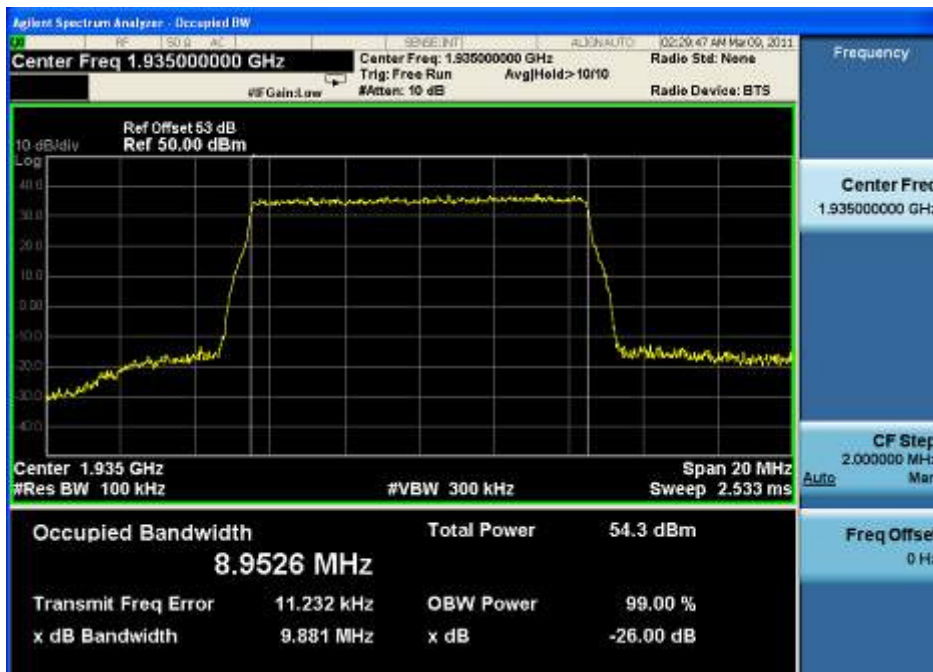



3.4.3 middle frequency-- Input

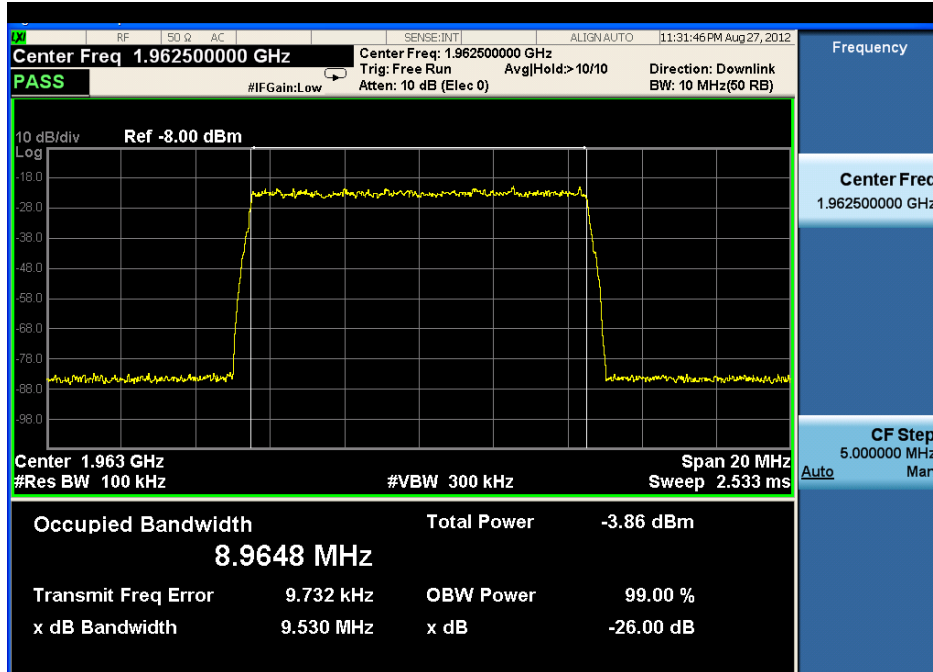

3.4.4 middle frequency-- Output

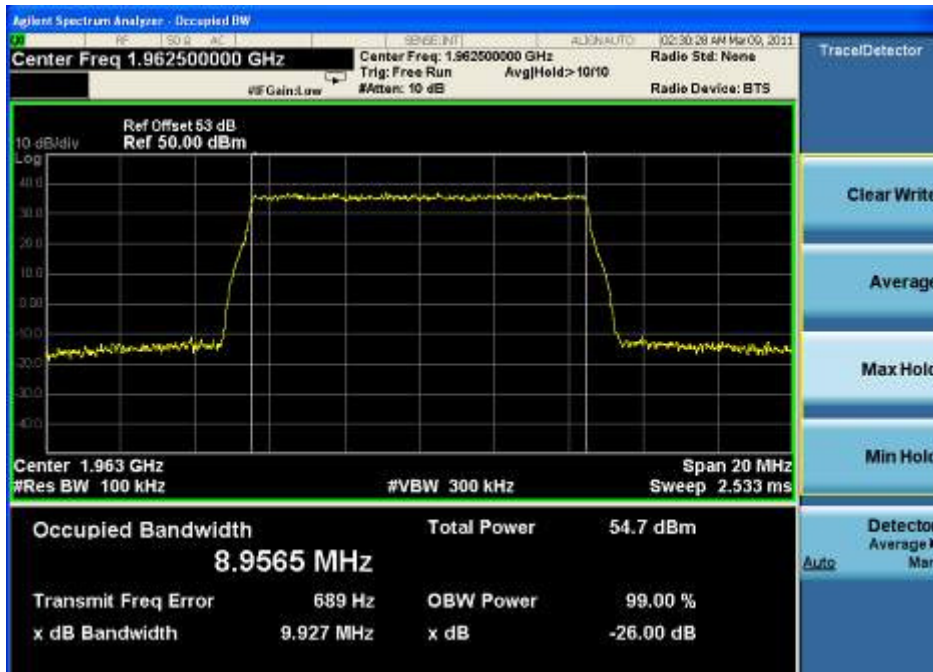



3.4.5 highest frequency—Input

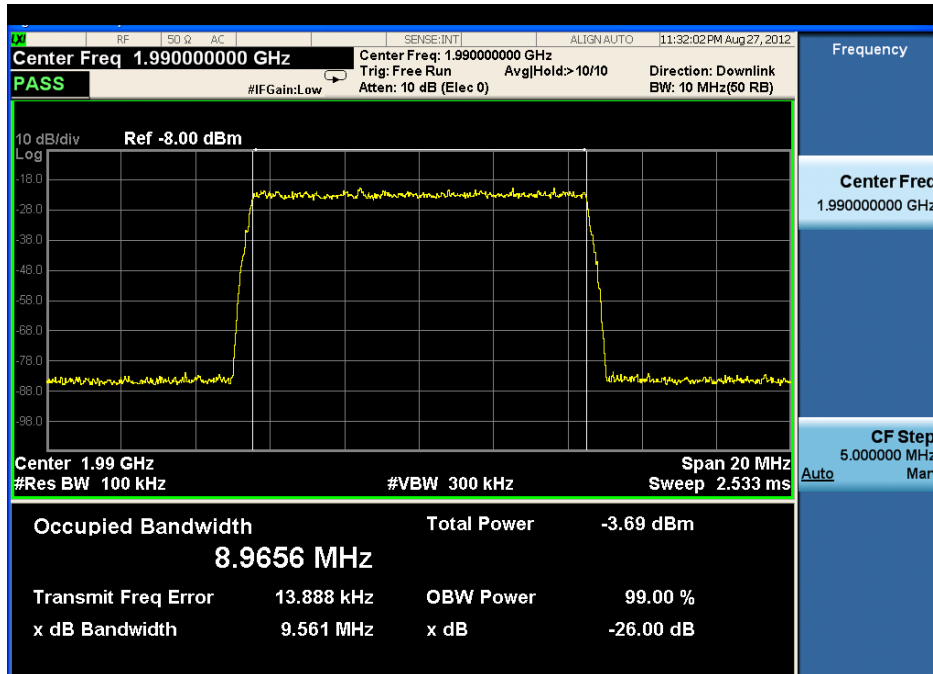

3.4.6 highest frequency--Output





4. Downlink: 2110MHz to 2155MHz(CDMA,WCDMA,LTE)

4.1 CDMA Mode:

4.1.1 lowest frequency-- Input

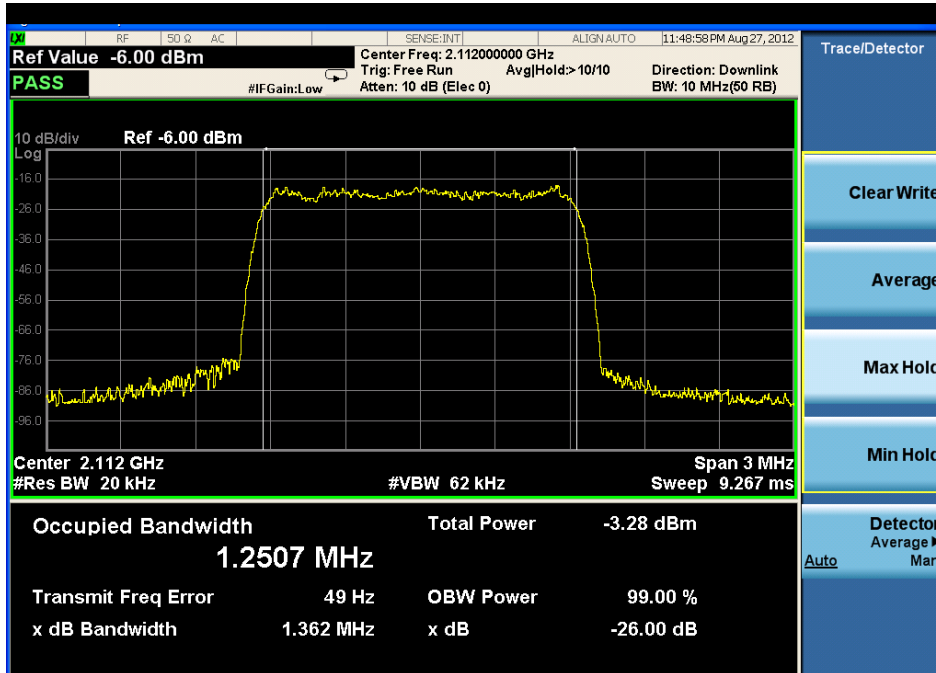

4.1.2 lowest frequency-- Output

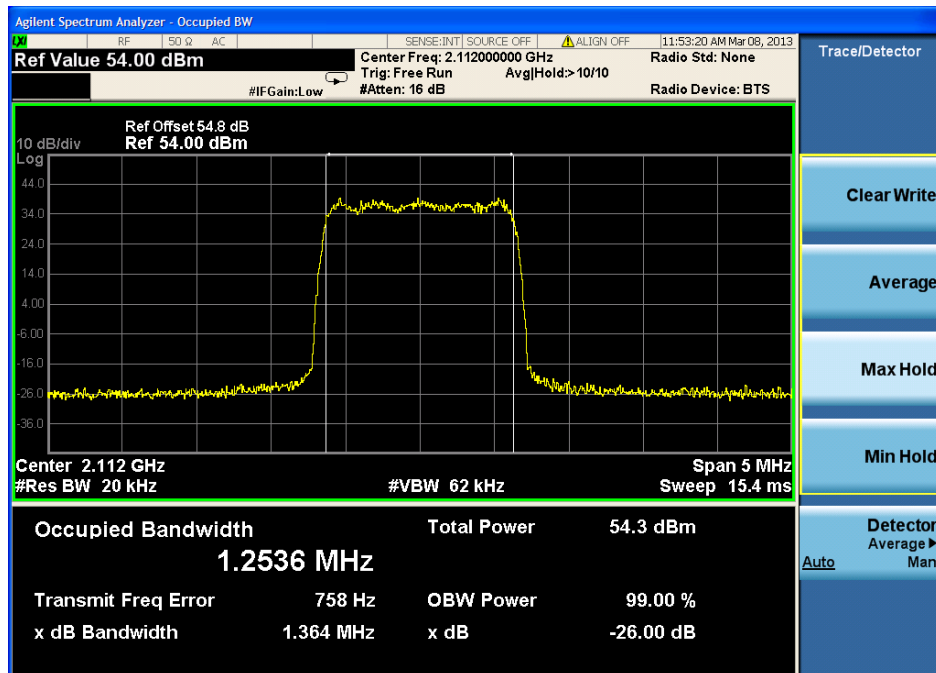



4.1.3 middle frequency-- Input

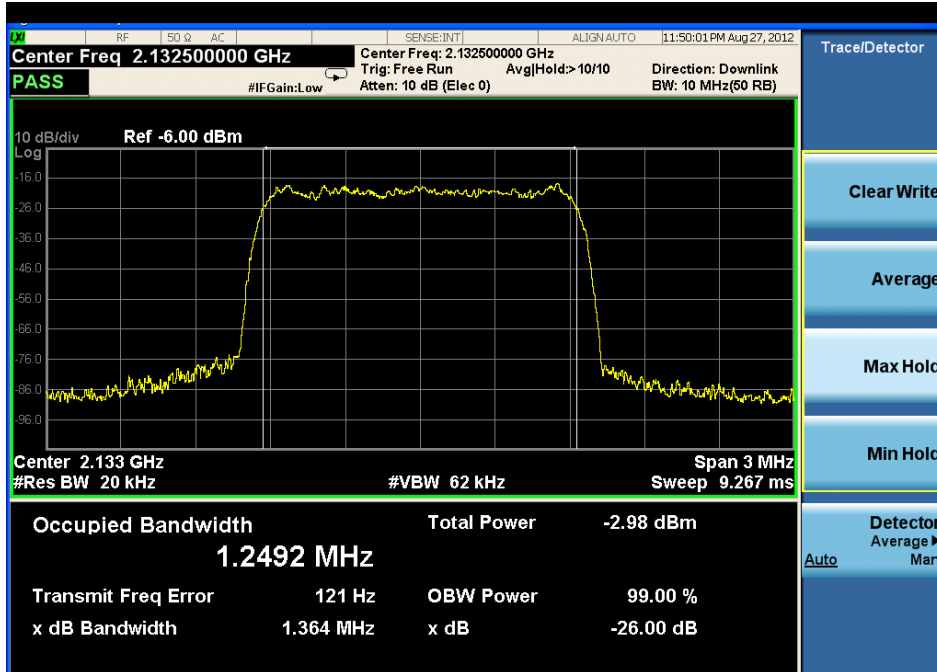

4.1.4 middle frequency-- Output

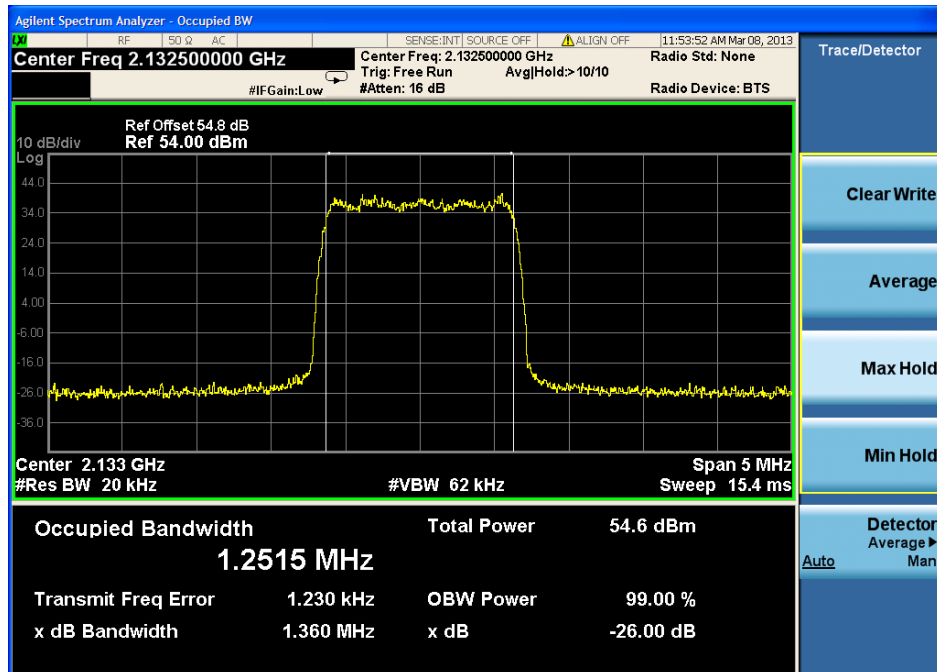



4.1.5 highest frequency—Input

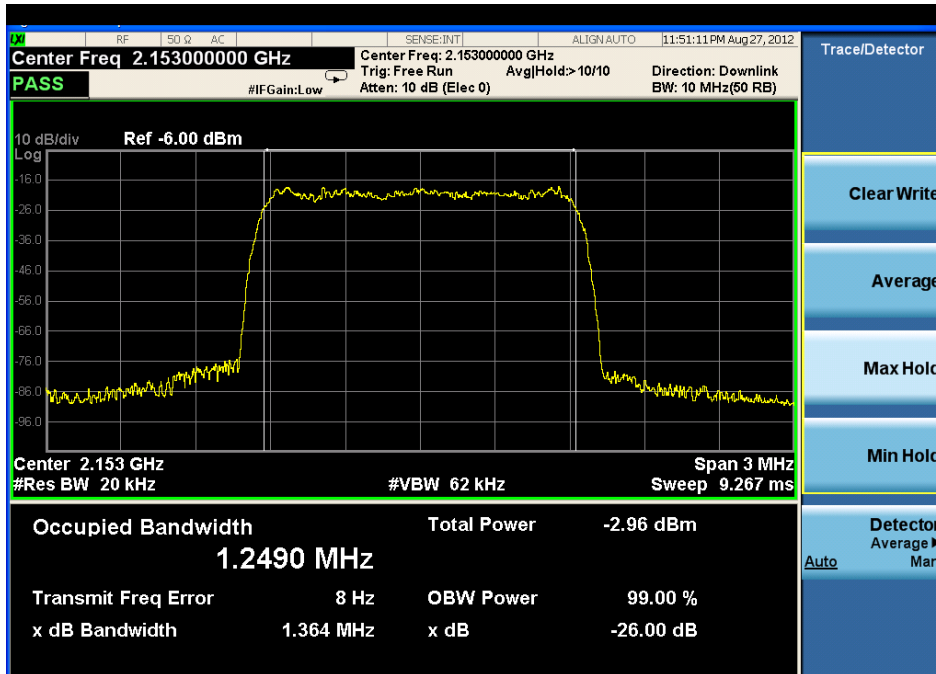

4.1.6 highest frequency--Output

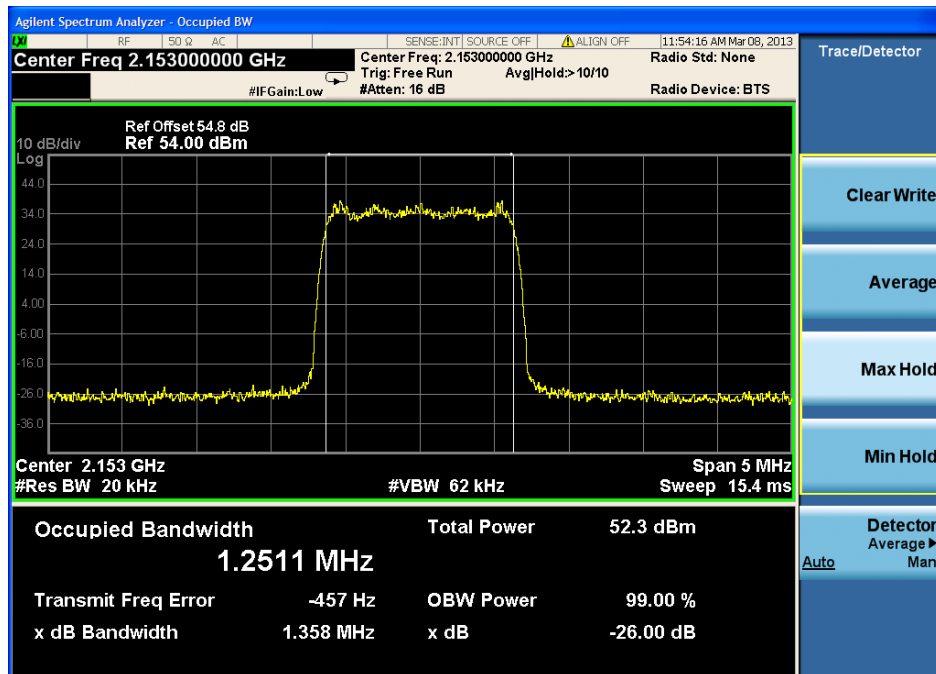



4.2 WCDMA Mode:

4.2.1 lowest frequency-- Input

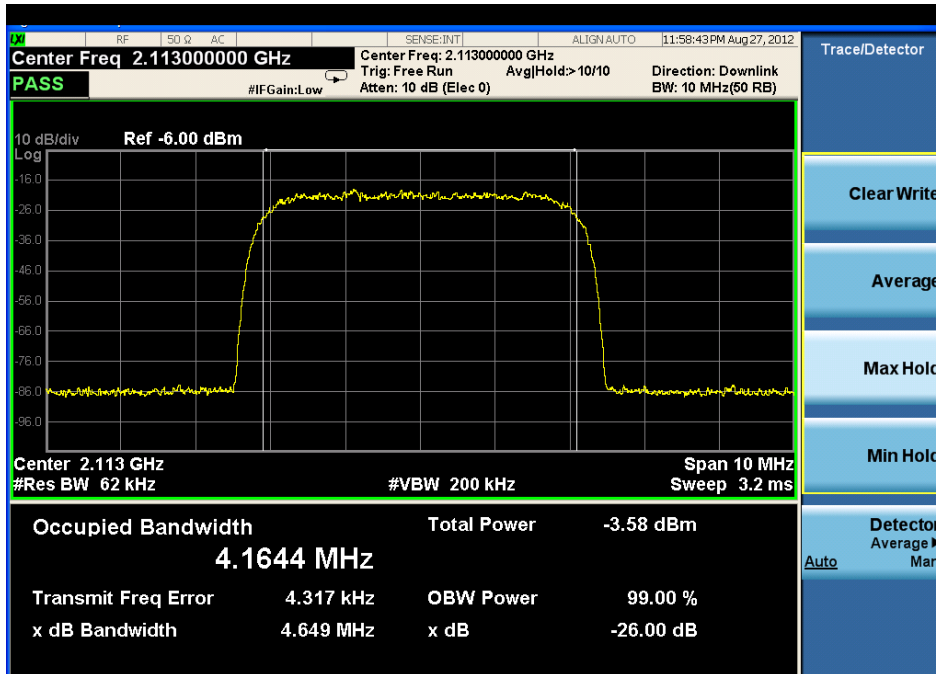

4.2.2 lowest frequency-- Output

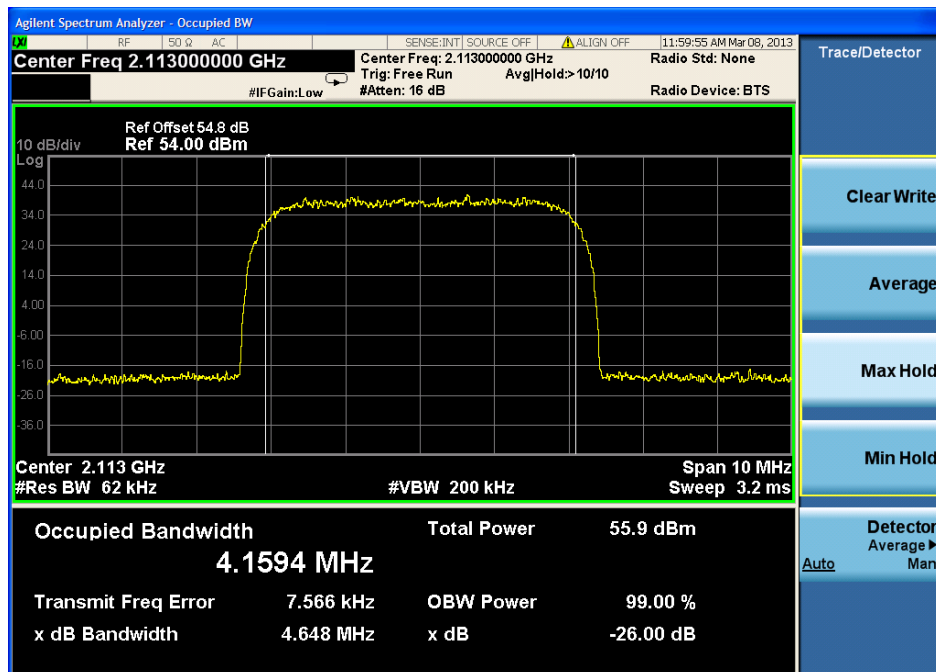



4.2.3 middle frequency-- Input

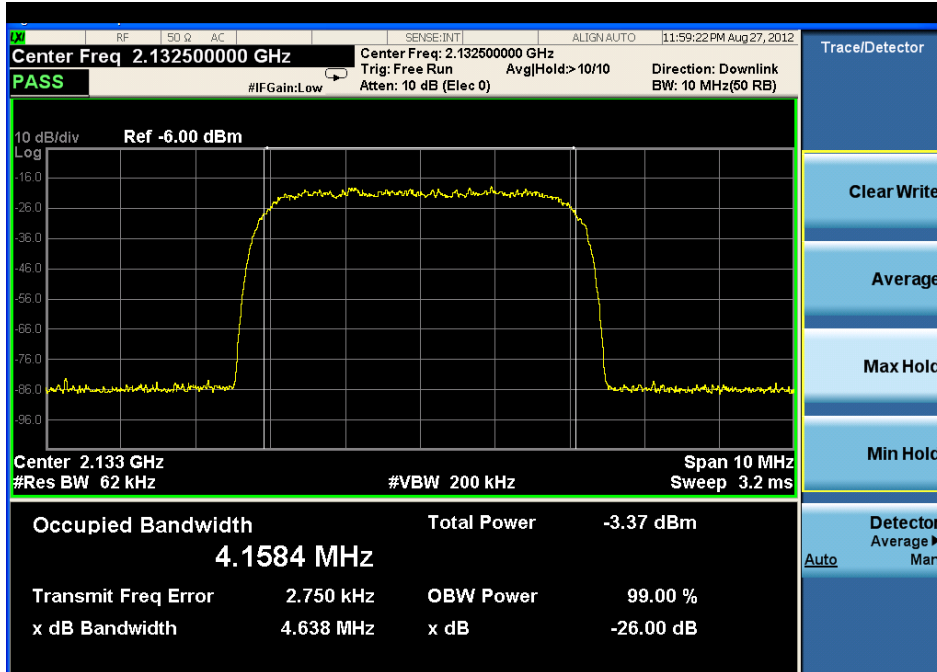

4.2.4 middle frequency-- Output

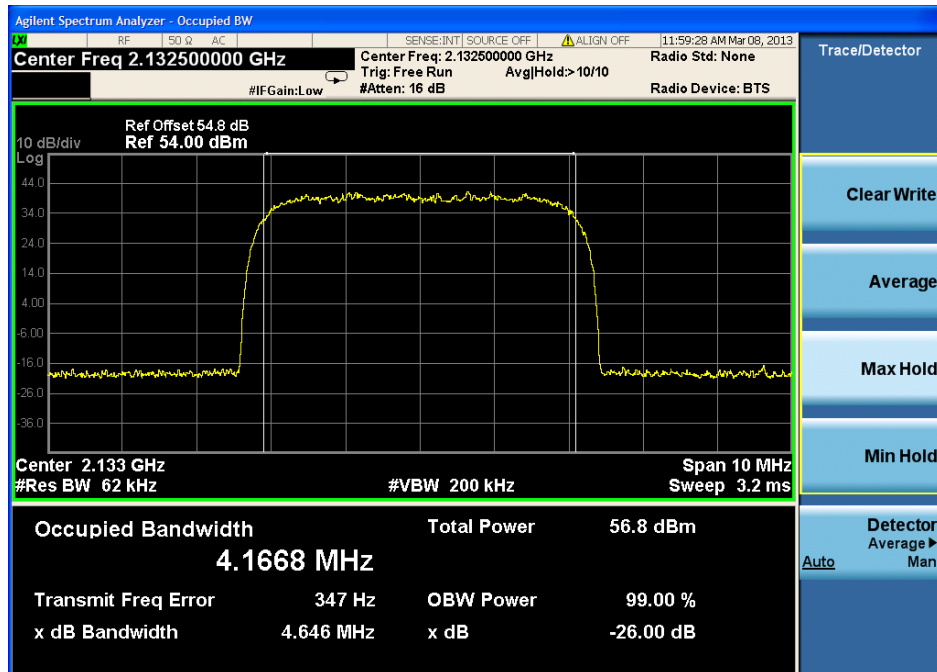



4.2.5 highest frequency—Input

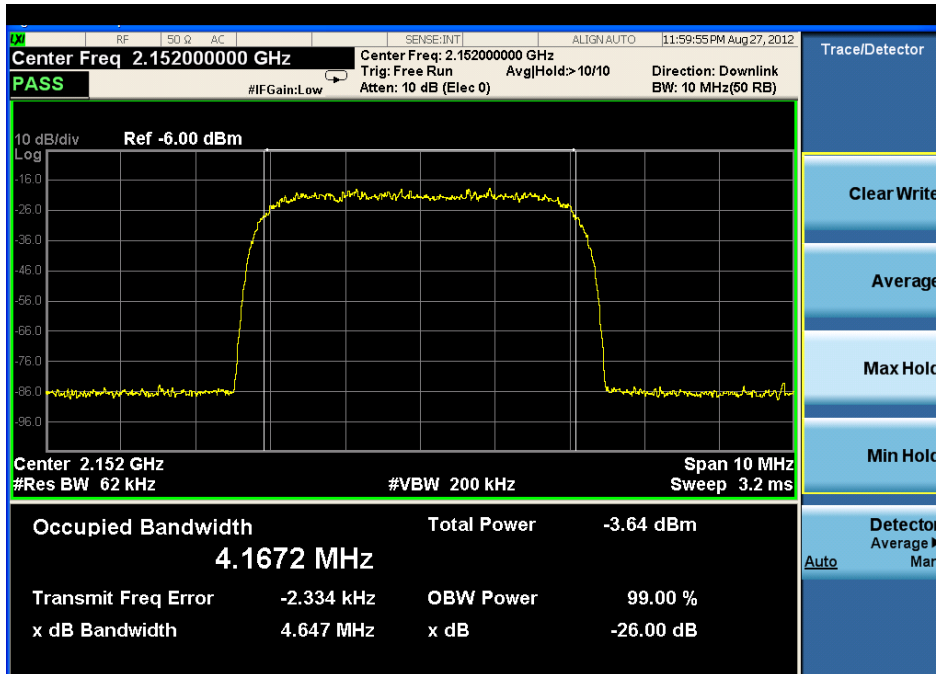

4.2.6 highest frequency--Output

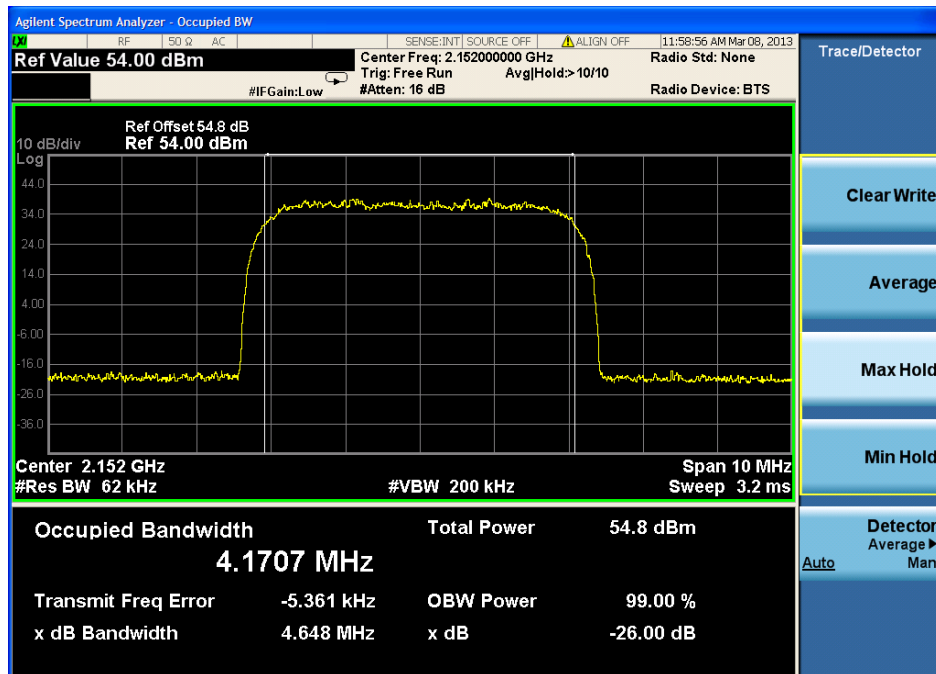



4.3 LTEMMode:

4.3.1 lowest frequency-- Input

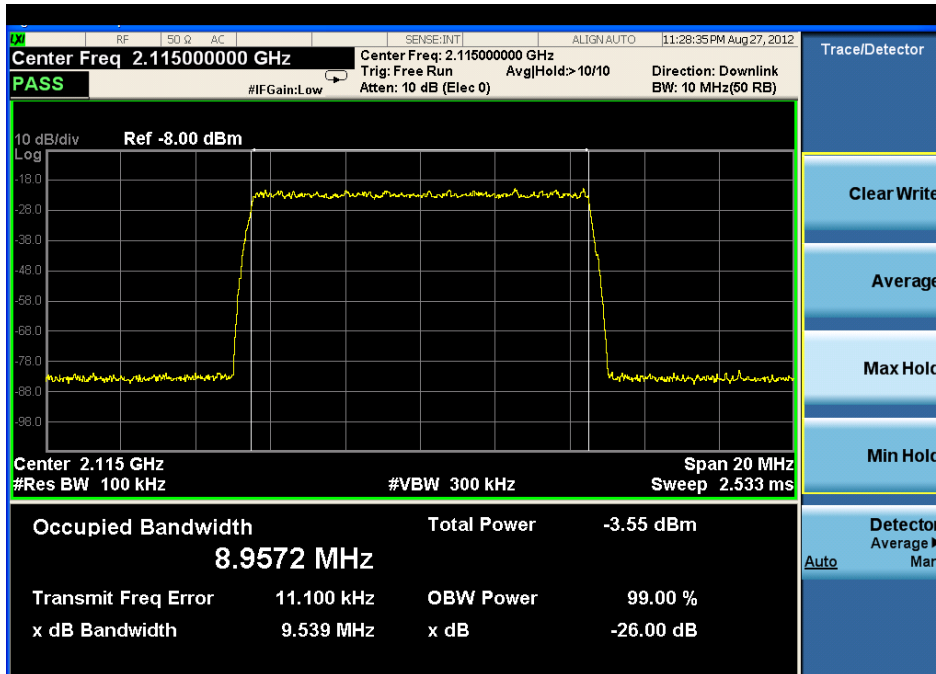

4.3.2 lowest frequency-- Output

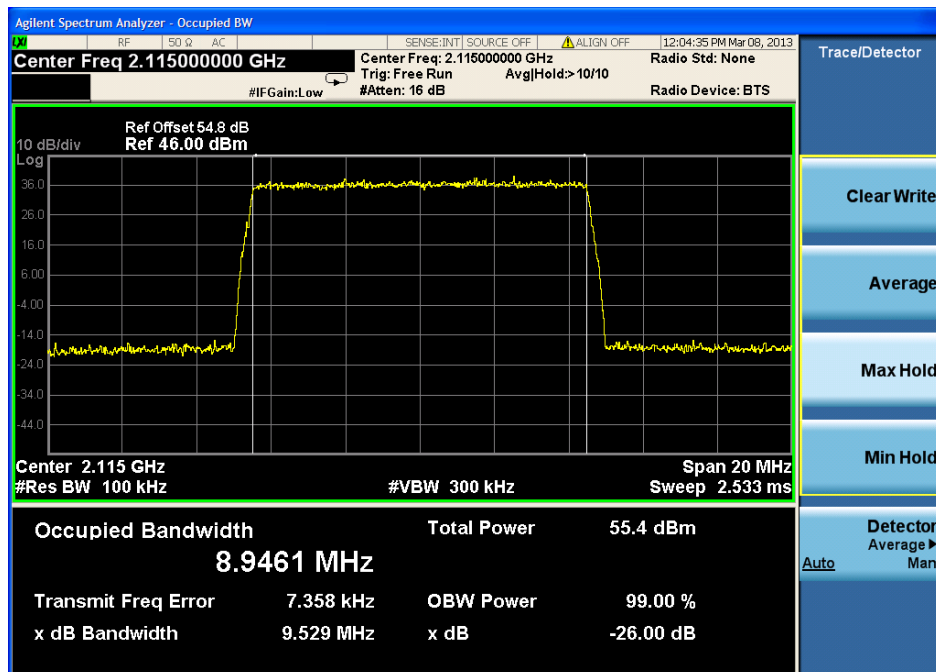



4.3.3 middle frequency-- Input

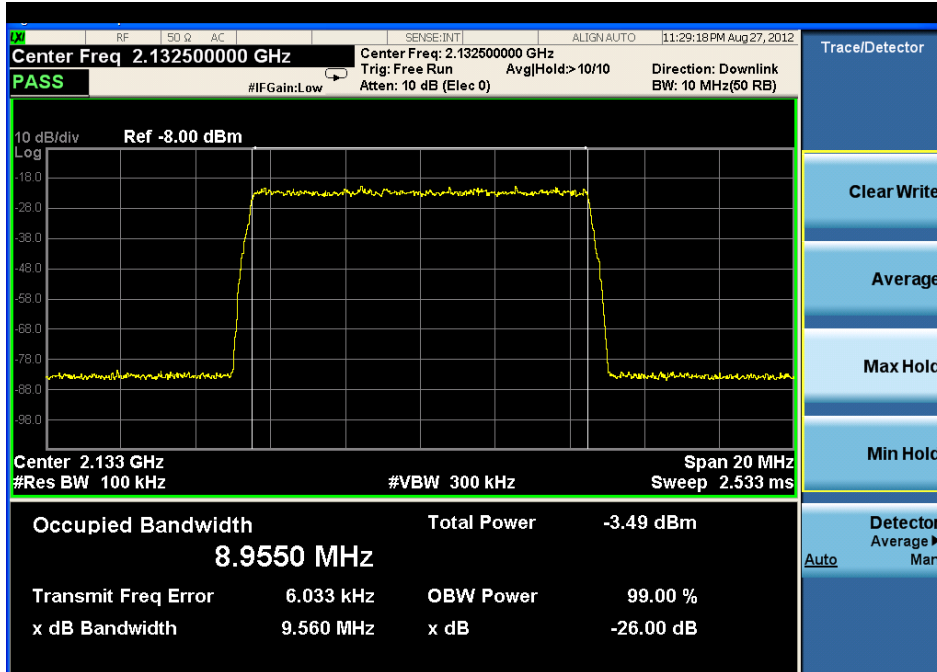

4.3.4 middle frequency-- Output

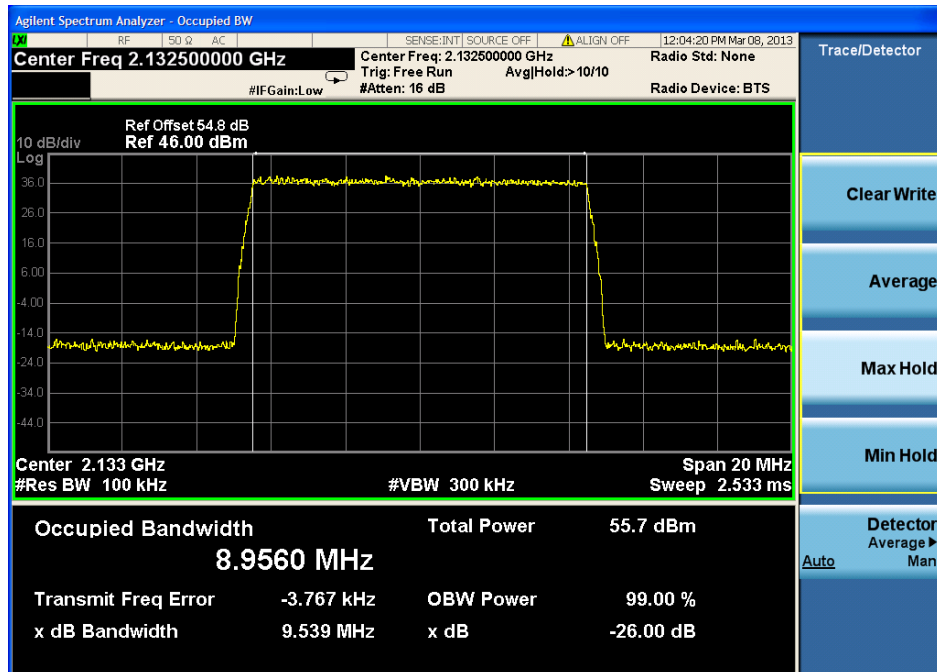



4.3.5 highest frequency—Input

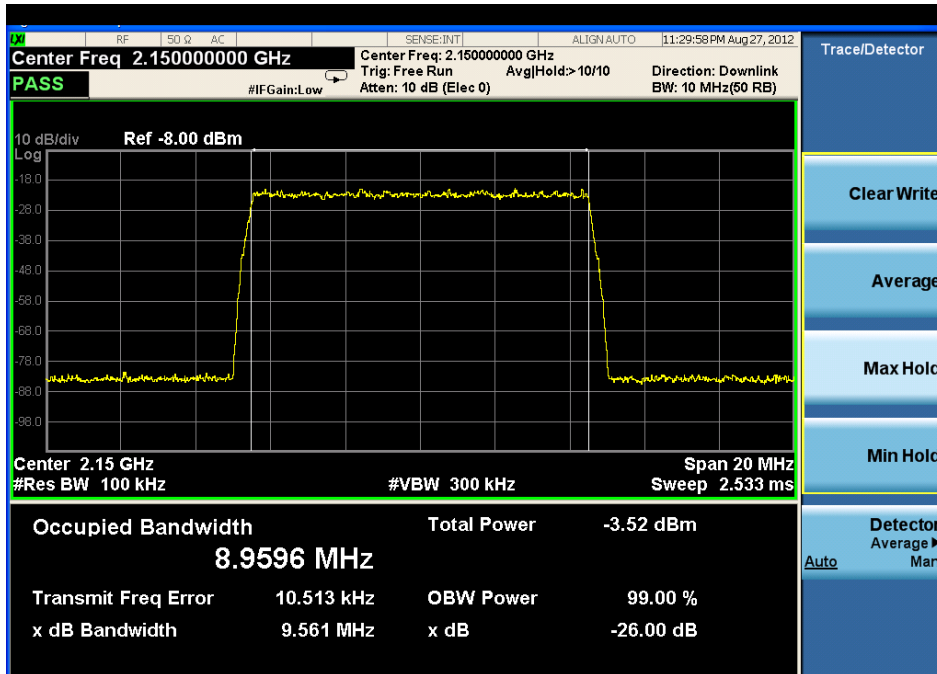

4.3.6 highest frequency--Output

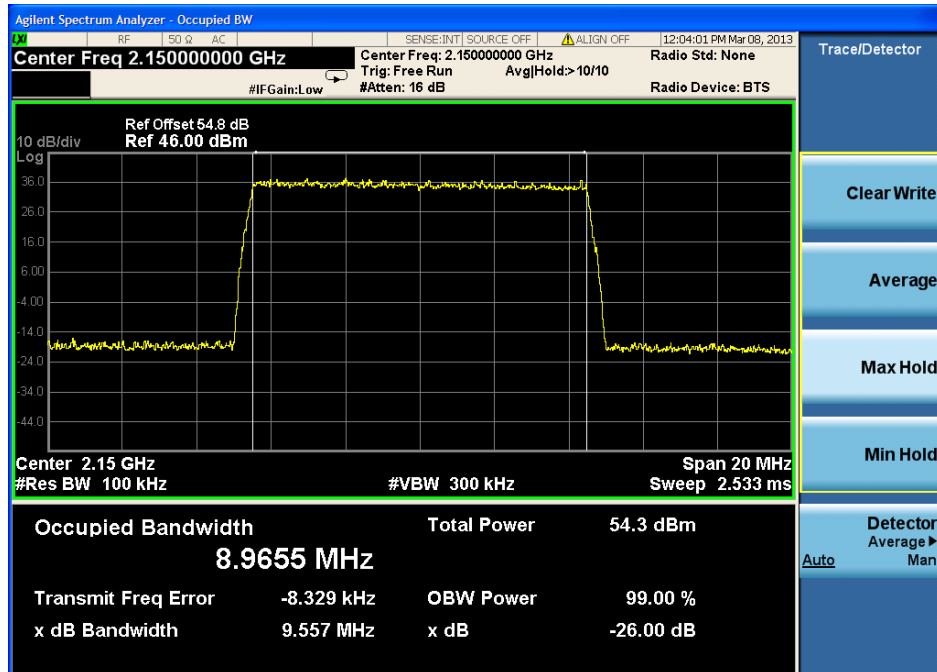

7.2.6 Out of Band Rejection

Test Date: 2013-03-17

Test Requirement: 2-11-04/EAB/RF

Test for rejection of out of band signals. Filter freq. response plots are acceptable.

Test Method: 2-11-04/EAB/RF

EUT Operation:

Status: Drive the EUT to maximum output power. .

Conditions: Normal conditions

Application: Cellular Band RF output ports

Test Configuration:

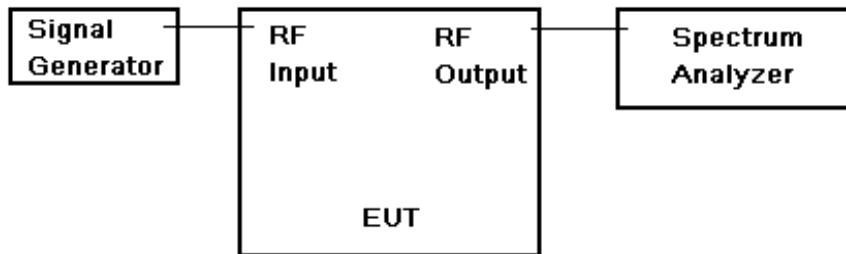

Fig.4. Out of Band rejection test configuration

Test Procedure:

1. Connect the equipment as illustrated;
 2. Test the background noise level with all the test facilities;
 3. Keep one transmitting path, all other connectors shall be connected by normal power or RF leads;
 4. Select the attenuator to avoid the test receiver or spectrum analyzer being destroyed;
 5. Keep the EUT continuously transmitting in max power;
 6. Signal generator sweep from the frequency more lower than the product frequency to the frequency more higher than it, find the product band filter characteristic;
- CW signal rather than typical signal is acceptable (for FM).
 - Multiple band filter will need test each other.



7.2.6.1 Measurement Record:

1. Test for Downlink: 728MHz to 757MHz

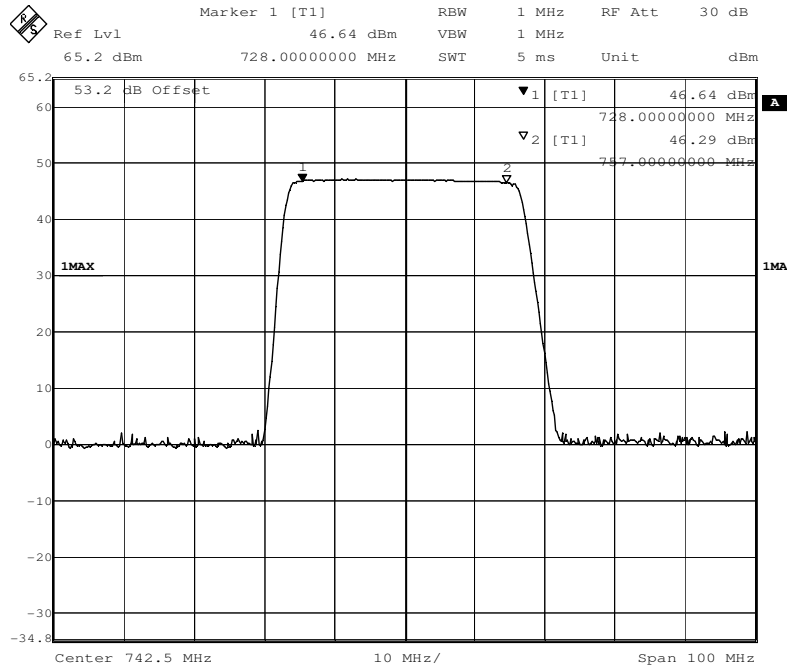

2. Test for Downlink: 869MHz to 894MHz

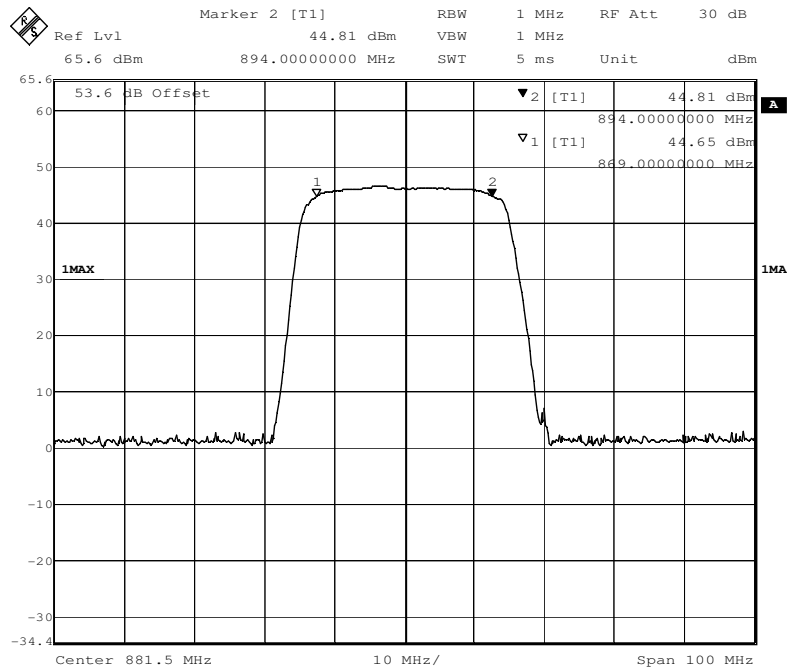



2. Test for Downlink: 1930MHz to 1995MHz

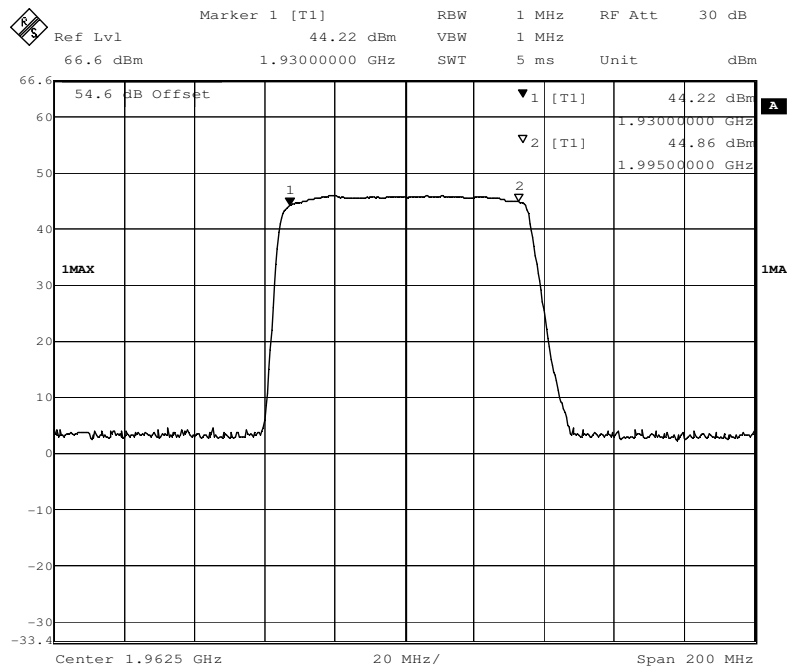

3. Test for Downlink: 2110MHz to 2155MHz

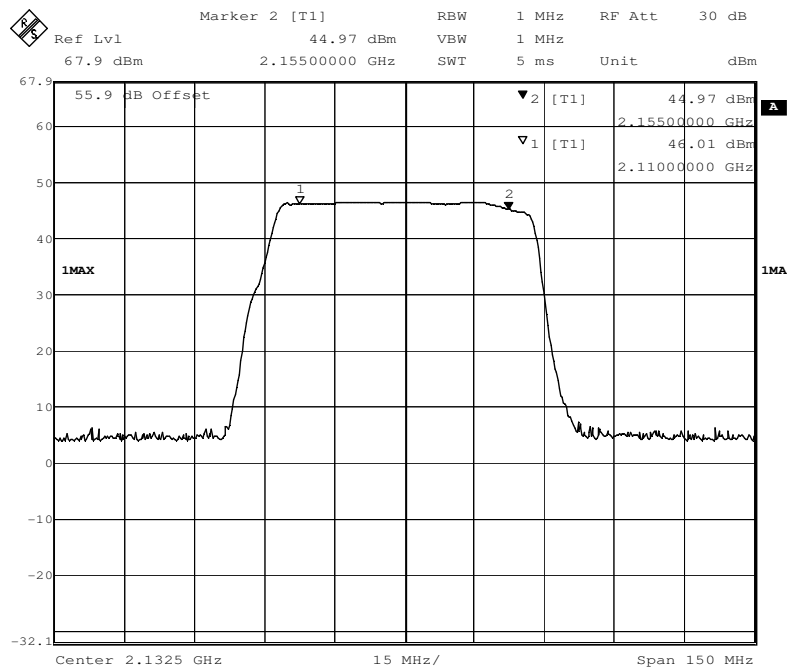



7.2.7 Frequency Stability

- Test Date: 2013-03-19
- Test Requirement: FCC part 22.355 & FCC part 24.235 & FCC part 27.54
The frequency stability shall be sufficient to ensure that the fundamental emissions stay within the authorized bands of operation.
- Test Method: FCC part 2.1055
- EUT Operation:
- Status: Drive the EUT to maximum output power.
 - Conditions: Temperature conditions, voltage conditions
 - Application: Cellular Band RF output ports
- Test Procedure:
1. Temperature conditions:
 - a) The RF output port of the EUT was connected to Frequency Meter;
 - b) Set the working Frequency in the middle channel;
 - c) record the 20°C and nominal voltage frequency value as reference point;
 - d) vary the temperature from -40°C to 50°C with step 10°C
 - e) when reach a temperature point, keep the temperature balance at least 1 hour to make the product working in this status;
 - f) read the frequency at the relative temperature.
 2. Voltage conditions:
 - a) record the 20°C and nominal voltage frequency value as reference point;
 - b) vary the voltage from -15% nominal voltage to +15% voltage;
 - c) read the frequency at the relative voltage.



7.2.7.1 Measurement Record:

1) Frequency Stability vs temperature:

1.1) Test for Downlink: 728~757MHz (middle channel 742.5MHz)

Temperature(°C)	Frequency(MHz)	Tolerance(ppm)
50	742.5000031	0.00107744
40	742.5000024	0.00013468
30	742.5000022	-0.00013468
20	742.5000023	Reference
10	742.5000025	0.00026936
0	742.5000026	0.00040404
-10	742.5000019	-0.000538721
-20	742.5000033	0.0013468
-30	742.5000030	0.000942761
-40	742.5000025	0.00026936

1.2) Test for Downlink: 869~894MHz (middle channel 881.5MHz)

Temperature(°C)	Frequency(MHz)	Tolerance(ppm)
50	881.5000038	0.000794101
40	881.5000036	0.000567215
30	881.5000034	0.000340329
20	881.5000031	Reference
10	881.5000028	-0.000340329
0	881.5000035	0.000453772
-10	881.5000041	0.00113443
-20	881.5000032	0.000113443
-30	881.5000027	-0.000453772
-40	881.5000038	0.000794101

1.3) Test for Downlink: 1930~1995MHz (middle channel 1962.5MHz)

Temperature(°C)	Frequency(MHz)	Tolerance(ppm)
50	1962.5000025	-0.000203822
40	1962.5000027	-0.000101911
30	1962.5000032	0.000152866
20	1962.5000029	Reference
10	1962.5000043	0.000713376
0	1962.5000034	0.000254777
-10	1962.5000031	0.000101911
-20	1962.5000033	0.000203822
-30	1962.5000034	0.000254777
-40	1962.5000035	0.000305732



1.4) Test for Downlink: 2110~2155MHz (middle channel 2132.5MHz)

Temperature(°C)	Frequency(MHz)	Tolerance(ppm)
50	2132.500034	0.0000937867
40	2132.500032	0.00000
30	2132.500039	0.000328253
20	2132.500032	Reference
10	2132.500029	-0.00014068
0	2132.500028	-0.000187573
-10	2132.500035	0.00014068
-20	2132.500037	0.000234467
-30	2132.500028	-0.000187573
-40	2132.500034	0.0000937867

2) Frequency Stability vs voltage:

2.1) For AC supplied:

2.1.1) Test for Downlink:728~757MHz (middle channel 742.5MHz)

Voltage(V AC)	Frequency(MHz)	Tolerance(ppm)
102 (120*0.85)	742.500024	0.00013468
120	742.500023	Reference
138 (120*1.15)	742.500029	0.000808081

2.1.2) Test for Downlink: 869~894MHz (middle channel 881.5MHz)

Voltage(V AC)	Frequency(MHz)	Tolerance(ppm)
102 (120*0.85)	881.500032	0.000113443
120	881.500031	Reference
138 (120*1.15)	881.500029	-0.000226886

2.1.3) Test for Downlink: 1930~1995MHz (middle channel 1962.5MHz)

Voltage(V AC)	Frequency(MHz)	Tolerance(ppm)
102 (120*0.85)	1962.500032	0.000152866
120	1962.500029	Reference
138 (120*1.15)	1962.500035	0.000305732

2.1.4) Test for Downlink: 2110~2155MHz (middle channel 2132.5MHz)

Voltage(V AC)	Frequency(MHz)	Tolerance(ppm)
102 (120*0.85)	2132.500033	0.0000468935
120	2132.500032	Reference
138 (120*1.15)	2132.500034	0.0000937867



2.2) For DC supplied:

2.2.1) Test for Downlink:728~757MHz (middle channel 742.5MHz)

Voltage(V DC)	Frequency(MHz)	Tolerance(ppm)
-40.8 (-48.0*0.85)	742.500025	0.00026936
-48.0	742.500023	Reference
-55.2 (-48.0*1.15)	742.500019	-0.000538721

2.2.2) Test for Downlink: 869~894MHz (middle channel 881.5MHz)

Voltage(V DC)	Frequency(MHz)	Tolerance(ppm)
-40.8 (-48.0*0.85)	881.500034	0.000340329
-48.0	881.500031	Reference
-55.2 (-48.0*1.15)	881.500028	-0.000340329

2.2.3) Test for Downlink: 1930~1995MHz (middle channel 1962.5MHz)

Voltage(V DC)	Frequency(MHz)	Tolerance(ppm)
-40.8 (-48.0*0.85)	1962.500027	-0.000101911
-48.0	1962.500029	Reference
-55.2 (-48.0*1.15)	1962.500043	0.000713376

2.2.4) Test for Downlink: 2110~2155MHz (middle channel 2132.5MHz)

Voltage(V DC)	Frequency(MHz)	Tolerance(ppm)
-40.8 (-48.0*0.85)	2132.500029	-0.00014068
-48.0	2132.500032	Reference
-55.2 (-48.0*1.15)	2132.500028	-0.000187573

--The End of Report--