

The Corning logo is a dark blue square with the word "CORNING" in white, uppercase, sans-serif font centered within it.

CORNING

Nano Power (E62-N2) Installation Manual

Everon™ 6200

GENERAL INFORMATION

The E62-N2RU is a low-power remote unit supporting cellular technologies on fiber optic cable using the CPRI protocol. The N2 is ideal for multioperator multiband deployments of cellular services in small-to-medium coverage areas. The N2 supports up to eight 20 dBm RF channels. The N2 converts an optical signal to RF and then transmits at the relevant 3GPP band and receives the analog RF signal, conditions it, and converts it back to optical for routing to the E2 or A2.

This document describes the installation procedure for the E62-N2 remote unit. This is NOT a CONSUMER device. It is designed for installation by FCC LICENSEES and QUALIFIED INSTALLERS. You MUST have an FCC LICENSE or express consent of an FCC License to operate this device. NOTE: Only authorized person can enter the area where the antenna is installed. And the person is fully aware of the potential for exposure and can exercise control over his or her exposure by leaving the area or by some other appropriate means. Awareness of the potential for RF exposure in a workplace or similar environment can be provided through specific training as part of a RF safety program.

CONTENT

1. GENERAL.....	4
WARNINGS	4
SITE CONSIDERATIONS.....	4
ENVIRONMENTAL.....	4
2. PREPARATION	5
UNPACKING AND INSPECTION	5
TOOLS.....	5
SYSTEM CABLING	5
E62-N2RU POWER SUPPLY	6
OPTICAL TRANSCEIVER MODULE.....	8
Single Port Bidirectional SFP Transceiver	8
Dual Port SFP Transceiver	9
3. INSTALLATION OF THE A2.....	10
MOUNT THE A2 IN THE RACK	10
A2 Accessories	10
Attach A2 Handle.....	11
Attach Sliding Rails and A2 to Rack	11
Fan Installation	12
Connect Power and Ground Cable to A2.....	13
MOUNT THE A2 ON THE WALL.....	14
Attach Handle to A2.....	14
Mount A2 to Wall	14
Connect Power and Ground Cable to A2.....	15
A2 MOUNTING DIMENSION SPACING.....	16
4. INSTALLATION OF THE EU-O	17
MOUNT THE EU-O IN THE RACK.....	17
EU-O Accessories	17
Attach EU-O Handle	18
Attach Sliding Rails and EU-O to Rack.....	18

Connect Power and Ground Cable to EU-O	19
MOUNT THE EU-O ON THE WALL	20
Attach Handle to EU-O	20
Mount EU-O to Wall.....	20
Connect Power and Ground Cable to EU-O	21
EU-O MOUNTING DIMENSION SPACING	22
5. INSTALLATION OF THE E62-N2RU	23
E62-N2RU CEILING INSTALLATION (WITH THE SUSPENDED CEILING).....	23
E62-N2RU Accessories	23
Assemble Bracket I&II	24
Place the Bracket.....	24
Assemble Bracket II.....	25
Buckle Up and Connect Wire.....	26
To Perform Maintenance on the E62-N2RU	27
E62-N2RU CEILING INSTALLATION (WITHOUT SUSPENDED CEILING)	28
Draw Circles for Plastic Expansion Nails	28
Assemble Mounting Bracket.....	29
Buckle Up and Connect Wire.....	29
To Perform Maintenance on the E62-N2RU	31
DUAL E62-N2RU CEILING INSTALLATION (WITH THE SUSPENDED CEILING)	32
Dual E62-N2RU Accessories.....	33
Assemble Bracket I & III	34
Place the Bracket I & VI.....	34
Assemble the Bracket II.....	35
Assemble the Bracket V	36
Buckle Up and Connect Wire.....	38
To Perform Maintenance on the E62-N2RU	40
Install Outer Case	41
E62-N2RU MOUNTING DIMENSION SPACING.....	42

1. GENERAL

The Everon™ 6200 system components are designed for maximum safety and reliability when they are installed, used, and maintained by trained and qualified technicians in accordance with the procedures and instructions contained in this manual. To ensure the safe operation of your system, always follow the safety and operational recommendations in this manual.

WARNINGS

Everon™ 6200 is not a consumer product. Please install and use Everon™ 6200 in accordance with the instructions. Before installing or modifying any Everon™ 6200 equipment, read and fully understand the entire instructions in this guide.

Only qualified personnel are authorized to install and maintain the Everon™ 6200 system. Changes or modifications to the Everon™ 6200 equipment not expressly approved by the manufacturer could void the product warranty and the user's authority to operate the equipment. Follow Electro Static Discharge precautions to avoid any damage to PCB, PSU, etc.

Keep equipment powered-off during installing or modifying.

Low path-loss cables connected to antennas are highly recommended.

SITE CONSIDERATIONS

Everon™ 6200 complies with FCC RF exposure limits for an uncontrolled environment.

The system delay should be taken into consideration when there are neighboring BTS sites with overlapping coverage.

Pick an ideal easy-to-reach location for installation convenience.

Verify that there is a minimum of a 50 cm radius of space around Everon™ 6200 equipment for the convenience of maintenance and on-site inspection.

In accordance with wireless service provider standards, it is not advised to use digital repeaters as a signal source for Corning solutions.

Install Master A2 close to the service area for monitor and debugging.

ENVIRONMENTAL

Humidity and temperature have adverse effects on the reliability of the Everon™ 6200 system. Therefore, it is highly recommended to install the equipment in locations with stable humidity, temperature, and ventilation.

The equipment has to operate within the following humidity level and temperature range:

Maximum humidity: 85%

Temperature range: -10°C to 40°C

2. PREPARATION

UNPACKING AND INSPECTION

Unpack and inspect the packages as follows:

1. Open the shipping packages carefully for each unit from the protective packing sponge.
2. Ensure that all equipment and accessories have been delivered.
3. Ensure that all equipment and accessories have no damage. If there is any damage, contact your Corning service agent.

TOOLS

Electric drill, crosshead screwdriver, side cutters, ladder, and other tools are needed for E62-N2RU installation which is not currently offered from Corning. Customers are to provide these tools themselves.



Philips
Screwdriver M6
and M3



Drilling Machine



Pen



Allen Wrench T5



Combination
Spanner 17mm

SYSTEM CABLING

Here are the key features of Everon™ 6200 E62-N2RU system cabling

- Master A2 connects EU-O using single-port bidirectional SFP module.
- EU-O connects E62-N2RU using dual-ports SFP module.
- See Section Optical Transceiver Module for SFP module connection.
- E62-N2RU is a DC power supply equipment.
- Hybrid cable is recommend for E62-N2RU cabling. The following figure shows how hybrid cable connects.

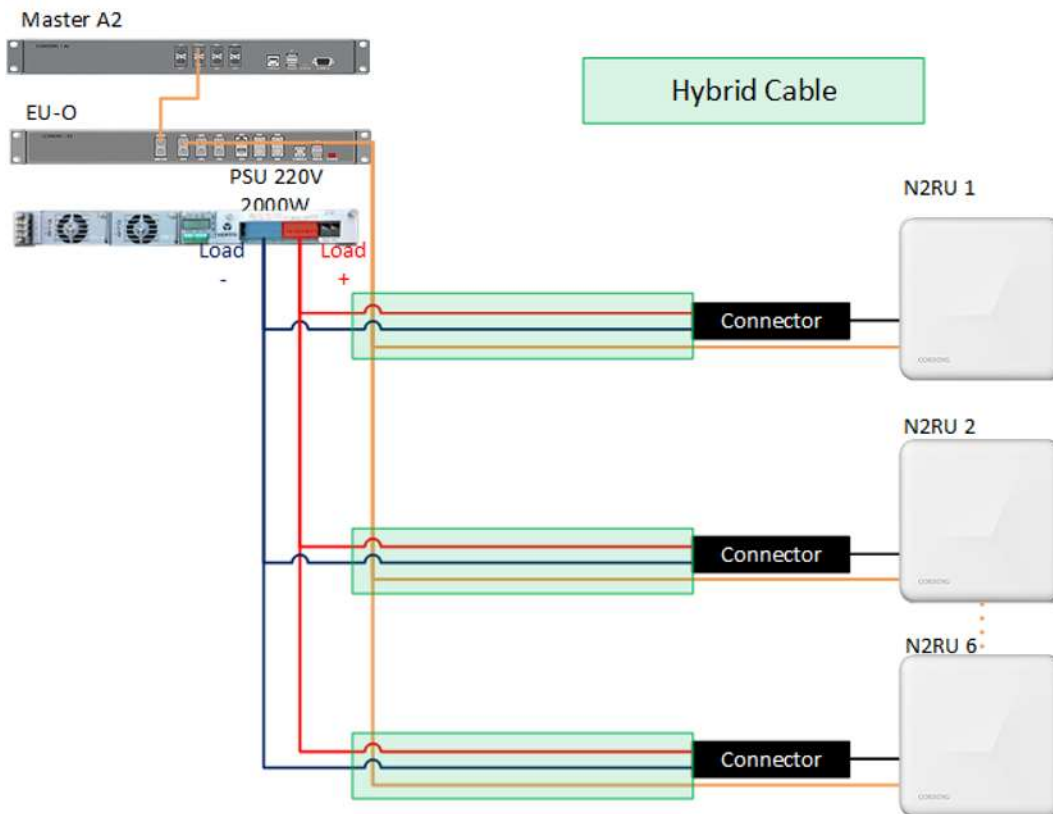

Figure 1. Hybrid Cable Configuration

E62-N2RU POWER SUPPLY

The E62-N2RU needs a DC power supply at the remote unit location. A power supply unit (PSU) can be used to supply this DC power.

These are the specifications for DC power cables for use with the 56V PSU:

$P_n = 78 \text{ W}$	Power consumption of E62-N2RU	$P = I \cdot V_{in} = 142.92 \text{ W}$	Power required from PSU
$V_{in} = 56 \text{ V}$	Voltage of E62-N2 PSU	$R_w = (V_{in} - V_{out}) / I = 6.90$	$R_w =$ resistance of the wire
$V_{out} = 48 \cdot (1 - 20\%) = 38.4 \text{ V}$	Minimum input voltage of E62-N2RU	$R_w = R_d \cdot D$	$D =$ distance of the wire (total length of supply + return cable) $R_d =$ resistance per meter of the wire
$I = P_n / V_{out} = 2.552 \text{ A}$	$I =$ Injected current		

Cable type	Voltage Drop	$D = R_w / R_d$ (meters)	Max Fiber Distance (meters)
	ohms/meter	2x distance between PSU and N2RU (there and back)	Distance between PSU and N2RU
12 AWG	0.00557	1238	619
14 AWG	0.00928	743	372
16 AWG	0.0147	469	235

Power	Max Distance (meters) @ AWG		
	12	14	16
78 W	778	467	295
88 W	689	414	261
96 W	632	379	239
98 W	619	372	235

Note: The maximum power consumption is 98 W when N2 has 8 PA modules operating at maximum output power.

Class 2 Installation for North America area (maximum input power is 100 W):

$P_n = 78 \text{ W}$	Power consumption of N2RU	$P_w = 22 \text{ W}$	If N2 consumes 78 W then 22 W is dissipated in the wire (P_w)
$P_{in} = V_{in} \cdot I_{in} = 100 \text{ W}$	$P_{in} = 100 \text{ W}$ max for class 2 installation	$R_w = P_w / I_w^2 = 6.8992$	$R_w =$ resistance of the wire
$V_{in} = 56 \text{ V}$	Voltage of N2 PSU	$R_w = R_d \cdot D$	$D =$ distance of the wire (total length of supply + return cable) $R_d =$ resistance per meter of the wire
$I_{in} = P_{in} / V_{in} = 1.786$	$I_{in} =$ Max injected current to not exceed 100 W		

Cable type	Voltage Drop	$D = R_w / R_d$ (meters)		Max Fiber Distance (meters)
	ohms/meter	2x distance between PSU and N2RU (there and back)		Distance between PSU and N2RU
12 AWG	0.00557	1239		619
14 AWG	0.00928	743		372
16 AWG	0.0147	469		235

Power	Max Distance (meters) @ AWG		
	12	14	16
78 W	619	372	235
88 W	338	203	128
94 W	169	101	64
98 W	56	34	21

The cable connector diagram is below

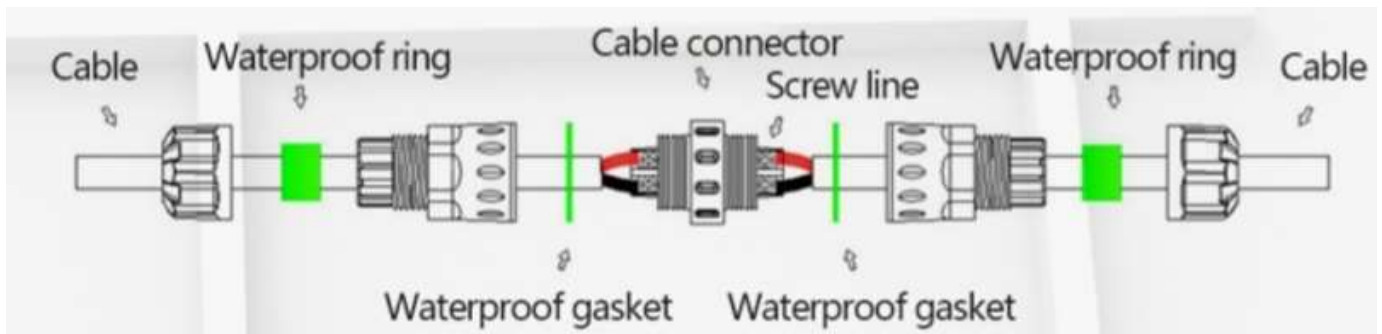
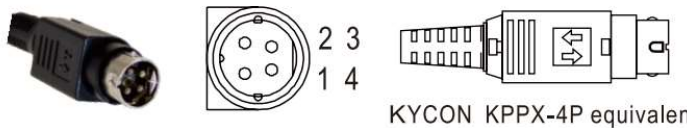
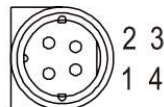
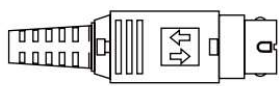
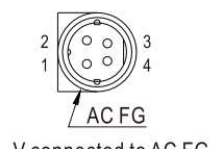

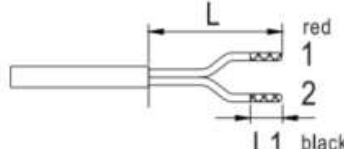

Figure 2. Cable Connector Diagram

Note: The cable connector is available for 12 AWG, 14 AWG, and 16 AWG. However, the waterproof ring must be removed when using 12 AWG and 14 AWG

The power connector is stripped and tinned as below.

R7B		Pin Assignment												
		 KYCON KPPX-4P equivalent	 -V connected to AC FG	<table border="1"> <thead> <tr> <th>PIN NO.</th> <th>OUTPUT</th> </tr> </thead> <tbody> <tr> <td>1</td> <td>+Vo</td> </tr> <tr> <td>2</td> <td>-Vo</td> </tr> <tr> <td>3</td> <td>-Vo</td> </tr> <tr> <td>4</td> <td>+Vo</td> </tr> </tbody> </table>	PIN NO.	OUTPUT	1	+Vo	2	-Vo	3	-Vo	4	+Vo
			PIN NO.	OUTPUT										
			1	+Vo										
			2	-Vo										
			3	-Vo										
4	+Vo													
2	+Vo													
3	-Vo													
4	-Vo													
1	+Vo													

Stripped and tinned leads	Type No.	Pin Assignment	
		PIN No.	Output
  Length of Land L1 by request (MW's standard length, L: <u>25</u> mm, L1: <u>5</u> mm)	by customer	1	+Vo
		2	-Vo

OPTICAL TRANSCEIVER MODULE

Single-Port Bidirectional SFP Transceiver

The Figure below shows a pair of single-port Bidirectional SFP transceivers. For device's optical connection, the transceivers of two sides must be paired -- the wavelength of one side is 1271 nm, and the wavelength of another side is 1331 nm. Otherwise, it will fail the connection. All lower-level devices under this port won't be working in the system.

All the optical ports of all type devices have triangle LED indicators pointing to each port, which represent the synchronization status of the upper and lower optical modules. The indicator turns to green when optical modules are plugged into ports and synchronized. When the connection is down, or there is no optical module in the port, the indicator remains red.



Figure 3. Single Port SFP Module

 The single-port SFP modules have to be used in pairs.

Dual-Port SFP Transceiver

The optical connector unit includes an optical module and optical fiber. The Figure below shows that when using a dual-port SFP module, the optical transmitter and optical receiver should correspond to each other. In other words, the optical transmitter of optical module A should correspond to the optical receiver of optical module B, and the receiver of A should correspond to the transmitter of B. The optical receiver and transmitter terminals of the optical module can be determined by the triangular mark on the optical module. The triangular mark in the yellow box and the red and blue lines indicate the optical fiber connections.

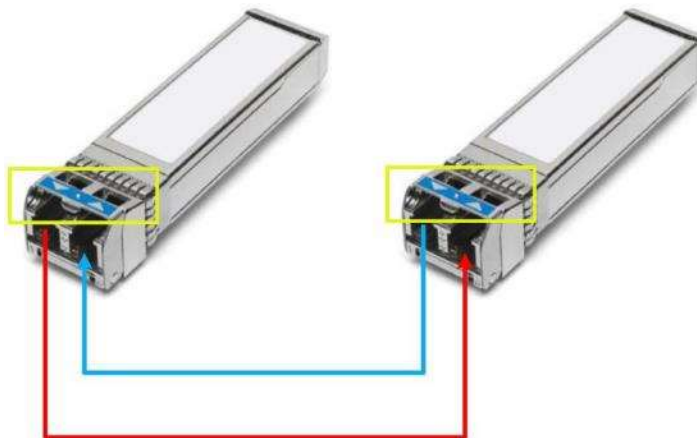

Figure 4. Dual-Port SFP Module

3. INSTALLATION OF THE A2

MOUNT THE A2 IN THE RACK

A2 Accessories







① Screw M6*16	② Screw M3*6
	
③ Suspension Loop	④ AC Power Lead 2.5m
	
⑤ CAT-5 Cable 1.5m	⑥ Ground Wire 2m
	

Figure 5. A2 Accessories

Note: The ground wire of A2 is 12 AWG and 2 meter in Accessories package.

Attach A2 Handle

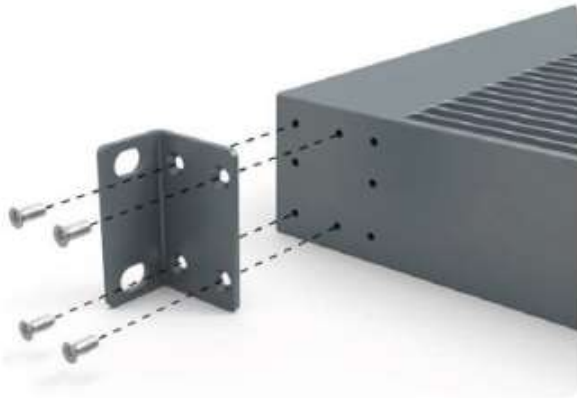

Figure 6. Attaching a 19-in Mounting Bracket

1. Attach the 19-inch mounting brackets at the front of the A2, using 4 screws M3×16 per bracket and the Phillips screwdriver. Observe the orientation of the brackets.

Attach Sliding Rails and A2 to Rack

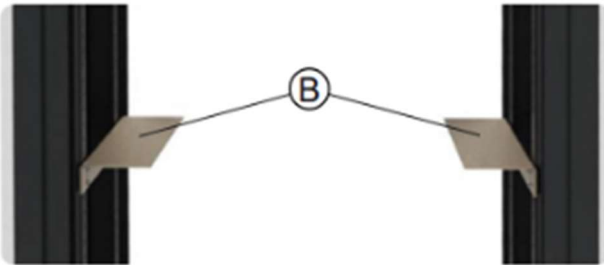

Figure 7. Attached Sliding Rails

1. Attach the sliding rails (B) to the rack.

Note: The sliding rails are not included in the delivery.



Figure 8. Place A2 in Rack

2. Place the A2 in the rack.

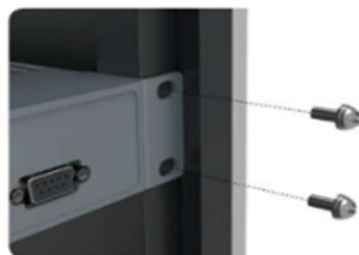

Figure 9. Fix A2 with Screws

3. Secure the A2 using 2 screws M6×16 on both sides and the Phillips screwdriver.



Figure 10. Separation of Adjacent A2

For rack installation, it is highly recommended to use a fan tray in the middle of 2 adjacent A2 units for cooling.

Note: It will reduce service life if A2 unit is continuously working in a high-temperature environment.

Fan Installation

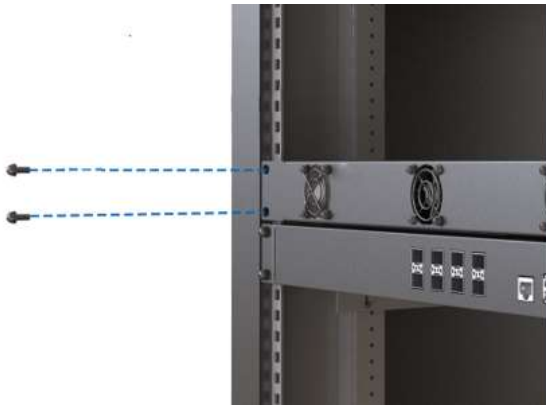

Figure 11. Fix Fan with Screws

1. Secure the fan using 2 screws M6×16 on both sides and the Phillips screwdriver.



Figure 12. Plug AC Power Lead

2. Plug AC power lead.



Figure 13. Fan DC Version



Figure 14. DC Power Cable

Fan DC version has power cable embedded in chassis.

Note: Red is for positive; Blue is for negative.

Connect Power and Ground Cable to A2



Figure 15. Connect Power Cable at Rear Side



Figure 16. Connect Ground Cable at Rear Side

1. Connect and lock the power cable at the rear of the A2.
2. Connect and screw the ground wire at the rear of the A2.

MOUNT THE A2 ON THE WALL

Attach Handle to A2

Attach the 19-inch mounting brackets to the rear of the A2 unit, using 4 screws M3×16 per bracket and the Phillips screwdriver. Observe the orientation of the brackets shown in Figure 17.

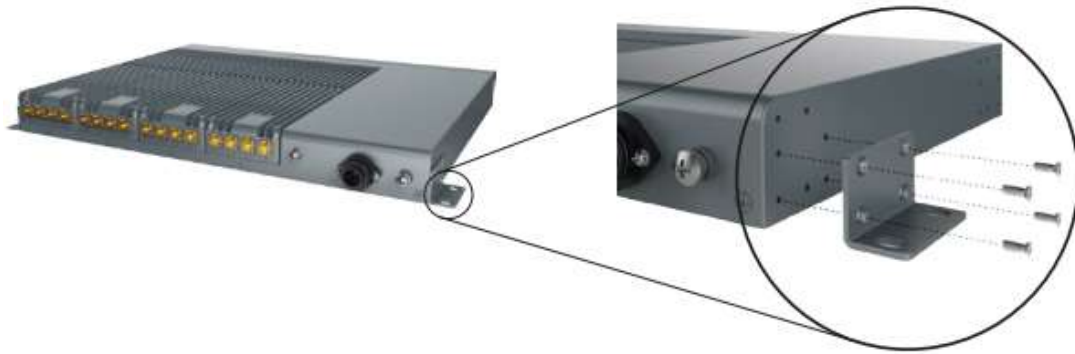

Figure 17. Attaching a 19-in Mounting Bracket

Mount A2 to Wall

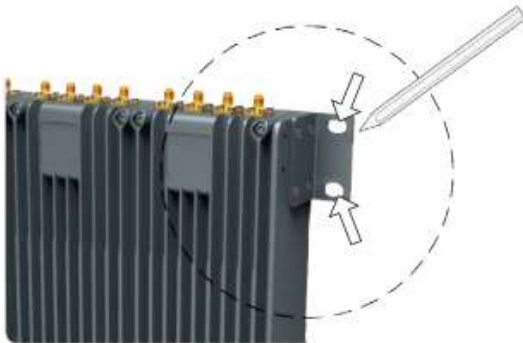

Figure 18. Marking the position of mounting holes

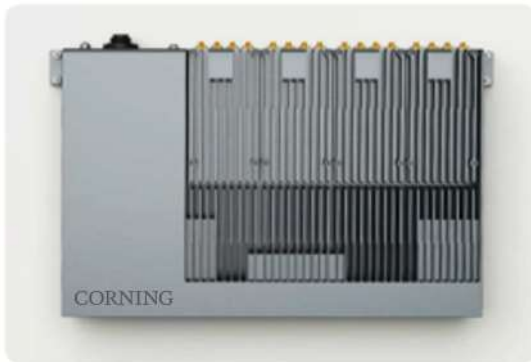

Figure 19. Mounting completed

1. Hold the A2 to the installation location and mark the position of the 4 mounting holes in the mounting brackets.
2. Drill the mounting holes according to the chosen mounting accessories.
3. Attach the dowels, expansion screws, and fasten the A2 to the wall.

Connect Power and Ground Cable to A2



Figure 20. Connect power cable at the rear of the unit

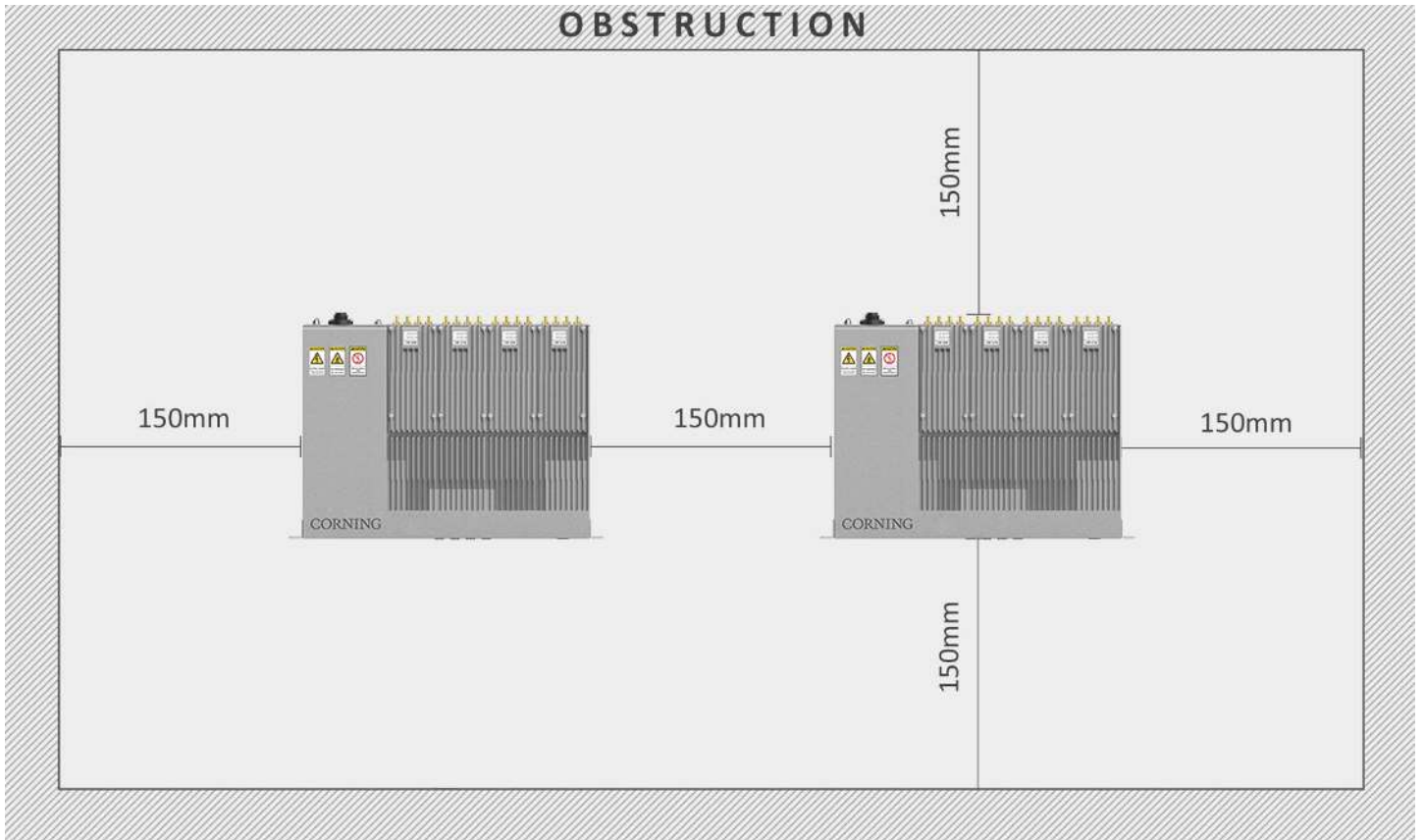

Figure 21. Connect ground cable at the rear of the unit

1. Connect and lock the power cable at the rear of the A2.

1. Connect and screw the ground wire at the rear of the A2.

A2 MOUNTING DIMENSION SPACING



4. INSTALLATION OF THE EU-O

Installing the EU-O is virtually the same as installing the A2. Please refer to the steps described in the A2 installation for the EU-O.

MOUNT THE EU-O IN THE RACK

EU-O Accessories







	① Screw M6×16	② Screw M3×6
		
③ Suspension Loop	④ AC Power Lead 2.5m	
		
⑤ Optical Transceiver	⑥ Ground Wire 2m	
		

Figure 22. EU-O Accessories

Note: The ground wire of EU-O is 12 AWG and 2 meter in Accessories package.

Attach EU-O Handle

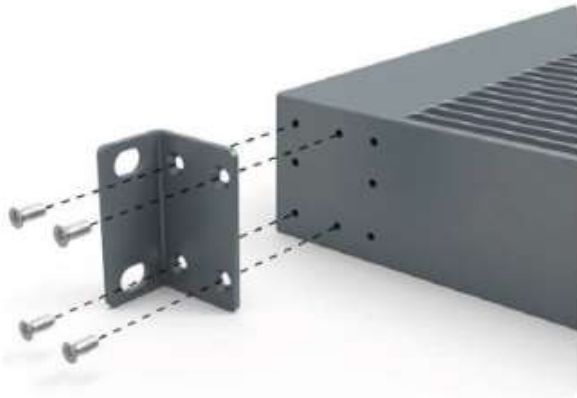

Figure 23. Attaching a 19-in Mounting Bracket

1. Attach the 19-inch mounting brackets at the front of the EU-O, using 4 screws M3×16 per bracket and the Phillips screwdriver. Observe the orientation of the brackets.

Attach Sliding Rails and EU-O to Rack



Figure 24. Attached Sliding Rails

1. Attach the sliding rails (B) to the rack.

Note: The sliding rails are not included in the delivery.



Figure 25. Place EU-O in Rack

2. Place the EU-O in the rack.

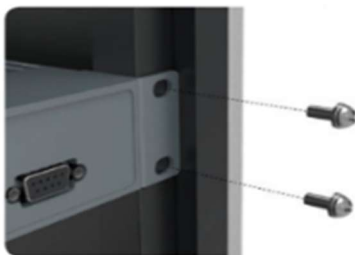

Figure 26. Fix EU-O with Screws

3. Secure the EU-O using 2 screws M6×16 on both sides and the Phillips screwdriver.



Figure 27. Separation of Adjacent EU-O

For rack installation, it is highly recommended to use a fan tray in the middle of 2 adjacent EU-O for cooling.

Note: It will reduce service life if EU-O is continuously working in a high-temperature environment.

Connect Power and Ground Cable to EU-O



Figure 28. Connect Power Cable at Rear Side



Figure 29. Connect Ground Cable at Rear Side

1. Connect and lock the power cable at the rear of the EU-O.
2. Connect and screw the ground wire at the rear of the EU-O.

MOUNT THE EU-O ON THE WALL

Attach Handle to EU-O

Attach the 19-inch mounting brackets to the rear of the EU-O, using 4 screws M3×16 per bracket and the Phillips screwdriver. Observe the orientation of the brackets.



Figure 30. Attaching a 19-in Mounting Bracket

Mount EU-O to Wall

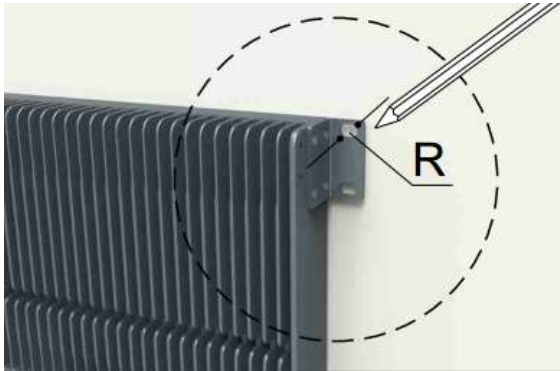

Figure 31. Marking the Position of Mounting Holes



Figure 32. Mounting Completed

1. Hold the EU-O to the installation location and mark the position of the 4 mounting holes in the mounting brackets; see arrows in Figure 18.
2. Drill the mounting holes according to the chosen mounting accessories.
1. Attach the dowels, expansion screws, and fasten the EU-O to the wall.

Connect Power and Ground Cable to EU-O



Figure 33. Connect power cable at the rear of the unit



Figure 34. Connect ground cable at the rear of the unit

1. Connect and lock the power cable at the rear of the EU-O
2. Connect and screw the ground wire at the rear of the EU-O

EU-O MOUNTING DIMENSION SPACING

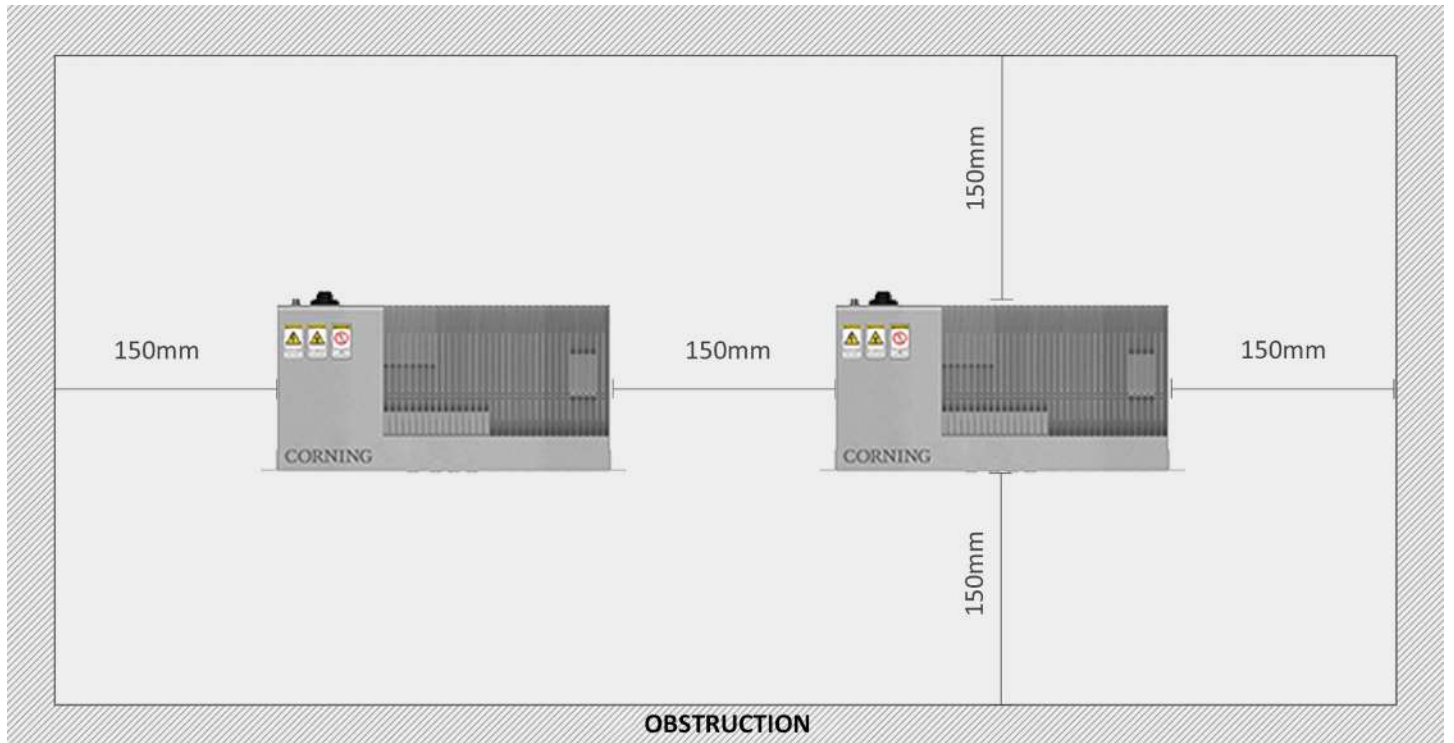

5. INSTALLATION OF THE E62-N2RU

E62-N2RU CEILING INSTALLATION (WITH THE SUSPENDED CEILING)

E62-N2RU Accessories













① Screw M3×6	② Screw M6×70	③ Flat Washer M6
		
④ Spring Washer M6	⑤ DC Power Lead 2m	⑥ Waterproof Connector
		
⑦ Optical Transceiver FTLX1370W4BTL	⑧ Nylon Cable Ties	⑨ Plastic Expansion Nail
		
⑩ Screw ST6.3×50	⑪ Mounting Bracket I	
		
⑫ Mounting Bracket II	⑬ Mounting Bracket IV	
		

Figure 35. E62-N2 Accessories

Assemble Bracket I & II



Figure 36. Assembling Bracket I & IV



Figure 37. Attaching Cable Tie to Mounting Bracket

1. Assemble Mounting Bracket I & IV with 6 x M3 x 6 screws.
2. Attach Nylon Cable Tie to the Bracket I & IV combination.

Place the Bracket

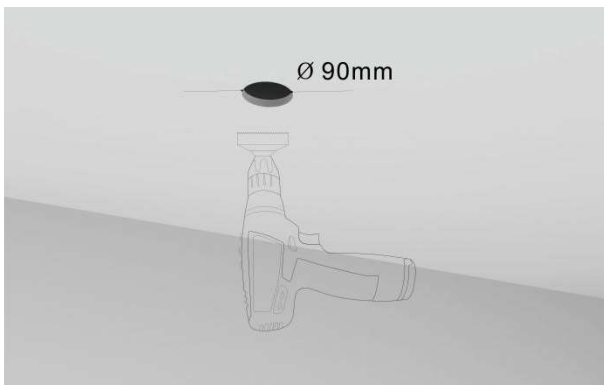

Figure 38. Drilling a Hole

1. Drill a hole with a diameter of 90 mm for putting Mounting Bracket I & IV.

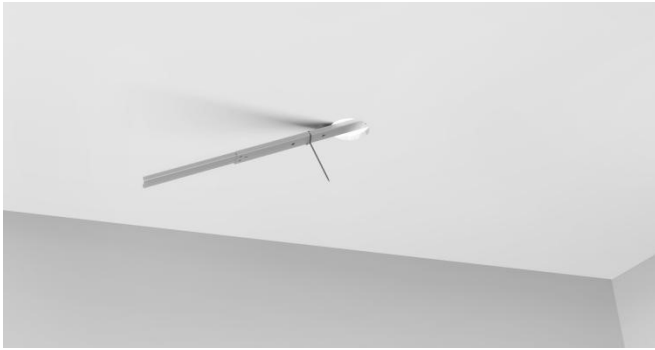

Figure 39. Placing Bracket I & IV



Figure 40. Placing Bracket 2

2. Place the Mounting Bracket I & IV onto the surface where the E62-N2RU will be attached to the reverse of the Ceiling Tiles.

3. Ensure the nylon tie hangs down through the hole.

Assemble Bracket II



Figure 41. Assemble Bracket II

1. Attach Mounting Bracket II to Mounting Bracket I using 2 x M6 x 70 screws, Flat Washer M6, and Spring Washer M6.

Note: Paired Mounting Bracket III is already assembled into E62-N2RU in factory

Buckle Up and Connect Wire

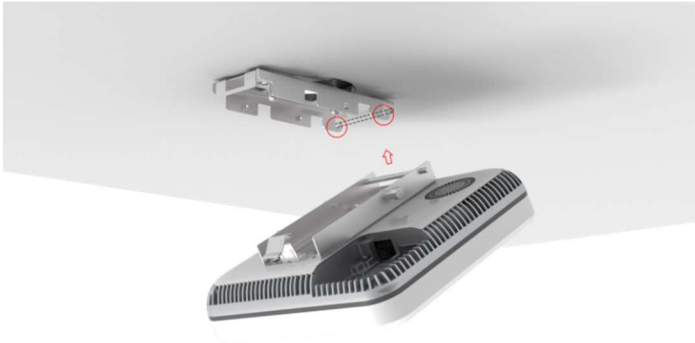

Figure 42. Connecting Bar over Hooks on Bracket II

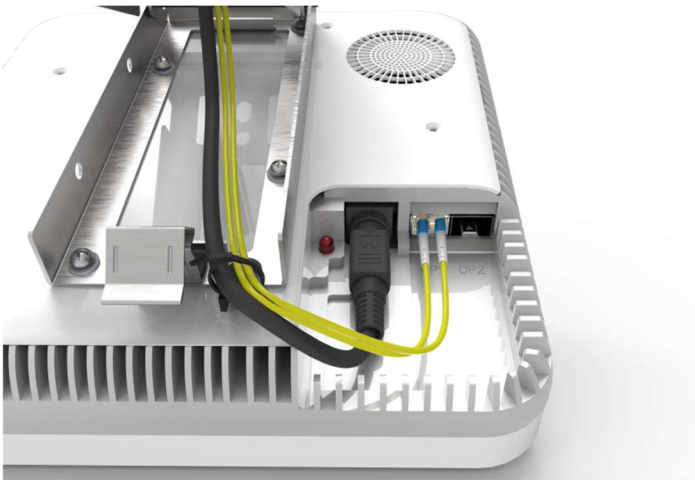

Figure 43. Wire Connection Diagram

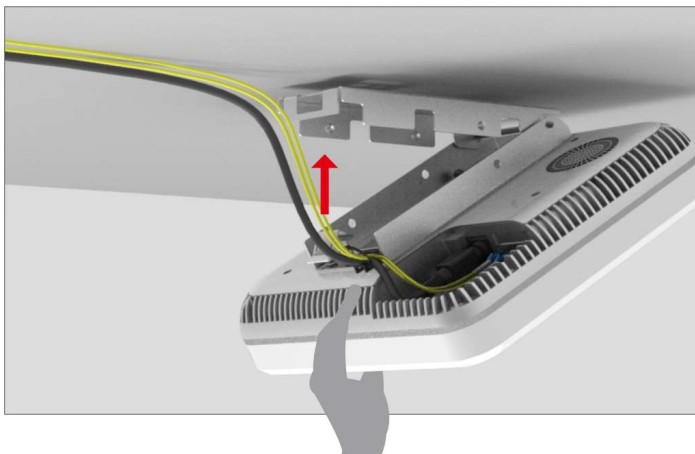

Figure 44. Installation Completed Diagram

1. Clip the bar on paired Bracket III over the hooks on Bracket II.

2. Connect the power cable and fiber cable to E62-N2RU

Note: Connect power cable first and then power it on. Do NOT connect the powered cable to the E62-N2RU in case of excessive current impulse.

3. Engage the rotary hook on Bracket IV into Bracket II



Figure 45. Tighten E62-N2RU

4. Tighten the M3 x 3 screws

To Perform Maintenance on the E62-N2RU



Figure 46. Unlock Rotary Hook Diagram 1

1. Depress the hook on the front of the E62-N2RU to expose top panel of E62-N2RU for debugging and maintenance

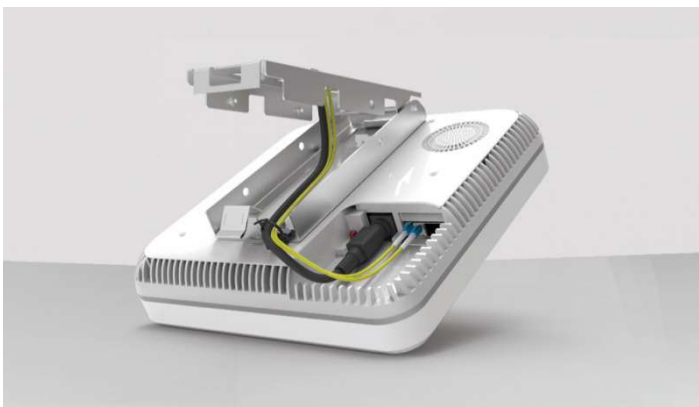

Figure 47. Unlock Rotary Hook Diagram 2

E62-N2RU CEILING INSTALLATION (WITHOUT SUSPENDED CEILING)

Draw Circles for Plastic Expansion Nails

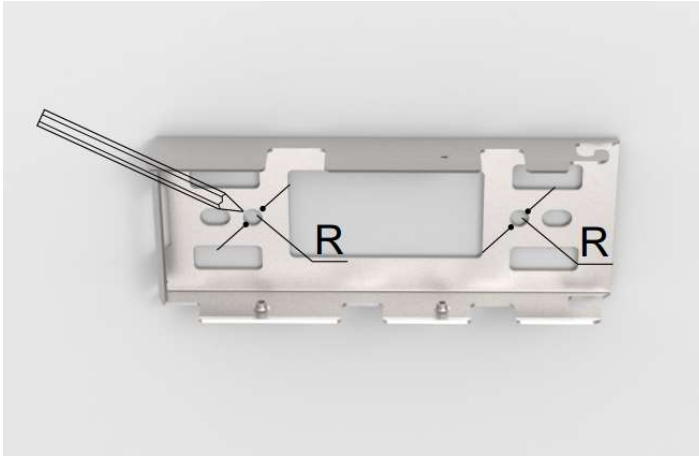

Figure 48. Drawing Circles Diagram 1

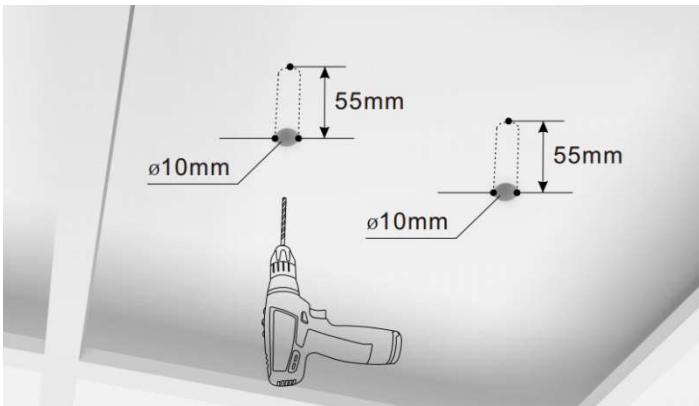

Figure 49. Drilling Holes Diagram 1



Figure 50. Insert Plastic Wall Plugs

1. Using the Mounting Bracket III keyholes as guides, mark the position of the 2 holes to be drilled into the ceiling.

2. Drill 2 holes with a diameter of 10 mm and depth of 55 mm at the positions in step 1.

3. Insert plastic wall plugs into holes by hammer.

Assemble Mounting Bracket



Figure 51. Assembling Bracket III Diagram 1



Figure 52. Assembling Bracket III Diagram 2

1. Assemble Mounting Bracket III to the ceiling using ST6.3 x 50 screws.

Buckle Up and Connect Wire

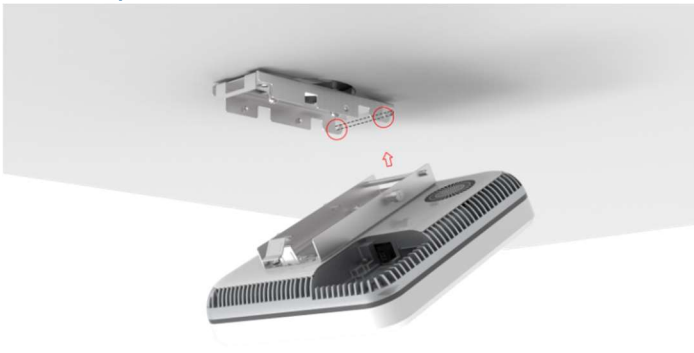

Figure 53. Connecting Bar over Hooks on Bracket II

1. Clip the bar on paired Bracket III over the hooks on Bracket II.

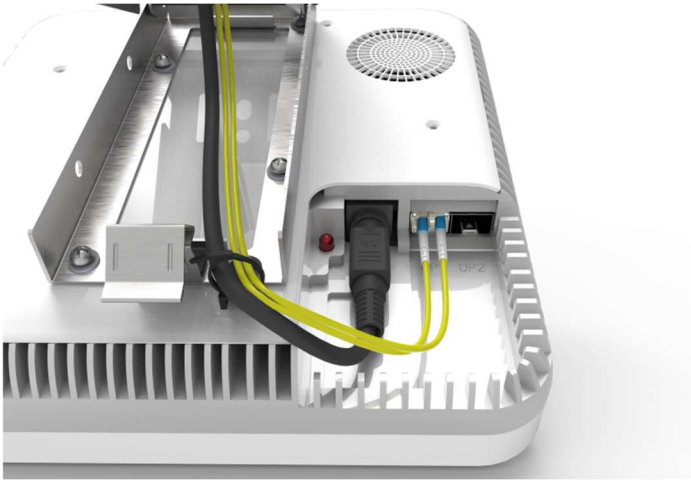

Figure 54. Wire Connection Diagram

2. Connect the power cable and fiber cable to E62-N2RU.

Note: Connect power cable first and then power it on. Do NOT connect the powered cable to the E62-N2RU in case of excessive current impulse.

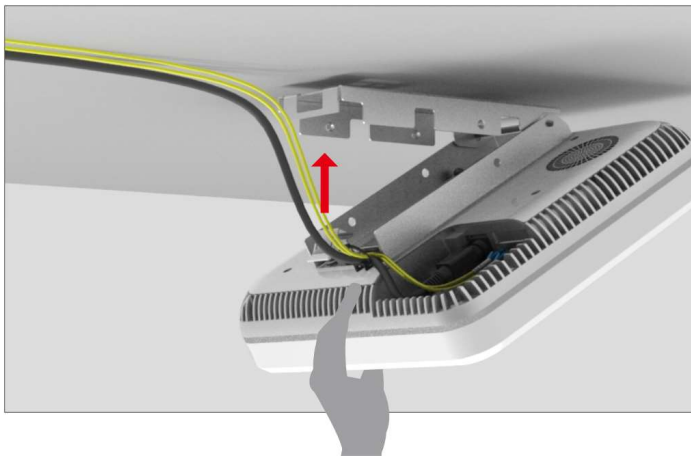

Figure 55. Installation Completed Diagram

3. Engage the rotary hook on Bracket IV into Bracket II



Figure 56. Tighten E62-N2RU

4. Tighten the M3 x 3 screws

To Perform Maintenance on the E62-N2RU



Figure 57. Unlock Rotary Hook Diagram 1

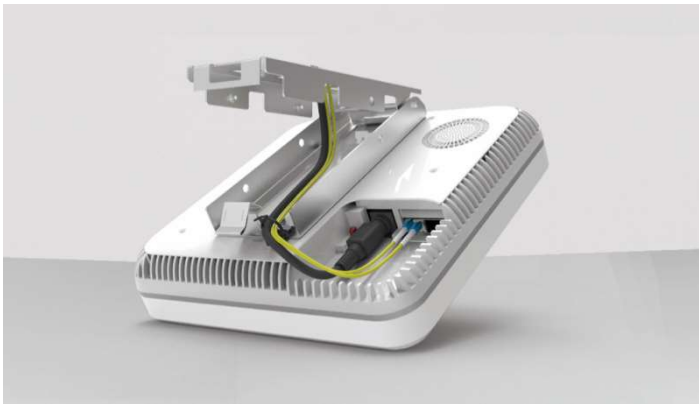

Figure 58. Top Panel of E62-N2RU Exposed

1. Depress the hook on the front of the E62-N2RU to expose the top panel of E62-N2RU for debugging and maintenance.

DUAL E62-N2RU CEILING INSTALLATION (WITH THE SUSPENDED CEILING)



Figure 59. Dual E62-N2RU

Dual E62-N2RU Accessories















① Screw M3×6	② Screw M6×70	③ Screw M5×14
		
④ Spring Washer M6	⑤ Flat Washer M6	⑥ Screw M3×10
		
⑦ Screw M10×90	⑧ Nylon Cable Ties	⑨ Optical Transceiver FTLX1370W4BTL
		
⑩ DC Power Lead 2m	⑪ Waterproof Connector	⑫ Mounting Bracket I
		
⑬ Mounting Bracket V		⑭ Mounting Bracket VI
		

Figure 60. Dual E62-N2RU Accessories

Assemble Bracket I & III

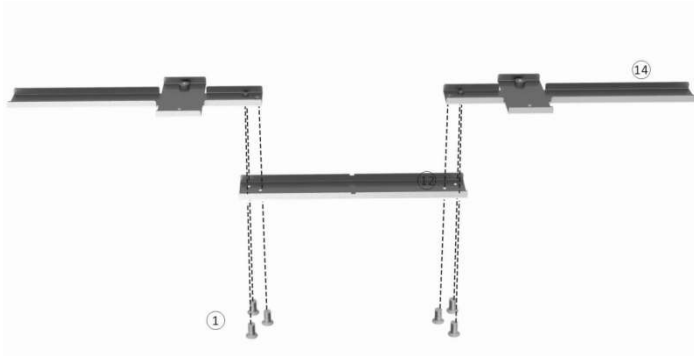

Figure 61. Assembling Bracket I & VI

1. Assemble Mounting Bracket I & VI with 6 x M3 x 6 screws.



Figure 62. Attaching Cable Tie to Mounting Bracket

2. Attach nylon cable tie to the Bracket I & VI combination.

Place the Bracket I & VI

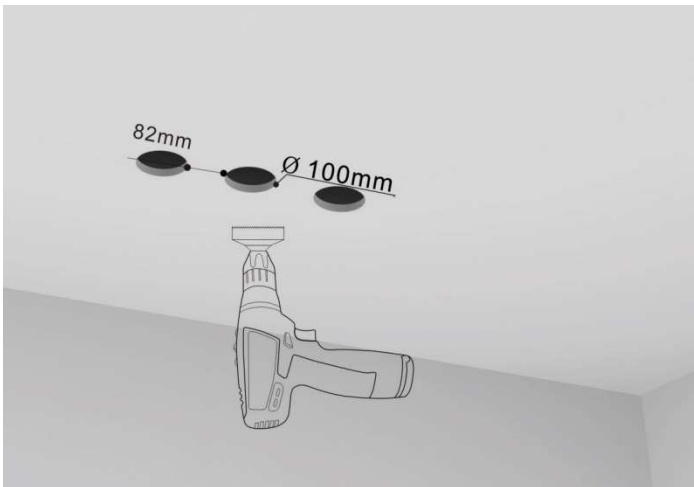

Figure 63. Drilling 3 Holes

1. Drill 3 holes for putting Mounting Bracket I & VI.



Figure 64. Placing the Bracket I & VI

2. Place the Mounting Bracket I & VI.



Figure 65. Placing the Bracket I & VI 2

3. Ensure the nylon tie hangs down through the hole and 2 x M6 screw threads are in holes of 2 sides.

Assemble the Bracket II



Figure 66. Assemble Bracket II

1. Attach Mounting Bracket II to Mounting Bracket V using 4 x M5 x 14 screws.

Note: Paired Mounting Bracket III is already assembled into E62-N2RU in factory

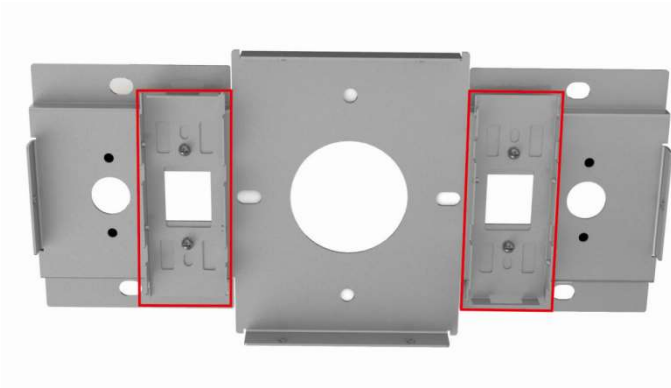

Figure 67. Assemble Bracket II 2

Note: 2 Bracket II are mounted in opposite directions for cooling.

Assemble the Bracket V

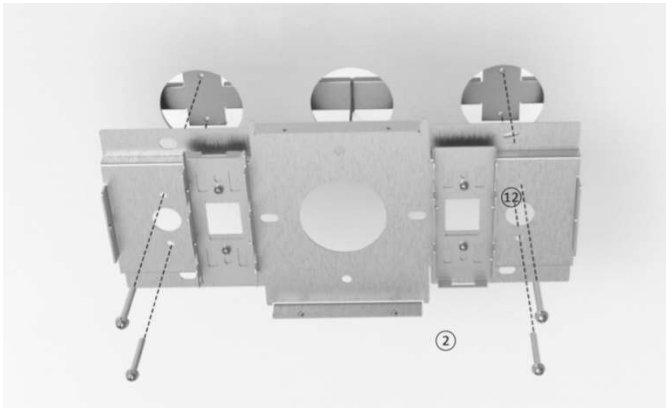

Figure 68. Assemble Bracket V

1. Assemble Mounting Bracket V to Mounting Bracket I using 4 x M6 x 70 screws, Flat Washer M6 and Spring Washer M6.



Figure 69. Bracket Bottom View

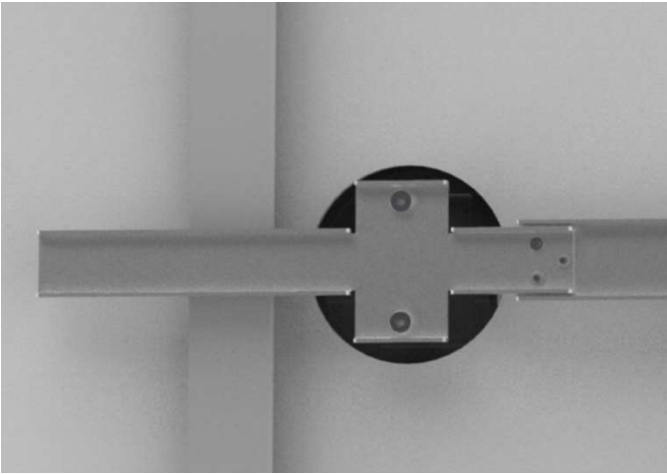

Figure 70. Bracket Top View

Buckle Up and Connect Wire

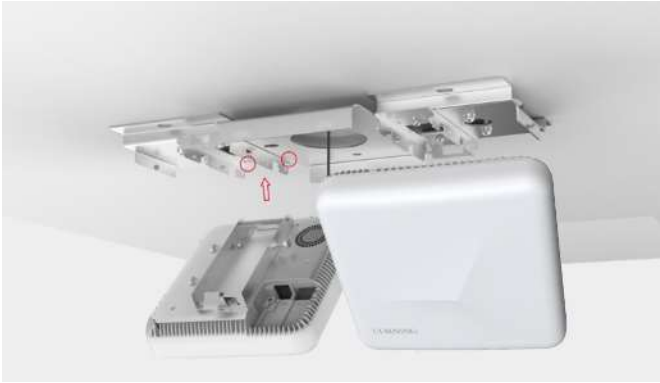

Figure 71. Buckle the Bracket



Figure 72. Buckle the Bracket 2



Figure 73. SFP Module Insertion

1. Buckle the bar side of Mounting III Bracket onto Mounting Bracket II

2. Connect the power cable and fiber optical cable to E62-N2RU.

Note: Connect power cable first and then power it on. Do NOT connect the powered cable to the E62-N2RU in case of excessive current impulse.

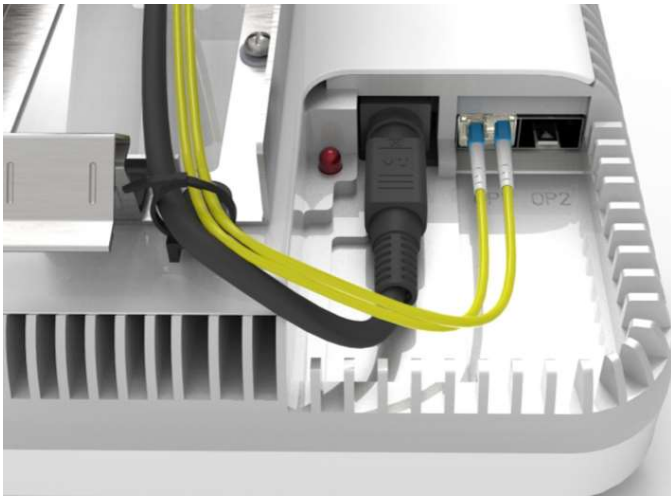

Figure 74. Wire Connection Diagram

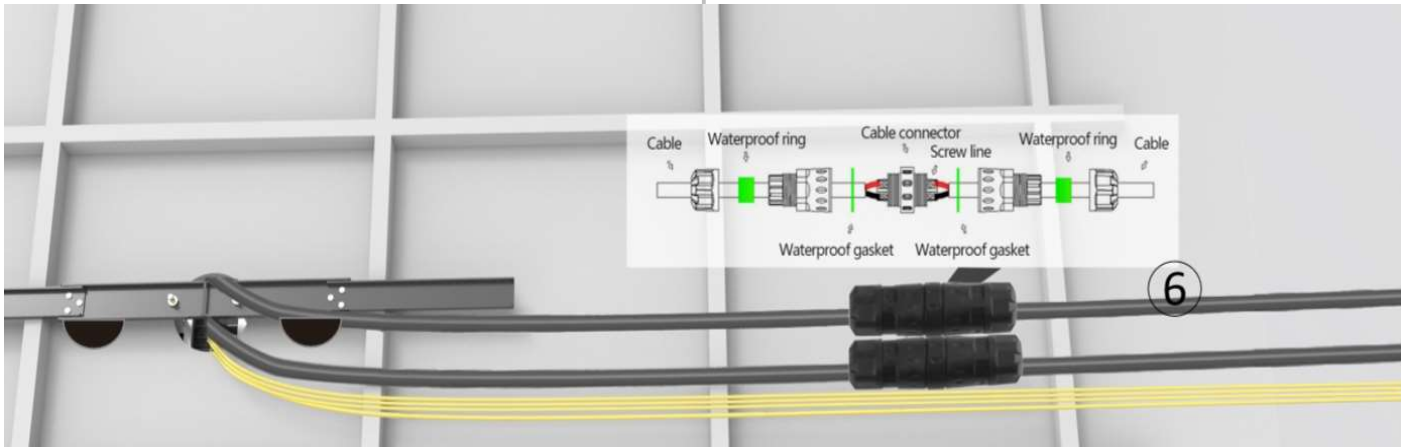

Figure 75. Wire Cabling View

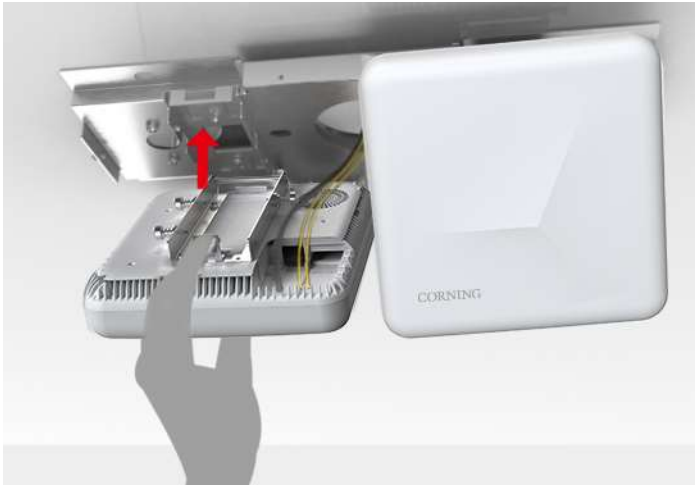

Figure 76. Push E62-N2RU Up

3. Push the E62-N2RU upward to interlace with the hook at the Bracket II.



Figure 77. Tighten the Screws

4. Tighten the M3 x 3 screws.

To Perform Maintenance on the E62-N2RU



Figure 78. Unlock Rotary Hook Diagram 1

1. Depress the hook on the front of the E62-N2RU to expose the top panel of E62-N2RU for debugging and maintenance.



Figure 79. Top Panel of E62-N2RU Exposed

Install Outer Case



Figure 80. Sleeve the Outer Case

1. Sleeve the outer case.

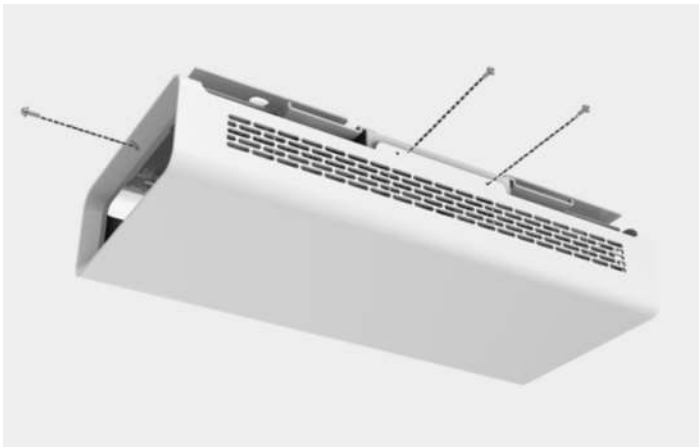

Figure 81. Tighten the Screws

2. Tighten the M3 x 10 screws.

E62-N2RU MOUNTING DIMENSION SPACING

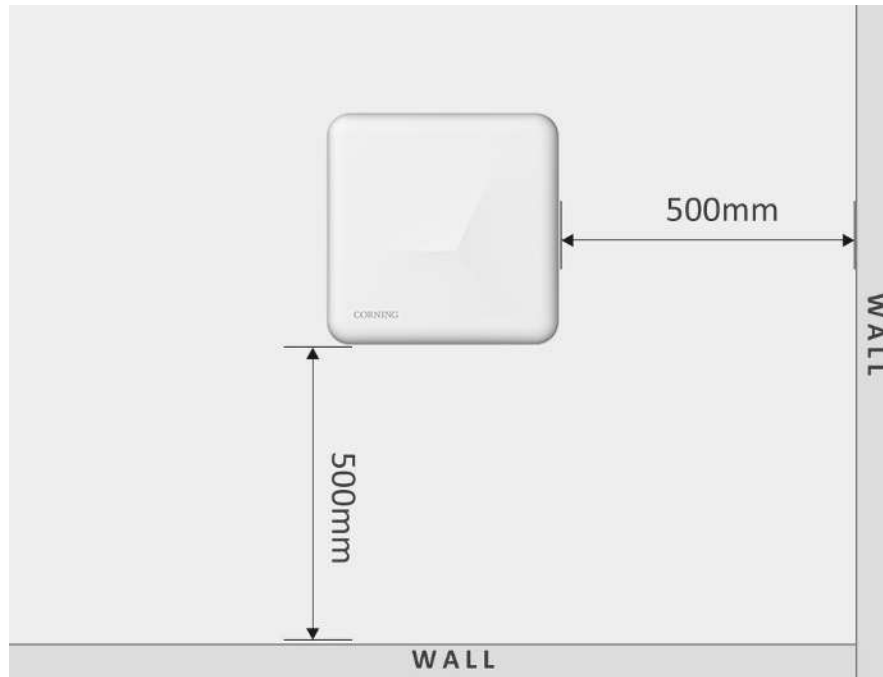

Figure 82. E62-N2RU Clearance

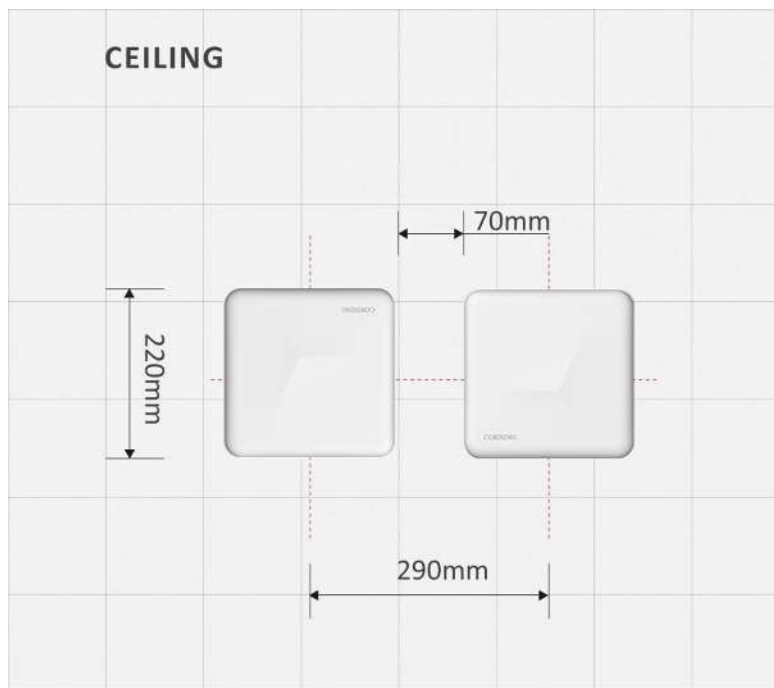

Figure 83. Dual E62-N2RU Clearance

Note: 2 x E62-N2RU installed in one spot are directional for case installation and cooling. (Details in Installation of the E62-N2RU)

FCC Warning:

This device complies with Part 15 of the FCC Rules. Operation is subject to the following two conditions:

- (1) This device may not cause harmful interference, and
- (2) This device must accept any interference received, including interference that may cause undesired operation.

Part20 Warning :

WARNING. This is NOT a CONSUMER device. It is designed for installation by FCC LICENSEES and QUALIFIED INSTALLERS. You MUST have an FCC LICENSE or express consent of an FCC Licensee to operate this device. Unauthorized use may result in significant forfeiture penalties, including penalties in excess of \$100,000 for each continuing violation.

Note: This product has been tested and found to comply with the limits for a Class B digital device, pursuant to Part 15 of the FCC Rules. These limits are designed to provide reasonable protection against harmful interference in a residential installation. This product generates, uses, and can radiate radio frequency energy and, if not installed and used in accordance with the instructions, may cause harmful interference to radio communications. However, there is no guarantee that interference will not occur in a particular installation. If this product does cause harmful interference to radio or television reception, which can be determined by turning the equipment off and on, the user is encouraged to try to correct the interference by one or more of the following measures:

- Reorient or relocate the receiving antenna.
- Increase the separation between the equipment and receiver.
- Connect the equipment into an outlet on a circuit different from that to which the receiver is connected.
- Consult the dealer or an experienced radio/TV technician for help.



CORNING

Corning Optical Communications LLC • 4200 Corning Place • Charlotte, NC 28216 USA 800-743-2675
FAX: 828-325-5060 • International: +1-828-901-5000 • www.corning.com/opcomm

Corning Optical Communications reserves the right to improve, enhance, and modify the features and specifications of Corning Optical Communications products without prior notification. A complete listing of the trademarks of Corning Optical Communications is available at www.corning.com/opcomm/trademarks. All other trademarks are the properties of their respective owners. Corning Optical Communications is ISO 9001 certified. © 2021 Corning Optical Communications. All rights reserved. CMA-794-AEN / July 2021