

Appendix

Photographs of Internal photo for KSCR2305000877AT

Test Model No.: E62-M3-L



Unless otherwise agreed in writing, this document is issued by the Company subject to its General Conditions of Service printed overleaf, available on request or accessible at <https://www.sgs.com/en/Terms-and-Conditions>. Attention is drawn to the limitation of liability, indemnification and jurisdiction issues defined therein. Any holder of this document is advised that information contained hereon reflects the Company's findings at the time of its intervention only and within the limits of Client's instructions, if any. The Company's sole responsibility is to its Client and this document does not exonerate parties to a transaction from exercising all their rights and obligations under the transaction documents. This document cannot be reproduced except in full, without prior written approval of the Company. Any unauthorized alteration, forgery or falsification of the content or appearance of this document is unlawful and offenders may be prosecuted to the fullest extent of the law. Unless otherwise stated the results shown in this test report refer only to the sample(s) tested and such sample(s) are retained for 30 days only.

Attention: To check the authenticity of testing /inspection report & certificate, please contact us at telephone: (86-755) 8307 1443, or email: CN.Doccheck@sgs.com

No.10 Weiye Road, Development Zone, Kunshan, Jiangsu, China 215300 t(86-512) 5735 5888 f(86-512) 57370818 www.sgsgroup.com.cn
中国·江苏·昆山开发区伟业路10号 邮编: 215300 t(86-512) 57355888 f(86-512) 57370818 sgs.china@sgs.com

EUT Constructional Details (EUT Photos)

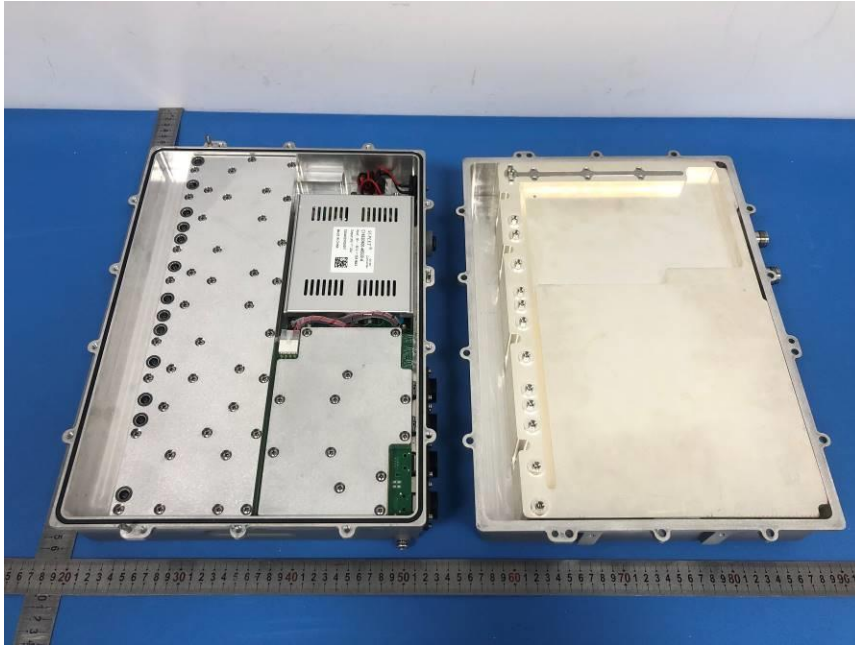

Unless otherwise agreed in writing, this document is issued by the Company subject to its General Conditions of Service printed overleaf, available on request or accessible at <https://www.sgs.com/en/Terms-and-Conditions>. Attention is drawn to the limitation of liability, indemnification and jurisdiction issues defined therein. Any holder of this document is advised that information contained hereon reflects the Company's findings at the time of its intervention only and within the limits of Client's instructions, if any. The Company's sole responsibility is to its Client and this document does not exonerate parties to a transaction from exercising all their rights and obligations under the transaction documents. This document cannot be reproduced except in full, without prior written approval of the Company. Any unauthorized alteration, forgery or falsification of the content or appearance of this document is unlawful and offenders may be prosecuted to the fullest extent of the law. Unless otherwise stated the results shown in this test report refer only to the sample(s) tested and such sample(s) are retained for 30 days only.

Attention: To check the authenticity of testing /inspection report & certificate, please contact us at telephone: (86-755) 8307 1443, or email: CN.Doccheck@sgs.com
 No.10 Weiye Road, Development Zone, Kunshan, Jiangsu, China 215300 t(86-512)5735 5888 f(86-512) 57370818 www.sgsgroup.com.cn
 中国·江苏·昆山开发区伟业路10号 邮编: 215300 t(86-512)57355888 f(86-512)57370818 sgs.china@sgs.com

AC POWER SUPPLY



DC POWER SUPPLY

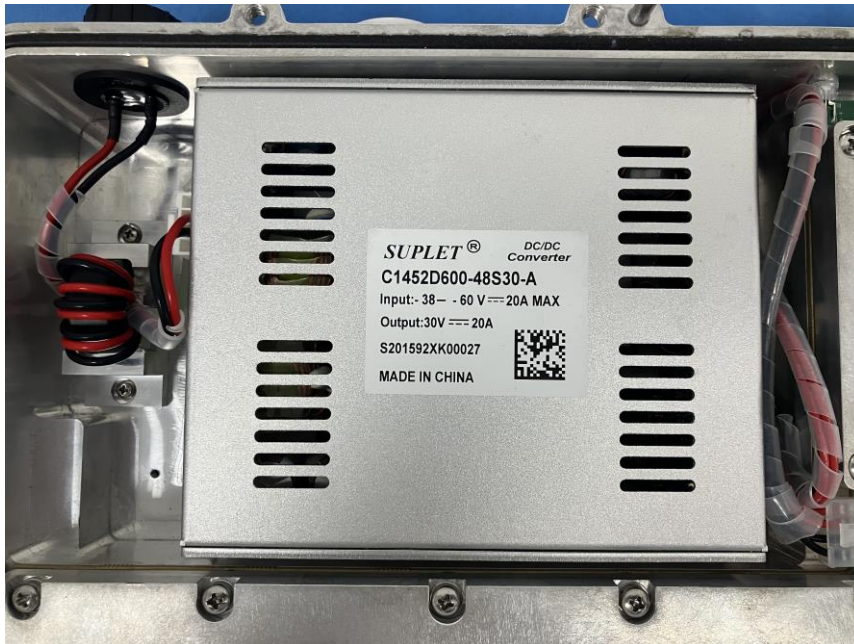

Unless otherwise agreed in writing, this document is issued by the Company subject to its General Conditions of Service printed overleaf, available on request or accessible at <https://www.sgs.com/en/Terms-and-Conditions>. Attention is drawn to the limitation of liability, indemnification and jurisdiction issues defined therein. Any holder of this document is advised that information contained hereon reflects the Company's findings at the time of its intervention only and within the limits of Client's instructions, if any. The Company's sole responsibility is to its Client and this document does not exonerate parties to a transaction from exercising all their rights and obligations under the transaction documents. This document cannot be reproduced except in full, without prior written approval of the Company. Any unauthorized alteration, forgery or falsification of the content or appearance of this document is unlawful and offenders may be prosecuted to the fullest extent of the law. Unless otherwise stated the results shown in this test report refer only to the sample(s) tested and such sample(s) are retained for 30 days only.

Attention: To check the authenticity of testing /inspection report & certificate, please contact us at telephone: (86-755) 8307 1443, or email: CN.Doccheck@sgs.com
 No.10 Weiye Road, Development Zone, Kunshan, Jiangsu, China 215300 t(86-512)5735 5888 f(86-512)57370818 www.sgsgroup.com.cn
 中国·江苏·昆山开发区伟业路10号 邮编: 215300 t(86-512)57355888 f(86-512)57370818 sgs.china@sgs.com

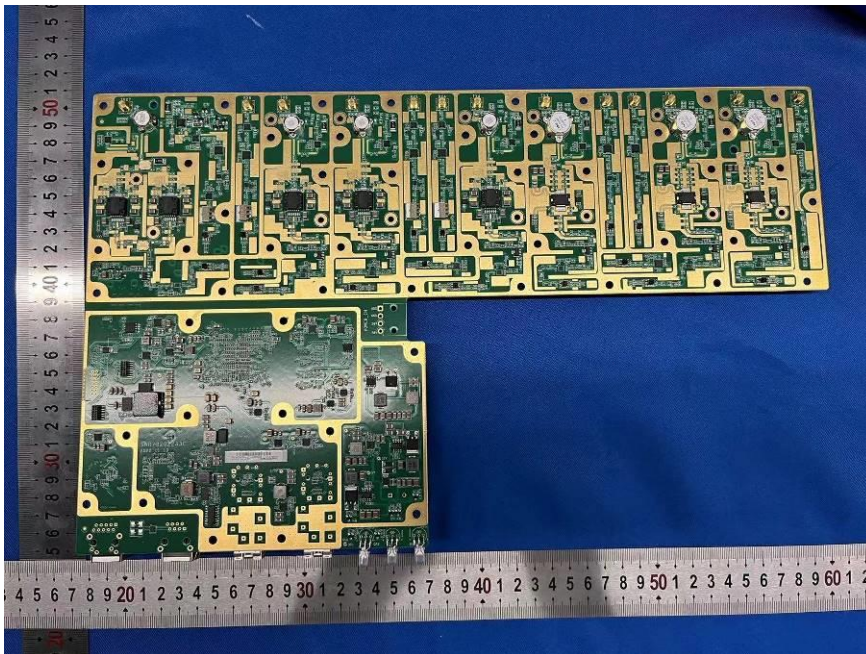
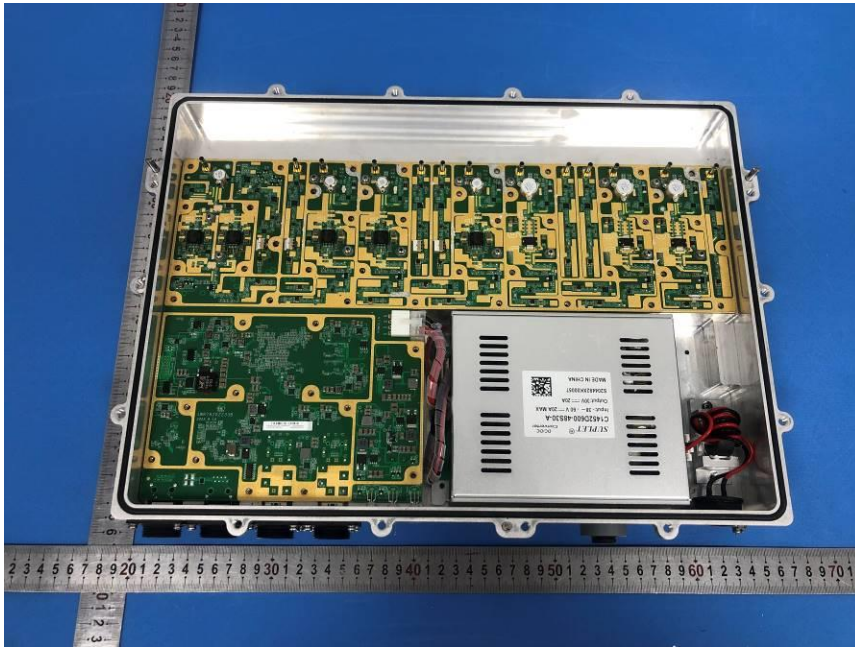

Unless otherwise agreed in writing, this document is issued by the Company subject to its General Conditions of Service printed overleaf, available on request or accessible at <https://www.sgs.com/en/Terms-and-Conditions>. Attention is drawn to the limitation of liability, indemnification and jurisdiction issues defined therein. Any holder of this document is advised that information contained hereon reflects the Company's findings at the time of its intervention only and within the limits of Client's instructions, if any. The Company's sole responsibility is to its Client and this document does not exonerate parties to a transaction from exercising all their rights and obligations under the transaction documents. This document cannot be reproduced except in full, without prior written approval of the Company. Any unauthorized alteration, forgery or falsification of the content or appearance of this document is unlawful and offenders may be prosecuted to the fullest extent of the law. Unless otherwise stated the results shown in this test report refer only to the sample(s) tested and such sample(s) are retained for 30 days only.

Attention: To check the authenticity of testing /inspection report & certificate, please contact us at telephone: (86-755) 8307 1443, or email: CN.Doccheck@sgs.com

No.10 Weiye Road, Development Zone, Kunshan, Jiangsu, China 215300 t(86-512)5735 5888 f(86-512)57370818 www.sgsgroup.com.cn
 中国·江苏·昆山开发区伟业路10号 邮编: 215300 t(86-512)57355888 f(86-512)57370818 sgs.china@sgs.com

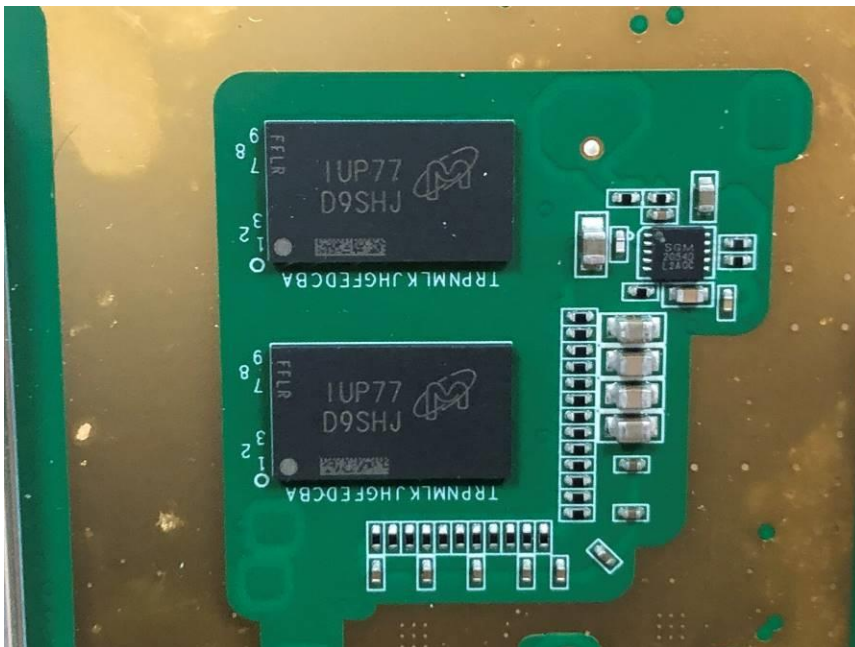
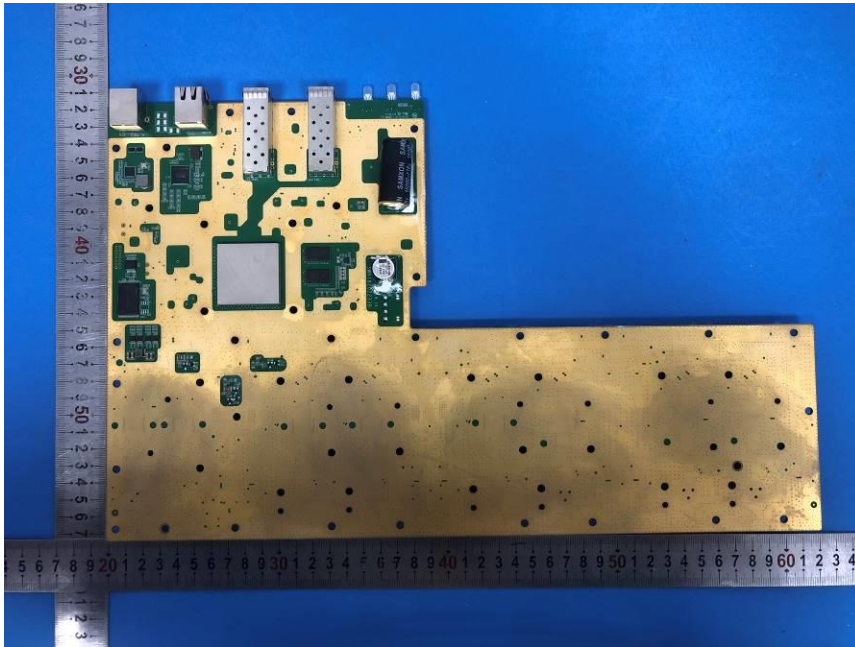

Unless otherwise agreed in writing, this document is issued by the Company subject to its General Conditions of Service printed overleaf, available on request or accessible at <https://www.sgs.com/en/Terms-and-Conditions>. Attention is drawn to the limitation of liability, indemnification and jurisdiction issues defined therein. Any holder of this document is advised that information contained hereon reflects the Company's findings at the time of its intervention only and within the limits of Client's instructions, if any. The Company's sole responsibility is to its Client and this document does not exonerate parties to a transaction from exercising all their rights and obligations under the transaction documents. This document cannot be reproduced except in full, without prior written approval of the Company. Any unauthorized alteration, forgery or falsification of the content or appearance of this document is unlawful and offenders may be prosecuted to the fullest extent of the law. Unless otherwise stated the results shown in this test report refer only to the sample(s) tested and such sample(s) are retained for 30 days only.

Attention: To check the authenticity of testing /inspection report & certificate, please contact us at telephone: (86-755) 8307 1443, or email: CN.Doccheck@sgs.com

No.10 Weiye Road, Development Zone, Kunshan, Jiangsu, China 215300 t(86-512)5735 5888 f(86-512)57370818 www.sgsgroup.com.cn
 中国·江苏·昆山开发区伟业路10号 邮编: 215300 t(86-512)57355888 f(86-512)57370818 sgs.china@sgs.com

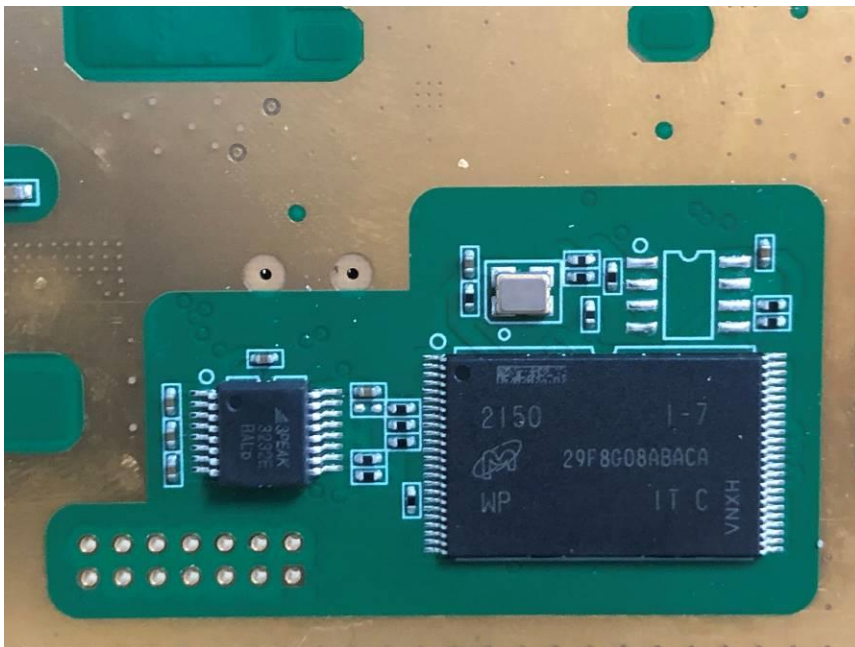
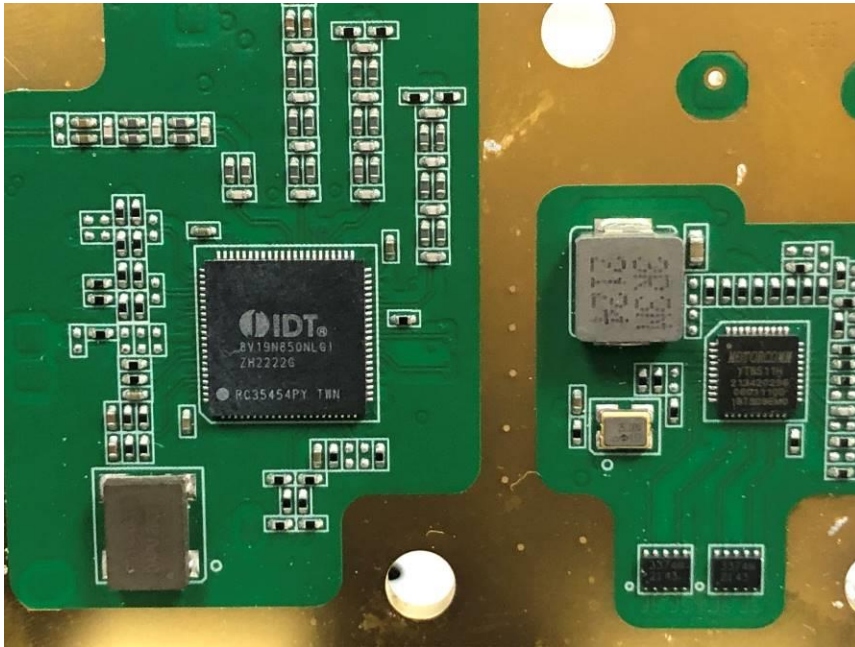

Unless otherwise agreed in writing, this document is issued by the Company subject to its General Conditions of Service printed overleaf, available on request or accessible at <https://www.sgs.com/en/Terms-and-Conditions>. Attention is drawn to the limitation of liability, indemnification and jurisdiction issues defined therein. Any holder of this document is advised that information contained hereon reflects the Company's findings at the time of its intervention only and within the limits of Client's instructions, if any. The Company's sole responsibility is to its Client and this document does not exonerate parties to a transaction from exercising all their rights and obligations under the transaction documents. This document cannot be reproduced except in full, without prior written approval of the Company. Any unauthorized alteration, forgery or falsification of the content or appearance of this document is unlawful and offenders may be prosecuted to the fullest extent of the law. Unless otherwise stated the results shown in this test report refer only to the sample(s) tested and such sample(s) are retained for 30 days only.

Attention: To check the authenticity of testing /inspection report & certificate, please contact us at telephone: (86-755) 8307 1443, or email: CN.Doccheck@sgs.com
 No.10 Weiye Road, Development Zone, Kunshan, Jiangsu, China 215300 t(86-512)5735 5888 f(86-512)57370818 www.sgsgroup.com.cn
 中国·江苏·昆山开发区伟业路10号 邮编: 215300 t(86-512)57355888 f(86-512)57370818 sgs.china@sgs.com



DC POWER CABLE



Unless otherwise agreed in writing, this document is issued by the Company subject to its General Conditions of Service printed overleaf, available on request or accessible at <https://www.sgs.com/en/Terms-and-Conditions>. Attention is drawn to the limitation of liability, indemnification and jurisdiction issues defined therein. Any holder of this document is advised that information contained hereon reflects the Company's findings at the time of its intervention only and within the limits of Client's instructions, if any. The Company's sole responsibility is to its Client and this document does not exonerate parties to a transaction from exercising all their rights and obligations under the transaction documents. This document cannot be reproduced except in full, without prior written approval of the Company. Any unauthorized alteration, forgery or falsification of the content or appearance of this document is unlawful and offenders may be prosecuted to the fullest extent of the law. Unless otherwise stated the results shown in this test report refer only to the sample(s) tested and such sample(s) are retained for 30 days only.

Attention: To check the authenticity of testing /inspection report & certificate, please contact us at telephone: (86-755) 8307 1443, or email: CN.Doccheck@sgs.com

No.10 Weiye Road, Development Zone, Kunshan, Jiangsu, China 215300 t(86-512)5735 5888 f(86-512)57370818 www.sgsgroup.com.cn
 中国·江苏·昆山开发区伟业路10号 邮编: 215300 t(86-512)57355888 f(86-512)57370818 sgs.china@sgs.com

AC POWER CABLE



Unless otherwise agreed in writing, this document is issued by the Company subject to its General Conditions of Service printed overleaf, available on request or accessible at <https://www.sgs.com/en/Terms-and-Conditions>. Attention is drawn to the limitation of liability, indemnification and jurisdiction issues defined therein. Any holder of this document is advised that information contained hereon reflects the Company's findings at the time of its intervention only and within the limits of Client's instructions, if any. The Company's sole responsibility is to its Client and this document does not exonerate parties to a transaction from exercising all their rights and obligations under the transaction documents. This document cannot be reproduced except in full, without prior written approval of the Company. Any unauthorized alteration, forgery or falsification of the content or appearance of this document is unlawful and offenders may be prosecuted to the fullest extent of the law. Unless otherwise stated the results shown in this test report refer only to the sample(s) tested and such sample(s) are retained for 30 days only.

Attention: To check the authenticity of testing /inspection report & certificate, please contact us at telephone: (86-755) 8307 1443, or email: CN.Doccheck@sgs.com

No.10 Weiye Road, Development Zone, Kunshan, Jiangsu, China 215300 t(86-512)5735 5888 f(86-512) 57370818 www.sgsgroup.com.cn
中国·江苏·昆山开发区伟业路10号 邮编: 215300 t(86-512)57355888 f(86-512)57370818 sgs.china@sgs.com