



DATE: 4 August 2021

**I.T.L. (PRODUCT TESTING) LTD.
FCC Radio Test Report**

**For
Corning Optical Communications
Wireless Ltd.**

**Equipment under test:
Medium Power Modular Remote Unit
Everon 6000 DAS - dMRU TDD 2.5**

Tested by: 
B. Mizrahi

Approved by: 
D. Shidlow

This report must not be reproduced, except in full, without the written permission of I.T.L. (Product Testing) Ltd.
This report relates only to items tested.



Measurement/Technical Report for Corning Optical Communications Wireless Ltd.

Medium Power Modular Remote Unit

Everon 6000 DAS - dMRU TDD 2.5

(TDD-2.5)

FCC ID: OJFDMRUDPAM25

This report concerns: Original Grant: X
 Class II change:
 Class I change:

Equipment type: Part 20 Industrial Booster (CMRS)

Limits used: 47CFR Parts 2; 27

Measurement procedure used is KDB 935210 D05 v01r04 April 2020 and
ANSI IEEE C63.26-2015

Substitution Method used as in ANSI TIA-603-E-2016

Application for Certification
prepared by:
R. Ezra
ITL (Product Testing) Ltd.
1 Bat Sheva St., Lod 7120101
Israel
E-mail: rame@itlglobal.org

Applicant for this device (different from
"prepared by"):
Isaac Nissan
Corning Optical Communication Wireless
8253 1st Street, Vienna, VA 22812, U.S.A.
Tel: +1-703 855-1773
Email: nissani@corning.com



TABLE OF CONTENTS

1	GENERAL INFORMATION -----	5
	1.1 Administrative Information	5
	1.2 List of Accreditations	6
	1.3 Product Description	7
	1.4 Test Methodology	7
	1.5 Test Facility	7
	1.6 Measurement Uncertainty	7
2	SYSTEM TEST CONFIGURATION -----	8
	2.1 Justification	8
	2.2 EUT Exercise Software	8
	2.3 Special Accessories	8
	2.4 Equipment Modifications	8
	2.5 Configuration of Tested System	8
3	TEST SET-UP PHOTOS -----	10
4	RF POWER OUTPUT -----	12
	4.1 Test Specification	12
	4.2 Test Procedure	12
	4.3 Test Limit	12
	4.4 Test Results	12
	4.5 Test Equipment Used; RF Power Output	29
5	OCCUPIED BANDWIDTH -----	30
	5.1 Test Specification	30
	5.2 Test Procedure	30
	5.3 Test Limit	30
	5.4 Test Results	30
	5.5 Test Equipment Used; Occupied Bandwidth	63
6	PEAK TO AVERAGE POWER RATIO -----	64
	6.1 Test Specification	64
	6.2 Test Procedure	64
	6.3 Test Limit	64
	6.4 Test Results	64
	6.5 Test Equipment Used; 0.1% PAPR	81
7	BAND EDGE SPECTRUM -----	82
	7.1 Test Specification	82
	7.2 Test Procedure	82
	7.3 Test Limit	82
	7.4 Test Results	82
	7.5 Equipment Used; Band Edge Spectrum	93
8	SPURIOUS EMISSIONS AT ANTENNA TERMINALS -----	94
	8.1 Test Specification	94
	8.2 Test Procedure	94
	8.3 Test Results	94
	8.4 Equipment Used; Spurious Emissions at Antenna Terminals	129
9	SPURIOUS RADIATED EMISSION -----	130
	9.1 Test Specification	130
	9.2 Test Procedure	130
	9.3 Test Limit	131
	9.4 Test Results	131
	9.5 Test Instrumentation Used; Radiated Measurements	132



10	OUT-OF-BAND REJECTION	133
	10.1 Test Specification	133
	10.2 Test Procedure	133
	10.3 Test Limit	133
	10.4 Test Results.....	133
	10.5 Test Equipment Used; Out-of-Band Rejection	134
11	APPENDIX A - CORRECTION FACTORS	135
	11.1 For ITL #1911 OATS RF Cable.....	135
	11.2 For ITL #1840 Anechoic Chamber RF Cable.....	136
	11.3 For ITL # 1075 Active Loop Antenna	137
	11.4 For ITL #1356 Biconical Antenna	138
	11.5 For ITL # 1349 Log Periodic Antenna	139



1 General Information

1.1 Administrative Information

Manufacturer:	Corning Optical Communications Wireless Ltd.
Manufacturer's Address:	8253 1st Street Vienna, VA 22812 U.S.A. Tel: +1-703 855-1773
Manufacturer's Representative:	Isaac Nissan
Equipment Under Test (E.U.T):	Medium Power Modular Remote Unit
Equipment Model No.:	Everon 6000 DAS - dMRU TDD 2.5
Equipment Serial No.:	0920470018
Date of Receipt of E.U.T:	June 13, 2021
Start of Test:	June 14, 2021
End of Test:	June 30, 2021
Test Laboratory Location:	I.T.L. (Product Testing) Ltd. 1 Bat Sheva St., Lod 7116002, Israel
Test Specifications:	FCC Parts 2; 27



1.2 List of Accreditations

The EMC laboratory of I.T.L. is accredited by/registered with the following bodies:

1. The American Association for Laboratory Accreditation (A2LA) (U.S.A.), Certificate No. 1152.01.
2. The Federal Communications Commission (FCC) (U.S.A.), FCC Designation Number is IL1005.
3. The Israel Ministry of the Environment (Israel), Registration No. 1104/01.
4. The Voluntary Control Council for Interference by Information Technology Equipment (VCCI) (Japan), Registration Numbers: C-20025, R-2729, T-20028, G-20068.
5. Department of Innovation, Science and Economic Development (ISED) Canada, CAB identifier: IL1002.

I.T.L. Product Testing Ltd. is accredited by the American Association for Laboratory Accreditation (A2LA) and the results shown in this test report have been determined in accordance with I.T.L.'s terms of accreditation unless stated otherwise in the report.



1.3 Product Description

DMRU - Digital Medium-power Remote Unit.

The MRU is a medium power modular remote antenna unit with a single antenna port.

The Output power for the lower bands: 600/700 MHz Low/700 MHz High/FirstNet, 800/850 MHz is 33 dBm and the output power for the medium bands EAWS, PCS, WCS and 2.5GHz TDD is 37dBm.

The MRU modular structure and integrated high-performance cavity based multiplexing functionalities, enable setups of up to 6 RF modules, for a variety of licensed frequency bands within a single cabinet.

The MRU also provides CBRS/C-Band ready RF interface for future field upgrades.

1.4 Test Methodology

Both conducted and radiated testing were performed according to the procedures in KDB 935210 D05 v01r03 April 2019 and ANSI/TIA-603-E-2016. Radiated testing was performed at an antenna to EUT distance of 3 meters.

1.5 Test Facility

Both conducted and radiated emissions tests were performed at I.T.L.'s testing facility in Lod, Israel. I.T.L.'s EMC Laboratory is accredited by A2LA, certificate No. 1152.01 and its FCC Designation Number is IL1005.

1.6 Measurement Uncertainty

Conducted Emission (CISPR 11, EN 55011, CISPR 32, EN 55032, ANSI C63.4)
0.15 – 30 MHz:

Expanded Uncertainty (95% Confidence, K=2):
 ± 3.44 dB

Radiated Emission (CISPR 11, EN 55011, CISPR 32, EN 55032, ANSI C63.4)
for open site 30-1000MHz:

Expanded Uncertainty (95% Confidence, K=2):
 ± 4.98 dB

2 System Test Configuration

2.1 Justification

The dMRU is a repeater supporting a broad range of cellular generations: 4G and 5G in the TDD-2.5 band.

Evaluation was performed at the low, mid and high channels each one defined per the operation BW.

Evaluation was performed at 115VAC as the nominal power source.

Conducted tests were performed with an external attenuator connected to the spectrum analyzer.

Radiated emission tests were performed with a 50Ω termination connected to the E.U.T output terminal.

2.2 EUT Exercise Software

The Element Management System ver. 1.4 used for commands delivery. These commands are used to enable/disable the EUT transmission. SW Ver. is 1.4.

2.3 Special Accessories

No special accessories were needed in order to achieve compliance.

2.4 Equipment Modifications

No modifications were necessary in order to achieve compliance.

2.5 Configuration of Tested System

Product Name	Corning Everon 6000 DAS - dMRU
Model Name	dMRU medium power modular remote unit (TDD-2.5)
Working voltage	48 VDC ,115/230 VAC
Mode of operation	Repeater Booster support -4,5G
Modulations	16QAM, 64QAM, 256QAM, QPSK
Frequency Range	TDD-2.5 (DL: 2496-2690, UL: 2496-2690)
Transmit power	~40 dBm (Max) per band
DATA rate	N/A
Modulation BW	20; 40; 60 MHZ
DC Voltage applied to final RF stage band board (Driver and PA)	28.5V
DC Current applied to final RF stage band board (Driver and PA)	1.8A

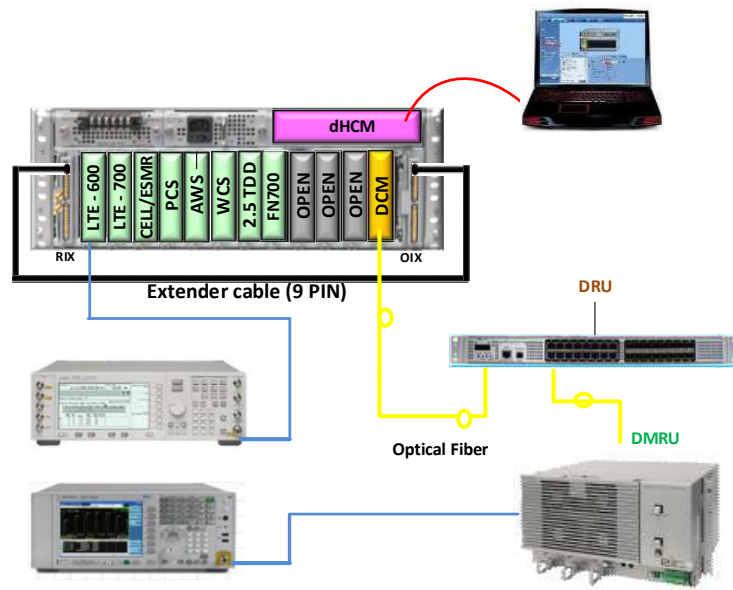

Figure 1. Conducted Test Set-Up

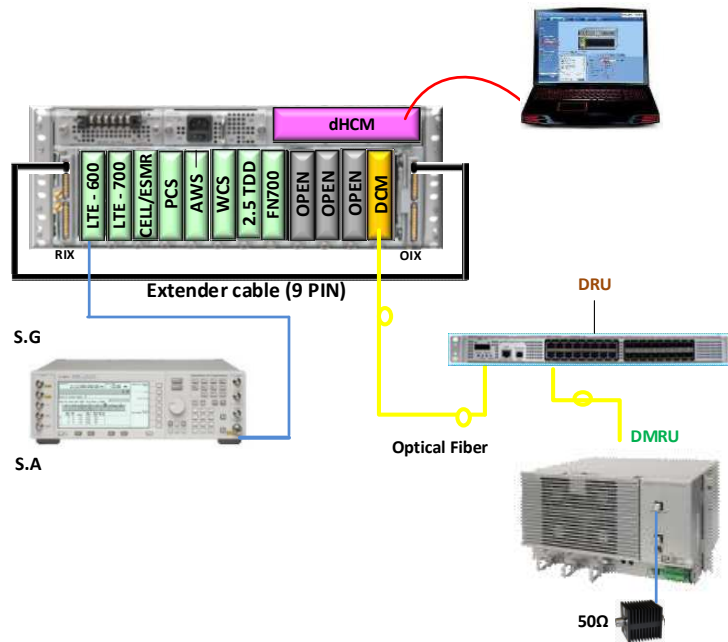

Figure 2. Radiated Test Set-Up

3 Test Set-Up Photos

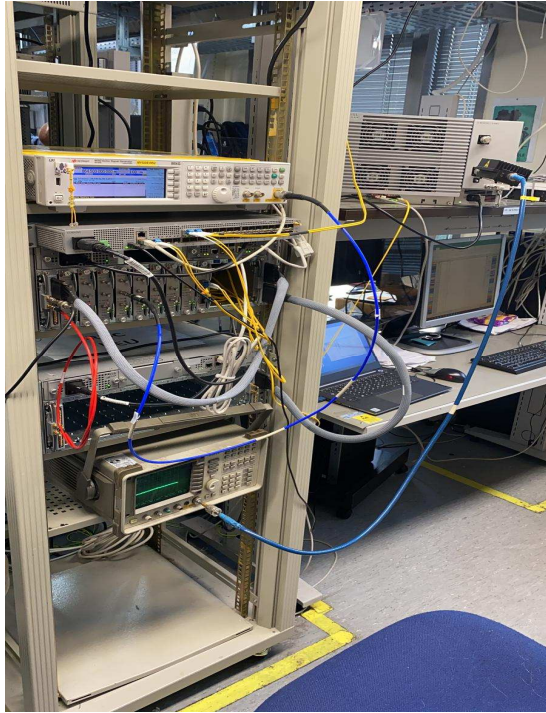

Figure 3. Conducted Emission From Antenna Port Tests



Figure 4. Radiated Emission Test 9kHz - 30MHz



Figure 5. Radiated Emission Test 30 - 200 MHz



Figure 6. Radiated Emission Test 200 - 1000MHz



Figure 7. Radiated Emission Test 1.0 - 9.0GHz

4 RF Power Output

4.1 Test Specification

FCC Part 27, Subpart C (27.50)

4.2 Test Procedure

(Temperature (22°C)/ Humidity (36%RH))

The E.U.T. antenna terminal was connected to the Spectrum Analyzer through an external attenuator (41.1 dB) and an appropriate coaxial cable. Special attention was taken to prevent Spectrum Analyzer RF input overload.

4.3 Test Limit

Peak Power Output must not exceed 1000W (60 dBm).

4.4 Test Results

JUDGEMENT: Passed

See additional information in:

5G: Table 1 to Table 3, and Figure 8 to Figure 67.

4G: Table 5 and Figure 68 to Figure 76.

5G

Modulation	Bandwidth (MHz)	Sub Carrier (kHz)	Operation Frequency (MHz)	Reading (dBm)
16QAM	40	15	2516	38.27
		30	2516	38.33
		60	2516	38.30
		15	2593	38.58
		30	2593	38.63
		60	2593	38.59
		15	2670	37.51
		30	2670	37.69
		60	2670	37.64
	60	30	2526	38.56
		60	2526	39.42
		30	2593	38.82
		60	2593	39.51
		30	2660	38.78
	60	2660	39.63	

Table 1 RF Power Output 16QAM

Modulation	Bandwidth (MHz)	Sub Carrier (kHz)	Operation Frequency (MHz)	Reading (dBm)
64QAM	40	15	2516	40.82
		30	2516	41.14
		60	2516	41.06
		15	2593	40.86
		30	2593	40.88
		60	2593	41.85
		15	2670	40.02
		30	2670	39.95
		60	2670	41.09
	60	30	2526	40.57
		60	2526	40.53
		30	2593	40.23
		60	2593	40.44
		30	2660	40.93
	60	2660	40.98	

Table 2 RF Power Output 64QAM

Modulation	Bandwidth (MHz)	Sub Carrier (kHz)	Operation Frequency (MHz)	Reading (dBm)
256QAM	40	15	2516	41.15
		30	2516	40.93
		60	2516	40.72
		15	2593	42.16
		30	2593	41.86
		60	2593	41.58
		15	2670	41.09
		30	2670	41.09
		60	2670	40.84
	60	30	2526	40.12
		60	2526	40.10
		30	2593	39.17
		60	2593	39.36
		30	2660	40.51
	60	2660	40.45	

Table 3 RF Power Output 256QAM

Modulation	Bandwidth (MHz)	Sub Carrier (kHz)	Operation Frequency (MHz)	Reading (dBm)
QPSK	40	15	2516	40.29
		30	2516	39.89
		60	2516	39.90
		15	2593	40.36
		30	2593	39.82
		60	2593	39.76
		15	2670	39.38
		30	2670	39.13
		60	2670	38.98
	60	30	2526	40.21
		60	2526	39.87
		30	2593	39.96
		60	2593	39.77
		30	2660	40.03
	60	2660	39.84	

Table 4 RF Power Output QPSK

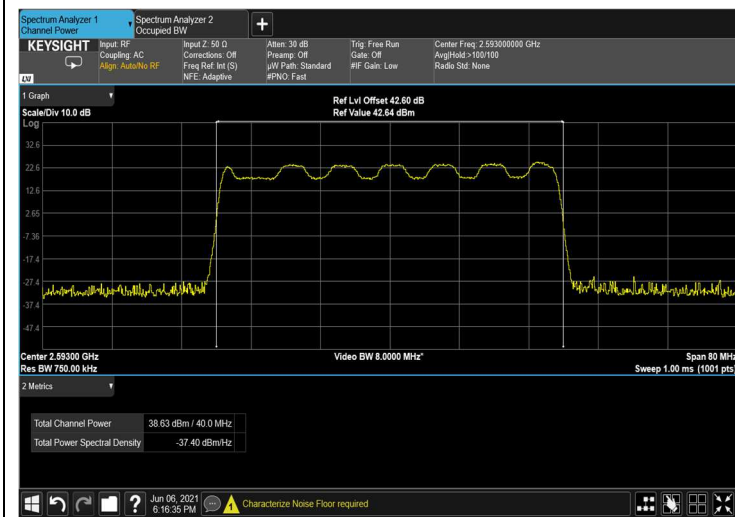
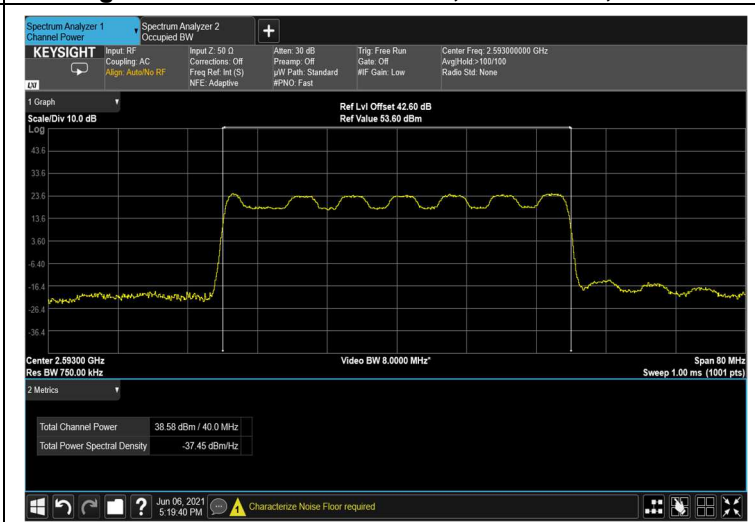
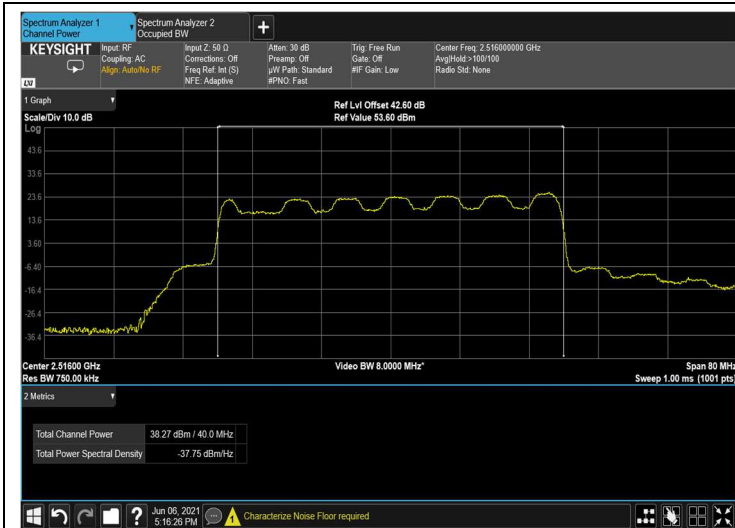

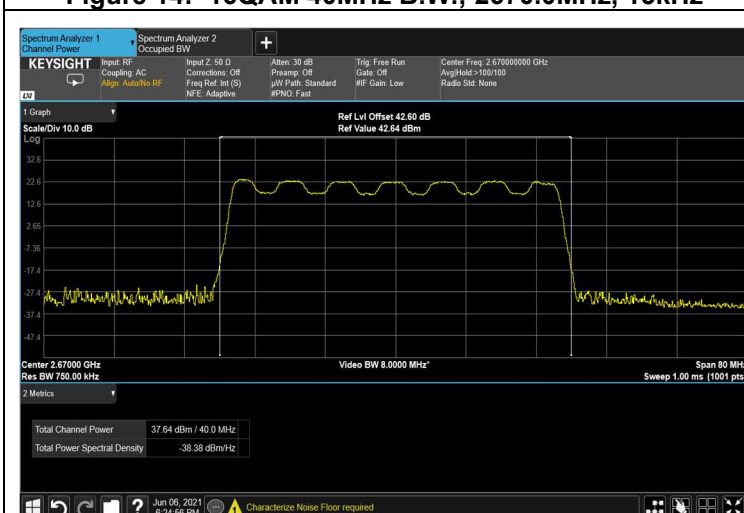
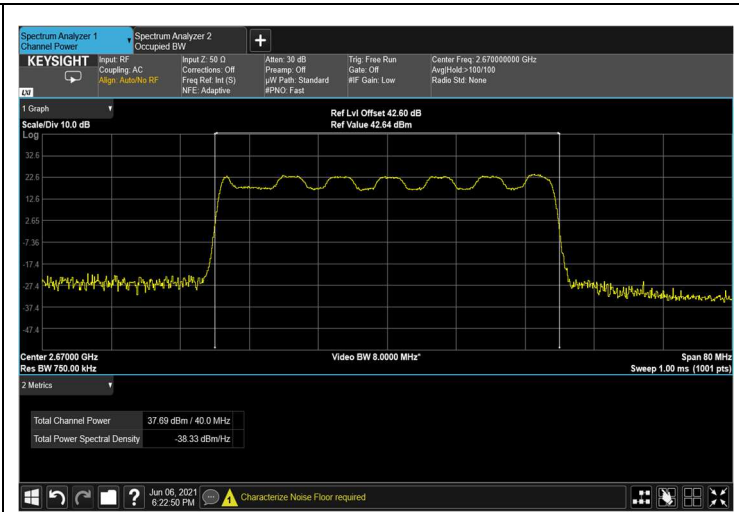
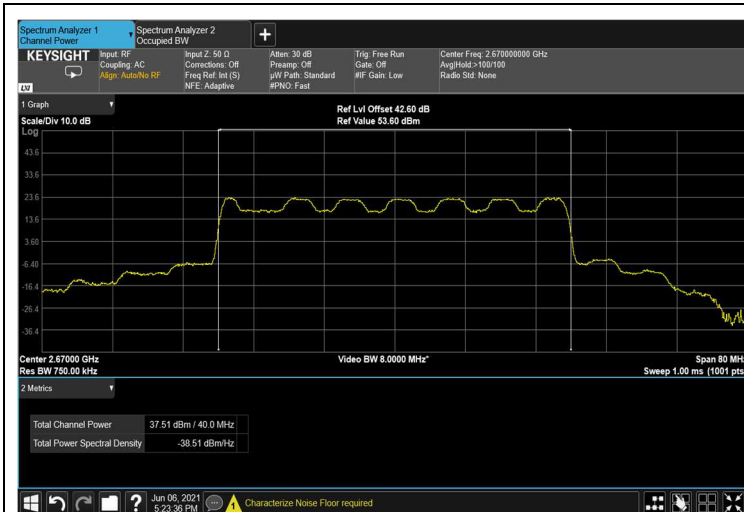

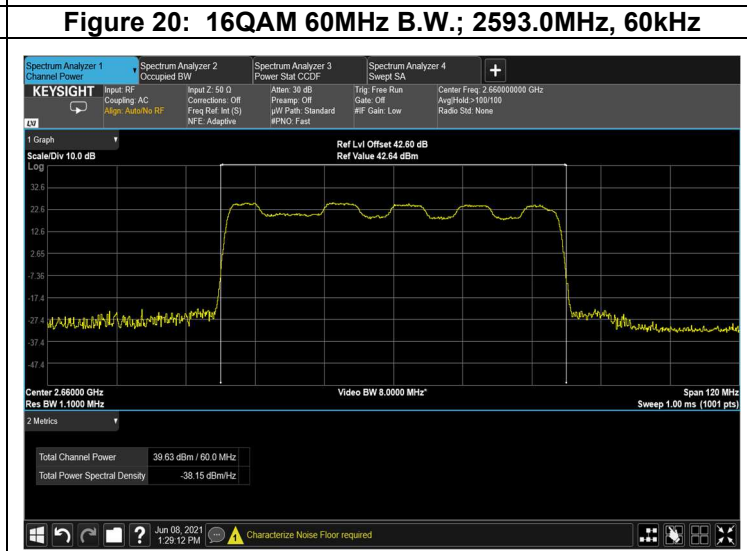
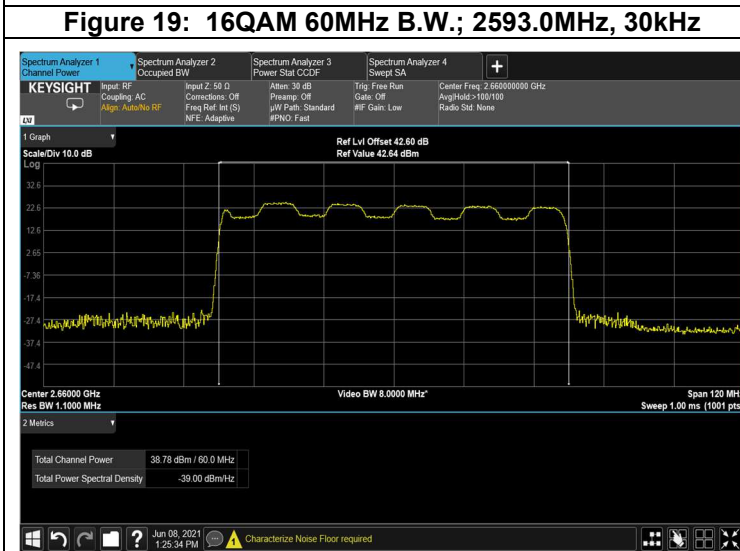
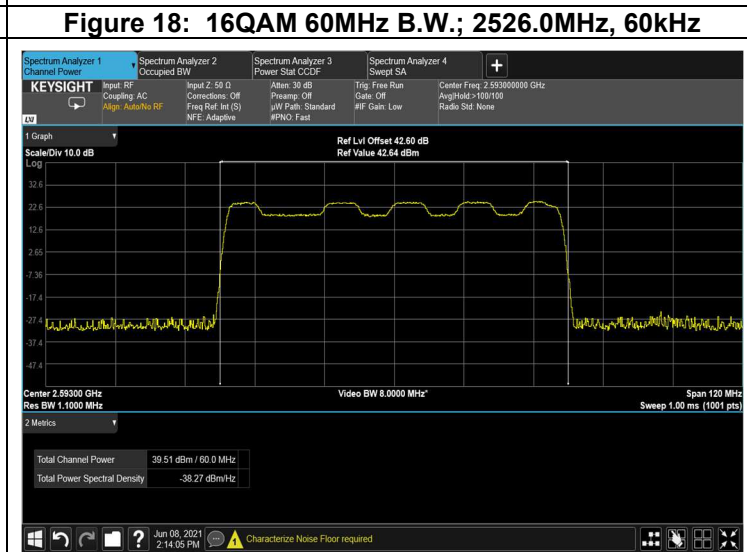
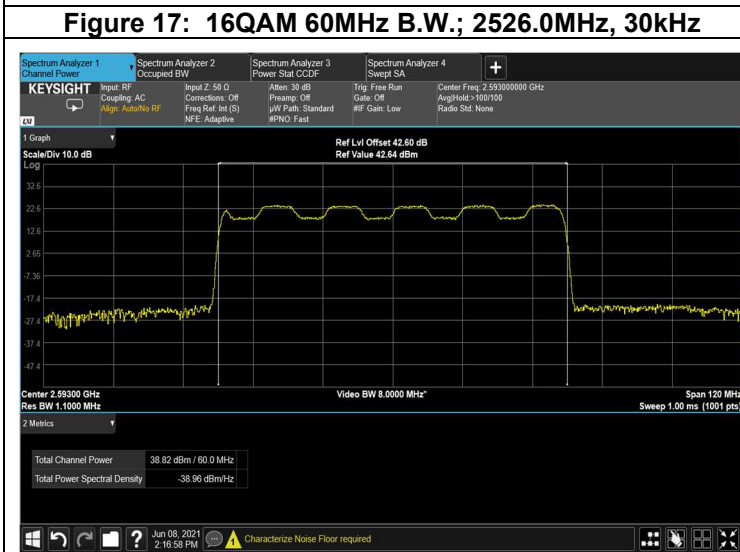
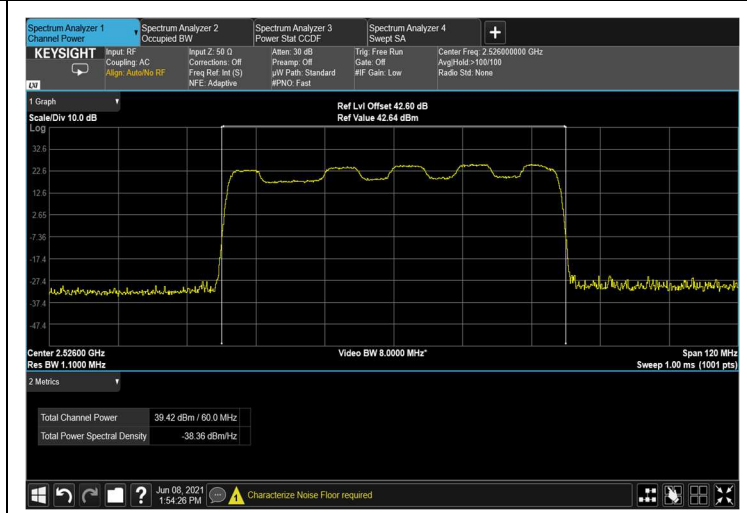
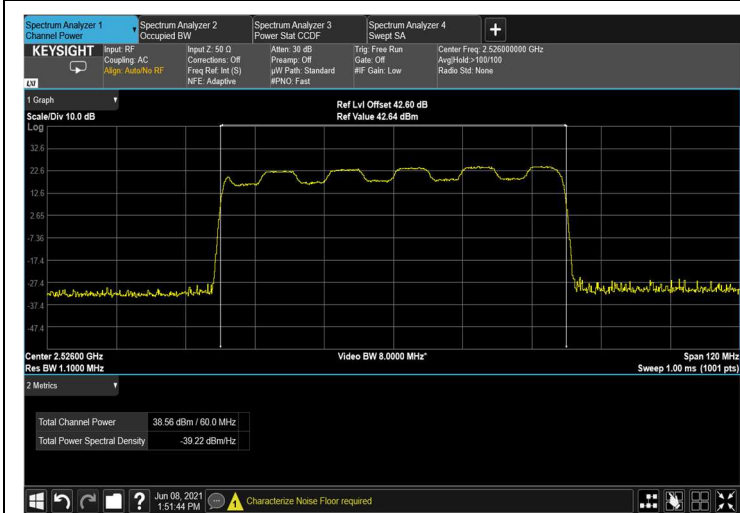



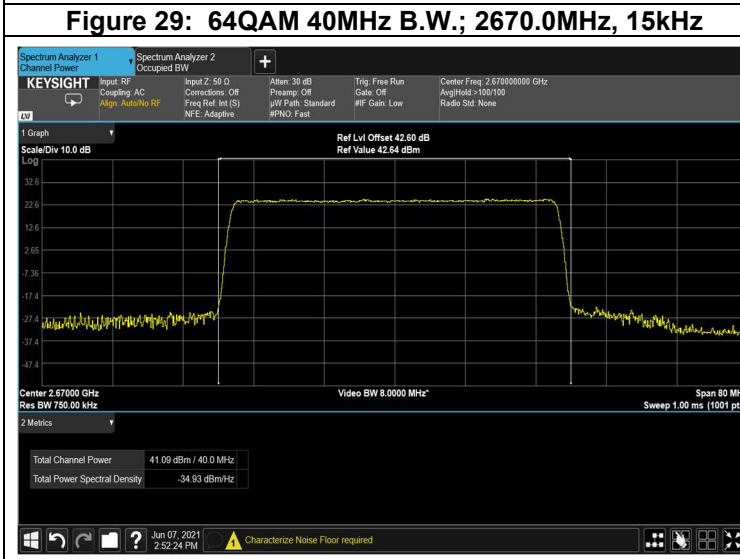
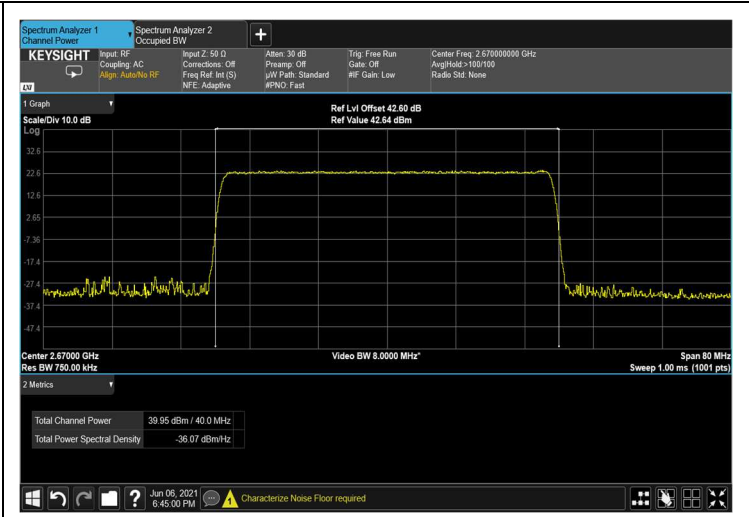

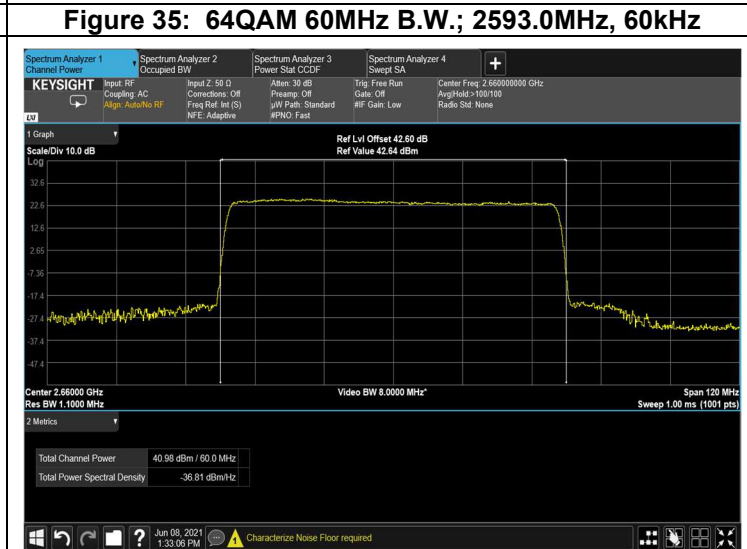
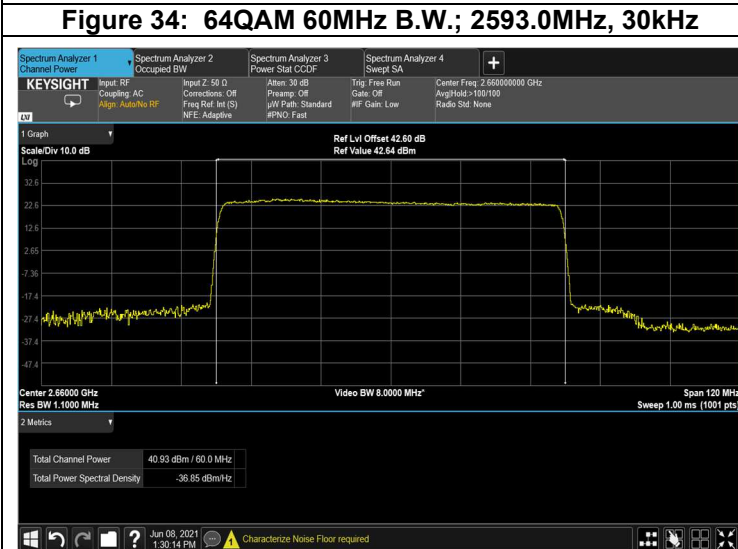
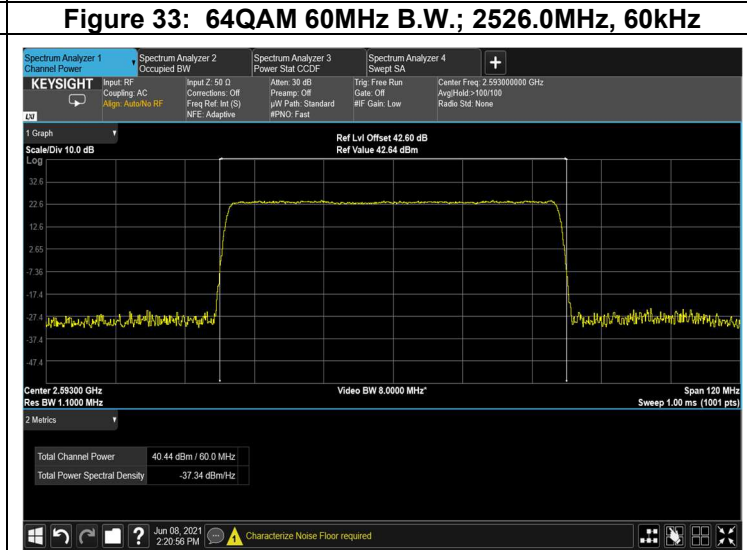
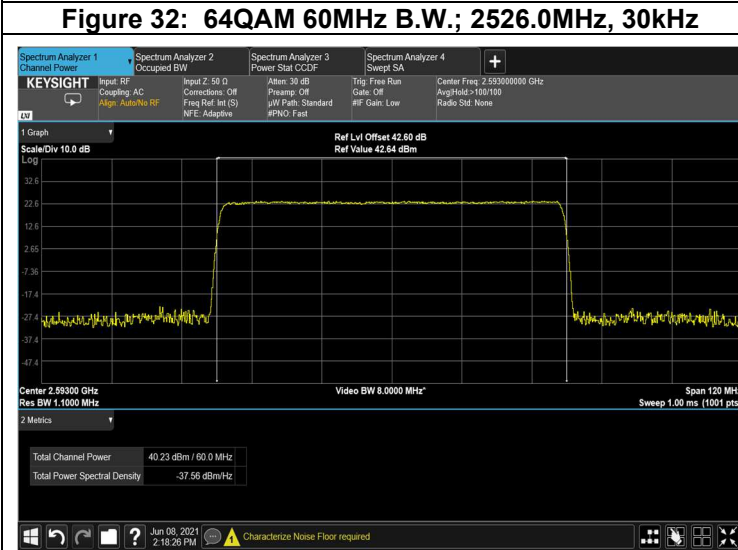
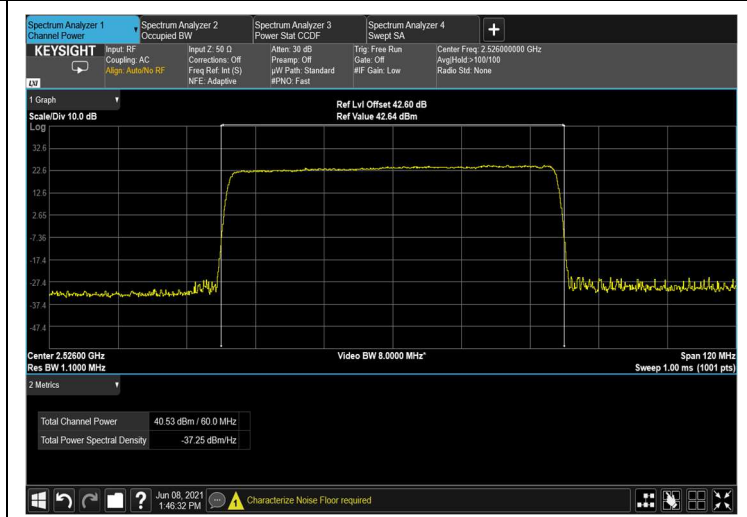



Figure 38: 256QAM 40MHz B.W.; 2516.0MHz, 15kHz



Figure 39: 256QAM 40MHz B.W.; 2516.0MHz, 30kHz

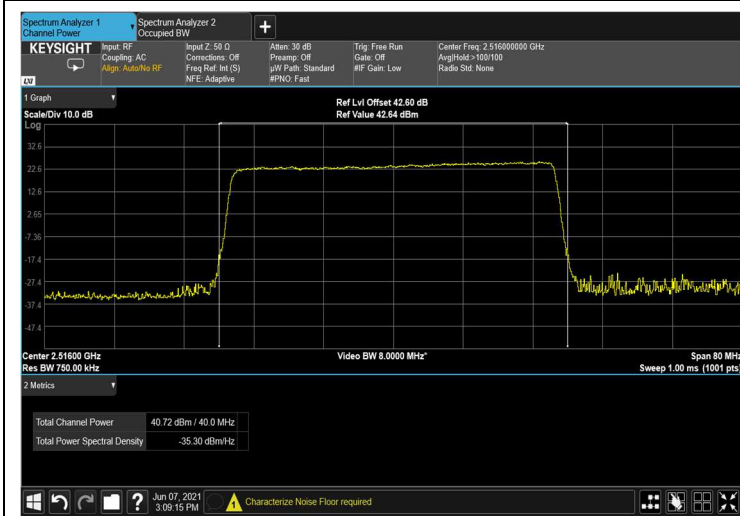

Figure 40: 256QAM 40MHz B.W.; 2516.0MHz, 60kHz

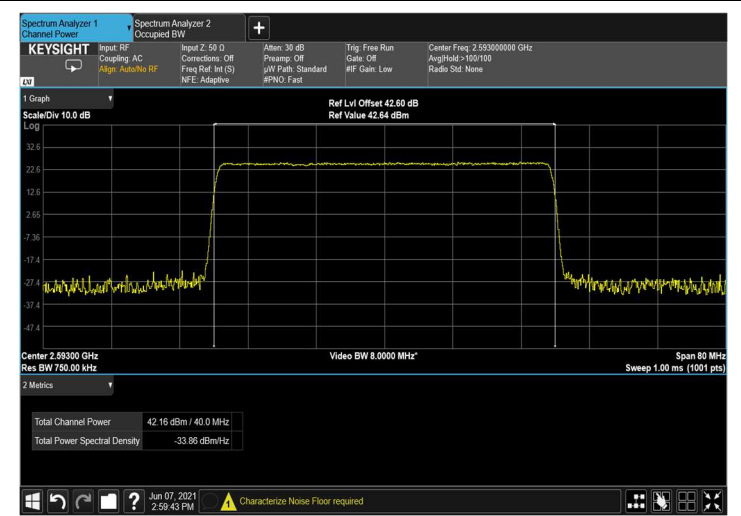

Figure 41: 256QAM 40MHz B.W.; 2593.0MHz, 15kHz



Figure 42: 256QAM 40MHz B.W.; 2593.0MHz, 30kHz



Figure 43: 256QAM 40MHz B.W.; 2593.0MHz, 60kHz



Figure 44: 256QAM 40MHz B.W.; 2670.0MHz, 15kHz



Figure 45: 256QAM 40MHz B.W.; 2670.0MHz, 30kHz



Figure 46: 256QAM 40MHz B.W.; 2670.0MHz, 60kHz



Figure 47: 256QAM 60MHz B.W.; 2526.0MHz, 30kHz

Figure 48: 256QAM 60MHz B.W.; 2526.0MHz, 60kHz

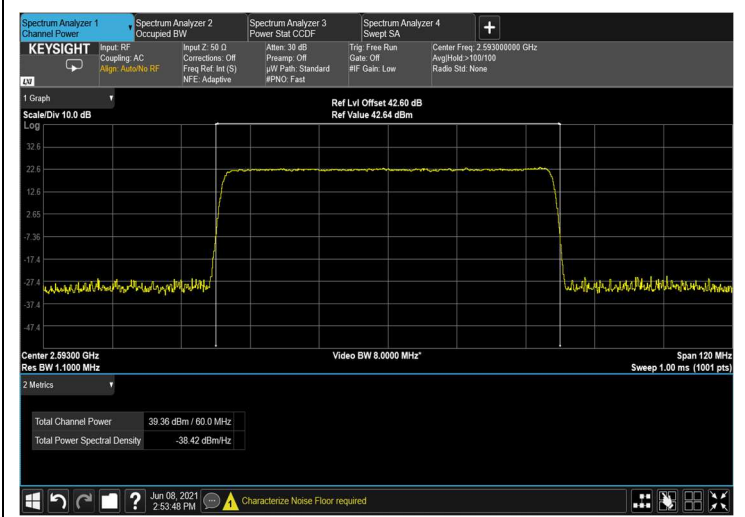

Figure 49: 256QAM 60MHz B.W.; 2593.0MHz, 30kHz

Figure 50: 256QAM 60MHz B.W.; 2593.0MHz, 60kHz



Figure 51: 256QAM 60MHz B.W.; 2660.0MHz, 30kHz

Figure 52: 256QAM 60MHz B.W.; 2660.0MHz, 60kHz

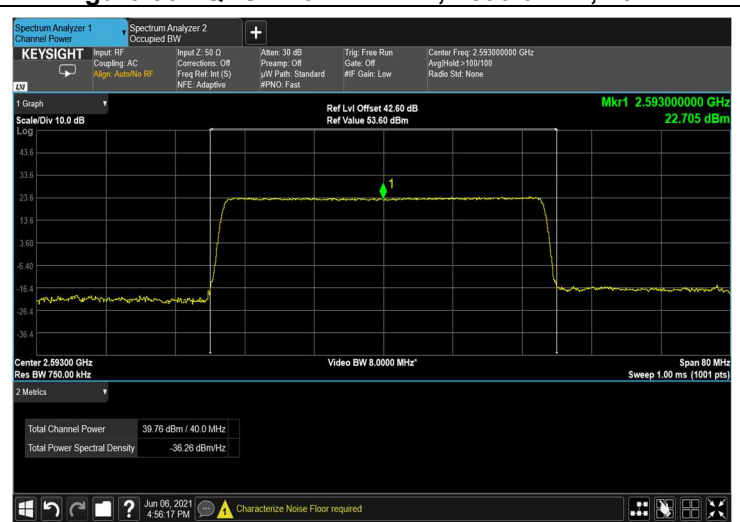
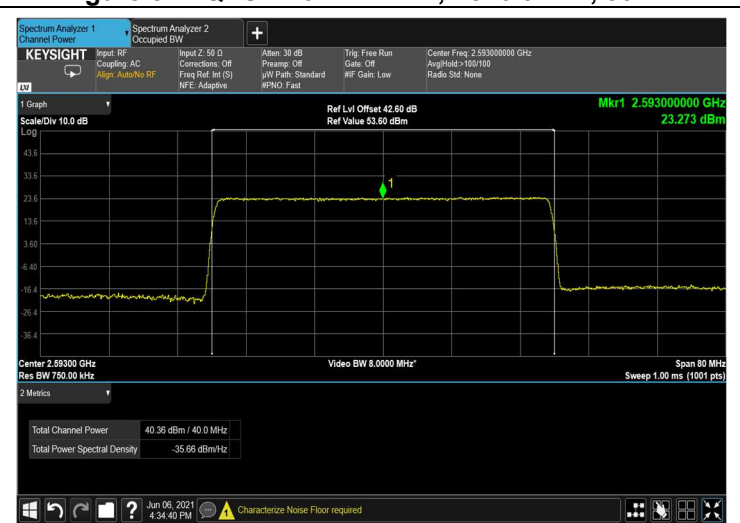



Figure 59: QPSK 40MHz B.W.; 2670.0MHz, 15kHz



Figure 60: QPSK 40MHz B.W.; 2670.0MHz, 30kHz



Figure 61: QPSK 40MHz B.W.; 2670.0MHz, 60kHz