



DATE: 24 February 2021

I.T.L. (PRODUCT TESTING) LTD.

FCC Radio Test Report

For

Corning Optical Communication Wireless

Equipment under test:

Corning Everon 6000 DAS - dMRU

dMRU Medium Power Modular Remote Unit

(PCS+G+BAND70)

Tested by:

M. Zohar

Approved by:

D. Shidlow

This report must not be reproduced, except in full, without the written permission of I.T.L. (Product Testing) Ltd.

This report relates only to items tested.



Measurement/Technical Report for Corning Optical Communication Wireless

Corning Everon 6000 DAS - dMRU dMRU Medium Power Modular Remote Unit (PCS+G+BAND70)

FCC ID: OJFDMRUDPAM19

This report concerns: Original Grant: X
 Class II change:
 Class I change:

Equipment type: Part 20 Industrial Booster (CMRS)

Limits used: 47CFR Parts 2; 24

Measurement procedure used is KDB 935210 D05 v01r04 April 2020 and ANSI IEEE C63.26-2015

Substitution Method used as in ANSI TIA-603-E-2016

Application for Certification
prepared by:
 R. Pinchuck
 ITL (Product Testing) Ltd.
 1 Bat Sheva St.
 Lod 7120101
 Israel
 e-mail davids@iltglobal.org

Applicant for this device:
(different from "prepared by")
Isaac Nissan
Corning Optical Communication Wireless
8253 1st Street
Vienna, VA 22812
U.S.A.
Tel: +1-703 855-1773
e-mail: NissanI@corning.com



TABLE OF CONTENTS

1.	GENERAL INFORMATION -----	5
1.1	Administrative Information	5
1.2	List of Accreditations	6
1.3	Product Description	7
1.4	Test Methodology	7
1.5	Test Facility	7
1.6	Measurement Uncertainty	7
2	SYSTEM TEST CONFIGURATION -----	8
2.1	Justification	8
2.2	EUT Exercise Software	8
2.3	Special Accessories	8
2.4	Equipment Modifications	8
2.5	Configuration of Tested System	9
3	TEST SET-UP PHOTOS -----	11
4	RF POWER OUTPUT - 5G -----	15
4.1	Test Specification	15
4.2	Test Procedure	15
4.3	Test Limit	15
4.4	Test Results	15
4.5	Test Equipment Used; RF Power Output	32
5	RF POWER OUTPUT – 3G AND 4G -----	33
5.1	Test Specification	33
5.2	Test Procedure	33
5.3	Test Limit	33
5.4	Test Results	33
5.5	Test Equipment Used; RF Power Output	40
6	BAND EDGE SPECTRUM - 5G -----	41
6.1	Test Specification	41
6.2	Test Procedure	41
6.3	Test Limit	41
6.4	Test Results	41
6.5	Test Equipment Used; Band Edge Spectrum	52
7	BAND EDGE SPECTRUM – 3G AND 4G -----	53
7.1	Test Specification	53
7.2	Test Procedure	53
7.3	Test Limit	53
7.4	Test Results	53
7.5	Test Equipment Used; Band Edge Spectrum	58
8	OCCUPIED BANDWIDTH - 5G -----	59
8.1	Test Specification	59
8.2	Test Procedure	59
8.3	Test Limit	59
8.4	Test Results	59
8.5	Test Equipment Used; Occupied Bandwidth	92
9	OCCUPIED BANDWIDTH – 3G AND 4G -----	93
9.1	Test Specification	93
9.2	Test Procedure	93
9.3	Test Limit	93
9.4	Test Results	93
9.5	Test Equipment Used; Occupied Bandwidth	107



10	SPURIOUS EMISSIONS AT ANTENNA TERMINALS - 5G	108
10.1	Test Specification	108
10.2	Test Procedure	108
10.3	Test Limit	108
10.4	Test Results	108
10.5	Test Equipment Used; Spurious Emissions at Antenna Terminals	133
11	SPURIOUS EMISSIONS AT ANTENNA TERMINALS 3G&4G&5G	134
11.1	Test Specification	134
11.2	Test Procedure	134
11.3	Test Limit	134
11.4	Test Results	134
11.5	Test Equipment Used; Spurious Emissions at Antenna Terminals	145
12	SPURIOUS RADIATED EMISSION 3G&4G&5G	146
12.1	Test Specification	146
12.2	Test Procedure	146
12.3	Test Limit	146
12.4	Test Results	147
12.5	Test Instrumentation Used; Radiated Measurements	149
13	OUT-OF-BAND REJECTION	150
13.1	Test Specification	150
13.2	Test Procedure	150
13.3	Test Limit	150
13.4	Test Results	150
13.5	Test Equipment Used; Out-of-Band Rejection	151
14	APPENDIX A - CORRECTION FACTORS	152
14.1	Correction factors for RF OATS Cable 35m	152
14.2	Correction factors for RF OATS Cable 10m	153
14.3	Correction factors for Horn Antenna	154
14.4	Correction factors for Horn Antenna	155
14.5	Correction factors for Log Periodic Antenna	156
14.6	Correction factors for Biconical Antenna	157
14.7	Correction factors for ACTIVE LOOP ANTENNA	158



1. General Information

1.1 Administrative Information

Manufacturer:	Corning Optical Communication Wireless
Manufacturer's Address:	8253 1st Street Vienna, VA 22812 U.S.A. Tel: +1-703 855-1773
Manufacturer's Representative:	Isaac Nissan
Equipment Under Test (E.U.T):	Corning Everon 6000 DAS - dMRU
Equipment Model No.:	dMRU Medium Power Modular Remote Unit
Equipment Serial No.:	Not Designated
Date of Receipt of E.U.T:	November 1, 2020
Start of Test:	November 2, 2020
End of Test:	February 23, 2021
Test Laboratory Location:	I.T.L (Product Testing) Ltd. 1 Batsheva St, Lod, Israel 7116002
Test Specifications:	FCC Parts 2; 24



1.2 List of Accreditations

The EMC laboratory of I.T.L. is accredited by/registered with the following bodies:

1. The American Association for Laboratory Accreditation (A2LA) (U.S.A.), Certificate No. 1152.01.
2. The Federal Communications Commission (FCC) (U.S.A.), FCC Designation Number is IL1005.
3. The Israel Ministry of the Environment (Israel), Registration No. 1104/01.
4. The Voluntary Control Council for Interference by Information Technology Equipment (VCCI) (Japan), Registration Numbers: C-20025, R-2729, T-20028, G-20068.
5. Department of Innovation, Science and Economic Development (ISED) Canada, CAB identifier: IL1002.

I.T.L. Product Testing Ltd. is accredited by the American Association for Laboratory Accreditation (A2LA) and the results shown in this test report have been determined in accordance with I.T.L.'s terms of accreditation unless stated otherwise in the report.



1.3 Product Description

DMRU - Digital Medium-power Remote Unit.

The MRU is a medium power modular remote antenna unit with a single antenna port.

The Output power for the lower bands: 600/700 MHz Low/700 MHz High/FirstNet, 800/850 MHz is 33 dBm and the output power for the medium bands EAWS, PCS, WCS and 2.5GHz TDD is 37dBm.

The MRU modular structure and integrated high-performance cavity based multiplexing functionalities, enable setups of up to 6 RF modules, for a variety of licensed frequency bands within a single cabinet.

The MRU also provides CBRS/C-Band ready RF interface for future field upgrades.

1.4 Test Methodology

Both conducted and radiated testing were performed according to the procedures in KDB 935210 D05 v01r03 April 2019 and ANSI/TIA-603-E-2016. Radiated testing was performed at an antenna to EUT distance of 3 meters.

1.5 Test Facility

Both conducted and radiated emissions tests were performed at I.T.L.'s testing facility in Lod, Israel. I.T.L.'s EMC Laboratory is accredited by A2LA, certificate No. 1152.01 and its FCC Designation Number is IL1005.

1.6 Measurement Uncertainty

Conducted Emission

Conducted Emission (CISPR 11, EN 55011, CISPR 22, EN 55022, ANSI C63.4)

0.15 – 30 MHz:

Expanded Uncertainty (95% Confidence, K=2):
 ± 3.44 dB

Radiated Emission

Radiated Emission (CISPR 11, EN 55011, CISPR 22, EN 55022, ANSI C63.4) for open site:

30-1000MHz:

Expanded Uncertainty (95% Confidence, K=2):
 ± 4.96 dB

1 GHz to 6 GHz

Expanded Uncertainty (95% Confidence, K=2):
 ± 5.19 dB

>6 GHz

Expanded Uncertainty (95% Confidence, K=2):
 ± 5.51 dB



2 System Test Configuration

2.1 *Justification*

The dMRU is a repeater supporting a broad range of cellular generations: 3G, 4G and 5G in the PCS+G+BAND70 band.

Evaluation was performed at the low, mid and high channels each one defined per the operation BW.

Evaluation was performed at 115VAC as the nominal power source.

Conducted tests were performed with an external attenuator connected to the spectrum analyzer.

Radiated emission tests were performed with a 50Ω termination connected to the E.U.T output terminal.

2.2 *EUT Exercise Software*

The Element Management System ver. 1.4 used for commands delivery. These commands are used to enable/disable the EUT transmission. SW Ver. is 1.4 .

2.3 *Special Accessories*

No special accessories were needed in order to achieve compliance.

2.4 *Equipment Modifications*

No modifications were necessary in order to achieve compliance.

2.5 Configuration of Tested System

Product Name	Corning Everon 6000 DAS - dMRU
Model Name	dMRU medium power modular remote unit (PCS+G+BAND70)
Working voltage	48 VDC, 115/230 VAC
Mode of operation	Repeater Booster supporting 3G, 4G and 5G
Modulations	3G: WCDMA 4G: 16QAM, 64QAM, QPSK 5G: 16QAM, 64QAM, 256QAM, QPSK
Frequency Range	PCS+G+BAND70 (DL: 1930-1995, UL:1850-1915)
Transmit power	~38 dBm (Max) per band
DATA rate	N/A
Modulation BW	5; 10; 15 MHZ
DC Voltage applied to final RF stage band board (Driver and PA)	28.5V
DC Current applied to final RF stage band board (Driver and PA)	1.2A

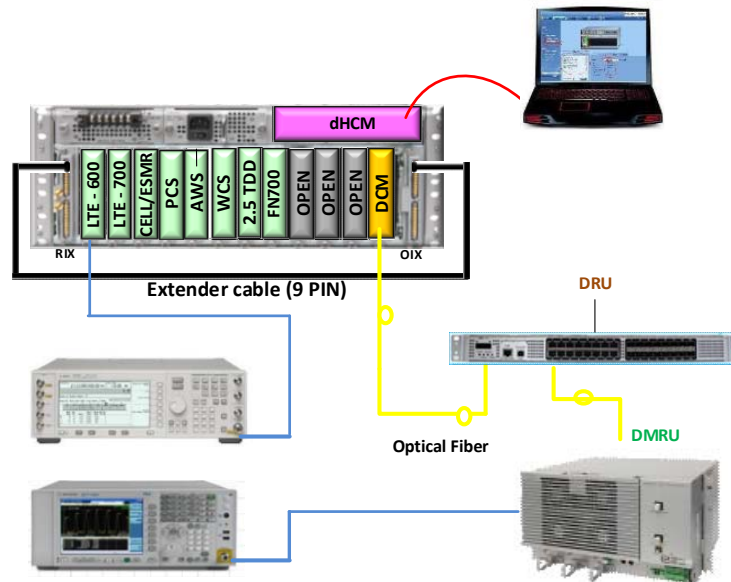

Figure 1. Conducted Test Set-Up

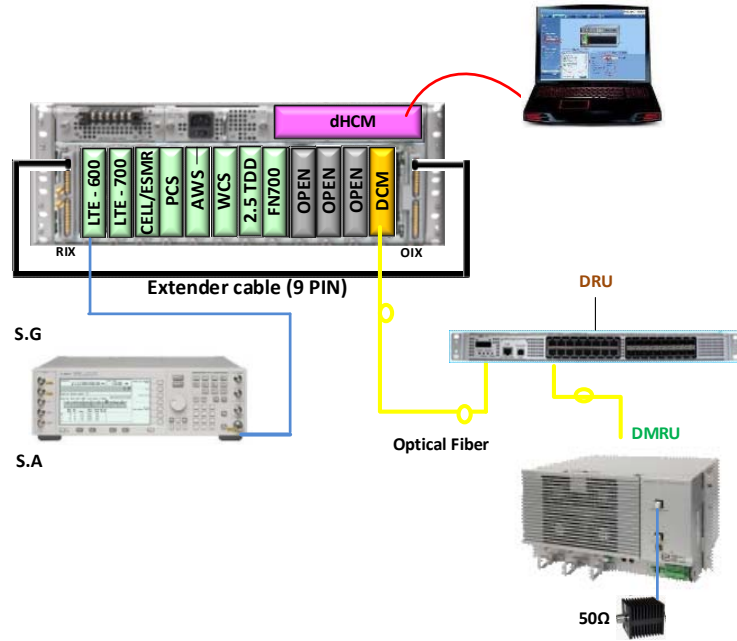

Figure 2. Radiated Test Set-Up

3 Test Set-Up Photos



Figure 3. Conducted Emission From Antenna Port Tests



Figure 4. Radiated Emission Test 9kHz - 30MHz



Figure 5. Radiated Emission Test 30 - 200 MHz



Figure 6. Radiated Emission Test 200 - 1000MHz



Figure 7. Radiated Emission Test 1.0 - 18.0GHz



Figure 8. Radiated Emission Test 18.0-20.0GHz



4 RF Power Output - 5G

4.1 Test Specification

FCC Part 24, Subpart E (24.232)

4.2 Test Procedure

(Temperature (22°C)/ Humidity (36%RH))

The E.U.T. antenna terminal was connected to the Spectrum Analyzer through an external attenuator (41.6 dB) and an appropriate coaxial cable. Special attention was taken to prevent Spectrum Analyzer RF input overload.

4.3 Test Limit

Peak Power Output must not exceed 1640W (62.1 dBm).

4.4 Test Results

JUDGEMENT: Passed

See additional information in Table 1 to Table 4 and Figure 9 to Figure 80.



Modulation	Bandwidth	Sub Carrier	Operation Frequency	Reading
	(MHz)	(kHz)	(MHz)	(dBm)
16QAM	5	15	1932.5	37.56
		30		37.24
		15	1962.5	37.10
		30		37.10
		15	1992.5	37.12
		30		37.68
	10	15	1935.0	37.15
		30		37.95
		15	1962.5	35.53
		30		38.72
		15	1990.0	38.30
		30		38.35
	15	15	1937.5	38.55
		30		38.70
		15	1962.5	38.24
		30		38.38
		15	1987.5	37.39
		30		37.81

Table 1 RF Power Output 16QAM



Modulation	Bandwidth	Sub Carrier	Operation Frequency	Reading
	(MHz)	(kHz)	(MHz)	(dBm)
64QAM	5	15	1932.5	37.04
		30		37.17
		15	1962.5	37.08
		30		36.78
		15	1992.5	37.35
		30		37.03
	10	15	1935.0	37.78
		30		37.45
		15	1962.5	38.70
		30		38.86
		15	1990.0	38.46
		30		38.50
	15	15	1937.5	38.82
		30		38.28
		15	1962.5	38.37
		30		38.25
		15	1987.5	37.94
		30		37.90

Table 2 RF Power Output 64QAM



Modulation	Bandwidth	Sub Carrier	Operation Frequency	Reading
	(MHz)	(kHz)	(MHz)	(dBm)
256QAM	5	15	1932.5	36.97
		30		37.29
		15	1962.5	38.20
		30		36.96
		15	1992.5	37.48
		30		38.82
	10	15	1935.0	37.82
		30		37.25
		15	1962.5	38.68
		30		38.79
		15	1990.0	37.07
		30		38.50
	15	15	1937.5	38.75
		30		38.49
		15	1962.5	39.01
		30		38.97
		15	1987.5	37.99
		30		37.97

Table 3 RF Power Output 256QAM



Modulation	Bandwidth	Sub Carrier	Operation Frequency	Reading
	(MHz)	(kHz)	(MHz)	(dBm)
QPSK	5	15	1932.5	36.79
		30		36.55
		15	1962.5	37.24
		30		37.07
		15	1992.5	37.65
		30		37.33
	10	15	1935.0	37.52
		30		38.24
		15	1962.5	38.67
		30		38.80
		15	1990.0	38.25
		30		38.35
	15	15	1937.5	38.79
		30		38.74
		15	1962.5	38.02
		30		38.35
		15	1987.5	37.03
		30		37.59

Table 4 RF Power Output QPSK

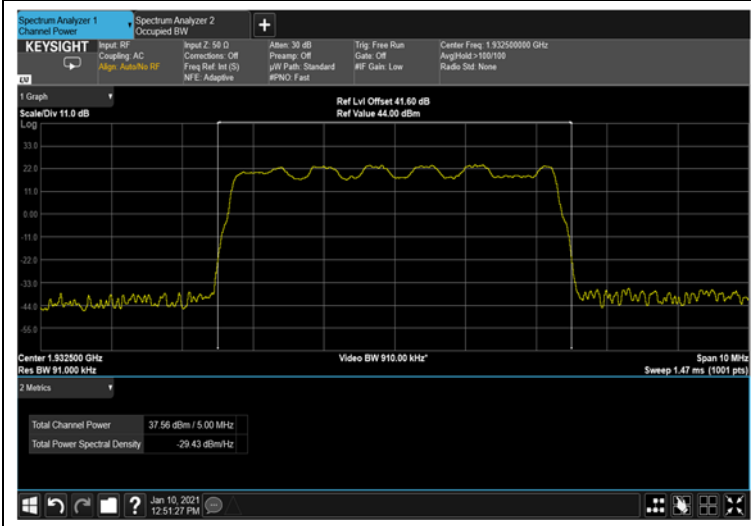

Figure 9: 16QAM 5MHz B.W.; 1932.5MHz, 15kHz



Figure 10: 16QAM 5MHz B.W.; 1932.5MHz, 30kHz

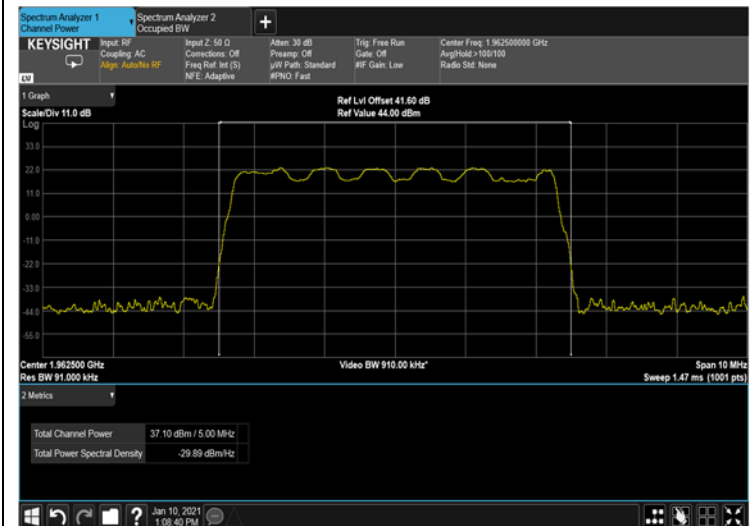

Figure 11: 16QAM 5MHz B.W.; 1962.5MHz, 15kHz

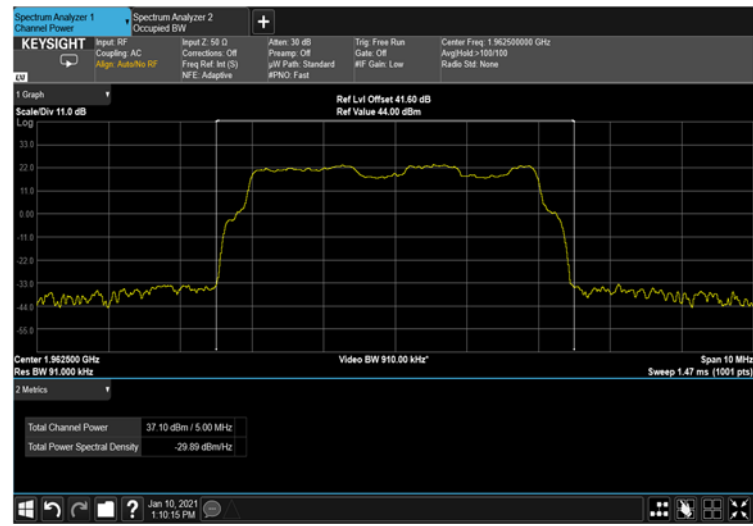

Figure 12: 16QAM 5MHz B.W.; 1962.5MHz, 30kHz

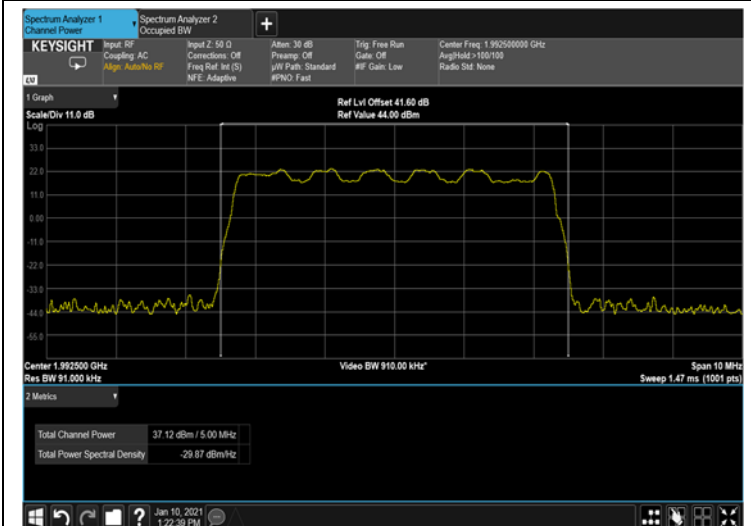

Figure 13: 16QAM 5MHz B.W.; 1992.5MHz, 15kHz

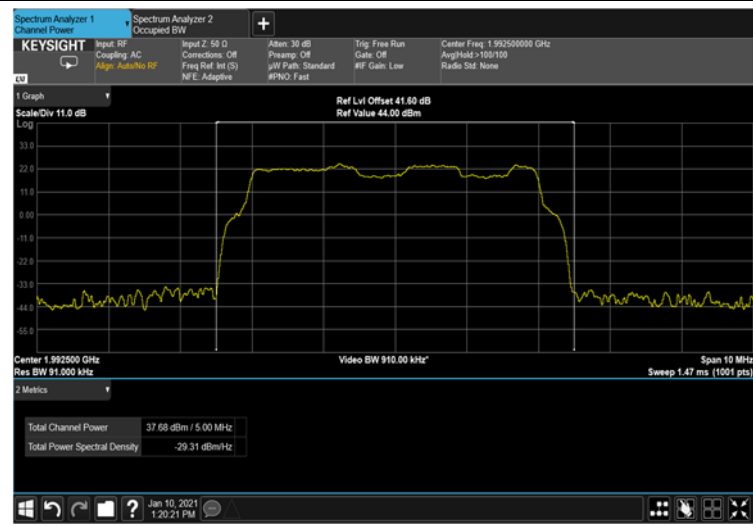

Figure 14: 16QAM 5MHz B.W.; 1992.5MHz, 30kHz

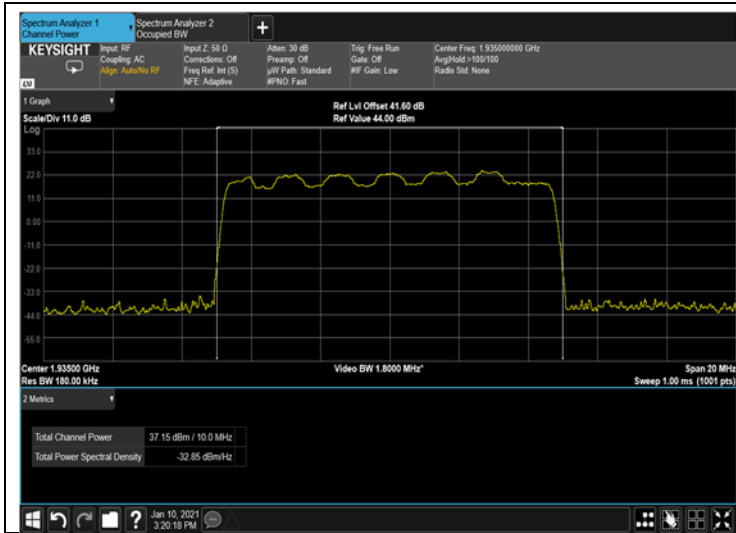

Figure 15: 16QAM 10MHz B.W.; 1935MHz, 15kHz

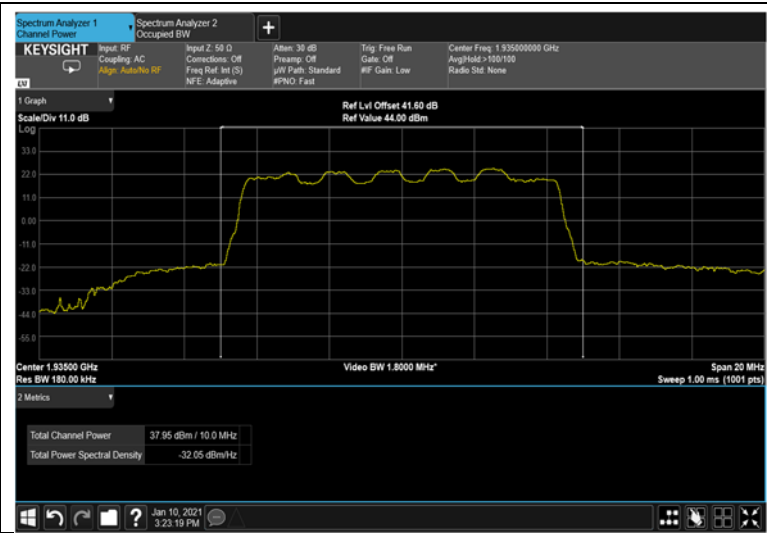

Figure 16: 16QAM 10MHz B.W.; 1935MHz, 30kHz

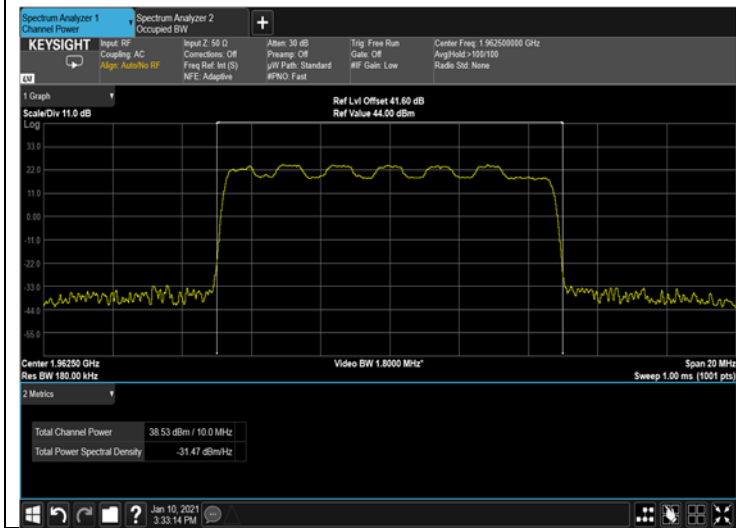

Figure 17: 16QAM 10MHz B.W.; 1962.5MHz, 15kHz

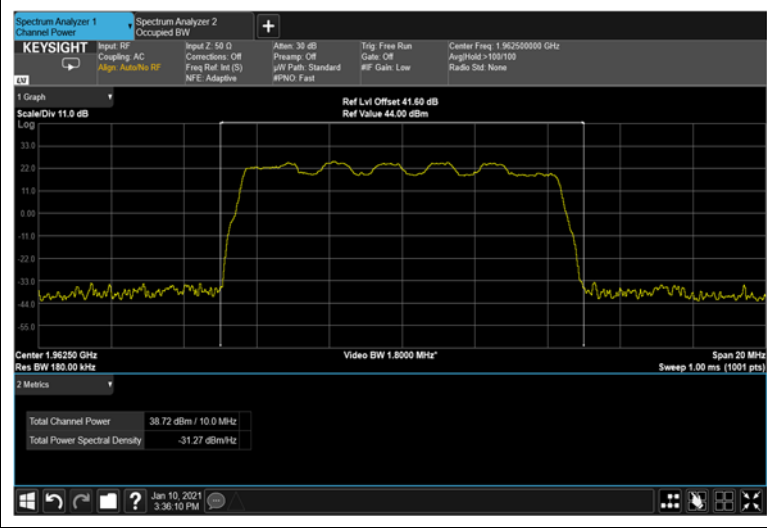

Figure 18: 16QAM 10MHz B.W.; 1962.5MHz, 30kHz

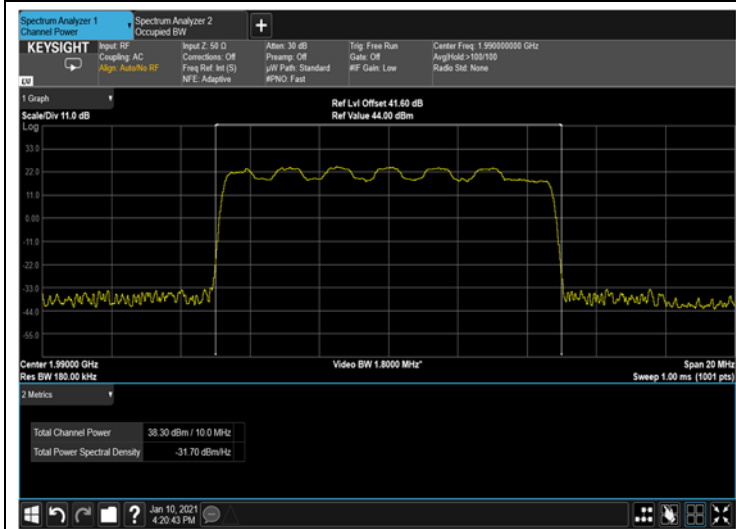

Figure 19: 16QAM 10MHz B.W.; 1990MHz, 15kHz

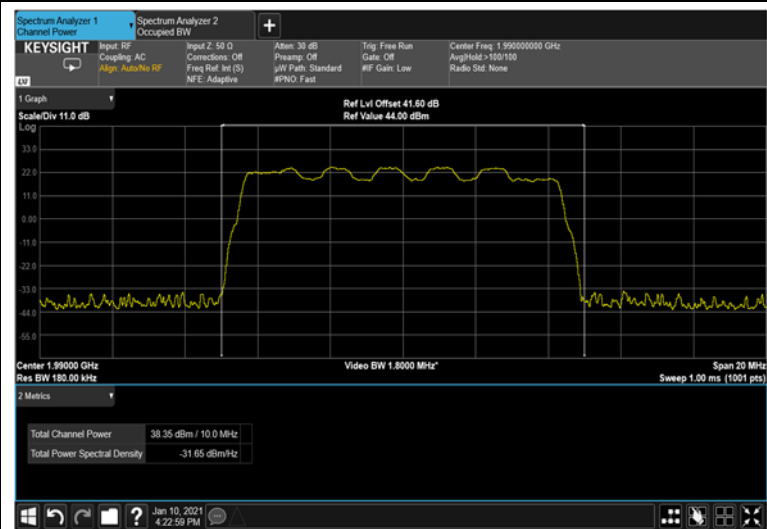

Figure 20: 16QAM 10MHz B.W.; 1990MHz, 30kHz

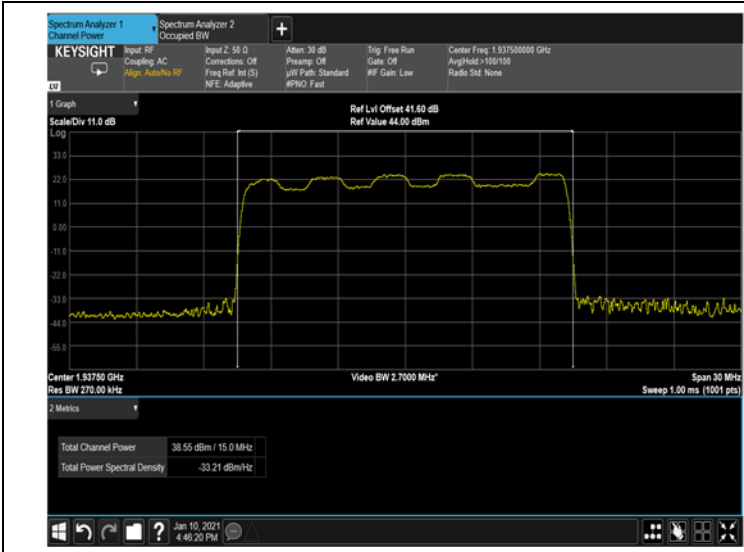

Figure 21: 16QAM 15MHz B.W.; 1937.5MHz, 15kHz



Figure 22: 16QAM 15MHz B.W.; 1937.5MHz, 30kHz

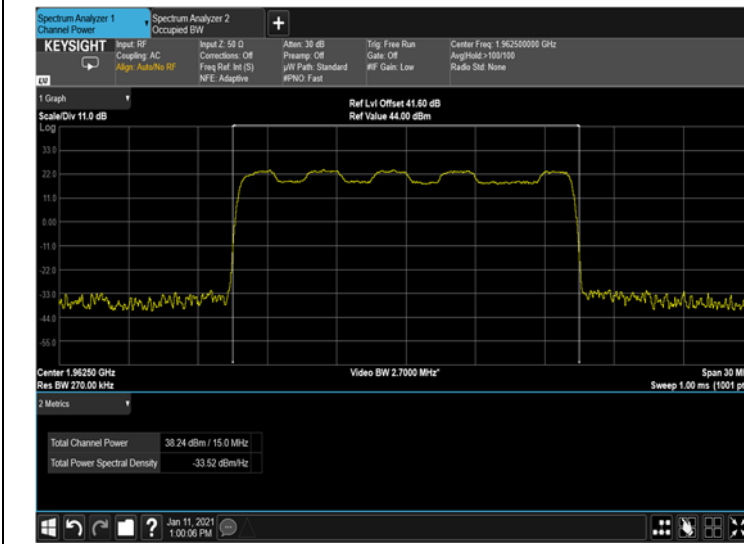

Figure 23: 16QAM 15MHz B.W.; 1962.5MHz, 15kHz

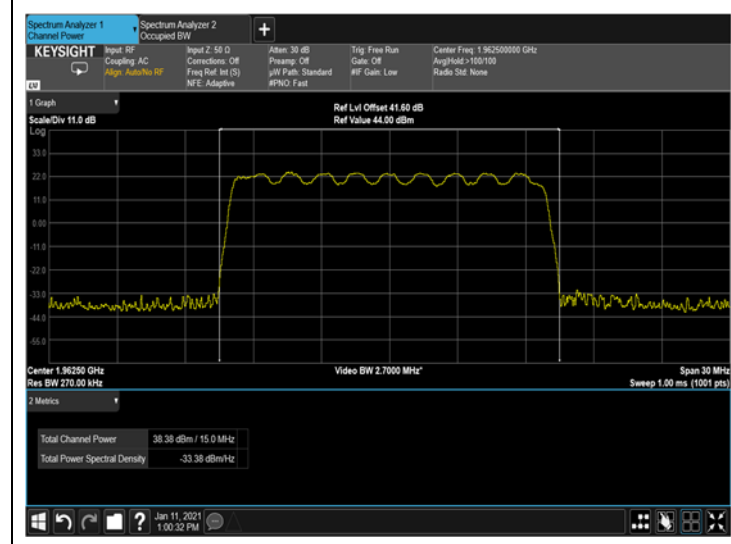

Figure 24: 16QAM 15MHz B.W.; 1962.5MHz, 30kHz

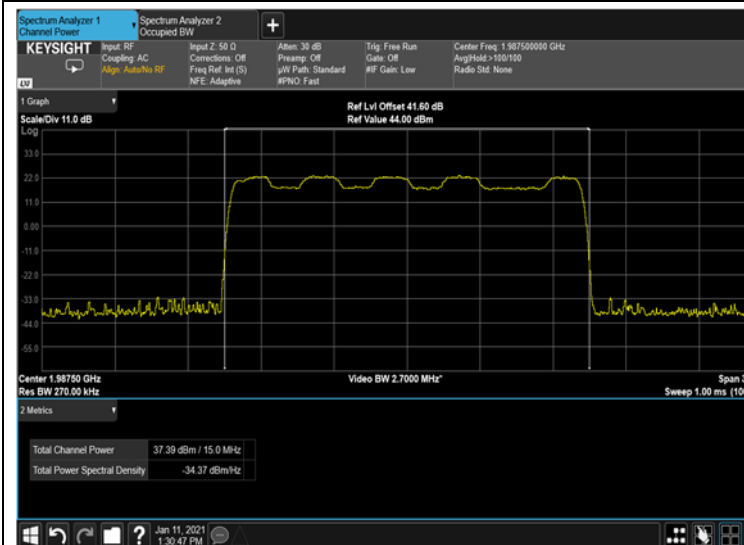

Figure 25: 16QAM 15MHz B.W.; 1987.5MHz, 15 kHz

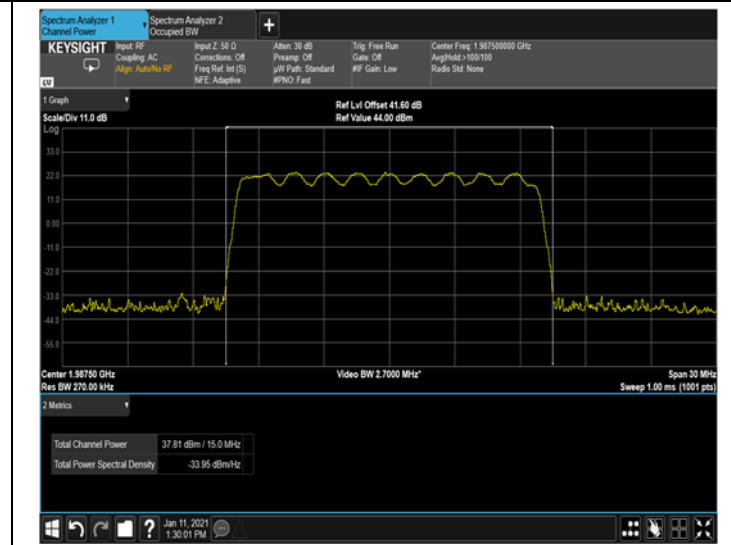
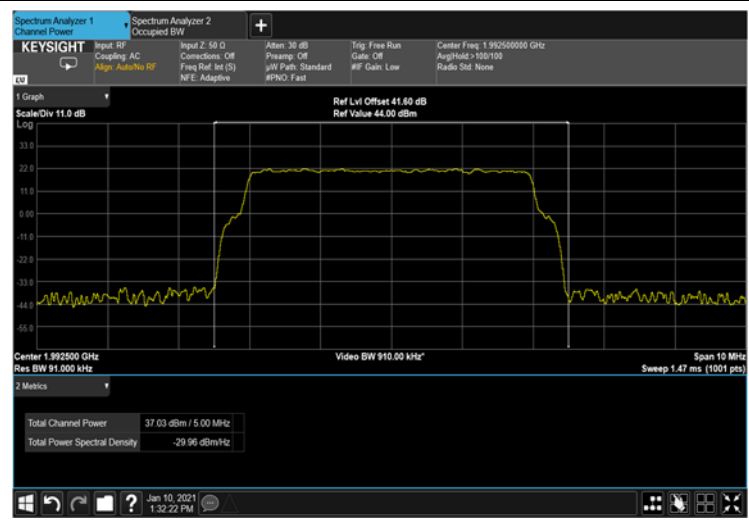
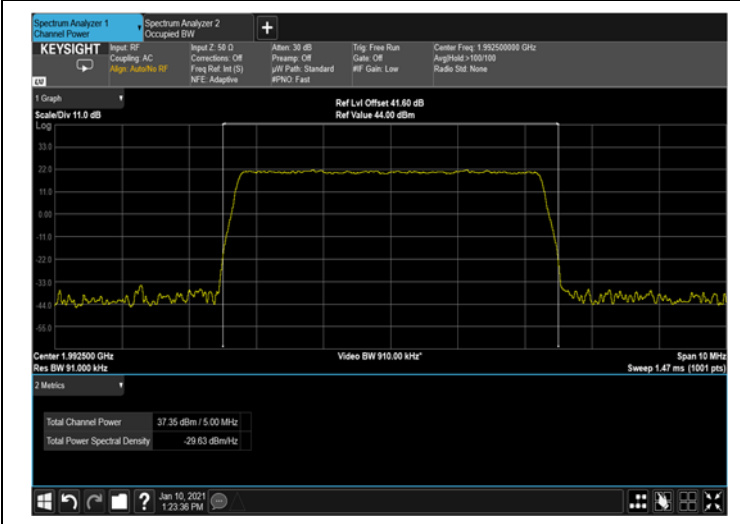
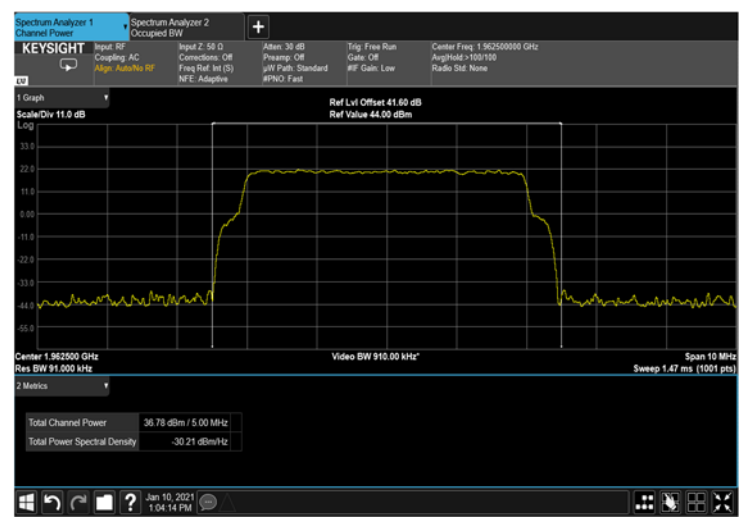
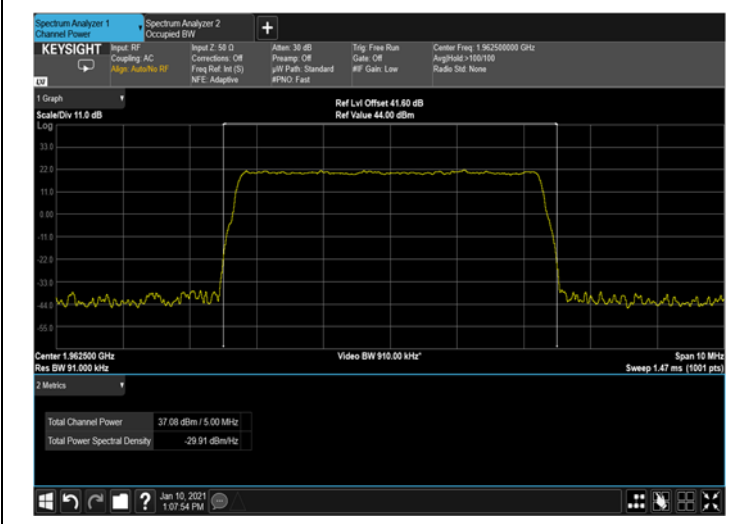
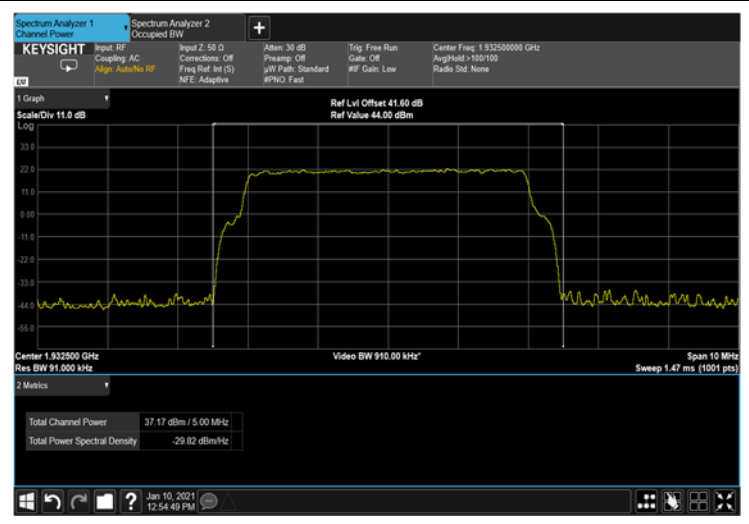

Figure 26: 16QAM 15MHz B.W.; 1987.5MHz, 30 kHz



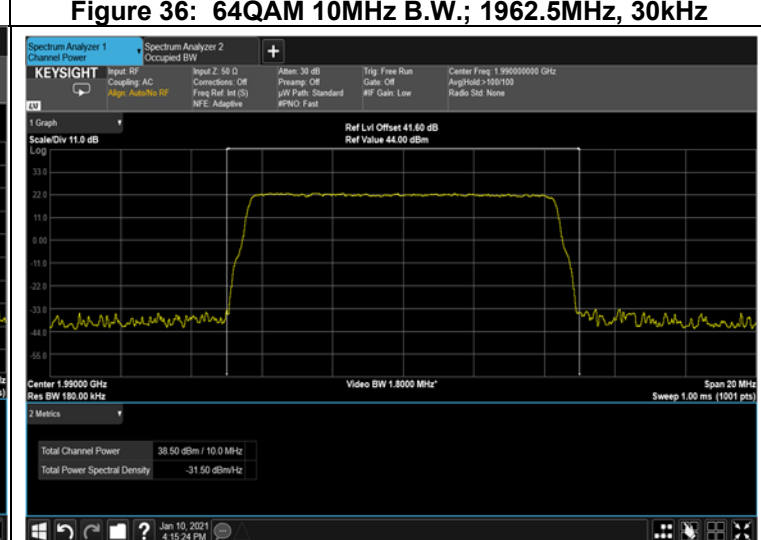
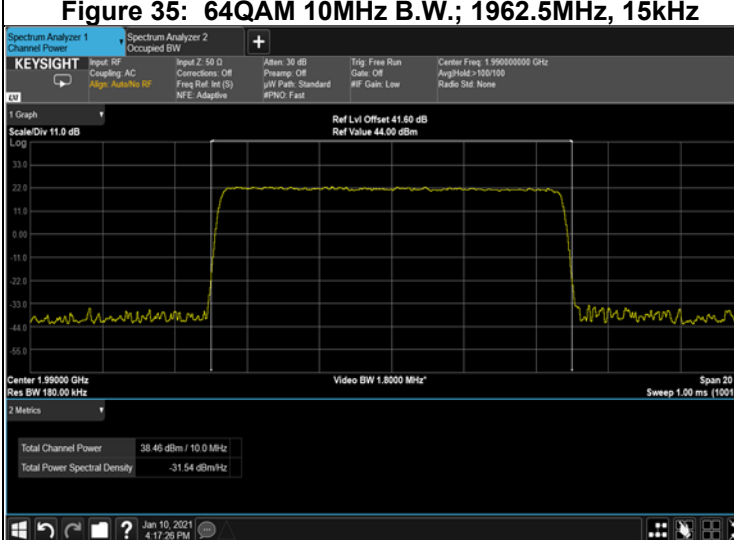
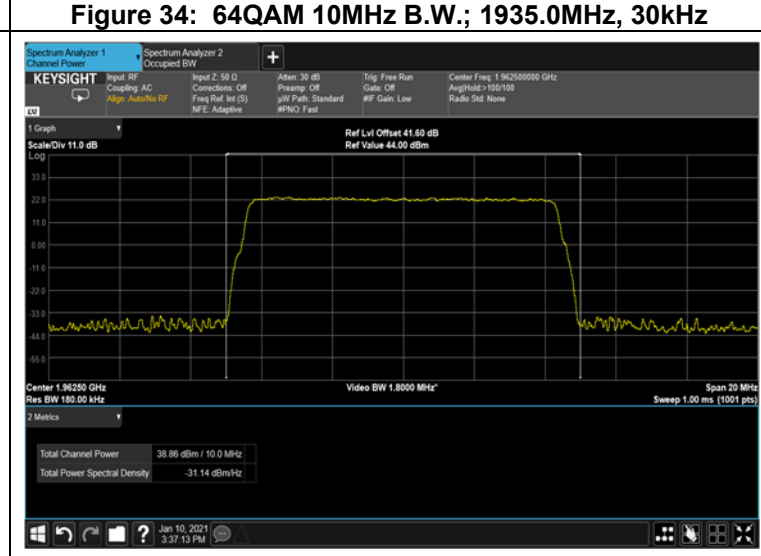
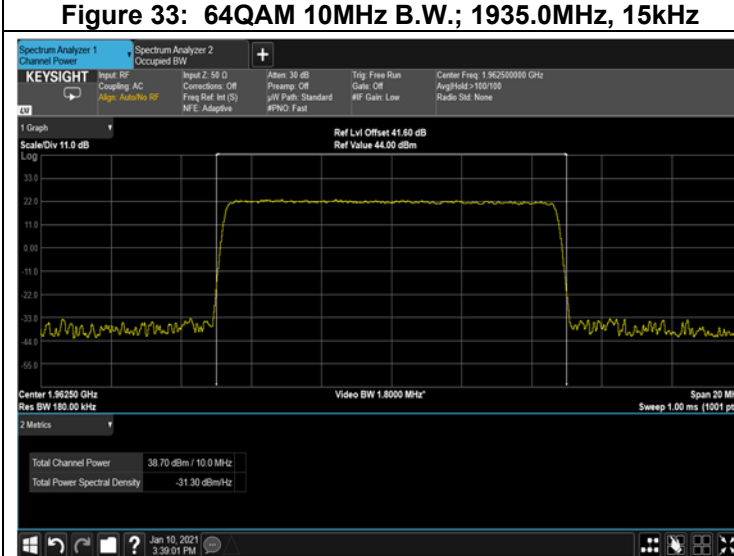
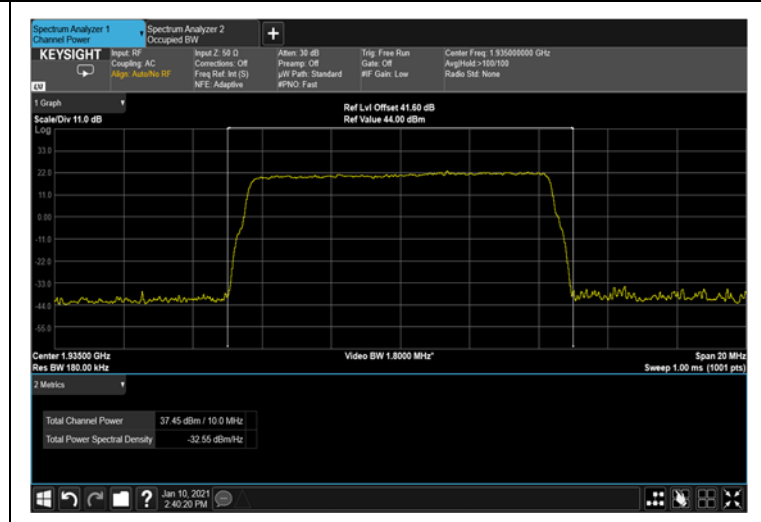

Figure 37: 64QAM 10MHz B.W.; 1990MHz, 15kHz

Figure 38: 64QAM 10MHz B.W.; 1990MHz, 30kHz

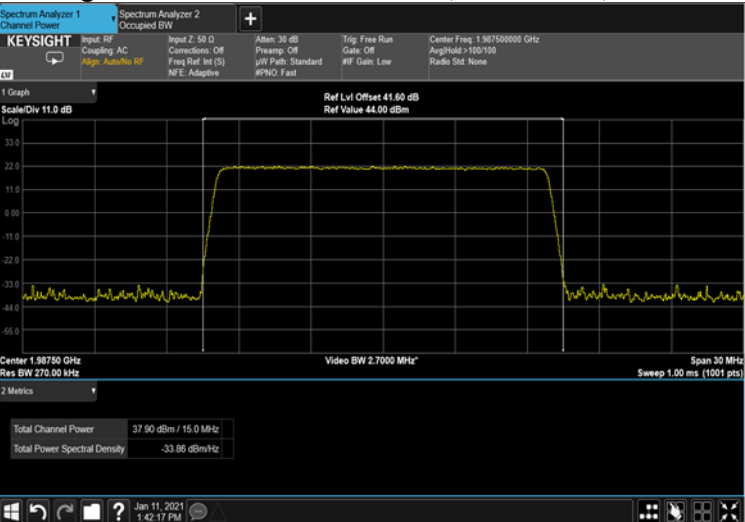
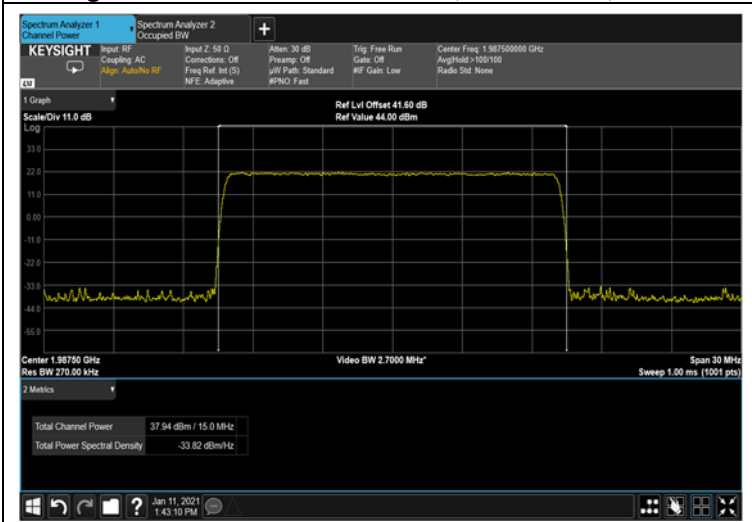
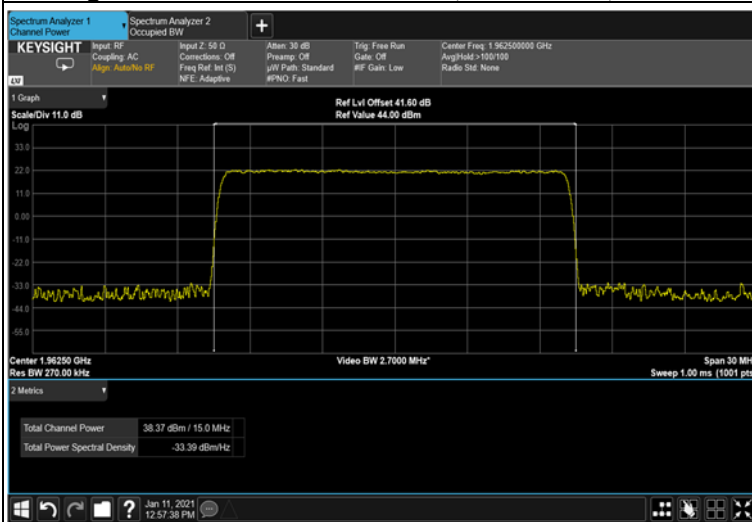
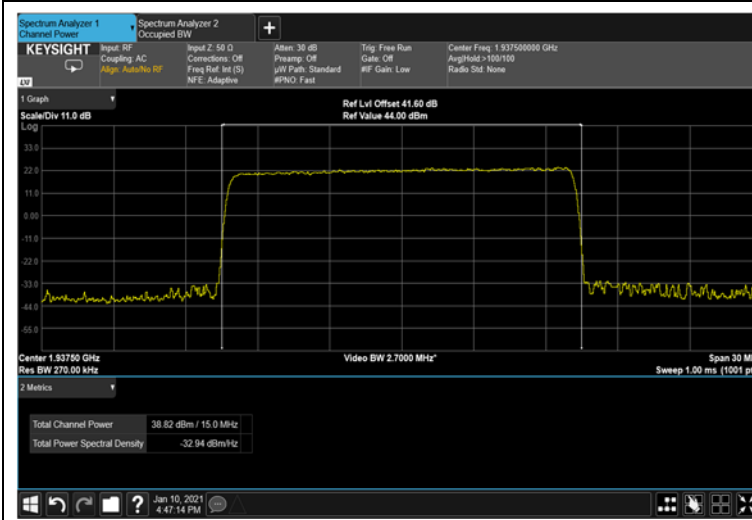



Figure 45: 256QAM 5MHz B.W.; 1932.5MHz, 15kHz



Figure 46: 256QAM 5MHz B.W.; 1932.5MHz, 30kHz



Figure 47: 256QAM 5MHz; 1962.5MHz B.W, 15kHz

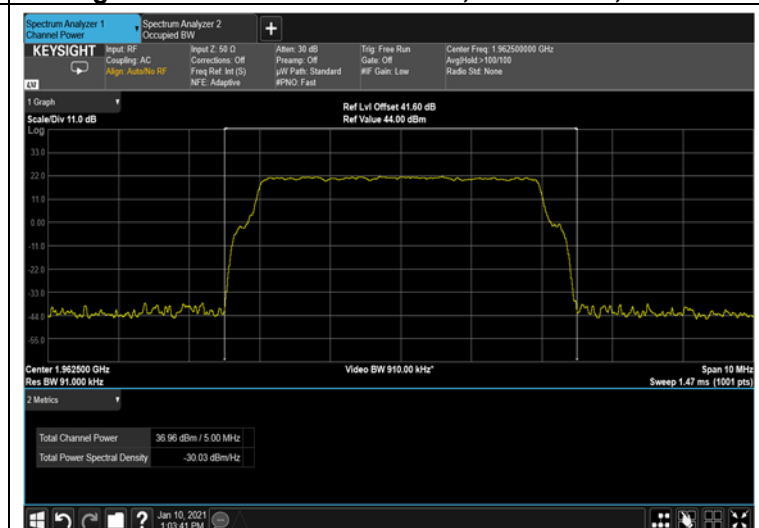

Figure 48: 256QAM 5MHz; 1962.5MHz B.W, 30kHz

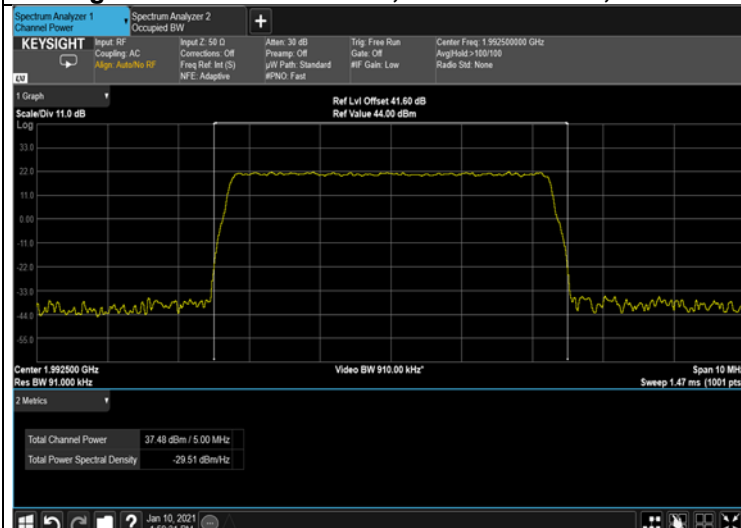

Figure 49: 256QAM 5MHz B.W.; 1992.5MHz, 15kHz

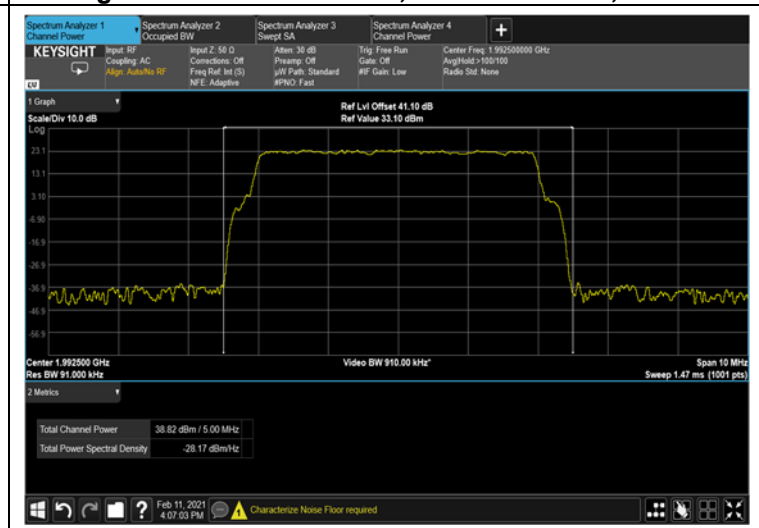

Figure 50: 256QAM 5MHz B.W.; 1992.5MHz, 30kHz



Figure 51: 256QAM 10MHz B.W.; 1935MHz, 15kHz

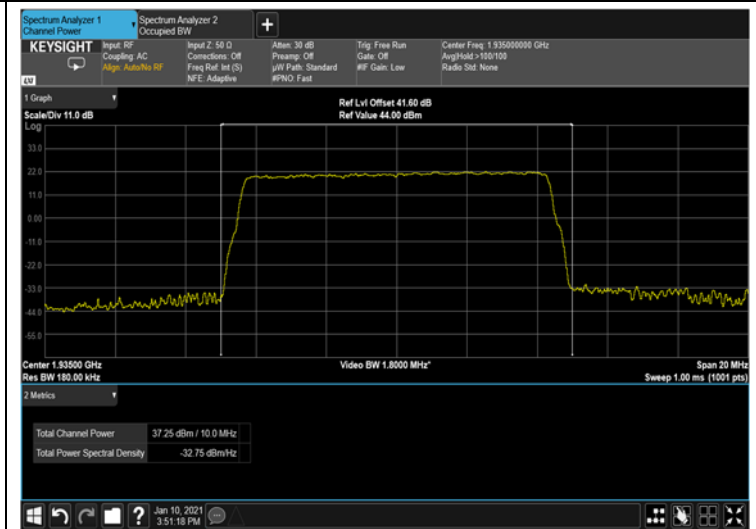

Figure 52: 256QAM 10MHz B.W.; 1935MHz, 30kHz

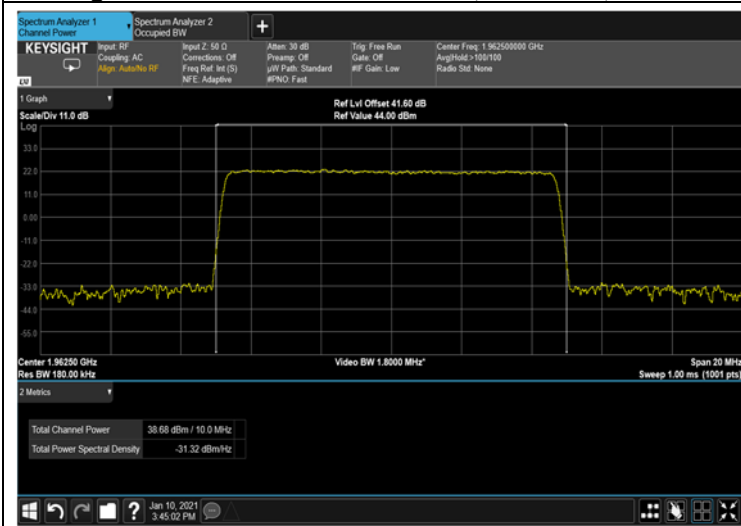

Figure 53: 256QAM 10MHz B.W.; 1962.5MHz, 15kHz

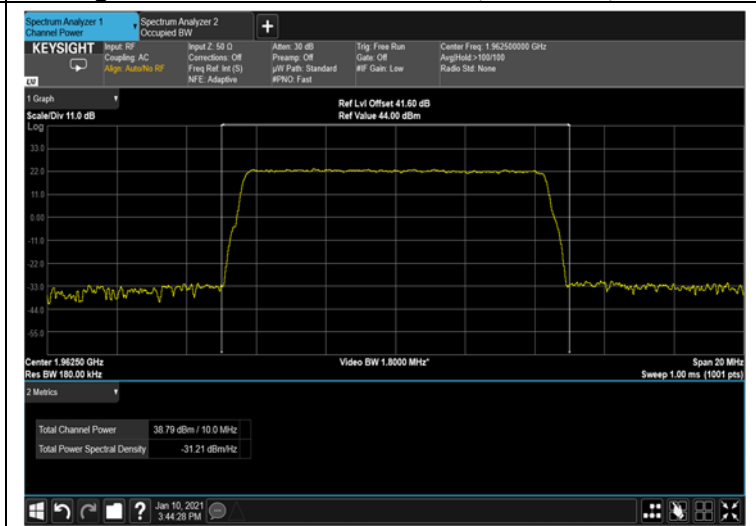

Figure 54: 256QAM 10MHz B.W.; 1962.5MHz, 30kHz

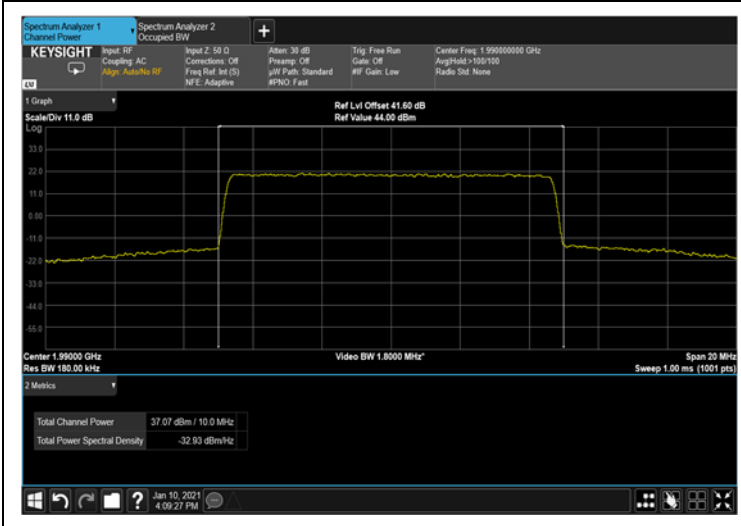

Figure 55: 256QAM 10MHz B.W.; 1990MHz, 15kHz

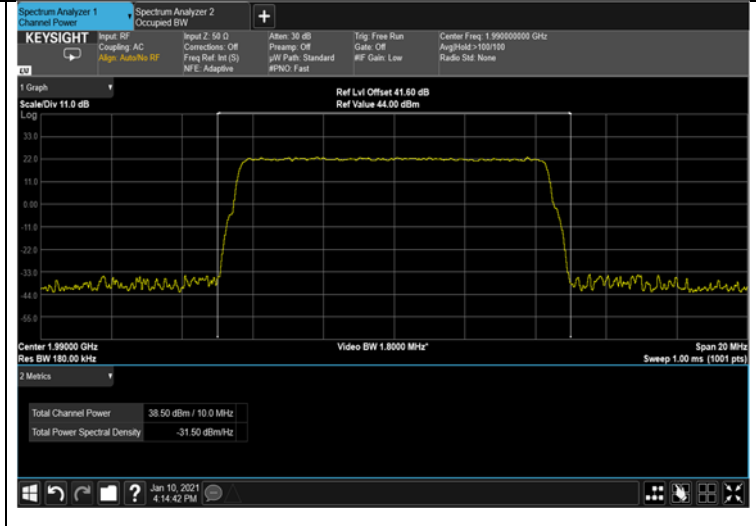
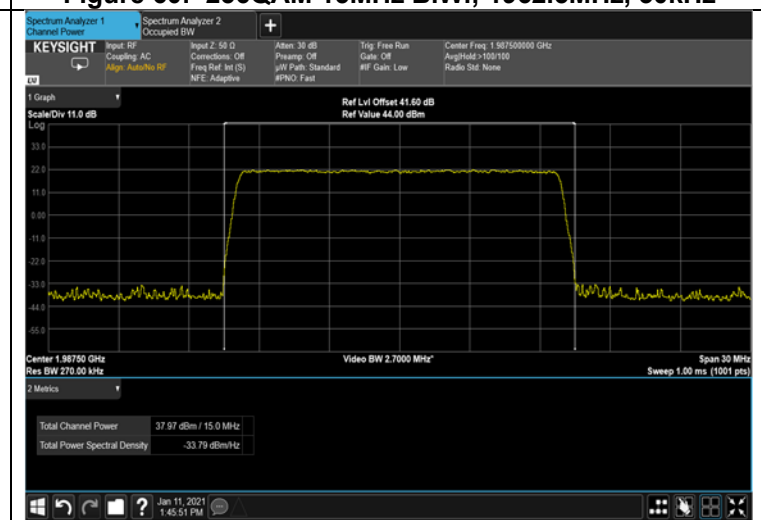
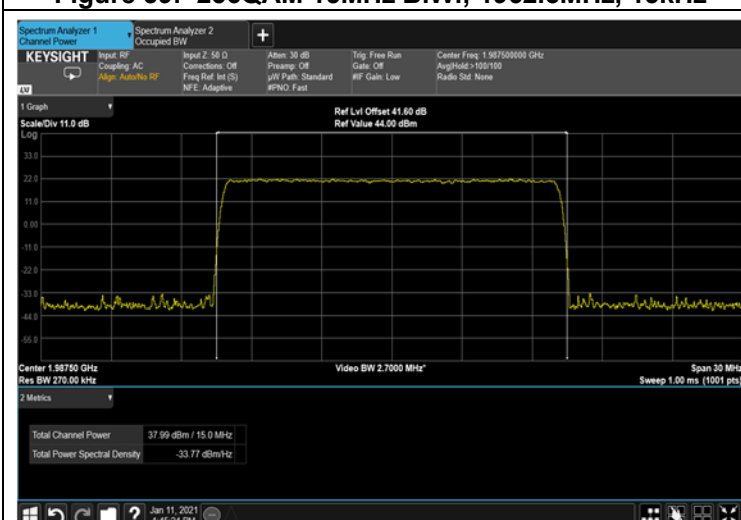
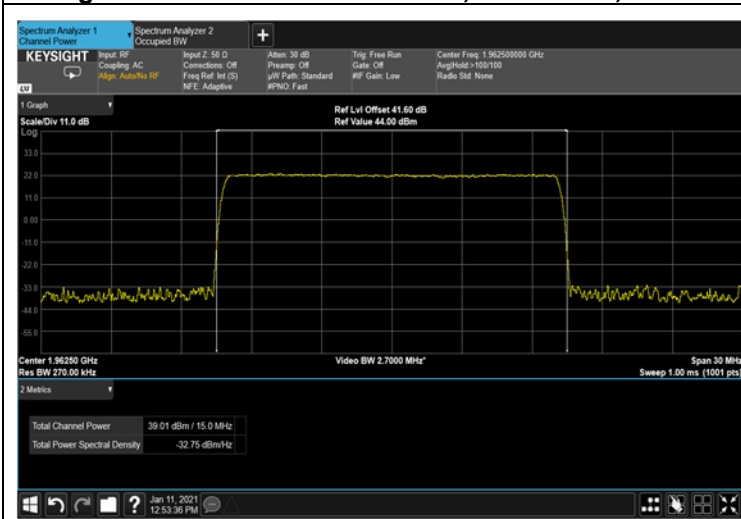
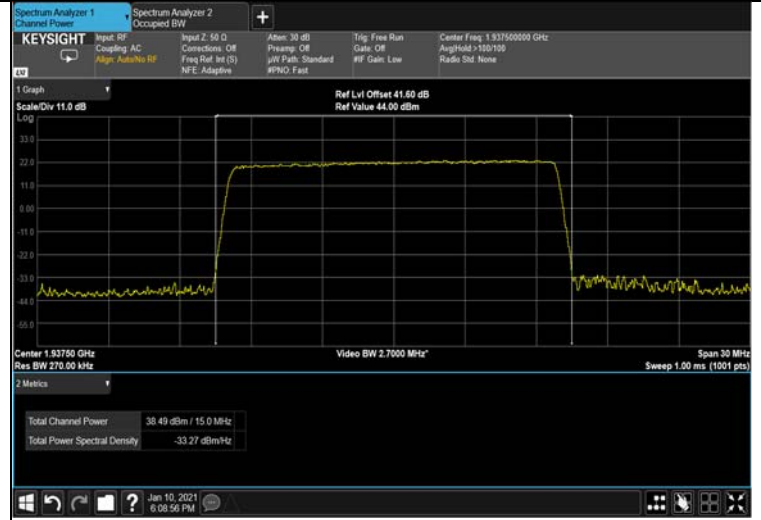

Figure 56: 256QAM 10MHz B.W.; 1990MHz, 30kHz



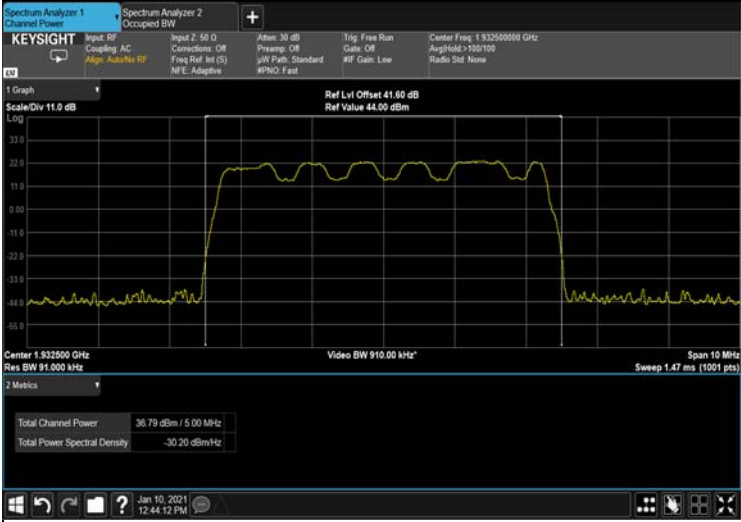

Figure 63: QPSK 5MHz B.W.; 1932.5MHz, 15kHz



Figure 64: QPSK 5MHz B.W.; 1932.5MHz, 30kHz

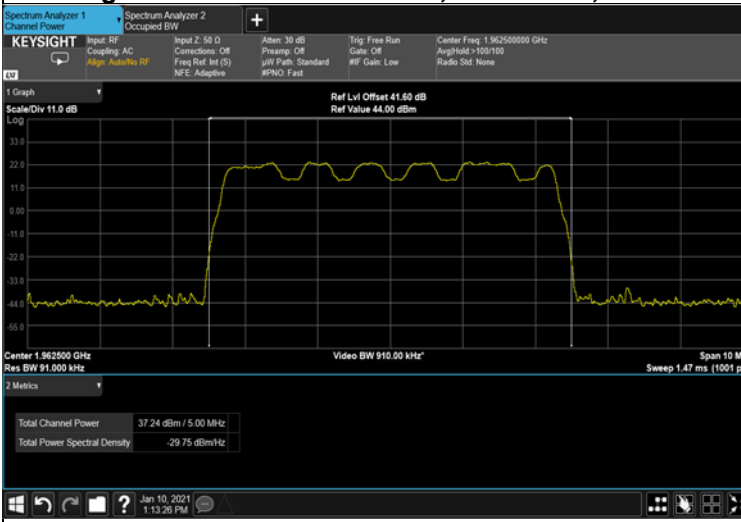

Figure 65: QPSK 5MHz B.W.; 1962.5MHz, 15kHz

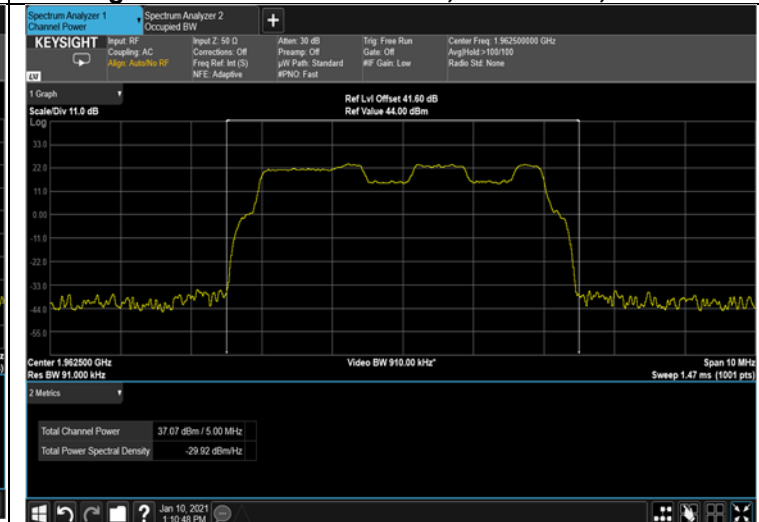

Figure 66: QPSK 5MHz B.W.; 1962.5MHz, 30kHz

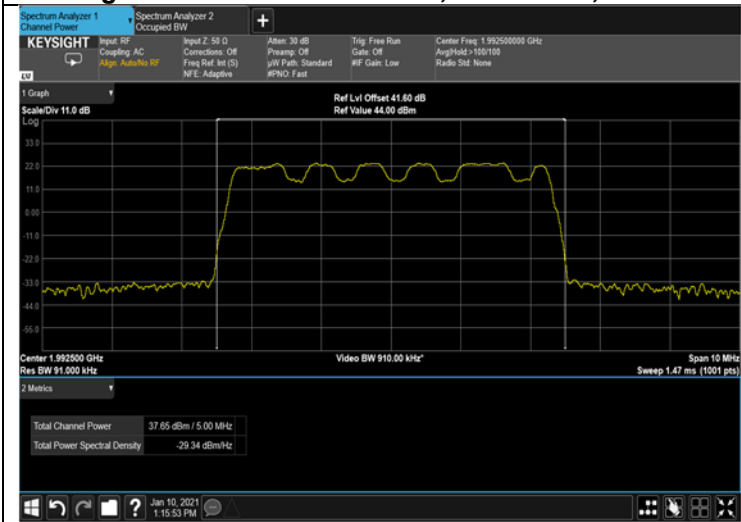

Figure 67: QPSK 5MHz B.W.; 1992.5MHz, 15kHz

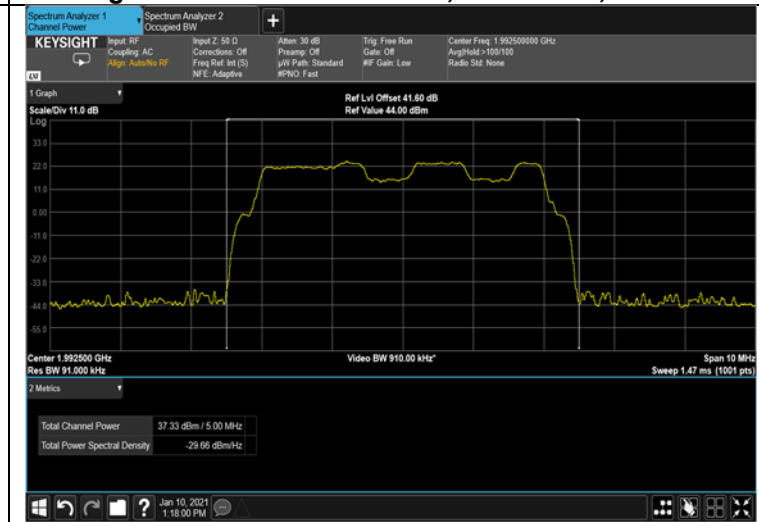

Figure 68: QPSK 5MHz B.W.; 1992.5MHz, 30kHz

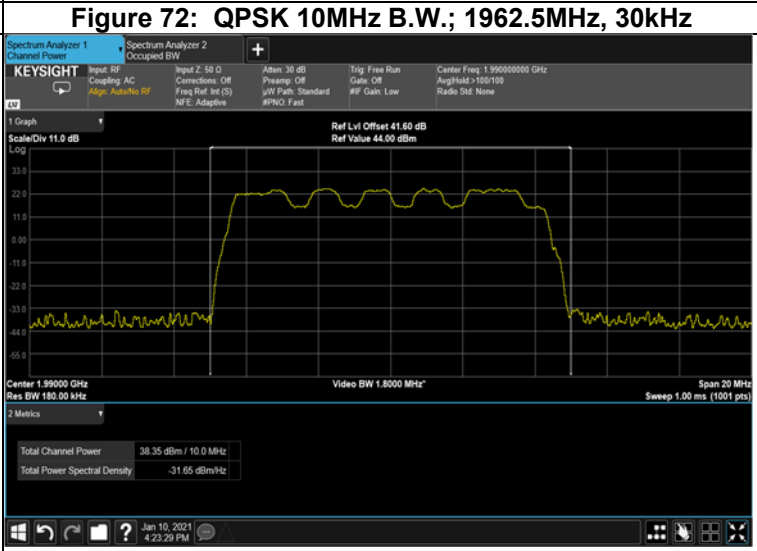
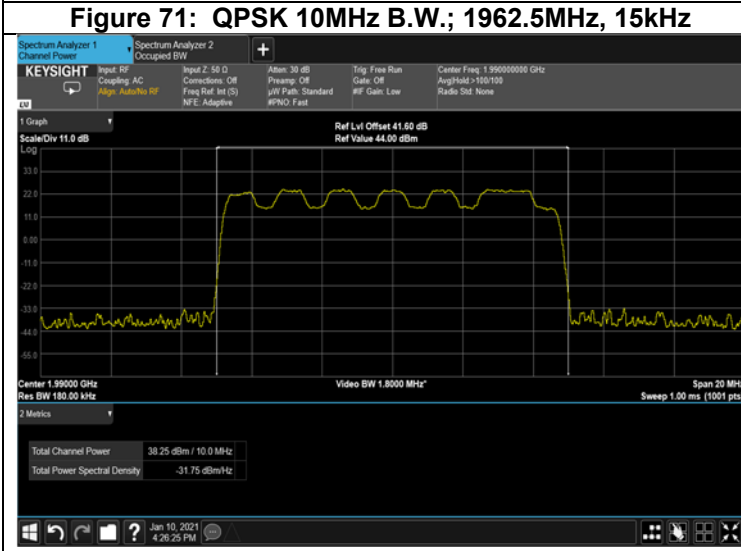
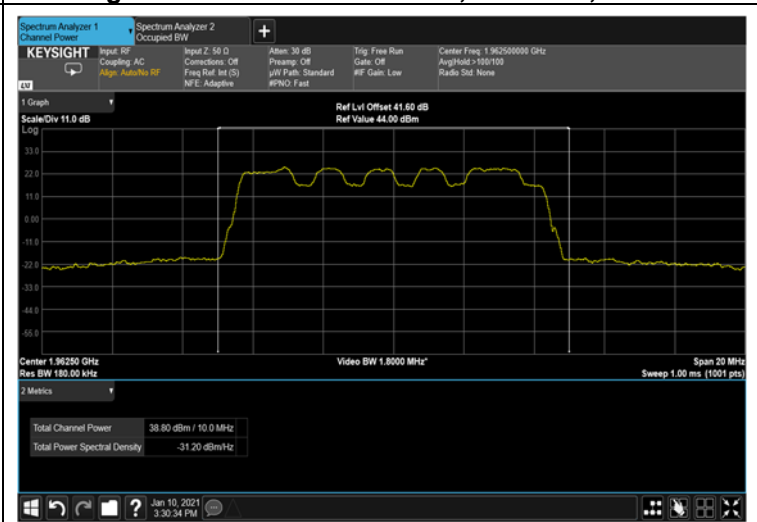
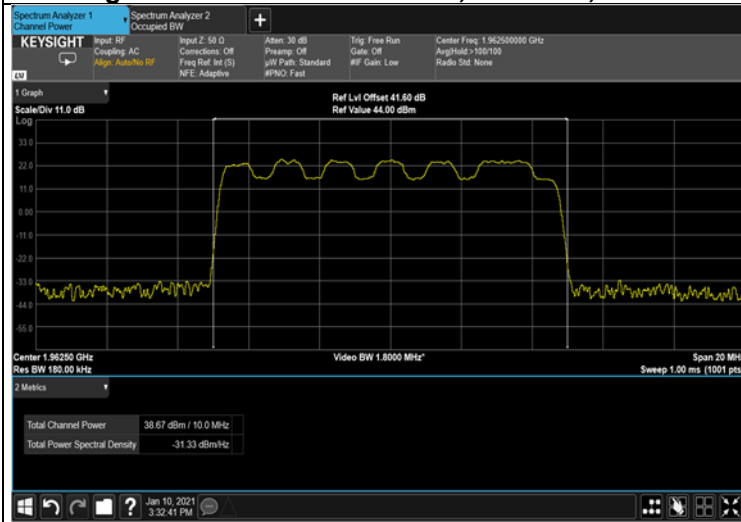
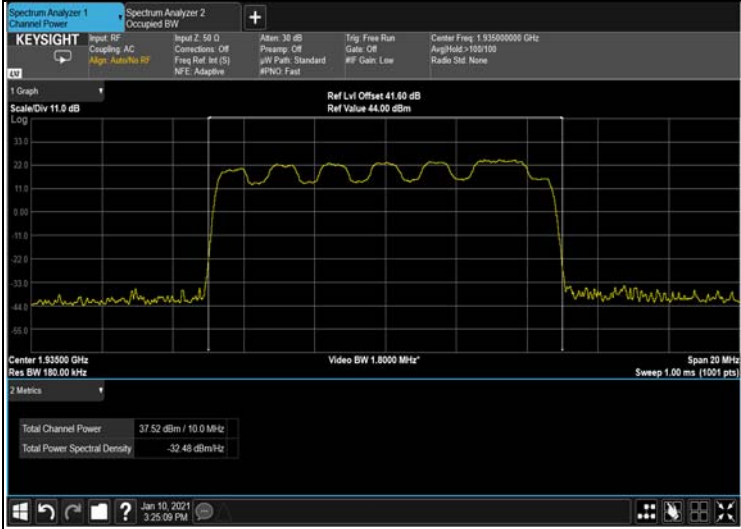



Figure 75: QPSK 15MHz B.W.; 1937.5MHz, 15kHz



Figure 76: QPSK 15MHz B.W.; 1937.5MHz, 30kHz

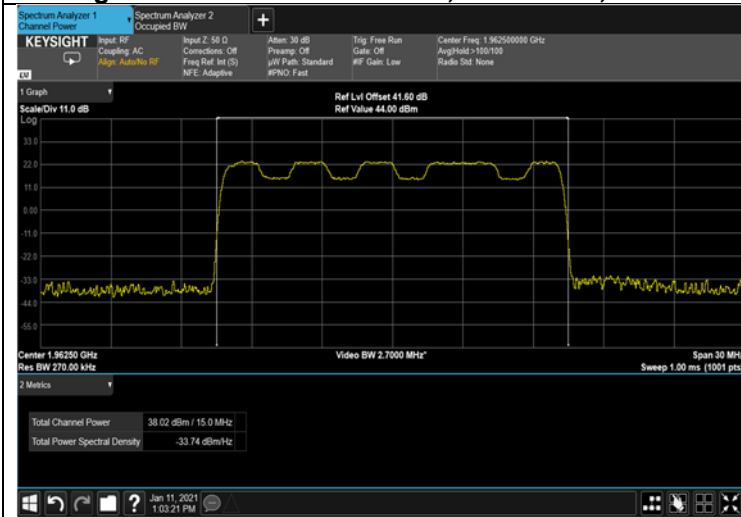

Figure 77: QPSK 15MHz B.W.; 1962.5MHz, 15kHz

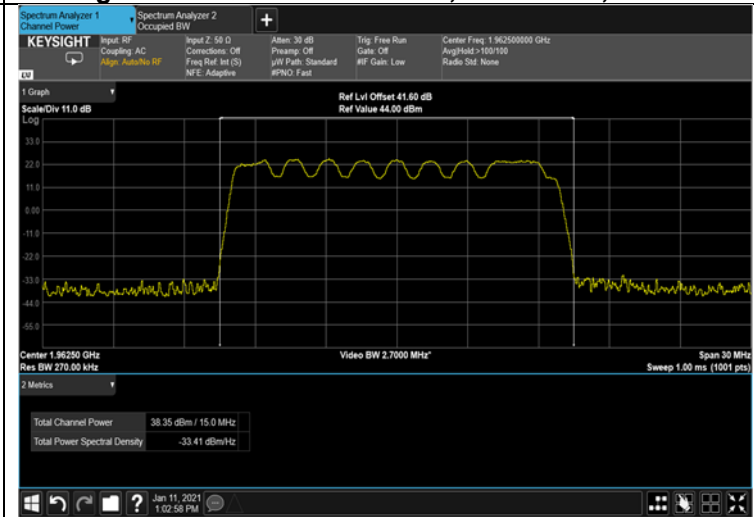

Figure 78: QPSK 15MHz B.W.; 1962.5MHz, 30kHz

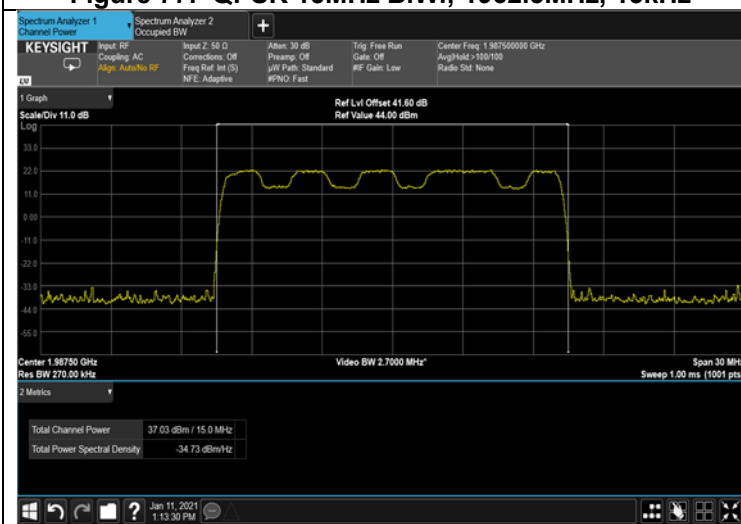

Figure 79: QPSK 15MHz B.W.; 1987.5MHz, 15kHz

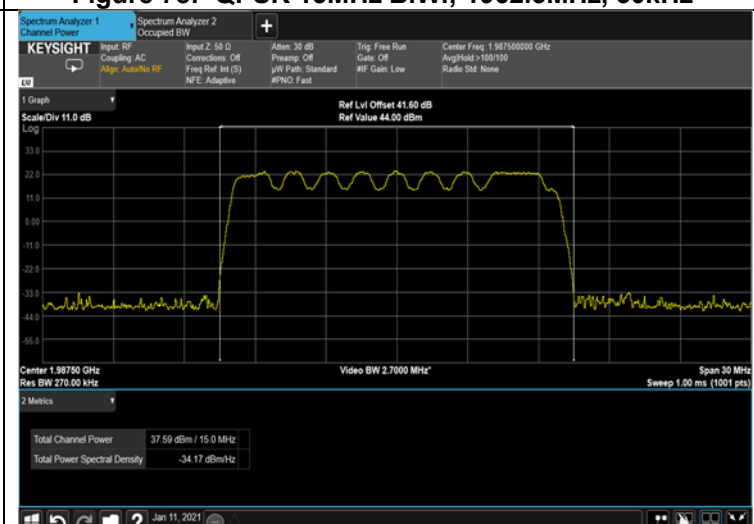

Figure 80: QPSK 15MHz B.W.; 1987.5MHz, 30kHz



4.5 Test Equipment Used; RF Power Output

Instrument	Manufacturer	Model	Serial Number	Calibration	
				Last Calibration Date	Next Calibration Due
EXA signal Analyzer	Keysight	UXA N9040B	MY56080119	January 31, 2020	January 31, 2022
EXG Vector Signal Generator	Agilent Technologies	N5172B	MY53051952	January 17, 2019	January 17, 2022
40 dB Attenuator	Weinschel Associates	WA 39-40-33	-	November 1, 2020	November 1, 2021
RF Coaxial Cable	Huber-Suner	SLLS210B	-	November 1, 2020	November 1, 2021

Table 5 Test Equipment Used



5 RF Power Output – 3G and 4G

5.1 Test Specification

FCC Part 24, Subpart E (24.232)

5.2 Test Procedure

(Temperature (22°C)/ Humidity (36%RH))

The E.U.T. antenna terminal was connected to the Spectrum Analyzer through an external attenuator (41.6 dB) and an appropriate coaxial cable. Special attention was taken to prevent Spectrum Analyzer RF input overload.

5.3 Test Limit

Peak Power Output must not exceed 1640W (62.1 dBm).

5.4 Test Results

JUDGEMENT: Passed

See additional information in Table 6 to Table 9 and Figure 81 to Figure 110.

Modulation	Bandwidth	Operation Frequency	Reading
	(MHz)	(MHz)	(dBm)
WCDMA	5	1932.5	37.70
		1962.5	37.73
		1992.5	37.46

Table 6 RF Power Output WCDMA - 3G

Modulation	Bandwidth	Operation Frequency	Reading
	(MHz)	(MHz)	(dBm)
16QAM	5	1932.5	37.09
		1962.5	37.24
		1992.5	37.24
	10	1935.0	37.19
		1962.5	37.12
		1990.0	37.08
	15	1937.5	37.08
		1962.5	37.05
		1987.5	37.22

Table 7 RF Power Output 16QAM - 4G

Modulation	Bandwidth	Operation Frequency	Reading
	(MHz)	(MHz)	(dBm)
64QAM	5	1932.5	38.33
		1962.5	38.65
		1992.5	37.64
	10	1935.0	38.11
		1962.5	38.89
		1990.0	37.79
	15	1937.5	37.82
		1962.5	38.62
		1987.5	37.17

Table 8 RF Power Output 64AM - 4G



Modulation	Bandwidth (MHz)	Operation Frequency	Reading
		(MHz)	(dBm)
QPSK	5	1932.5	37.03
		1962.5	37.58
		1992.5	37.06
	10	1935.0	37.05
		1962.5	37.34
		1990.0	37.04
	15	1937.5	37.87
		1962.5	36.97
		1987.5	37.47

Table 9 RF Power Output QPSK - 4G

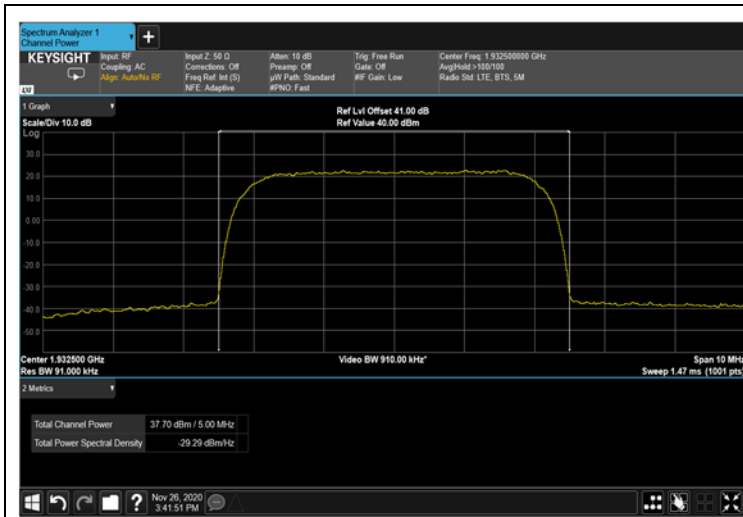

Figure 81: WCDMA 5MHz B.W.; 1932.5MHz – 3G

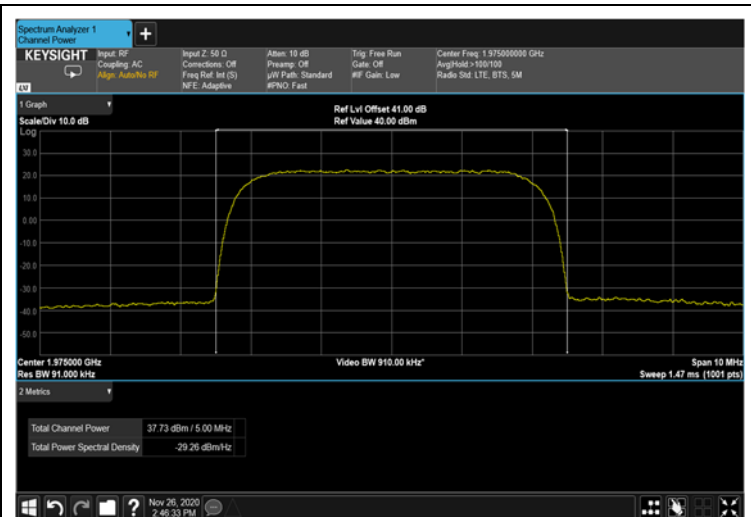

Figure 82: WCDMA 5MHz B.W.; 1962.5MHz – 3G

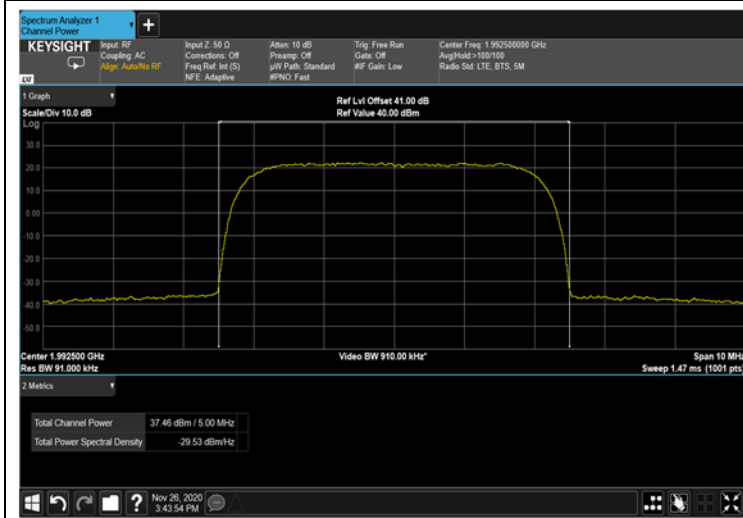

Figure 83: WCDMA 5MHz B.W.; 1992.5MHz – 3G



Figure 84: 16QAM 5MHz B.W.; 1932.5MHz – 4G



Figure 85: 16QAM 5MHz B.W.; 1962.5MHz – 4G

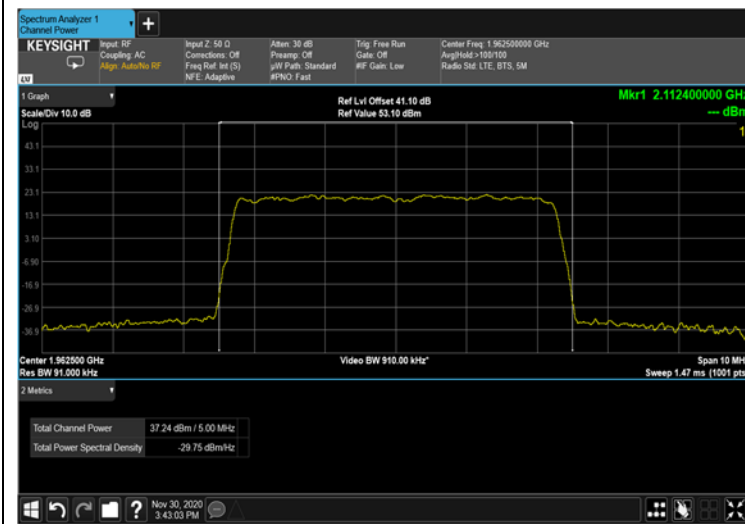

Figure 86: 16QAM 5MHz B.W.; 1992.5MHz – 4G

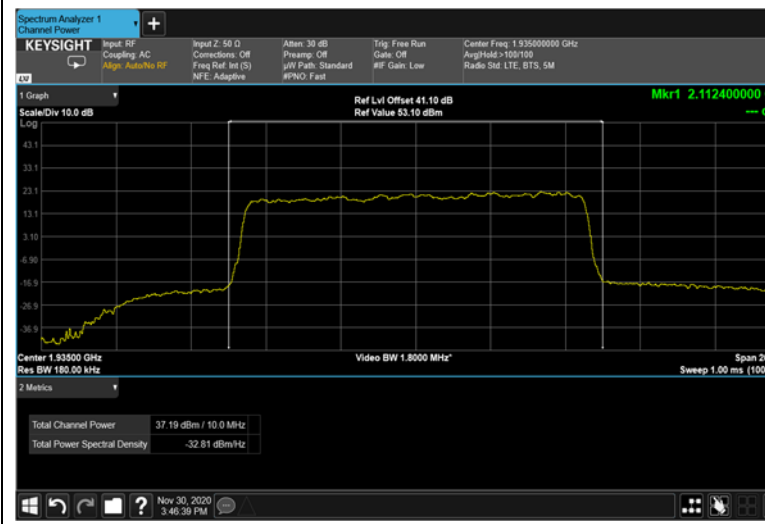

Figure 87: 16QAM 10MHz B.W.; 1935MHz – 4G

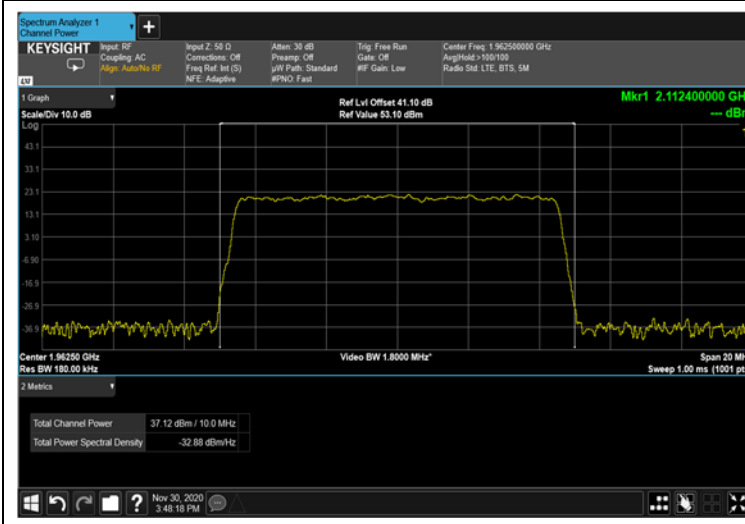

Figure 88: 16QAM 10MHz B.W.; 1962.5MHz – 4G

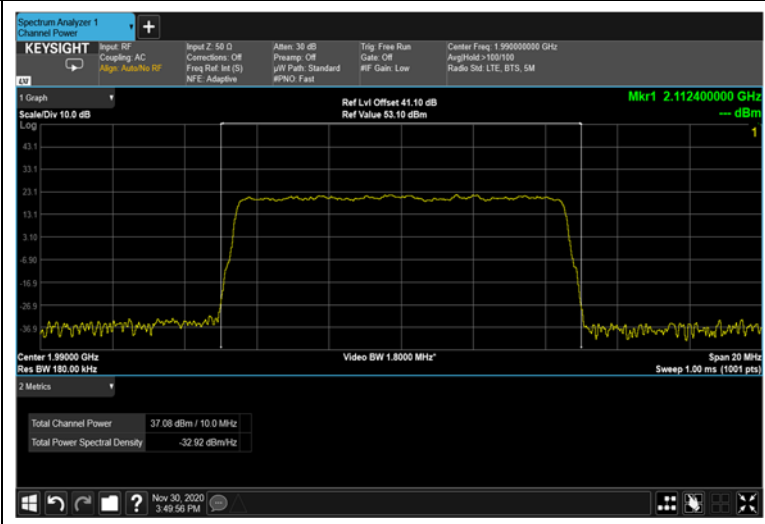

Figure 89: 16QAM 10MHz B.W.; 1990MHz – 4G

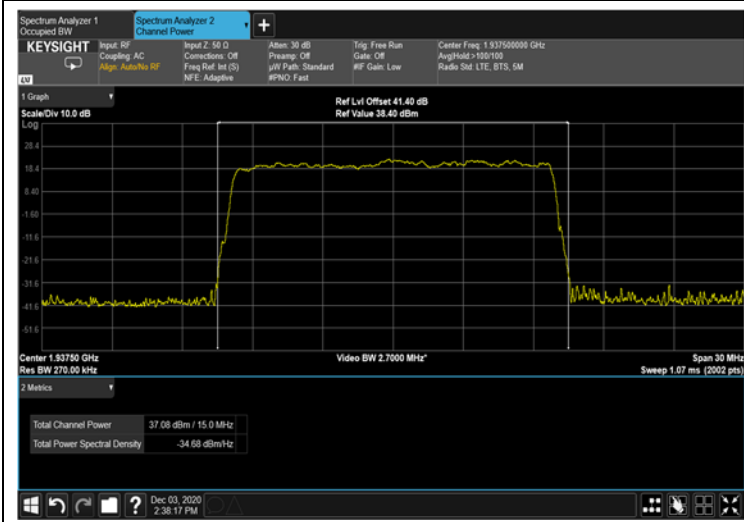

Figure 90: 16QAM 15MHz B.W.; 1937.5MHz – 4G

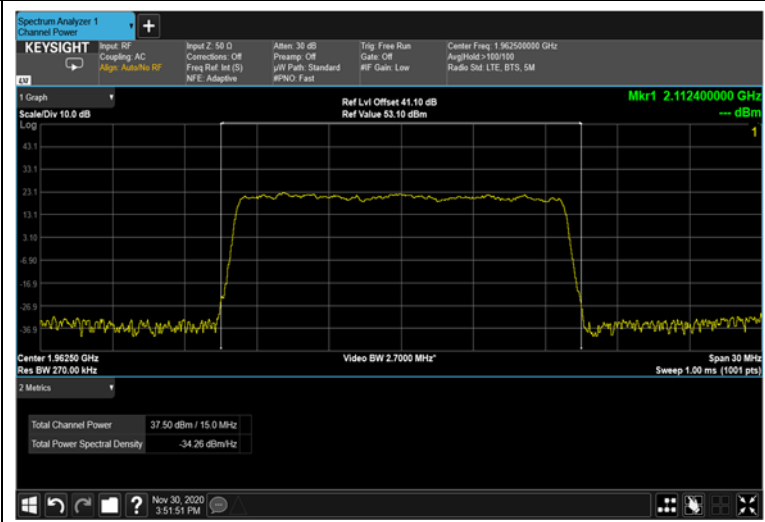

Figure 91: 16QAM 15MHz B.W.; 1962.5MHz – 4G

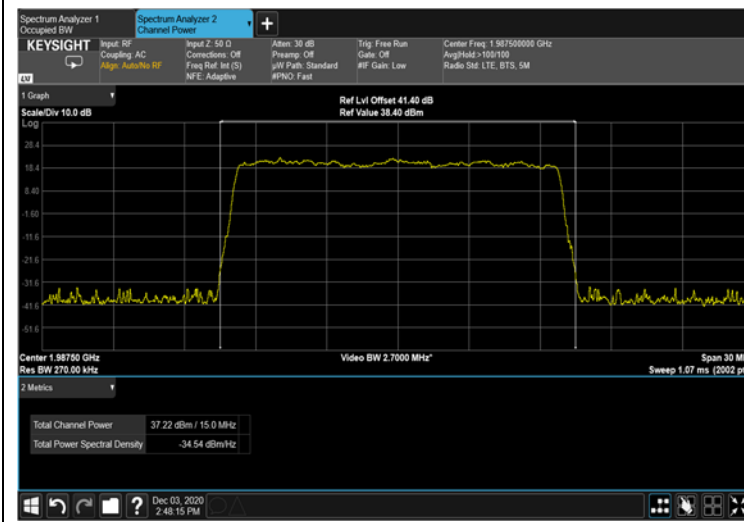

Figure 92: 16QAM 15MHz B.W.; 1987.5MHz – 4G

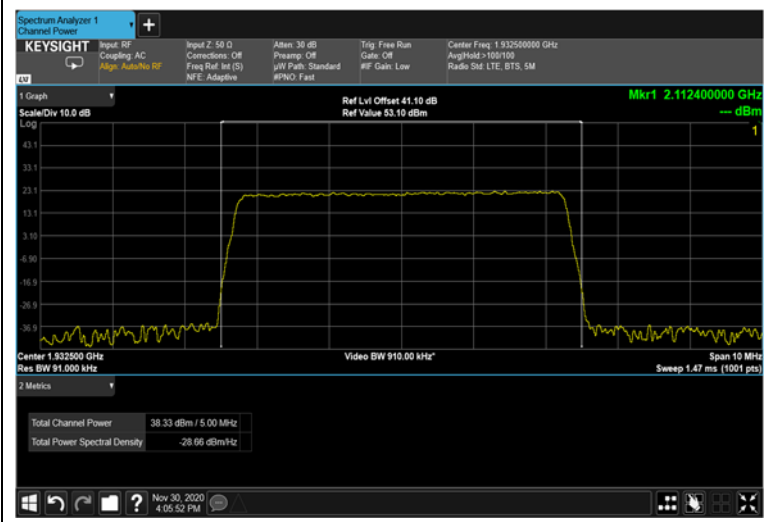

Figure 93: 64QAM 5MHz B.W.; 1932.5MHz – 4G



Figure 94: 64QAM 5MHz B.W.; 1962.5MHz – 4G

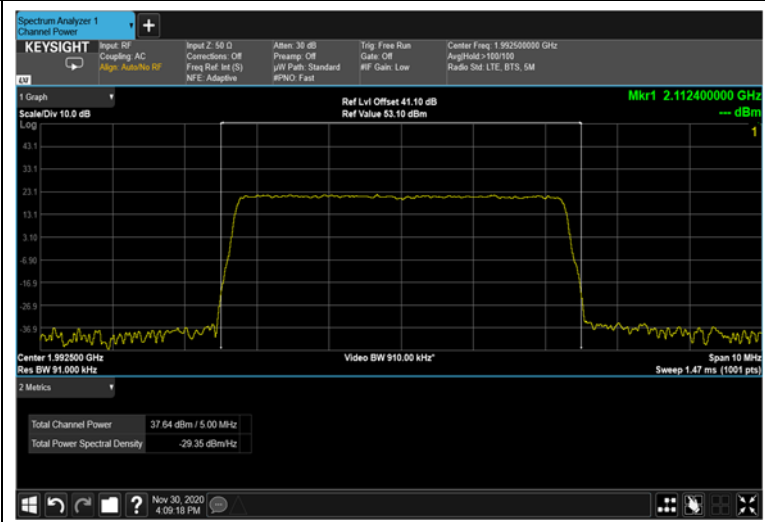

Figure 95: 64QAM 5MHz B.W.; 1992.5MHz – 4G

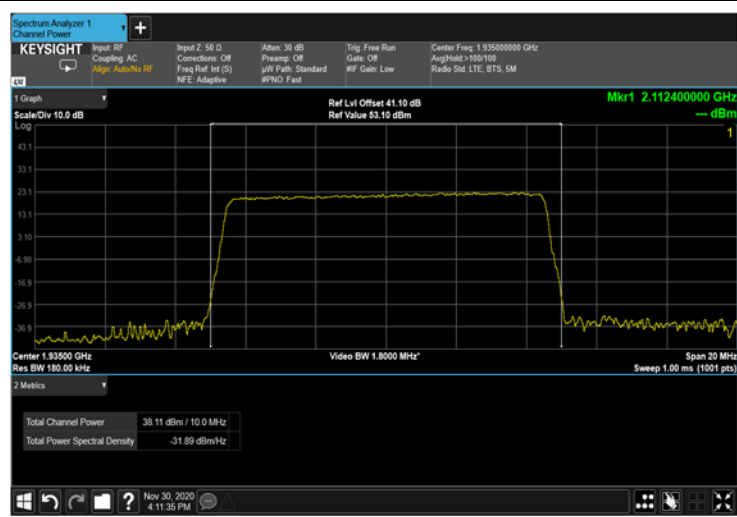

Figure 96: 64QAM 10MHz B.W.; 1935MHz – 4G

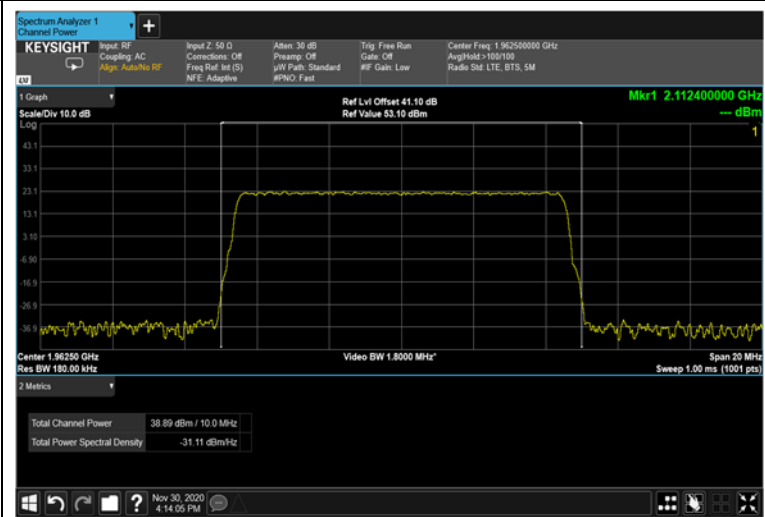

Figure 97: 64QAM 10MHz B.W.; 1962.5MHz – 4G

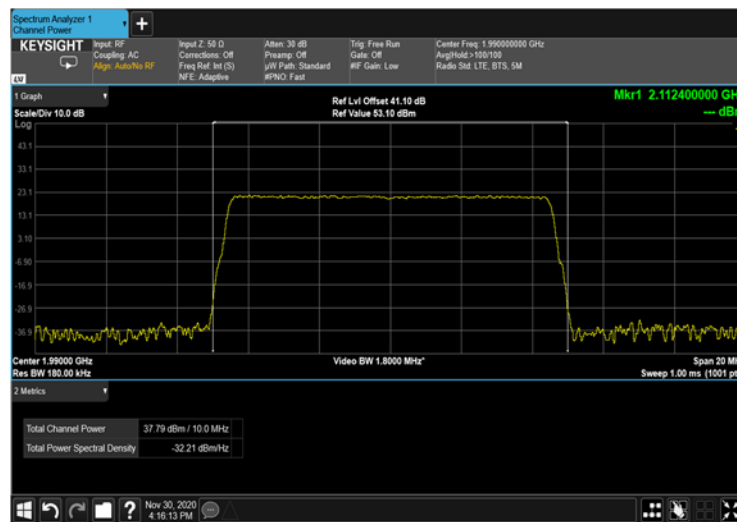

Figure 98: 64QAM 10MHz B.W.; 1990MHz – 4G

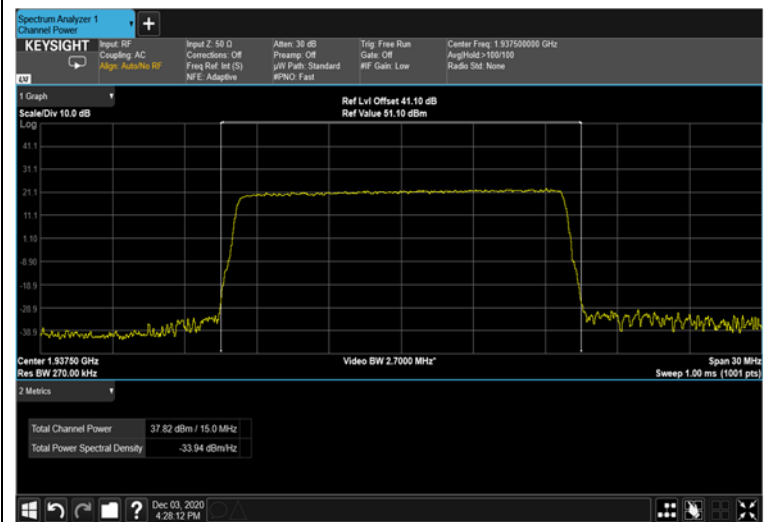

Figure 99: 64QAM 15MHz B.W.; 1937.5MHz – 4G



Figure 100: 64QAM 15MHz B.W.; 1962.5MHz – 4G

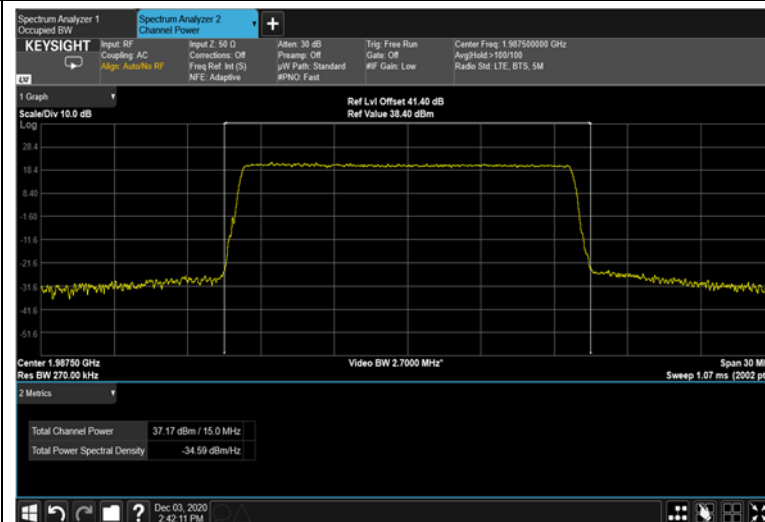

Figure 101: 64QAM 15MHz B.W.; 1987.5MHz – 4G

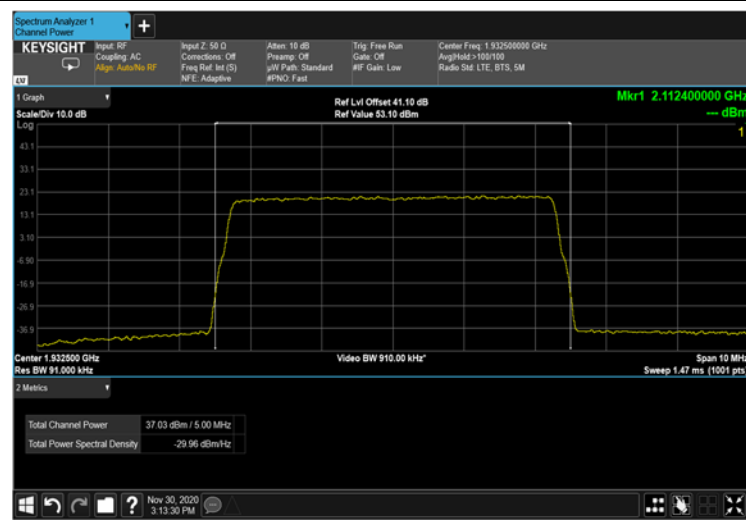

Figure 102: QPSK 5MHz B.W.; 1932.5MHz – 4G

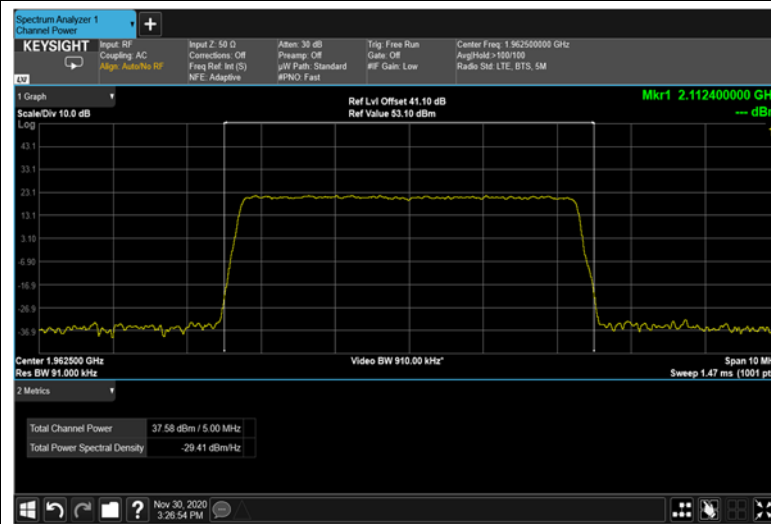

Figure 103: QPSK 5MHz B.W.; 1962.5MHz – 4G

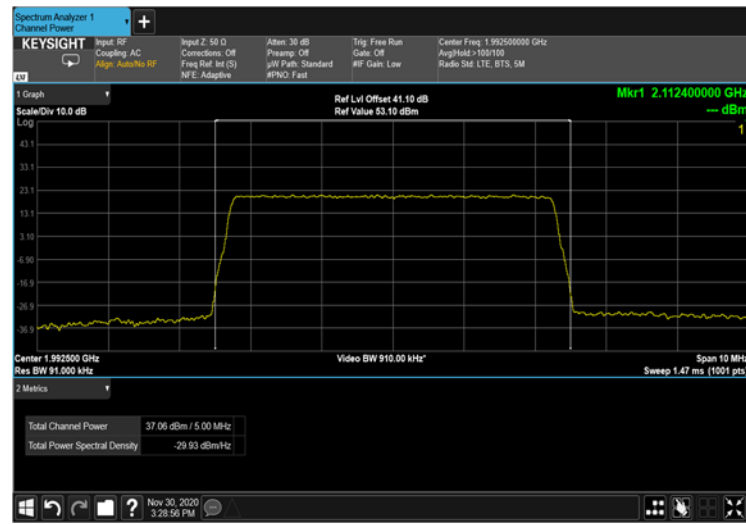

Figure 104: QPSK 5MHz B.W.; 1992.5MHz – 4G



Figure 105: QPSK 10MHz B.W.; 1935MHz – 4G

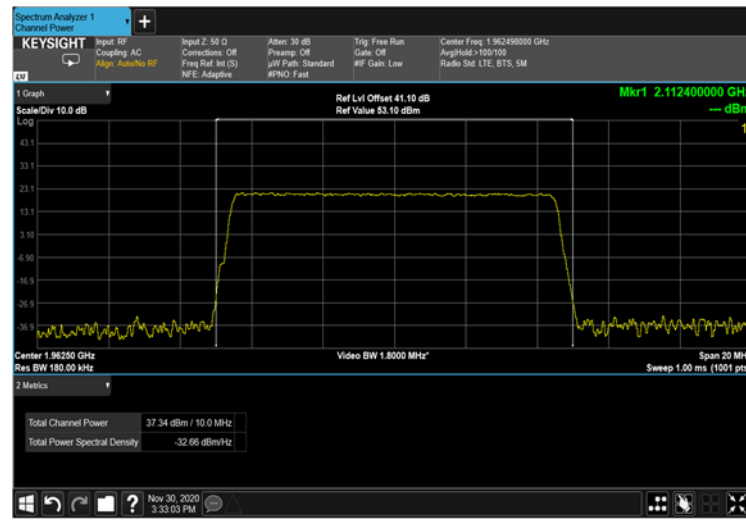

Figure 106: QPSK 10MHz B.W.; 1962.5MHz – 4G

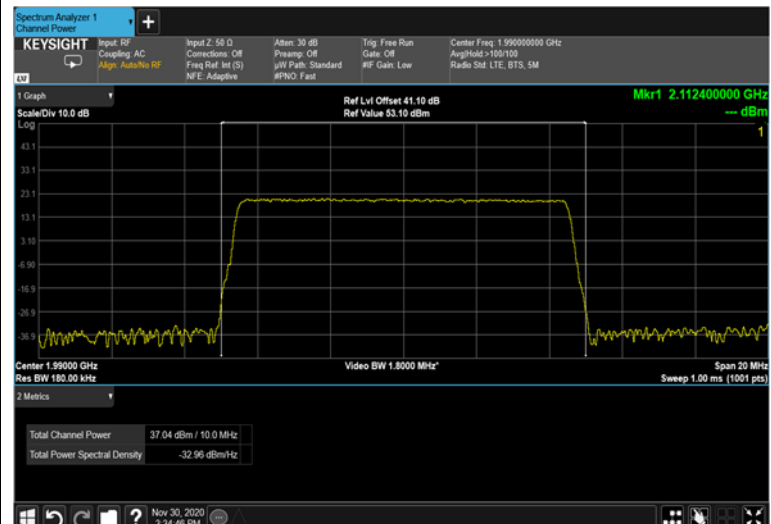

Figure 107: QPSK 10MHz B.W.; 1990MHz – 4G

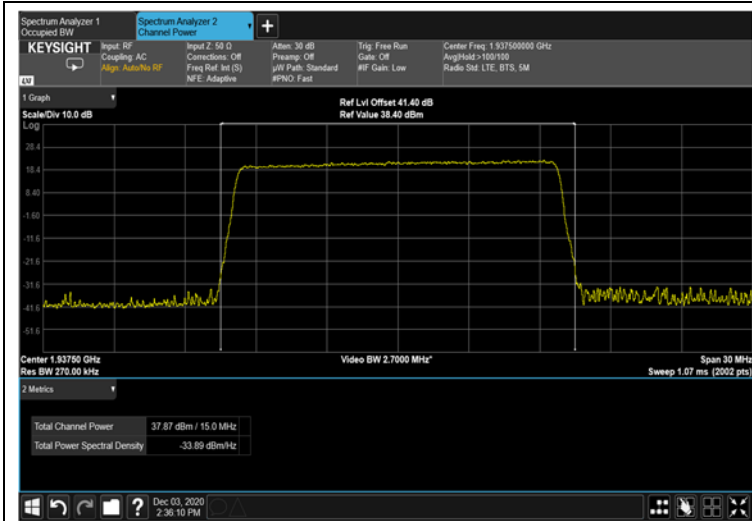

Figure 108: QPSK 15MHz B.W.; 1937.5MHz – 4G

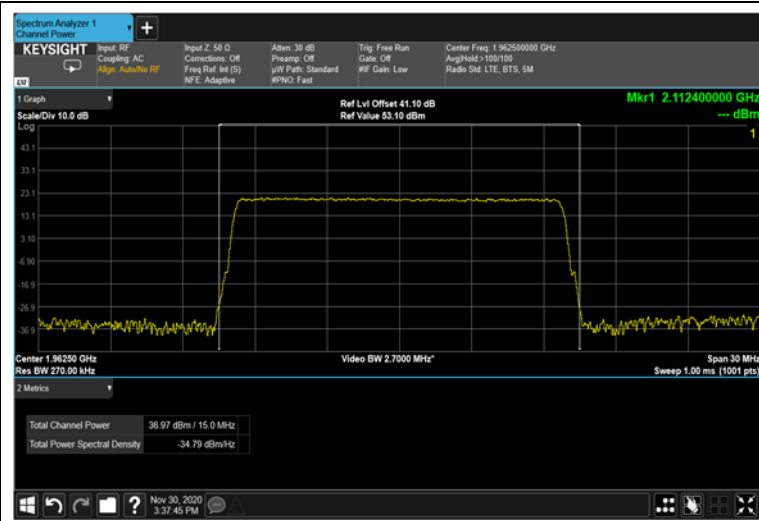

Figure 109: QPSK 15MHz B.W.; 1962.5MHz– 4G

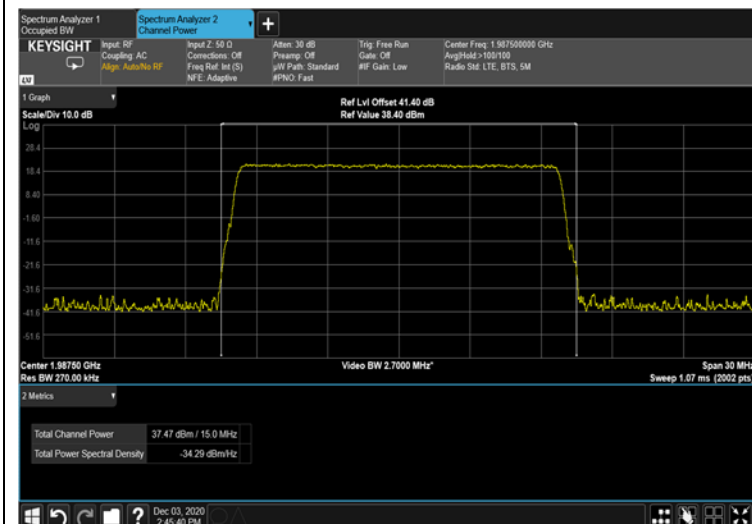

Figure 110: QPSK 15MHz B.W.; 1987.5MHz – 4G

5.5 Test Equipment Used; RF Power Output

Instrument	Manufacturer	Model	Serial Number	Calibration	
				Last Calibration Date	Next Calibration Due
EXA signal Analyzer	Keysight	UXA N9040B	MY56080119	January 31, 2020	January 31, 2022
EXG Vector Signal Generator	Agilent Technologies	N5172B	MY53051952	January 17, 2019	January 17, 2022
40 dB Attenuator	Weinschel Associates	WA 39-40-33	-	November 1, 2020	November 1, 2021
RF Coaxial Cable	Huber-Suner	SLLS210B	-	November 1, 2020	November 1, 2021

Table 10 Test Equipment Used



6 Band Edge Spectrum - 5G

6.1 Test Specification

FCC Part 24, Subpart E (24.238(a))

6.2 Test Procedure

(Temperature (22°C)/ Humidity (35%RH))

The E.U.T. antenna terminal was connected to the spectrum analyzer through an external attenuator and an appropriate coaxial cable (41.6 dB). resolution bandwidth of at least one percent of the emission bandwidth of the fundamental emission of the transmitter was employed

6.3 Test Limit

The power of any emission outside of the authorized operating frequency ranges (1930- 1995 MHz) must be attenuated below the transmitting power (P) by a factor of at least $43 + \log (P)$ dB, yielding -13dBm .

6.4 Test Results

JUDGEMENT: Passed

See additional information in Table 11 to Table 14 and Figure 111 to Figure 158.



Modulation	Bandwidth	Sub Carrier	Band Edge Frequency	Reading	Limit
	(MHz)	(kHz)	(MHz)	(dBm)	(dBm)
16QAM	5	15	1932.5	-21.704	-13.0
			1992.5	-17.848	-13.0
		30	1932.5	-36.021	-13.0
			1992.5	-36.917	-13.0
	10	15	1935.0	-35.968	-13.0
			1990.0	-41.399	-13.0
		30	1935.0	-41.836	-13.0
			1990.0	-43.845	-13.0
	15	15	1937.5	-40.746	-13.0
			1987.5	-38.606	-13.0
		30	1937.5	-43.095	-13.0
			1987.5	-42.635	-13.0

Table 11 Band Edge Spectrum Results 16QAM – 5G

Modulation	Bandwidth	Sub Carrier	Band Edge Frequency	Reading	Limit
	(MHz)	(kHz)	(MHz)	(dBm)	(dBm)
64QAM	5	15	1932.5	-21.903	-13.0
			1992.5	-18.757	-13.0
		30	1932.5	-37.013	-13.0
			1992.5	-40.712	-13.0
	10	15	1935.0	-36.092	-13.0
			1990.0	-37.188	-13.0
		30	1935.0	-38.218	-13.0
			1990.0	-36.537	-13.0
	15	15	1937.5	-36.498	-13.0
			1987.5	-40.850	-13.0
		30	1937.5	-41.210	-13.0
			1987.5	-41.764	-13.0

Table 12 Band Edge Spectrum Results 64QAM – 5G



Modulation	Bandwidth	Sub Carrier	Band Edge Frequency	Reading	Limit
	(MHz)	(kHz)	(MHz)	(dBm)	(dBm)
256QAM	5	15	1932.5	-20.967	-13.0
			1992.5	-19.114	-13.0
		30	1932.5	-35.282	-13.0
			1992.5	-37.192	-13.0
	10	15	1935.0	-38.201	-13.0
			1990.0	-40.470	-13.0
		30	1935.0	-39.369	-13.0
			1990.0	-37.171	-13.0
	15	15	1937.5	-40.324	-13.0
			1987.5	-37.482	-13.0
		30	1937.5	-39.622	-13.0
			1987.5	-42.221	-13.0

Table 13 Band Edge Spectrum Results 256QAM – 5G

Modulation	Bandwidth	Sub Carrier	Band Edge Frequency	Reading	Limit
	(MHz)	(kHz)	(MHz)	(dBm)	(dBm)
QPSK	5	15	1932.5	-19.674	-13.0
			1992.5	-18.283	-13.0
		30	1932.5	-34.278	-13.0
			1992.5	-36.813	-13.0
	10	15	1935.0	-36.334	-13.0
			1990.0	-43.080	-13.0
		30	1935.0	-43.625	-13.0
			1990.0	-43.104	-13.0
	15	15	1937.5	-39.650	-13.0
			1987.5	-35.776	-13.0
		30	1937.5	-42.464	-13.0
			1987.5	-39.202	-13.0

Table 14 Band Edge Spectrum Results QPSK – 5G