

TEST REPORT

Application No.: KSCR2207001273AT(FYCR2207000277AT)
FCC ID: OJFDLRUG235
Applicant: Corning Optical Communication LLC
Address of Applicant: 6 Concord Road, Shrewsbury, MA 01545 United States
Manufacturer: Comba Network System Company Limited.
Address of Manufacturer: No.10 Shenzhou Road, Guangzhou Science City, Guangzhou, Guangdong
Equipment Under Test (EUT):
EUT Name: Digital Low-power Remote Unit High Band supporting 3.5G
Model No.: dLRU-G2-35
Standard(s): FCC Part 96.47
 FCC KDB 940660 D01 Part 96 CBRS Eqpt v03
 WINNF-TS-0122-V1.0.2 CBRS CBSD Test Specification
 WINNF-18-IN-00178 CBRS End User Device as UUT Test Guidelines
Date of Receipt: 2022-07-21
Date of Test: 2022-08-02 to 2022-08-03
Date of Issue: 2022-08-04

Test Result:	Pass*
---------------------	--------------

* In the configuration tested, the EUT complied with the standards specified above.

Eric Lin
Laboratory Manager

The manufacturer should ensure that all products in series production are in conformity with the product sample detailed in this report. If the product in this report is used in any configuration other than that detailed in the report, the manufacturer must ensure the new system complies with all relevant standards. Any mention of SGS International Electrical Approvals or testing done by SGS International Electrical Approvals in connection with, distribution or use of the product described in this report must be approved by SGS International Electrical Approvals in writing.



Unless otherwise agreed in writing, this document is issued by the Company subject to its General Conditions of Service printed overleaf, available on request or accessible at <http://www.sgs.com/en/Terms-and-Conditions.aspx> and, for electronic format documents, subject to Terms and Conditions for Electronic Documents at <http://www.sgs.com/en/Terms-and-Conditions/Terms-e-Documents.aspx>. Attention is drawn to the limitation of liability, indemnification and jurisdiction issues defined therein. Any holder of this document is advised that information contained hereon reflects the Company's findings at the time of its intervention only and within the limits of Client's instructions, if any. The Company's sole responsibility is to its Client and this document does not exonerate parties to a transaction from exercising all their rights and obligations under the transaction documents. This document cannot be reproduced except in full, without prior written approval of the Company. Any unauthorized alteration, forgery or falsification of the content or appearance of this document is unlawful and offenders may be prosecuted to the fullest extent of the law. Unless otherwise stated the results shown in this test report refer only to the sample(s) tested and such sample(s) are retained for 30 days only.

Attention: To check the authenticity of testing /inspection report & certificate, please contact us at telephone: (86-755) 8307 1443, or email: CN.Doccheck@sgs.com

No.10, Weiye Road, Innovation Park, Kunshan, Jiangsu, China 215300
中国·江苏·昆山市留学生创业园伟业路10号 邮编 215300

t(86-512)57355888 f(86-512)57370818 www.sgsgroup.com.cn
t(86-512)57355888 f(86-512)57370818 sgs.china@sgs.com

Revision Record			
Version	Description	Date	Remark
00	Original	2022-08-04	/

Authorized for issue by:			
		<i>Damon Zhou</i>	
		Damon Zhou / Project Engineer	
		<i>Eric Lin</i>	
		Eric Lin / Reviewer	



Unless otherwise agreed in writing, this document is issued by the Company subject to its General Conditions of Service printed overleaf, available on request or accessible at <http://www.sgs.com/en/Terms-and-Conditions.aspx> and, for electronic format documents, subject to Terms and Conditions for Electronic Documents at <http://www.sgs.com/en/Terms-and-Conditions/Terms-e-Document.aspx>. Attention is drawn to the limitation of liability, indemnification and jurisdiction issues defined therein. Any holder of this document is advised that information contained hereon reflects the Company's findings at the time of its intervention only and within the limits of Client's instructions, if any. The Company's sole responsibility is to its Client and this document does not exonerate parties to a transaction from exercising all their rights and obligations under the transaction documents. This document cannot be reproduced except in full, without prior written approval of the Company. Any unauthorized alteration, forgery or falsification of the content or appearance of this document is unlawful and offenders may be prosecuted to the fullest extent of the law. Unless otherwise stated the results shown in this test report refer only to the sample(s) tested and such sample(s) are retained for 30 days only.
Attention: To check the authenticity of testing / inspection report & certificate, please contact us at telephone: (86-755) 8307 1443, or email: CN.Doccheck@sgs.com

2 Test Summary

Item	Standard	Test Case ID	Result
End User Device additional requirement	96.47	/	Pass

The UUT is an End User Device. According to the specifications of the manufacturer, it must comply with the requirements of the following standards:

Test standards:

FCC Part 96.47

FCC KDB 940660 D01 Part 96 CBRS Eqpt v03

WINNF-TS-0122-V1.0.2 CBRS CBSD Test Specification

WINNF-18-IN-00178 CBRS End User Device as UUT Test Guidelines



Unless otherwise agreed in writing, this document is issued by the Company subject to its General Conditions of Service printed overleaf, available on request or accessible at <http://www.sgs.com/en/Terms-and-Conditions.aspx> and, for electronic format documents, subject to Terms and Conditions for Electronic Documents at <http://www.sgs.com/en/Terms-and-Conditions/Terms-e-Document.aspx>. Attention is drawn to the limitation of liability, indemnification and jurisdiction issues defined therein. Any holder of this document is advised that information contained hereon reflects the Company's findings at the time of its intervention only and within the limits of Client's instructions, if any. The Company's sole responsibility is to its Client and this document does not exonerate parties to a transaction from exercising all their rights and obligations under the transaction documents. This document cannot be reproduced except in full, without prior written approval of the Company. Any unauthorized alteration, forgery or falsification of the content or appearance of this document is unlawful and offenders may be prosecuted to the fullest extent of the law. Unless otherwise stated the results shown in this test report refer only to the sample(s) tested and such sample(s) are retained for 30 days only. Attention: To check the authenticity of testing /inspection report & certificate, please contact us at telephone: (86-755) 8307 1443, or email: CN.Doccheck@sgs.com

3 Contents

	Page
1 COVER PAGE	1
2 TEST SUMMARY	3
3 CONTENTS	4
4 GENERAL INFORMATION	5
4.1 DETAILS OF E.U.T.	5
4.2 MEASUREMENT UNCERTAINTY	5
4.3 DESCRIPTION OF SUPPORT UNITS	5
4.4 TEST LOCATION	6
4.5 TEST FACILITY	6
5 EQUIPMENT LIST	7
6 TEST METHOD AND ENVIRONMENT	8
6.1 END USER DEVICE CONFORMANCE AND PERFORMANCE	8
6.2 TEST ENVIRONMENT	8
6.3 TEST REQUIREMENT	8
6.4 TEST PROCEDURE	8
6.5 TEST SETUP	10
6.6 TEST RESULT	11
7 PHOTOGRAPHS	15
7.1 EUT CONSTRUCTIONAL DETAILS (EUT PHOTOS)	15



Unless otherwise agreed in writing, this document is issued by the Company subject to its General Conditions of Service printed overleaf, available on request or accessible at <http://www.sgs.com/en/Terms-and-Conditions.aspx> and, for electronic format documents, subject to Terms and Conditions for Electronic Documents at <http://www.sgs.com/en/Terms-and-Conditions/Terms-e-Document.aspx>. Attention is drawn to the limitation of liability, indemnification and jurisdiction issues defined therein. Any holder of this document is advised that information contained hereon reflects the Company's findings at the time of its intervention only and within the limits of Client's instructions, if any. The Company's sole responsibility is to its Client and this document does not exonerate parties to a transaction from exercising all their rights and obligations under the transaction documents. This document cannot be reproduced except in full, without prior written approval of the Company. Any unauthorized alteration, forgery or falsification of the content or appearance of this document is unlawful and offenders may be prosecuted to the fullest extent of the law. Unless otherwise stated the results shown in this test report refer only to the sample(s) tested and such sample(s) are retained for 30 days only.
Attention: To check the authenticity of testing /inspection report & certificate, please contact us at telephone: (86-755) 8307 1443, or email: CN.Doccheck@sgs.com

Compliance Certification Services (Kunshan) Inc.
 EMC Laboratory

No.10, Weiye Road, Innovation Park, Kunshan, Jiangsu, China 215300
 中国·江苏·昆山市留学院创业园伟业路10号 邮编 215300

t(86-512)57355888 f(86-512)57370818 www.sgs.com.cn
 t(86-512)57355888 f(86-512)57370818 sgs.china@sgs.com

4 General Information

4.1 Details of E.U.T.

Power supply:	DC 48V
Sample Type:	Digital Low-power Remote Unit High Band supporting 3.5G
Transmitter Frequency Band:	LTE/NR Band 48
Transmitter Frequency Range:	3550~3700MHz
Hardware Version:	Version 1
Software Version:	DLRUHG2_V01.00.01.23
Antenna Gain:	0dBi
MIMO Type:	2T2R

4.2 Measurement Uncertainty

No.	Item	Measurement Uncertainty
1	Radio Frequency	$\pm 7.25 \times 10^{-8}$
2	RF conducted power	$\pm 0.75\text{dB}$
3	Temperature test	$\pm 1^\circ\text{C}$
4	Humidity test	$\pm 3\%$
5	Supply voltages	$\pm 1.5\%$
6	Time	$\pm 3\%$

4.3 Description of Support Units

Description	Manufacturer	Model No.	Serial No.
EPC	Lanner Electronics Inc.	LICA-1513A	LR202002004052
OMC	Lanner Electronics Inc.	LICA-1513A	LR202002004054
Router	TP-LINK	TL-R860+	1175379002425
Base station	Baicells	mBS31001H (FCC ID: 2AG32MBS3100196N)	1202000240194DP0023
Base station	Airspan	AIRSPPEED 2900 (FCC ID: PIDAS2900)	/
USB Dongle	Smawave	SDF311-a	DF311a02203700001



Unless otherwise agreed in writing, this document is issued by the Company subject to its General Conditions of Service printed overleaf, available on request or accessible at <http://www.sgs.com/en/Terms-and-Conditions.aspx> and, for electronic format documents, subject to Terms and Conditions for Electronic Documents at <http://www.sgs.com/en/Terms-and-Conditions/Terms-e-Document.aspx>. Attention is drawn to the limitation of liability, indemnification and jurisdiction issues defined therein. Any holder of this document is advised that information contained hereon reflects the Company's findings at the time of its intervention only and within the limits of Client's instructions, if any. The Company's sole responsibility is to its Client and this document does not exonerate parties to a transaction from exercising all their rights and obligations under the transaction documents. This document cannot be reproduced except in full, without prior written approval of the Company. Any unauthorized alteration, forgery or falsification of the content or appearance of this document is unlawful and offenders may be prosecuted to the fullest extent of the law. Unless otherwise stated the results shown in this test report refer only to the sample(s) tested and such sample(s) are retained for 30 days only.
Attention: To check the authenticity of testing / inspection report & certificate, please contact us at telephone: (86-755) 8307 1443, or email: CN.Doccheck@sgs.com

Compliance Certification Services (Kunshan) Inc.
EMC Laboratory

No.10, Weiye Road, Innovation Park, Kunshan, Jiangsu, China 215300
中国·江苏·昆山市留学院创业园伟业路10号 邮编 215300

t(86-512)57355888 f(86-512)57370818 www.sgs.com.cn
t(86-512)57355888 f(86-512)57370818 sgs.china@sgs.com

4.4 Test Location

All tests were performed at:

Compliance Certification Services (Kunshan) Inc.

No.10 Weiye Rd, Innovation park, Eco&Tec, Development Zone, Kunshan City, Jiangsu, China.

Tel: +86 512 5735 5888 Fax: +86 512 5737 0818

No tests were sub-contracted.

4.5 Test Facility

The test facility is recognized, certified, or accredited by the following organizations:

- **CNAS (No. CNAS L4354)**

CNAS has accredited Compliance Certification Services (Kunshan) Inc. to ISO/IEC 17025:2017 General Requirements for the Competence of Testing and Calibration Laboratories (CNAS-CL01 Accreditation Criteria for the Competence of Testing and Calibration Laboratories) for the competence in the field of testing.

- **A2LA (Certificate No. 2541.01)**

Compliance Certification Services (Kunshan) Inc. is accredited by the American Association for Laboratory Accreditation (A2LA). Certificate No. 2541.01.

- **FCC (Designation Number: CN1172)**

Compliance Certification Services (Kunshan) Inc. has been recognized as an accredited testing laboratory. Designation Number: CN1172.

- **ISED (CAB identifier: CN0072)**

Compliance Certification Services (Kunshan) Inc. has been recognized by Innovation, Science and Economic Development Canada (ISED) as an accredited testing laboratory.

Company Number: 2324E

- **VCCI (Member No.: 1938)**

The 3m and 10m Semi-anechoic chamber and Shielded Room of Compliance Certification Services (Kunshan) Inc. has been registered in accordance with the Regulations for Voluntary Control Measures with Registration No.: R-20134, R-11600, C-11707, T-11499, G-10216 respectively.



Unless otherwise agreed in writing, this document is issued by the Company subject to its General Conditions of Service printed overleaf, available on request or accessible at <http://www.sgs.com/en/Terms-and-Conditions.aspx> and, for electronic format documents, subject to Terms and Conditions for Electronic Documents at <http://www.sgs.com/en/Terms-and-Conditions/Terms-e-Document.aspx>. Attention is drawn to the limitation of liability, indemnification and jurisdiction issues defined therein. Any holder of this document is advised that information contained hereon reflects the Company's findings at the time of its intervention only and within the limits of Client's instructions, if any. The Company's sole responsibility is to its Client and this document does not exonerate parties to a transaction from exercising all their rights and obligations under the transaction documents. This document cannot be reproduced except in full, without prior written approval of the Company. Any unauthorized alteration, forgery or falsification of the content or appearance of this document is unlawful and offenders may be prosecuted to the fullest extent of the law. Unless otherwise stated the results shown in this test report refer only to the sample(s) tested and such sample(s) are retained for 30 days only.
Attention: To check the authenticity of testing / inspection report & certificate, please contact us at telephone: (86-755) 8307 1443, or email: CN.Doccheck@sgs.com

5 Equipment List

Test Equipment	Manufacturer	Model No.	Inventory No.	Cal. Date	Cal. Due date
Laptop	Lenovo	Y510P	HFL000026	N/A	N/A
Spectrum Analyzer	KEYSIGHT	N9030B	KSEM021-1	2022/01/22	2023/01/22
Shield Room	研创	N/A	KS301115-2	N/A	N/A
Coaxial Cable	Thermax	N/A	14	2021/10/16	2022/10/15
Attenuator	Mini-Circuits	NAT-6-2W	15542-1	N.C.R.	N.C.R.
Humidity / Temperature Indicator	Anymetre	TH603	CZ700001(4/7)	2021/10/14	2022/10/13



Unless otherwise agreed in writing, this document is issued by the Company subject to its General Conditions of Service printed overleaf, available on request or accessible at <http://www.sgs.com/en/Terms-and-Conditions.aspx> and, for electronic format documents, subject to Terms and Conditions for Electronic Documents at <http://www.sgs.com/en/Terms-and-Conditions/Terms-e-Document.aspx>. Attention is drawn to the limitation of liability, indemnification and jurisdiction issues defined therein. Any holder of this document is advised that information contained hereon reflects the Company's findings at the time of its intervention only and within the limits of Client's instructions, if any. The Company's sole responsibility is to its Client and this document does not exonerate parties to a transaction from exercising all their rights and obligations under the transaction documents. This document cannot be reproduced except in full, without prior written approval of the Company. Any unauthorized alteration, forgery or falsification of the content or appearance of this document is unlawful and offenders may be prosecuted to the fullest extent of the law. Unless otherwise stated the results shown in this test report refer only to the sample(s) tested and such sample(s) are retained for 30 days only.

Attention: To check the authenticity of testing /inspection report & certificate, please contact us at telephone: (86-755) 8307 1443, or email: CN.Doccheck@sgs.com

Compliance Certification Services (Kunshan) Inc.
EMC Laboratory

No.10, Weiye Road, Innovation Park, Kunshan, Jiangsu, China 215300
中国·江苏·昆山市留学生创业园伟业路10号 邮编 215300

t(86-512)57355888 f(86-512)57370818 www.sgs.com.cn
t(86-512)57355888 f(86-512)57370818 sgs.china@sgs.com

6 Test Method and Environment

6.1 End User Device Conformance and Performance

Test Requirement: FCC Part 96.47

Test Method: WINNF-18-IN-00178 CBRS End User Device as UUT Test Guidelines

6.2 Test Environment

Environmental Conditions: 25deg. C, 65%RH

6.3 Test Requirement

FCC Part 96.47

- a). End User Devices may operate only if they can positively receive and decode an authorization signal transmitted by a CBSD, including the frequencies and power limits for their operation.
- b). An End User Device must discontinue operations, change frequencies, or change its operational power level within 10 seconds of receiving instructions from its associated CBSD.

6.4 Test Procedure

Following procedure can be done by applying WINNF-TS-0122-V1.0.2 CBRS CBSD Test Specification, use the certified Base station CBSD as companion device to show compliance with Part 96.47 requirement for End User Device (EUD):

For LTE

1. Setup with frequency 3590-3610MHz and power level 16dBm/MHz;
2. Enable CBSD service ;
3. Check EUD Tx Frequency and power;
4. Disable CBSD service ;
5. Check EUD stops transmission within 10 seconds;

6. Setup with frequency 3560-3580MHz and power level 11dBm/MHz;
7. Enable CBSD service;
8. Check EUD Tx Frequency and power;
9. Disable CBSD service;
10. Check EUD stops transmission within 10seconds.

For 5G NR

1. Setup with frequency 3620-3640MHz and power level 16dBm/MHz;
2. Enable CBSD service ;



3. Check EUD Tx Frequency and power;
4. Disable CBSD service ;
5. Check EUD stops transmission within 10 seconds;

6. Setup with frequency 3570-3590MHz and power level 11dBm/MHz;
7. Enable CBSD service;
8. Check EUD Tx Frequency and power;
9. Disable CBSD service;
10. Check EUD stops transmission within 10seconds.



6.5 Test Setup

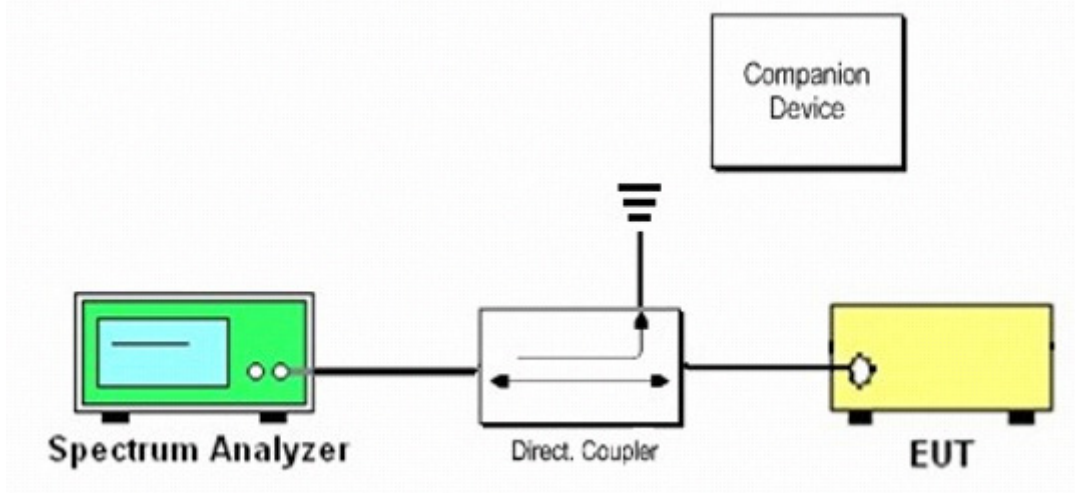

End User Device as UUT, the companion device is certified CBSD



Compliance Certification Services (Kunshan) Inc.
EMC Laboratory

Unless otherwise agreed in writing, this document is issued by the Company subject to its General Conditions of Service printed overleaf, available on request or accessible at <http://www.sgs.com/en/Terms-and-Conditions.aspx> and, for electronic format documents, subject to Terms and Conditions for Electronic Documents at <http://www.sgs.com/en/Terms-and-Conditions/Terms-e-Document.aspx>. Attention is drawn to the limitation of liability, indemnification and jurisdiction issues defined therein. Any holder of this document is advised that information contained hereon reflects the Company's findings at the time of its intervention only and within the limits of Client's instructions, if any. The Company's sole responsibility is to its Client and this document does not exonerate parties to a transaction from exercising all their rights and obligations under the transaction documents. This document cannot be reproduced except in full, without prior written approval of the Company. Any unauthorized alteration, forgery or falsification of the content or appearance of this document is unlawful and offenders may be prosecuted to the fullest extent of the law. Unless otherwise stated the results shown in this test report refer only to the sample(s) tested and such sample(s) are retained for 30 days only.
Attention: To check the authenticity of testing /inspection report & certificate, please contact us at telephone: (86-755) 8307 1443, or email: CN.Doccheck@sgs.com

No.10, Weiye Road, Innovation Park, Kunshan, Jiangsu, China 215300
中国·江苏·昆山市留学生创业园伟业路10号 邮编 215300

t(86-512)57355888 f(86-512)57370818 www.sgsgroup.com.cn
t(86-512)57355888 f(86-512)57370818 sgs.china@sgs.com

6.6 Test Result

Setup with frequency 3590-3610MHz and power level 16dBm/MHz

Check EUD Tx Frequency and power

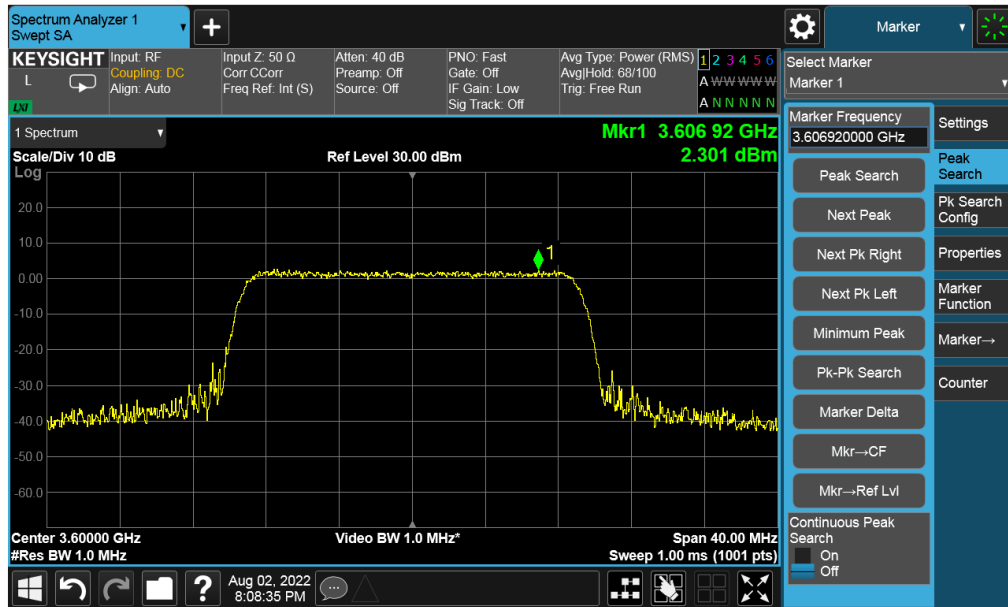

EIRP PSD=2.301+1+6.02=9.321dBm/MHz, loss of Cable and Splitter is 1dB, Antenna gain is 0dBi. 6.02dB is corrected antenna gain and MIMO power factor

EUD stops transmission within 10 seconds of receiving instructions from its associated CBSD.



Unless otherwise agreed in writing, this document is issued by the Company subject to its General Conditions of Service printed overleaf, available on request or accessible at <http://www.sgs.com/en/Terms-and-Conditions.aspx> and, for electronic format documents, subject to Terms and Conditions for Electronic Documents at <http://www.sgs.com/en/Terms-and-Conditions/Terms-e-Document.aspx>. Attention is drawn to the limitation of liability, indemnification and jurisdiction issues defined therein. Any holder of this document is advised that information contained herein reflects the Company's findings at the time of its intervention only and within the limits of Client's instructions, if any. The Company's sole responsibility is to its Client and this document does not exonerate parties to a transaction from exercising all their rights and obligations under the transaction documents. This document cannot be reproduced except in full, without prior written approval of the Company. Any unauthorized alteration, forgery or falsification of the content or appearance of this document is unlawful and offenders may be prosecuted to the fullest extent of the law. Unless otherwise stated the results shown in this test report refer only to the sample(s) tested and such sample(s) are retained for 30 days only. Attention: To check the authenticity of testing /inspection report & certificate, please contact us at telephone: (86-755) 8307 1443, or email: CN.Doccheck@sgs.com

Compliance Certification Services (Kunshan) Inc.
EMC Laboratory

No.10, Weiye Road, Innovation Park, Kunshan, Jiangsu, China 215300
中国·江苏·昆山市留学生创业园伟业路10号 邮编 215300

(86-512)57355888 (86-512)57370818 www.sgs.com.cn
(86-512)57355888 (86-512)57370818 sgs.china@sgs.com

Setup with frequency 3560-3580MHz and power level 11dBm/MHz

Check EUD Tx Frequency and power

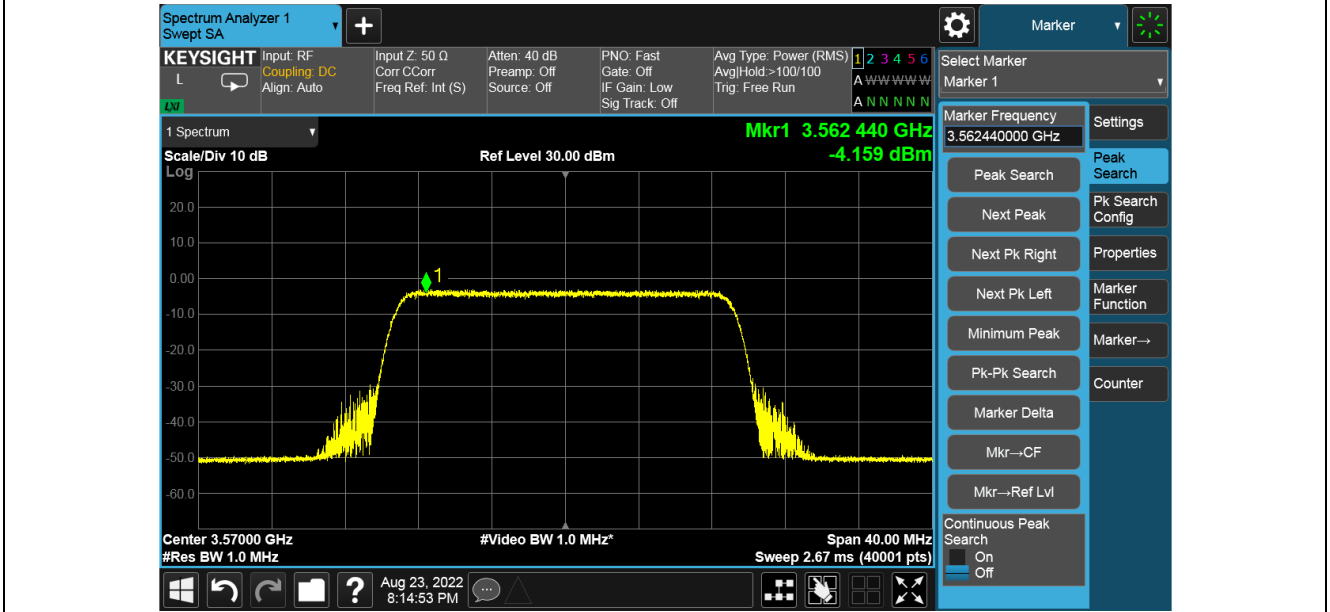

EIRP PSD= $-4.159 + 1 + 6.02 = 2.861$ dBm/MHz, loss of Cable and Splitter is 1dB, Antenna gain is 0dBi. 6.02dB is corrected antenna gain and MIMO power factor

EUD stops transmission within 10 seconds of receiving instructions from its associated CBSD.

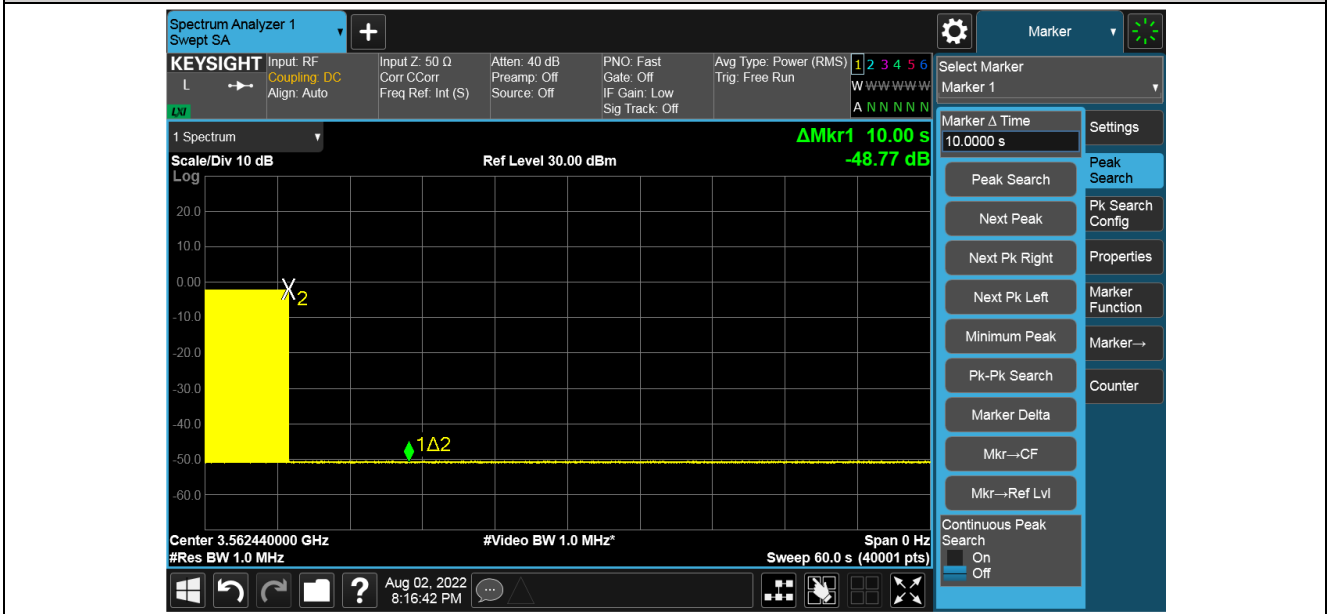

Unless otherwise agreed in writing, this document is issued by the Company subject to its General Conditions of Service printed overleaf, available on request or accessible at <http://www.sgs.com/en/Terms-and-Conditions.aspx> and, for electronic format documents, subject to Terms and Conditions for Electronic Documents at <http://www.sgs.com/en/Terms-and-Conditions/Terms-e-Documents.aspx>. Attention is drawn to the limitation of liability, indemnification and jurisdiction issues defined therein. Any holder of this document is advised that information contained herein reflects the Company's findings at the time of its intervention only and within the limits of Client's instructions, if any. The Company's sole responsibility is to its Client and this document does not exonerate parties to a transaction from exercising all their rights and obligations under the transaction documents. This document cannot be reproduced except in full, without prior written approval of the Company. Any unauthorized alteration, forgery or falsification of the content or appearance of this document is unlawful and offenders may be prosecuted to the fullest extent of the law. Unless otherwise stated the results shown in this test report refer only to the sample(s) tested and such sample(s) are retained for 30 days only.
Attention: To check the authenticity of testing /inspection report & certificate, please contact us at telephone: (86-755) 8307 1443, or email: CN.Doccheck@sgs.com

Compliance Certification Services (Kunshan) Inc.
EMC Laboratory

No.10, Weiye Road, Innovation Park, Kunshan, Jiangsu, China 215300
中国·江苏·昆山市留学生创业园伟业路10号 邮编 215300

(86-512)57355888 (86-512)57370818 www.sgs.com.cn
(86-512)57355888 (86-512)57370818 sgs.china@sgs.com

Setup with frequency 3620-3640MHz and power level 16dBm/MHz

Check EUD Tx Frequency and power

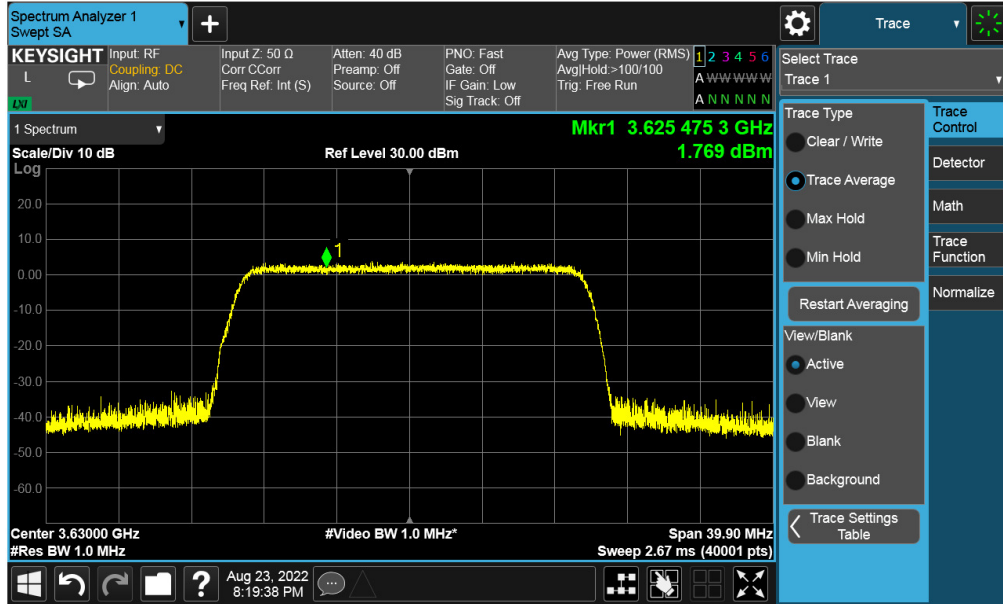

EIRP PSD=1.769+1+6.02=8.789dBm/MHz, loss of Cable and Splitter is 1dB, Antenna gain is 0dBi.
6.02dB is corrected antenna gain and MIMO power factor

EUD stops transmission within 10 seconds of receiving instructions from its associated CBSD.



Unless otherwise agreed in writing, this document is issued by the Company subject to its General Conditions of Service printed overleaf, available on request or accessible at <http://www.sgs.com/en/Terms-and-Conditions.aspx> and, for electronic format documents, subject to Terms and Conditions for Electronic Documents at <http://www.sgs.com/en/Terms-and-Conditions/Terms-e-Documents.aspx>. Attention is drawn to the limitation of liability, indemnification and jurisdiction issues defined therein. Any holder of this document is advised that information contained herein reflects the Company's findings at the time of its intervention only and within the limits of Client's instructions, if any. The Company's sole responsibility is to its Client and this document does not exonerate parties to a transaction from exercising all their rights and obligations under the transaction documents. This document cannot be reproduced except in full, without prior written approval of the Company. Any unauthorized alteration, forgery or falsification of the content or appearance of this document is unlawful and offenders may be prosecuted to the fullest extent of the law. Unless otherwise stated the results shown in this test report refer only to the sample(s) tested and such sample(s) are retained for 30 days only.
Attention: To check the authenticity of testing /inspection report & certificate, please contact us at telephone: (86-755) 8307 1443, or email: CN.Doccheck@sgs.com

Compliance Certification Services (Kunshan) Inc.
EMC Laboratory

No.10, Weiye Road, Innovation Park, Kunshan, Jiangsu, China 215300
中国·江苏·昆山市留学生创业园伟业路10号 邮编 215300

(86-512)57355888 (86-512)57370818 www.sgs.com.cn
(86-512)57355888 (86-512)57370818 sgs.china@sgs.com

Setup with frequency 3570-3590MHz and power level 11dBm/MHz

Check EUD Tx Frequency and power

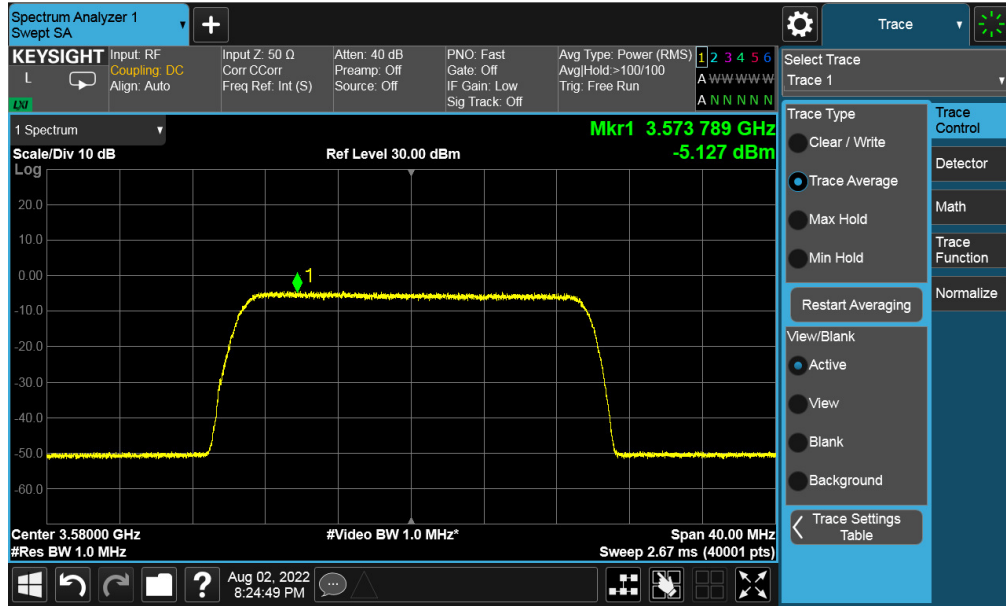

EIRP PSD=-5.127+1+6.02=1.893dBm/MHz, loss of Cable and Splitter is 1dB, Antenna gain is 0dBi.
6.02dB is corrected antenna gain and MIMO power factor

EUD stops transmission within 10 seconds of receiving instructions from its associated CBSD.

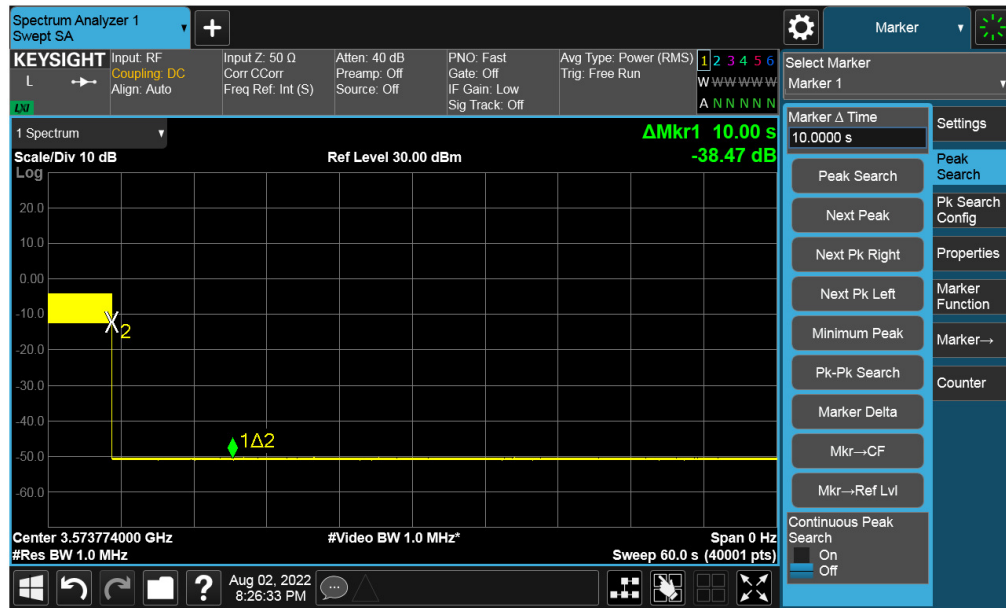

Unless otherwise agreed in writing, this document is issued by the Company subject to its General Conditions of Service printed overleaf, available on request or accessible at <http://www.sgs.com/en/Terms-and-Conditions.aspx> and, for electronic format documents, subject to Terms and Conditions for Electronic Documents at <http://www.sgs.com/en/Terms-and-Conditions/Terms-e-Documents.aspx>. Attention is drawn to the limitation of liability, indemnification and jurisdiction issues defined therein. Any holder of this document is advised that information contained hereon reflects the Company's findings at the time of its intervention only and within the limits of Client's instructions, if any. The Company's sole responsibility is to its Client and this document does not exonerate parties to a transaction from exercising all their rights and obligations under the transaction documents. This document cannot be reproduced except in full, without prior written approval of the Company. Any unauthorized alteration, forgery or falsification of the content or appearance of this document is unlawful and offenders may be prosecuted to the fullest extent of the law. Unless otherwise stated the results shown in this test report refer only to the sample(s) tested and such sample(s) are retained for 30 days only.
Attention: To check the authenticity of testing /inspection report & certificate, please contact us at telephone: (86-755) 8307 1443, or email: CN.Doccheck@sgs.com

Compliance Certification Services (Kunshan) Inc.
EMC Laboratory

No.10, Weiye Road, Innovation Park, Kunshan, Jiangsu, China 215300
中国·江苏·昆山市留学生创业园伟业路10号 邮编 215300

(86-512)57355888 (86-512)57370818 www.sgs.com
(86-512)57355888 (86-512)57370818 sgs.china@sgs.com

7 Photographs

7.1 EUT Constructional Details (EUT Photos)

Please Refer to Integral and internal photos for details.

- End of the Report -



Compliance Certification Services (Kunshan) Inc.
EMC Laboratory

Unless otherwise agreed in writing, this document is issued by the Company subject to its General Conditions of Service printed overleaf, available on request or accessible at <http://www.sgs.com/en/Terms-and-Conditions.aspx> and, for electronic format documents, subject to Terms and Conditions for Electronic Documents at <http://www.sgs.com/en/Terms-and-Conditions/Terms-e-Document.aspx>. Attention is drawn to the limitation of liability, indemnification and jurisdiction issues defined therein. Any holder of this document is advised that information contained hereon reflects the Company's findings at the time of its intervention only and within the limits of Client's instructions, if any. The Company's sole responsibility is to its Client and this document does not exonerate parties to a transaction from exercising all their rights and obligations under the transaction documents. This document cannot be reproduced except in full, without prior written approval of the Company. Any unauthorized alteration, forgery or falsification of the content or appearance of this document is unlawful and offenders may be prosecuted to the fullest extent of the law. Unless otherwise stated the results shown in this test report refer only to the sample(s) tested and such sample(s) are retained for 30 days only.
Attention: To check the authenticity of testing /inspection report & certificate, please contact us at telephone: (86-755) 8307 1443, or email: CN.Doccheck@sgs.com

No.10, Weiye Road, Innovation Park, Kunshan, Jiangsu, China 215300
中国·江苏·昆山市留学生创业园伟业路10号 邮编 215300

t(86-512)57355888 f(86-512)57370818 www.sgs.com.cn
t(86-512)57355888 f(86-512)57370818 sgs.china@sgs.com