

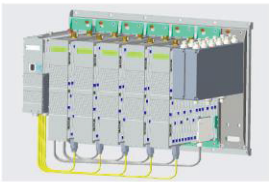

*Note: The following figures demonstrate the wall installation for low and high bands*

● Wall Installation (High bands and low bands RFU separated installed)



High Band Combinations

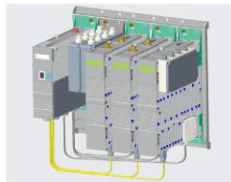

Low Band Combinations

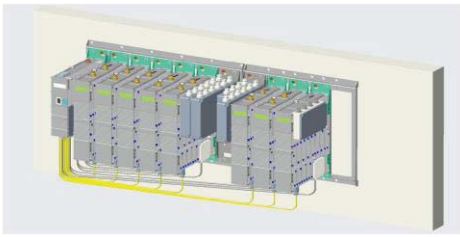



### 2.8.3.2 Connect the Internal cables (OEU to RFUs)

The internal cable connections include:

1. Connect the modules bottom panel CPRI connections (lower RFU and OEU panels)

*Note: the internal fibers are provided; the external fibers are not provided.*

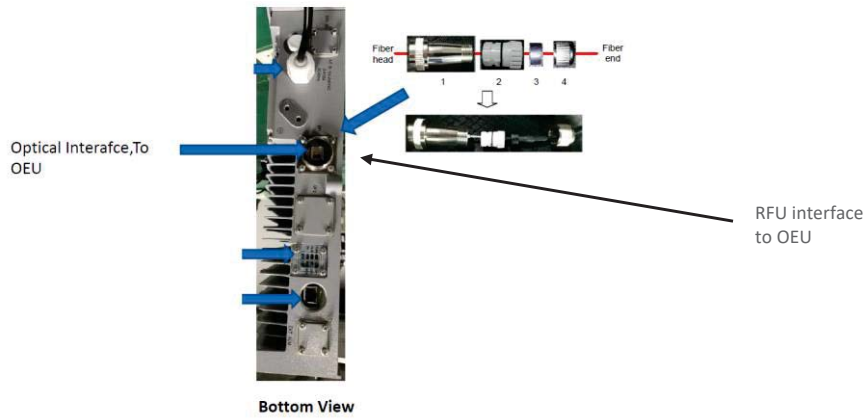
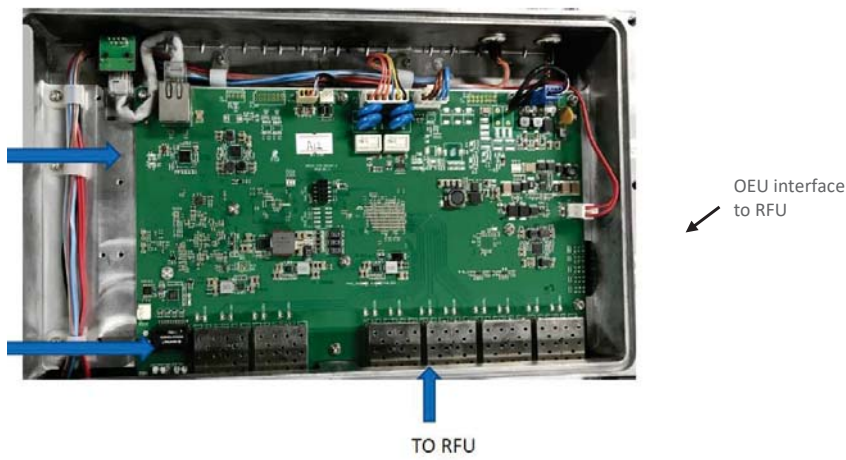

2. Connect the RF between the modules and the combiners in the upper panel (all jumpers – these are provided with the kit)



### 2.8.3.3 Connect the External cables (OEU to DRUs)

The following figure indicates the connections between the system and the DRU

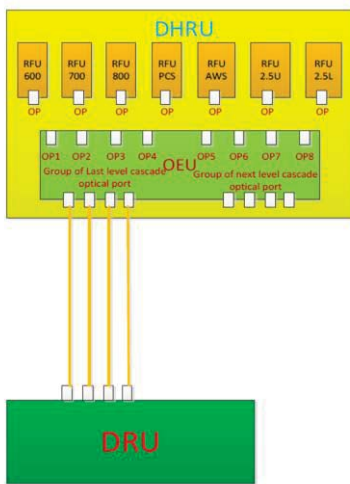

1. Connect the cables between the OEU and the DRU

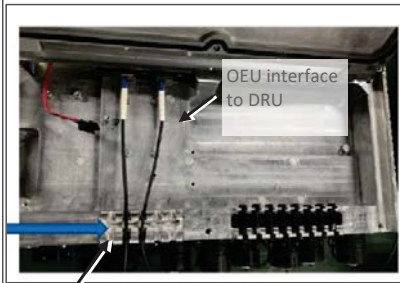
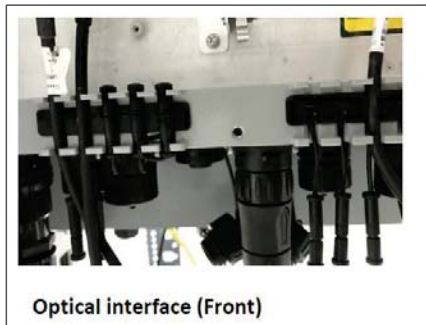

OEU to corning DRU

### 2.8.3.4 Connect the rest of the Cables

For each of the units, connect the cables as follows:

- Ground, see 2.8.3.4.1
- Power, see 2.8.3.4.2

#### 2.8.3.4.1 Connect Ground

*Note: Ground according to local regulations*

The following additional (not supplied) tools and components are required for connecting the system ground:

- Grounding wire - grounding wire should be sized according to local and national installation requirements. The provided grounding lug supports 14 AWG to 10 AWG stranded copper (or 12 AWG to 10 AWG solid) wire conductors.



1. Use a wire-stripping tool to remove approximately 0.4 inch (10.9 mm) of the covering from the end of the grounding wire
2. Insert the stripped end of the grounding wire into the open end of the grounding lug
3. Crimp the grounding wire in the barrel of the grounding lug. Verify that the ground wire is securely attached to the ground lug by holding the ground lug and gently pulling on the ground wire
4. Prepare the other end of the grounding wire and connect it to an appropriate grounding point at the site to ensure adequate earth ground



### 2.8.3.4.2 Connect AC Power

The AC power is connected to the OEU, and is distributed from the OEU to the modules

➤ **To connect the power**

1. Connect the AC power source to the OEU input power port

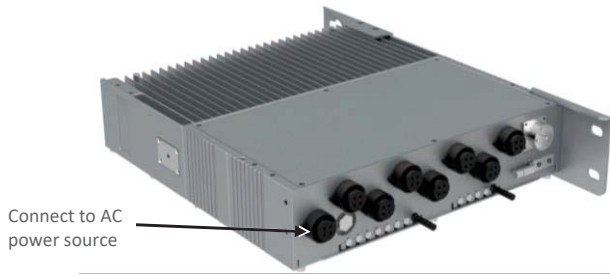



- 2. Connect each of the RFUs to an OEU power source distribution port

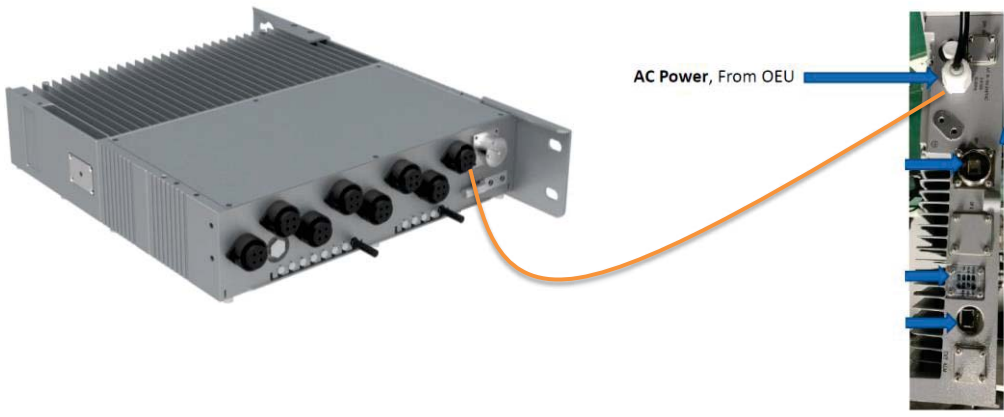

**2.8.3.5 Power up and Verify Normal Operation**

Power up the system, and verify normal operation according to the following LED guidelines

Status	Description	Color	State
<b>Power</b>	The RFU was powered up	Green	Solid
<b>RUN</b>	The RFU is up and running	Green	Blinking (1s)
<b>OP1</b>	The RFU is sync to the OEU	Green	Solid
<b>PA</b>	The PA of RFU is on	Green	Solid
<b>ALARM</b>	The RFU is alarm	Red	Solid



### 3. GUI – General Description

This section provides general guidelines and tools for navigating the system GUI:

- Screen layout, see 3.1
- Main menu options, see 3.2
- Default network settings, see 3.3
- Supported access options, see 3.4

#### 3.1 Screen Layout

The main menu (located to the left of the window) lists all the available management options.

Next to the main menu either the system tree or the corresponding sub-options are displayed. The display changes according to the option selected from the main menu.

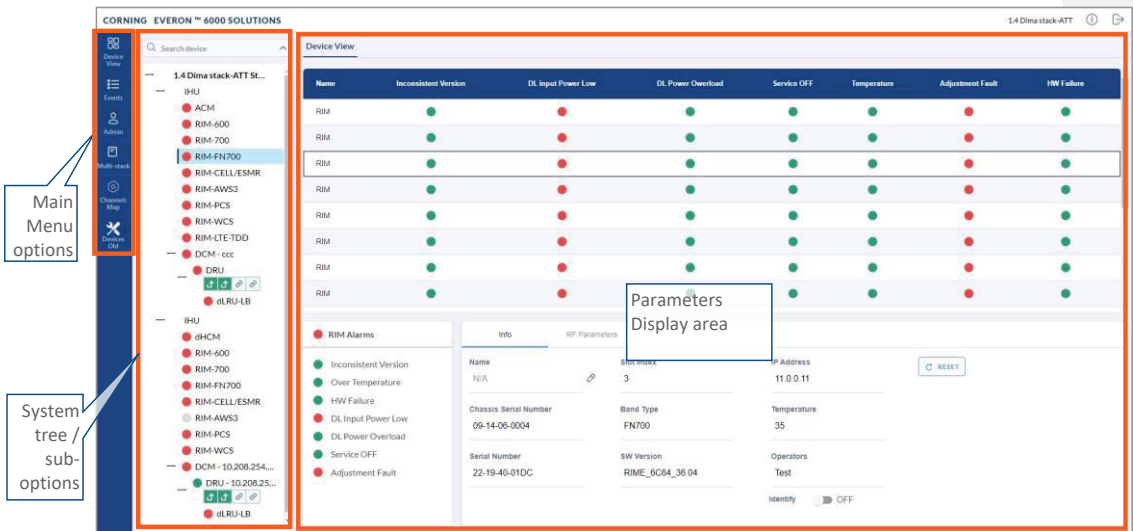









### 3.2 Main Menu Options

The table below lists the management options provided by the main menu:

Table 11: Main Menu Options

Icon	Enables user to...
 Devices	View the system topology and information about the different system elements.
 Events	View all system events and generate reports.
 Config	Perform initial system configurations. <b>This option is only visible to the system administrator.</b>
 Admin	Administrative options to perform system configurations, implement updates, define and monitor user's activity.
 Multi-stack	View the information of the different stacks of the system.
 Channels	Manage the system RF channels.



### 3.3 Default Network Settings

The system devices are managed via a web session to the headend control module (HCM) that is installed as either a headend unit (HEU) or integrated headend unit (IHU)



The HCM has three types of RJ45 Ethernet ports: LOCAL port, LAN port and four INTERNAL ports.

- LOCAL Port: 1 Gb Ethernet connection for a local setup session.  
By default, the port is configured to have a static IP address: 172.16.1.1; Subnet Mask: 255.255.0.0.  
Alternatively, the port can be configured as a DHCP server (connected to a DHCP client computer).

---

*Note: The LOCAL port is designated for a local connection. However, the port may be used for a remote session as well, for troubleshooting and service purposes. In any case, don't connect a network device to the port if it's configured as a DHCP server, as the server will disrupt the LAN IP addressing.*

---

- LAN Port: 1 Gb Ethernet connection to the customer's network for remote management.  
By default, the port is configured to have a static IP address: 192.168.1.1; Subnet Mask: 255.255.0.0.  
Alternatively, the port can be configured as a DHCP client.  
IPv4 and IPv6 network protocols can be simultaneously supported.
- INTERNAL Ports: Four RJ45, 100 Mb Ethernet ports used for management of connected ACMs.

---

*Note: Any one of these ports can also be used for a local connection if required.*

---

Default settings: IP: 10.0.0.1; Subnet Mask: 255.0.0.0

### 3.4 Supported Access Options

This section describes the HW and SW required to connect to the HCM.

First connection to the HCM should be done with a laptop or a tablet.

The following browsers are supported:

- Microsoft Internet Explorer 11.0 and above
- Mozilla Firefox 42.0, 43.0, and above
- Google Chrome 45.0, 46.0, and above

After the initial configurations are done, it is recommended to establish remote access to the HCM by using the following:

*LAN Ethernet connection to the HCM with a minimum connectivity and throughput capability of 256 Kbps.*



## 4. Session Access and first time settings

Once all the system elements are installed, the system administrator can log into the system GUI and perform initial configurations.

It is recommended to begin working with the Corning® Everon™ 6000 by following these steps:

1. **Open a local session to the HCM**, see Open a Local Session section 4.1.
2. **Configure the LAN IP settings** to allow remote access, see Remote Management section 4.2
3. **Perform the initial configurations** using the system GUI, see Commissioning, chapter 5

### 4.1 Open a Local Session

Below are the instructions for opening a local management session, to perform basic system configurations via the system GUI.

#### ➤ To Open the system GUI

1. Connect a computer (i.e., laptop) to the HCM LOCAL port via an RJ45 Cat 5 Ethernet cable, as shown below:



---

#### Notes:

\* The LOCAL port is set to a static IP Address by default: 172.16.1.1; Subnet Mask: 255.255.0.0. Your laptop/tablet network parameters must be set to match the subnet of the default IP address.

\* The laptop/tablet IP address must be different than the LOCAL port IP address.

2. Set up your laptop/tablet network parameters by following the steps below (the steps may vary slightly depending on the OS version used):



a. Go to the **Windows Settings** → **Network & Internet**

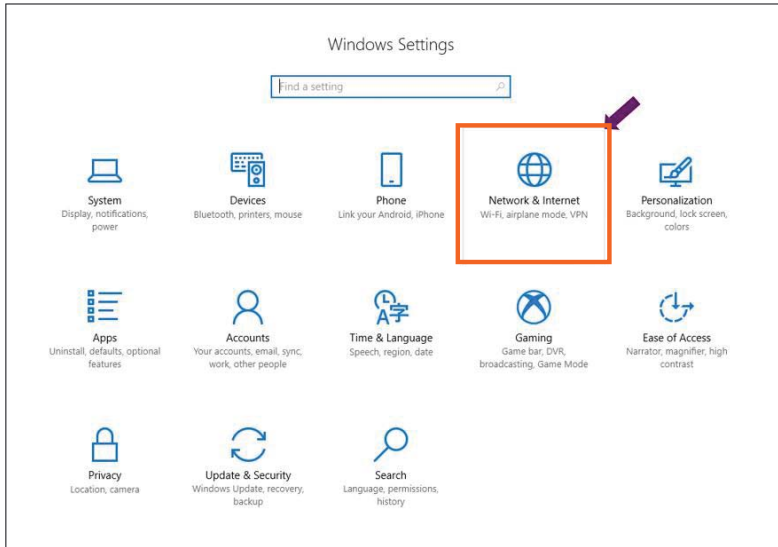

b. Select **Ethernet** → **Change adapter options**

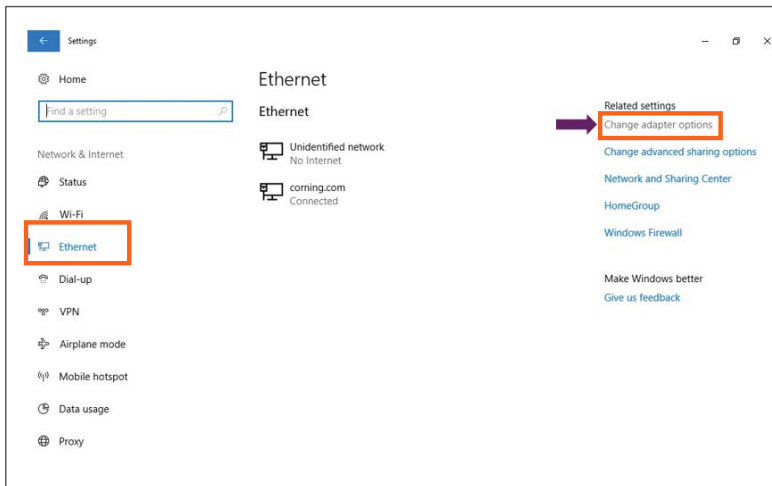



c. Right-click on **Ethernet USB adapter** and select **Properties**

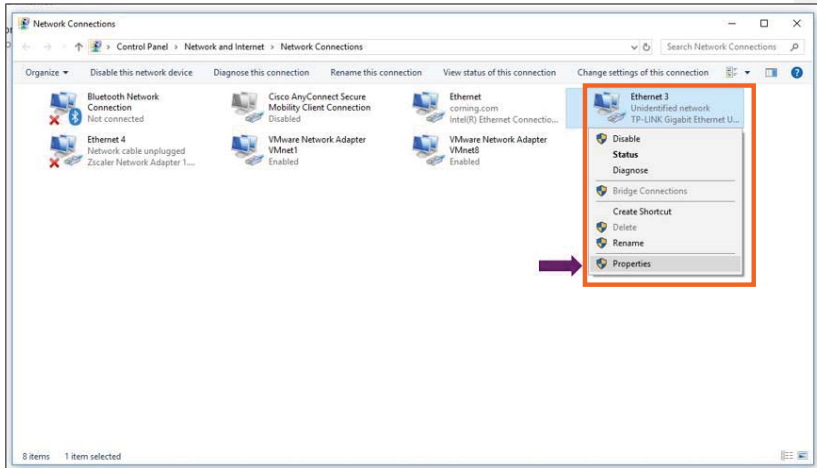

d. Select **TCP/IPv4** and click **Properties**

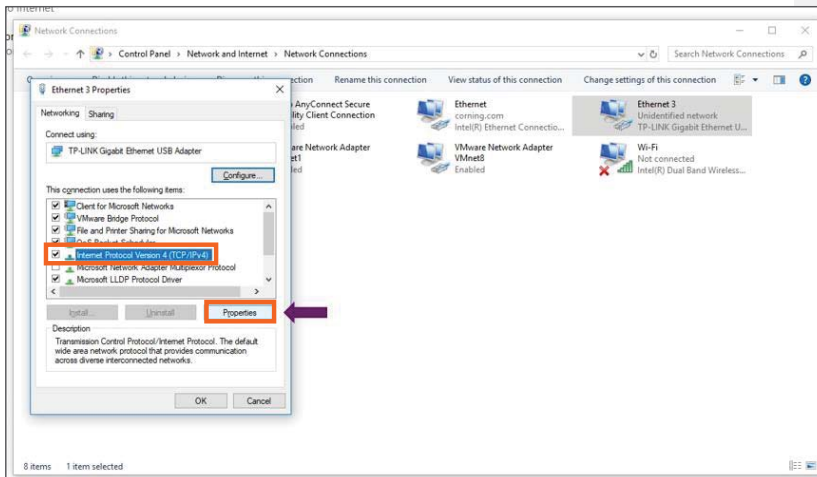



e. Type in the properties: 172.16.1.2 : 255.255.0.0 → click **OK**

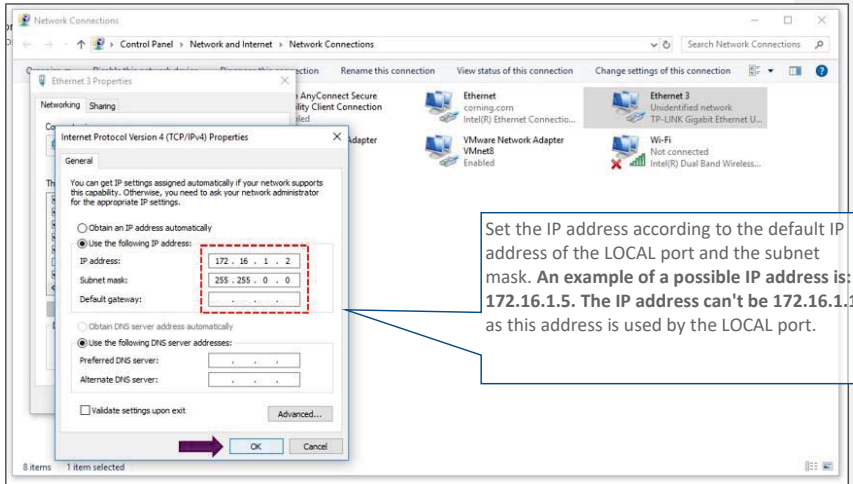

f. Click on **Close** and close the control panel

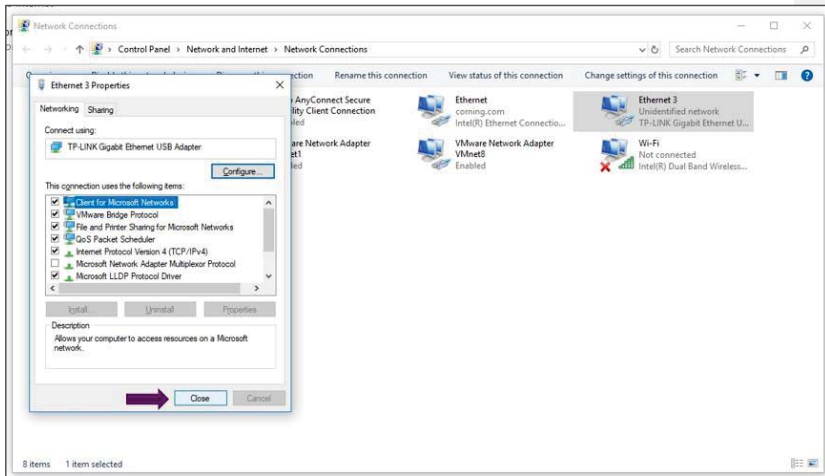

3. Once the connection is established (can be verified by accessing through command prompt: `cmd` → `ipconfig -h`), open a browser and type-in the LOCAL port default IP address in the address bar: 172.16.1.1. See section 4.2







## 4.2 Remote Management

After doing the preliminary configuration (see section 3.4 ), the system can be used for remote management, and needs to be configured as follows.

This section describes the configurations required for remote session access using Ethernet connection via the LAN port.

At this point the system is ready to be connected to the LAN according to the instructions below.

For HCM modules only – using the provided RJ45/RJ45 communication cable, connect the HCM LAN port to the corporate LAN:

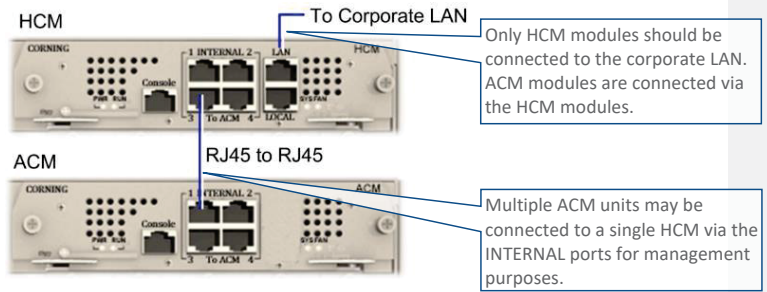

The LAN port is set to a static IP address by default: 192.168.1.1; Subnet Mask: 255.255.0.0.

### ➤ To configure the HCM LAN port

1. **IMPORTANT:** Make sure the HCM LAN port is connected to the corporate LAN.

2. In the main menu bar, click →
3. Select the **IPv4 LAN Port** or **IPv6 LAN Port** tabs and click the button.

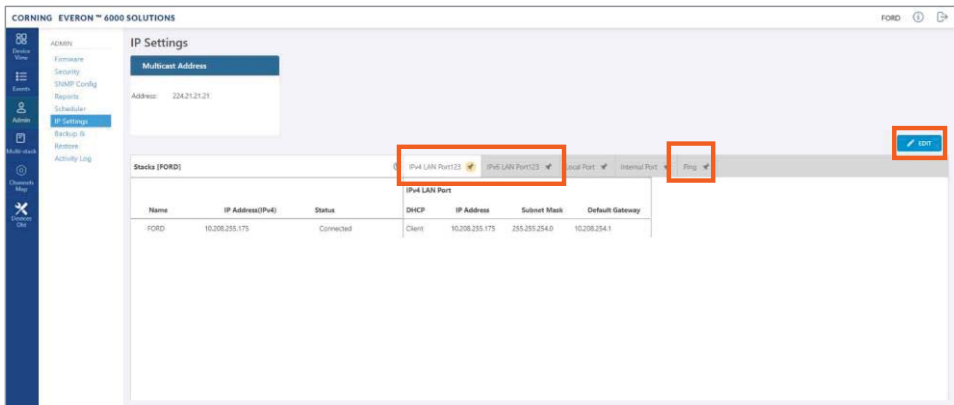

4. The LAN port is set to a static IP address, by default: 192.168.1.1; Subnet Mask: 255.255.0.0.  
You may change the **static IP address**, **subnet mask** and **default gateway** manually to legal IP values.

*Note: make sure the values you enter in the above fields aren't used by other system elements, and are different than the default values.*

*Make sure the address format matches IPv4 or IPv6, according to the tab being updated.*

For Dynamic IP Address — set **DHCP** as **Client**, then click **OK**.

5. The HCM restarts after the LAN IP address is updated.
6. To open a remote management session: Open a browser and enter the **LAN port IP Address** in the **address bar**.

*Note: A Ping Tool option is provided to verify access to IP hosts (rather than opening another application). For more information about the ping tool and the IP Settings tab refer to section 6.1.3.6.*

4. Once the connection is established (can be verified by accessing through command prompt: cmd → ipconfig -h), open a browser and type-in the LOCAL port default IP address in the address bar: 172.16.1.1.

The HCM Controller Log In dialog appears:

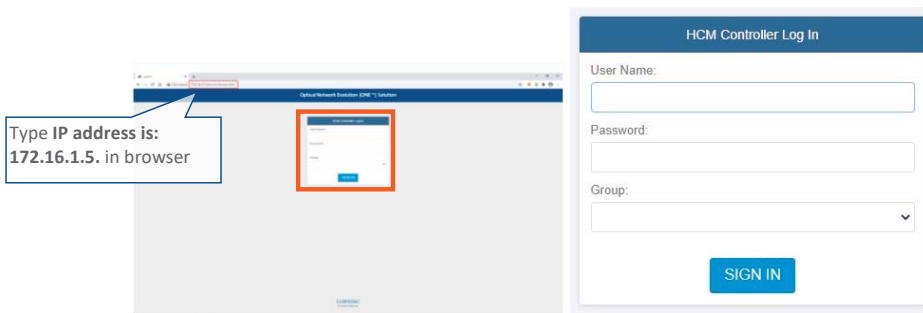

5. For first-time authentication use the following default values:

- Username: *admin*
- Password: *default provided with your system*
- Group: *leave blank*

**Note: IMPORTANT!** For security reasons it is highly recommended to immediately change the password (via the "Admin" -> "Security" tab) and log in again using the new password.

6. Click the "SIGN IN" button. System GUI main screen appears.



CORNING EVERON™ 6000 SOLUTIONS 1.4 Dima stack-ATT

Search device

Device View

Name	Inconsistent Version	Temperature	HW Failure	Adjustment Fault	Power Failure	FAM Failure	Pilot Clock Failed
ACM	●	●	●	●	●	●	●
gHCM	●	●	●	●	●	●	●

ACM Alarms

- Inconsistent Version
- Temperature
- HW Failure
- Adjustment Fault
- Power Failure
- FAM Failure
- Ext1 Clock Failed
- Ext2 Clock Failed
- Pilot Clock Failed

Power Supply

Power supply A	Power supply B
Temperature	Temperature
Output Under Voltage	Output Under Voltage
Input Under Voltage	Input Under Voltage

1.4 Dima stack-ATT SL...

1.4 Dima stack-ATT



7. Configure the IP settings (to allow working through LAN IP address and not only via the local port connection) as follows:

a. In the Device view Select **Admin**

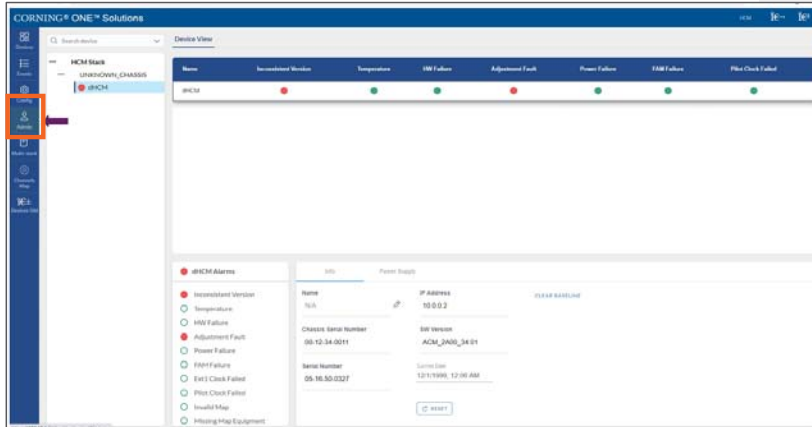

b. Select **IP Settings** and click on **Edit**

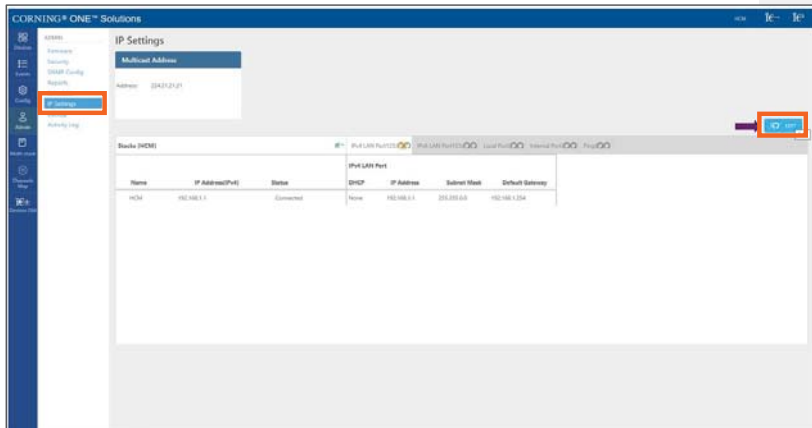



- c. Set internal ports to the required IP address (in this example 11.0.0.1)

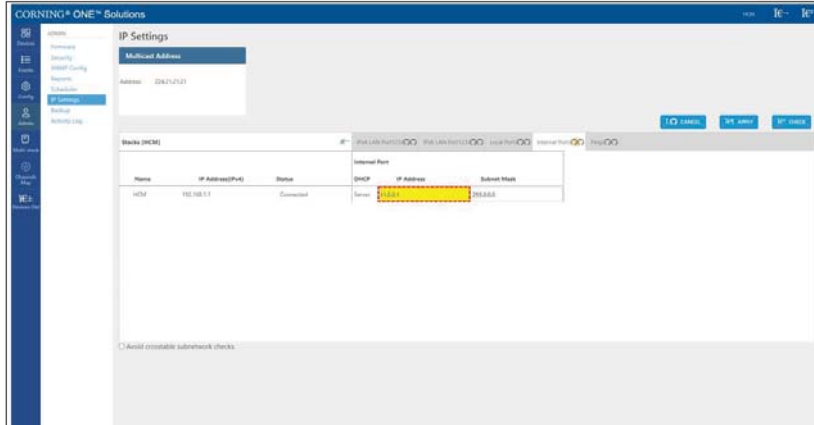

- d. Click on LAN port to display roll-down menu and select Client

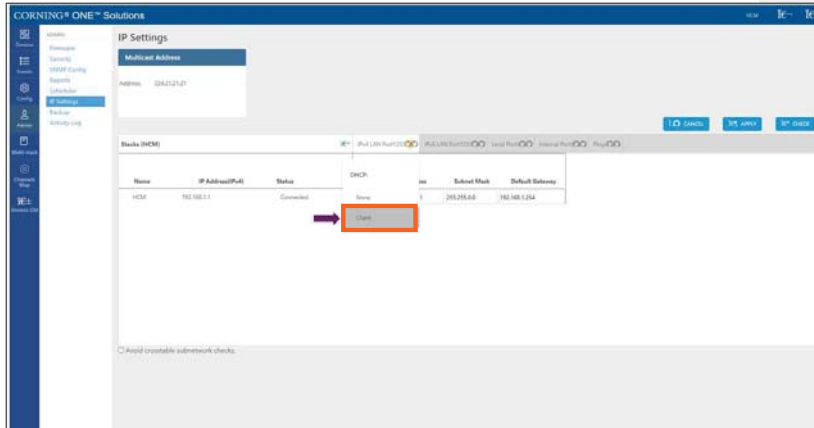



e. Click on **Apply**

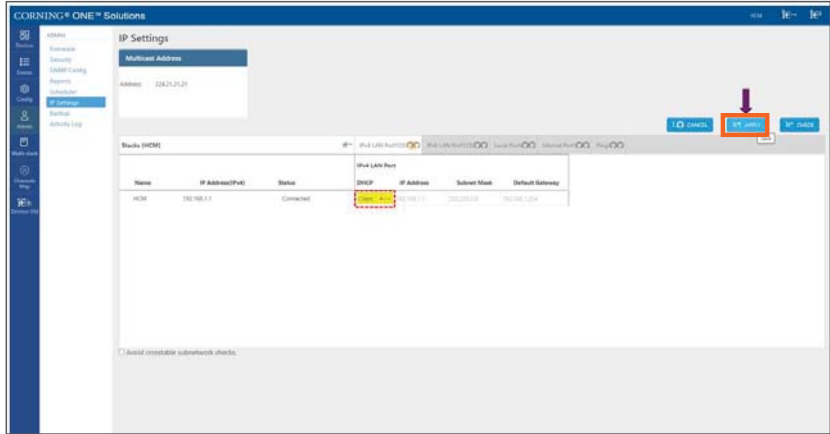

f. Enter the credentials





- g. Sign out of the application. Then re-access the application:  
In your browser address bar type the IP address again:

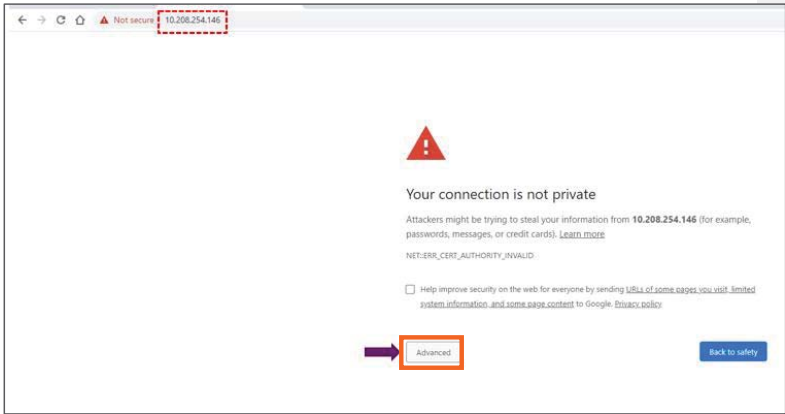

- h. Select advanced → proceed to (the IP address)

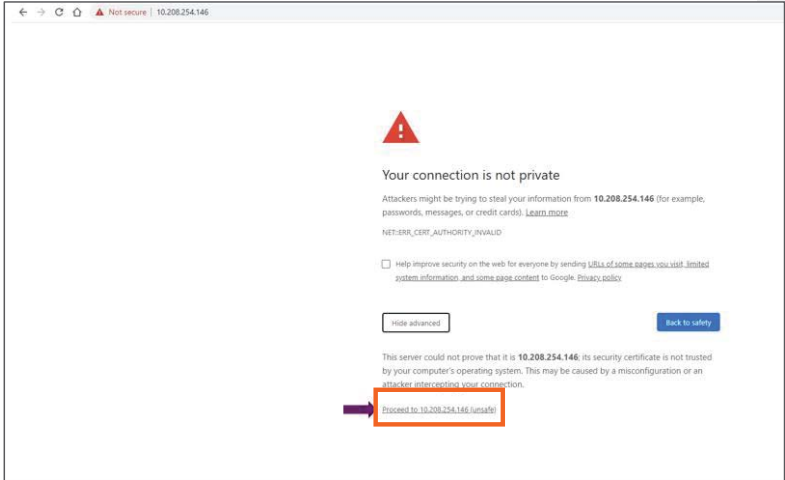

- i. The application appears.

## 5. Commissioning

This section describes all the initial configurations (commissioning) that **must** be done by the system administrator, in order to perform commissioning and to add operators. Also – to configure maps:

- Create new user operators, see 5.1
- Set the system parameters (site, power sharing, time, TDD, adjustment), see 5.2

### 5.1 Create new user operators

Initially the system administrator is the only system user. To enable other users to log in to the system, the system administrator must create user operators for the different providers/carriers.

When a new operator is created the administrator of the new operator must log in to add users to the operator.

Only the system administrator can create new operators.

For more information about system security refer to section 6.1.3.2.

#### ➤ To create a new operator

1. Log in as the **system** administrator.
2. In the main menu bar, click  → 
3. Click the **Add operator** button → enter the new operator name (alphanumeric characters only, no spaces) and click OK. Up to 31 operators can be created.
4. The new operator name is added to the list of defined operators and the operator administrator is automatically created with the following default authentication:
  - Username: admin
  - Password: admin
  - Operator: operator name

---

*Note: Default Passwords should be changed when the relevant users first log in to the system. See password changing flow below. System admin can't change the operator admin password.*

---





This is an example of how the new operator is listed in the **Security** tab:

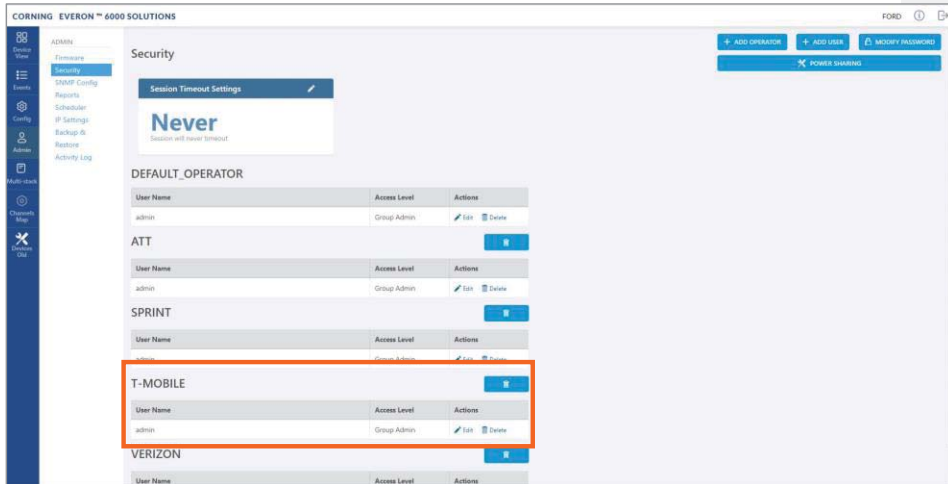

*Note: clicking on the Power Sharing option, displays a pop up window with a link to power sharing*

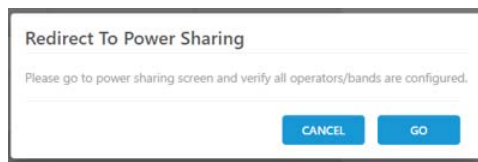

## 5.2 Set system parameters through Main Menu Config Option



The **Config** option in the main menu is only visible to the system administrator. This section describes the configurations that only the system administrator can perform.

### 5.2.1 Set Site config – auto set

#### ➤ To view the site config settings

1. Choose the **Site Config** option from the **Config** submenu. the following screen appears:

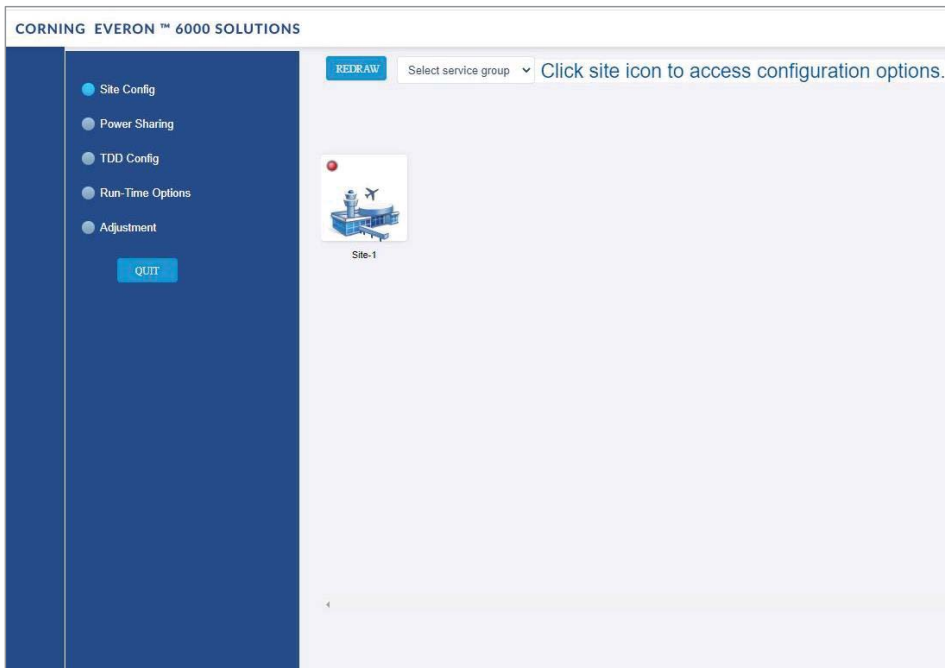

2. Each relevant site is presented by an image. By clicking on the site image, the configuration options for the specific site appear. The configuration options are described below Select the required option to be displayed:
  - a. Operator, see 5.2.1.1
  - b. RF path, see 5.2.1.2
  - c. Max input, see 5.2.1.3



### 5.2.1.1 Operator

The **Operator** tab shows all system chassis with the RIMs inside each chassis. It displays a full list of the operators in popup (so for large lists the user may scroll-down)

The user can click on a RIM to have the carrier name displayed. This view is read only, where changes to RIM carrier assignments can only be done via the **Channels** tab in the main menu.





### 5.2.1.2 RF Path

The **RF Path** tab enables the user to easily see which RIMs belong to which service operator.

A service operator consists of one or more RIMs which are connected to a DCM, and via a DRU to one or more remote units. Up to 2 service operators are supported. This view is read only.

A RIM can be selected to show to which service operator it belongs. Alternatively, a service operator can be selected to show all the RIMs which belong to it.

*Note Modules may not be set from this screen.*





### 5.2.1.3 Max Input

The **Max Input** tab allows the configuration of three parameters for each RIM:

- Max Expected Power - UL gain range enabled is determined by the max expected power setting
- UL Gain Mode - Set the UL Gain Mode for the selected RIM
- UL Gain Value – Set UL gain (dB) for the selected RIM

A single RIM can be clicked to be configured. Alternatively, an operator of RIMs can be configured by selecting a service operator, chassis or a frequency band.





### 5.2.2 Power Sharing

The **Power Sharing** tab shows all supported frequency bands and the carriers sharing each band.

The carriers are sharing the power associated with the frequency band.

The user needs to enter the power sharing parameters as follows:

For each band perform the following:

1. Select the band (in the example: AWS is selected)
2. Click on add new operator
3. Select the operator (not: if an operator is not selected – the data cannot be entered)
4. Select the parameters to configure the power sharing

5. Click on the V sign

6. Click on the SAVE button

**CORNING EVERON™ 6000 SOLUTIONS**

#### Power Sharing

Band	Power Sharing	Operator	Action
600	100%		+ ADD NEW OPERATOR
700	100%		+ ADD NEW OPERATOR
800/850	100%		+ ADD NEW OPERATOR
AWS	0%		+ ADD NEW OPERATOR
PCS	0%		+ ADD NEW OPERATOR
WCS	0%		+ ADD NEW OPERATOR
2.5TDD	0%		+ ADD NEW OPERATOR

**Configuration for AWS:**

- Operator: T-MOBILE
- Power Share: 55%
- Density: Even
- Buttons: X, ✓

**Buttons:** SAVE, Go Back To Config



### 5.2.3 Run time options

- **To perform run-time options**
  1. Select the **Run-Time options** radio button
  2. Click on **Submit**

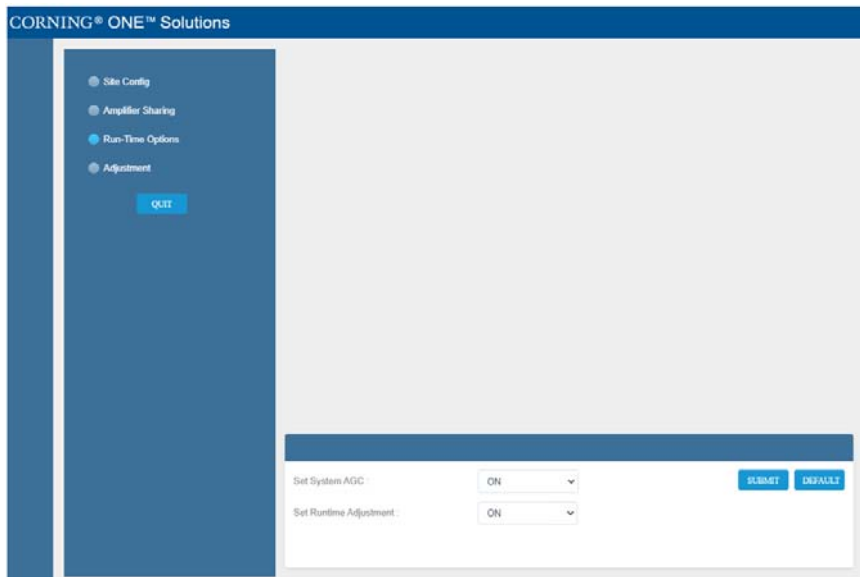



### 5.2.4 TDD Config

The **TDD Config** tab allows the user to configure TDD related parameters per stack.

- Site Config
- Power Sharing
- TDD Config
- Run-Time Options
- Adjustment

QUIT

TDD Configuration

4G Table

Sub Frame	1	2	3	4	5	6	7	8	9	10
	D	S	U	D	D	D	S	U	D	D

5G Table

Slot	1	2	3	4	5	6	7	8	9	10
	D	S	U	D	D	D	S	U	D	D

TDD 2.5 Config Form

Allocation Mode

2

CP Type

Normal

Frame Format

7

Sub Carrier Spacing [5G]

15

SAVE

➤ **To configure the TDD:**

1. For each of the screen's fields, click the arrow near the field to show the list of optional values.
2. Select the relevant value
3. At the end – click SAVE





### 5.2.5 Adjustment

The **Adjustment** tab allows the user to start the adjustment process. During adjustment the status and relevant information are updated for each process.

After completing the configuration above, perform Adjustment.

➤ **To perform adjustment:**

1. Select the **adjustment** radio button
2. Click on **Start Adjustment** (default values: *Do not run sensitive mode; Do not run BIT*)

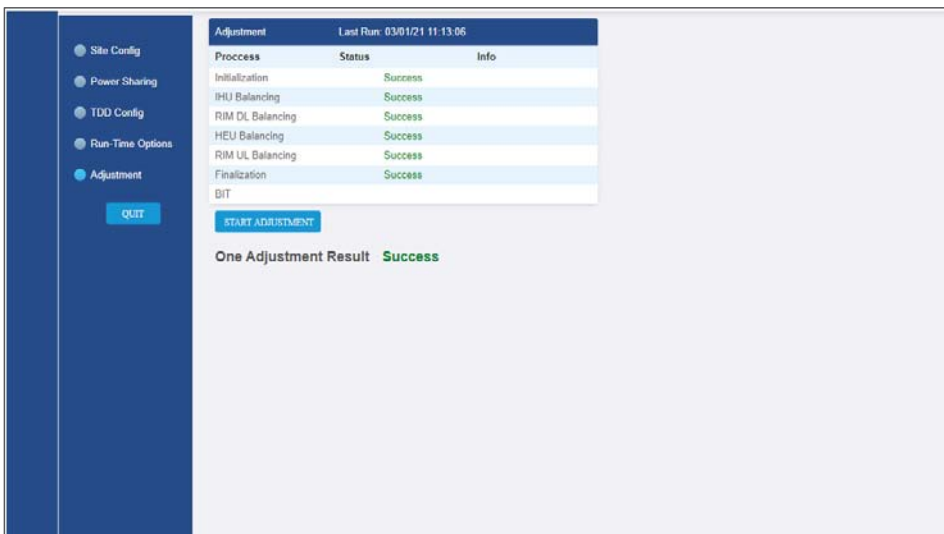

The process runs automatically, and returns the status (successful / failed)



## 6. Using the System Graphical User Interface (GUI)

This section describes the system GUI options.

### 6.1 Main GUI Options

The main menu options are described below.

#### 6.1.1 Devices Screen – Element Management

The Devices option provides visual information on the system layout, connected units and hierarchy, alarms etc. The system elements hierarchy tree is detected via an auto-discovery process, executed upon system start-up.

The system units' alarms are indicated according to severity, type, masked/unmasked alarms, etc. These coding icons are detailed in Table 12 below.

When choosing **Devices** from the main menu, the following screen appears (the displayed system tree is updated according to system topology):

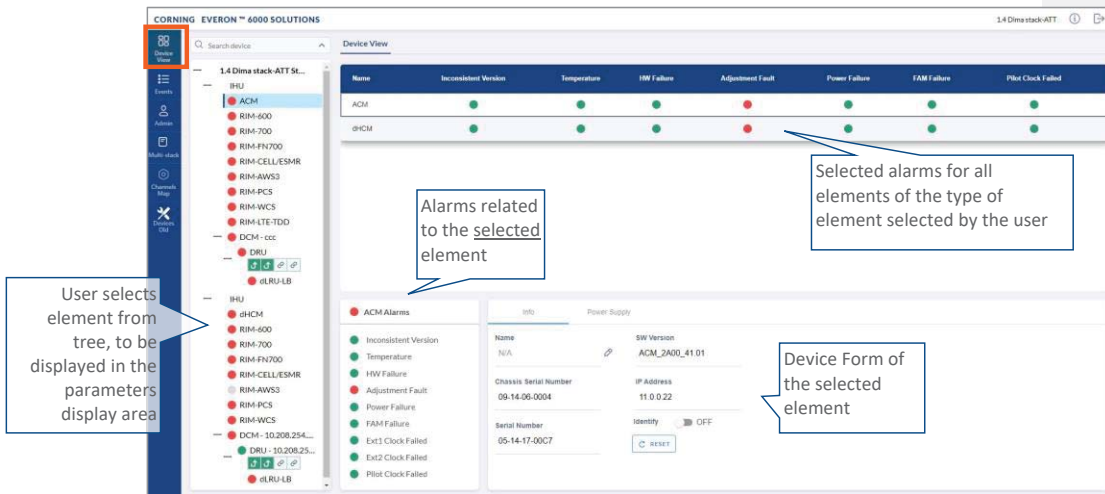

Figure 16: Devices Screen

*Note: The same DRU may appear in the system tree multiple times if it is connected to different DCMs. For details see section 6.1.1.9 DRU to DCM Connection.*













**6.1.1.1 System Tree Alarm icons**

This section includes a description of the different alarm icons.

For each element, the system displays the most severe status in the system tree. Each device status is indicated by a coloured circle to its left, according to the symbols shown in the table that follows.

Table 12: Alarm Icons

Icon Unmasked	Masked	Indicates that...
 Red circle		There is a major alarm related to the element
 Green circle		No alarm is related to the element
 Orange circle		There is a minor alarm related to the element
		Unit is disconnected
		Indication on DRU-DCM connection – no alarms
		Indication on DRU-DCM connection – major alarm
		Indication on DRU-DCM connection – minor alarm
		Indication on DRU-DCM connection – no DCM connected to this DRU port

Any status changes are reported via SNMP to a monitoring system. If an alarm is masked, it isn't reported to the monitoring system. In addition, the system events log, lists only unmasked alarms which were set or unset. Unmasked alarms are listed separately (see section 6.1.2).

The status of the element in the system tree doesn't change due to alarm masking.

For example: DCM status icon is red due to HW Failure alarm. If HW Failure alarm is masked, DCM status icon remains red.

### 6.1.1.2 Lists of alarms per system element

The following tables details all the alarms per system element type.

Table 13: HCM Alarms Descriptions

Alarm Name	Description
HW Failure	Faulty HCM hardware.
Adjustment Failure	Unsuccessful Adjustment procedure.
Installation Failure	Faulty physical installation between chassis.
SW Release Mismatch	A module (or modules) in the system do not have the defined active release. Several modules may not have corresponding software versions.
Connectivity	Faulty connectivity state in one of the previously discovered system modules (module should appear gray in the network topology).
Overall Status	Overall status of enabled (unmasked) alarms.

Table 14: ACM Alarms Descriptions

Alarm Name	Description
Overall Status	Overall status of enabled (unmasked) alarms.
HW Failure	ACM faulty hardware upon initialization or during operation.
Over Temperature	Ambient temperature inside the ACM is greater than 75°C.
Inconsistent Version/ SW Version	The module does not have the defined active release.
Adjustment Fault	Unsuccessful Adjustment procedure.
Ext1/Ext2 Clock Failed	Failure in master reference clock. Only relevant when ACM is installed in an HEU or IHU chassis as follows: <ul style="list-style-type: none"> <li>•For ACM installed in an HEU chassis - Ext1/Ext2 Clock Failed are relevant.</li> <li>•For ACM installed in an IHU chassis - only Ext1 Clock Failed alarm is relevant.</li> </ul>
Pilot Clock Failed	Relevant for IHU and OIU. Indicates failure in reference in the pilot clock in the OIX Expander.
Fan Failure	Fault in at least one of the fan modules (i.e., fan does not match duty cycle set value). Displays the highest severity alarm.
Power Failure	Power failure in one or both (if two are installed) of the PSMs.
Output Under Voltage	The ACM has detected an input voltage value under 10.8 V DC from one of the PSM modules (severity – minor) or both (severity – major) during three consequent samplings.
Input Under Voltage	The ACM has detected an input voltage value of under 60 V AC from either one PSM module (severity – minor) /both PSMs (severity – major).

Table 15: RIM Alarms Descriptions

Alarm Name	Description
Overall Status	Overall status of enabled (unmasked) alarms.
HW Failure	Hardware failure during startup or during normal operation.
Over Temperature/Temp	Ambient temperature inside the RIM is more than 75°C.
Inconsistent Version/SW Version	The module does not have the defined active release.
Adjustment Fault	Unsuccessful adjustment procedure for the selected module.
Service State	Service has been disabled by the user.
DL Input Power Low	BTS RF power input to the RIM is at least 15 dB lower than the configured max expected power.
DL Power Overload	BTS RF power input to the RIM is at least 3 dB higher than the value measured during the adjustment procedure.
Sync Loss Only applicable for RIM TDD	Green — indicates TDD sync lock between RIM and input signal. Red — TDD sync lock error (unlocked).
Clock Synthesizer Only applicable for RIM TDD	UL/DL Synthesizer and Reference Clock lock/unlock status.
Band Mismatch Only applicable for RIM AWS	RIM bands are overlapping.

Table 16: DRU Alarms Descriptions

Alarm Name	Description
Inconsistent Version	The module does not have the defined active release.
Temperature	Ambient temperature inside the DRU is high
HW Failure	DRU faulty hardware upon initialization or during operation.
Overall Optical DCM Links	Overall status of enabled (unmasked) alarms in input links.
Overall Optical RU Links	Overall status of enabled (unmasked) alarms in output links.

Table 17: DCM Alarms Descriptions

Alarm Name	Description
Inconsistent Version	The module does not have the defined active release.
Temperature	Ambient temperature inside the DCM is high
HW Failure	DCM faulty hardware upon initialization or during operation.
Adjustment Fault	Unsuccessful Adjustment procedure.
Overall Optical Links	Overall status of enabled (unmasked) alarms in output optical links.

Table 18: dLRU/dMRU/dHRU Alarms Descriptions

Alarm Name	Description
HW_ALARM	Indicates <b>un-recoverable</b> HW failure. Applicable for module or sub-module.
TEMP_ALARM_Minor_X	Over temperature indication. X is sensor number.
TEMP_ALARM_Critical_X	Critical temperature indication. X is sensor number.
SERVICE_OFF_X	X band is OFF. Only applied if there is a channel in that band, but band is OFF.
ANT	Antenna issues.
UL_LIMITER_X	UL limiter active due to high UL signal at antenna. X is band number.
DL_RF_LOW_X	X channel power at CPRI input is low.
CLK	CLK/CPRI un-synchronized.
DISCONNECTED_PORT	dLRU/dMRU/dHRU ports connected to different DRUs.
LOW_TRANSMISSION_ALARM	Digital power and analog power mismatch.
OVERFLOW	Digital signal overflow.
VSWR_X	VSWR alarm on band X.

Alarm Name	Description
SELF_PROTECTION	Self-protection alarm
TDD_OUT_OF_SYNC	The TDD band lost the sync on the TDD pattern.
PA_OVERCURRENT	The current consumption of the PA exceeds the limit.
CONNECTION_ERROR	Connection error

The following table lists alarms related to the CPRI protocol. These alarms are relevant for the optical links that some of the system elements have (see sections 6.1.1.6 - 6.1.1.8 below).

*Table 19: CPRI Alarms Descriptions*

Alarm Name	Description
LOS	Loss of signal.
LOF	Loss of frame synchronization.
RAI	Remote alarm indication.
SDI	SAP (service access point) default indication.
Certified SFP	Indicates whether SFP certified.



### 6.1.1.3 HCM Device Form

The device form of an HCM has a single tab: **Info**. The Info tab includes general information about the system element:

Info

---

<p><b>Name</b></p> <p>Sergeysdfsd </p>	<p><b>SW Version</b></p> <p>1.4</p>
<p><b>Chassis Serial Number</b></p> <p>22-19-24-08B9</p>	<p><b>Current Date</b></p> <p>9/29/2020, 10:37 PM</p>
<p><b>Serial Number</b></p> <p>NDD590012</p>	
<p><b>IP Address</b></p> <p></p>	

Table 20: HCM Info Device Form Fields

Field	Information
Name	The name of the element as it appears in the system tree.
Chassis Serial Number	The serial number of the chassis the HCM resides in.
Serial Number	The serial number of the HCM.
IP Address	The IP address of the HCM.
SW Version	SW version updated in HCM.
Current Date	Current system date and time.





**6.1.1.4 ACM Device Form**

The device form of an ACM has two tabs: **Info** and **Power Supply**. The Info tab displays general information about the system element:

Info	Power Supply
<b>Name</b> ACM1	<b>IP Address</b> 11.0.0.13
<b>Chassis Serial Number</b> 09-14-06-0001	<b>Identify</b> <input type="checkbox"/> OFF
<b>Serial Number</b> 05-14-34-019F	
<b>SW Version</b> ACM_2A00_33.04	

Table 21: ACM Info Device Form Fields

Field	Information
Name	The name of the element as it appears in the system tree
Chassis Serial Number	The serial number of the chassis the ACM resides in
Serial Number	The serial number of the ACM
SW Version	SW version updated in ACM
IP Address	The IP address of the ACM
Identify (ON/OFF switch)	When the switch is ON the ACM LEDs are blinking (can be used to identify the specific module among many other modules).



The **Power Supply** tab shows the relevant alarms status for both power supplies. There are two power supplies for backup and the switch between the power supplies is automatic. Explanation of the alarms can be found in section 6.1.1.2, under ACM Alarms Descriptions. In the example below there are no alarms related to any of the power supplies.

Info	Power Supply								
	<table border="0"> <tr> <td><b>Power supply A</b></td> <td><b>Power supply B</b></td> </tr> <tr> <td><input type="radio"/> Temperature</td> <td><input type="radio"/> Temperature</td> </tr> <tr> <td><input type="radio"/> Output Under Voltage</td> <td><input type="radio"/> Output Under Voltage</td> </tr> <tr> <td><input type="radio"/> Input Under Voltage</td> <td><input type="radio"/> Input Under Voltage</td> </tr> </table>	<b>Power supply A</b>	<b>Power supply B</b>	<input type="radio"/> Temperature	<input type="radio"/> Temperature	<input type="radio"/> Output Under Voltage	<input type="radio"/> Output Under Voltage	<input type="radio"/> Input Under Voltage	<input type="radio"/> Input Under Voltage
<b>Power supply A</b>	<b>Power supply B</b>								
<input type="radio"/> Temperature	<input type="radio"/> Temperature								
<input type="radio"/> Output Under Voltage	<input type="radio"/> Output Under Voltage								
<input type="radio"/> Input Under Voltage	<input type="radio"/> Input Under Voltage								

**6.1.1.5 RIM Device Form**

The device form of a RIM has at least two tabs: **Info** and **RF Parameters**. A RIM which supports TDD also has a **TDD** tab in its Device Form. The Info tab displays general information about the system element:

Info	RF Parameters	TDD
Name LTE Band 14	Slot Index 8	IP Address 11.0.0.12
Chassis Serial Number 22-19-24-08B9	Band Type 14	Temperature 38
Serial Number 22-20-11-0068	SW Version RIMT_6B64_36.03	Carrier 0
		Identify <input type="checkbox"/> OFF



Table 22: RIM Info Device Form Fields

Field	Information
Name	The name of the element as it appears in the system tree.
Chassis Serial Number	The serial number of the chassis the RIM resides in.
Serial Number	The serial number of the RIM.
Slot Index	The number of the slot in the chassis the RIM resides in.
Band Type	Band number according to LTE frequency bands. Band number is mapped directly to a frequency range.
SW Version	SW version updated in RIM.
IP Address	The IP address of the RIM.
Temperature	Current temperature of the RIM.
Carrier	Identification of the supplier the RIM belongs to (telecommunications company).
Identify (ON/OFF switch)	When the switch is ON the RIM LEDs are blinking (can be used to identify the specific module among many other modules).

The RF Parameters tab includes information about the RIM UL and DL signals:



Table 23: RIM RF Parameters Device Form Fields

Field	Information
DL Power Detector[dBm]	Power of base station down link transmission. Range is -10 to +37[dBm].
Automatic Limit Control (ON/OFF switch)	enable (On = default)/disable (Off) ALC function for RIM
Service State (ON/OFF switch)	Service State OFF simulates RIM is disconnected. Transmission disabled by user.
Max Exp. Power [dBm]	User defined max power for the base station transmission. An alarm is triggered if the value in DL Power Detector field deviates from this value.
UL Gain Mode	Auto Symmetrical – equalizes the UL Gain Manual (default) – select a value in the range of -19 dB to +15 dB (in 1dB steps). Note that the enabled UL gain range is determined by the max expected power setting.
UL Gain [dBm]	The configured maximum expected power determines the maximum UL gain range enabled for configuration

Table 24: Max Expected Power Settings

Max Expected Power Value [dBm]	Max UL Gain Range [dB]
0	-19 to +10
1	-19 to +11
2	-19 to +12
3	-19 to +13
4	-19 to +14
5 to 37	-19 to +15



A RIM which supports TDD (Time Division Duplexing) has an additional tab: **TDD**

Info	RF Parameters	TDD
<b>UL/DL Allocation Mode</b> <input type="text" value="2"/>		<b>Clock Alarms</b> <input type="radio"/> UL Synthesizer Unlocked <input type="radio"/> DL Synthesizer Unlocked <input type="radio"/> Reference Clock Unlocked
<b>CP Type</b> <input type="text" value="0"/>		
<b>S Frame Format</b> <input type="text" value="7"/>		
<b>Central Frequency (MHz)</b> <input type="text" value="2593"/>		

Table 25: RIM TDD device form fields

Field	Information
UL/DL Allocation Mode	0 to 6
CP Type	Cycle Prefix: Normal/Extended
S Frame Format	0 to 8
Central Frequency (MHz)	Low – 2526 Medium – 2593 High – 2660 Custom – 2526 to 2660 (0.1MHz steps)



### 6.1.1.6 DCM Device Form

The device form of a DCM element has two tabs: **Info** and **Optical Links**. The Info tab has general information about the system element.

Info		Optical Links	
Name	Slot Index	Carrier	
First		1	
Chassis Serial Number	SW Version	Identify	<input checked="" type="checkbox"/> ON
1234567			
Serial Number	IP Address		
123456	192.168.1.1		

Table 26: DCM Info Device Form Fields

Field	Information
Name	The name of the element as it appears in the system tree.
Chassis Serial Number	The serial number of the chassis the DCM resides in.
Serial Number	The serial number of the DCM.
Slot Index	The number of the slot in the chassis the DCM resides in.
SW Version	SW version updated in DCM.
IP Address	The IP address of the DCM.
Carrier	Identification of the supplier the DCM belongs to (telecommunications company).
Identify (ON/OFF switch)	When the switch is ON the DCM LEDs are blinking (can be used to identify the specific module among many other modules).



The **Optical Links** tab has information about the optical links of the DCM. Each optical link displays the colour of the most severe alarm related to it. In the example below, links 1 and 3 have no alarms, link 2 has a major alarm and link 4 has a minor alarm.

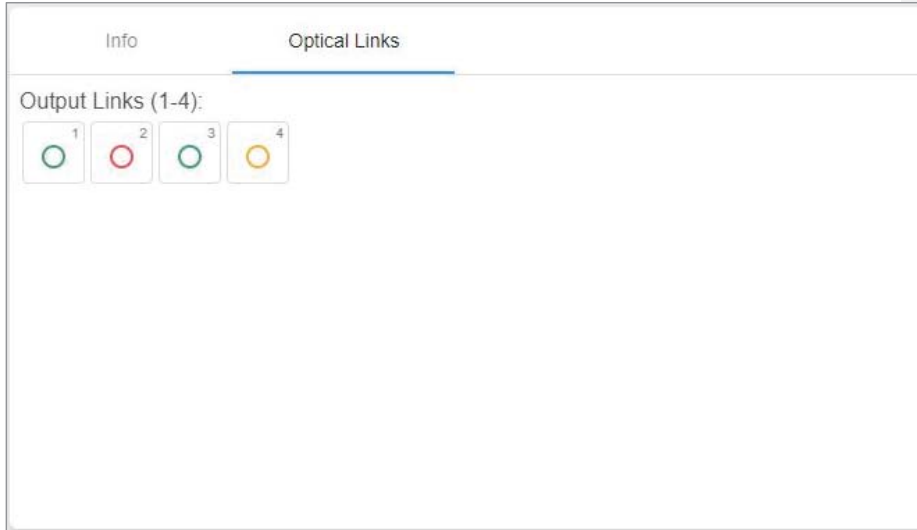

**6.1.1.7 DRU Device Form**

The device form of a DRU element has two tabs: **Info** and **Optical Links**. The Info tab has general information about the system element:





Table 27: DRU Info device form fields

Field	Information
Name	The name of the element as it appears in the system tree.
Serial Number	The serial number of the DRU.
SW Version	SW version updated in DRU.
IP Address	The IP address of the DRU.
Identify (ON/OFF switch)	When the switch is ON the DRU LEDs are blinking (can be used to identify the specific module among many other modules).

The Optical Links tab shows information about the optical links of the DRU. Each optical link indicates the colour of the most severe alarm related to it. The DRU can have up to 4 optical input links and 32 optical output links.

The user can click on one of the inputs or outputs to view information about the link. In the example below output link number 6 was clicked and the information about this link is displayed:

The screenshot shows a web interface for configuring optical links. It is divided into two main sections: 'Input Links (1-4)' and 'Output Links (1-32)'. The 'Output Links' section is active, showing a grid of 32 ports. Port 6 is highlighted with a blue border. To the right of the grid, the configuration details for 'Port Number 6' are displayed in a form:

- IP Address:** 11.0.0.11
- Part Number:** 998
- SFP Tx Level [dBm]:** 59
- SFP Temperature [C]:** 25
- SFP Rx Level [dBm]:** 89
- SFP VCC [V]:** 89

Below the configuration fields, there are two columns of alarm status indicators:

- SFP Alarms:** IO Error, Certified SFP, 64/66 Errors.
- CPRI Alarms:** LOS, LOF, RAI, SDI.

All alarm indicators are currently turned off (radio buttons are not selected).





### 6.1.1.8 dLRU/dMRU/dHRU Device Form

The device form of a dL/M/HRU element has three tabs: **Info**, **Supported Bands** and **Optical Links**. The Info tab has general information about the system element:

Info	Supported Bands	Optical Links
<b>Name</b> I'm remote Align		<b>HE Chassis SN</b> 123-456-789
<b>Serial Number</b> 17-897-1563-5	<b>DRU's Ports</b> 1,4,17	
<b>SW Version</b> Digital-YadaYada	<b>Temperature [C]</b> 25	
	<b>Identify</b> <input type="checkbox"/> OFF	

Table 28: dLRU/dMRU/dHRU Info Device Form Fields

Field	Information
Name	The name of the element as it appears in the system tree.
Serial Number	The serial number of the dL/M/HRU.
SW Version	SW version updated in dL/M/HRU.
HE Chassis SN	The serial number of the Head End chassis the dL/M/HRU is connected to.
DRU's Ports	The DRU ports the dL/M/HRU is connected to. Same dL/M/HRU can be connected to several DRU ports.
Temperature	The current temperature of the dL/M/HRU.
Identify (ON/OFF switch)	When the switch is ON the dL/M/HRU LEDs are blinking (can be used to identify the specific module among many other modules).



The **Supported Bands** tab lists all the bands supported by the dL/M/HRU. Clicking on a band shows the band information. In the example below information about the AWS band is displayed:

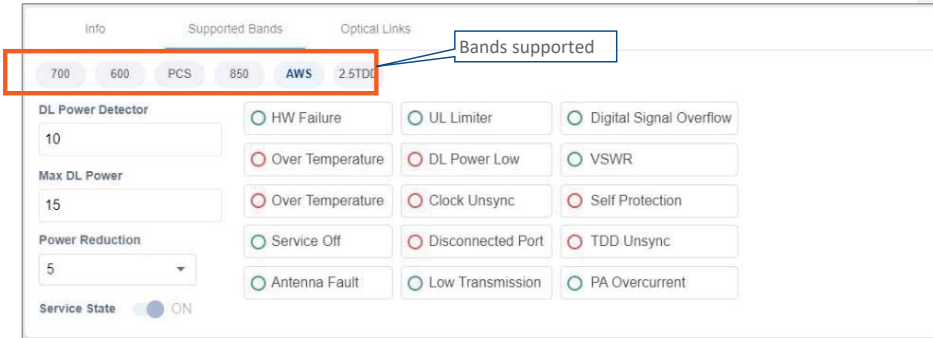

The **Optical Links** tab has information about the optical links of the dL/M/HRU. Each optical link indicates the colour of the most severe alarm related to it. When clicking on one of the inputs, information about the link appears. In the example below there are 3 input links because the DRAUL is connected to 3 DRU ports. link number 2 was clicked and the information of this link is displayed:

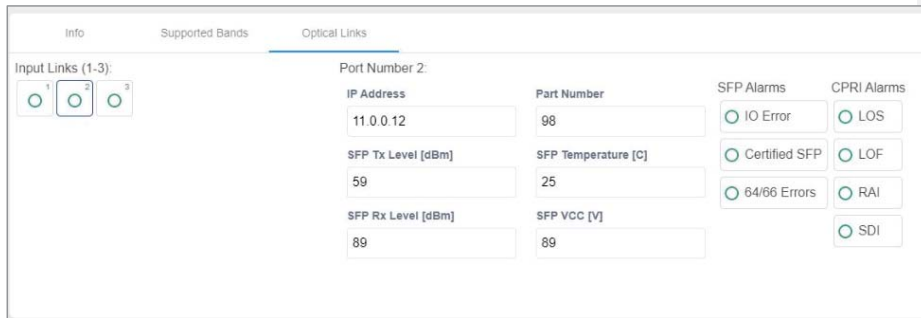



### 6.1.1.9 DRU to DCM Connection

➤ **Example: DRU to DCM(s) Connection**

The following figures indicate connectivity between DRU and DCM(s). For DRU the device status per DCM is shown in the following manner:

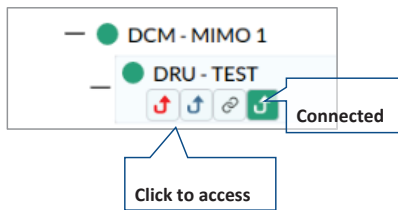

The number of arrows is the number of DCMs the DRU is connected to. The user may skip between the DRUs connected DCMs by clicking the arrow of the desired DCM.

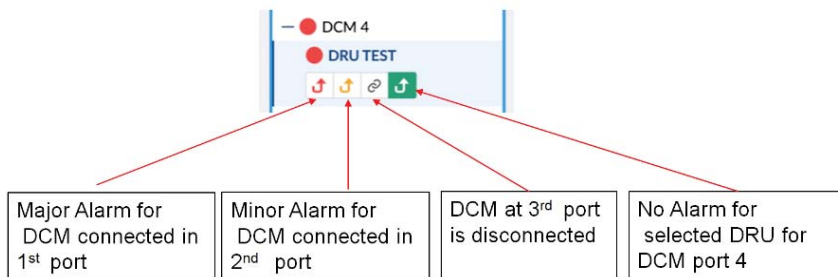

Figure 17: Example – alarms for connected DCMs



### 6.1.2 Events Screen

The events option provides indications on the different events in the system. This includes: alarms, upgrades, admin-actions, etc. The events may be sorted according to the time they occurred, severity, source, etc. The user may choose to display the alarms history, masked alarms or active alarms.

When choosing Events from the main menu the following screen appears:

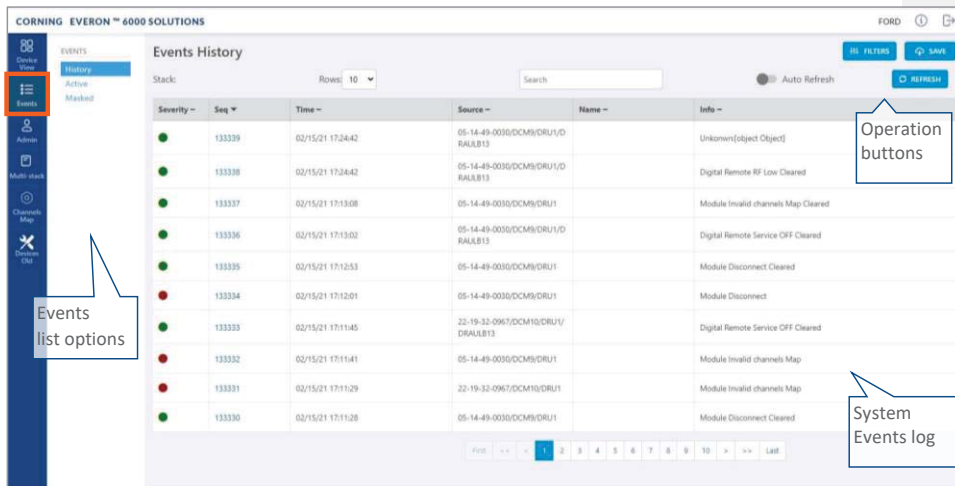

Figure 18 Events Screen

Table 19: Events Screen Sub-Options

Tab	Information	Screen Example (
History	View all events in a certain time period.	
Active	View events which are currently active.	
Masked	View events which are masked by user.	



Tab	Information	Screen Example (
	Set filters for displayed events	
	Save to file	
	Refresh screen view	

### 6.1.3 Admin Screen

The admin screen allows the user to define administrators, update credentials, upgrade firmware, generate reports and other admin options as detailed in the table below. When choosing **Admin** from the main menu the following screen appears:

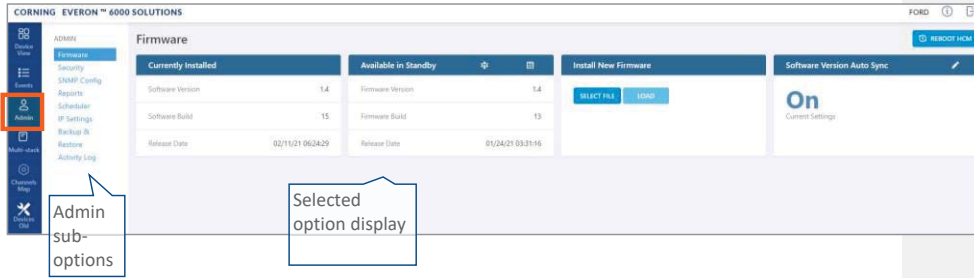

Table 20: Admin Screen Sub Options

Tab	Enables user to...
Firmware	Update HCM FW and enable FW auto synchronization. Lists which FW version is currently installed and what versions are available.
Security	Create and manage multi-user account operators and monitor user activities.
SNMP Config	Use any SNMP manager.
Reports	View the summary of the information of various types of devices in the network along with basic physical and configuration information on each device.
Scheduler	Schedule specified system operations and administrative procedures.
IP Settings	Change IP addresses that were auto assigned by DHCP, ping a manually typed IP address, etc.
Backup	Choose the stacks to be backed-up or re-stored to/from a backup file or SD card(s).
Activity Log	View activities such as configuration changes, according to a range of criteria such as User, Date, Device or Activity type.
License	View a list of available licenses and their expiration time, load new license obtained from Corning.

### 6.1.3.1 Firmware

The **Firmware** tab allows the user to upgrade the firmware version of the system elements.

The HCM upgrade procedure consists of downloading the new software version, setting it as the "Active" version, and restarting the HCM. The new software can be activated either immediately or at a more convenient time as defined by the user. The procedures are performed via the **Firmware** submenu.

By default, Auto Sync option is enabled, hence the software of all installed devices at the site is updated to the software version of the HCM. If this automatic update is not desired, the "Auto Sync" option can be set to "OFF."



The  button can be used when a reboot is required.

#### ➤ To upgrade the firmware version

1. In the main menu bar, click  → 
2. **Download the new image file:** In the "Install New Firmware" area (see image below), click the "SELECT FILE" option and then browse for the required \*.img file. For the latest build, refer to the Corning Everon™ 6000 software release notes.

Once the required file is selected, click "LOAD". The download progress is indicated in the progress bar and may take up to 10 minutes to complete. When the download is complete click "OK".



---



*Note: Do not attempt to refresh the browser or perform any operation before download procedure is complete.*

---

3. **Activate the new firmware version:** After the download is complete, the new firmware version should appear in the "Available in Standby" area:



Available in Standby	
Firmware Version	1.4
Firmware Build	13
Release Date	01/24/21 03:31:16

**Activate the new firmware** – either immediately by using the  icon or at a scheduled (user defined) time by using the  icon.

4. After the new firmware is activated, and the controller automatically restarts: **Log in to the system.**  
The new firmware version should appear in the "Currently Installed" area:

Currently Installed	
Software Version	1.4
Software Build	15
Release Date	02/11/21 06:24:29



### 6.1.3.2 Security

Access security is provided by definitions of user operators created by the system administrator. Operators are used to limit access to specific devices so that only devices allocated to an operator are accessible by members of that operator.

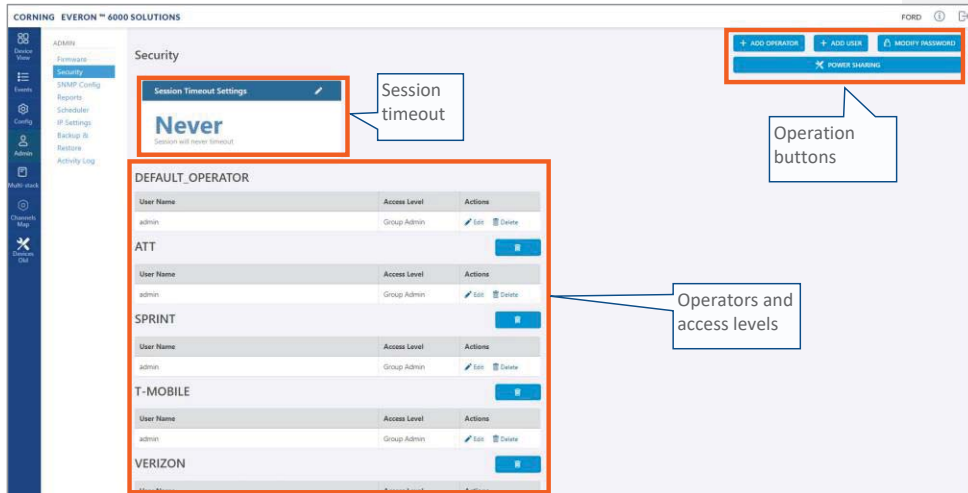

The **Security** tab allows the definition of the operators and the system users. The following three types of users are supported:

- **System administrator:** Single user of the highest level that can create operators with dedicated operator administrators. Only the system administrator can create new operators.
- **Operator administrator:** Automatically created for each operator that is created by the system administrator.
- **Operator users:** Defined by the corresponding operator administrator. Five hard-coded access levels are available per operator:

Table 29: Operator Users Access Levels

Level	Description
Operator	R/O access to Devices and Events screens.
Installer	R/O Access to Devices and Events screens. Write access to <i>free text parameters</i> to allow the definition of location and identification information.
RF Tech	Access to the Devices, Config, Events and Channels screens: <ul style="list-style-type: none"> <li>• Write access to all <i>RF</i> parameters.</li> <li>• R/O to all other parameters.</li> </ul>
IT Tech	Access to the Devices and Admin screens: <ul style="list-style-type: none"> <li>• Write access to all non-<i>RF</i> parameters.</li> <li>• Access to activity logs of all users and operators.</li> </ul>





Level	Description
	<ul style="list-style-type: none"> <li>• HCM firmware upgrade.</li> <li>• R/O to all other parameters.</li> </ul>
Operator Admin	The operator admin has the capabilities of all the other access levels and the permissions to create and manage the users in the operator.

➤ **To add users to an operator**

1. Log in as the **operator** administrator (use relevant operator name at log in).



2. In the main menu bar, click **Admin** → **Security**



3. Click the **+ ADD USER** button. The following form appears:

4. Enter the relevant data:

- The Name of the user (alphanumeric characters, no spaces)
- An access level according to Table 29: Operator Users Access Levels.
- Set the user Password (at least 8 characters) and type it again in the Confirm (password) field.

*Note: The strength of the password is indicated upon entering it in the field (i.e., very weak/weak/reasonable/strong). Weak passwords will not be accepted.*

When done filling in the information, click **OK**.

*Note: An operator can have up to 20 users. Maximum of 31 operators and 500 users per HCM.*



- The new user account is added to the operator list. For example: ATNT operator has three users defined: admin, RF and Installer.

ATNT		
User Name	Access Level	Actions
admin	Group Admin	
RF	RF Tech	
Installer	Installer	

- Users can be removed from the operator list using the icon. User information, including password, can be modified using the icon. The operator administrator can change the passwords of the users in the operator.

*Note: Users with "Operator Admin" access level can be added by the operator admin. The original operator admin can be removed.*

➤ **To modify Password by the user**

- In the main menu bar, click →

- Click the button. The following form appears:

**Modify Password**

Enter old password

Enter new password

Confirm new password

- Enter the old password and the new password, confirm the new password and then click "SAVE". The password must consist of at least 8 alphanumeric characters, no spaces. Weak passwords will not be accepted.

*Note: The operator admin can change the passwords of the users in his operator as explained in the flow above: "To add users to a operator" step 5.*





➤ **Session Access and Timeout**

Sessions are accessed or terminated according to the following criteria:

- Up to ten simultaneous sessions for multiple users are supported.
- The login of users is enabled according to priority. When the maximum number of multiple users are logged in and another user attempts to login, the outcome depends on the level of the user attempting the login:
  - For a higher-level user, the lowest-level user with the longest session time is logged out and the appropriate session termination message appears.
  - For the same level or lower level than the lowest logged in level, session access is denied, and the appropriate message appears.
- If no session activity is detected for the configured amount of time, i.e. session timeout, the session is terminated.

➤ **To configure the session timeout**

1. In the main menu bar, click  → .

2. In the **Session Timeout Settings** area, click the  icon.



3. Enter a timeout value between 1-255 (minutes) or **Never**. Then click **OK**.



### 6.1.3.3 SNMP Config

The SNMP config allows configuring and using any SNMP manager.



### 6.1.3.4 Reports

The Reports option, provides access to all the reports provided by the system, including the **general** and **Inventory** reports. The reports can be generated either in XLS or in PDF format. In addition, **Device Logs** can be exported for troubleshooting by the system administrator.

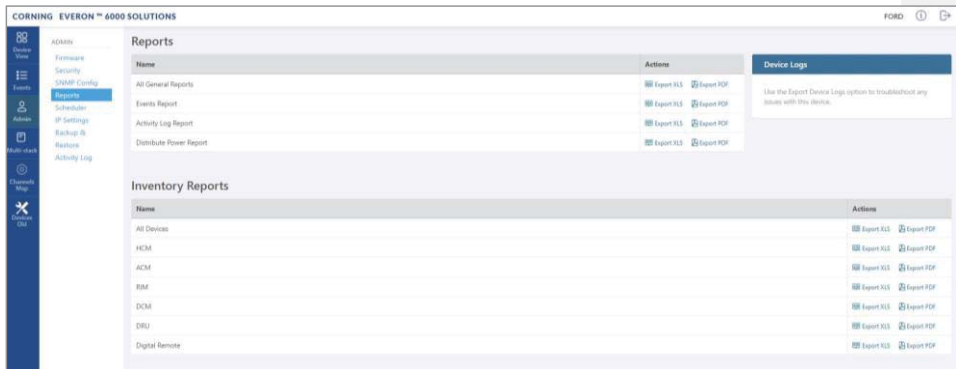

#### ➤ General Reports

The **General Reports** options are detailed in the table below.

Table 30: General Reports

Report Type	What does the report include
All General Reports	This report includes the events, activity log and distribute power reports.
Events Report	Three reports are generated: History (all events), active events and masked events.
Activity Log report	Lists the user activity with information such as time stamp, affected module, username, operator, etc.
Distribute Power	Lists the RF power distribution, configured and actual output power, for all system remotes and RIMs.



The General reports can be exported individually or simultaneously, using the **All General Reports** option, in PDF or XLS format. When all General files are exported in PDF format, the files are provided as a single ZIP file that includes individual PDF files; when exported in XLS format, the files are provided in a single XLS file with dedicated tabs.

➤ **Inventory Reports**

**Inventory reports** provide detailed information in the selected format of "All Devices" or a specific system element. The information includes location, installed versions, IP Address, and more.

➤ **Device Logs**

**Device logs** are the HCM logs, which are accessible to system admin level users only; used for tech support troubleshooting.

**6.1.3.5 Scheduler**

The task scheduler enabling schedule- specified system operations and administrative procedure scheduler. For example: Inventory reports can be scheduled by clicking on the **Schedule** button. In the displayed screen, under **Inventory Reports**, click on **Schedule Reports** and configure the schedule according to instructions provided in Task Scheduler

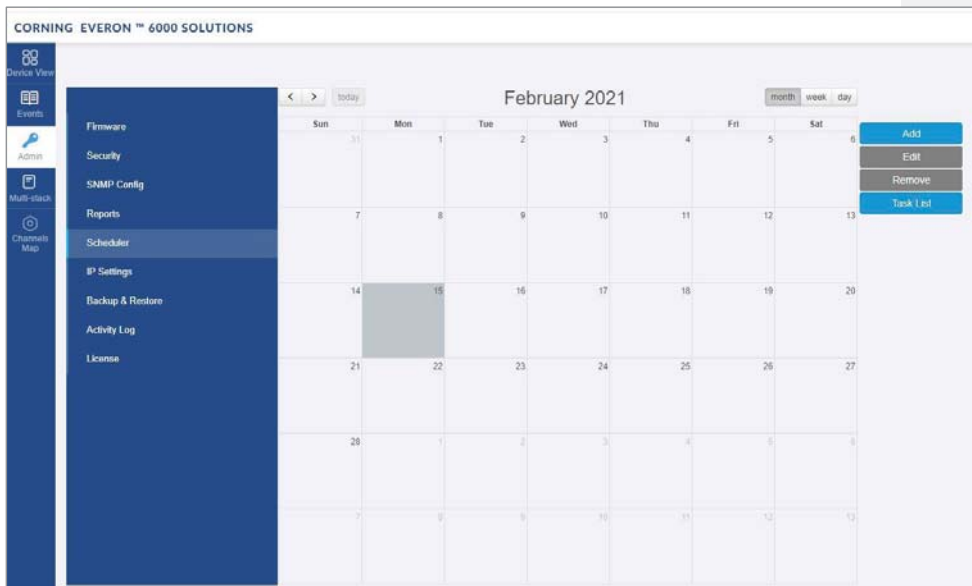



Task: TDD Config Active:

S: TDD Config Params

Set: **Susp** Maintenance

One-time Date: 12/03/2099 Time: 19:45 **MODIFY**

Daily

Weekly

Monthly

Yearly

Comment:

OK CANCEL

December 3, 2099

Thursday

16:00	
16:30	
17:00	
17:30	
18:00	
18:30	
19:00	
19:30	
19:45	TDD Config
20:00	
20:30	
21:00	
21:30	
22:00	
22:30	
23:00	
23:30	



### 6.1.3.6 IP Settings

The **IP Settings** tab allows the configuration of all stacks in the current MS operator. It allows changing IP addresses that were auto assigned by DHCP, pinging a manually typed IP address and more. For more information about remote access configuration refer to section 4.2.

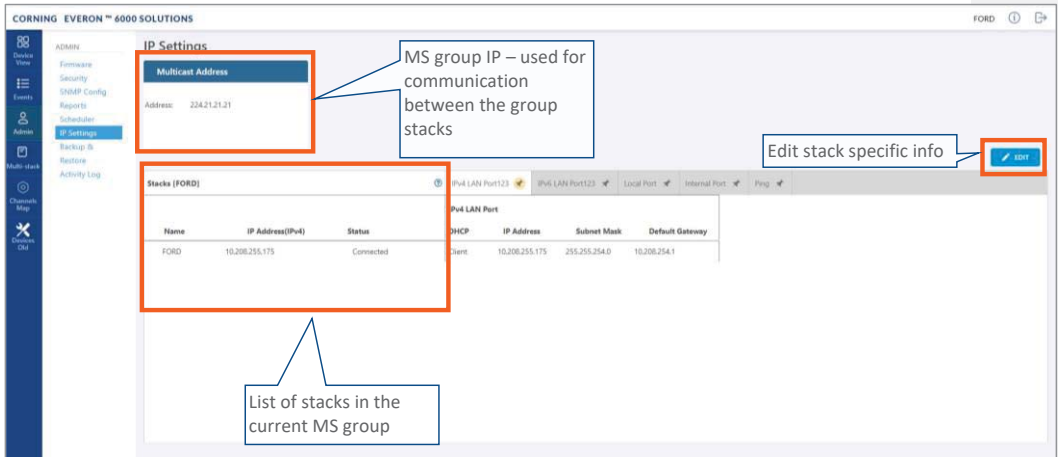

All HCMs in the MS-operator are automatically updated when one stack in the operator is updated. The update is done using the Multicast Address which is used for communication between the stacks in the operator.

Each HCM has three types of RJ45 Ethernet ports: local port, LAN port and four internal ports.



The local port is usually used for first time local access – refer to section 4.1.

The LAN port is used for remote access – refer to section 4.2.

The internal ports are used for management of the connected ACMs.

Each port DHCP can be set to "Client" for dynamic IP addressing. If DHCP is set to "None" the IP address, subnet mask and default gateway must be set manually.



A Ping Tool option is provided in the IP Settings pane. Use this tool to verify access to IP hosts (rather than opening another application).

In the “Ping” work area, enter the IP address and then click the “PING” button. The validity/invalidity result of the IP address appears in the Result line.



### 6.1.3.7 Backup

The **Backup** tab allows the **system administrator** to backup and restore system configurations. Other users don’t have the permissions to perform these procedures.

The system administrator selects the configuration of which stacks to back up to a file and the Micro SD card inserted in the HCM (see section \* for SD card slot location). It is recommended to perform backup after each configuration change.

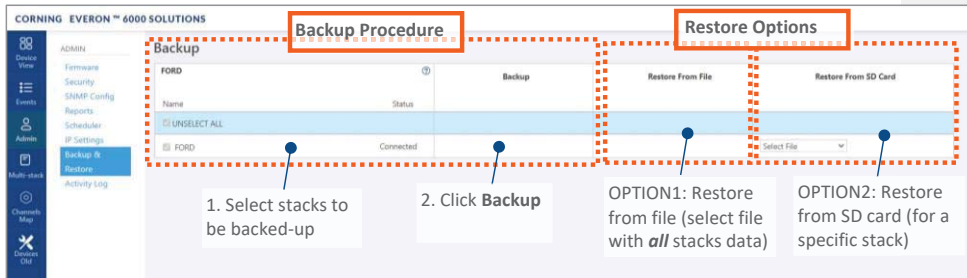

#### ➤ To backup and restore configurations



1. In the main menu bar, click **Admin** → **Backup & Restore**.
2. Select the stacks to be backed up by checking their boxes.
3. Click **Backup**. A backup file will be created, and the configurations will be saved in the HCM SD card as well.
4. To restore configurations from a file: click the **Select File** button in the **Restore From File** area, select a file from the computer and click **Restore**.  
To restore configurations from the HCM Micro SD card: select the configuration file from the drop-down list in the **Restore from SD Card** area and click **Restore**.





### 6.1.3.8 Activity Log

The **Activity Log** is used to view activities such as configuration changes, according to a range of criteria such as User, Time, Operator, etc. The information can be saved in \*.csv format (can be opened with MS-Excel).

The full log list of all user activities is displayed:

Seq	Time	User	Source	Group	Type	Location	Name	SN #	Info
511	02/15/21 17:28:18	admin	WEB GLX 149.42.48.2 28	ATT	HCM	22-19-32-0967/HCM	FORD	NDD9C0046	User Logged In
510	02/15/21 16:25:36	admin	WEB GLX 149.42.58.5 7	ATT	RIM	22-19-32-0967/RIM7		22-19-20-0207	RIM Alarm Mask Changed
509	02/15/21 16:24:49	admin	WEB GLX 149.42.58.5 7	ATT	ACM	22-19-32-0967/ACM		05-17-01-0123	ACM Alarm Mask Changed
508	02/15/21 16:18:04	admin	WEB GLX 149.42.58.5 7	ATT	HCM	22-19-32-0967/HCM	FORD	NDD9C0046	User Logged In
507	02/15/21 16:07:40	admin	WEB GLX 10.208.255.180	DEFAULT_OPERATOR	HCM	22-19-32-0967/HCM	FORD	NDD9C0046	User Logged In
506	02/15/21 15:41:33	admin	WEB GLX 10.208.254.161	DEFAULT_OPERATOR	HCM	22-19-32-0967/HCM	FORD	NDD9C0046	User Logged Off
505	02/15/21 15:41:18	admin	WEB GLX 10.208.254.161	DEFAULT_OPERATOR	HCM	22-19-32-0967/HCM	FORD	NDD9C0046	User Logged In
504	02/15/21 15:41:07		WEB GLX 10.208.254.161	DEFAULT_OPERATOR	HCM	22-19-32-0967/HCM	FORD	NDD9C0046	User Failed to Log In, Attempt 1
503	02/15/21 15:15:19	admin	WEB GLX 10.208.255.180	DEFAULT_OPERATOR	HCM	22-19-32-0967/HCM	FORD	NDD9C0046	User Logged In
502	02/15/21 14:47:54	admin	WEB GLX 10.208.255.180	DEFAULT_OPERATOR	HCM	22-19-32-0967/HCM	FORD	NDD9C0046	User Logged In

The activity log display can be changed in the following ways:

- **Rows Per Page** can be changed to list a different number of activities per page. Page navigation is at the bottom of the screen.
- Enter a specific value in **Search** field (serial number, exact time and date, etc.) to display only the activities that match the search criteria.
- Click on a specific header (i.e. Time) to rearrange activities according to the selected criteria in ascending or descending order.
- Use the **FILTERS** button to limit the displayed information according to device type, action type, and date.



### 6.1.4 Multi-Stack Screen

**MS management** allows centralized network management of sites with multiple stacks deployment, sharing common configuration, where user-defined operators of stacks are automatically and immediately updated with common data.

**MS management** allows a main admin (i.e. sysadmin) user to access a single stack GUI and create an **MS-operator** of up to 100 stacks. The network publishes the list of grouped stacks; then, when an **MS-group** stack member is updated, the updates and common-data attributes are immediately distributed and synchronized (according to the latest time-stamped and indexed data) to each of the stacks that are members of that **MS-operator**.

In addition, the system allows access and management of private (per stack) attributes (such as name, stack-tree, etc.).

The system allows up to 5 users to access and manage the **MS-operator** GUI simultaneously (one of them can be sys-admin user).

When choosing **Multi-Stack** from the main menu the following screen appears:

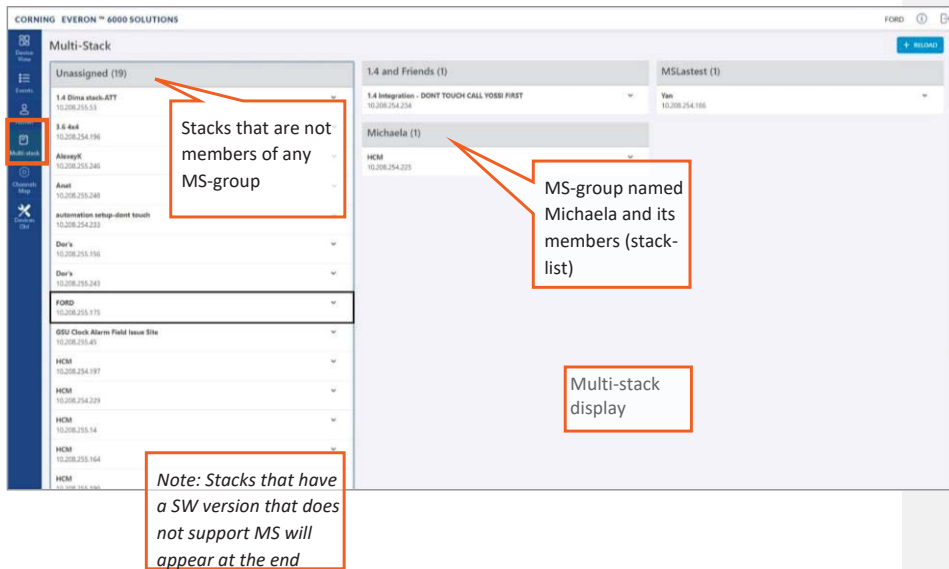

The user can view the information of the different stacks of the system.



### 6.1.5 Channels Screen

The Channels screen allows the user to create, view and modify the system RF channels.

The configuration is done via a map: each map is an operator of channels. The system allows storage of two map configurations: one that is currently being used by the system (named VALID map), and another map configuration that may be edited for future use (named INVALID map), where each map determines the configuration of all the system RF channels.

When choosing **Channels** from the main menu the following screen appears:

Phase	Result	Source Id	Error Description
HCM	Success	aaaa	sdr(sdr)Resqf
DCM	Success	bbbb	sdr(sdr)Resqf
DRU	Failed	cccc	sdr(sdr)Resqf
		aaaa	sdr(sdr)Resqf
		bbbb	sdr(sdr)Resqf
		cccc	sdr(sdr)Resqf

CELL ID	DL CF (MHz)	UL CF (MHz)	UL BW (MHz)	DL BW (MHz)	Operator	SCS (KHz)	Technology	TDD	Power Reduction (dB)	RIM Number	RIM Type	MIMO	Channel Mute	
Channel 1	Lobby	2500	2500	5	5	test	15	4G	YES	0	1	TDD	1T1R	False
Channel 2	355	2500	2500	40	40	test	60	5G	YES	0	2	TDD	1T1R	False

When configuring a new system, the user is required to create a new map and then add channels to it. Channels can be added to existing maps as well.



The following table shows the available options for managing the RF channels map:

Table 31: Map Options

Option	Enables user to...
	When clicking this button the following option appears: Latest Invalid Map ▾ Switch between saved maps: invalid map or valid map.
	Save the map currently loaded in xls format.
	Load a map from xls file.
	Create a new map.
	Add a new RF channel to the map currently loaded.
	Check validity of the map currently being edited. If the map is successfully validated it will replace the existing valid map. If errors are encountered, the map currently being edited will replace any existing (previously saved) invalid map.
	Exit back to the main menu. NOTE: before exiting, make sure to save changes to the edited map; otherwise, they will be lost.

A map of channels can have one of the following statuses.

Table 32: Map Status

Map status	Enables user to...
	The map was submitted, but errors were found during activation.
	The map was submitted, no errors were found during activation.
	Map was not submitted yet.

*Note: At any given time only 2 maps are saved: one valid map and one invalid map.*



### 6.1.5.1 Map Management Flows

Below are examples of two map management scenarios.

➤ **Example1: Create a new map from scratch**

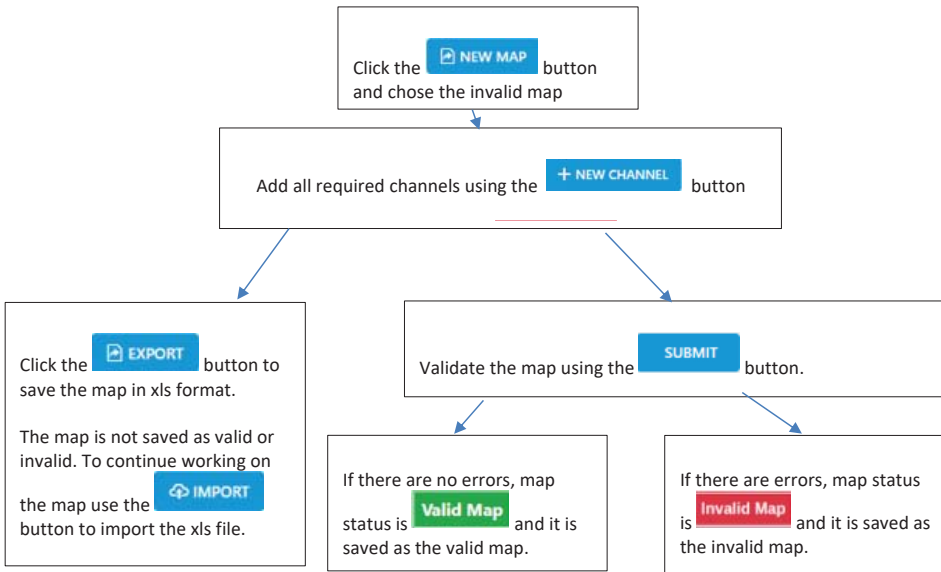



➤ **Example 2: Change an invalid map and repeat the validation process:**

Click the **GET MAP** button and select the invalid map **GET MAP** Latest Invalid Map ▾

Modify the map as required: add new channels, delete channels or edit existing channels information.

Validate the map using the **SUBMIT** button.

If there are no errors, map status is **Valid Map** and it is saved as the valid map. Any previously saved valid map is lost. The invalid map no longer exists.

If there are errors, map status is **Invalid Map** and the updates are saved to the invalid map.



### 6.1.5.2 Add a New Channel

When choosing the **New Channel** option, the following form appears:

**Add Channel**

---

Cell Id <input type="text" value="1-12 characters"/>	DL CF (MHz) <input type="text" value="0"/>
UL CF <input type="text" value="0"/>	BW (MHz) <input type="text" value="5"/>
Operator <input type="text" value="VZ"/>	TDD Service <input type="text" value="NO"/>
Power Reduction (DB) <input type="text" value="1"/>	RIM Number <input type="text" value="1"/>
Technology <input type="text" value="3G"/>	SCS <input type="text" value="15"/>
MIMO <input type="text" value="1T1R"/>	

Table 33: Add Channel Form

Field	Information
Cell Id	Channel name entered by the user, may include location and other information regarding the channel.
DL CF	Downlink Center Frequency (MHz).
UL CF	Uplink Center Frequency (MHz).
BW	Bandwidth (MHz).
Operator	Name of operator (name of telecommunication company).
TDD Service	YES/NO; Indicates whether Time Division Duplexing is enabled.
Power Reduction	Indicates a power failure
RIM Number	Slot number of the connected RIM. Slots 1-8 are IHU slots and slots 9-20 are HEU slots.
Technology	The applicable values are 3G/4G/5G.
SCS	Sub Carrier Spacing (kHz).
MIMO	Number of transmitters and receivers.

*Note: Up to 32 channels can be added (16 channels per DCM).*



### 6.1.5.3 Submitting a map

- When changes are made to any map the status of the map is **map in process** until the changes are submitted:

Invalid Map Failures Information : HCM | success DCM | failed DRU | success

1. Error occurred in cahnnel #4 please fix this error and activate map again  
 2. Error occurred in cahnnel #5 please fix this error and activate map again

CELL ID	DL CF (MHz)	UL CF (MHz)	BW (MHz)	Operator	SCS (KHz)	Technology	TDD	Power Reduction (dB)	RIM Number	RIM Type	MIMO
1	1000.5	1000.5	5	5	30	4G	YES	10	4	-	4T4R
2	1000.5	1000.5	10	5	15	5G	NO	5	9	-	4T4R
3	1000.5	1000.5	15	5	60	4G	YES	7	8	-	1T1R
4	1000.5	1000.5	15	5	15	4G	NO	13	8	-	1T1R

- When done making changes to the map, you may press the **Submit** button. Validation of the map begins, and a progress bar appears:

The system performs a basic check to make sure all parameters have valid values according to system limits, such as: Number of channels per specific BW, channels overlap, etc.

Activating Map:  
 This process may take a several minutes, please wait!

Progress bar

CELL ID	DL CF (MHz)	UL CF (MHz)	BW (MHz)	Operator	SCS (KHz)	Technology	TDD	Power Reduction (dB)	RIM Number	RIM Type	MIMO
1	1000.5	1000.5	5	5	30	4G	YES	10	4	-	4T4R
2	1000.5	1000.5	10	5	15	5G	NO	5	9	-	4T4R
3	1000.5	1000.5	15	5	60	4G	YES	7	8	-	1T1R
4	1000.5	1000.5	15	5	15	4G	NO	13	8	-	1T1R





3. A pop up window indicates the activation status. If activation fails, the errors are displayed, as well as the activation status per module. In the following example, the map status is "invalid map" (the map will be saved as the invalid map).

Map status

Invalid Map Failures Information : HCM | success DCM | failed DRU | success

1. Error occurred in cahnnel #4 please fix this error and activate map again  
2. Error occurred in cahnnel #5 please fix this error and activate map again

Errors found

Activation status per module:  
Activation passed at HCM and DCM levels, but failed in DRU level

CELL ID	DL CF (MHz)	UL CF (MHz)	BW (MHz)	Power Reduction (dB)	RIM Number	RIM Type	MIMO
1	1000.5	1000.5	5	10	4	-	4T4R
2	1000.5	1000.5	10	5	9	-	4T4R
3	1000.5	1000.5	15	7	8	-	1T1R
4	1000.5	1000.5	15	13	8	-	1T1R
5	1000.5	1000.5	15	13	8	-	1T1R

Activation Failed  
Map activation failed.  
OK

Pop up window indicating activation failed

If activation is successful, the status of the map becomes "valid map" (map is saved as the valid map).

If the user makes changes to an invalid map, submits it and activation passes, the map is saved as the valid map and the invalid map is deleted.

## 7. SNMP Management

The Everon system supports SNMP protocol, which allows standard monitoring via a large variety of 3rd party endpoint monitoring tools, also known as SNMP manager agents (e.g., HP OpenView, CA Unicenter, IBM Tivoli, CastelRock SNMPc): The Everon system sends indications on system events and failures to a user-defined monitoring destination-address, by sending SNMP protocol traps. Integration between the Everon system and the monitoring agent, is done by loading Everon MIB files (Management Information Base) to the SNMP manager agent. These files include system driver-like data required for the two systems to communicate, where one of the parameters is a binding table (provided here in section 0), which allows interpretation of the supported traps sent by Everon.

Everon supports simultaneously two SNMP protocol versions - SNMPv2 and SNMPv3. This allows system monitoring by multiple tools that support different SNMP protocol versions.

- **SNMPv2** is enabled by default and can be disabled by the user. The user can also modify the community string, which is an ID of the SNMP device used for communication with the SNMP manager. The community string is sent with all SNMP requests.
- **SNMPv3** provides a secure SNMP protocol and facilitates remote configuration of the SNMP entities, thus simplifying remote administration. The security aspect is addressed by offering both strong authentication and data encryption for privacy, whereas the administration aspect focuses on notification originators and proxy forwarders. SNMPv3 authentication and security:
  - Verification for each received SNMP message that it has not been modified during transmission through the network.
  - Verification of the user identity for which the received SNMP message was supposedly generated.
  - Detection of received SNMP messages, requesting or containing management information, whose time of generation is not recent.

---

*Note: Everon allows the user to perform system configurations via the SNMP manager.*

---

➤ **To allow SNMP monitoring, the user needs to perform the following steps:**

1. Perform SNMP Setup, see **Error! Reference source not found.**
2. Optional: Test the configuration using a MIB browser, see 7.2
3. Start monitoring the system

---

*Notes:*

*\* The supported traps are listed in section 7.3*

*\* The information each trap includes is listed in section **Error! Reference source not found.***

---



## 7.1 SNMP Setup

This section details the following steps, required to set SNMP trap monitoring:

1. Through Everon GUI: Set the SNMP protocol version parameters (SNMPv2 / SNMPv3), see 7.1.1
2. Through Everon GUI: Set traps monitoring destination addresses, see 7.1.2
3. Through your 3rd party SNMP monitoring tool: Load the MIB files, see 7.1.3

### 7.1.1 Set Protocol Version Parameters (SNMPv2 / SNMPv3)

➤ To set SNMP version:

1. Choose **Admin** from the main menu → **SNMP Config**. The following screen appears:



2. In the following instructions, refer to the protocol version relevant in your deployment, and perform the set of instructions listed below.

➤ **To configure SNMPv2 parameters**

1. In the main menu bar, click  → .
2. In the "V2 Configuration" area, click  to change the current configurations.

The **SNMP Community** dialog appears:



The dialog box titled "SNMP Community" has a close button (X) in the top right corner. The main content area contains the following fields:

- Modify SNMP community:**
- Enable V2:** A checkbox that is currently unchecked.
- Command:** A text field containing the value "Read".
- Community:** A text field containing the value "public123".

At the bottom of the dialog, there are two buttons: "OK" and "CANCEL".

3. Select/unselect the checkbox next to "Enable V2" to enable/disable SNMPv2.
4. If necessary, modify the community name in the **Community** field.
5. Click **OK**.

➤ **To configure SNMPv3 parameters**

1. In the main menu bar, click  → .
2. Select the required user from the **User Name** list and click . The following dialog appears:

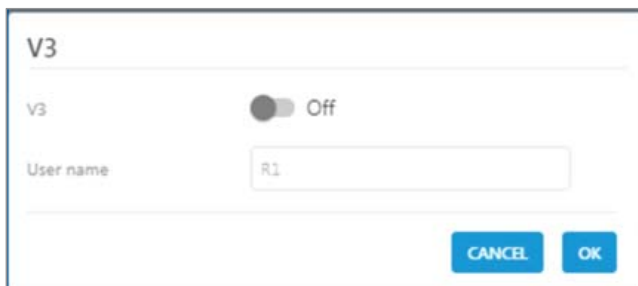

The dialog box titled "V3" has a close button (X) in the top right corner. The main content area contains the following fields:

- V3:** A toggle switch that is currently set to "Off".
- User name:** A text field containing the value "R1".

At the bottom of the dialog, there are two buttons: "CANCEL" and "OK".



3. Enable "V3" to get the SNMPv3 configuration options:

V3

V3  On

User name

Authentication protocol

Privacy protocol

Password

Trap Destination

IPv4  IPv6

4. Configure the following SNMPv3 parameters for the user:
  - Authentication protocol – MD5/SHA.
  - Privacy protocol – None/DES/AES-128.
  - Password – one password for both authentication and privacy protocols.
5. Select the internet protocol version (IPv4/IPv6) for the SNMP traps and enter the trap destination address:
  - IPv4 - SNMPv3 trap destination address: IP (x.x.x.x).
  - IPv6 - SNMPv3 trap destination address: IP (0:0:0:0:0:0).
6. Click **OK**.

## 7.1.2 Set Traps Monitoring Destination Addresses

This section explains how to configure the IP addresses to which SNMP traps are sent. Both IPv4 and IPv6 addresses are supported.

In addition, each SNMP trap destination can be configured with a HB trap timer (“keep alive”). This option enables a periodical trap indicating that the device is operational. The trap is sent every user-configured time interval: 1-59 minutes.

*Note: The defined HB interval must be the same for all devices in the system. This option is disabled by default.*

### ➤ To define the trap destination IP address

- In the main menu bar, click  → 
- Click  in the **Trap Destination List** area.

The **Trap Destination IP Address** dialog appears:

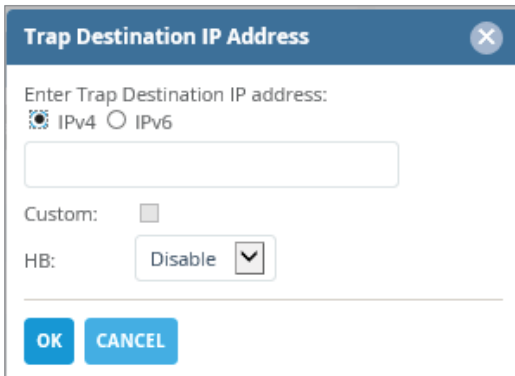

The dialog box titled "Trap Destination IP Address" contains the following elements:

- Header: "Trap Destination IP Address" with a close button (X).
- Text: "Enter Trap Destination IP address:"
- Radio buttons:  IPv4 and  IPv6.
- Text input field for the IP address.
- Checkbox: "Custom:" with an unchecked checkbox.
- Text: "HB:" followed by a dropdown menu currently showing "Disable".
- Buttons: "OK" and "CANCEL".

- Select the **protocol version of the IP address**: IPv4/IPv6 and enter the trap destination address.
  - IPv4: IP (x.x.x.x).
  - IPv6: IP (0:0:0:0:0:0:0:0).
- If needed: select the **Custom** checkbox, to and fill-in the required parameters
- If needed: set the **Heartbeat (HB)**:
  - In the HB box, select Enable from the roll-down menu.
  - Determine the time interval (rate) for sending HBs.

*Note: Ensure the HB definition is identical in the whole system.*

- Click **OK**.
- DONE:** The IP address is added to the list.



### 7.1.3 SNMP manager Setup: Load the MIB Files

This section describes the steps necessary to view the traps sent by the monitored system in the management application.

*Note: It is assumed that the HCM IP address and the trap destination addresses have already been configured.*

➤ **To view interpreted traps through the 3<sup>rd</sup> party management application**

1. Start the management application.
2. Load and compile the MIB-II file (a public domain file which can be found on <http://www.rfc-editor.org>).
3. Load and compile the ma\_events.mib file.
4. Load and compile the maHCM.mib file.

*Note: In most cases MIB files are loaded and compiled using the "MIB menu" tool items in the main menu of the management application.*

5. SNMP monitoring can begin.

### 7.2 Test the Configuration using a MIB Browser Tool (Recommended)

After SNMP is configured, it is recommended that the user verifies that SNMP information is properly received and sent by the monitored system.

To do so, the user may download a MIB browser (free to download). MIB browsers are accessible and easy to use tools, which can be used to check the configurations and view, configure and parse SNMP traps.

### 6.3 Trap Variable Bindings

Data within a trap is encoded in a typical key-value pair configuration. These pairs are called "variable bindings" and they contain extra information related to the trap. For example, a trap has the binding "trapDeviceTpe", which may have the value "1". This means the Module that generated the trap is the HCM.

The table below lists all bindings supported.

Table 34: Binding Table

No.	Binding	Description
1.	trapSequenceID	Trap sequence ID to be sent with the trap. This is a trapSequenceID varbind that is attached to the trap message in order to allow the manager to track missing traps.
2.	trapTimeStamp	Time and date the current event occurred; Format H:M:S D/M/Y
3.	trapDeviceType	Additional data sent with the trap; Type of module that generated the trap: hcm = (1) acm = (2) rim = (3) oim = (4) RAU5 = (5) rxu = (6) fmm = (9) frm = (10) site = (11)

No.	Binding	Description
		mru = (12) lau = (21) och = (24) gx = (25) mxu = (26)
4.	trapDeviceSerial	Additional data sent with the trap. This is the serial number of the device that generated the trap (up to remote unit level).
5.	trapChassisSN	Chassis serial number of the module
6.	trapChassisIndex	Additional data sent with the trap. This is the base controller index that generates the trap (chassis index).
7.	trapSlotIndex	Additional data sent with the trap. This is the base controller's port index that generates the trap (the slot inside the chassis).
8.	trapPortIndex	Additional data sent with the trap. This is the connector index of the base controller that connects to the generating device (the optical port of the OIM).
9.	trapRemoteIndex	Additional data sent with the trap. This is the internal index within the generating device (e.g., RxU index).
10.	trapCtrlSerialNum	Serial number of the controller generating the event; Internal parameter.
11.	trapCtrlName	Name of controller
12.	trapModuleName	Name of module
13.	trapSeverity	The alarm severity: (1) Notify (2) Minor (3) Major
14.	trapChannel	Trap channel for remote unit band number for OIM optic port.
15.	trapChannelDescription	Trap channel for remote unit band name for the OIM optical port.



### 7.3 List of traps

The system supported traps (i.e., alert messages sent by the system to the SNMP manager, indicating system events or failures), are provided in the following table.

Table 35: List of Traps

Trap name	Description	OID
controllerPowerUp	Controller power up indication	1
moduleDisconnected	Module disconnected	4
moduleDetected	Module detected	5
versionMismatchSet	Module Version Mismatch	6
versionMismatchClear	Module Version Mismatch clear	7
moduleAdjustmentFaultSet	Module Adjustment Fault	8
moduleAdjustmentFaultClear	Module Adjustment Fault clear	9
ModuleHwFailureSet	HW Failure	10
moduleHwFailureClear	HW Failure Clear	11
moduleInvalidChannelsMapSet	Module Invalid Channels Map set	12
moduleInvalidChannelsMapClear	Module Invalid Channels Map clear	13
adjustFaultSet	Adjustment Procedure Fault set	20
adjustFaultClear	Adjustment Procedure Fault clear	21
installFaultSet	Installation Fault set	22
installFaultClear	Installation Fault clear	23
releaseMismatchSet	SW Release Mismatch versions set	24
releaseMismatchClear	SW Release Mismatch versions clear	25
connectivitySet	Connectivity set	26
connectivityClear	Connectivity clear	27
hcmHeartbeat	HCM Heartbeat (Keep alive)	28
N/A	HCM HB Placeholder (not in use)	29
N/A	HCM License Placeholder (not in use)	30
N/A	HCM License Placeholder (not in use)	31
hcmInvalidChannelsMapSet	HCM Invalid Channels Map set	32
hcmInvalidChannelsMapClear	HCM Invalid Channels Map clear	33
hcmMissingEquipmentSet	HCM Missing equipment for the Channels Map	34
hcmMissingEquipmentClear	HCM Missing equipment for the Channels Map clear	35
acmPSMAOverTemperatureSet	ACM Power Supply A over Temperature	100
acmPSMAOverTemperatureClear	ACM Power Supply A over Temperature Clear	101
acmOverTemperatureSet	ACM Over Temperature	102
acmOverTemperatureClear	ACM Over Temperature clear	103
acmPSMBOverTemperatureSet	ACM Power Supply B over Temperature	104
acmPSMBOverTemperatureClear	ACM Power Supply B over Temperature Clear	105
acmPSMAOutputUnderVoltageSet	ACM Power Supply A Output Under Voltage	108
acmPSMAOutputUnderVoltageClear	ACM Power Supply A Output Under Voltage Clear	109
acmPSMBOutputUnderVoltageSet	ACM Power Supply B Output Under Voltage	110
acmPSMBOutputUnderVoltageClear	ACM Power Supply B Output Under Voltage Clear	111
acmExt1ClockDownSet	ACM Ext1 Clock down	114
acmExt1ClockDownClear	ACM Ext1 Clock down Clear	115
acmExt2ClockDownSet	ACM Ext2 Clock down	116

Trap name	Description	OID
acmExt2ClockDownClear	ACM Ext2 Clock down Clear	117
acmPilotClockDownSet	ACM Pilot Clock Down	118
acmPilotClockDownClear	ACM Pilot Clock Down Clear	119
acmPSMAInputUnderVoltageSet	ACM Power Supply A Input Under Voltage	120
acmPSMAInputUnderVoltageClear	ACM Power Supply A Input Under Voltage Clear	121
acmPSMBInputUnderVoltageSet	ACM Power Supply B Input Under Voltage	122
acmPSMBInputUnderVoltageClear	ACM Power Supply B Input Under Voltage Clear	123
acmPowerFailureSet	ACM Power Failure	126
acmPowerFailureClear	ACM Power Failure Clear	127
acmFamFailureSet	ACM Fam Failure	128
acmFamFailureClear	ACM Fam Failure Clear	129
rimDLRFLowPowerSet	RIM DL RF Low Power	200
rimDLRFLowPowerClear	RIM DL RF Low Power Clear	201
rimDLOverPowerSet	RIM DL Over Power	202
rimDLOverPowerClear	RIM DL Over Power Clear	203
rimServiceOffSet	RIM Service Off	204
rimServiceOffClear	RIM Service Off Clear	205
rimOverTemperatureSet	RIM Over Temperature	208
rimOverTemperatureClear	RIM Over Temperature Clear	209
rimTddSyncLossSet	RIM TDD Sync Loss	212
rimTddSyncLossClear	RIM TDD Sync Loss Clear	213
rimAwsMixConnectionSet	RIM AWS3 Band mismatch	214
rimAwsMixConnectionClear	RIM AWS3 Band mismatch Clear	215
Place Holder	Place Holder	216
Place Holder	Place Holder	217
rimUISynthesizerUnlockedSet	RIM UL Synthesizer Unlocked	250
rimUISynthesizerUnlockedClear	RIM UL Synthesizer Unlocked Clear	251
rimDISynthesizerUnlockedSet	RIM DL Synthesizer Unlocked	252
rimDISynthesizerUnlockedClear	RIM DL Synthesizer Unlocked Clear	253
rimReferenceClockUnlockedSet	RIM Reference Clock Unlocked	254
rimReferenceClockUnlockedClear	RIM Reference Clock Unlocked Clear	255
siteAdjustFaultSet	Site Adjustment Fault	700
siteAdjustFaultClear	Site Adjustment Fault clear	701
siteReleaseMismatchSet	There are Modules with Version Mismatch in the site	702
siteReleaseMismatchClear	All Modules Versions OK in the Site	703
siteConnectivitySet	There are Disconnected Modules in the site	704
siteConnectivityClear	All Modules are connected in the site	705
druOverTemperatureSet	DRU over temperature	2100
druOverTemperatureClear	DRU over temperature Clear	2101
druSfpPortSet	DRU SFP port X (X from 1 to 36) status	2102
druSfpPortClear	DRU SFP port X (X from 1 to 36) status clear	2103
druCpriLinkSet	DRU CPRI link X (X from 1 to 36) status	2104
druCpriLinkClear	DRU CPRI link X (X from 1 to 36) status clear	2105
dcmOverTempratureSet	DCM over temperature	2200

Trap name	Description	OID
dcmOverTemperatureClear	DCM over temperature clear	2201
dcmSfpPortSet	DCM SFP port X (X=1,2,3,4) status	2202
dcmSfpPortClear	DCM SFP port X (X=1,2,3,4) status clear	2203
dcmCpriLinkSet	DCM CPRI link X (X=1,2,3,4) status	2204
dcmCpriLinkClear	DCM CPRI link X (X=1,2,3,4) status clear	2205
ruSfpPortSet	Remote SFP port X (X=1,2,3,4) status	2300
ruSfpPortClear	Remote SFP port X (X=1,2,3,4) status clear	2301
ruCpriLinkSet	Remote CPRI link X (port# of remote side) status  (Examples for remotes CPRI links numbers: DLRU Med bands 1,2,3 DLRU Low bands 1 DMRU 1,2 DHRU 1,2,3,4)	2302
ruCpriLinkClear	Remote CPRI link X status clear	2303
ruOverTemperatureSet	Remote Unit Over temperature - sensor X	2304
ruOverTemperatureClear	Remote Unit Over temperature clear	2305
ruServiceOffSet	Remote Unit service off - band X (600/700L/700H/FN/800/850/PCS/AWS/WCS/TDD 2.5)	2306
ruServiceOffClear	Remote Unit service off clear	2307
ruULimiterSet	Remote Unit UL Limiter - band X	2310
ruULimiterClear	Remote Unit UL Limiter clear	2311
ruDIRfLowSet	Remote Unit DL RF Low	2312
ruDIRfLowClear	Remote Unit DL RF Low clear	2313
ruConnectionErrorSet	Remote Unit connection error	2316
ruConnectionErrorClear	Remote Unit connection error clear	2317
ruOverflowSet	Remote Unit Overflow - per channel X	2320
ruOverflowClear	Remote Unit Overflow clear	2321
ruVswrSet	Remote Unit VSWR Alarm in band X	2322
ruVswrClear	Remote Unit VSWR Alarm clear	2323
ruPaSelfProtectionSet	Remote Unit PA Self Protection Alarm - band X	2324
ruPaSelfProtectionClear	Remote Unit PA Self Protection Alarm clear	2325
ruTddOutOfSyncSet	Remote Unit TDD out of sync - band X	2326
ruTddOutOfSyncClear	Remote Unit TDD out of sync clear	2327

## 8. APPENDIX A: Specifications

### ➤ Specifications |

#### ➤ RF Parameters

Frequency Range Name	Uplink	Downlink
600-band 71	663-698 MHz	617-652 MHz
700L (Lower Band)- band 12	698-716 MHz	728-746 MHz
700U (Upper Band)-band 13	776-787 MHz	746-757 MHz
FirstNet (700)-band 14	788-798 MHz	758-768 MHz
800/850 -band 26	817-849 MHz	862-894 MHz
1900 (PCS)-band 25	1850-1915 MHz	1930-1995 MHz
EAWS-band 66	1710-1780 MHz	2110-2200 MHz
WCS -band 30	2305-2315 MHz	2350-2360 MHz
2500 -band 41	2496-2690 MHz (TDD)	

#### ➤ Standards and Certifications

Attribute	Description
EMC	CE, EMC FCC 47 CFR Part 15 sub part B
Safety	62368
Radio	Fire Safety UL 2043 (applicable for LRU only)

\*Technical spec subject to change without notice



- **Radio Interface Frames (IHU/HEU)**
- **IHU Chassis**



Radio Interface Frame Modules	
RIMe – up to 8 modules per chassis	Single band module (see bands table) Interfaces: UL, DL and duplexed interface ports, QMA RF connectors Weight: 1.9 lbs (0.9 kg)
DCM – up to 2 modules per chassis	Interfaces: CPRI: 4x SFP+ (optical connectors) Weight: 2.9 lbs (1.3 kg)
RIX- one module per chassis	Interfaces: Two 9-pin coaxial interface connectors (RF and Clock) Two QMA ports for reference clock connections between Radio Interface Frames (IHU, HEU) Weight: 1.54 lbs (0.7 kg)
OIX - one module per chassis	Interfaces: Two 9-pin coaxial interface connectors (RF and Clock) Weight: 1.54 lbs (0.7 kg)
PSM – up to 2 modules per chassis	Power Consumption 200 Watt (Full Chassis) AC PSM: power input 120-220 VAC; tri-pin DC PSM: power input 48 VDC; 9A Max.; 6-pin terminal block connector On/Off power switch Weight: 1.9 lbs (0.9 kg)
dHCM – one module per system using IHU and 7 HEU chassis	Interfaces: Four RJ45 100 Mb Ethernet ports - internal interfaces to auxiliary control modules One RJ45 1 Gigabit Ethernet LAN port – for remote management One RJ45 1 Gigabit Ethernet Local port – for local configuration and management One RJ45 console port – for service personnel use only (e.g., debugging, etc.) SD card slot – support for micro SD card up to 32 GB, used for saving and importing system configuration files Status LEDs: indicating power, module operation (RUN), system status and fan operation of chassis Weight: 2.2 lbs (1 kg)
ACM -one module per chassis	Interfaces: Four RJ45 100 Mb Ethernet ports - internal interfaces to dHCM One RJ45 console port – for service personnel only Status LEDs: indicating power, module operation (RUN), system status and fan operation of chassis To dHCM RJ-45 internal port Weight: 2.2 lbs (1 kg)



Mechanical	
Dimension (H x W x D)	7" x 17.3" x 18.95" (177.8 x 440 x 481.7 mm)
Mounting	19"/4U
Weight	58 Lbs (26.4Kg) for full chassis configuration

Environmental	
Operating temperature	0 to +50° C (32 to 122° F)

\*Technical spec subject to change without notice



➤ **HEU Chassis**



Radio Interface Frame Modules	
RIMe – up to 12 modules per chassis	Single band module (see bands table) Interfaces: UL, DL and duplexed interface ports, QMA RF connectors Weight: 1.9 lbs (0.9 kg)
RIX- one module per chassis	Interfaces: Two 9-pin coaxial interface connectors (RF and Clock) Two QMA ports for reference clock connections between Radio Interface Frames (IHU, HEU) Weight: 1.54 lbs (0.7 kg)
PSM – up to 2 modules per chassis	Power Consumption 200 Watt (Full Chassis) AC PSM: power input 120-220 VAC; tri-pin DC PSM: power input 48 VDC; 9A Max.; 6-pin terminal block connector On/Off power switch Weight: 1.9 lbs (0.9 kg)
ACM -one module per chassis	Interfaces: Four RJ45 100 Mb Ethernet ports - internal interfaces to dHCM One RJ45 console port – for service personnel only Status LEDs: indicating power, module operation (RUN), system status and fan operation of chassis To dHCM RJ-45 internal port Weight: 2.2 lbs (1 kg)



Mechanical	
Dimension (H x W x D)	7" x 17.3" x 18.95" (177.8 x 440 x 481.7 mm)
Mounting	19"/4U
Weight	64.5 Lbs (29.3) for full chassis configuration

Environmental	
Operating temperature	0 to +50° C (32 to 122° F)

\*Technical spec subject to change without notice





➤ **DRU - Digital Routing Unit**



Interfaces & Mechanical	
CPRI ports	32 x SFP+ (10.1 Gbps, CPRI line bit rate option 8) to Remote Units
CPRI ports	4 x SFP+ (10.1 Gbps, CPRI line bit rate option 8) to DCM
Ethernet Ports	2x RJ45 - LAN, Local
External synchronization	2*QMA -10MHz In/Out
Mounting:	19" rack, 1U
Dimension (W x H x D)	Size: 19" x 1.75" x 16.5" (482.6 x 44.5x 419 mm)
Weight	19.8 Lbs (9Kg)
Powering	
Powering	48V DC / or AC 220/110V
Power Consumption	180 Watt
Environmental	
Operating temperature	0 to +50° C (32 to 122° F)

\*Technical spec subject to change without notice



- Low Band LRU-Low power Remote Unit
- End to End System Performance
- Headend to Digital Low power Remote Unit



RF Specifications						
Frequency Range Name			600	700L & 700U & FirstNet		800/850
Frequency Range	Uplink	MHz	663-698	698-716	777-798	817-849
	Downlink		617-652	728-746	746-768	862-894
Max. Operating Bandwidth-Non-contiguous		MHz	Full Band			
Instantaneous Bandwidth		MHz	35	18	21	32
Downlink Output Power (LRU)		dBm	20	20		20
Attenuation Adjustable Range (1dB step)		dB	0-20			
Pass Band Ripple (p-p)		dB	≤ 4	≤ 4	≤ 4	≤ 4
Channel Bandwidth		MHz	5/10/15/20			
Uplink Noise Figure (typical)		dB	12			
Uplink IIP3 (typical)		dBm	-14			
VSWR			≤ 1.8			
EVM (256 QAM) (TM3.1A @ Rated power)		%	< 3.5			
Spurious Emission			3GPP TS 36.106/25.106; 3GPP TS 38.104 V15.5.0 (sections 6; 7)			
Electrical Specifications						
Power Consumption		Watt	70			
DC voltage		DC	37-56			
Interfaces and Mechanical						
CPRI Port			1, SFP+ 10.1Gbps			
Antenna Ports			2, 4.3-10 female			
Dimension (W x H x D)		Inch (mm)	9.84 x 10.63 x 2.75 (250 x 270 x70)			
Weight		Lbs (Kg)	13 (6)			
Mounting and installation			Wall, ceiling and pole mount options			
Cooling			Convection			
Environmental						
Operational Temperature		°F (°C)	-40° to 131° (-40° to 55° )			
Outdoor installation (Ingress Protection)			IP 66			

\*Technical spec subject to change without notice



- **Medium Band LRU- Low power Remote Unit**
- **End to End System Performance**
- **Headend to Digital Low power Remote Unit**



RF				1900	EAWS	WCS	2500	
Frequency Range Name				1850-1915	1710-1780	2305-2315	2496-2690	
Frequency Range	Uplink	MHz		1850-1915	1710-1780	2305-2315	2496-2690	
	Downlink			1930-1995	2110-2180	2350-2360	2496-2690	
Max. Operating Bandwidth-Non-contiguous		MHz	Full Band					
Instantaneous Bandwidth		MHz	65	70	10	60 + 60		
Downlink Output Power (LRU)		dBm	20	20	18	20		
ATT Adjustable Range (1dB step)		dB	0-20					
Pass Band Ripple (p-p)		dB	≤ 4	≤ 4	≤ 4	≤ 4		
Channel Bandwidth		MHz	5/10/15/20				5/10/15/20 for 4G	40 or 60 for 5G
Uplink Noise Figure (typical)		dB	12					
Uplink IIP3 (typical)		dBm	-14					
VSWR			≤ 1.8					
EVM (256 QAM)		%	< 3.5					
Spurious Emission			3GPP TS 36.106/25.106; 3GPP TS 38.104 V15.5.0 (sections 6; 7); 3GPP TR 36.846 V12.0.0					
Electrical Specifications								
Power Consumption		Watt	80					
DC voltage		DC	37-56					
Interfaces and Mechanical								
CPRI Port			3, SFP+ 10.1Gbps					
Antenna Ports			2 ,4.3-10 female					
Dimension (W x H x D)		Inch (mm)	9.84 x 10.63 x 2.75 (250 x 270 x 70)					
Weight		Lbs (Kg)	13 (6)					
Mounting and installation			Wall, ceiling and pole mount options					
Cooling			Convection					
Environmental								
Operational Temperature		°F (°C)	-40° to 131° (-40° to 55°)					
Outdoor installation (Ingress Protection)			IP 66					

\*Technical spec subject to change without notice



**LRU 2:2 MIMO Antenna Combiner**

The LRU combiner is used to combine the 2 LRU's:  
 Low Band LRU and Medium Band LRU.  
 The combiner has a total of 6 input ports and 2 output ports.  
 There are two independent three-frequency combiners inside.  
 The input frequencies are:  
 617-894MHz (connected to LRU Low Band)  
 1695-2690 MHz (connected to LRU Medium Band)  
 3450-4000MHz (for future connection to CBRS C-Band LRU)

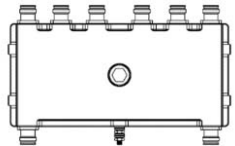

		Port1/Port4	Port2/Port5	Port3/Port6
Port Name		Low Band 1/2	Mid Band 1/2	C-Band 1/2
Frequency Range	MHz	617-894	1695-2690	3450-4000
Bandwidth	MHz	277	995	550
Insertion Loss	dB	≤ 1		
Pass band Ripple	dB	≤ 0.5		
Out of Band Isolation	dB	≥50@1695-2690 ≥50@3450-4000	≥50@617-894 ≥40@3450-4000	≥50@617-894 ≥50@1695-2690
PIM	dBc	-155 ( @ 2x1W)		
Return Loss	dB	≥18		
Isolation	dB	≥40		
Impedance	Ω	50		

**Interfaces and Mechanical**

Port Type		4.3-10 Female
Dimension	Inch(mm)	10.6 x 4.92 x 1.38 (270 x 125 x 35)
Maximum Power		1W (Average)

**Environmental**

Operating temperature	°F (°C)	-40 to +185 (-40 to +85)
Ingress Protection		IP66

\*Technical spec subject to change without notice



- **MRU - Medium Power Remote Unit**
- **System performance**
- **Head End to Medium power Remote Unit**



RF										
Frequency Range Name		600	700L & 700U & FirstNet			800 /850	1900	EAWS	WCS	2500
Frequency Range	Uplink	663-698	698-716	777-798	817-849	1850-1915	1710-1780	2305-2315	2496-2690	
	Downlink	617-652	728-746	746-768	862-894	1930-1995	2110-2180	2350-2360		
Max. Operating Bandwidth-Non-contiguous	MHz	Full Band								
Instantaneous Bandwidth	MHz	35	18	21	32	65	70	10	60+ 60	
Downlink Output Power	dBm	33	33		33	37	37	37	37	
Attenuator Adjustable Range (1dB step)	dB	0-20								
Pass Band Ripple (p-p)	dB	≤ 4								
Channel Bandwidth	MHz	5/10/15/20							5/10/15/20 for 4G 40 or 60 for 5G	
Uplink Noise Figure (typical)	dB	12								
Uplink IIP3 (typical)	dB	-12								
VSWR		≤ 1.8								
EVM (256 QAM) (TM3.1A@ Rated power)	%	< 3.5								
Spurious Emission		3GPP TS 36.106/25.106; 3GPP TS 38.104 V15.5.0 (sections 6; 7)								
CBRS ready frequencies	MHz	3350-3980. Combined with all other services								
Coupling port	dB	35								
Electrical Specifications										
Power Consumption (Typical)	Watt	With DC power supply: 515 With AC power supply: 550								
DC voltage	DC	48								

Interfaces and Mechanical		
CPRI Port		2, SFP+ 10.1Gbps
Antenna Ports		1, 4.3-10 female
CBRS port		1, N-Type female
Coupling port		1, QMA connector that will enable measurement of the DL/UL signals while the system is working
Dimension (W x H x D)	Inch (mm)	17.45 x 10.5 x 15.75 (443.2 x 266.7 x 400)
Mounting and installation		19", 6U -Wall mount and Rack mount options
Weight	Lbs (Kg)	83.77(38) -Fully populated with 6 RF modules
Cooling		Active
Environmental		
Operational Temperature	°F (°C)	-40° to 131° (-40° to 55°)
Indoor installation		For outdoor applications external enclosure is required

\*Technical spec subject to change without notice



- **HRU -High-Power Remote Unit**
- **System performance (Head End to High power Remote Unit)**

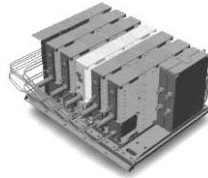

RF											
Frequency Range Name		600	700L & 700U & FirstNet			800 /850	1900	EAWS	WCS	2500	
Frequency Range	Uplink	663-698	698-716	777-798	817-849	1850-1915	1710-1780	2305-2315	2496-2690		
	Downlink	617-652	728-746	746-768	862-894	1930-1995	2110-2180	2350-2360			
Max. Operating Bandwidth-Non-contiguous	MHz	Full Band									
Instantaneous Bandwidth	MHz	35	18	21	32	65	70	10	100		
Downlink Output Power	dBm	43	43		43	43	43	43	43		
Attenuator Adjustable Range (1dB step)	dB	0-20									
Pass Band Ripple (p-p)	dB	≤ 4									
Channel Bandwidth	MHz	5/10/15/20							5/10/15/20 for 4G		40 or 60 for 5G
Uplink Noise Figure (typical)	dB	6									
Uplink IIP3 (typical)	dB	-20									
VSWR		≤ 1.8									
EVM (256 QAM) (TM3.1A@ Rated power)	%	< 3.5									
Spurious Emission		3GPP TS 36.106/25.106; 3GPP TS 38.104 V15.5.0 (sections 6; 7)									
Electrical Specifications											
Power Consumption (Typical)	Watt	OEU (Optical Expansion Unit) –connected to RFU's					50				
		RFU (RF Unit) – MIMO 2:2 for the bands 600,700,800/850,1700.1900,2300,2500TDD					220				
AC voltage	AC	100-240									



Interfaces and Mechanical			
CPRI Port		4, SFP+ 10.1Gbps	
Antenna Ports		1, 4.3-10 female	
Dimension (W x H x D)	Inch (mm)	OEU	14.6 x 3.2 x 13.8 (370 x 80 x 355)
		RFU except 700	19.7 x 3.2 x 13.8 (500 x80 x355)
		RFU 700	19.7 x4.8 x 13.8 (500 x121 x355)
Mounting and installation		Wall mount	
Weight	Lbs (Kg)	OEU	26.4 (12)
		RFU except 700	39.6 (18)
		RFU 700	44 (20)
Cooling		Convection	
Environmental			
Operational Temperature	°F (°C)	-40° to 131° (-40° to 55°)	
Outdoor installation (Ingress Protection)		IP 65	

\*Technical spec subject to change without notice

Low Bands Combiner specifications					
The Low band combiner is designed to combine the following services :600MHz,700MHz, 800/850MHz and high frequencies from the Medium Band combiner					
Frequency Name		600	700	800/850	High Freq
Port Name		Port 1	Port 2	Port 3	Port 4
Frequency Range	MHz	617-716	728-798	817-894	1695-2690
Insertion Loss	dB	≤0.3			
Port Isolation	dB	≥50			
Return Loss	dB	≤20			
Pass band ripple	dB	≤0.2			
PIM	dBc	≤155@2x43dBm			
Power Capacity	Watt	250 per port			
Interface					
Connector		4.3-10 Mini DIN-Female			

\*Technical spec subject to change without notice





**Medium Bands Combiner specifications**  
 The medium band combiner is designed to combine the following services: 1900, EAWS, WCS and 2.5GHz.  
 If a single module is required a single input (2500) is used.  
 If 2 \* 2.5GHz RF modules are used (to support 4G and 5G services) 2 inputs are required (2500 IN1 and 2500 IN2) .

Frequency Name		1900	EAWS	WCS	2500	2500 IN1	2500 IN 2	2500 OUT
Port Name		Port 1	Port 2	Port 3	Port 4	Port 5	Port 6	Port7
Frequency Range	MHz	1850-2020	1695-1780 2110-2200	2305-2360	2496-2690			
Insertion Loss	dB	≤ 0.3				≤3.3		
Port Isolation	dB	≥50				≥20, 2500 IN1 to 2500 IN2 ≥50 to Other ports		
Return Loss	dB	≤20						
Pass band ripple	dB	≤ 0.2						
PIM	dBc	≤155@2×43dBm						
Power Capacity	Watt	250 per port						
Interface								
Connector		4.3-10 Mini DIN-Female						

\*Technical spec subject to change without notice

## 9. APPENDIX B: Ordering information

### ➤ Headend Unit Assemblies and RF Modules

Part Number	Description
HEU:	Head End Unit Assembly (without RIME); provided with ERFC, one PSM and one RIX ( supports up to 12 RIME's)
HEU-1-00-1-A-A	Hosts one RIX module; one ETM, one PSM-AC and one ACM
HEU-1-00-1-D-A	Hosts one RIX module; one ETM, one PSM-DC and one ACM
HEU-1-00-2-A-A	Hosts one RIX module; one ETM , 2 PSM-AC and one ACM
HEU-1-00-2-D-A	Hosts one RIX module; one ETM, 2 PSM-DC and one ACM

Part Number	Description
RIME-25T	2500 MHz TDD
RIME-W23	WCS 2300 MHz
RIME-L70	LTE 700 MHz
RIME-E80	CELL/ESMR 800 MHz
RIME-A17	AWS 1700 MHz
RIME-P19	PCS 1900 MHz
RIME-FN70	FirstNet® 700 MHz
RIME-L60	TMO 600 MHz

*Note: IHUs support both RIMe and OIMs (ordering information detailed in HEU and OIU ordering information).*

Part Number	Description
IHU:	Integrated Headend Unit Assembly (without RIMe and DCM's); provided with ERFC cable, one RIX and one OIX. Supports up to eight RIMe and two DCM's
IHU-2-11-1-A-dH	Hosts one RIX; one OIX; one ERFC cable; one PSM-AC module and one dHCM module
IHU-2-11-2-A-dH	Hosts one RIX; one OIX; one ERFC cable; two PSM-AC modules and one dHCM module
IHU-2-11-1-A-A	Hosts one RIX; one OIX; one ERFC cable; one PSM-AC module and one ACM module
IHU-2-11-2-A-A	Hosts one RIX; one OIX; one ERFC cable; two PSM-AC module and one ACM module
IHU-2-11-1-D-dH	Hosts one RIX; one OIX; one ERFC cable; one PSM-DC module and one dHCM module
IHU-2-11-2-D-dH	Hosts one RIX; one OIX; one ERFC cable; two PSM-DC modules and one dHCM module
IHU-2-11-1-D-A	Hosts one RIX; one OIX; one ERFC cable; one PSM-DC module and one ACM module
IHU-2-11-2-D-A	Hosts one RIX; one OIX; one ERFC cable; two PSM-DC module and one ACM module

Part Number	Description
dHCM	Digital Headed Control Module; Includes two RJ45 cables (2 m)
ACM	Auxiliary Control Module; Includes two RJ45 cables (2 m)
DCM -4-S	Digital Conversion Module 4 CPRI ports, SISO (SFP+ not included)

Part Number	Description
PSM-AC	AC Power Supply – installed in HEU, OIUc, and IHU chassis; includes U.S. plug power cords
PSM-DC	DC Power Supply - installed in HEU, OIUc, and IHU chassis; includes 48 V DC six-pin terminal block connector

➤ **DRU Part Numbers**

Part Number	Description
DRU-1A-32C-4C-AD	Digital Routing Unit, 32 CPRI Ports of Distribution, 4 CPRI ports for uplink, AC and DC Power( SFP+, not included)

➤ **LRU Part Numbers**

Part Number	Description
<b>Stand Alone Modules</b>	
dLRU-678	LRU module, supporting low bands in MIMO configuration: 600, 700 and 800/850
dLRU-17192325	LRU module, supporting mid bands in MIMO configuration: PCS, AWS, WCS and TDD 2500 MHz
dLRU-COMB	LRU combiner for low, mid band including CBRS/C-Band, including jumper cables, termination loads and combiner plate
dLRU-CABLE	Jumper cable between the LRU and the combiner
dLRU-TL	Termination load for LRU combiner
<b>Assemblies</b>	
dLRU-67817192325	LRU set including: LRU low band, LRU mid band, mounting brackets, combiner plate, jumper cables, termination load, combiner
<b>Wall Mount bracket</b>	
BR-dLRU	LRU bracket for wall or ceiling mount installation

➤ **MRU Part Numbers**

Part Number	Description
<b>Stand Alone Modules</b>	
dMRU-ASM-DC	MRU Chassis Assembly with: dOPTM ,FAM, Mid-Plane, Cavity Filter, DC power supply
dMRU-ASM-AC	MRU Chassis Assembly with: dOPTM ,FAM, Mid-Plane, Cavity Filter, AC power supply
dMRU-CHS-ASM	MRU Chassis Assembly with: dOPTM ,FAM, Mid-Plane, Cavity Filter
dMRU-dOPTM	MRU Digital Optical Module
dMRU-PSM-AC	MRU Power Supply Module AC feeding
dMRU-PSM-DC	MRU Power Supply Module DC feeding
dMRU-DPAM-67	MRU- Digital Power Amplifier Module supporting 600,700 Lower,700 Upper and Firstnet
dMRU-DPAM-8	MRU- Digital Power Amplifier Module supporting 800/850
dMRU-DPAM-17	MRU- Digital Power Amplifier Module supporting AWS 1700MHz
dMRU-DPAM-19	MRU- Digital Power Amplifier Module supporting PCS 1900MHz
dMRU-DPAM-23	MRU- Digital Power Amplifier Module supporting WCS 2300MHz
dMRU-DPAM-25-TDD	MRU- Digital Power Amplifier Module supporting TDD 2500MHz
<b>Assemblies</b>	
dMRU-671719-AC	MRU-AC Assembly w/ DPAM: 600/700,AWS, PCS
dMRU-671719-DC	MRU-DC Assembly w/ DPAM: 600/700,AWS, PCS
dMRU-671923-AC	MRU-AC Assembly w/ DPAM: 600/700,AWS, PCS, WCS
dMRU-671923-DC	MRU-DC Assembly w/ DPAM: 600/700,AWS, PCS, WCS
dMRU-6781719-AC	MRU-AC Assembly w/ DPAM: 600/700,800/850, PCS , AWS
dMRU-6781719-DC	MRU-DC Assembly w/ DPAM: 600/700,800/850, PCS , AWS
dMRU-678171923-AC	MRU-AC Assembly w/ DPAM: 600/700,800/850, PCS, AWS , WCS
dMRU-678171923-DC	MRU-DC Assembly w/ DPAM: 600/700,800/850, PCS, AWS , WCS
dMRU-67817192325-AC	MRU-AC Assembly w/ DPAM: 600/700,800/850, AWS, PCS, WCS , TDD 2500
dMRU-67817192325-DC	MRU-DC Assembly w/ DPAM: 600/700,800/850, AWS, PCS, WCS , TDD 2500
dMRU-67819-AC	MRU-AC Assembly w/ DPAM: 600/700,800/850, PCS
dMRU-67819-DC	MRU-DC Assembly w/ DPAM: 600/700,800/850, PCS
dMRU-6781923-AC	MRU-AC Assembly w/ DPAM: 600/700,800/850, PCS, WCS
dMRU-6781923-DC	MRU-DC Assembly w/ DPAM: 600/700,800/850, PCS, WCS
<b>Wall Mount Bracket</b>	
BR-dMRU-W	MRU Wall Mounting Bracket
<b>General Information</b>	

MRU-DC/AC includes: OPTM, FAM, Mid-Plane and Cavity Filter Shipping Box will include:  
 AC power Cord-3m (in case of AC), BR-dMRU-R  
 Wall mount BR is not included, should be ordered separately.

**HRU Part Numbers**

Part Number	Description
<b>Stand Alone Modules</b>	
dHRU-dHPOM	HRU Digital High Power Optical Module
dHRU-dHPAM-6	HRU Digital High Power Amplifier Module supporting 600
dHRU-dHPAM-7	HRU Digital High Power Amplifier Module supporting 700
dHRU-dHPAM-85	HRU Digital High Power Amplifier Module supporting 800/850
dHRU-dHPAM-19	HRU Digital High Power Amplifier Module supporting PCS
dHRU-dHPAM-17	HRU Digital High Power Amplifier Module supporting AWS
dHRU-dHPAM-23	HRU Digital High Power Amplifier Module supporting WCS
dHRU-dHPAM-25	HRU Digital High Power Amplifier Module supporting TDD 2500, 100MHz contiguous BW
dHRU-COMB-L	HRU combiner module supporting low bands 600,700,800/850 including cables
dHRU-COMB-M	HRU combiner module supporting low bands AWS,PCS,WCS and TDD 2500 including cables
dHRU-TL	HRU termination load
BR-dHRU-L	HRU bracket to support low band modules
BR-dHRU-M	HRU bracket to support mid band modules
dHRU-CABLE	HRU 4.3-10 RF Jumper Cable
dHRU-INT-SFP	HRU Internal SFPs (from dHRU-dHPOM to modules) and Fiber
<b>Assemblies</b>	
dHRU-6781719232525-AC	HRU assembly supporting low and mid bands in a MIMO configuration: 600, 700, 800/850, PCS, AWS, WCS, TDD 2500
dHRU-678-AC	HRU assembly supporting low bands in a MIMO configuration: 600, 700, 800/850
dHRU-781719-AC	HRU assembly supporting low and mid bands in a MIMO configuration: 700, 800/850, PCS, AWS
dHRU-1719232525-AC	HRU assembly supporting mid bands in a MIMO configuration: PCS, AWS, WCS, TDD 2500

**➤ SFP+ Part Numbers**

Part Number	Description
SFP-10G-10K-BiDi-1270	SFP+ 10.1Gb/s ,10Km, Bi Directional TX 1270nm, for DCM and DRU output connected to Remote Units
SFP-10G-10K-BiDi-1330	SFP+ 10.1Gb/s ,10Km, Bi Directional TX 1330nm, for Remote Units and DRU input connected to DCM
SFP-10G-10K	SFP+ 10.1Gb/s ,10Km, dual fiber
SFP-10G-1.4K	SFP+ 10.1Gb/s ,1.4Km, dual fiber