



DATE: 22 June 2020

**I.T.L. (PRODUCT TESTING) LTD.
FCC Radio Test Report
For**

**Corning Optical Communication Wireless
Equipment under test:**

ONE - Distributed Antenna System

Remote Extender Unit RXU2325

(TDD Section 2496-2690MHz Band)

Tested by:

M. Zohar

Approved by:

D. Shidlow

This report must not be reproduced, except in full, without the written permission of I.T.L. (Product Testing) Ltd.

This report relates only to items tested.



Measurement/Technical Report for Corning Optical Communication Wireless ONE - Distributed Antenna System

FCC ID: OJF1RXUN

This report concerns: Original Grant:
 Class II change: X
 Class I change:

Equipment type: B21 - Part 20 Industrial Booster (CMRS)

Limits used: 47CFR Parts 2; 27

Measurement procedure used is KDB 935210 D05 v01r03 April 2019 and
ANSI IEEE C63.26-2015

Substitution Method used as in ANSI TIA-603-E-2016

Application for Certification
prepared by:
D. Shidlowky
ITL (Product Testing) Ltd.
1 Bat Sheva St.
Lod 7120101
Israel
e-mail davids@iltglobal.org

Applicant for this device:
(different from "prepared by")
Isaac Nissan
Corning Optical Communication Wireless
8253 1st Street
Vienna, VA 22812
U.S.A.
Tel: +1-703 855-1773
e-mail: NissanI@corning.com



TABLE OF CONTENTS

1	GENERAL INFORMATION -----	4
	1.1 Administrative Information	4
	1.2 List of Accreditations	5
	1.3 Product Description	6
	1.4 Test Methodology	6
	1.5 Test Facility	6
	1.6 Measurement Uncertainty	6
2	SYSTEM TEST CONFIGURATION -----	7
	2.1 Justification	7
	2.2 EUT Exercise Software	7
	2.3 Special Accessories	7
	2.4 Equipment Modifications	7
	2.5 Configuration of Tested System	8
3	TEST SET-UP PHOTOS -----	10
4	RF POWER OUTPUT -----	13
	4.1 Test Specification	13
	4.2 Test Procedure	13
	4.3 Test Limit	13
	4.4 Test Results	13
	4.5 Test Equipment Used; RF Power Output	44
5	OCCUPIED BANDWIDTH -----	45
	5.1 Test Specification	45
	5.2 Test Procedure	45
	5.3 Test Limit	45
	5.4 Test Results	45
	5.5 Test Equipment Used; Occupied Bandwidth	106
6	SPURIOUS EMISSIONS AT ANTENNA TERMINALS -----	107
	6.1 Test Specification	107
	6.2 Test Procedure	107
	6.3 Test Limit	107
	6.4 Test Results	107
	6.5 Test Equipment Used; Spurious Emissions at Antenna Terminals	156
7	SPURIOUS RADIATED EMISSION -----	157
	7.1 Test Specification	157
	7.2 Test Procedure	157
	7.3 Test Limit	158
	7.4 Test Results	158
	7.5 Test Instrumentation Used; Radiated Measurements	159
8	APPENDIX A - CORRECTION FACTORS -----	160
	8.1 Correction factors for RF OATS Cable 35m	160
	8.2 Correction factors for RF OATS Cable 10m	161
	8.3 Correction factors for Horn Antenna	162
	8.4 Correction factors for Horn Antenna	163
	8.5 Correction factors for Log Periodic Antenna	164
	8.6 Correction factors for Biconical Antenna	165
	8.7 Correction factors for ACTIVE LOOP ANTENNA	166



1 General Information

1.1 Administrative Information

Manufacturer:	Corning Optical Communication Wireless
Manufacturer's Address:	8253 1st Street Vienna, VA 22812 U.S.A. Tel: +1-703 855-1773
Manufacturer's Representative:	Isaac Nissan
Equipment Under Test (E.U.T):	ONE - Distributed Antenna System
Equipment Model No.:	Remote Extender Unit RXU2325
Equipment Serial No.:	Not Designated
Date of Receipt of E.U.T:	February 02, 2020
Start of Test:	February 06, 2020
End of Test:	April 13, 2020 (See Note below)
Test Laboratory Location:	I.T.L (Product Testing) Ltd. 1 Batsheva St, Lod, Israel 7116002
Test Specifications:	FCC Parts 2; 27

Note: Spurious radiated emission testing was performed on April 13, 2020.



1.2 List of Accreditations

The EMC laboratory of I.T.L. is accredited by/registered with the following bodies:

1. The American Association for Laboratory Accreditation (A2LA) (U.S.A.), Certificate No. 1152.01.
2. The Federal Communications Commission (FCC) (U.S.A.), FCC Designation Number is IL1005.
3. The Israel Ministry of the Environment (Israel), Registration No. 1104/01.
4. The Voluntary Control Council for Interference by Information Technology Equipment (VCCI) (Japan), Registration Numbers: C-20025, R-2729, T-20028, G-20068.
5. Department of Innovation, Science and Economic Development (ISED) Canada, CAB identifier: IL1002.

I.T.L. Product Testing Ltd. is accredited by the American Association for Laboratory Accreditation (A2LA) and the results shown in this test report have been determined in accordance with I.T.L.'s terms of accreditation unless stated otherwise in the report.



1.3 Product Description

The RxU2325 is an add-on module which plugs into the RAU (either RAU5x, RAU5 or RAU4) and enables support for two additional bands: 2.3 GHz WCS and 2.5 GHz LTE (TDD).

1.4 Test Methodology

Both conducted and radiated testing were performed according to the procedures in KDB 935210 D05 v01r03 April 2019 and ANSI/TIA-603-E-2016. Radiated testing was performed at an antenna to EUT distance of 3 meters.

1.5 Test Facility

Both conducted and radiated emissions tests were performed at I.T.L.'s testing facility in Lod, Israel. I.T.L.'s EMC Laboratory is accredited by A2LA, certificate No. 1152.01 and its FCC Designation Number is IL1005.

1.6 Measurement Uncertainty

Conducted Emission (CISPR 11, EN 55011, CISPR 32, EN 55032, ANSI C63.4)

0.15 – 30 MHz:

Expanded Uncertainty (95% Confidence, K=2):

± 3.44 dB

Radiated Emission (CISPR 11, EN 55011, CISPR 32, EN 55032, ANSI C63.4) for open site 30-1000MHz:

Expanded Uncertainty (95% Confidence, K=2):

± 4.98 dB

2 System Test Configuration

2.1 Justification

The E.U.T. was previously tested for FCC certification as follows:
The EUT consists of the RXU2325 installed in RAU5X
The E.U.T. has been fully tested receiving signals from the RAU5X.
The test setup was configured to closely resemble the standard installation.
All source signals are represented in the setup by appropriate signal generators.
An “Exercise” SW on the computer was used to enable / disable transmission of the RAU5x, while the EUT output was connected to the spectrum analyzer.
All channels transmitted during the testing.
There is neither an intermediate amplified nor donor antenna in the uplink.
All components included in the UL path are connected by cables.
Presently the following tests were performed in order to allow the use of 5G:
RF output power, occupied bandwidth, and spurious emissions.

2.2 EUT Exercise Software

rxut_ab64_37_50

2.3 Special Accessories

No special accessories were needed in order to achieve compliance.

2.4 Equipment Modifications

No modifications were necessary in order to achieve compliance.

2.5 Configuration of Tested System

Product Name	ONE Distributed Antenna System
Model Name	RXU 2325
Working voltage	48.0VDC
Mode of operation	Industrial Booster for TDD 2.5G band
Modulations	64QAM, 16QAM, 256QAM
Assigned Frequency Range	2496.0MHz-2690.0MHz
Operation Frequency Range	2496.0MHz-2690.0MHz
Transmit power	~20.0dBm
Antenna Gain	12.5 dBi
DATA rate	N/A
Modulation BW	10.0MHz

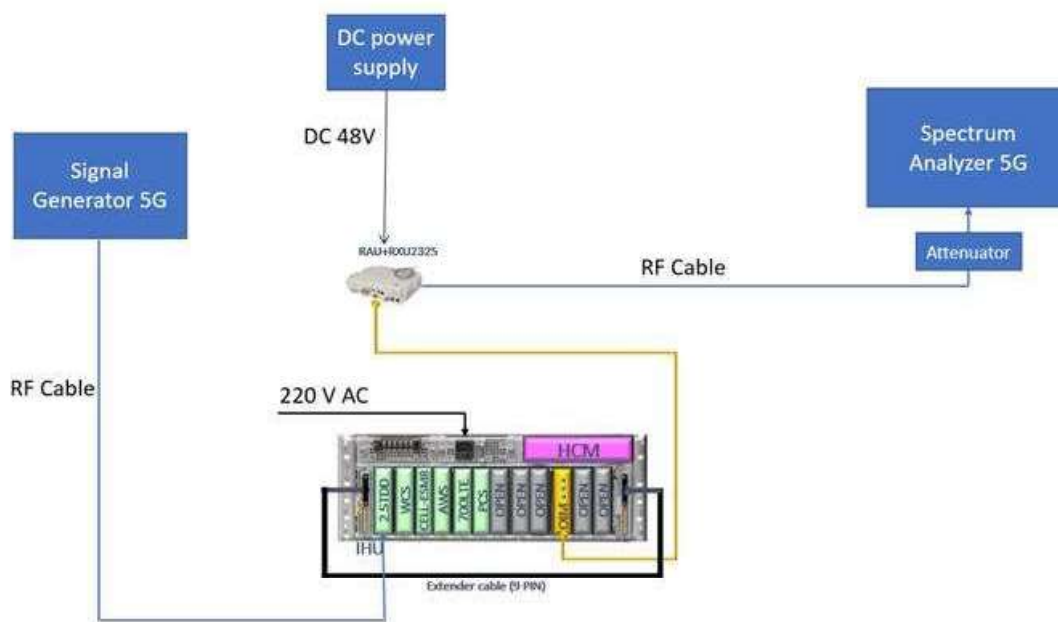

Figure 1. Conducted Test Set-Up

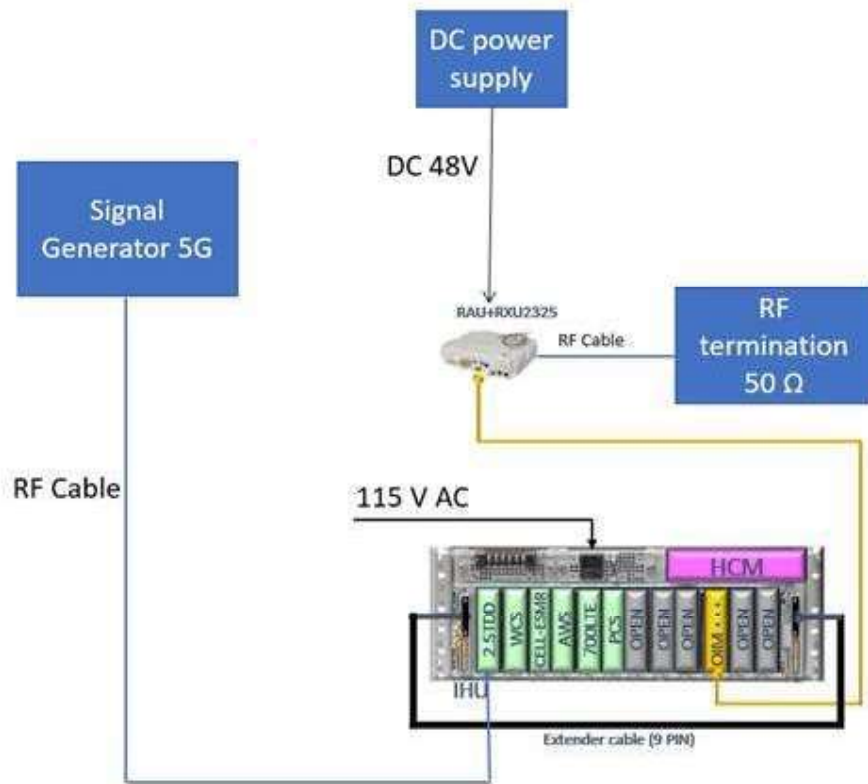

Figure 2. Radiated Test Set-Up

3 Test Set-Up Photos

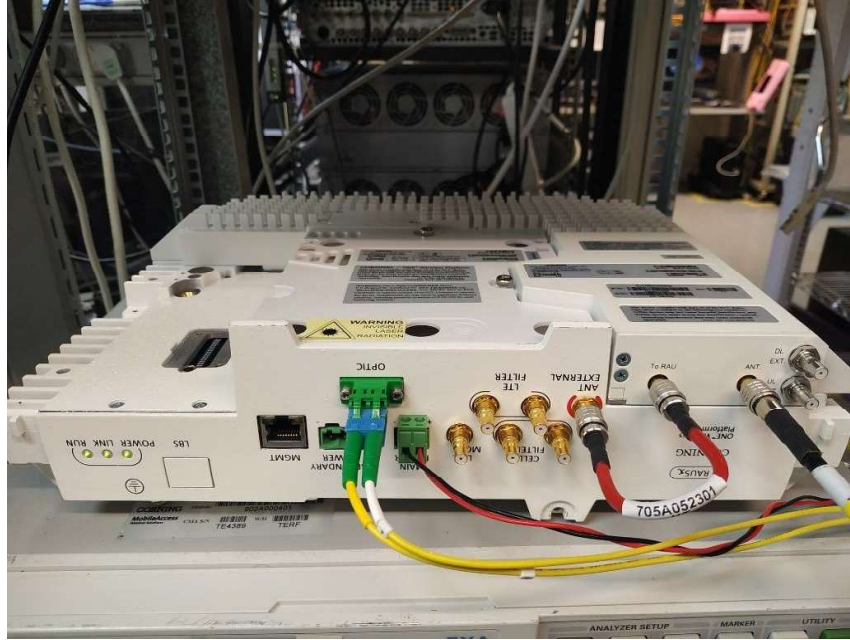

Figure 3. Conducted Emission From Antenna Port Tests

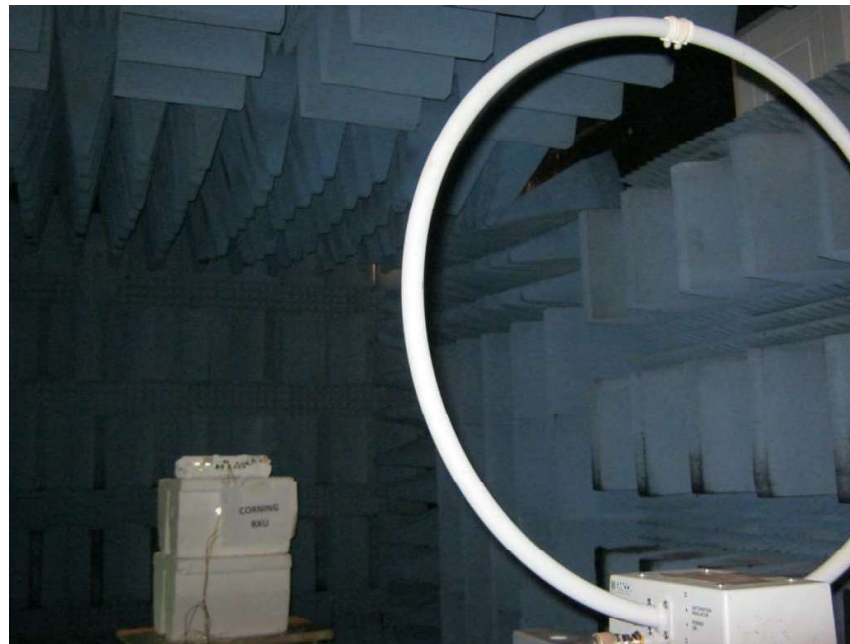

Figure 4. Radiated Emission Test 9kHz - 30MHz



Figure 5. Radiated Emission Test 30 - 200 MHz



Figure 6. Radiated Emission Test 200 - 1000MHz



Figure 7. Radiated Emission Test 1-18GHz



Figure 8. Radiated Emission Test 18-26.5GHz

4 RF Power Output

4.1 Test Specification

FCC Part 27, Subpart C (27.50)

4.2 Test Procedure

(Temperature (23°C)/ Humidity (35%RH))

The E.U.T. antenna terminal was connected to the Spectrum Analyzer through an external attenuator and an appropriate coaxial cable (31.0 dB). Special attention was taken to prevent Spectrum Analyzer RF input overload.

4.3 Test Limit

The maximum EIRP of a main, booster or base station shall not exceed $33 \text{ dBW} + 10\log(X/Y) \text{ dBW}$, where X is the actual channel width in MHz and Y is either 6 MHz if prior to transition or the station is in the MBS following transition or 5.5 MHz if the station is in the LBS and UBS following transition. The limit is calculated to be 62.2 dBm.

4.4 Test Results

JUDGEMENT: Passed

See additional information in Table 1 to Table 6 and Figure 9 to Figure 152.

Modulation	Bandwidth	Sub Carrier	Operation Frequency	Reading	Antenna Gain	EIRP	Limit	Margin		
	(MHz)	(kHz)	(MHz)	(dBm)	(dBi)	(dBm)	(dBm)	(dB)		
16QAM	5	15	2498.5	19.24	12.5	31.7	62.2	-30.5		
		30		19.26		31.8	62.2	-30.4		
		15	2593.0	18.88		31.4	62.2	-30.8		
		30		19.29		31.8	62.2	-30.4		
		15	2687.5	19.22		31.7	62.2	-30.5		
		30		19.76		32.3	62.2	-29.9		
	10	15	2501.0	18.76		31.3	62.2	-30.9		
				30		18.78	31.3	62.2	-30.9	
				60		19.81	32.3	62.2	-29.9	
		30	2593.0	18.19		30.7	62.2	-31.5		
				30		18.68	31.2	62.2	-31.0	
				60		19.89	32.4	62.2	-29.8	
		60	2685.0	18.55		31.1	62.2	-31.2		
				30		18.77	31.3	62.2	-30.9	
				60		19.86	32.4	62.2	-29.8	
		15	15	2503.0		19.63	32.1	62.2	-30.1	
						30	19.59	32.1	62.2	-30.1
						60	19.69	32.2	62.2	-30.0
	30		2593.0	20.10		32.6	62.2	-29.6		
				30		19.86	32.4	62.2	-29.8	
				60		19.09	31.6	62.2	-30.6	
	60		2682.5	19.30		31.8	62.2	-30.4		
				30		19.53	32.0	62.2	-30.2	
				60		19.14	31.6	62.2	-30.6	
	20		15	2506.0		19.87	32.4	62.2	-29.8	
						30	19.92	32.4	62.2	-29.8
						60	19.48	32.0	62.2	-30.2
		30	2593.0	19.28		31.8	62.2	-30.4		
				30		19.26	31.8	62.2	-30.4	
				60		19.00	31.5	62.2	-30.7	
		60	2680.0	18.74		31.2	62.2	-31.0		
				30		19.13	31.6	62.2	-30.6	
				60		18.97	31.5	62.2	-30.7	

Table 1 RF Power Output 16QAM

Modulation	Bandwidth	Sub Carrier	Operation Frequency	Reading	Antenna Gain	EIRP	Limit	Margin
	(MHz)	(kHz)	(MHz)	(dBm)	(dBi)	(dBm)	(dBm)	(dB)
16QAM	40	15	2516.0	19.47	12.5	32.0	62.2	-30.2
		30		19.24		31.7	62.2	-30.5
		60		19.71		32.2	62.2	-30.0
		15	2593.0	18.95		31.5	62.2	-30.8
		30		19.06		31.6	62.2	-30.6
		60		19.17		31.7	62.2	-30.5
		15	2670.0	19.16		31.7	62.2	-30.5
		30		19.28		31.8	62.2	-30.4
		60		19.74		32.2	62.2	-30.0
	60	30	2526.0	19.43		31.9	62.2	-30.3
				19.86		32.4	62.2	-29.8
		60	2593.0	19.27		31.8	62.2	-30.4
				19.23		31.7	62.2	-30.5
		30	2660.0	19.82		32.3	62.2	-29.9
				19.52		32.0	62.2	-30.2

Table 2 RF Power Output 16QAM

Modulation	Bandwidth	Sub Carrier	Operation Frequency	Reading	Antenna Gain	EIRP	Limit	Margin		
	(MHz)	(kHz)	(MHz)	(dBm)	(dBi)	(dBm)	(dBm)	(dB)		
64QAM	5	15	2498.5	19.60	12.5	32.1	62.2	-30.1		
		30		19.78		32.3	62.2	-29.9		
		15	2593.0	19.23		31.7	62.2	-30.5		
		30		19.41		31.9	62.2	-30.3		
		15	2687.5	19.07		31.6	62.2	-30.6		
		30		19.65		32.2	62.2	-30.1		
	10	15	2501.0	19.92		32.4	62.2	-29.8		
				30		20.08	32.6	62.2	-29.6	
				60		19.96	32.5	62.2	-29.7	
		30	2593.0	19.36		31.9	62.2	-30.3		
				30		19.65	32.2	62.2	-30.1	
				60		19.36	31.9	62.2	-30.3	
		60	2685.0	19.48		32.0	62.2	-30.2		
				30		19.62	32.1	62.2	-30.1	
				60		19.51	32.0	62.2	-30.2	
		15	15	2503.5		19.51	32.0	62.2	-30.2	
						30	19.40	31.9	62.2	-30.3
						60	19.35	31.9	62.2	-30.4
	30		2593.0	19.51		32.0	62.2	-30.2		
				30		19.40	31.9	62.2	-30.3	
				60		19.59	32.1	62.2	-30.1	
	60		2682.5	19.52		32.0	62.2	-30.2		
				30		19.45	32.0	62.2	-30.3	
				60		19.41	31.9	62.2	-30.3	
	20		15	2506.0		19.67	32.2	62.2	-30.0	
						30	19.69	32.2	62.2	-30.0
						60	19.68	32.2	62.2	-30.0
		30	2593.0	19.68		32.2	62.2	-30.0		
				30		19.73	32.2	62.2	-30.0	
				60		19.67	32.2	62.2	-30.0	
		60	2680.0	19.60		32.1	62.2	-30.1		
				30		19.53	32.0	62.2	-30.2	
				60		19.47	32.0	62.2	-30.2	

Table 3 RF Power Output 64QAM

Modulation	Bandwidth	Sub Carrier	Operation Frequency	Reading	Antenna Gain	EIRP	Limit	Margin
	(MHz)	(kHz)	(MHz)	(dBm)	(dBi)	(dBm)	(dBm)	(dB)
64QAM	40	15	2516.0	19.77	12.5	32.3	62.2	-29.9
		30		19.84		32.3	62.2	-29.9
		60		19.89		32.4	62.2	-29.8
		15	2593.0	19.87		32.4	62.2	-29.8
		30		18.93		31.4	62.2	-30.8
		60		19.16		31.7	62.2	-30.5
		15	2670.0	19.75		32.3	62.2	-30.0
		30		19.74		32.2	62.2	-30.0
		60		19.82		32.3	62.2	-29.9
	60	60	30	2526.0	18.90	31.4	62.2	-30.8
			60		18.93	31.4	62.2	-30.8
			30	2593.0	20.09	32.6	62.2	-29.6
			60		19.54	32.0	62.2	-30.2
			30	2660.0	19.55	32.1	62.2	-30.2
			60		19.10	31.6	62.2	-30.6

Table 4 RF Power Output 64QAM

Modulation	Bandwidth	Sub Carrier	Operation Frequency	Reading	Antenna Gain	EIRP	Limit	Margin	
	(MHz)	(kHz)	(MHz)	(dBm)	(dBi)	(dBm)	(dBm)	(dB)	
256QAM	5	15	2498.5	18.83	12.5	31.3	62.2	-30.9	
		30		19.31		31.8	62.2	-30.4	
		15	2593.0	19.84		32.3	62.2	-29.9	
		30		19.58		32.1	62.2	-30.1	
		15	2687.5	19.52		32.0	62.2	-30.2	
		30		19.39		31.9	62.2	-30.3	
	10	15	2501.0	19.81		32.3	62.2	-29.9	
				30		19.63	32.1	62.2	-30.1
				60		19.53	32.0	62.2	-30.2
		30	2593.0	19.69		32.2	62.2	-30.0	
				19.73		32.2	62.2	-30.0	
				19.94		32.4	62.2	-29.8	
		60	2685.0	19.37		31.9	62.2	-30.3	
				19.54		32.0	62.2	-30.2	
				19.37		31.9	62.2	-30.3	
	15	15	2503.5	19.68		32.2	62.2	-30.0	
				19.78		32.3	62.2	-29.9	
				19.74		32.2	62.2	-30.0	
		30	2593.0	19.94		32.4	62.2	-29.8	
				19.56		32.1	62.2	-30.1	
				19.36		31.9	62.2	-30.3	
		60	2682.5	19.26		31.8	62.2	-30.4	
				19.30		31.8	62.2	-30.4	
				19.41		31.9	62.2	-30.3	
	20	15	2506.0	19.63		32.1	62.2	-30.1	
				19.68		32.2	62.2	-30.0	
				19.82		32.3	62.2	-29.9	
		30	2593.0	19.18		31.7	62.2	-30.5	
				19.22		31.7	62.2	-30.5	
				19.55		32.1	62.2	-30.2	
		60	2680.0	19.26		31.8	62.2	-30.4	
				19.45		32.0	62.2	-30.3	
				19.46		32.0	62.2	-30.2	

Table 5 RF Power Output 256QAM

Modulation	Bandwidth	Sub Carrier	Operation Frequency	Reading	Antenna Gain	EIRP	Limit	Margin
	(MHz)	(kHz)	(MHz)	(dBm)	(dBi)	(dBm)	(dBm)	(dB)
256QAM	40	15	2516.0	19.84	12.5	32.3	62.2	-29.9
		30		19.79		32.3	62.2	-29.9
		60		19.73		32.2	62.2	-30.0
		15	2593.0	19.47		32.0	62.2	-30.2
		30		19.77		32.3	62.2	-29.9
		60		19.06		31.6	62.2	-30.6
		15	2670.0	19.60		32.1	62.2	-30.1
		30		19.51		32.0	62.2	-30.2
		60		19.70		32.2	62.2	-30.0
	60	30	2526.0	19.20	31.7	62.2	-30.5	
				19.40	31.9	62.2	-30.3	
		60	2593.0	19.77	32.3	62.2	-29.9	
				19.06	31.6	62.2	-30.6	
		30	2660.0	19.82	32.3	62.2	-29.9	
				19.83	32.3	62.2	-29.9	

Table 6 RF Power Output 256QAM

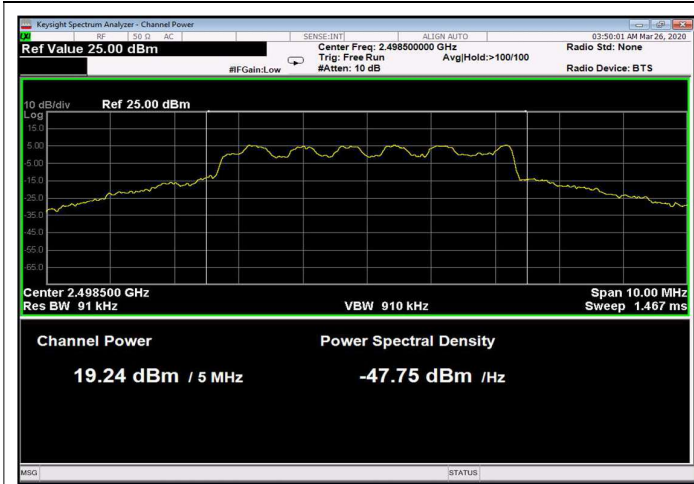

Figure 9: 16QAM 5MHz B.W.; 2498.5MHz, 15kHz

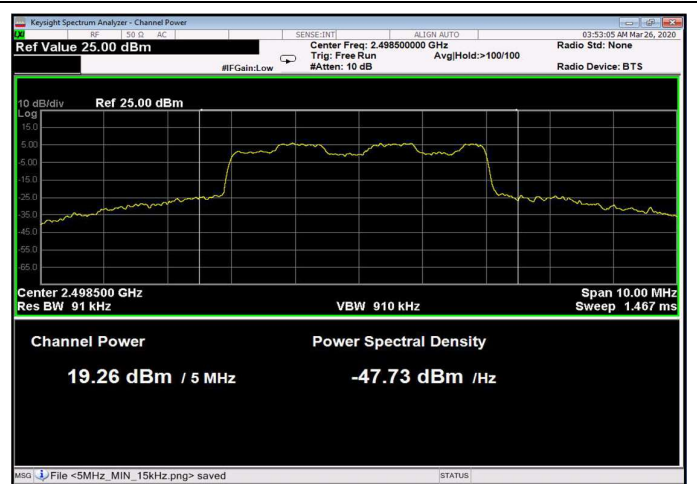

Figure 10: 16QAM 5MHz B.W.; 2498.5MHz, 30kHz

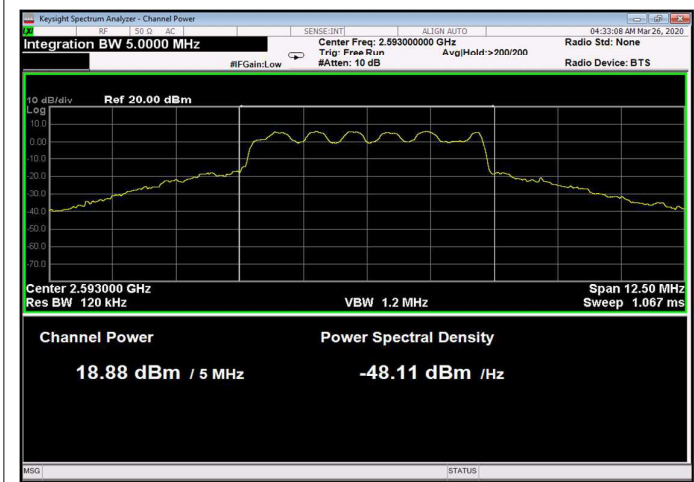

Figure 11: 16QAM 5MHz B.W.; 2593.0MHz, 15kHz

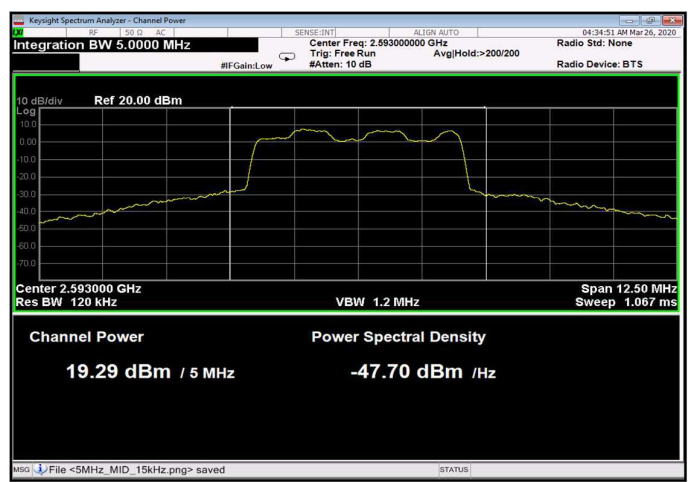

Figure 12: 16QAM 5MHz B.W.; 2593.0MHz, 30kHz

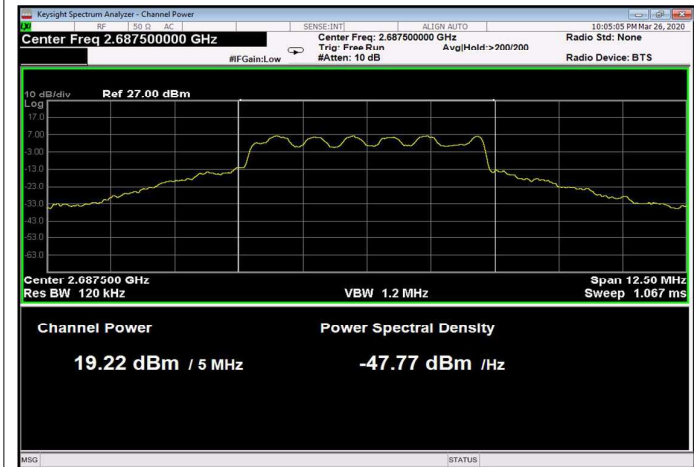

Figure 13: 16QAM 5MHz B.W.; 2687.5MHz, 15kHz

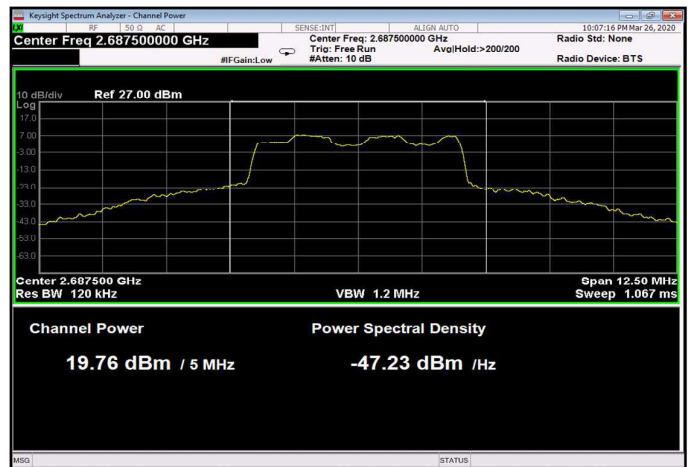

Figure 14: 16QAM 5MHz C.S; 2687.5MHz, 30kHz

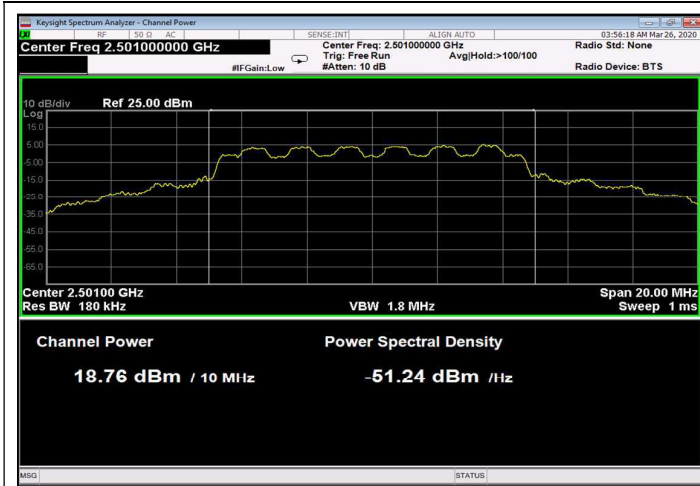

Figure 15: 16QAM 10MHz B.W.; 2501.0MHz, 15kHz

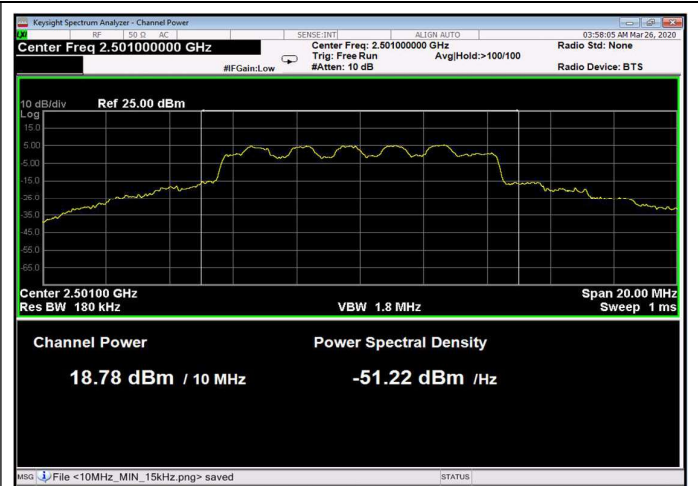

Figure 16: 16QAM 10MHz B.W.; 2501.0MHz, 30kHz

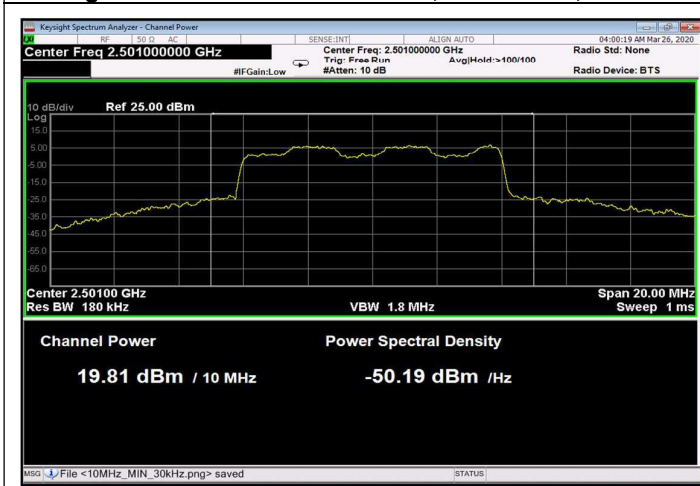

Figure 17: 16QAM 10MHz B.W.; 2501.0MHz, 60kHz

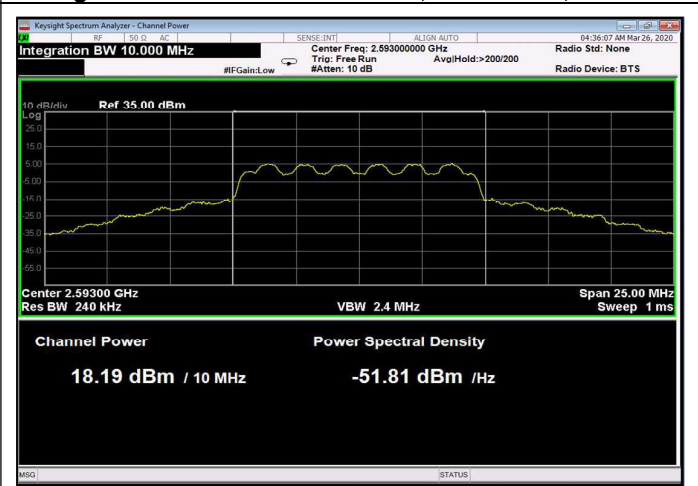

Figure 18: 16QAM 10MHz B.W.; 2593.0MHz, 15kHz

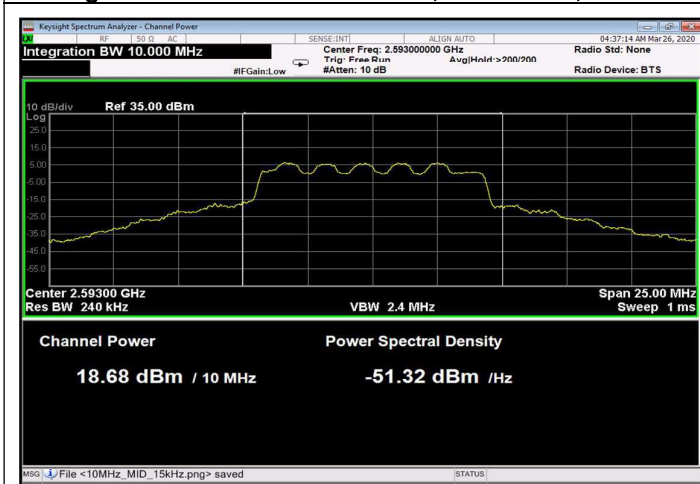

Figure 19: 16QAM 10MHz B.W.; 2593.0MHz, 30kHz

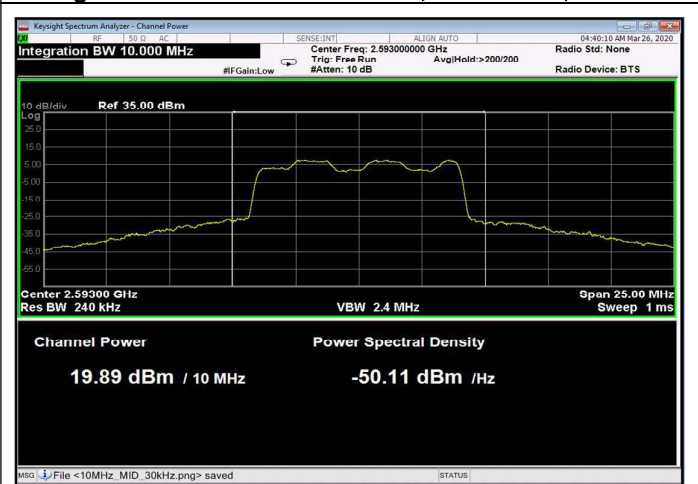

Figure 20: 16QAM 10MHz B.W.; 2593.0MHz, 60kHz

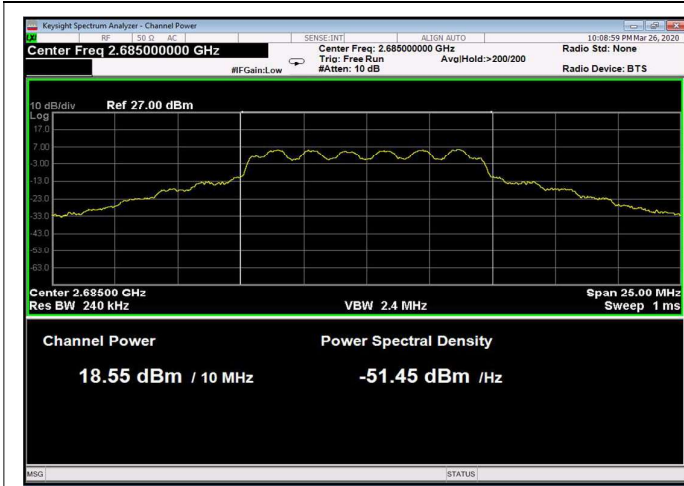

Figure 21: 16QAM 10MHz B.W.; 2685.0MHz, 15kHz

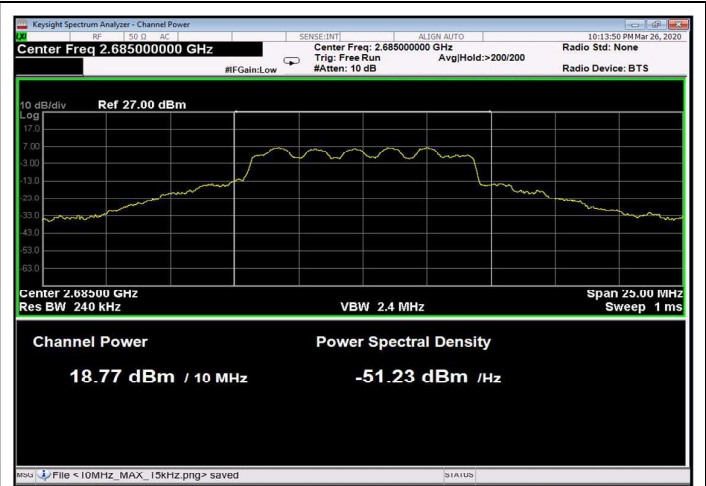

Figure 22: 16QAM 10MHz C.S; 2685.0MHz, 30kHz

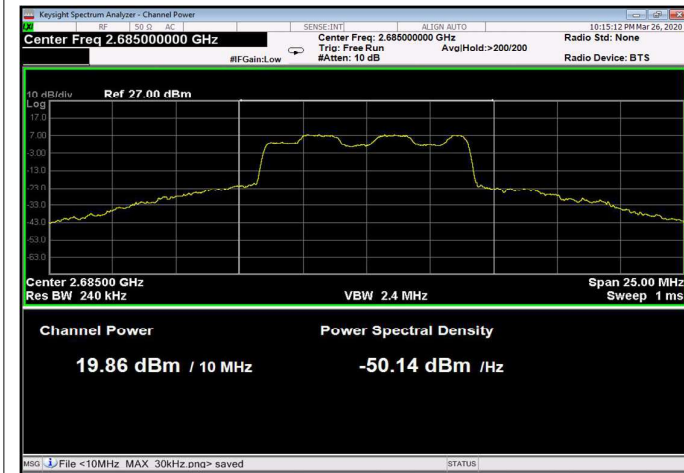

Figure 23: 16QAM 10MHz B.W.; 2685.0MHz, 60kHz

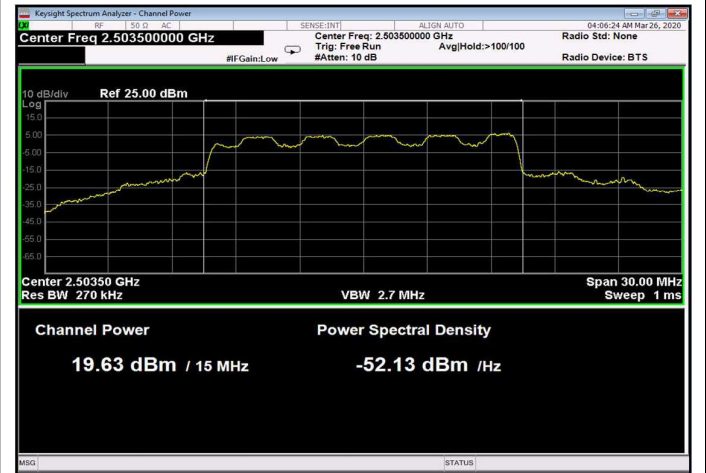

Figure 24: 16QAM 15MHz B.W.; 2503.5MHz, 15kHz

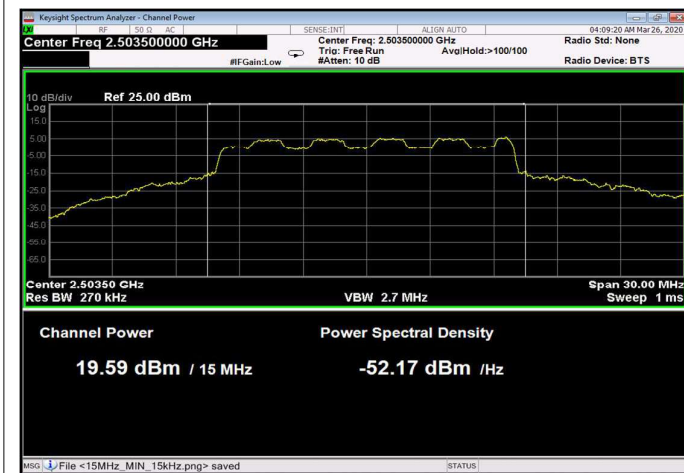

Figure 25: 16QAM 15MHz B.W.; 2503.5MHz, 30kHz

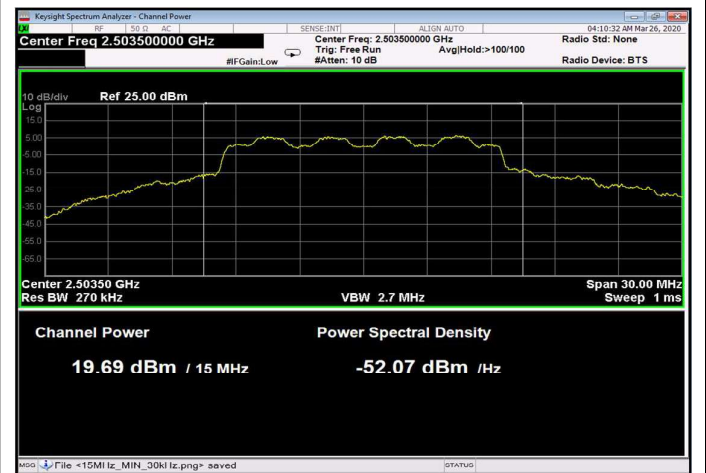

Figure 26: 16QAM 15MHz C.S; 2503.5MHz, 60kHz

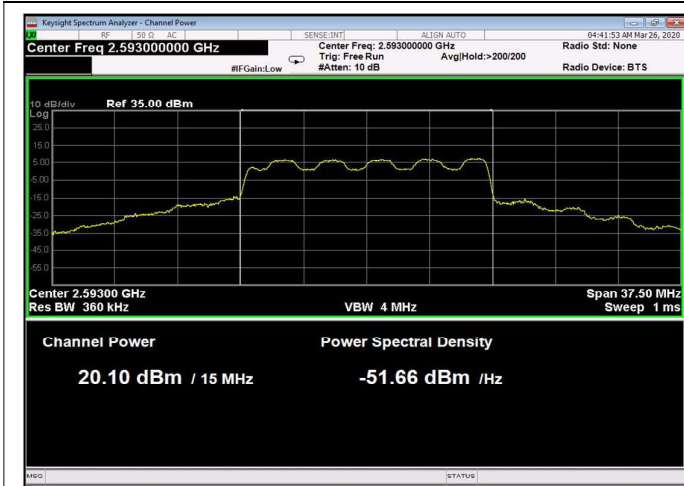

Figure 27: 16QAM 15MHz B.W.; 2593.0MHz, 15kHz

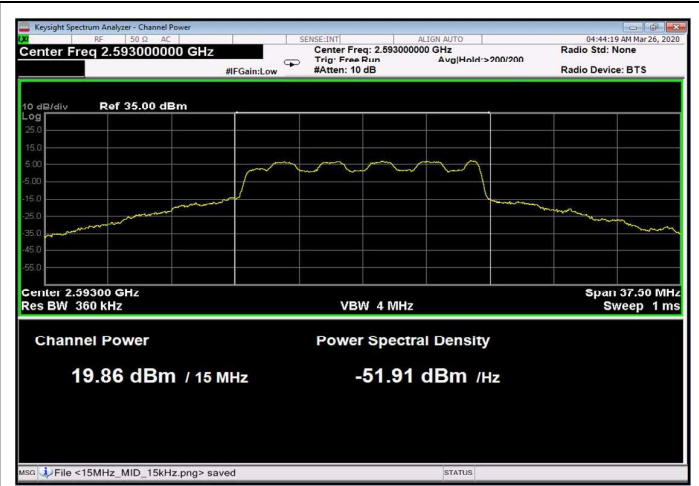

Figure 28: 16QAM 15MHz B.W.; 2593.0MHz, 30 kHz

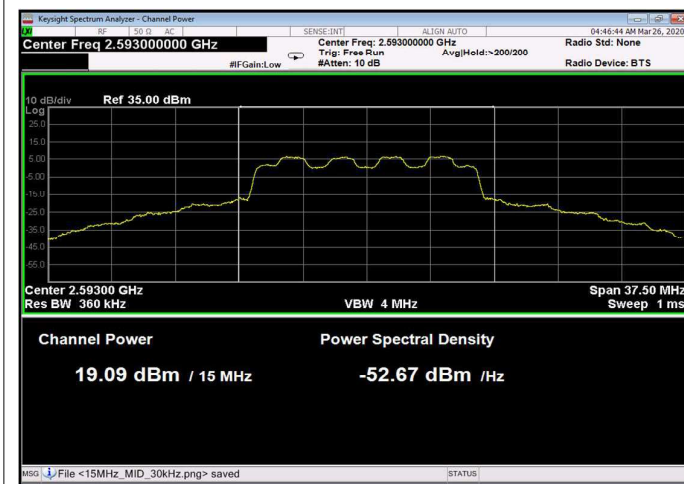

Figure 29: 16QAM 15MHz B.W.; 2593.0MHz, 60kHz

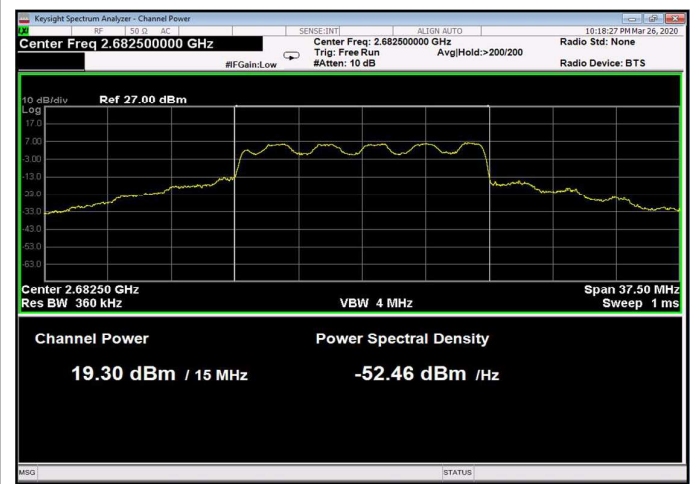

Figure 30: 16QAM 15MHz B.W.; 2682.5MHz, 15kHz

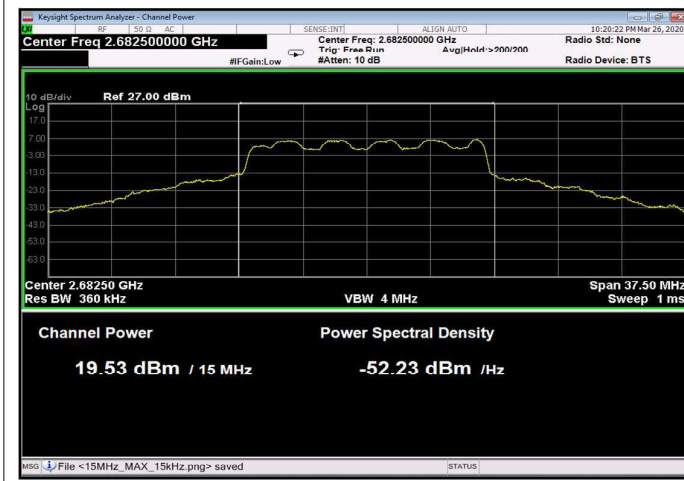

Figure 31: 16QAM 15MHz B.W.; 2682.5MHz, 30kHz



Figure 32: 16QAM 15MHz B.W.; 2682.5MHz, 60kHz

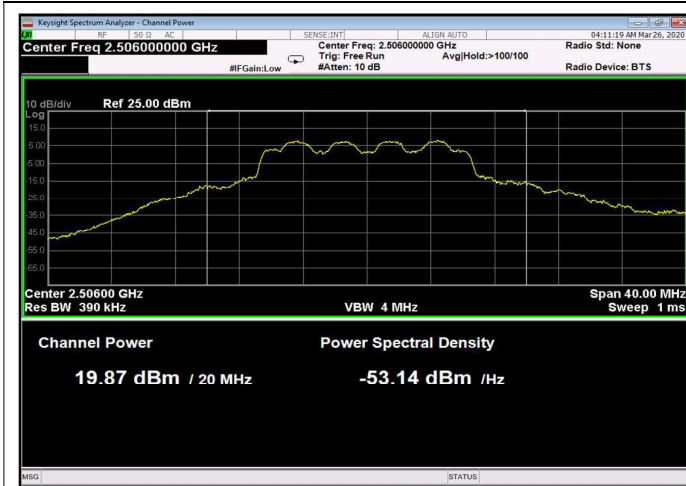

Figure 33: 16QAM 20MHz B.W.; 2506.0MHz, 15 kHz

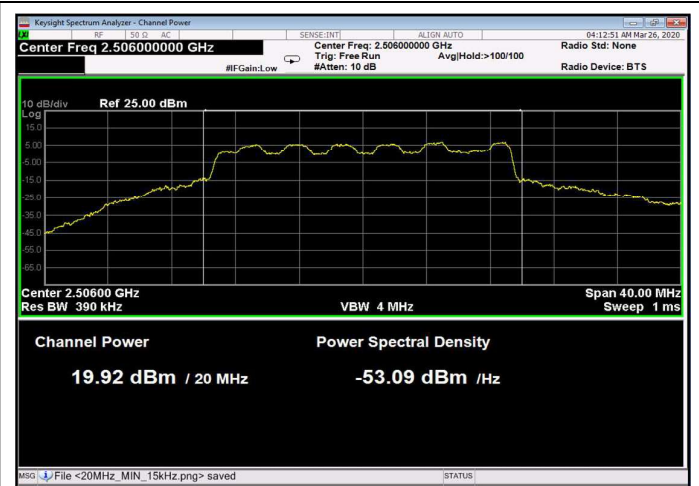

Figure 34: 16QAM 20MHz B.W.; 2506.0MHz, 30kHz

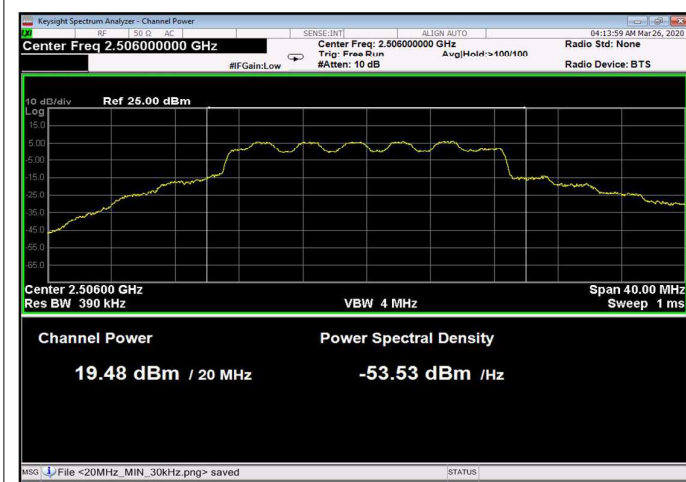

Figure 35: 16QAM 20MHz B.W.; 2506.0MHz, 60kHz

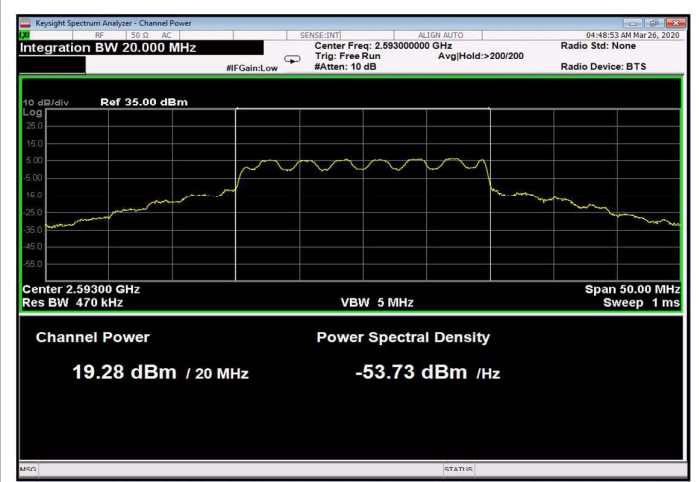

Figure 36: 16QAM 20MHz B.W.; 2593.0MHz, 15kHz

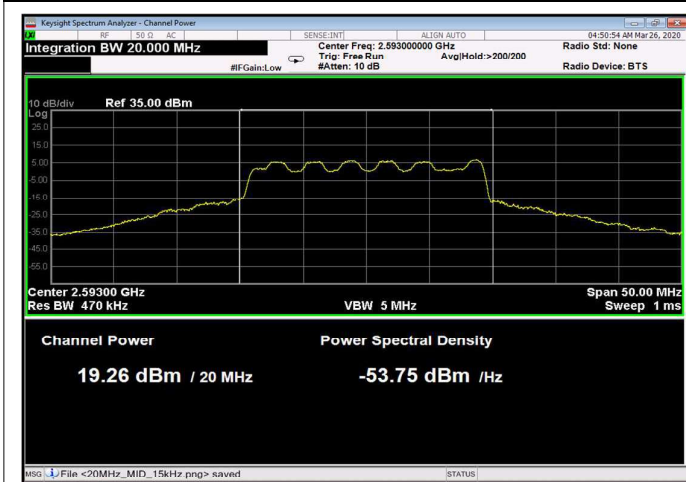

Figure 37: 16QAM 20MHz B.W.; 2593.0MHz, 30kHz

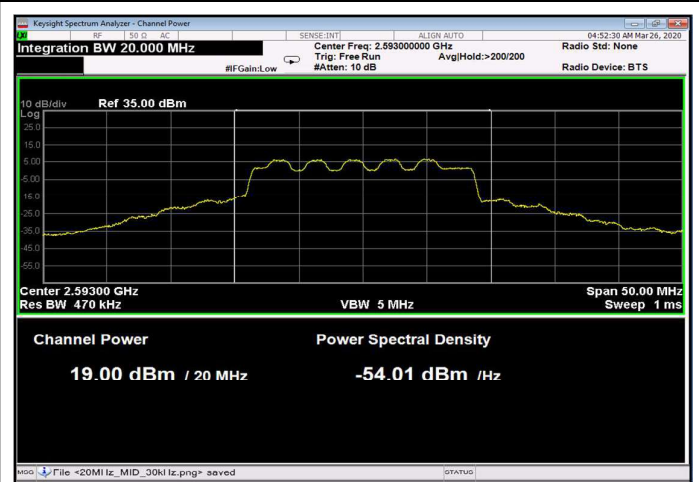

Figure 38: 16QAM 20MHz B.W.; 2593.0MHz, 60kHz

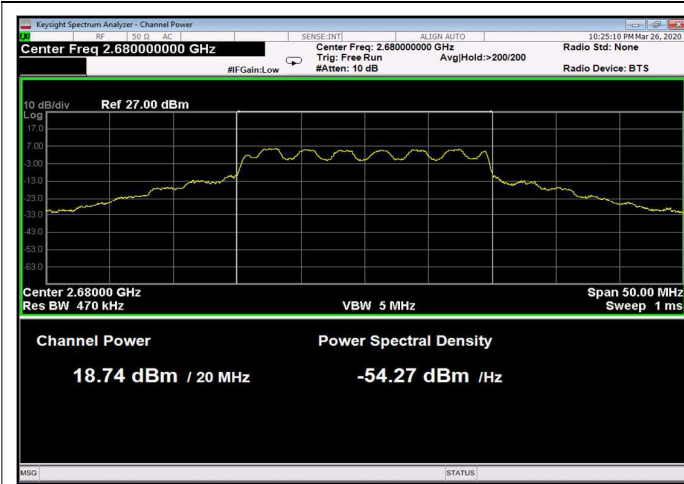

Figure 39: 16QAM 20MHz B.W.; 2680.0MHz, 15kHz

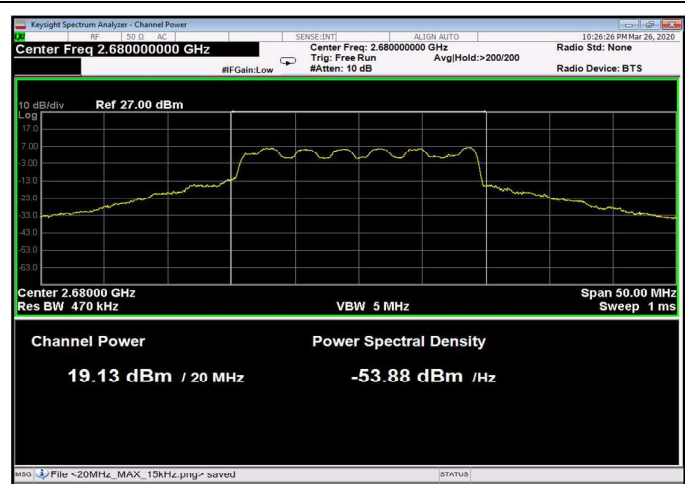

Figure 40: 16QAM 20MHz B.W.; 2680.0MHz, 30kHz

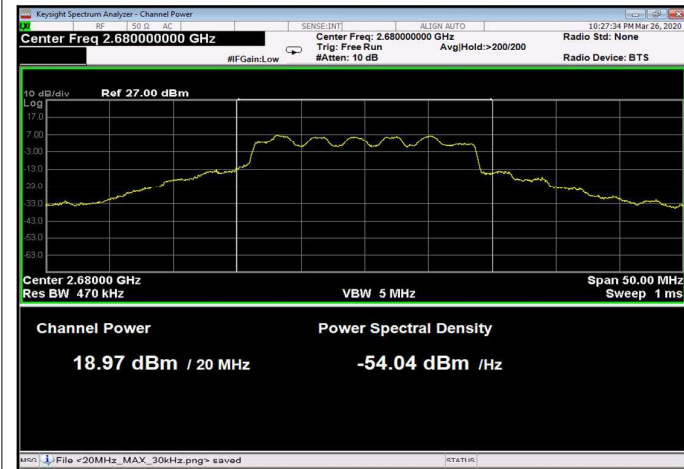

Figure 41: 16QAM 20MHz B.W.; 2680.0MHz, 60kHz

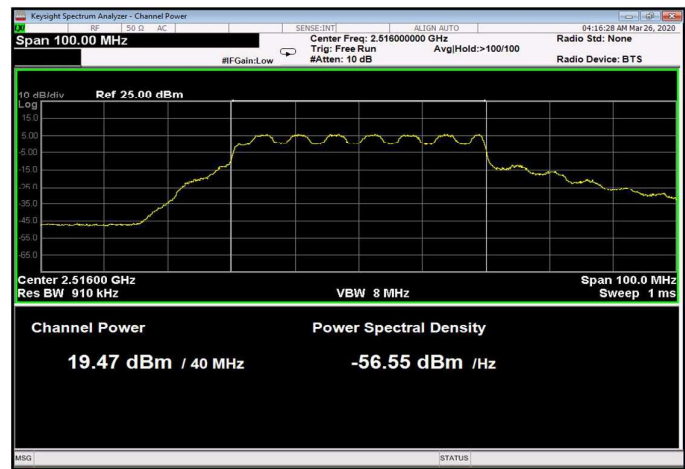

Figure 42: 16QAM 40MHz B.W.; 2516.0MHz, 15kHz

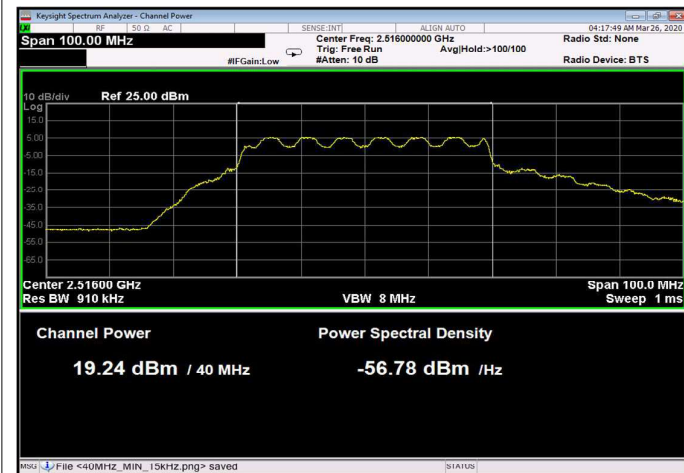

Figure 43: 16QAM 40MHz B.W.; 2516.0MHz, 30kHz

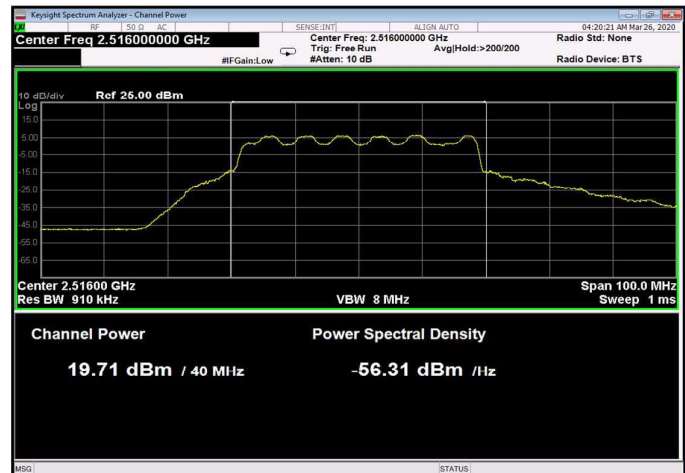

Figure 44: 16QAM 40MHz B.W.; 2516.0MHz, 60kHz