



DATE: 11 February 2020

**I.T.L. (PRODUCT TESTING) LTD.
FCC Radio Test Report**

For

**Corning Optical Communication Wireless
Equipment under test:**

Remote eXpansion Unit

RxU67

758-769MHz

First Responder Network Services

Tested by:



I. Kaganovich

Approved by:



D. Shidlowsky

This report must not be reproduced, except in full, without the written permission of I.T.L. (Product Testing) Ltd.

This report relates only to items tested.



Measurement/Technical Report for Corning Optical Communication Wireless

Remote eXpansion Unit

RxU67

(758-769; 788-799 MHz First Responder NetworkNet)

FCC ID: OJF1RXU67

This report concerns: Original Grant: X
 Class II change:
 Class I change:

Equipment type: Part 20 Industrial Booster (CMRS)

Limits used: 47CFR Parts 2; 90

Measurement procedure used is KDB 935210 D05 v01r03 April 2019 and
ANSI IEEE C63.26-2015

Substitution Method used as in ANSI TIA-603-E-2016

Application for Certification
prepared by:
D. Shidlowsky
ITL (Product Testing) Ltd.
1 Bat Sheva St.
Lod 7120101
Israel
e-mail davids@iltglobal.org

Applicant for this device:
(different from "prepared by")
Isaac Nissan
Corning Optical Communication Wireless
8253 1st Street
Vienna, VA 22812
U.S.A.
Tel: +1-703 855-1773
e-mail: NissanI@corning.com



TABLE OF CONTENTS

1	GENERAL INFORMATION -----	5
1.1	Administrative Information	5
1.2	List of Accreditations	6
1.3	Product Description	7
1.4	Test Methodology	7
1.5	Test Facility	7
1.6	Measurement Uncertainty	7
2	SYSTEM TEST CONFIGURATION -----	8
2.1	Justification	8
2.2	EUT Exercise Software	8
2.3	Special Accessories	8
2.4	Equipment Modifications	8
2.5	Configuration of Tested System	9
3	TEST SET-UP PHOTOS -----	11
4	RF POWER OUTPUT -----	14
4.1	Test Specification	14
4.2	Test Procedure	14
4.3	Test Limit	14
4.4	Test Results	14
4.5	Test Equipment Used; RF Power Output	27
5	PEAK TO AVERAGE POWER RATIO -----	28
5.1	Test Procedure	28
5.2	Test Limit	28
5.3	Test Results	28
5.4	Test Equipment Used; 0.1% PAPR	35
6	OCCUPIED BANDWIDTH -----	36
6.1	Test Specification	36
6.2	Test Procedure	36
6.3	Test Limit	36
6.4	Test Results	36
6.5	Test Equipment Used; Occupied Bandwidth	61
7	SPURIOUS EMISSIONS AT ANTENNA TERMINALS -----	62
7.1	Test Specification	62
7.2	Test Procedure	62
7.3	Test Limit	62
7.4	Test Results	62
7.5	Test Equipment Used; Spurious Emissions at Antenna Terminals	87
8	SPURIOUS RADIATED EMISSION -----	88
8.1	Test Specification	88
8.2	Test Procedure	88
8.3	Test Limit	89
8.4	Test Results	89
8.5	Test Instrumentation Used; Radiated Measurements	90
9	SPURIOUS RADIATED EMISSION FOR 1559-1610 MHZ BAND -----	91
9.1	Test Specification	91
9.2	Test Procedure	91
9.3	Test Limit	91
9.4	Test Results	91
9.5	Test Instrumentation Used; Radiated Measurements	93



10	OUT-OF-BAND REJECTION	94
	1.1 Test Specification	94
	1.2 Test Procedure	94
	1.3 Test Limit	94
	1.4 Test Results.....	94
	10.1 Test Equipment Used; Out-of-Band Rejection	95
11	APPENDIX A - CORRECTION FACTORS	96
	11.1 Correction factors for RF OATS Cable 35m.....	96
	11.2 Correction factors for RF OATS Cable 10m.....	97
	11.3 Correction factors for Horn Antenna	98
	11.4 Correction factors for Horn Antenna	99
	11.5 Correction factors for Log Periodic Antenna	100
	11.6 Correction factors for Biconical Antenna.....	101
	11.7 Correction factors for ACTIVE LOOP ANTENNA	102



1 General Information

1.1 Administrative Information

Manufacturer:	Corning Optical Communication Wireless
Manufacturer's Address:	8253 1st Street Vienna, VA 22812 U.S.A. Tel: +1-703 855-1773
Manufacturer's Representative:	Isaac Nissan
Equipment Under Test (E.U.T):	Remote eXpansion Unit
Equipment Model No.:	RxU67
Equipment Serial No.:	Not Designated
Date of Receipt of E.U.T:	28.12.2020
Start of Test:	29.12.2020
End of Test:	29.01.2020
Test Laboratory Location:	I.T.L (Product Testing) Ltd. 1 Batsheva St, Lod, Israel 7116002
Test Specifications:	FCC Parts 2; 90



1.2 List of Accreditations

The EMC laboratory of I.T.L. is accredited by/registered with the following bodies:

1. The American Association for Laboratory Accreditation (A2LA) (U.S.A.), Certificate No. 1152.01.
2. The Federal Communications Commission (FCC) (U.S.A.), FCC Designation Number is IL1005.
3. The Israel Ministry of the Environment (Israel), Registration No. 1104/01.
4. The Voluntary Control Council for Interference by Information Technology Equipment (VCCI) (Japan), Registration Numbers: C-20025, R-2729, T-20028, G-20068.
5. Department of Innovation, Science and Economic Development (ISED) Canada, CAB identifier: IL1002.

I.T.L. Product Testing Ltd. is accredited by the American Association for Laboratory Accreditation (A2LA) and the results shown in this test report have been determined in accordance with I.T.L.'s terms of accreditation unless stated otherwise in the report.



1.3 Product Description

Remote Expansion Unit RxU67 is an add-on module that expands the service distribution at remote locations to include 600MHz and 700MHz FirstNet bands.

RxU67 is part of the Corning optical network evolution (ONE™) solutions. It is designed to plug-into the remote access unit (RAU5x), expanding the five services supported by the RAU5x to include 600MHz and 700MHz FirstNet bands.

All seven services are distributed over the same infrastructure: routed to the RAU5x over a single optic fibre, distributed over the same footprint and managed as a single element – as the RAU5x.

1.4 Test Methodology

Both conducted and radiated testing were performed according to the procedures in KDB 935210 D05 v01r03 April 2019 and ANSI/TIA-603-E-2016. Radiated testing was performed at an antenna to EUT distance of 3 meters.

1.5 Test Facility

Both conducted and radiated emissions tests were performed at I.T.L.'s testing facility in Lod, Israel. I.T.L.'s EMC Laboratory is accredited by A2LA, certificate No. 1152.01 and its FCC Designation Number is IL1005.

1.6 Measurement Uncertainty

Conducted Emission (CISPR 11, EN 55011, CISPR 32, EN 55032, ANSI C63.4)

0.15 – 30 MHz:

Expanded Uncertainty (95% Confidence, K=2):

± 3.44 dB

Radiated Emission (CISPR 11, EN 55011, CISPR 32, EN 55032, ANSI C63.4)
for open site 30-1000MHz:

Expanded Uncertainty (95% Confidence, K=2):

± 4.98 dB

2 System Test Configuration

2.1 Justification

The E.U.T. has been fully tested receiving signals from the RAU5x.

The test setup was configured to closely resemble the standard installation.
All source signals are represented in the setup by appropriate signal generators.

An “Exercise” SW on the computer was used to enable / disable transmission of the RAU5x, while the EUT output was connected to the spectrum analyzer.
All channels transmitted during the testing.
There is neither an intermediate amplified nor donor antenna in the uplink.
All components included in the UL path are connected by cables.

2.2 EUT Exercise Software

HCM 3.6 build26-RC1

2.3 Special Accessories

No special accessories were needed in order to achieve compliance.

2.4 Equipment Modifications

No modifications were necessary in order to achieve compliance.

2.5 Configuration of Tested System

Product Name	Remote Expansion Unit
Model Name	RxU67
Working voltage	37-57 VDC
Mode of operation	Industrial Booster
Modulations	16QAM, 64QAM, 256QAM, QPSK
Frequency Range	600 (DL: 617-652, UL:663-698) FN700 (DL:758-768, UL: 788-798), LTE700 (DL:728-756, UL:698-716, 777-787)
Transmit power	15 dBm (Max) per band
Antenna Gain	Internal 0dBi; External Antenna 6dBi.
DATA rate	N/A
Modulation BW	5; 10; 15; 20

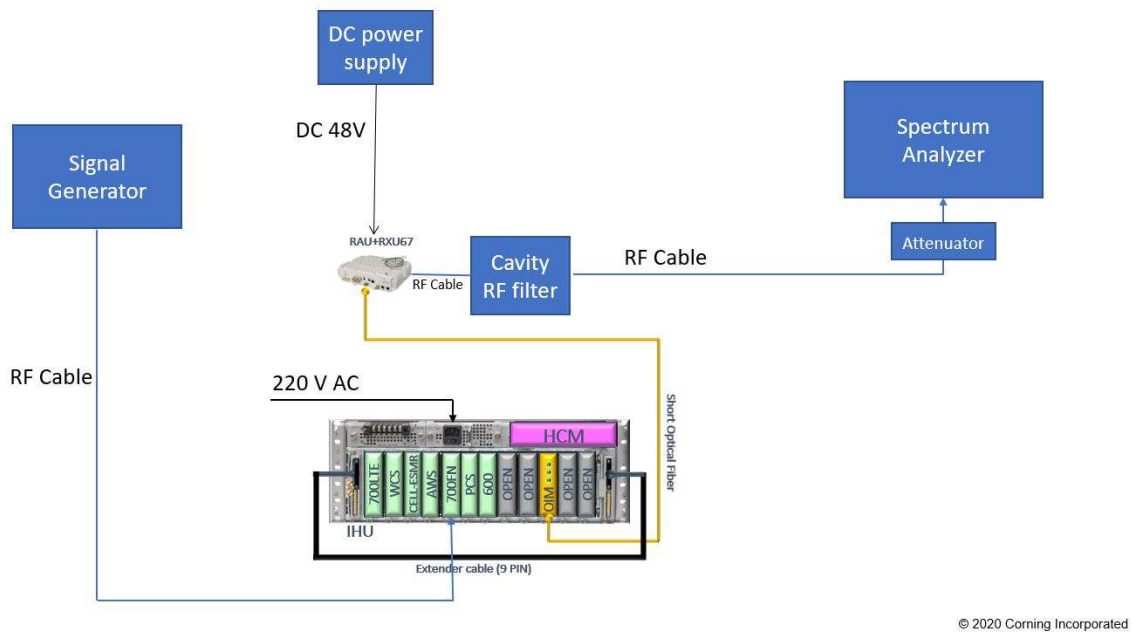

Figure 1. Conducted Test Set-Up

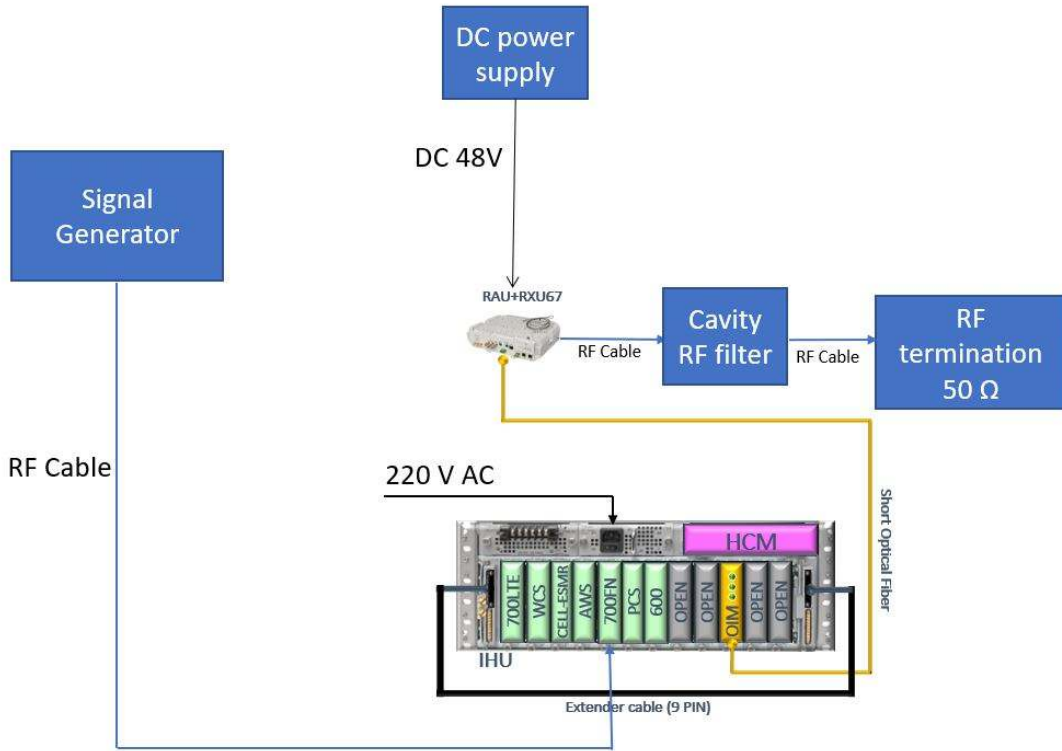

Figure 2. Radiated Test Set-Up Termination

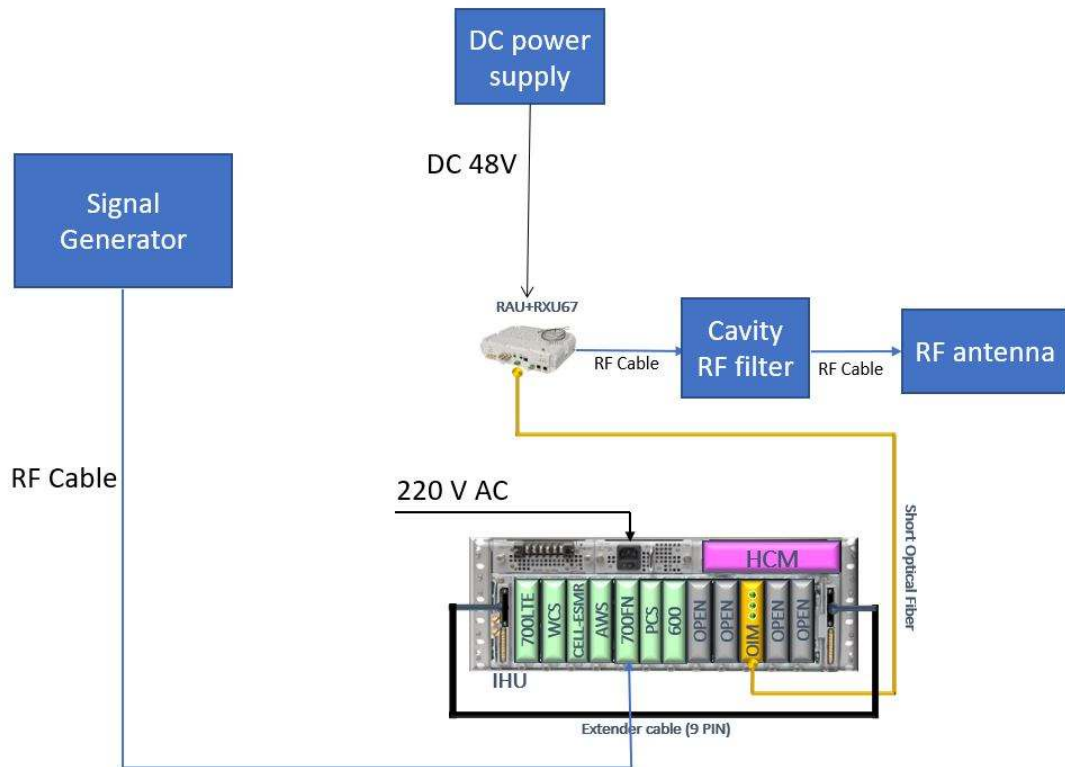

Figure 3. Radiated Test Set-Up Antenna

3 Test Set-Up Photos



Figure 4. Conducted Emission From Antenna Port Tests



Figure 5. Radiated Emission Test 9kHz - 30MHz

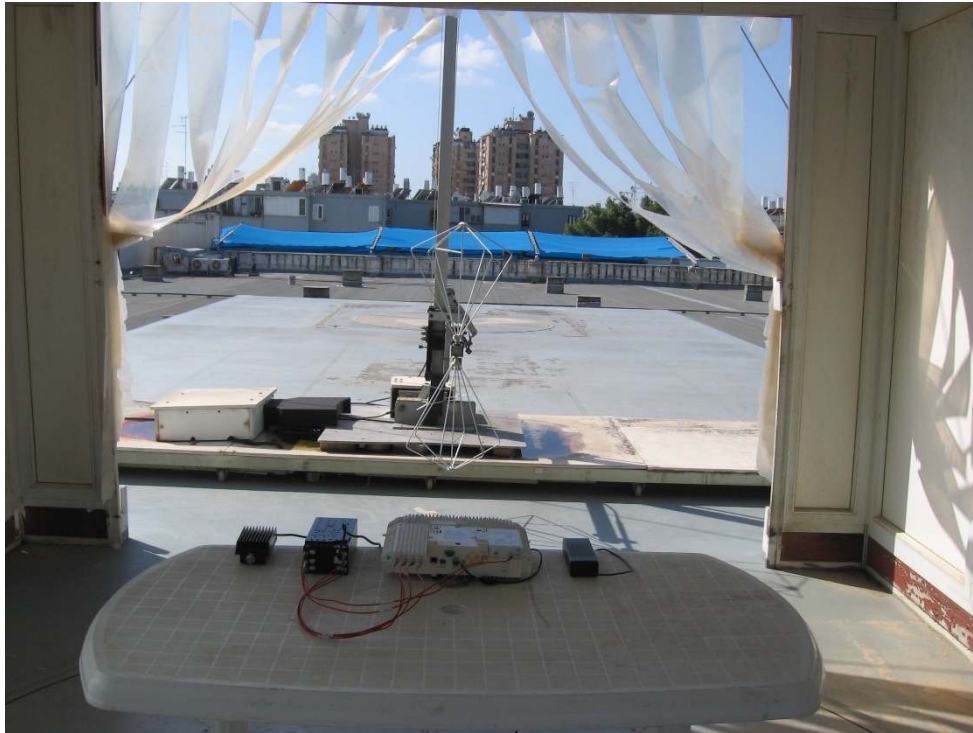

Figure 6. Radiated Emission Test 30 - 200 MHz

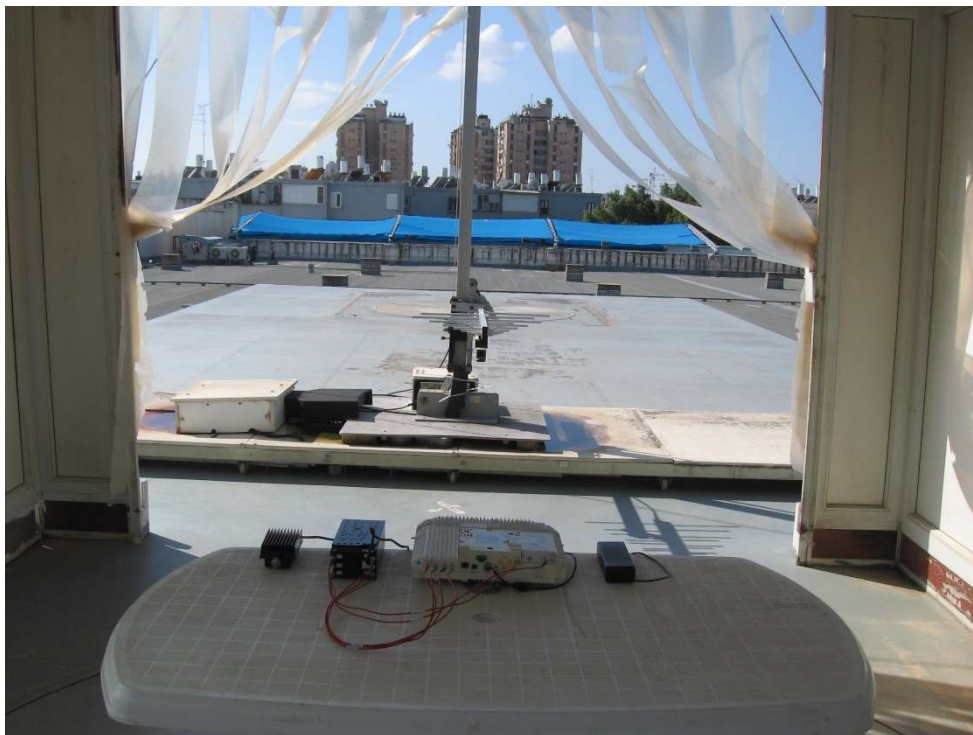

Figure 7. Radiated Emission Test 200 - 1000MHz



Figure 8. Radiated Emission Test 1.0 - 8.0GHz

4 RF Power Output

4.1 Test Specification

FCC Part 90, Subpart R (90.542(a)(3))

4.2 Test Procedure

(Temperature (22°C)/ Humidity (36%RH))

The E.U.T. antenna terminal was connected to the Spectrum Analyzer through an external attenuator (20.8 dB) and an appropriate coaxial cable. Special attention was taken to prevent Spectrum Analyzer RF input overload.

The Spectrum Analyzer was set to 91 kHz RBW for bandwidth 5 MHz and 180 kHz RBW for bandwidth 10 MHz for all modulations.

4.3 Test Limit

Peak Power Output must not exceed 1000W (60 dBm).

4.4 Test Results

JUDGEMENT: Passed

See additional information in Table 1 to Table 4 and Figure 9 to Figure 68.

Modulation	Bandwidth	Sub Carrier	Operation Frequency	Reading	Antenna Gain	EIRP	Limit	Margin
	(MHz)	(kHz)	(MHz)	(dBm)	(dBi)	(dBm)	(dBm)	(dB)
16QAM	5	15	760.5	15.72	6	21.72	60	-38.3
		30		15.80		21.80	60	-38.2
		15	763.5	15.66		21.66	60	-38.3
		30		15.40		21.40	60	-38.6
		15	766.5	15.90		21.90	60	-38.1
		30		15.50		21.50	60	-38.5
	10	15	763.0	15.34		21.34	60	-38.7
		30		15.56		21.56	60	-38.4
		60		15.65		21.65	60	-38.4
		15	763.5	15.59		21.59	60	-38.4
		30		15.45		21.45	60	-38.6
		60		15.55		21.55	60	-38.5
		15	764.0	15.57		21.57	60	-38.4
		30		15.41		21.41	60	-38.6
		60		15.63		21.63	60	-38.4

Table 1 RF Power Output 16QAM

Modulation	Bandwidth	Sub Carrier	Operation Frequency	Reading	Antenna Gain	EIRP	Limit	Margin
	(MHz)	(kHz)	(MHz)	(dBm)	(dBi)	(dBm)	(dBm)	(dB)
64QAM	5	15	760.5	15.40	6	21.40	60	-38.6
		30		15.48		21.48	60	-38.5
		15	763.5	15.54		21.54	60	-38.5
		30		15.59		21.59	60	-38.4
		15	766.5	15.48		21.48	60	-38.5
		30		15.47		21.47	60	-38.5
	10	15	763.0	15.63		21.63	60	-38.4
		30		15.49		21.49	60	-38.5
		60		15.56		21.56	60	-38.4
		15	763.5	15.49		21.49	60	-38.5
		30		15.40		21.40	60	-38.6
		60		15.45		21.45	60	-38.6
		15	764.0	15.58		21.58	60	-38.4
		30		15.69		21.69	60	-38.3
		60		15.37		21.37	60	-38.6

Table 2 RF Power Output 64QAM

Modulation	Bandwidth	Sub Carrier	Operation Frequency	Reading	Antenna Gain	EIRP	Limit	Margin
	(MHz)	(kHz)	(MHz)	(dBm)	(dBi)	(dBm)	(dBm)	(dB)
256QAM	5	15	760.5	15.26	6	21.26	60	-38.7
		30		15.36		21.36	60	-38.6
		15	763.5	15.43		21.43	60	-38.6
		30		15.20		21.20	60	-38.8
		15	766.5	15.54		21.54	60	-38.5
		30		15.42		21.42	60	-38.6
	10	15	763.0	15.39		21.39	60	-38.6
		30		15.49		21.49	60	-38.5
		60		15.55		21.55	60	-38.5
		15	763.5	15.26		21.26	60	-38.7
		30		15.71		21.71	60	-38.3
		60		15.47		21.47	60	-38.5
		15	764.0	15.61		21.61	60	-38.4
		30		15.61		21.61	60	-38.4
		60		15.58		21.58	60	-38.4

Table 3 RF Power Output 256QAM

Modulation	Bandwidth	Sub Carrier	Operation Frequency	Reading	Antenna Gain	EIRP	Limit	Margin
	(MHz)	(kHz)	(MHz)	(dBm)	(dBi)	(dBm)	(dBm)	(dB)
QPSK	5	15	760.5	15.48	6	21.48	60	-38.5
		30		15.43		21.43	60	-38.6
		15	763.5	15.75		21.75	60	-38.3
		30		15.58		21.58	60	-38.4
		15	766.5	15.62		21.62	60	-38.4
		30		15.68		21.68	60	-38.3
	10	15	763.0	15.54		21.54	60	-38.5
		30		15.66		21.66	60	-38.3
		60		15.52		21.52	60	-38.5
		15	763.5	15.40		21.40	60	-38.6
		30		15.72		21.72	60	-38.3
		60		15.62		21.62	60	-38.4
		15	764.0	15.60		21.60	60	-38.4
		30		15.67		21.67	60	-38.3
		60		15.31		21.31	60	-38.7

Table 4 RF Power Output QPSK

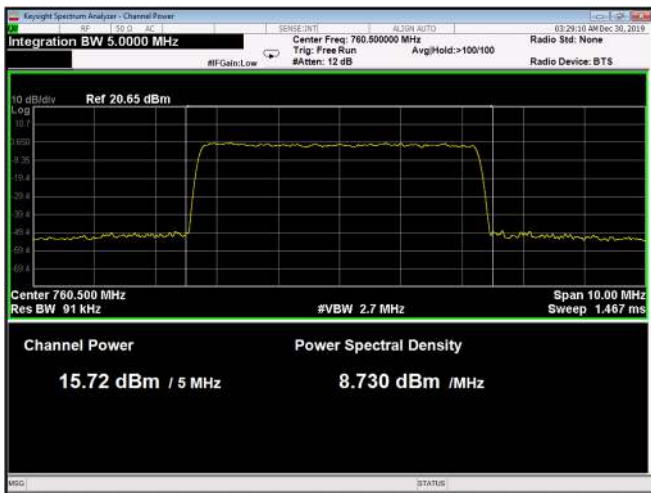

Figure 9: 16QAM 5MHz B.W.; 760.5MHz, 15kHz



Figure 10: 16QAM 5MHz B.W.; 760.5MHz, 30kHz

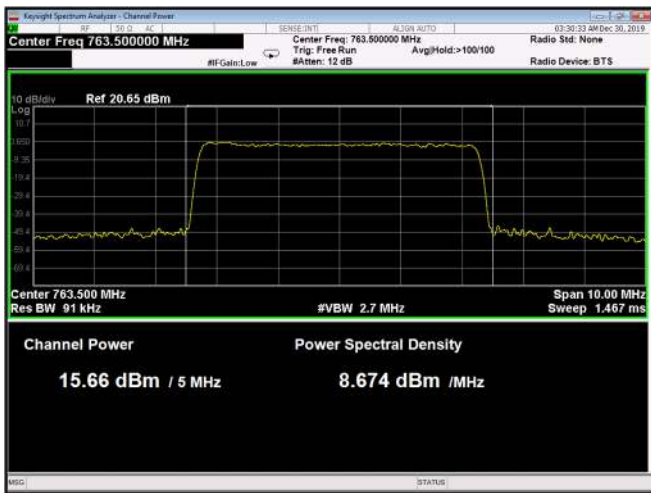

Figure 11: 16QAM 5MHz B.W.; 763.0MHz, 15kHz

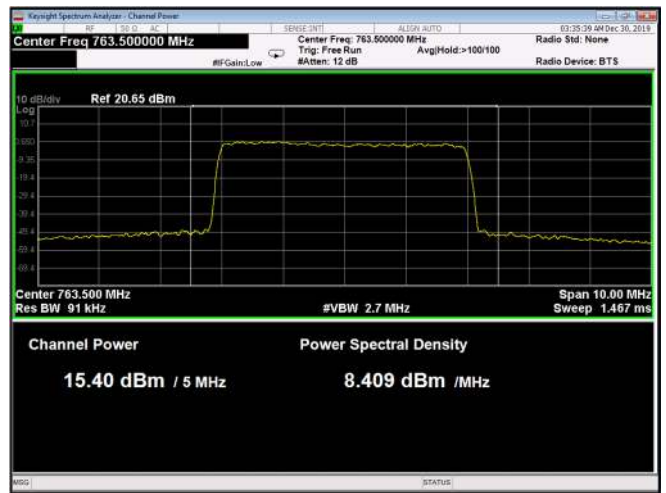

Figure 12: 16QAM 5MHz B.W.; 763.0MHz, 30kHz

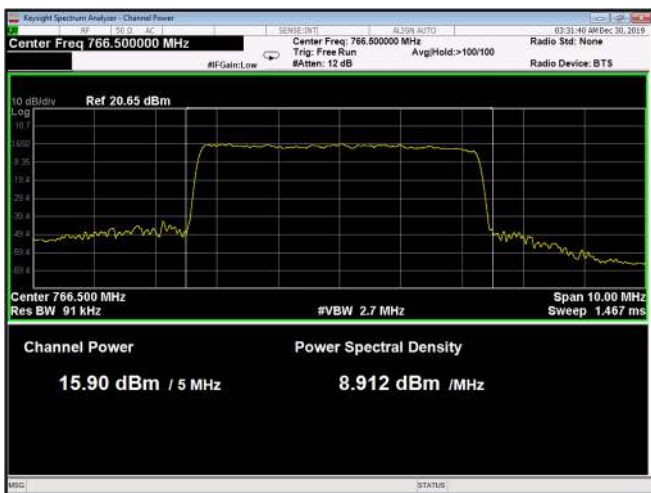

Figure 13: 16QAM 5MHz B.W.; 766.5MHz, 15kHz

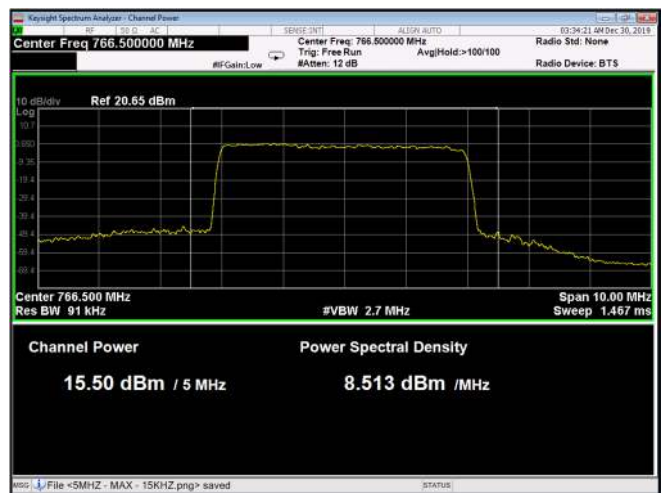

Figure 14: 16QAM 5MHz C.S.; 766.5MHz, 30kHz

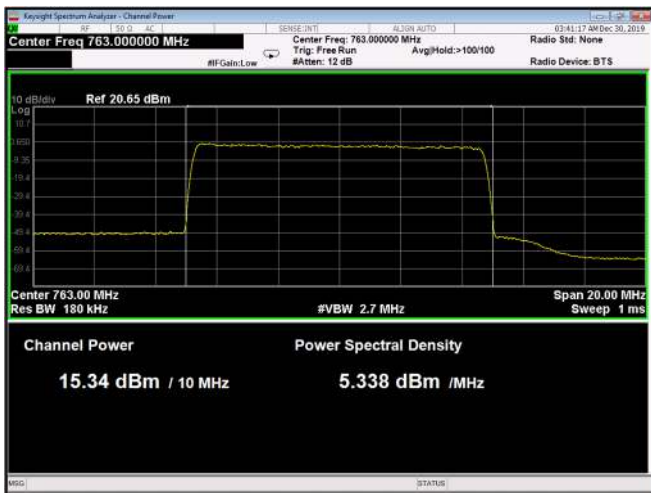

Figure 15: 16QAM 10MHz B.W.; 763.0MHz, 15kHz

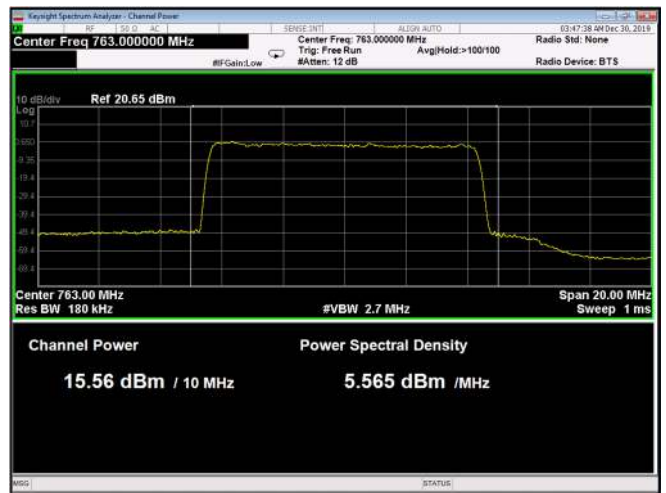

Figure 16: 16QAM 10MHz B.W.; 763.0MHz, 30kHz

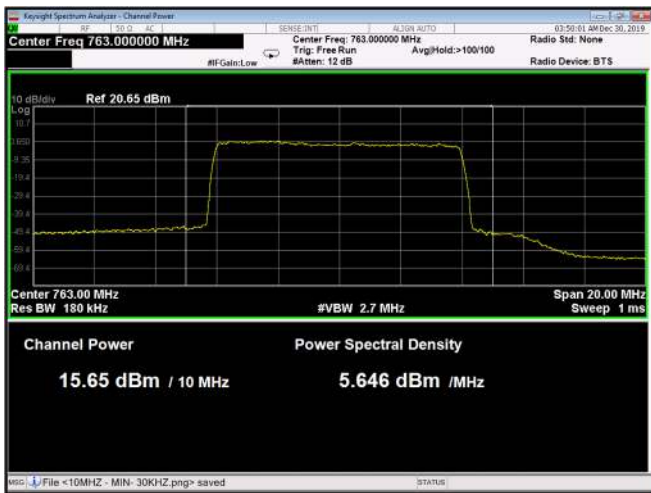

Figure 17: 16QAM 10MHz B.W.; 763.0 MHz, 60kHz

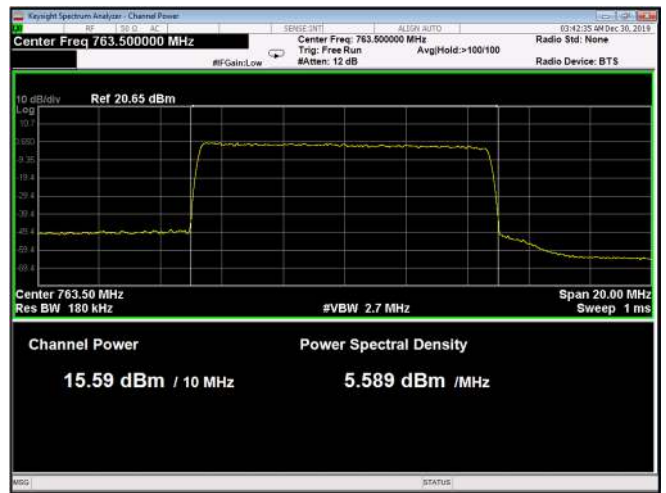

Figure 18: 16QAM 10MHz B.W.; 763.5MHz, 15kHz

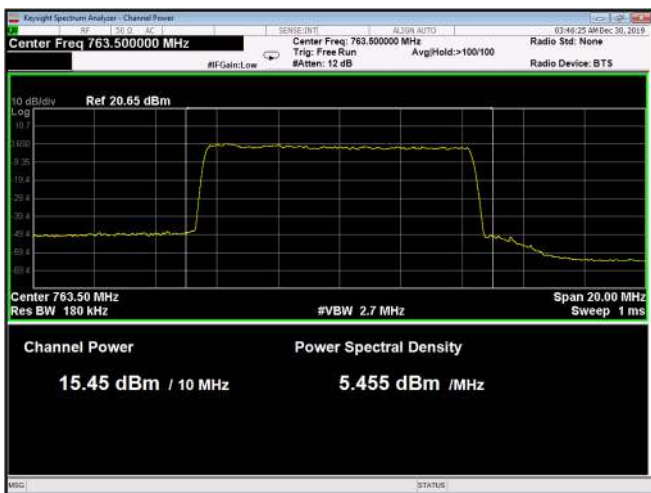

Figure 19: 16QAM 10MHz B.W.; 763.5MHz, 30kHz

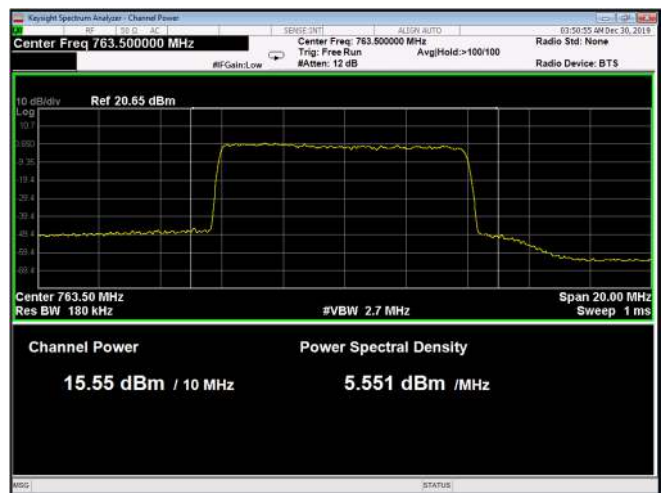

Figure 20: 16QAM 10MHz B.W.; 763.5MHz, 60kHz

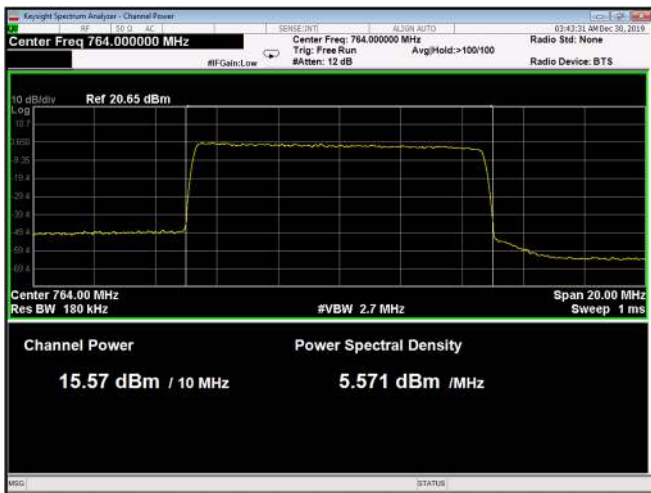

Figure 21: 16QAM 10MHz B.W.; 764.0MHz, 15kHz

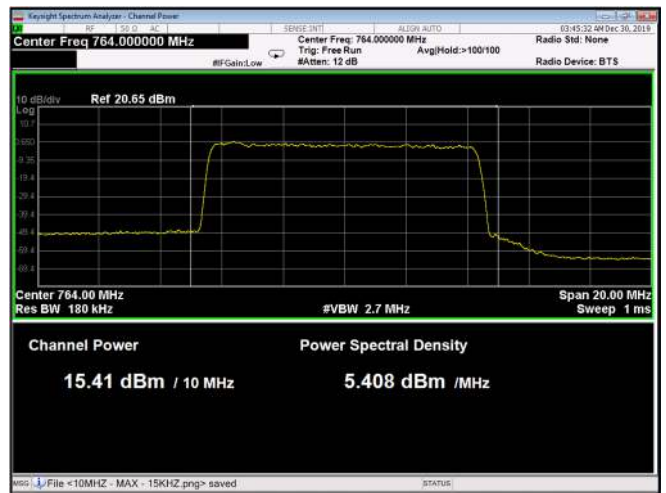

Figure 22: 16QAM 10MHz C.S; 764.0MHz, 30kHz

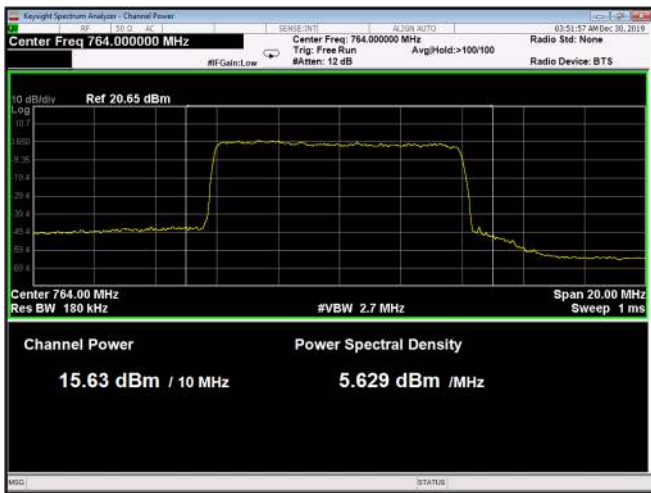

Figure 23: 16QAM 10MHz B.W.; 764.0MHz, 60kHz

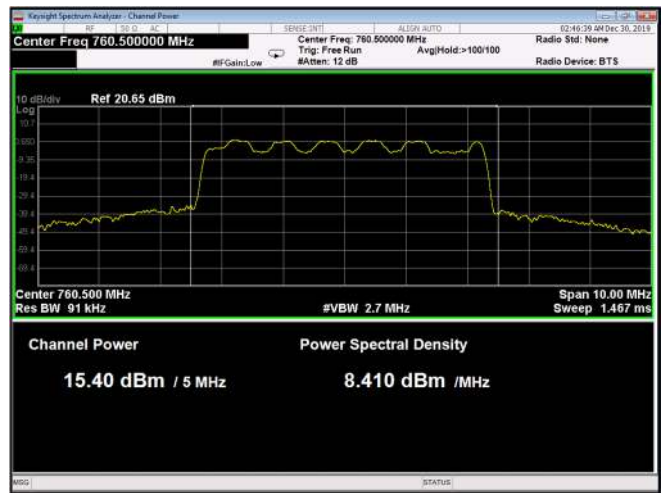

Figure 24: 64QAM 5MHz B.W.; 760.5MHz, 15kHz



Figure 25: 64QAM 5MHz B.W.; 760.5MHz, 30kHz

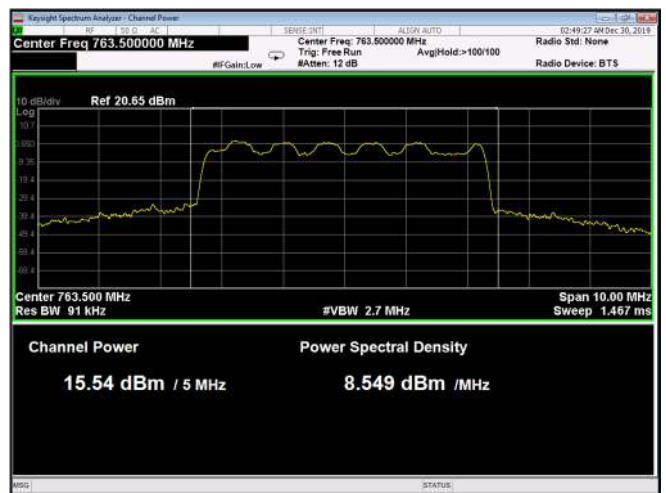

Figure 26: 64QAM 5MHz B.W.; 763.5MHz, 15kHz

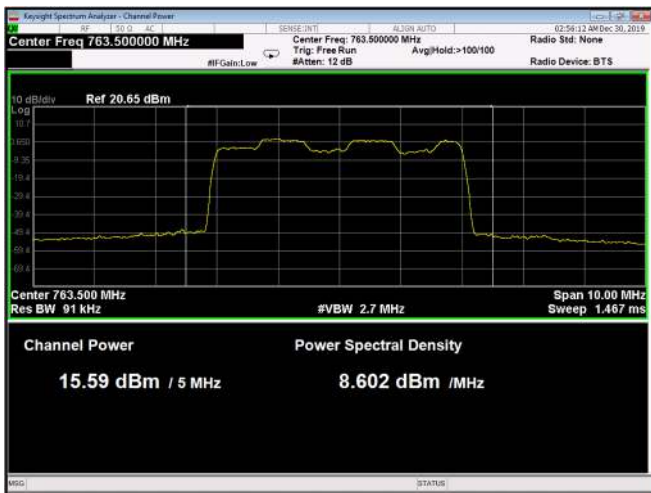

Figure 27: 64QAM 5MHz B.W.; 763.5MHz, 30kHz

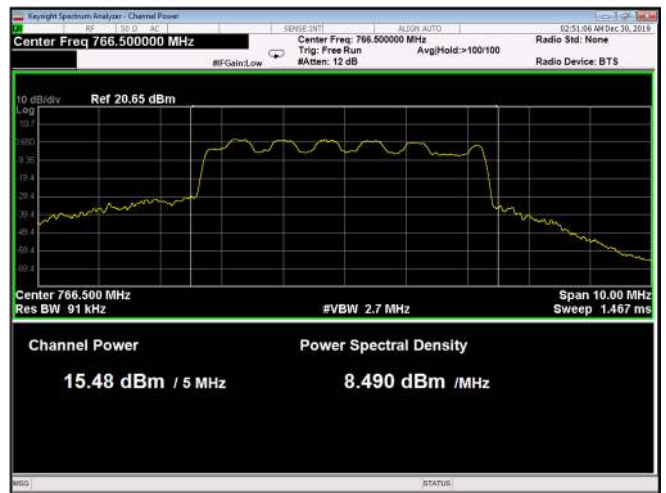

Figure 28: 64QAM 5MHz B.W.; 766.5MHz, 15kHz

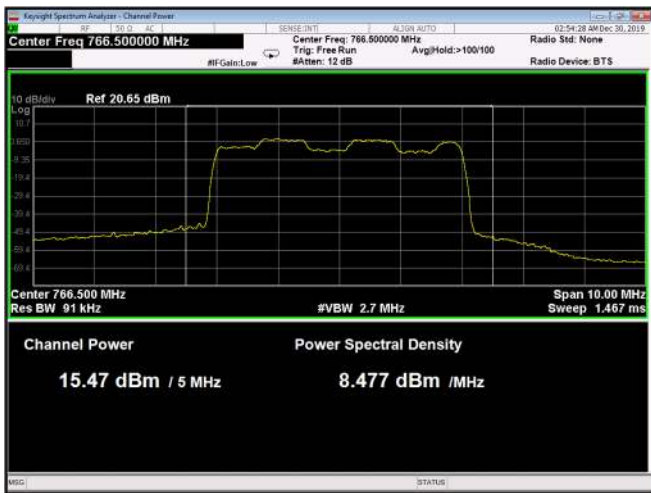

Figure 29: 64QAM 5MHz B.W.; 766.5MHz, 30kHz

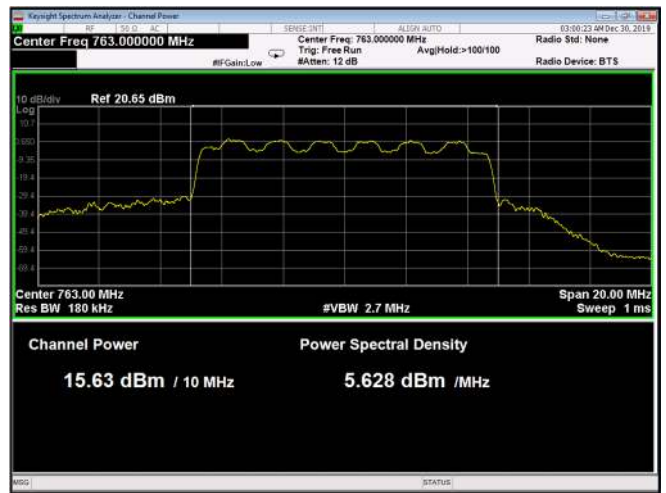

Figure 30: 64QAM 10MHz B.W.; 763.0MHz, 15kHz

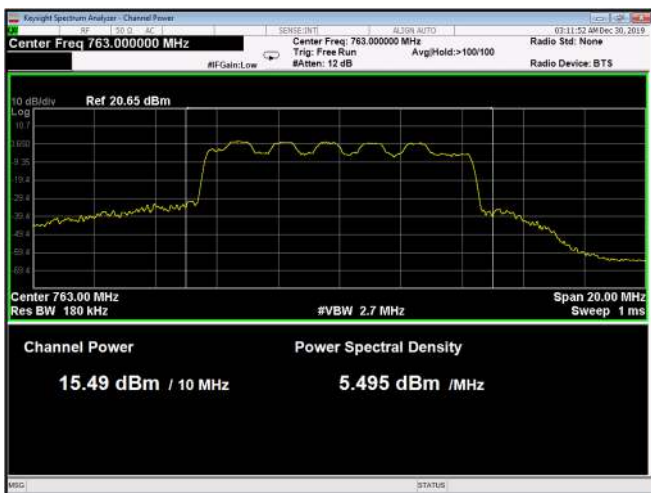

Figure 31: 64QAM 10MHz B.W.; 763.0MHz, 30kHz

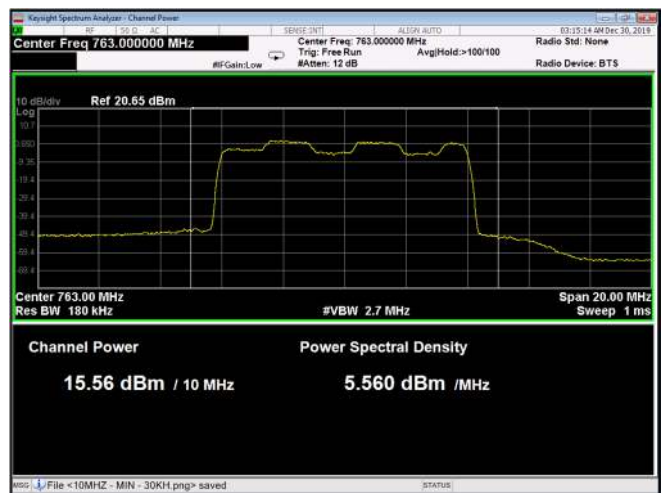

Figure 32: 64QAM 10MHz B.W.; 763.0MHz, 60kHz

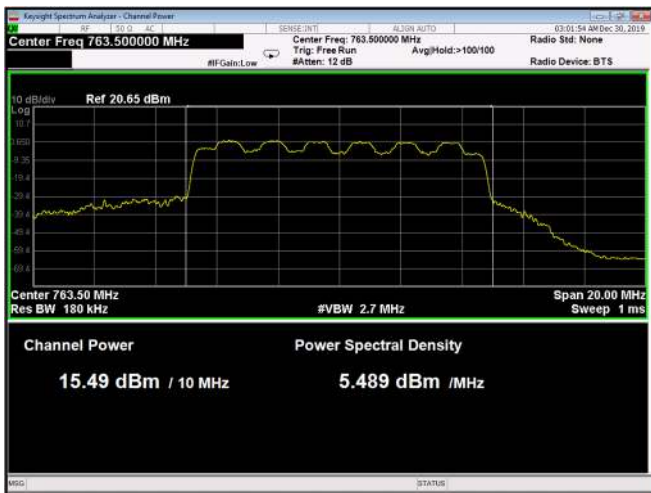

Figure 33: 64QAM 10MHz B.W.; 763.5MHz, 15kHz

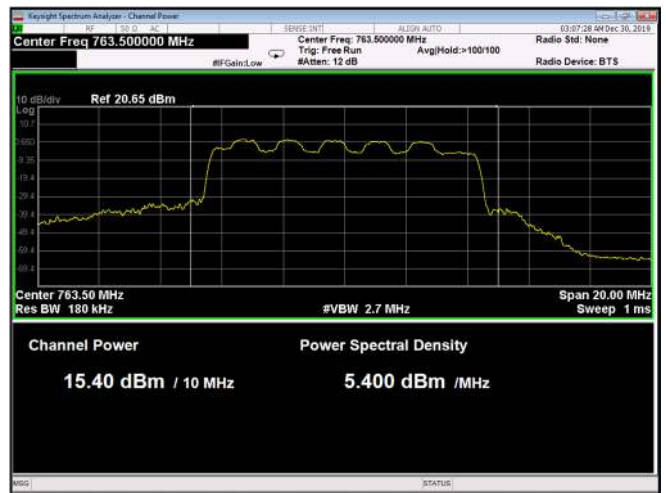

Figure 34: 64QAM 10MHz B.W.; 763.5MHz, 30kHz

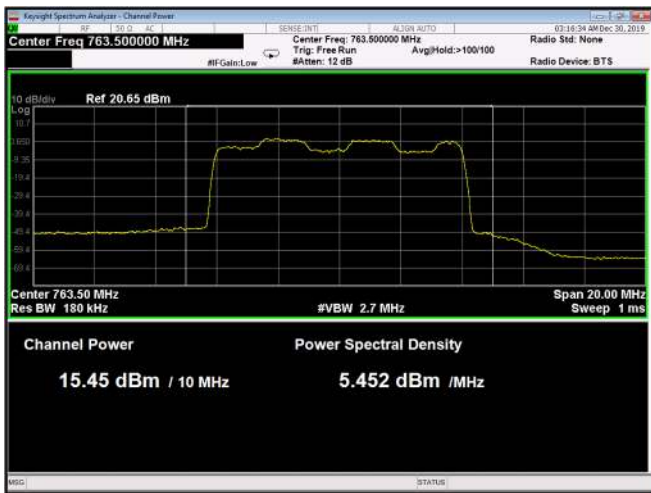

Figure 35: 64QAM 10MHz B.W.; 763.5MHz, 60kHz

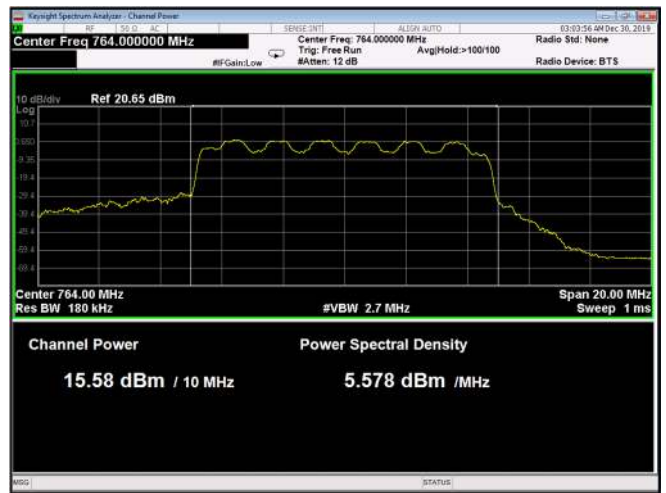

Figure 36: 64QAM 10MHz B.W.; 764.0MHz, 15kHz



Figure 37: 64QAM 10MHz B.W.; 764.0MHz, 30kHz

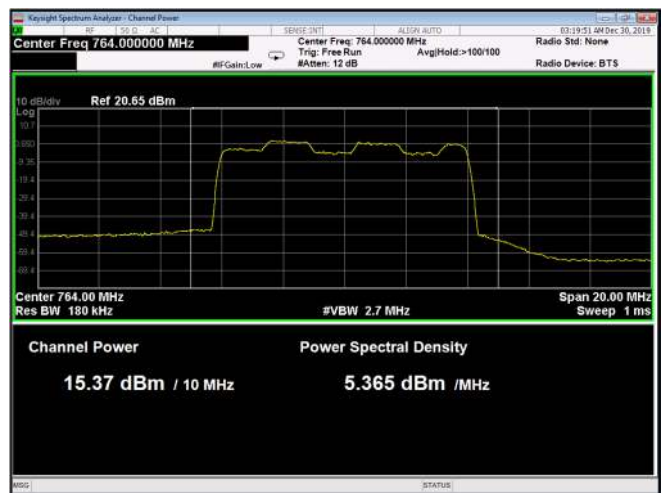

Figure 38: 64QAM 10MHz B.W.; 764.0 MHz, 60kHz

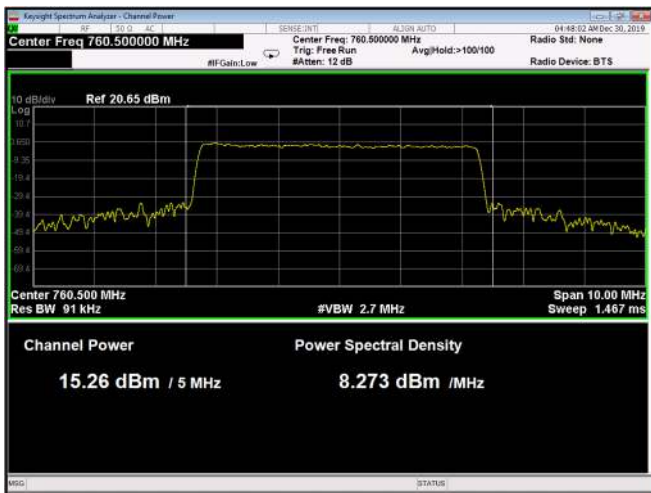

Figure 39: 256QAM 5MHz B.W.; 760.5MHz, 15kHz

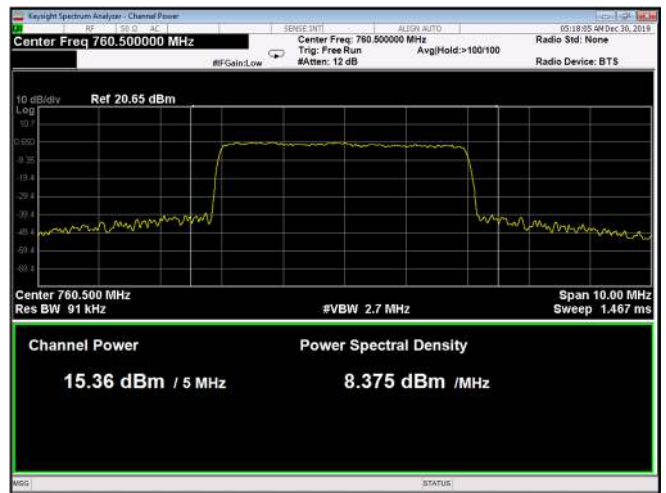

Figure 40: 256QAM 5MHz B.W.; 760.5MHz, 30kHz

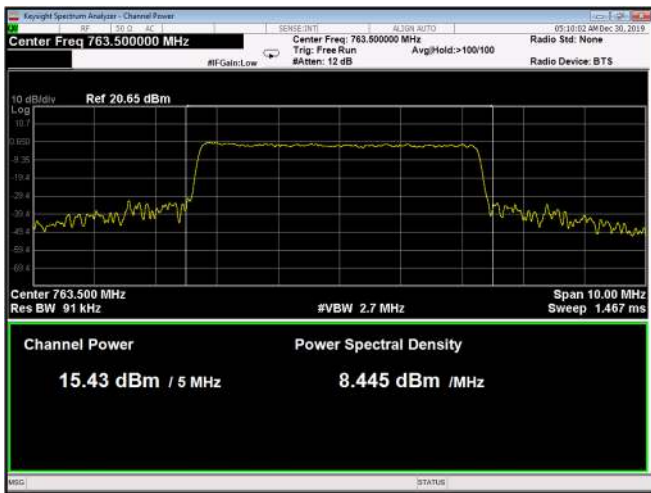

Figure 41: 256QAM 5MHz B.W.; 763.5MHz, 15kHz

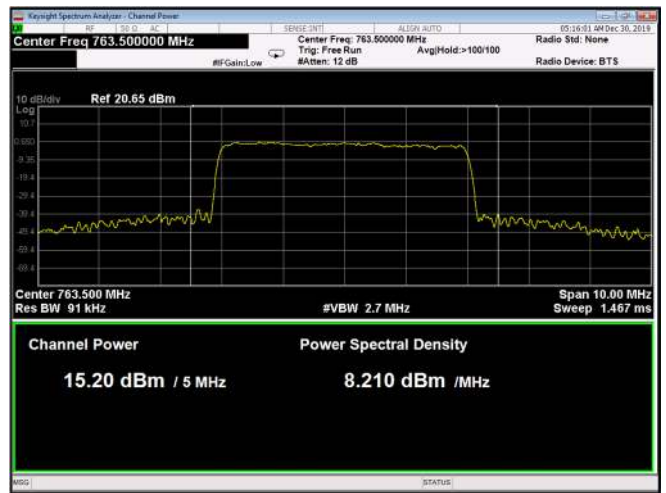

Figure 42: 256QAM 5MHz B.W.; 763.5MHz, 30kHz

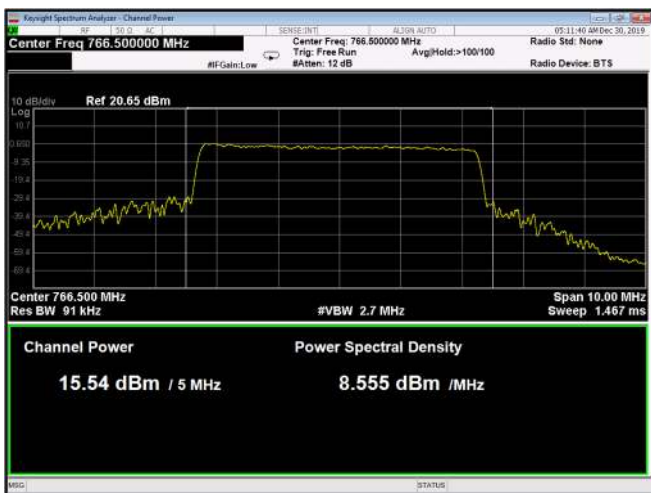

Figure 43: 256QAM 5MHz B.W.; 766.5MHz, 15kHz

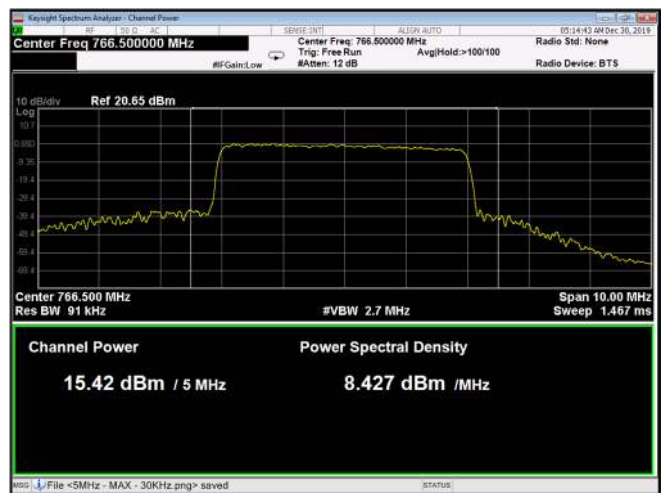

Figure 44: 256QAM 5MHz B.W.; 766.5MHz, 30kHz

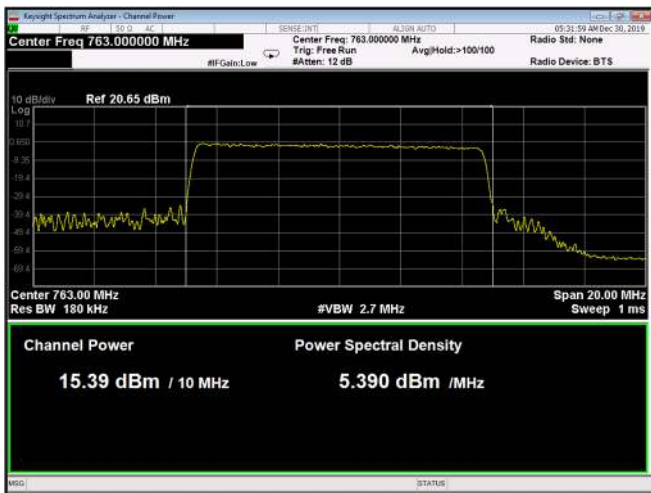

Figure 45: 256QAM 10MHz B.W.; 763.0MHz, 15kHz

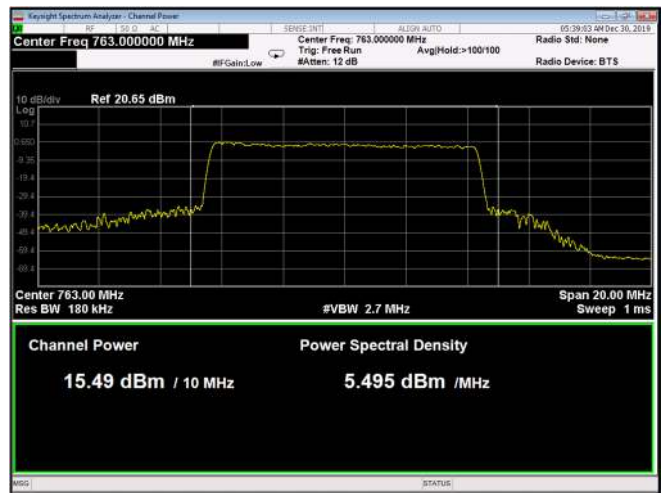

Figure 46: 256QAM 10MHz B.W.; 763.0MHz, 30kHz

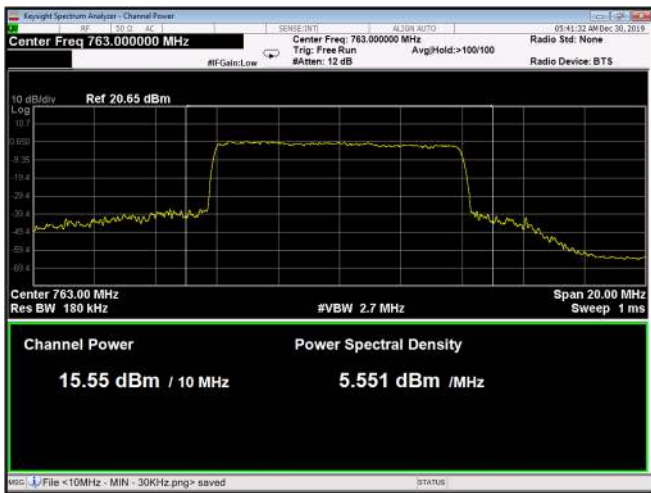

Figure 47: 256QAM 10MHz B.W.; 763.0MHz, 60kHz

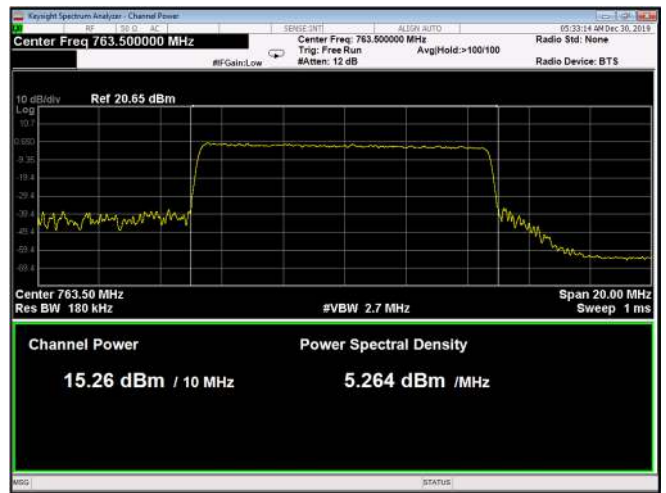

Figure 48: 256QAM 10MHz B.W.; 763.5MHz, 15kHz



Figure 49: 256QAM 10MHz B.W.; 763.5MHz, 30kHz

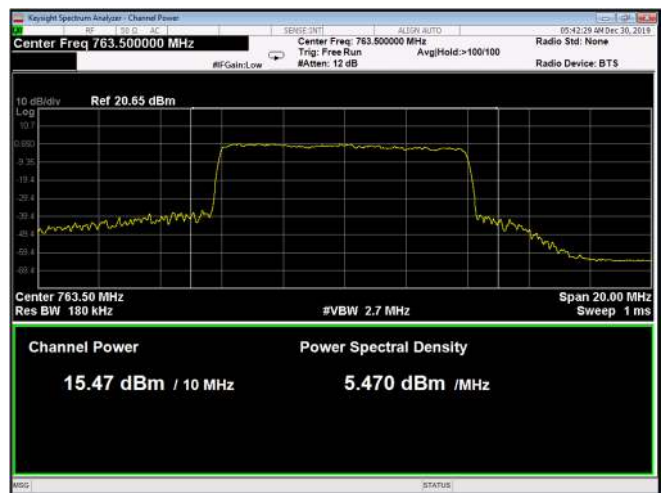

Figure 50: 256QAM 10MHz B.W.; 763.5MHz, 60kHz

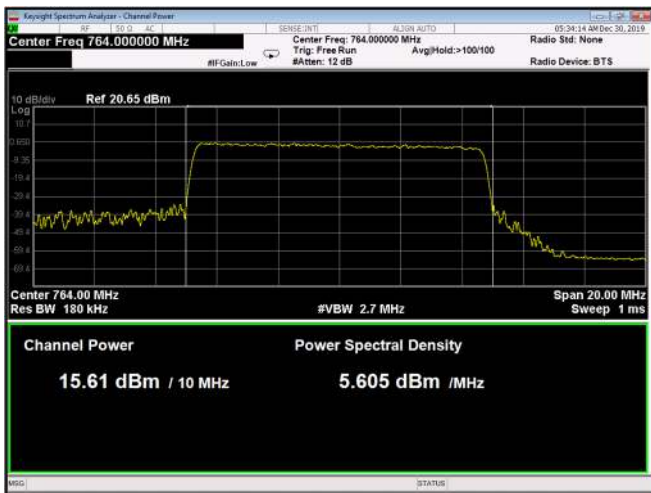

Figure 51: 256QAM 10MHz B.W.; 764.0MHz, 15kHz

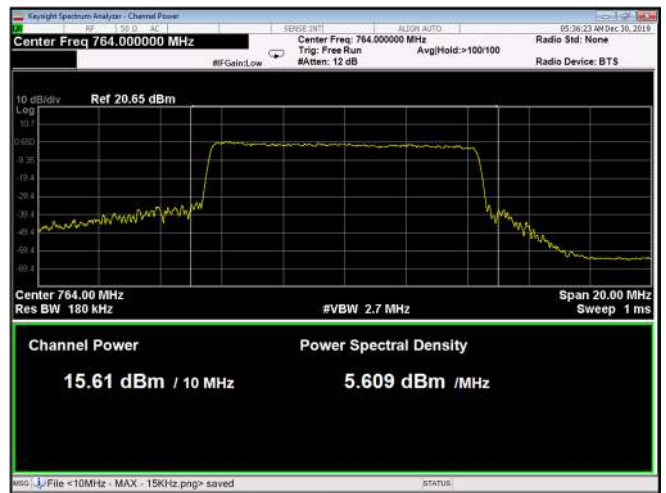

Figure 52: 256QAM 10MHz B.W.; 764.0MHz, 30kHz

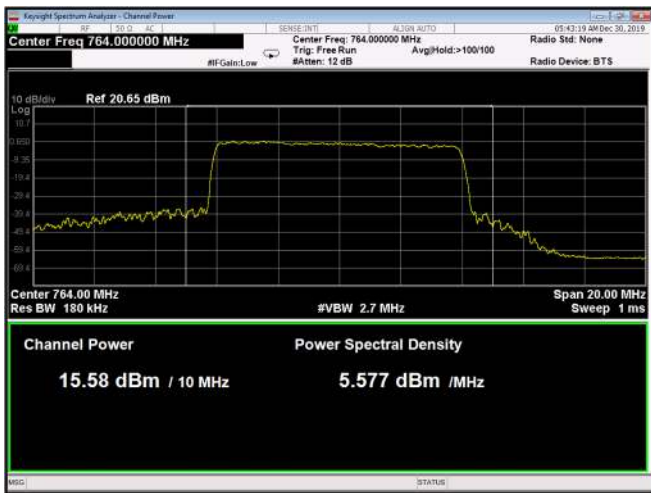

Figure 53: 256QAM 10MHz B.W.; 764.0MHz, 60kHz

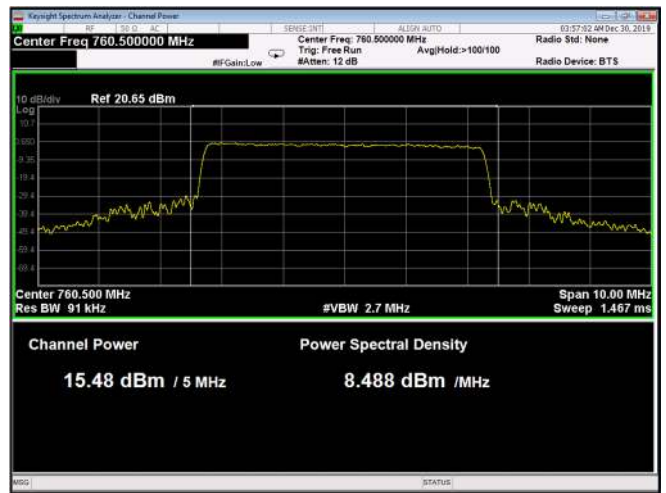

Figure 54: QPSK 5MHz B.W.; 760.5MHz, 15kHz

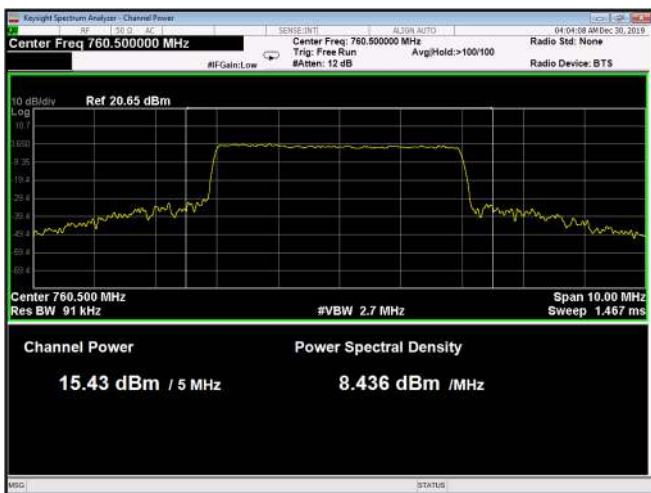

Figure 55: QPSK 5MHz B.W.; 760.5 MHz, 30kHz

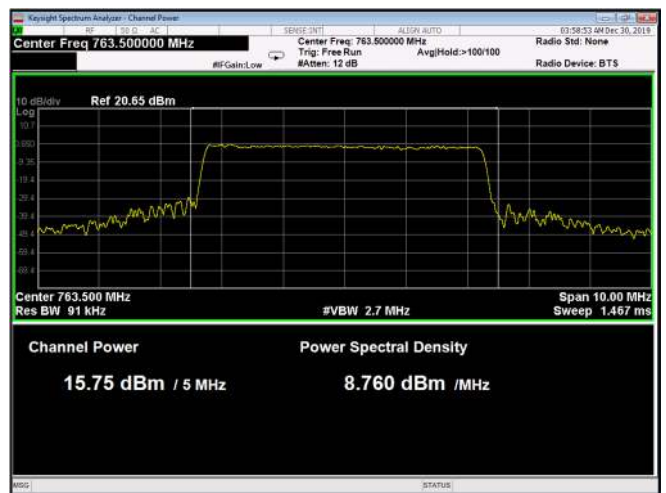

Figure 56: QPSK 5MHz B.W.; 763.5MHz, 15kHz

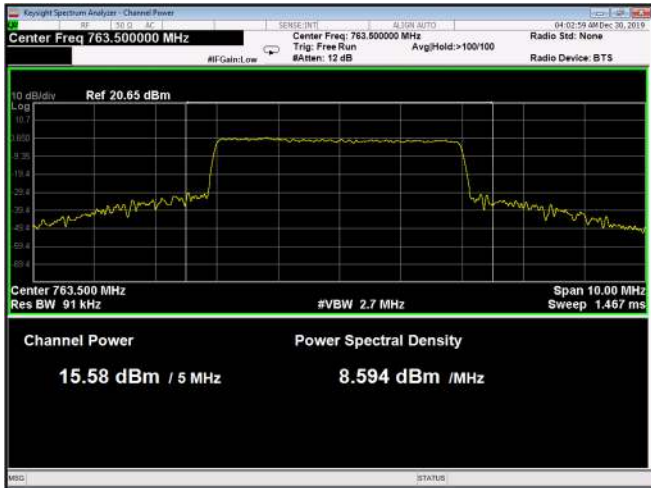

Figure 57: QPSK 5MHz B.W.; 763.5MHz, 30kHz

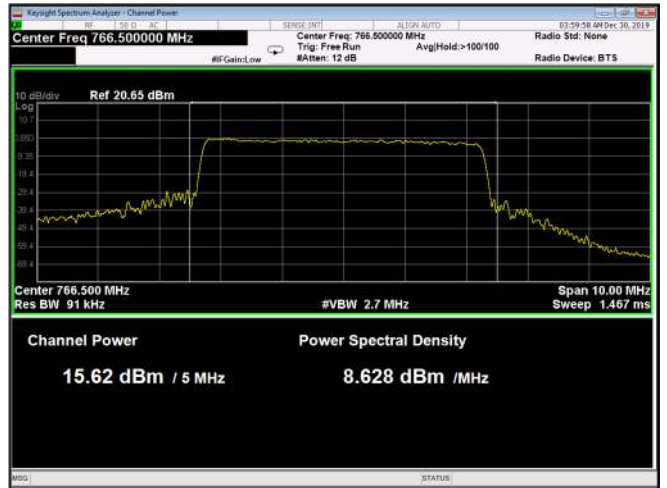

Figure 58: QPSK 5MHz B.W.; 766.5MHz, 15kHz

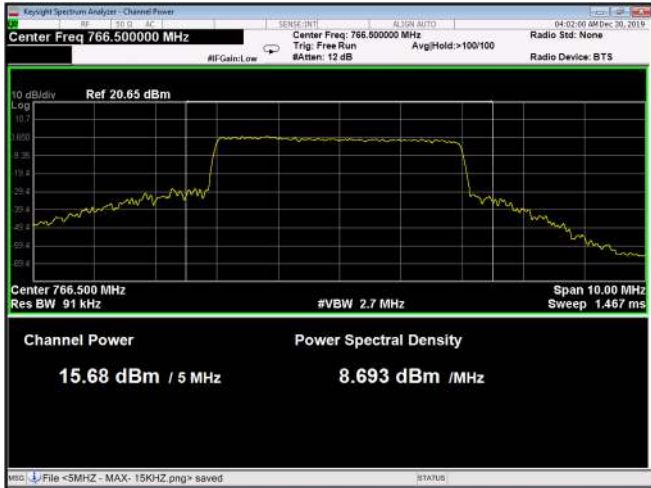

Figure 59: QPSK 5MHz B.W.; 766.5MHz, 30kHz

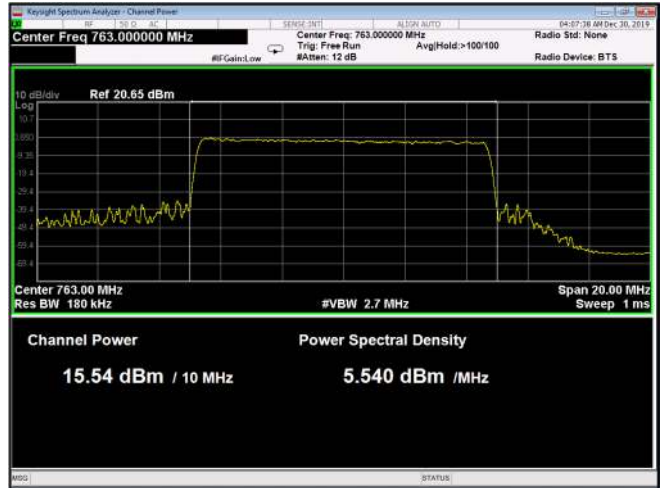

Figure 60: QPSK 10MHz B.W.; 763.0MHz, 15kHz

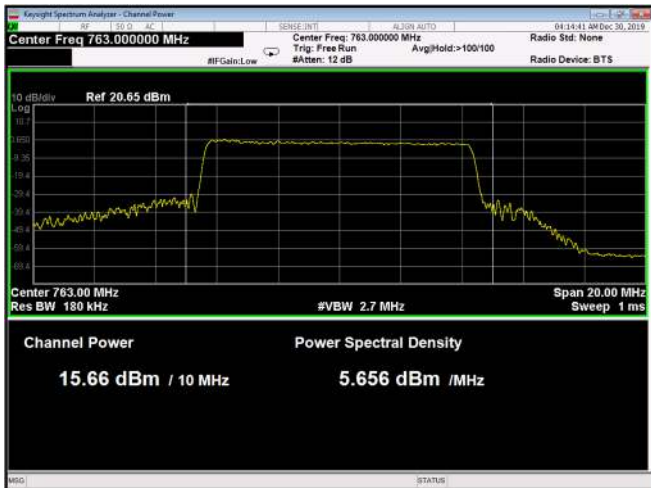

Figure 61: QPSK 5MHz B.W.; 763.0MHz, 30kHz

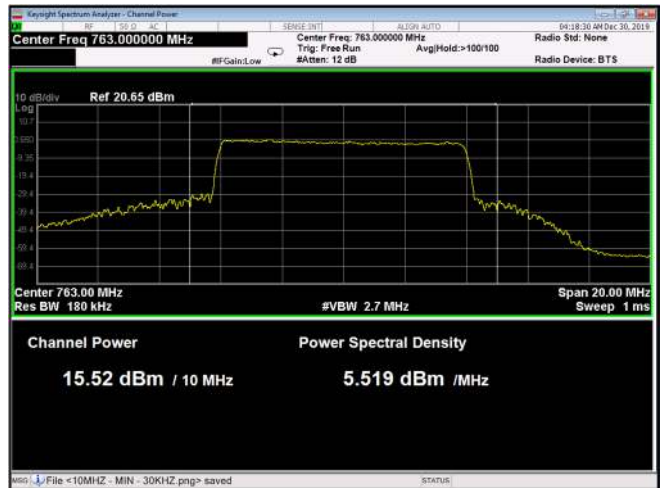

Figure 62: QPSK 10MHz B.W.; 763.0MHz, 15kHz

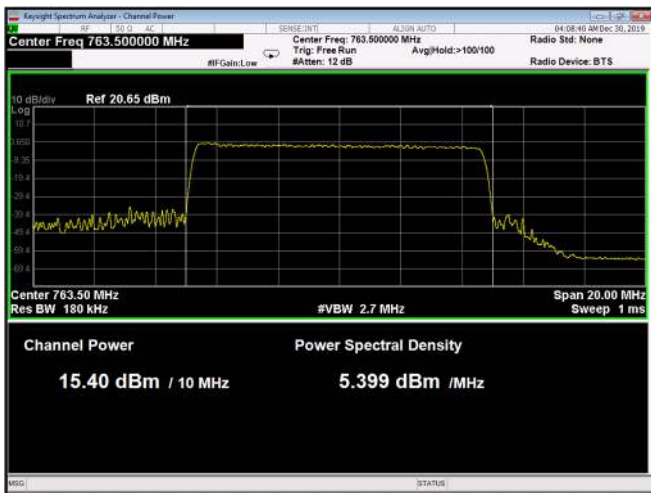

Figure 63: QPSK 10MHz B.W.; 763.5MHz, 15kHz

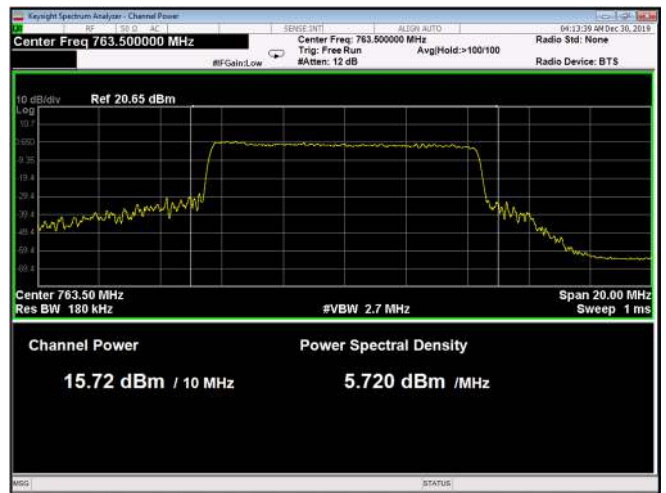

Figure 64: QPSK 1MHz B.W.; 763.5MHz, 30kHz

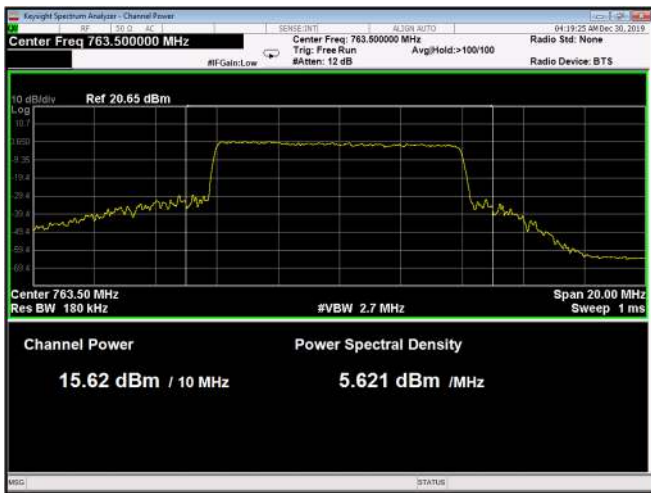

Figure 65: QPSK 10MHz B.W.; 763.5MHz, 60kHz

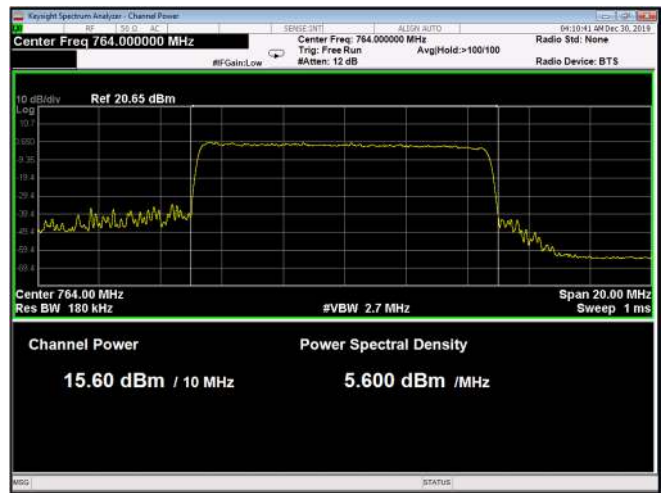

Figure 66: QPSK 10MHz B.W.; 764.0MHz, 15kHz



Figure 67: QPSK 10MHz B.W.; 764.0MHz, 30kHz



Figure 68: QPSK 10MHz B.W.; 764.0MHz, 60kHz

4.5 Test Equipment Used; RF Power Output

Instrument	Manufacturer	Model	Serial Number	Calibration	
				Last Calibration Date	Next Calibration Due
EXA signal Analyzer	Agilent Technologies	N9010A	MY52220686	28 November 2018	28 November 2020
EXG Vector Signal Generator	Agilent Technologies	N5172B	MY51350437	03 December 2018	03 December 2020
20 dB Attenuator	Bird	8304-N20DB	-	24 December 2019	24 December 2020

Table 5 Test Equipment Used

5 Peak to Average Power Ratio

5.1 Test Procedure

(Temperature (22°C)/ Humidity (40%RH))

The method used is detailed in FCC KDB 971168 D03 v01

Measurements was using CCDF function for each modulation.

5.2 Test Limit

The peak-to-average power ratio (PAPR) of the transmitter output power must not exceed 13 dB.

5.3 Test Results

JUDGEMENT: Passed

For additional information see Table 6 to Table 9 and Figure 69 to Figure 96.

Modulation	Bandwidth	Sub Carrier	Operation Frequency	0.1% PAPR	Limit	Margin
	(MHz)	(kHz)	(MHz)	(dBm)	(dBm)	(dB)
16QAM	5	15	760.5	8.65	13.0	-4.4
			766.5	8.71		-4.3
		30	760.5	8.53		-4.5
			766.5	8.50		-4.5
	10	15	763.0	8.60		-4.4
		30	763.0	8.59		-4.4
		60	763.0	8.54		-4.5

Table 6 Test Results Peak to Average Power Ratio 16 QAM

Modulation	Bandwidth	Sub Carrier	Operation Frequency	0.1% PAPR	Limit	Margin
	(MHz)	(kHz)	(MHz)	(dBm)	(dBm)	(dB)
64QAM	5	15	760.5	8.98	13.0	-4.0
			766.5	9.00		-4.0
		30	760.5	8.84		-4.2
			766.5	8.81		-4.2
	10	15	763.5	9.08		-3.9
		30	763.5	9.08		-3.9
		60	763.5	8.92		-4.1

Table 7 Test Results Peak to Average Power Ratio 64 QAM

Modulation	Bandwidth	Sub Carrier	Operation Frequency	0.1% PAPR	Limit	Margin
	(MHz)	(kHz)	(MHz)	(dBm)	(dBm)	(dB)
256QAM	5	15	760.5	8.58	13.0	8.58
			766.5	8.70		8.70
		30	760.5	8.73		8.73
			766.5	8.71		8.71
	10	15	763.5	8.89		8.89
		30	763.5	8.68		8.68
		60	763.5	8.72		8.72

Table 8 Test Results Peak to Average Power Ratio 256 QAM

Modulation	Bandwidth	Sub Carrier	Operation Frequency	0.1% PAPR	Limit	Margin
	(MHz)	(kHz)	(MHz)	(dBm)	(dBm)	(dB)
QPSK	5	15	760.5	9.71	13.0	-3.3
			766.5	9.74		-3.3
		30	760.5	9.90		-3.1
			766.5	9.88		-3.1
	10	15	763.5	9.35		-3.7
		30	763.5	10.10		-2.9
		60	763.5	9.87		-3.1

Table 9 Test Results Peak to Average Power Ratio QPSK

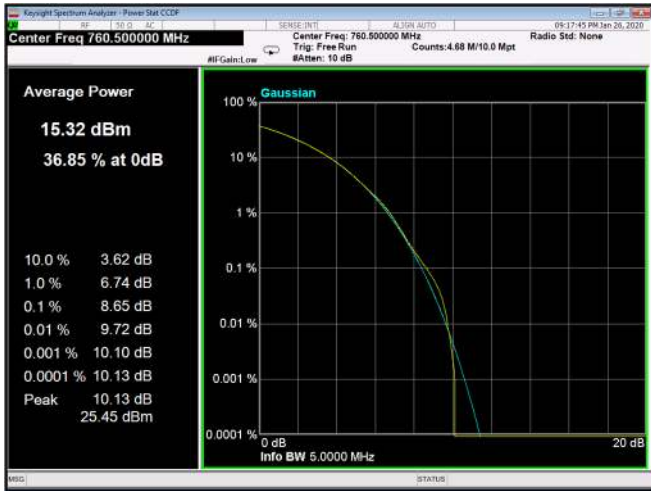

Figure 69: 16QAM 5MHz B.W.; 760.5MHz, 15kHz

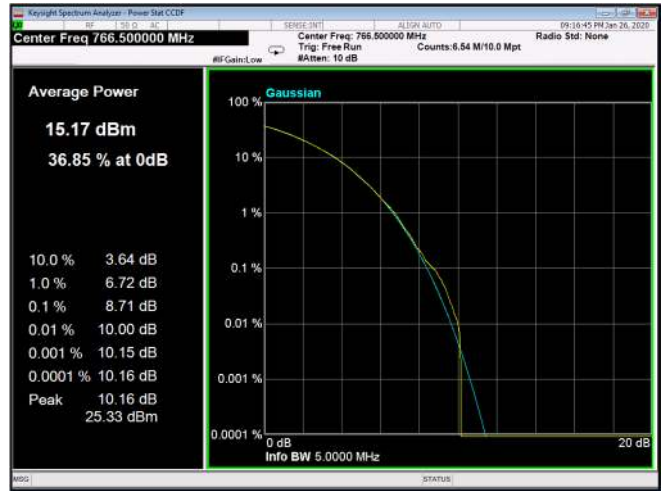

Figure 70: 16QAM 5MHz B.W.; 766.5MHz, 15kHz

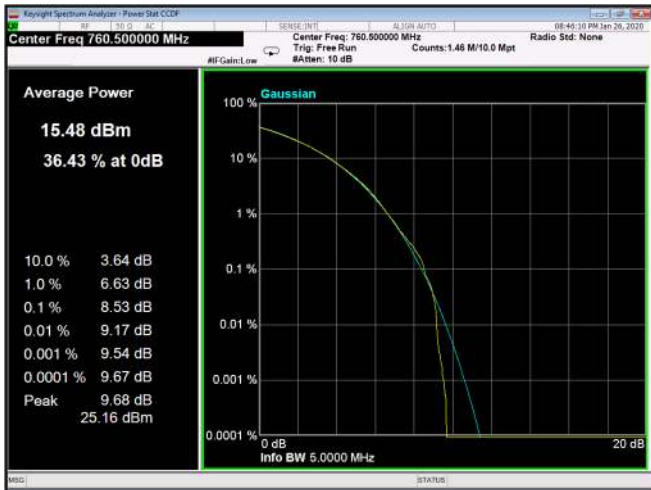

Figure 71: 16QAM 5MHz B.W.; 760.5MHz, 30kHz

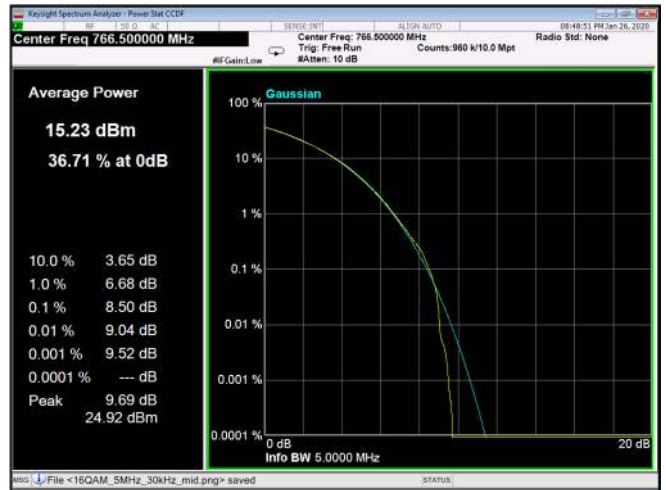

Figure 72: 16QAM 5MHz B.W.; 766.5MHz, 30kHz

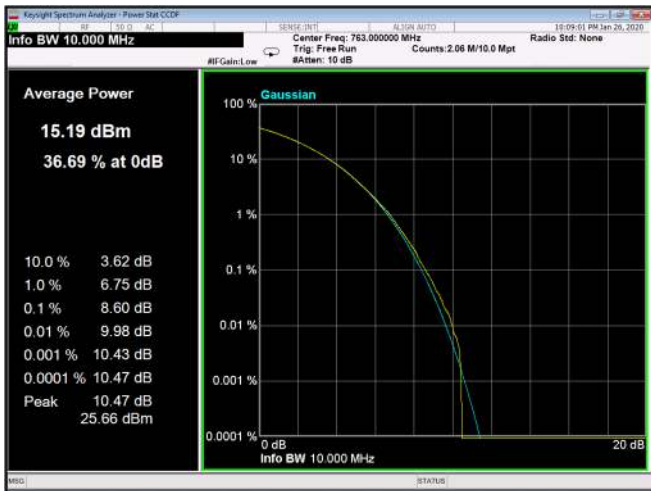

Figure 73: 16QAM 10MHz B.W.; 763.0MHz, 15kHz

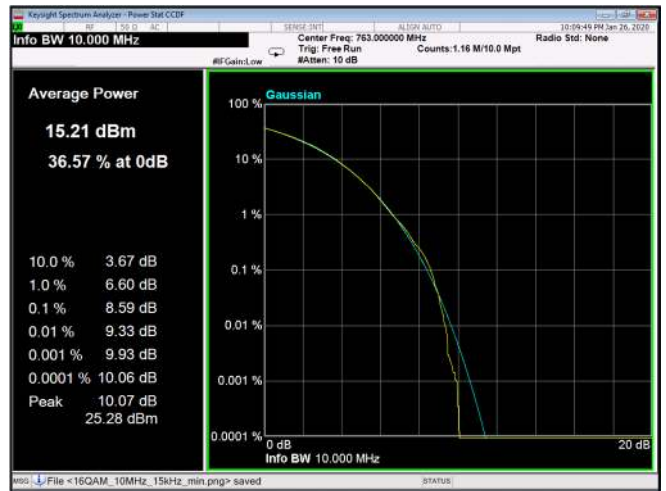

Figure 74: 16QAM 10MHz B.W.; 763.0MHz, 30kHz

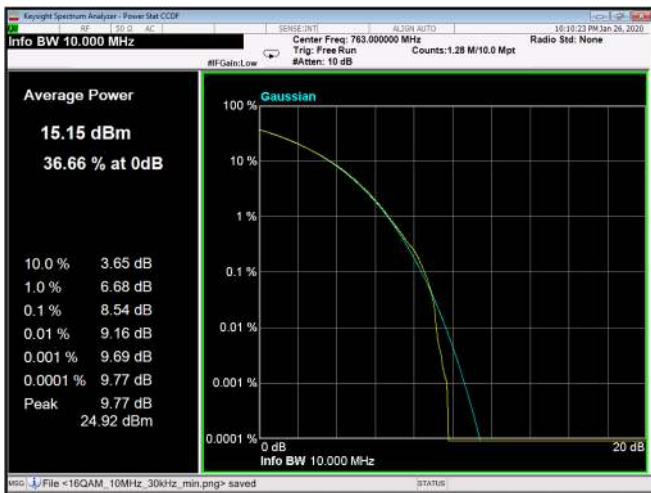

Figure 75: 16QAM 10MHz B.W.; 763.0MHz, 60kHz

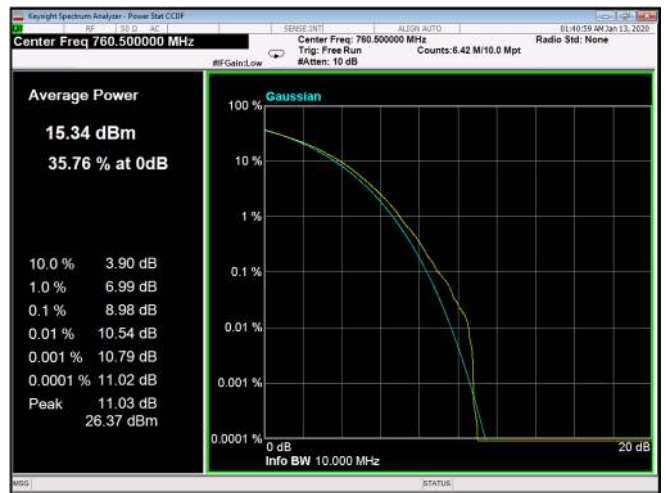

Figure 76: 64QAM 5MHz B.W.; 760.5MHz, 15kHz



Figure 77: 64QAM 5MHz B.W.; 766.5MHz, 15kHz

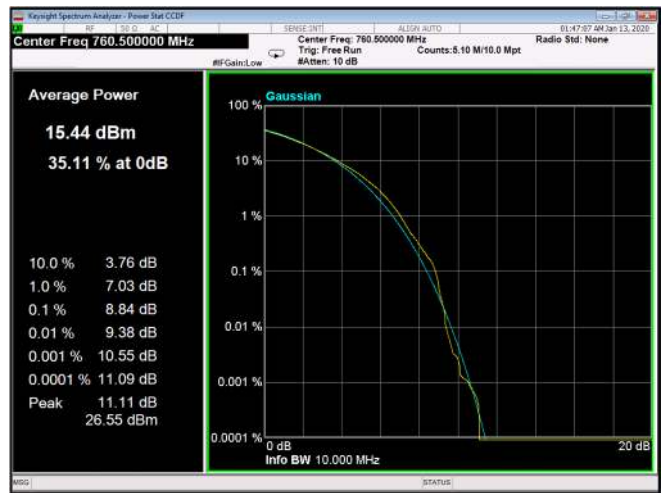

Figure 78: 64QAM 55MHz B.W.; 760.5MHz, 30kHz



Figure 79: 64QAM 5MHz B.W.; 766.5MHz, 30kHz

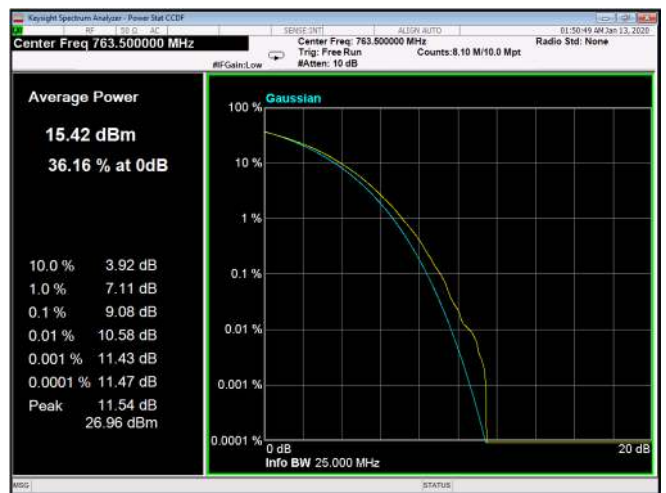

Figure 80: 64QAM 10MHz B.W.; 763.5MHz, 15kHz

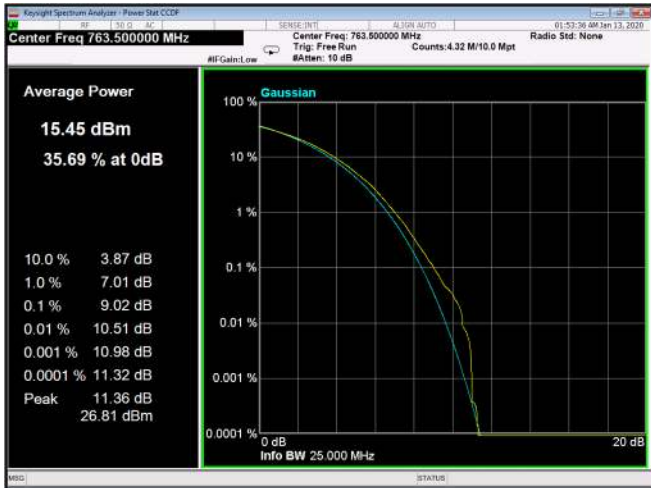

Figure 81: 64QAM 10MHz B.W.; 763.5MHz, 30kHz

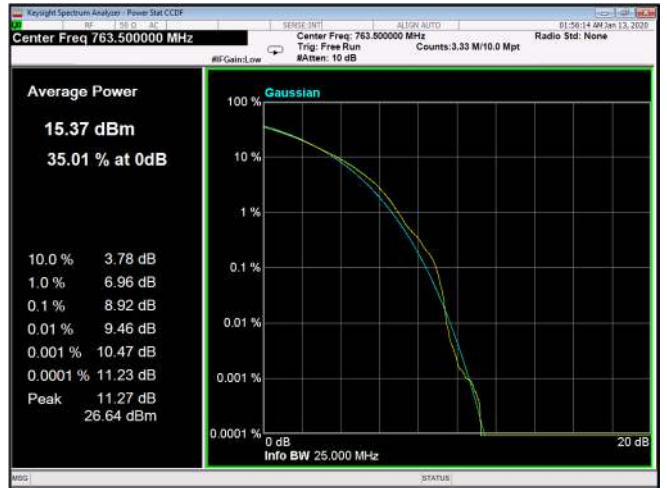

Figure 82: 64QAM 10MHz B.W.; 763.5MHz, 60kHz

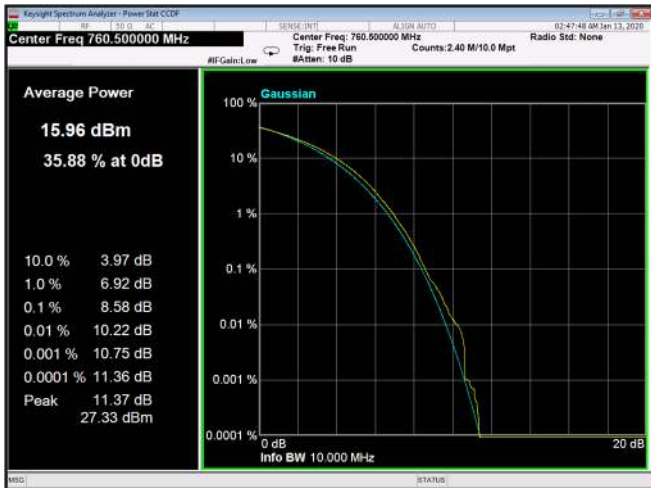

Figure 83: 256QAM 5MHz B.W.; 760.5MHz, 15kHz

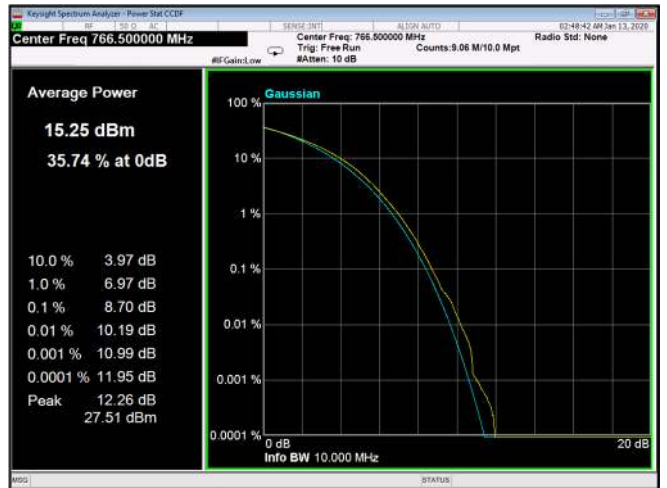

Figure 84: 256QAM 5MHz B.W.; 766.5MHz, 15kHz



Figure 85: 256QAM 5MHz B.W.; 760.5MHz, 30kHz

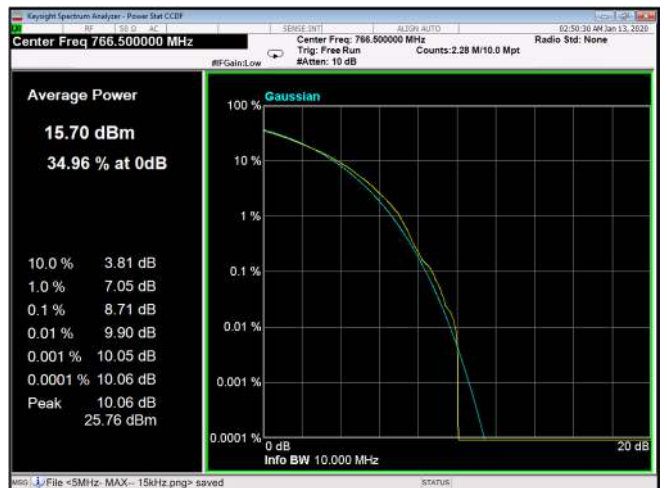

Figure 86: 256QAM 5MHz B.W.; 766.5MHz, 30kHz

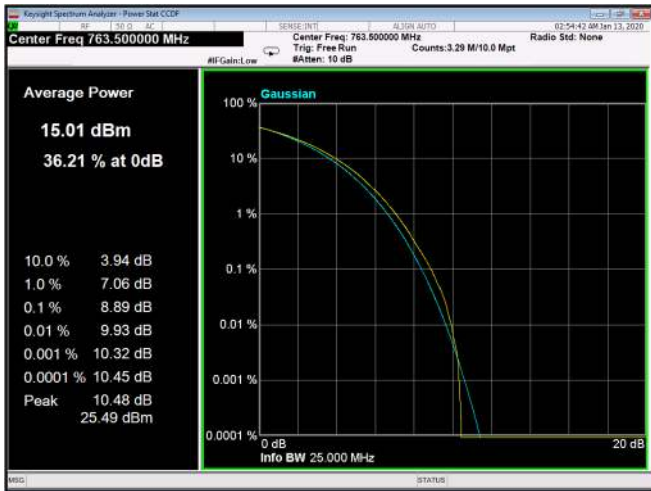

Figure 87: 256QAM 10MHz B.W.; 763.5MHz, 15kHz

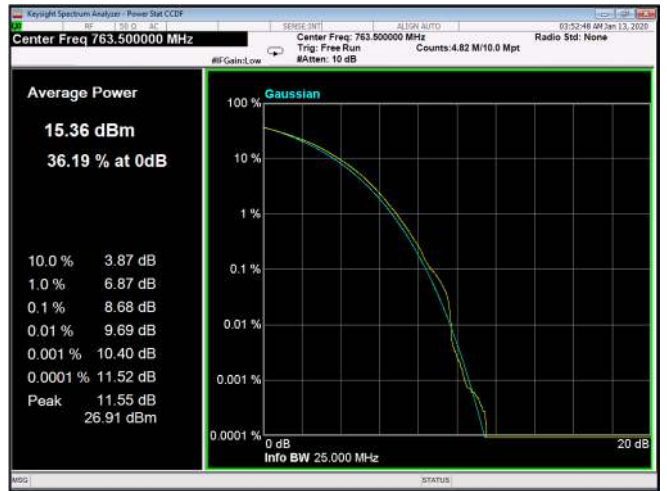

Figure 88: 256QAM 10MHz B.W.; 763.50MHz, 30kHz

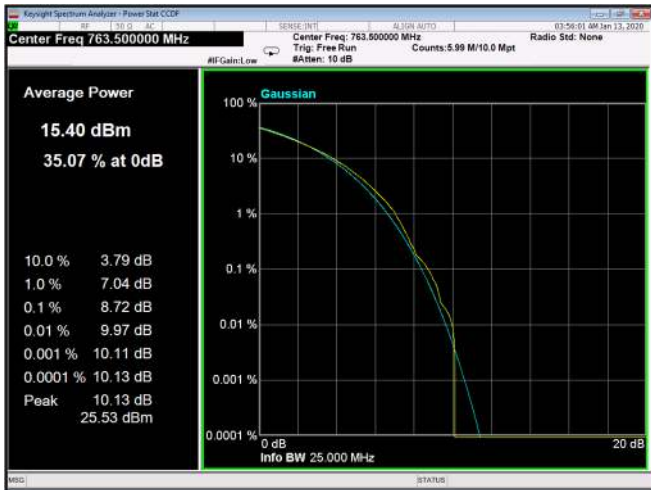

Figure 89: 256QAM 10MHz B.W.; 763.5MHz, 60kHz

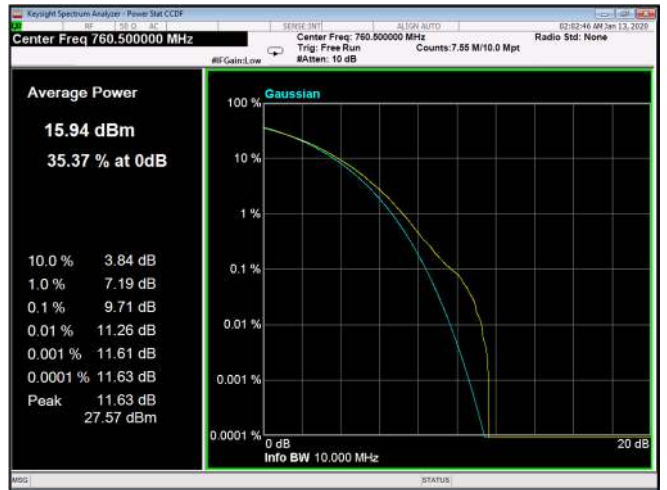

Figure 90: QPSK 5MHz B.W.; 760.5MHz, 15kHz

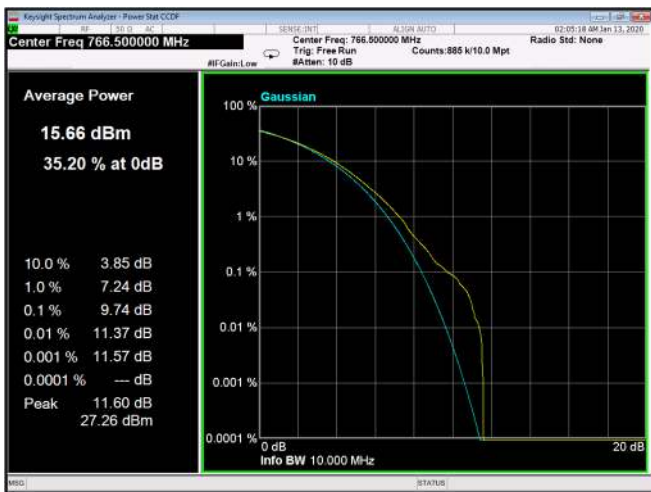

Figure 91: QPSK 5MHz B.W.; 766.5MHz, 15kHz



Figure 92: QPSK 5MHz B.W.; 760.5MHz, 30kHz



Figure 93: QPSK 5MHz B.W.; 766.5MHz, 30kHz

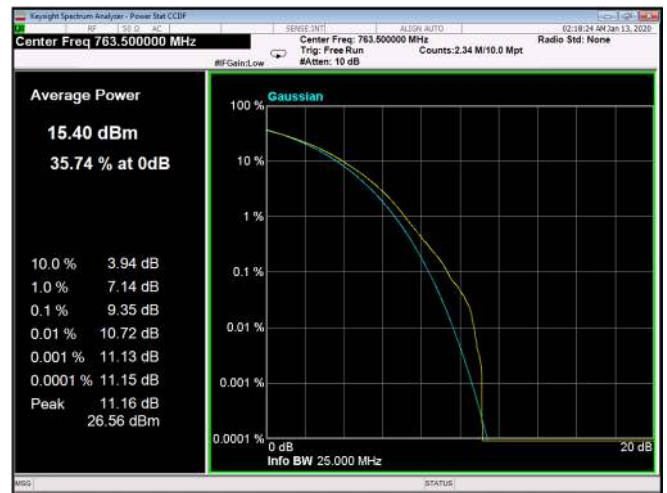

Figure 94: QPSK 10MHz B.W.; 763.5MHz, 15kHz



Figure 95: QPSK 10MHz B.W.; 763.5MHz, 30kHz

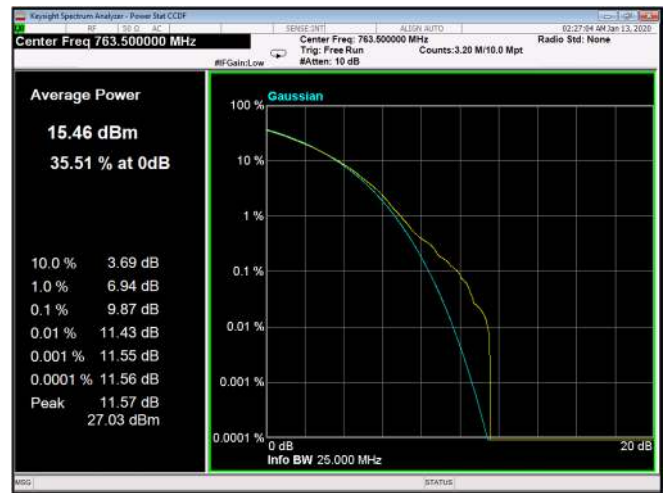

Figure 96: QPSK 10MHz B.W.; 763.5MHz, 60kHz

5.4 Test Equipment Used; 0.1% PAPR

Instrument	Manufacturer	Model	Serial Number	Calibration	
				Last Calibration Date	Next Calibration Due
EXA signal Analyzer	Agilent Technologies	N9010A	MY52220686	28 November 2018	28 November 2020
EXG Vector Signal Generator	Agilent Technologies	N5172B	MY51350437	03 December 2018	03 December 2020
20 dB Attenuator	Bird	8304-N20DB	-	24 December 2019	24 December 2020

Table 10 Test Equipment Used