



DATE: 5 December 2016

**I.T.L. (PRODUCT TESTING) LTD.
FCC Radio Test Report**

For

Corning Optical Communication Wireless

Equipment under test:

ONE - Optical Network Evolution DAS

RAU-5X Remote Antenna Unit

**AWS-3, CELL/ESMR, LTE, PCS
(LTE Section)**

Tested by:

M. Zohar

Approved by:

D. Shidlowsky

This report must not be reproduced, except in full, without the written permission of I.T.L. (Product Testing) Ltd.

This report relates only to items tested.



TABLE OF CONTENTS

1.	GENERAL INFORMATION -----	5
1.1	Administrative Information.....	5
1.2	List of Accreditations.....	6
1.3	Product Description.....	7
1.4	Test Methodology.....	7
1.5	Test Facility.....	7
1.6	Measurement Uncertainty.....	7
2.	SYSTEM TEST CONFIGURATION -----	8
2.1	Justification.....	8
2.2	EUT Exercise Software.....	8
2.3	Special Accessories.....	8
2.4	Equipment Modifications.....	8
2.5	Configuration of Tested System.....	9
3.	TEST SET-UP PHOTOS -----	11
4.	RF POWER OUTPUT LTE -----	15
4.1	Test Specification.....	15
4.2	Test Procedure.....	15
4.3	Test Limit.....	15
4.4	Test Results.....	15
4.5	Test Equipment Used; RF Power Output LTE.....	21
5.	OCCUPIED BANDWIDTH LTE -----	22
5.1	Test Specification.....	22
5.2	Test Procedure.....	22
5.3	Test Limit.....	22
5.4	Test Results.....	22
5.5	Test Equipment Used; Occupied Bandwidth LTE.....	32
6.	SPURIOUS EMISSIONS AT ANTENNA TERMINALS LTE -----	33
6.1	Test Specification.....	33
6.2	Test Procedure.....	33
6.3	Test Limit.....	33
6.4	Test Results.....	33
6.5	Test Equipment Used; Spurious Emissions at Antenna Terminals LTE.....	37
7.	BAND EDGE SPECTRUM LTE -----	38
7.1	Test Specification.....	38
7.2	Test procedure.....	38
7.3	Test Limit.....	38
7.4	Test Results.....	38
7.5	Test Equipment Used; Band Edge Spectrum LTE.....	42
8.	SPURIOUS RADIATED EMISSION LTE -----	43
8.1	Test Specification.....	43
8.2	Test Procedure.....	43
8.3	Test Limit.....	44
8.4	Test Results.....	44
8.5	Test Instrumentation Used; Radiated Measurements.....	45
9.	INTERMODULATION CONDUCTED -----	46
9.1	Test Procedure.....	46
9.2	Test Limit.....	46
9.3	Test Results.....	46
9.4	Test Equipment Used; Intermodulation Conducted.....	47
10.	INTERMODULATION RADIATED -----	48
10.1	Test Procedure.....	48
10.2	Test Limit.....	49
10.3	Test Results.....	49
10.4	Test Instrumentation Used; Radiated Measurements Intermodulation.....	50



11. OUT-OF-BAND REJECTION (LTE)	51
11.1 Test Specification	51
11.2 Test Procedure	51
11.3 Test Limit	51
11.4 Test Results	51
11.5 Test Equipment Used; Out-of-Band Rejection	52
12. APPENDIX A - CORRECTION FACTORS	53
12.1 Correction factors for RF OATS Cable 35m	53
12.2 Correction factors for RF OATS Cable 10m	54
12.3 Correction factors for Horn Antenna	55
12.4 Correction factors for Horn ANTENNA	56
12.5 Correction factors for Log Periodic Antenna	57
12.6 Correction factors for Biconical Antenna	58
12.7 Correction factors for ACTIVE LOOP ANTENNA	59



1. General Information

1.1 Administrative Information

Manufacturer: Corning Optical Communication Wireless

Manufacturer's Address: 13221 Woodland Park Rd., Suite #400
Herndon, VA. 20171
U.S.A.
Tel: +1-541-758-2880
Fax: +1-703-848-0260

Manufacturer's Representative: Habib Riazi

Equipment Under Test (E.U.T): ONE - Optical Network Evolution DAS

Equipment Model No.: RAU-5X

Equipment Serial No.: 0516110015

Date of Receipt of E.U.T: July 3, 2016

Start of Test: July 10, 2016

End of Test: September 15, 2016

Test Laboratory Location: I.T.L (Product Testing) Ltd.
1 Batsheva St,
Lod,
Israel 7120101

Test Specifications: FCC Parts 2; 27



1.2 List of Accreditations

The EMC laboratory of I.T.L. is accredited by/registered with the following bodies:

1. The American Association for Laboratory Accreditation (A2LA) (U.S.A.), Certificate No. 1152.01.
2. The Federal Communications Commission (FCC) (U.S.A.), FCC Designation Number is IL1005.
3. The Israel Ministry of the Environment (Israel), Registration No. 1104/01.
4. The Voluntary Control Council for Interference by Information Technology Equipment (VCCI) (Japan), Registration Numbers: C-3006, R-2729, T-1877, G-245.
5. Industry Canada (Canada), IC File No.: 46405-4025; Site No. IC 4025A-1, IC 4025A-2.

I.T.L. Product Testing Ltd. is accredited by the American Association for Laboratory Accreditation (A2LA) and the results shown in this test report have been determined in accordance with I.T.L.'s terms of accreditation unless stated otherwise in the report.



1.3 Product Description

The Optical Network Platform (ONE™) by Corning provides a flexible in-building RF and network digital coverage solution based on a fiber optic transport backbone.

The fiber-optics infrastructure is easily deployable via a wide range of pre-terminated composite cables and advanced end-to-end equipment. Easy to design, Plug and Play™ connectors, significantly reduce installation cost and deployment time.

The ONE™ solution is an ideal fit for large, high-rise or campus-style deployments. It generates significant CAPEX savings and OPEX savings through the use of user configurable sectorization and an infrastructure that is simple to deploy and efficient in usage.

Dynamic sectorization management allows precise service distribution control to meet changing density needs, and provides further savings by enabling sharing of equipment at various levels for service providers.

Radio source agnostic, remote units can be used as network extenders. Ethernet capability with dedicated fiber link for Wi-Fi offload brings a higher level of granularity and support for devices and applications with very high speed requirements.

1.4 Test Methodology

Radiated testing was performed according to the procedures in KDB 971168 D03 v01 and KDB 935210 D05 v01r01

Radiated testing was performed at an antenna to EUT distance of 3 meters.

1.5 Test Facility

Both conducted and radiated emissions tests were performed at I.T.L.'s testing facility in Lod, Israel. I.T.L.'s EMC Laboratory is accredited by A2LA, certificate No. 1152.01 and its FCC Designation Number is IL1005.

1.6 Measurement Uncertainty

Conducted Emission (CISPR 11, EN 55011, CISPR 22, EN 55022, ANSI C63.4)

0.15 – 30 MHz:

Expanded Uncertainty (95% Confidence, K=2):

± 3.44 dB

Radiated Emission (CISPR 11, EN 55011, CISPR 22, EN 55022, ANSI C63.4) for open site 30-1000MHz:

Expanded Uncertainty (95% Confidence, K=2):

± 4.98 dB



2. System Test Configuration

2.1 *Justification*

The E.U.T. was originally FCC certified on 02/18/2016 under FCC ID: OJF1RAU5X.

The E.U.T. transmitter is certified to operate as a 5 band remote unit as part of a booster system that can operate with FCC ID: OJF1RXU.

No changes have been made to the E.U.T.

The C2PC change is to allow the E.U.T. to operate as a 5 band remote unit as part of a booster system that can operate with the new RXU2325 certified under FCC ID: OJF1RXUN.

The E.U.T. has been fully tested with the RXU2325 and results presented in the four reports (for bands AWS-3, CELL/ESMR, PCS & LTE) submitted with this application.

The test setup was configured to closely resemble the standard installation. The EUT consists of the HEU, the OIU and the RAU5x. All source signals are represented in the setup by appropriate signal generators. An "Exercise" SW on the computer was used to enable / disable transmission of the RAU5x, while the EUT output was connected to the spectrum analyzer. All channels transmitted during the testing. There is neither an intermediate amplified nor donor antenna in the uplink. All components included in the UL path are connected by cables.

2.2 *EUT Exercise Software*

HCM_2.2 Build23
ACM_2a00_22_11.bin
RMM_5a00_22_02. bin
OIM_7a03_22_05. bin
RAU5_9a64_22_12.bin

2.3 *Special Accessories*

No special accessories were needed in order to achieve compliance.

2.4 *Equipment Modifications*

No modifications were necessary in order to achieve compliance.

2.5 Configuration of Tested System

Product Name	ONE Wireless Platform
Model Name	RAU-5X
Working voltage	48.0VDC (via ac/dc adapter: Manufacturer: FSP GROUP P/N: 9NA1201601 S/N: H00003056
Mode of operation	Industrial Booster for LTE band
Modulations	QPSK, 16QAM, 64QAM
Assigned Frequency Range	728.0MHz-758.0MHz
Transmit power	~20.0dBm
Antenna Gain	12.5dBi
DATA rate	N/A
Modulation BW	10.0MHz

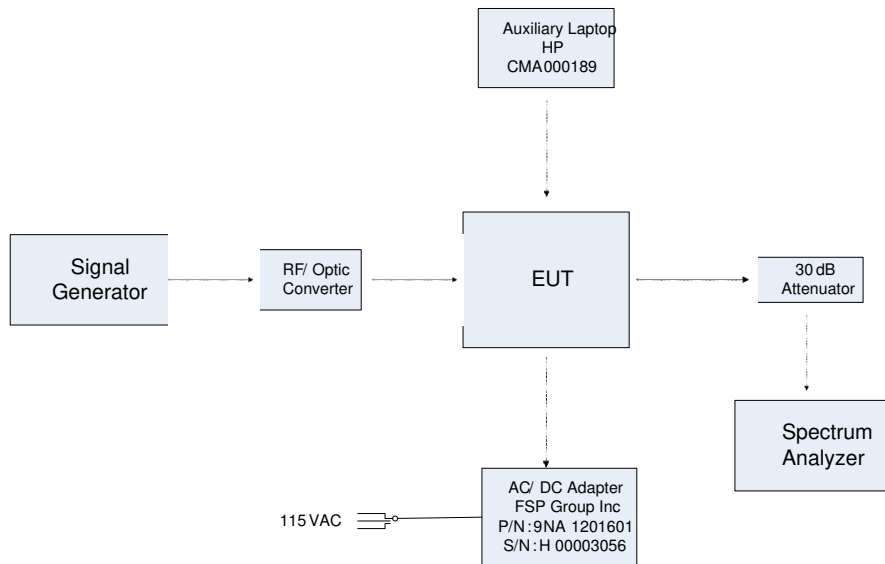

Figure 1. Conducted Test Set-Up

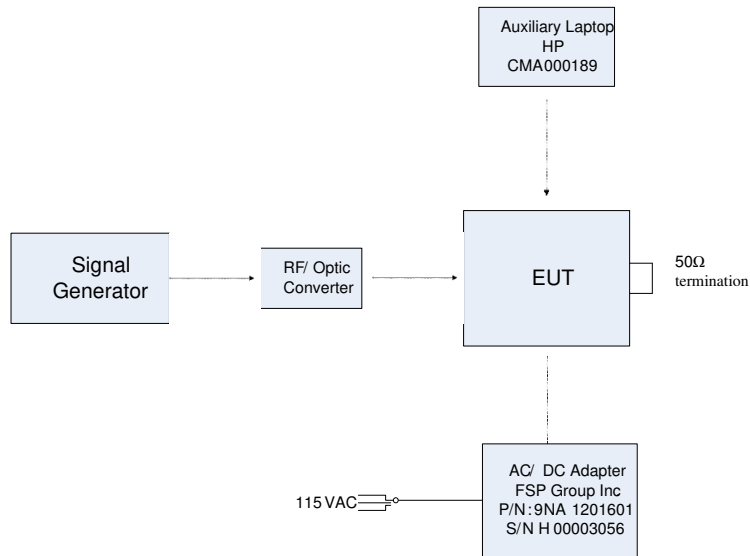

Figure 2. Radiated Test Set-Up

3. Test Set-Up Photos

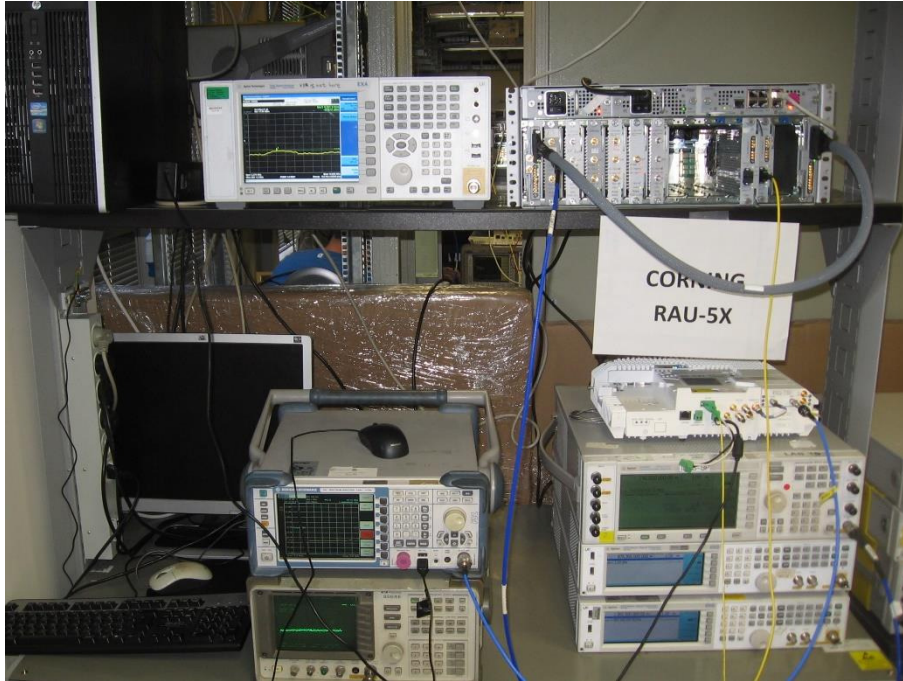

Figure 3. Conducted Emission From Antenna Port Test



Figure 4. Radiated Emission Test



Figure 5. Radiated Emission Test

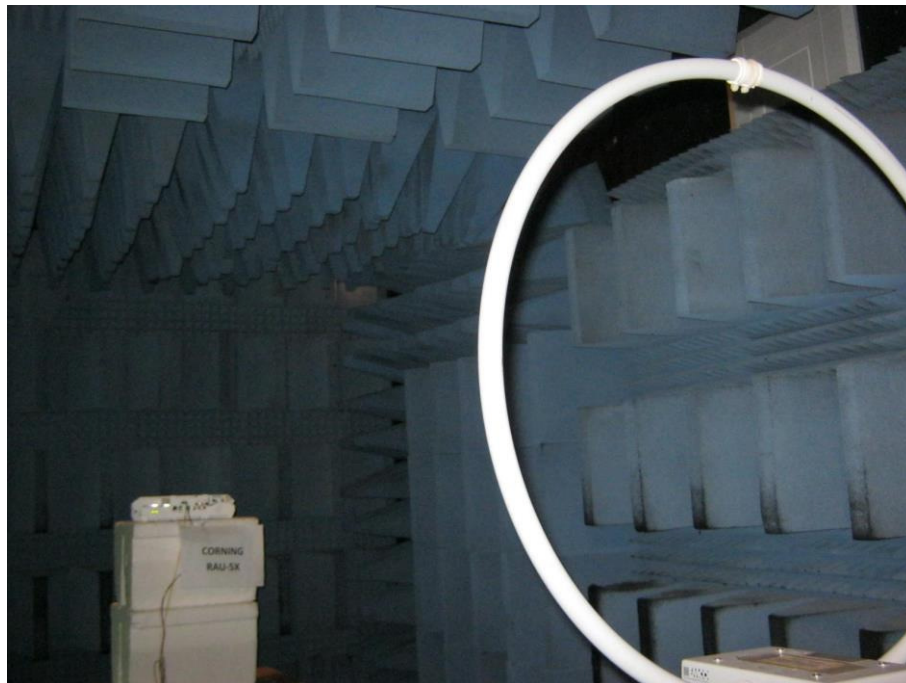

Figure 6. Radiated Emission Test



Figure 7. Radiated Emission Test



Figure 8. Radiated Emission Test

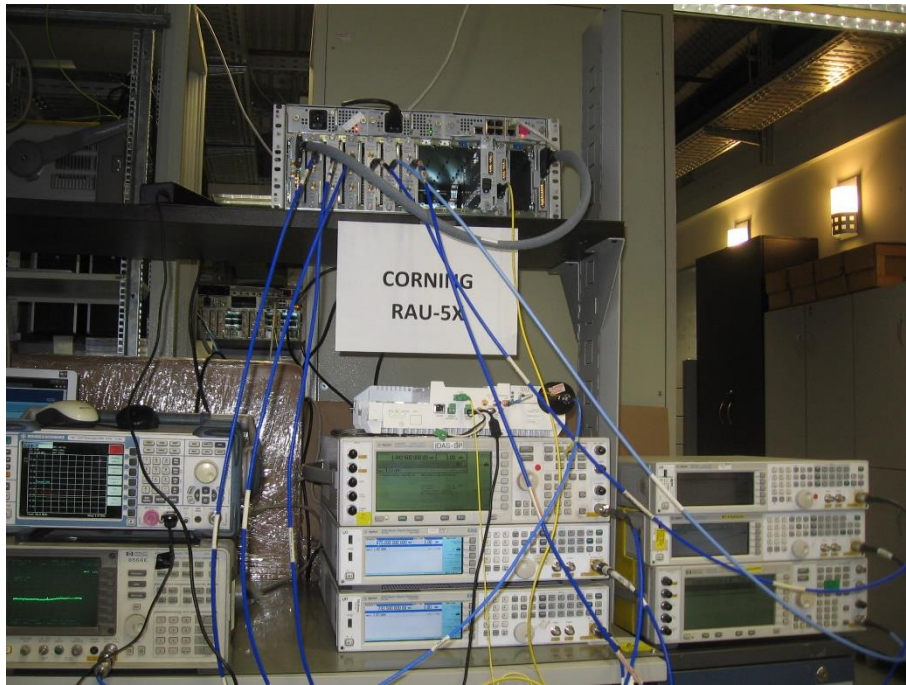

Figure 9. Intermodulated Conducted Emission Test



4. RF Power Output LTE

4.1 Test Specification

FCC Part 27, Subpart C (27.50)

4.2 Test Procedure

(Temperature (23°C)/ Humidity (36%RH))

The E.U.T. antenna terminal was connected to the Spectrum Analyzer through an external attenuator (31.0 dB) and an appropriate coaxial cable. Special attention was taken to prevent Spectrum Analyzer RF input overload. The Spectrum Analyzer was set to 100 kHz RBW.

4.3 Test Limit

Peak Power Output must not exceed 1000W (60 dBm).

4.4 Test Results

Modulation	Operation Frequency	Reading	Antenna Gain	EIRP	Limit	Margin
	(MHz)	(dBm)	(dBi)	(dBm)	(dBm)	(dB)
LTE 64QAM	733.0	16.7	12.5	29.2	60.0	-30.8
LTE 64QAM	747.0	16.7	12.5	29.2	60.0	-30.8
LTE 64QAM	753.0	16.5	12.5	29.0	60.0	-31.0
LTE 16QAM	733.0	16.5	12.5	29.0	60.0	-31.0
LTE 16QAM	747.0	16.7	12.5	29.2	60.0	-30.8
LTE 16QAM	753.0	15.4	12.5	27.9	60.0	-32.1
LTE QPSK	733.0	16.5	12.5	29.0	60.0	-31.0
LTE QPSK	747.0	16.8	12.5	29.3	60.0	-30.7
LTE QPSK	753.0	16.4	12.5	28.9	60.0	-31.1

Figure 10 RF Power Output LTE

JUDGEMENT: Passed

See additional information in *Figure 11* to *Figure 19*.

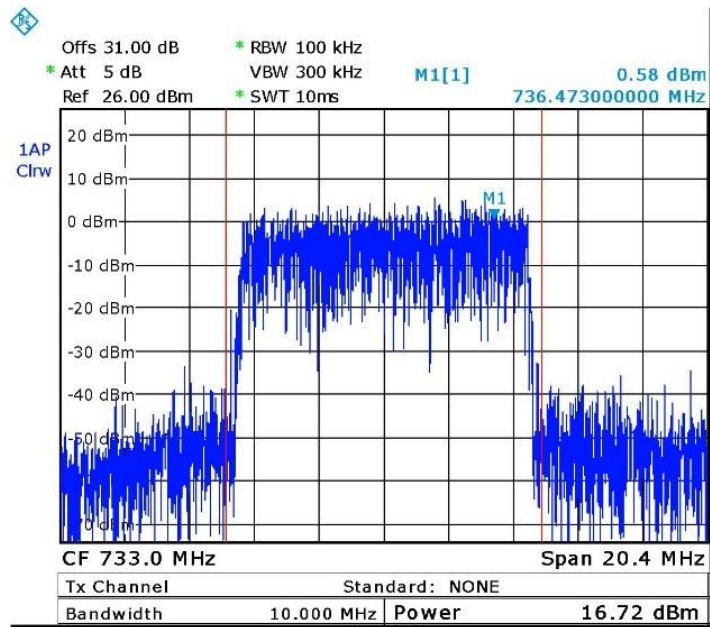

Date: 10.JUL.2016 14:37:41

Figure 11. — 64QAM, 733 MHz

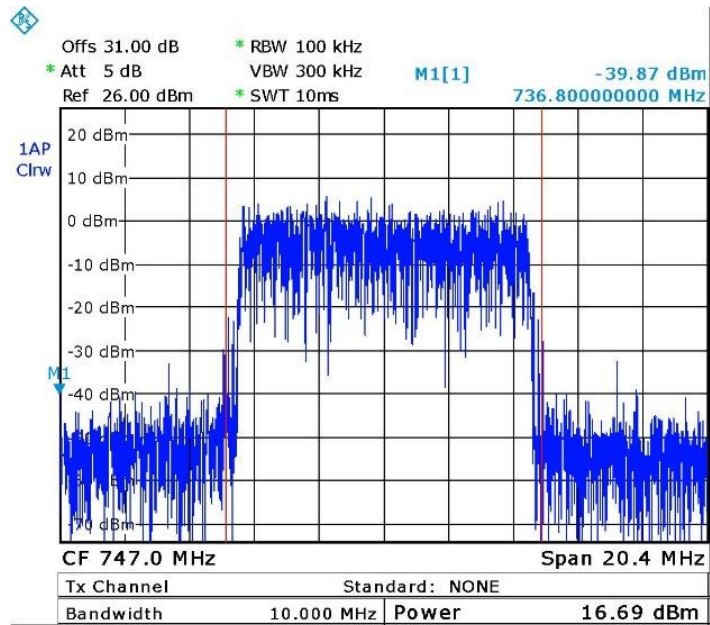

Date: 10.JUL.2016 14:38:14

Figure 12. — 64QAM 747 MHz

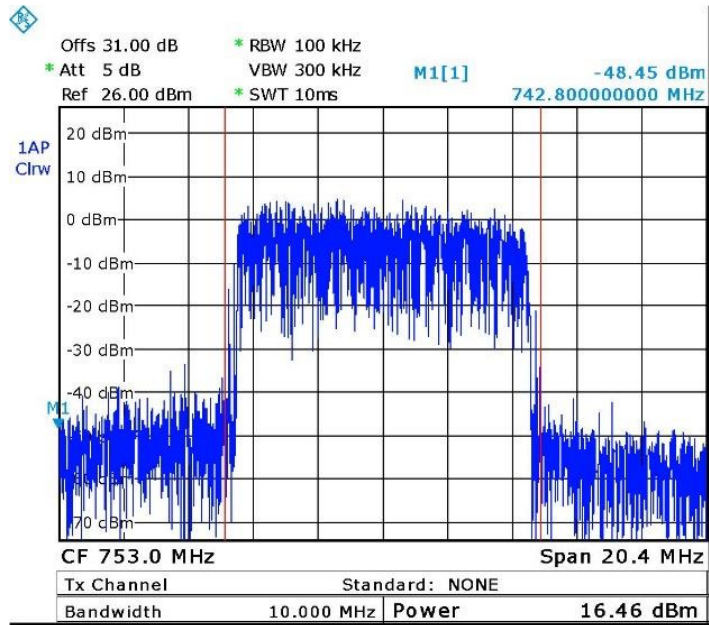

Date: 10.JUL.2016 14:38:59

Figure 13. — 64QAM 753 MHz

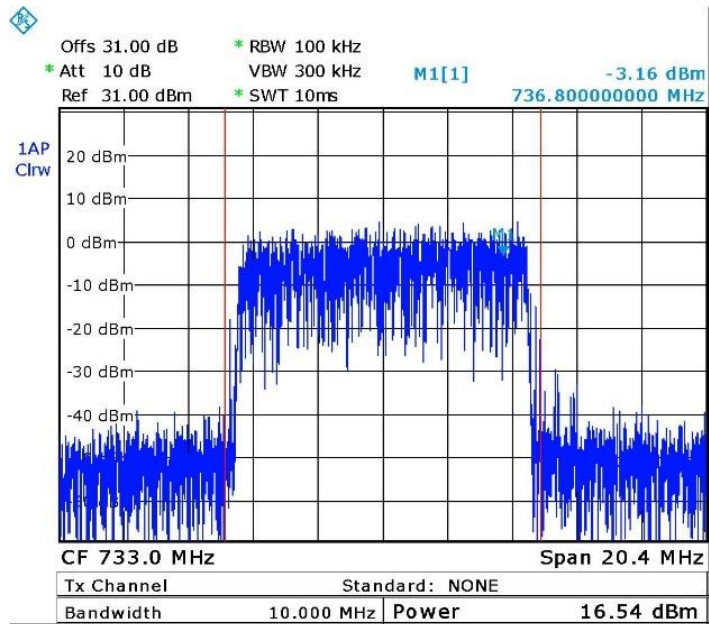

Date: 10.JUL.2016 15:23:07

Figure 14. — 16QAM 733 MHz

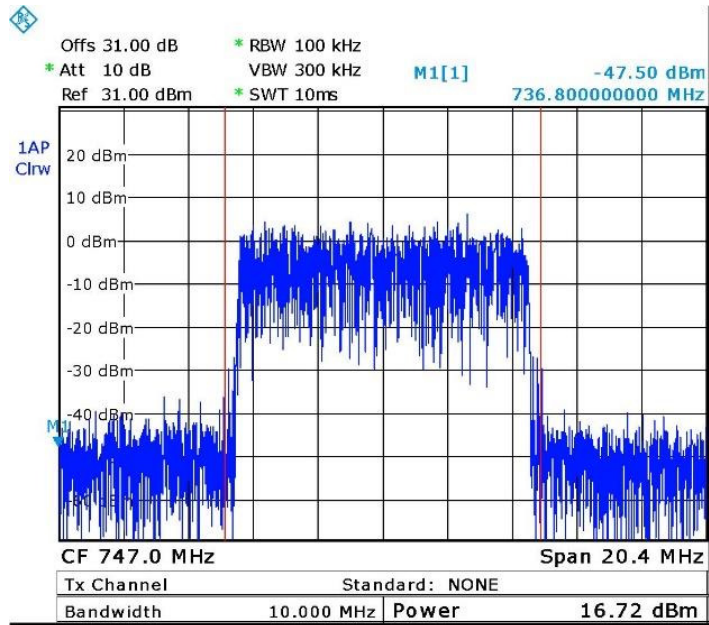

Date: 10.JUL.2016 15:23:47

Figure 15. — 16QAM 747 MHz

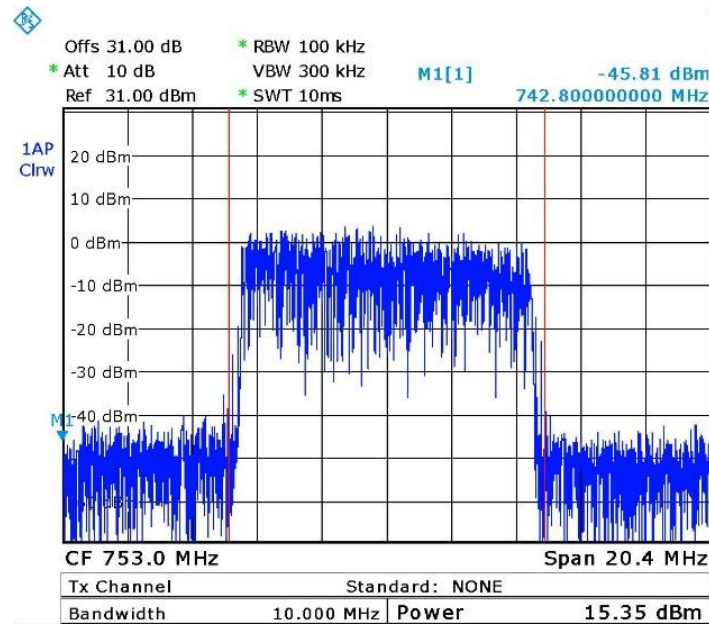

Date: 10.JUL.2016 15:24:16

Figure 16. — 16QAM 753 MHz

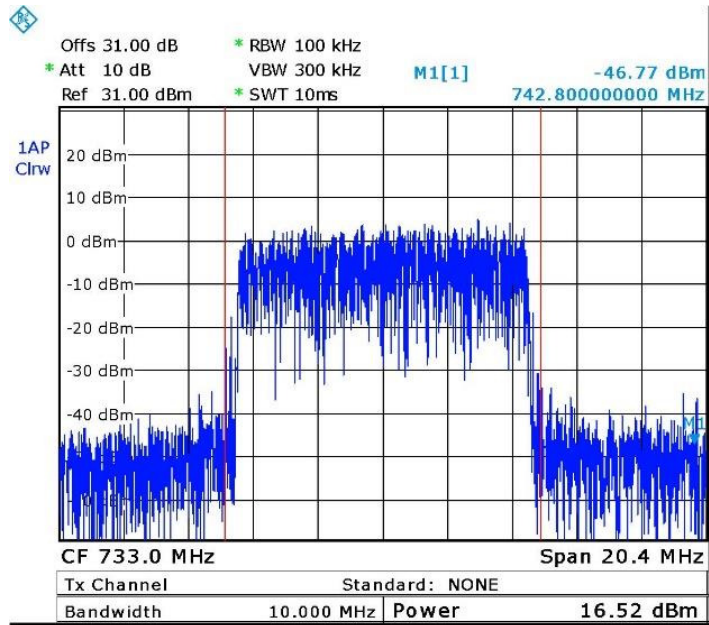

Date: 10.JUL.2016 15:26:13

Figure 17. — QPSK 733 MHz

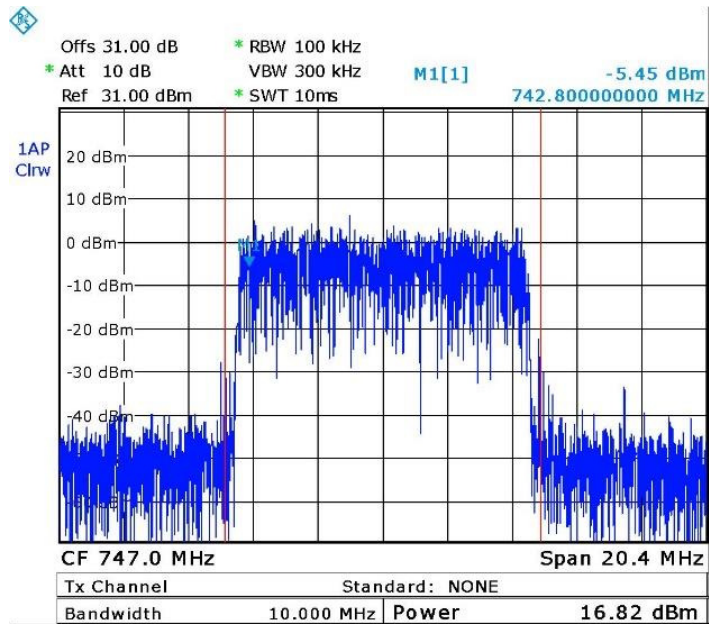

Date: 10.JUL.2016 15:25:43

Figure 18. — QPSK 747 MHz

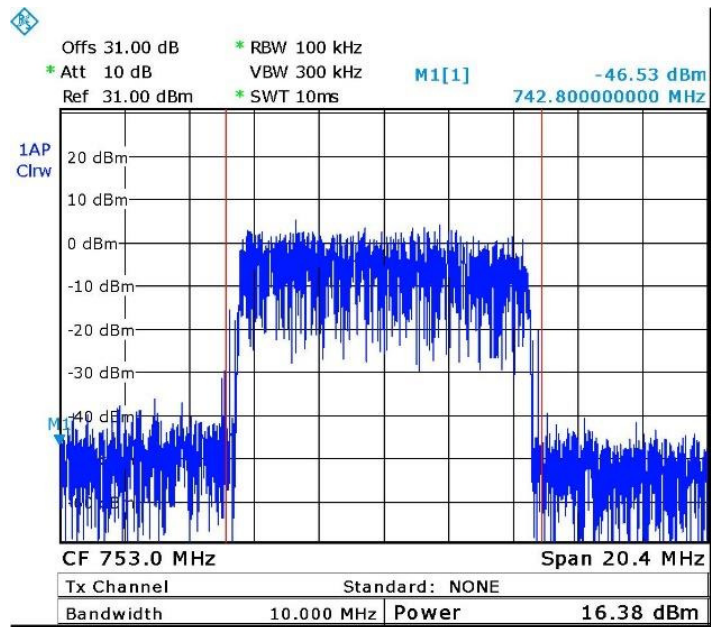

Date: 10.JUL.2016 15:25:06

Figure 19. — QPSK 753 MHz



4.5 Test Equipment Used; RF Power Output LTE

Instrument	Manufacturer	Model	Serial Number	Calibration	
				Last Calibration Date	Next Calibration Due
Spectrum Analyzer	R&S	FSL6	100194	February 29, 2016	March 1, 2017
Vector Signal Generator	Agilent	N5172B	MY51350584	July 1, 2016	July 1, 2017
30 dB Attenuator	MCL	BW-S30W5	533	July 5, 2016	July 5, 2017

Figure 20 Test Equipment Used

5. Occupied Bandwidth LTE

5.1 Test Specification

FCC Part 2, Section 1049

5.2 Test Procedure

(Temperature (22°C)/ Humidity (35%RH))

The E.U.T. antenna terminal was connected to the spectrum analyzer through an external attenuator and an appropriate coaxial cable (loss=31.0 dB). The spectrum analyzer was set to proper resolution B.W.

OBW function (99%) was employed for this evaluation.

Occupied bandwidth measured was repeated in the input terminal of the E.U.T.

5.3 Test Limit

N/A

5.4 Test Results

Modulation	Port	Operating Frequency	Reading
	(Input/ Output)	(MHz)	(MHz)
LTE 64QAM	Input	733.0	9.0
LTE 64QAM	Output	733.0	9.0
LTE 64QAM	Input	747.0	9.0
LTE 64QAM	Output	747.0	8.9
LTE 64QAM	Input	753.0	8.9
LTE 64QAM	Output	753.0	8.9
LTE 16QAM	Input	733.0	8.9
LTE 16QAM	Output	733.0	8.9
LTE 16QAM	Input	747.0	8.9
LTE 16QAM	Output	747.0	9.0
LTE 16QAM	Input	753.0	8.9
LTE 16QAM	Output	753.0	8.9
LTE QPSK	Input	733.0	8.9
LTE QPSK	Output	733.0	8.9
LTE QPSK	Input	747.0	8.9
LTE QPSK	Output	747.0	8.9
LTE QPSK	Input	753.0	8.9
LTE QPSK	Output	753.0	8.9

Figure 21 Occupied Bandwidth LTE

JUDGEMENT: Passed

See additional information in *Figure 22* to *Figure 39*.

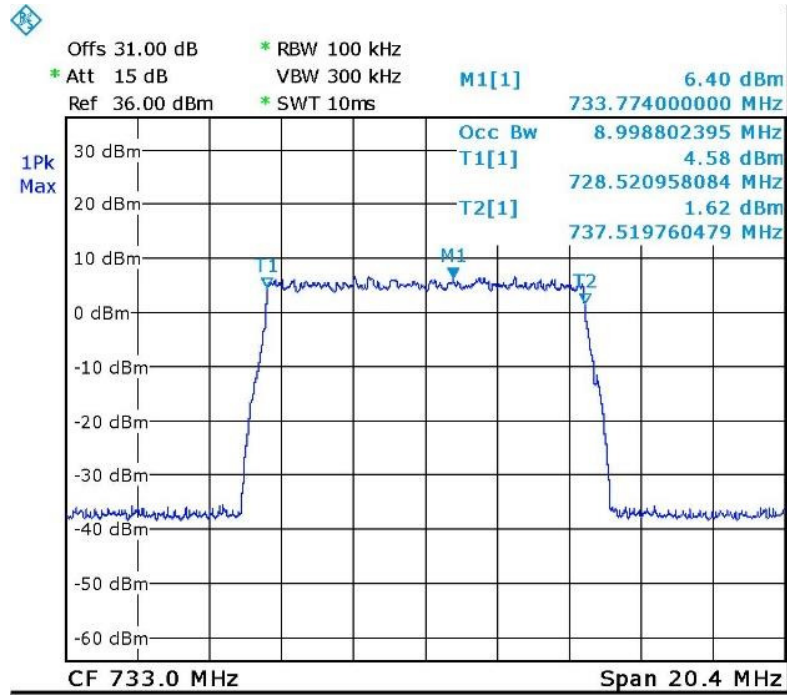

Date: 10.JUL.2016 14:52:10

Figure 22. — 64QAM 733 MHz IN

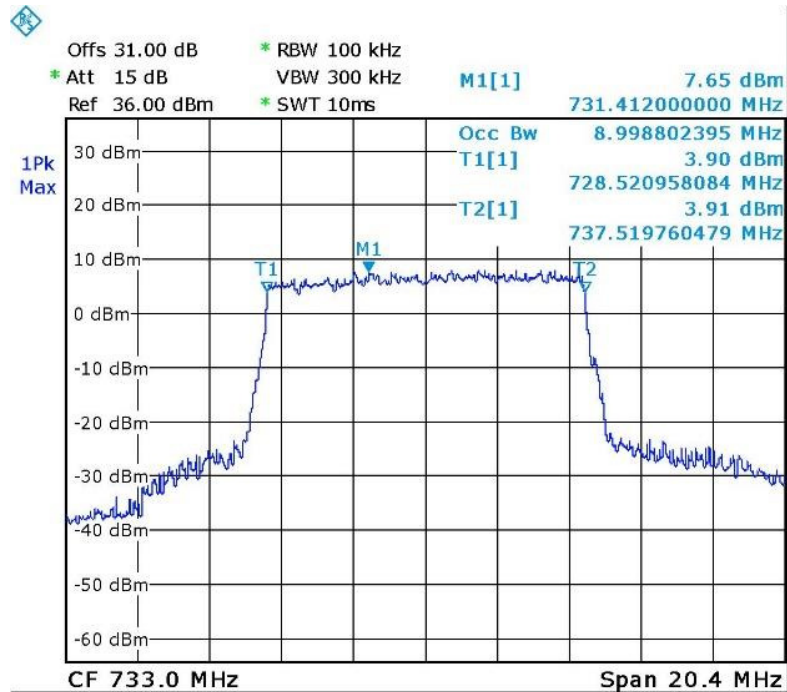

Date: 10.JUL.2016 14:46:48

Figure 23. — 64QAM 733 MHz OUT

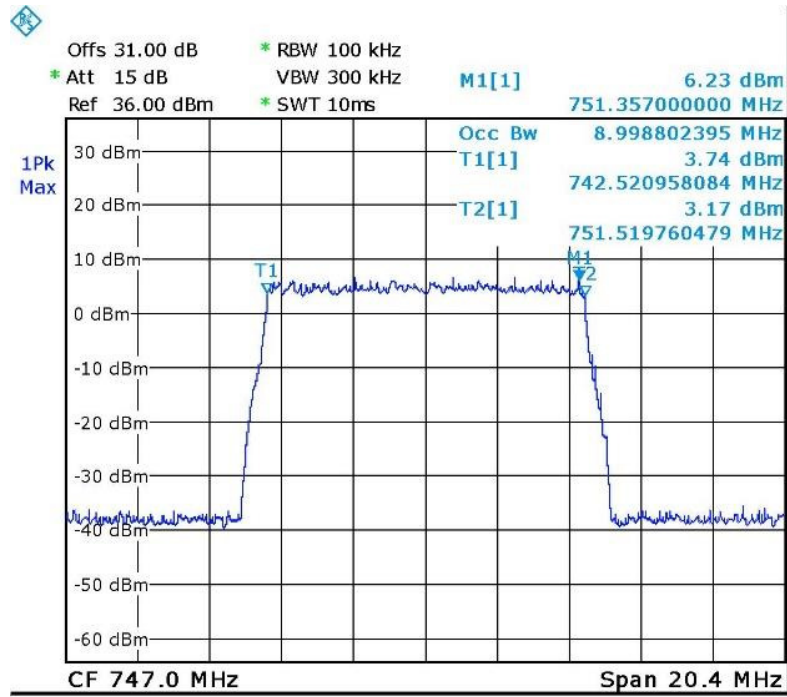

Date: 10.JUL.2016 14:52:35

Figure 24. — 64QAM 747 MHz IN

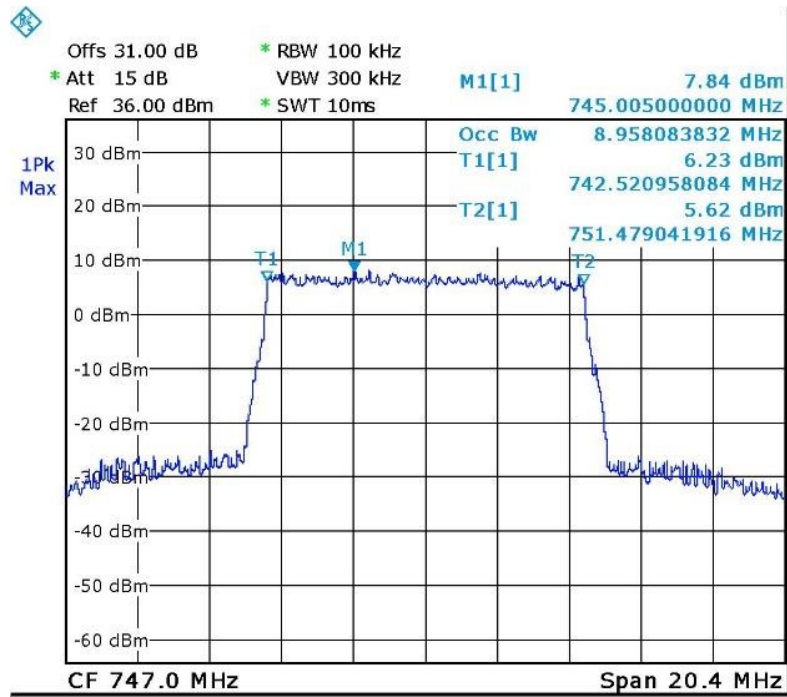

Date: 10.JUL.2016 14:46:11

Figure 25. — 64QAM 747 MHz OUT

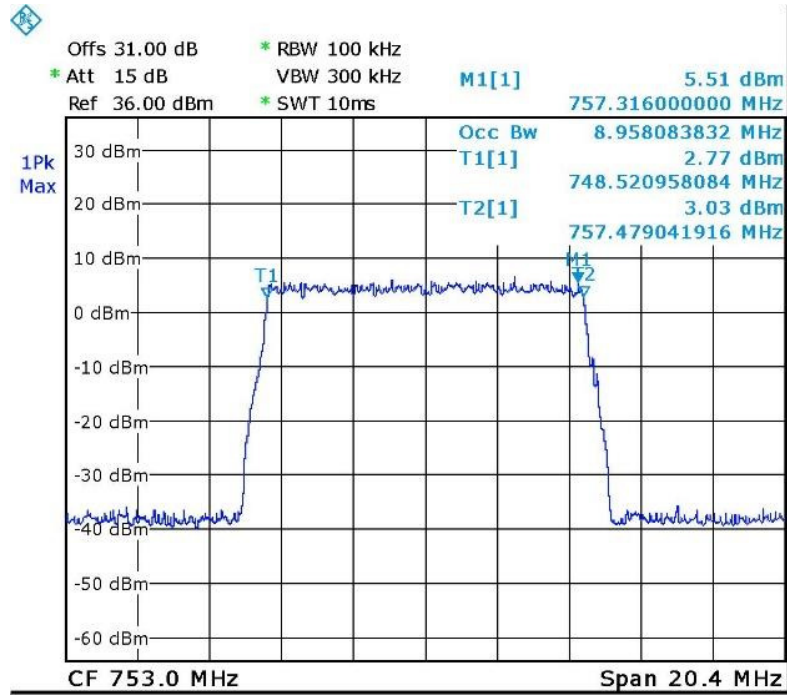

Date: 10.JUL.2016 14:52:56

Figure 26. — 64QAM 753 MHz IN

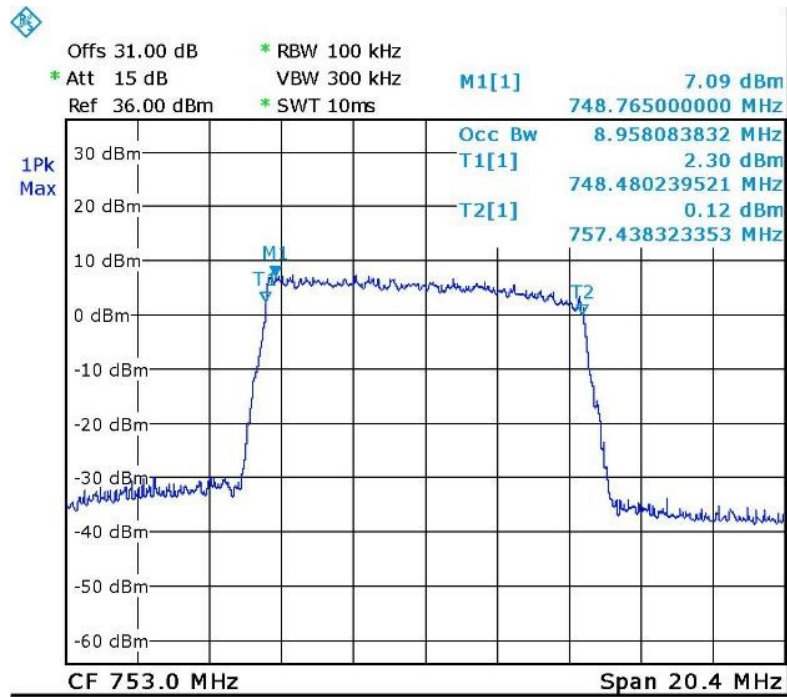

Date: 10.JUL.2016 14:45:36

Figure 27. — 64QAM 753 MHz OUT

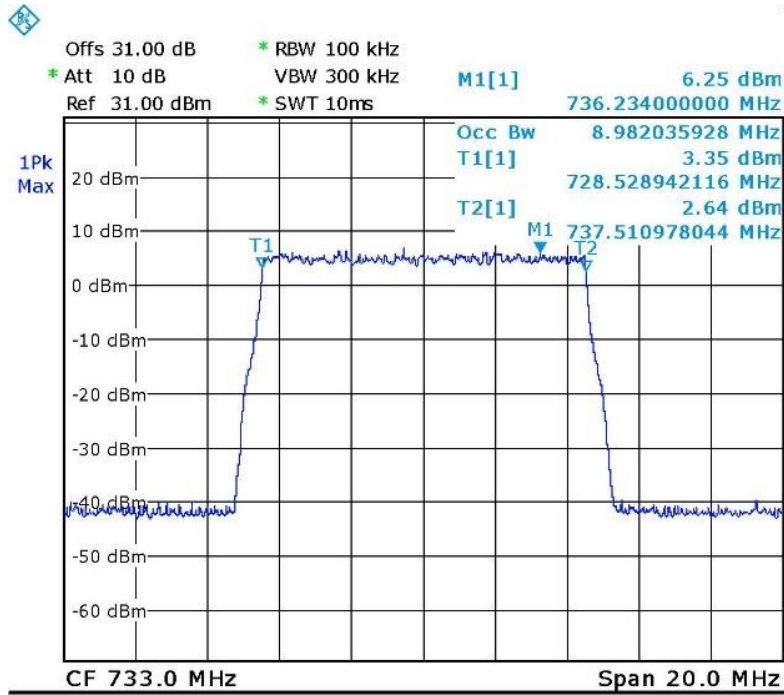

Date: 11.JUL.2016 09:53:38

Figure 28. — 16QAM 733 MHz IN

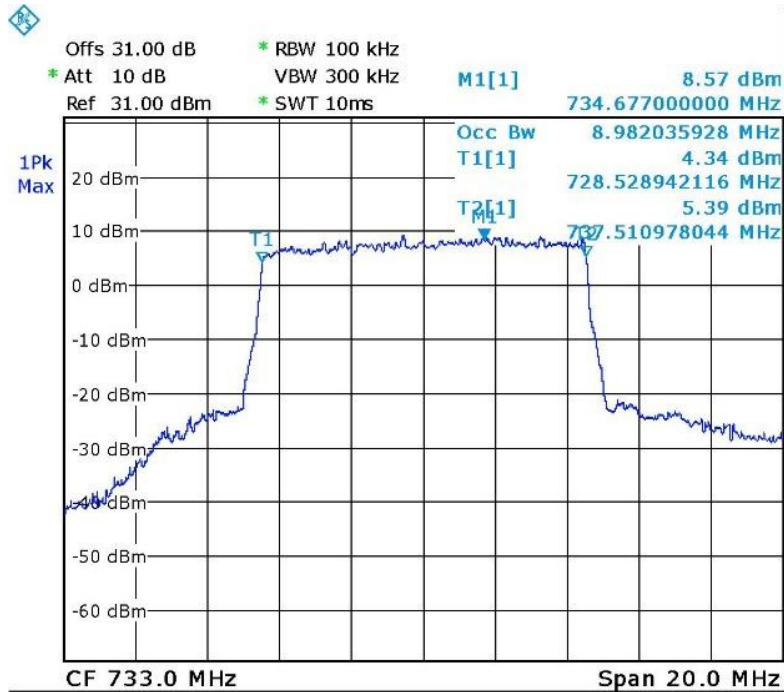

Date: 11.JUL.2016 09:32:16

Figure 29. — 16QAM 733 MHz OUT

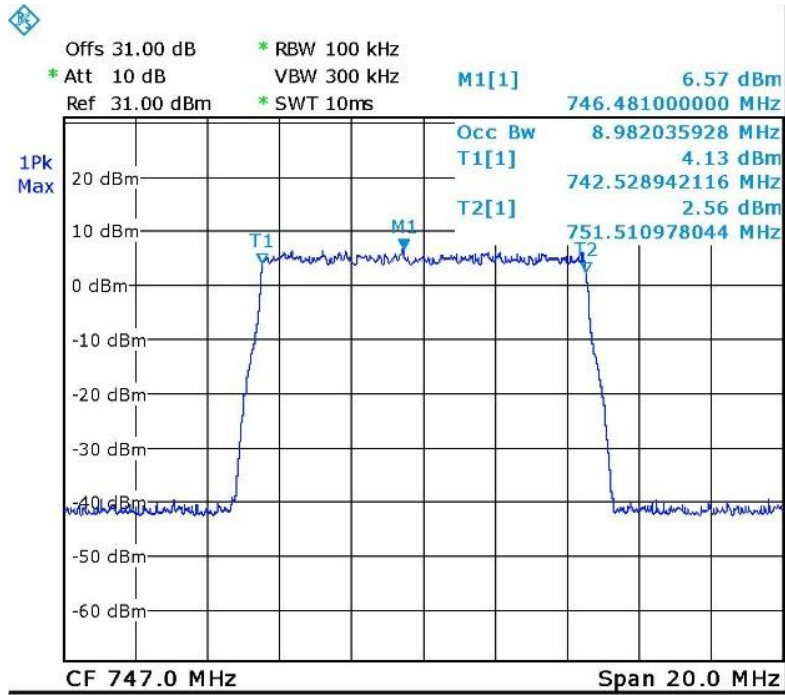

Date: 11.JUL.2016 09:53:02

Figure 30. — 16QAM 747 MHz IN

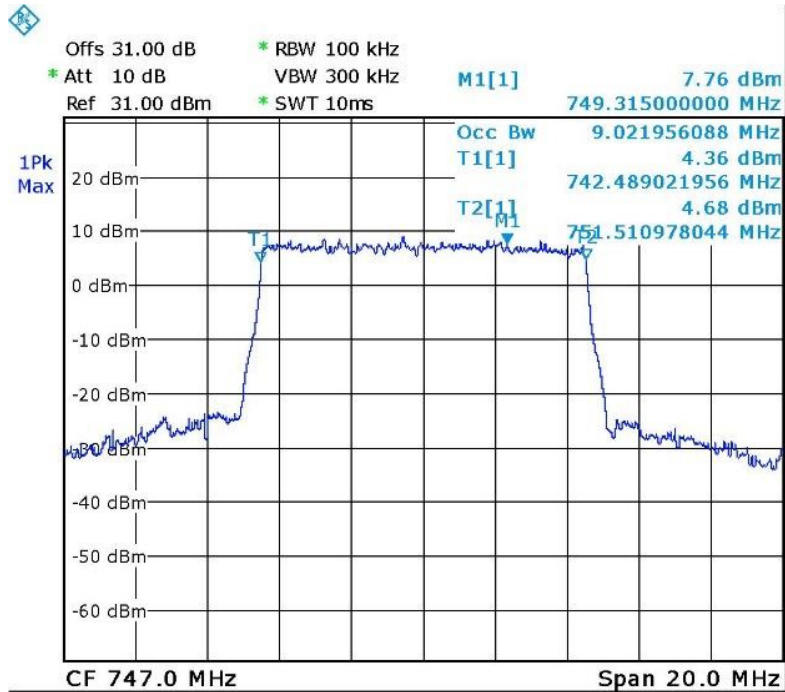

Date: 11.JUL.2016 09:33:36

Figure 31. — 16QAM 747 MHz OUT

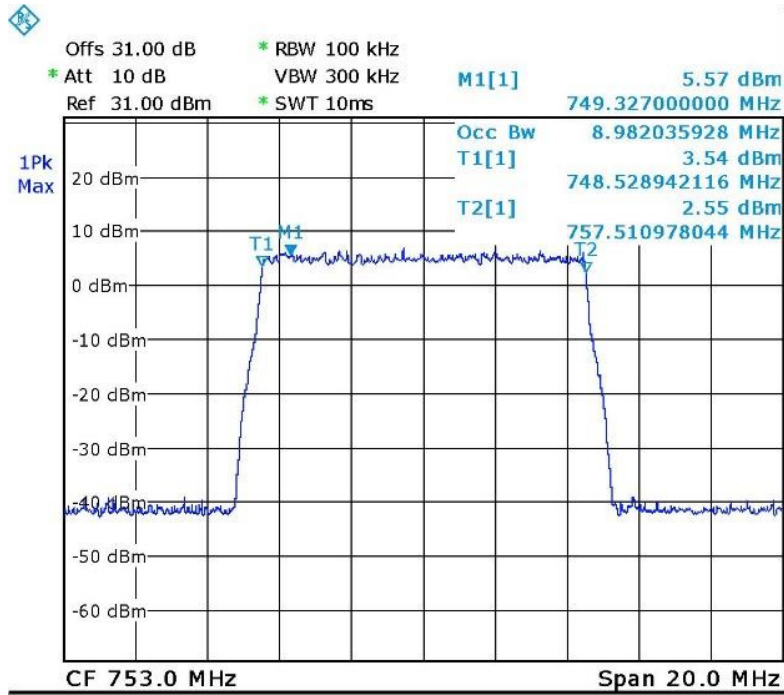

Date: 11.JUL.2016 09:52:20

Figure 32. — 16QAM 753 MHz IN

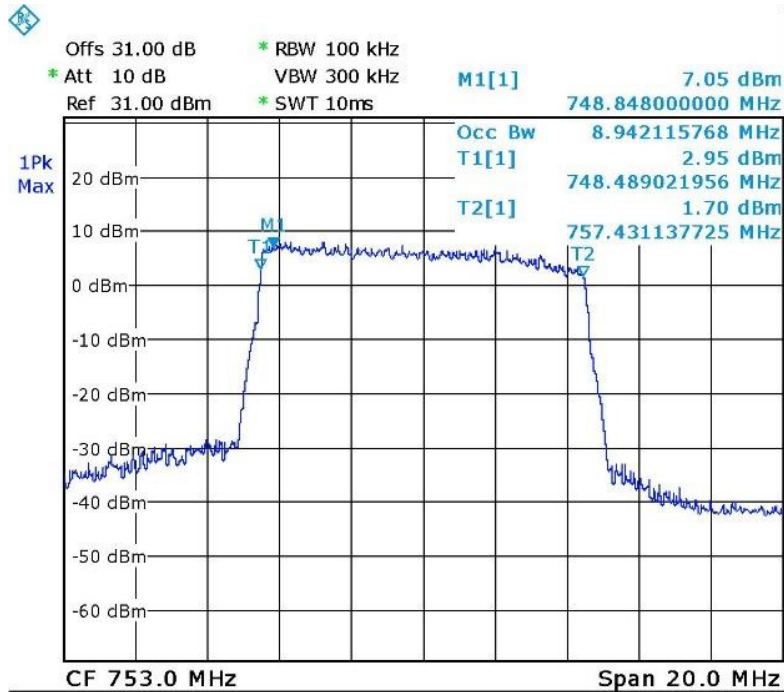

Date: 11.JUL.2016 09:34:13

Figure 33. — 16QAM 753 MHz OUT

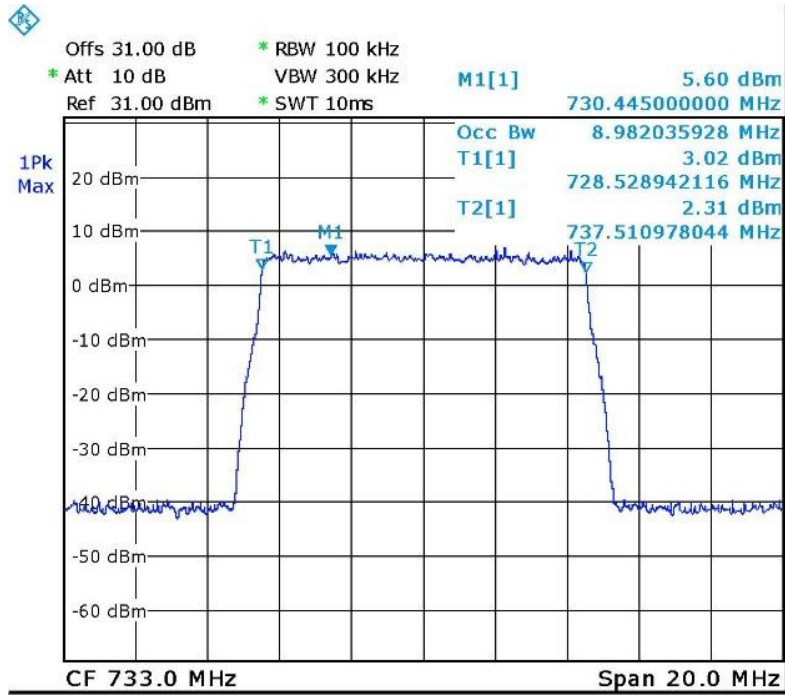

Date: 11.JUL.2016 09:39:50

Figure 34. — QPSK 733 MHz IN

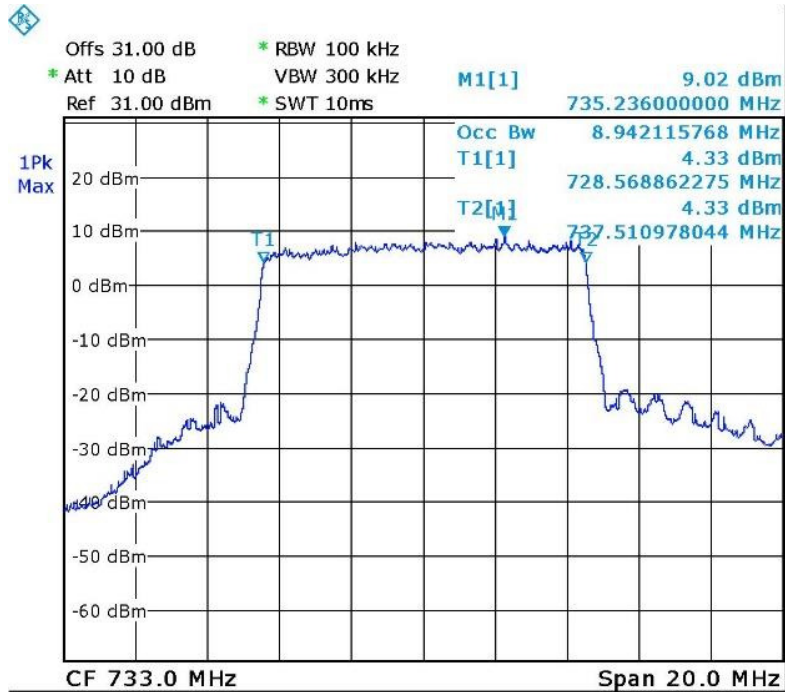

Date: 11.JUL.2016 09:36:39

Figure 35. — QPSK 733 MHz OUT

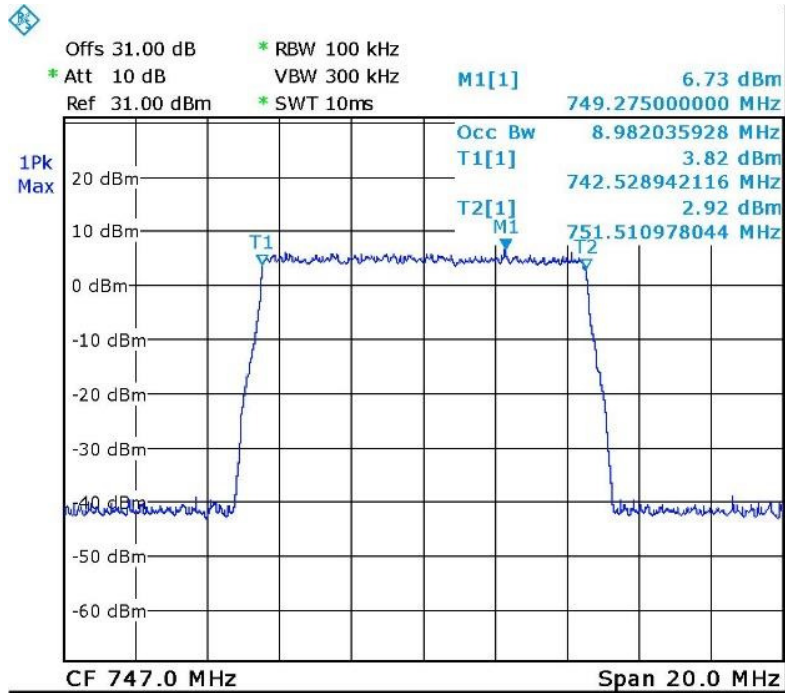

Date: 11.JUL.2016 09:40:28

Figure 36. — QPSK 747 MHz IN

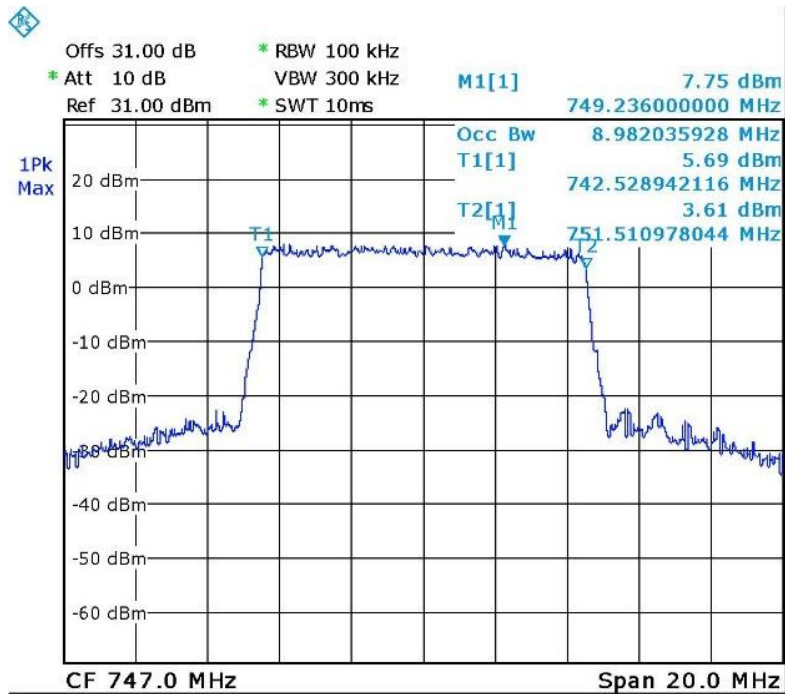

Date: 11.JUL.2016 09:35:43

Figure 37. — QPSK 747 MHz OUT

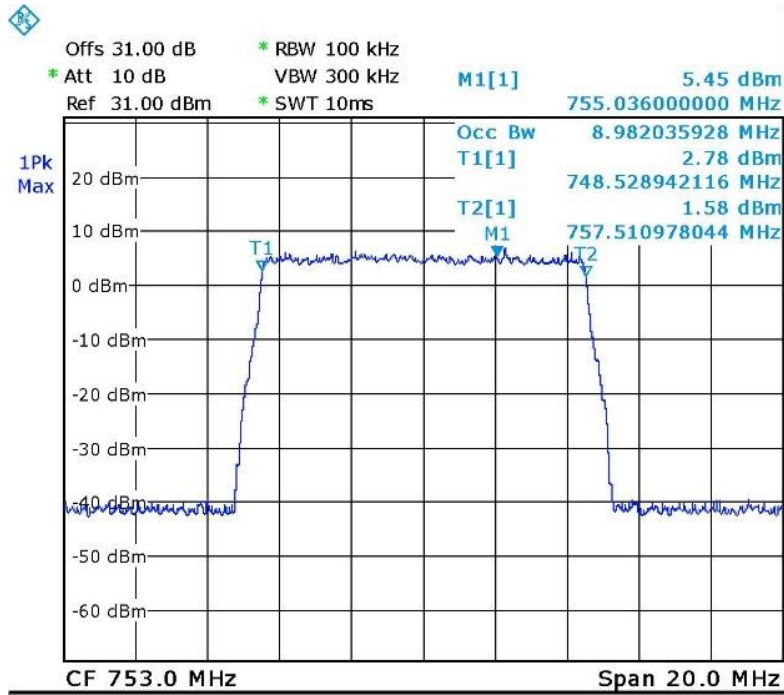

Date: 11.JUL.2016 09:41:34

Figure 38. — QPSK 753 MHz IN

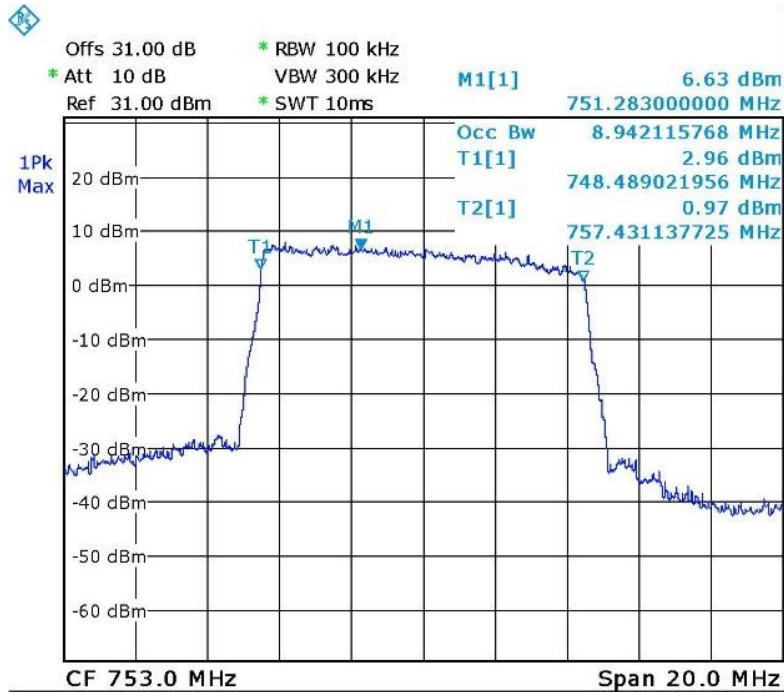

Date: 11.JUL.2016 09:35:09

Figure 39. — QPSK 753 MHz OUT



5.5 Test Equipment Used; Occupied Bandwidth LTE

Instrument	Manufacturer	Model	Serial Number	Calibration	
				Last Calibration Date	Next Calibration Due
Spectrum Analyzer	R&S	FSL6	100194	February 29, 2016	March 1, 2017
Vector Signal Generator	Agilent	N5172B	MY51350584	July 1, 2016	July 1, 2017
30 dB Attenuator	MCL	BW-S30W5	533	July 5, 2016	July 5, 2017

Figure 40 Test Equipment Used



6. Spurious Emissions at Antenna Terminals LTE

6.1 Test Specification

FCC Part 27, Subpart C, Sections 27.53(c)(1) (3) 27.53 (g)

6.2 Test Procedure

(Temperature (23°C)/ Humidity (36%RH))

The E.U.T. antenna terminal was connected to the spectrum analyzer through an external attenuator and an appropriate coaxial cable (max loss=31.5dB).

The spectrum analyzer was set to 1 kHz R.B.W for the frequency range of 9 kHz – 1 MHz, 100 kHz for the frequency range of 1 – 30 MHz, and 1 MHz for the frequency range of 30 MHz – 10 GHz.

6.3 Test Limit

The power of any emission outside of the authorized operating frequency ranges (728 -758 MHz) must be attenuated below the transmitting power (P) by a factor of $43 + 10 \log (P)$ dB.

6.4 Test Results

JUDGEMENT: Passed

See additional information in Figure 41 to *Figure 49*.

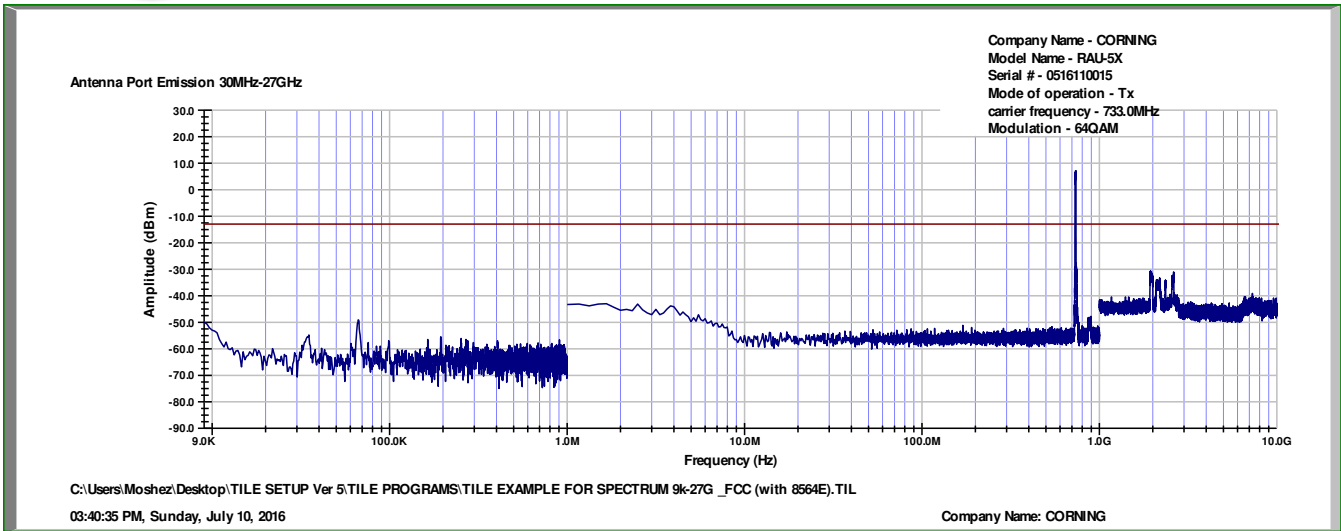

Figure 41 Spurious Emissions at Antenna Terminals 64QAM, 733MHz

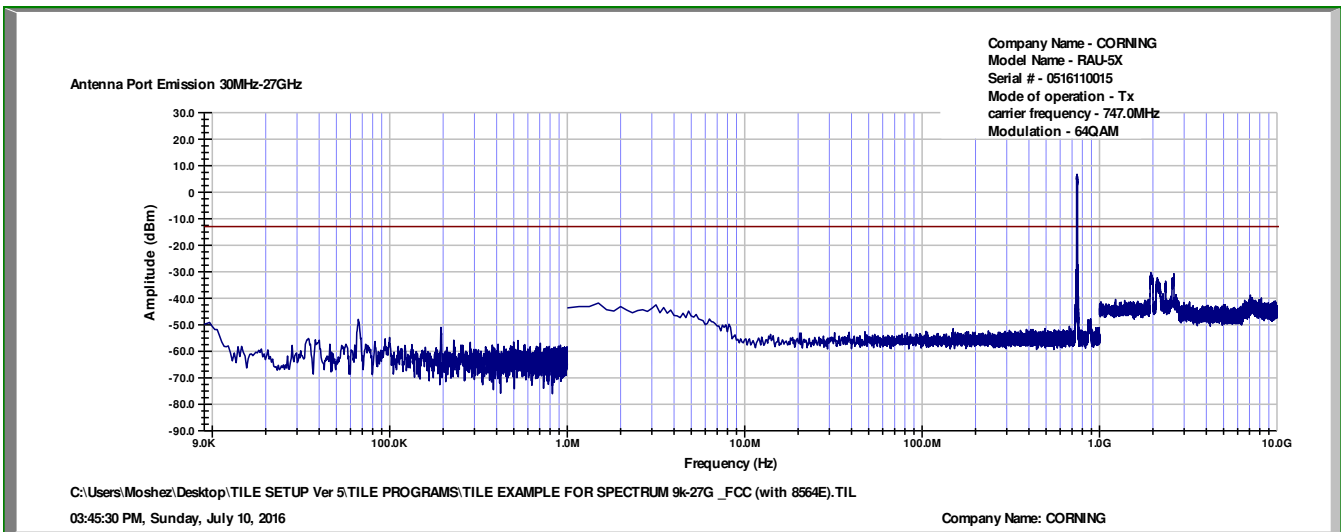

Figure 42 Spurious Emissions at Antenna Terminals 64QAM, 747MHz

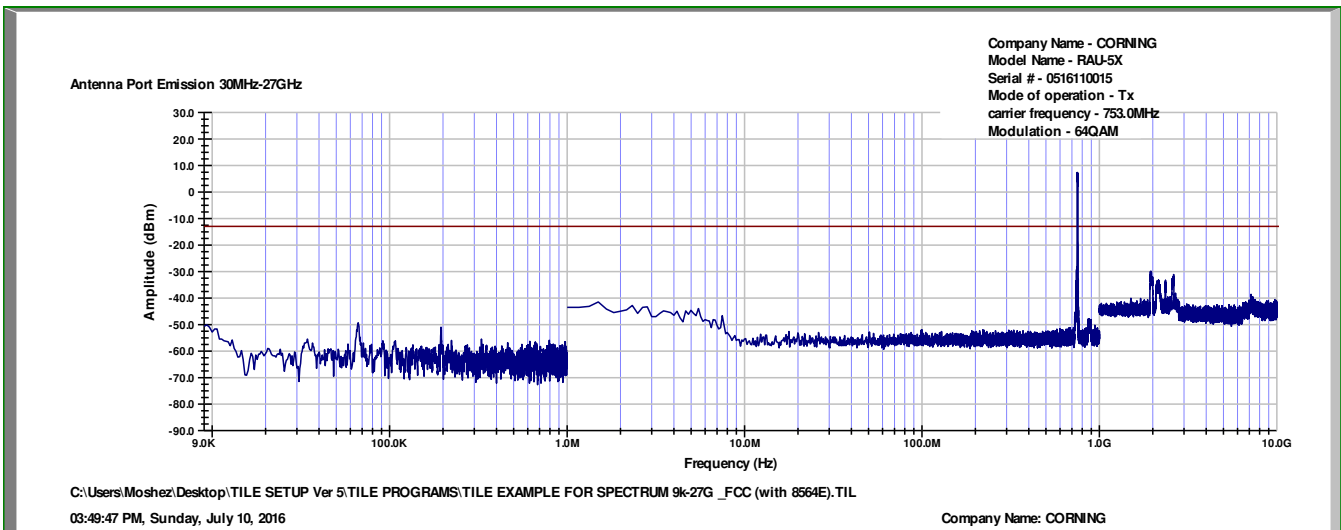

Figure 43 Spurious Emissions at Antenna Terminals 64QAM, 753MHz

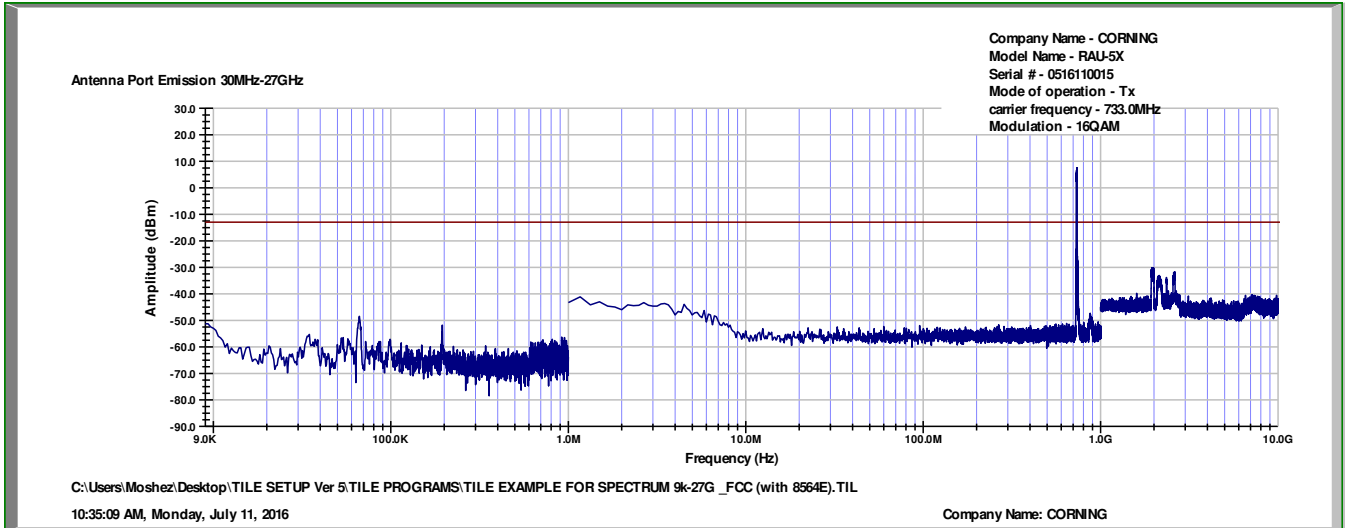

Figure 44 Spurious Emissions at Antenna Terminals 16QAM, 733MHz

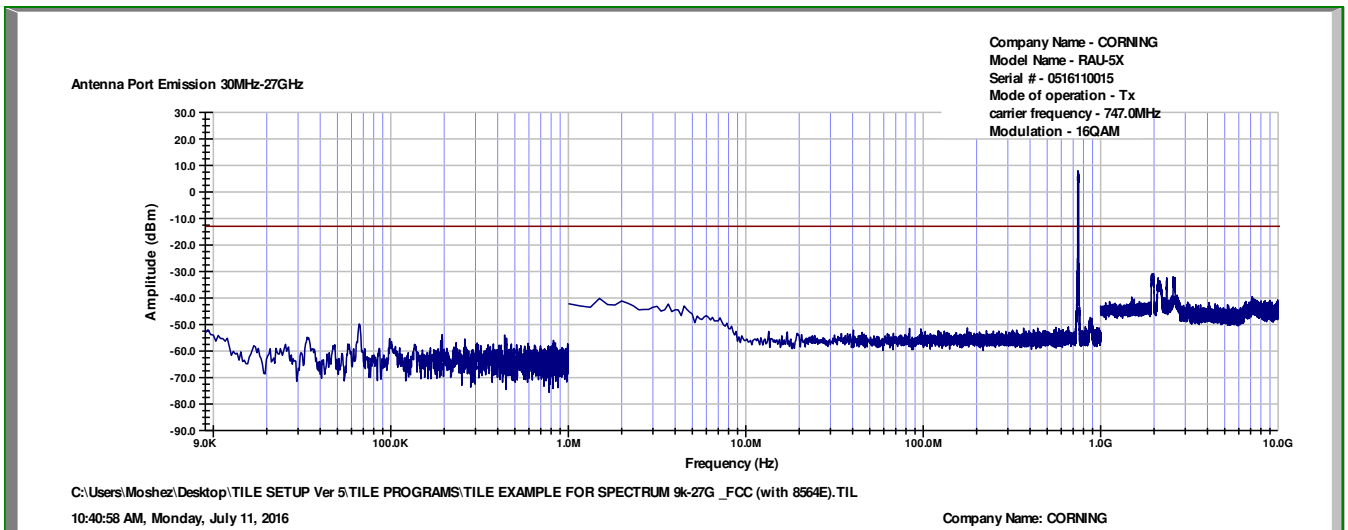

Figure 45 Spurious Emissions at Antenna Terminals 16QAM, 747MHz

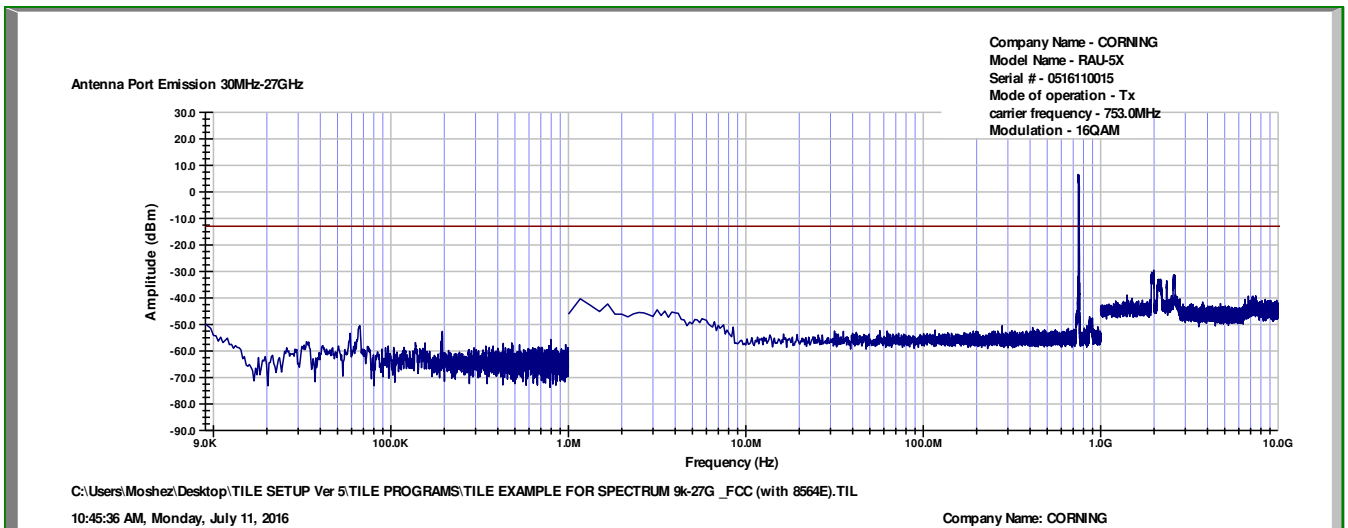

Figure 46 Spurious Emissions at Antenna Terminals 16QAM, 753MHz

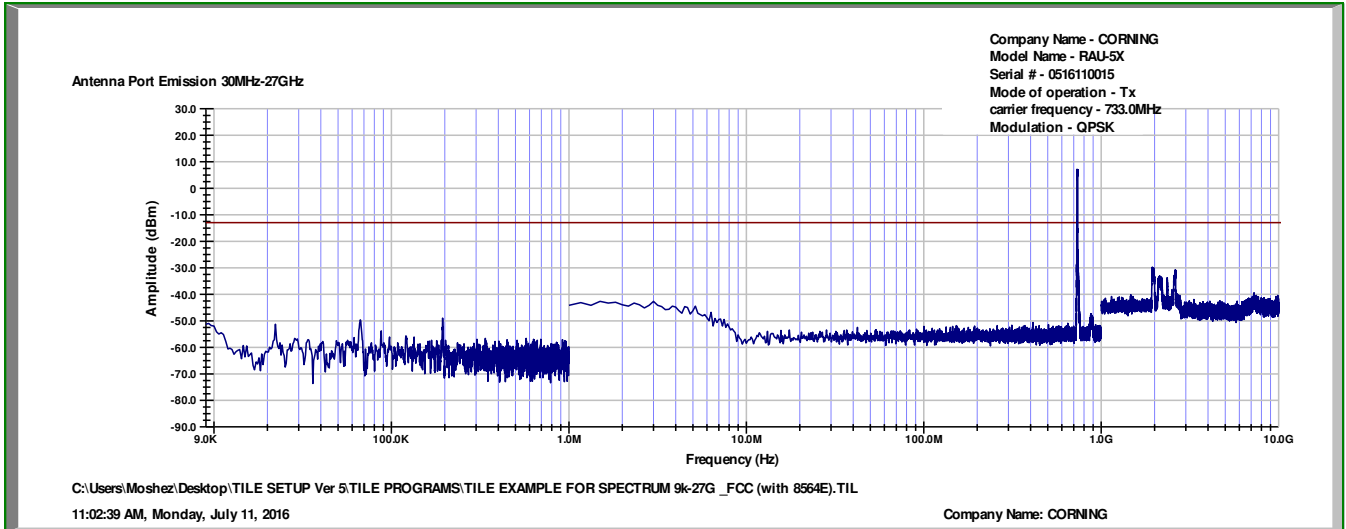

Figure 47 Spurious Emissions at Antenna Terminals QPSK, 733MHz

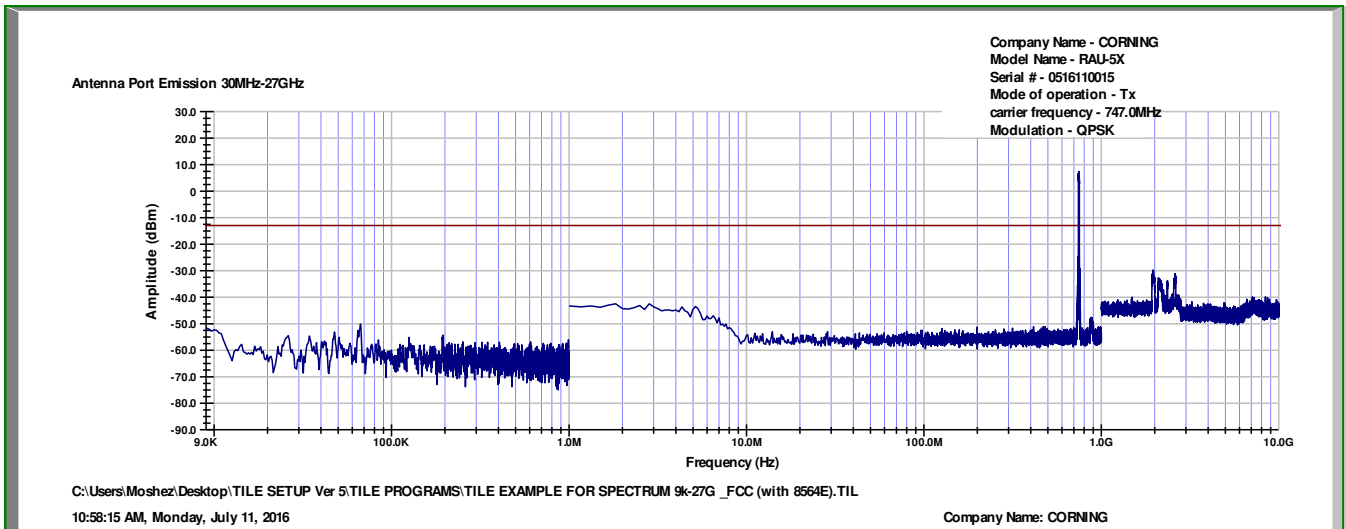

Figure 48 Spurious Emissions at Antenna Terminals QPSK, 747MHz

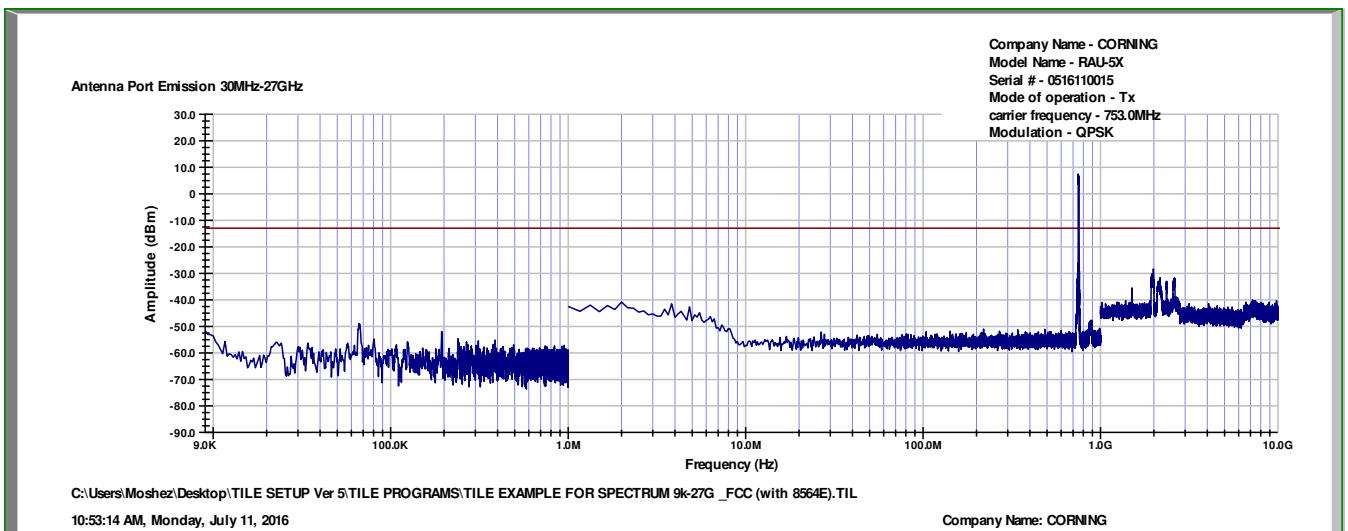

Figure 49 Spurious Emissions at Antenna Terminals QPSK, 753MHz



6.5 Test Equipment Used; Spurious Emissions at Antenna Terminals LTE

Instrument	Manufacturer	Model	Serial Number	Calibration	
				Last Calibration Date	Next Calibration Due
EXG Vector Signal Generator	Agilent	N5172B	MY51350584	July 1, 2016	July 1, 2017
Spectrum Analyzer	HP	8592L	3826A01204	March 13, 2016	March 13, 2017
30 dB Attenuator	MCL	BW-S30W5	533	July 5, 2016	July 5, 2017

Figure 50 Test Equipment Used

7. Band Edge Spectrum LTE

7.1 Test Specification

FCC Part 27, Subpart C, Section 27.53 (c)(1)

7.2 Test procedure

(Temperature (22°C)/ Humidity (35%RH))

The E.U.T. antenna terminal was connected to the spectrum analyzer through an external attenuator and an appropriate coaxial cable (31.0 dB).

The spectrum analyzer was set to 100 kHz R.B.W.

7.3 Test Limit

The power of any emission outside of the authorized operating frequency ranges (728 - 758 MHz) must be attenuated below the transmitting power (P) by a factor of at least $43 + \log(P)$ dB, yielding -13dBm.

7.4 Test Results

Modulation	Operation Frequency (MHz)	Band Edge Frequency (MHz)	Reading (dBm)	Limit (dBm)	Margin (dB)
LTE64QAM	733.0	728.0	-19.5	-13.0	-6.5
LTE64QAM	753.0	758.0	-20.8	-13.0	-7.8
LTE16QAM	733.0	728.0	-21.1	-13.0	-8.1
LTE16QAM	753.0	758.0	-25.1	-13.0	-12.1
LTEQPSK	733.0	728.0	-23.2	-13.0	-10.2
LTEQPSK	753.0	758.0	-24.2	-13.0	-11.2

Figure 51 Band Edge Spectrum Results LTE

JUDGEMENT: Passed by 6.5 dB

See additional information in *Figure 52* to *Figure 57*.

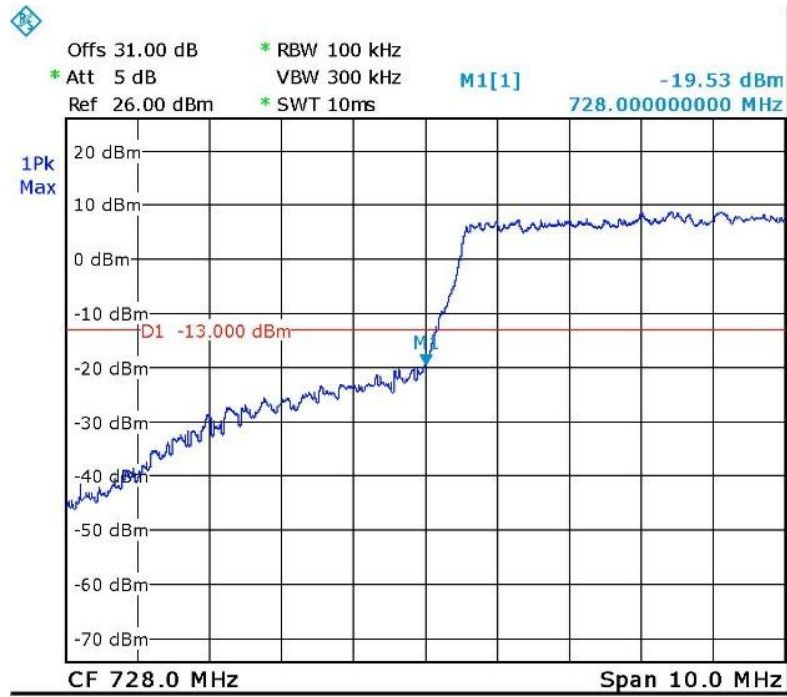

Date: 10.JUL.2016 15:00:18

Figure 52.—64QAM 733.0 MHz

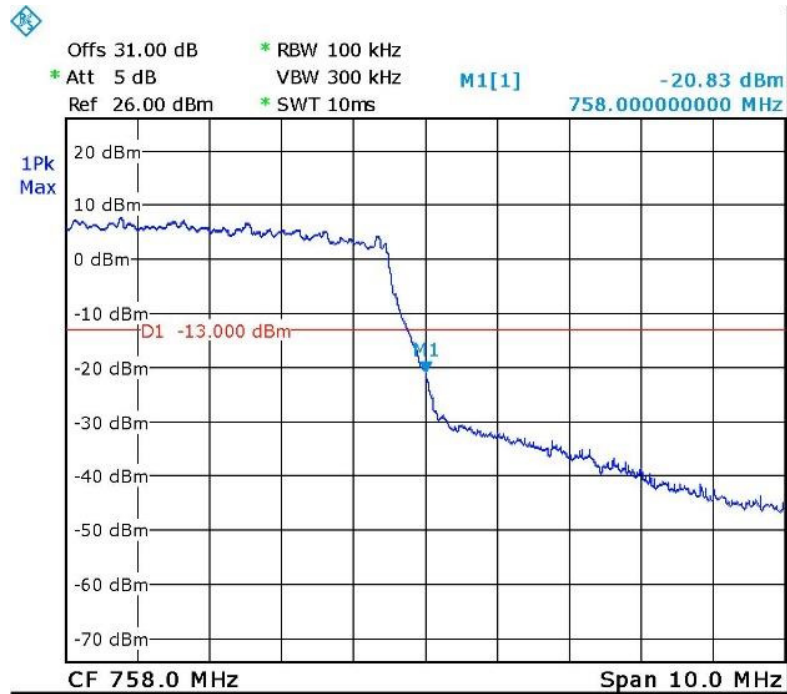

Date: 10.JUL.2016 14:58:06

Figure 53. — 64QAM 753.0 MHz

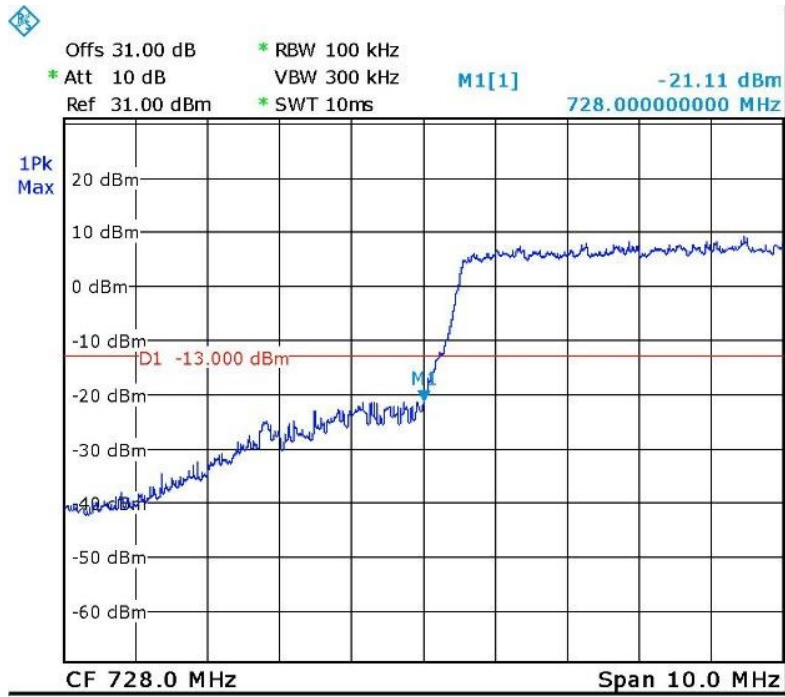

Date: 10.JUL.2016 15:37:48

Figure 54.—16QAM 733.0 MHz

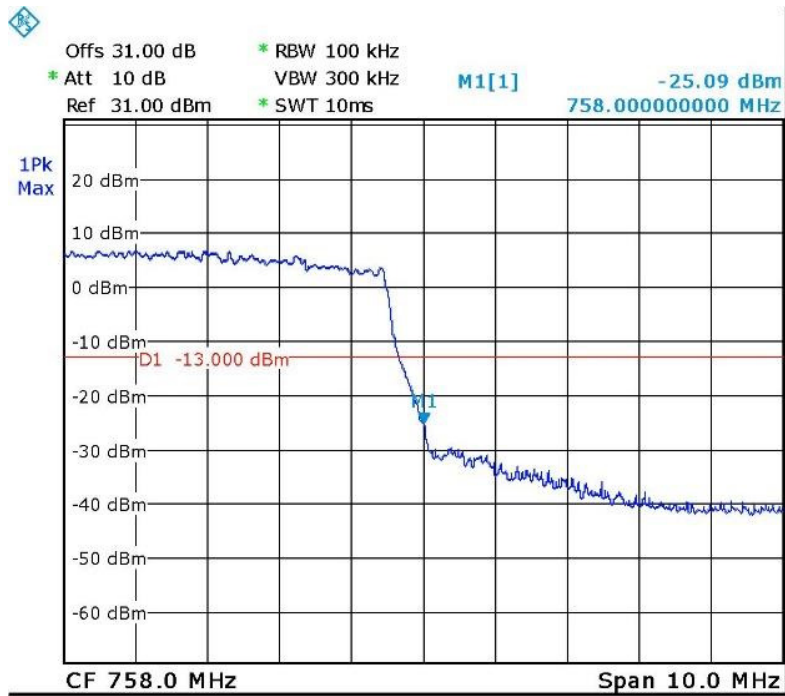

Date: 10.JUL.2016 15:36:35

Figure 55. — 16QAM 753.0 MHz

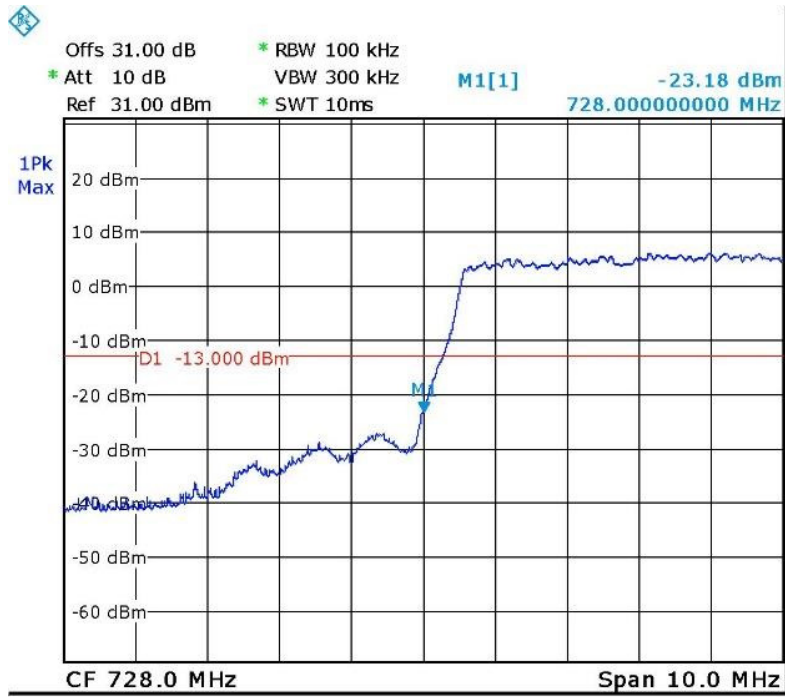

Date: 10.JUL.2016 15:34:07

Figure 56. — QPSK 733.0 MHz

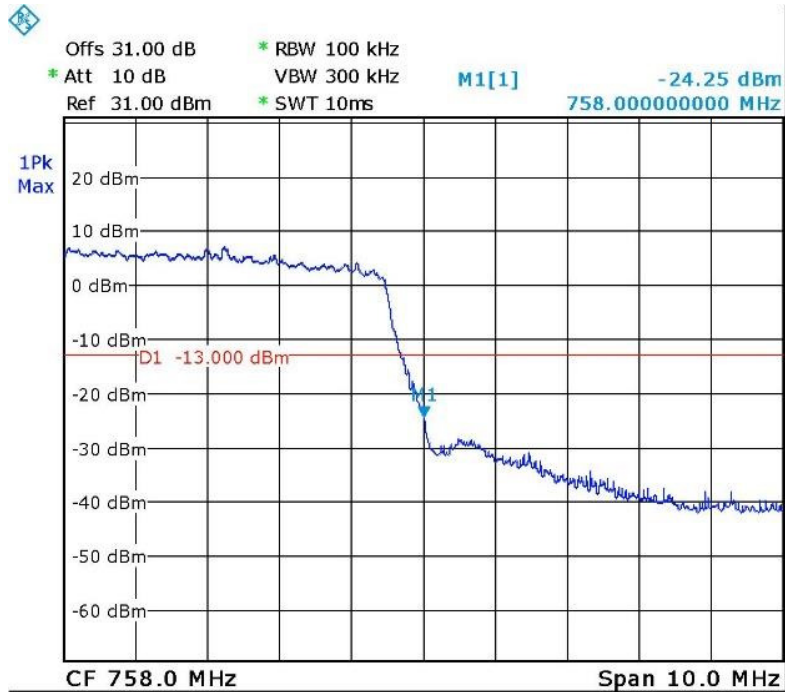

Date: 10.JUL.2016 15:35:21

Figure 57. — QPSK 753.0 MHz



7.5 Test Equipment Used; Band Edge Spectrum LTE

Instrument	Manufacturer	Model	Serial Number	Calibration	
				Last Calibration Date	Next Calibration Due
Spectrum Analyzer	R&S	FSL6	100194	February 29, 2016	March 1, 2017
Vector Signal Generator	Agilent	N5172B	MY51350584	July 1, 2016	July 1, 2017
30 dB Attenuator	MCL	BW-S30W5	533	July 5, 2016	July 5, 2017

Figure 58 Test Equipment Used



8. Spurious Radiated Emission LTE

8.1 Test Specification

FCC, Part 27, Subpart C, Section 27.53 (g)

8.2 Test Procedure

(Temperature (27°C)/ Humidity (68%RH))

The test method was based on ANSI/TIA-603-D: 2010, Section 2.2.12 Unwanted Emissions: Radiated Spurious.

For measurements between 0.009MHz-30.0MHz:

The E.U.T was tested inside the shielded room at a distance of 3 meters and the E.U.T was placed on a non-metallic table, 1.5 meters above the ground. The frequency range 0.009MHz-30MHz was scanned. The readings were maximized by the turntable azimuth between 0-360°, and the antenna polarization.

The emissions were measured at a distance of 3 meters.

For measurements between 30.0MHz-1.0GHz:

A preliminary measurement to characterize the E.U.T was performed inside the shielded room at a distance of 3 meters, using peak detection mode and broadband antennas. The preliminary measurements produced a list of the highest emissions. The E.U.T was then transferred to the open site, and placed on a remote-controlled turntable. The E.U.T was placed on a non-metallic table, 0.8 meters above the ground. The frequency range 30.0MHz -1.0GHz was scanned and the list of the highest emissions was verified and updated accordingly.

The readings were maximized by adjusting the antenna height between 1-4 meters, the turntable azimuth between 0-360°, and the antenna polarization.

The emissions were measured at a distance of 3 meters.

For measurements between 1.0GHz-10.0GHz:

The E.U.T was tested inside the shielded room at a distance of 3 meters and the E.U.T was placed on a non-metallic table, 1.5 meters above the ground. The frequency range 1.0GHz -10.0GHz was scanned. The readings were maximized by the turntable azimuth between 0-360°, and the antenna polarization.

The emissions were measured at a distance of 3 meters.

The E.U.T. was replaced by a substitution antenna (dipole 30MHz-1GHz, Horn Antenna above 1GHz) driven by a signal generator. The height was readjusted for maximum reading. The signal generator level was adjusted to obtain the same reading on the EMI receiver as in step (a).

The signals observed in step (a) were converted to radiated power using:

$$P_d(\text{dBm}) = P_g(\text{dBm}) - \text{Cable Loss (dB)} + \text{Substitution Antenna Gain (dBd)}$$

P_d = Dipole equivalent power (result).

P_g = Signal generator output level.

A Peak detector was used for this test.

The test was performed in 3 operation frequencies: low mid and high.

Testing was performed when the RF port was connected to 50 Ω termination.

The table below describe only results with the highest radiation.



8.3 Test Limit

The power of any emission outside of the authorized operating frequency ranges (728-758MHz) must be attenuated below the transmitting power (P) by a factor of at least $43 + 10 \log (P)$ dB, yielding -13dBm.

8.4 Test Results

Carrier Channel	Freq.	Antenna Pol.	Maximum Peak Level	Signal Generator RF Output	Cable Loss	Antenna Gain	Effective Radiated Power Level	Limit	Margin
(MHz)	(MHz)	(V/H)	(dB μ V/m)	(dBm)	(dB)	(dBd)	(dBm)	(dBm)	(dB)
733.0	1466.0	V	50.3	-49.3	0.5	6.0	-43.8	-13.00	-30.8
	1466.0	H	50.4	-49.2	0.5	6.0	-43.7	-13.00	-30.7
747.0	1494.0	V	50.4	-49.3	0.5	6.0	-43.8	-13.00	-30.8
	1494.0	H	50.4	-49.2	0.5	6.0	-43.7	-13.00	-30.7
753.0	1506.0	V	50.5	-49.2	0.5	6.0	-43.7	-13.00	-30.7
	1506.0	H	50.6	-49.0	0.5	6.0	-43.5	-13.00	-30.5

Figure 59 Spurious Radiated Emission LTE

JUDGEMENT: Passed by 30.5dB

The E.U.T met the requirements of the FCC, Part 27, Subpart C, Section 27.53 (g) specifications.



8.5 Test Instrumentation Used; Radiated Measurements

Instrument	Manufacturer	Model	Serial Number	Calibration	
				Last Calibration Date	Next Calibration Due
EMI Receiver	HP	85422E	3906A00276	March 3, 2016	March 3, 2017
RF Filter Section	HP	85420E	3705A00248	March 3, 2016	March 3, 2017
EMI Receiver	R&S	ESCI7	100724	February 29, 2016	March 1, 2017
Spectrum Analyzer	HP	8593EM	3536A00120ADI	March 10, 2016	March 10, 2017
Active Loop Antenna	EMCO	6502	9506-2950	November 5, 2015	November 30, 2016
Antenna Biconical	EMCO	3110B	9912-3337	March 24, 2016	March 24, 2018
Antenna Log Periodic	EMCO	3146	9505-4081	April 23, 2016	April 23, 2017
Horn Antenna 1G-18G	ETS	3115	29845	May 19, 2015	May 19, 2018
Low Noise Amplifier	Narda	LNA-DBS-0411N313	013	March 1, 2015	September 30, 2016
Low Noise Amplifier	Sophia Wireless	LNA 28-B	232	March 1, 2015	September 30, 2016
MXG Vector Signal Generator	Agilent	N5182A	MY49060440	July 1, 2016	July 1, 2017
Semi Anechoic Civil Chamber	ETS	S81	SL 11643	N/A	N/A
Antenna Mast	ETS	2070-2	-	N/A	N/A
Turntable	ETS	2087	-	N/A	N/A
Mast & Table Controller	ETS/EMCO	2090	9608-1456	N/A	N/A

Figure 60 Test Equipment Used



9. Intermodulation Conducted

9.1 Test Procedure

(Temperature (22°C)/ Humidity (37%RH))

The E.U.T. antenna terminal was connected to the spectrum analyzer through an external attenuator and an appropriate coaxial cable (max loss = 40.0dB). The spectrum analyzer was set to 1 kHz resolution BW for the frequency range 9.0-150.0 kHz, 10 kHz for the frequency range 150 kHz–1.0 MHz, 100 kHz for the frequency range 1.0 MHz – 30 MHz, and 1MHz for the frequency range 30 MHz - 24GHz.

6 input signals were sent simultaneously to the E.U.T. as follows:

LTE band: 742.0 MHz, 0 dBm

CELL&ESMR band: 878.0 MHz, 0 dBm

PCS band: 1962.5 MHz, 0 dBm

AWS-3 band: 2145.0 MHz, 0 dBm

WCS band: 2355.0MHz, 0 dBm

TDD 2.5G band: 2593.0MHz, 0 dBm

The frequency range of 9 kHz – 24.0 GHz was scanned for unwanted signals.

9.2 Test Limit

The power of any emission outside of the authorized operating frequency ranges must be attenuated below the transmitting power (P) by a factor of at least $43 + 10 \log (P)$ dB, yielding -13 dBm.

9.3 Test Results

JUDGEMENT: Passed

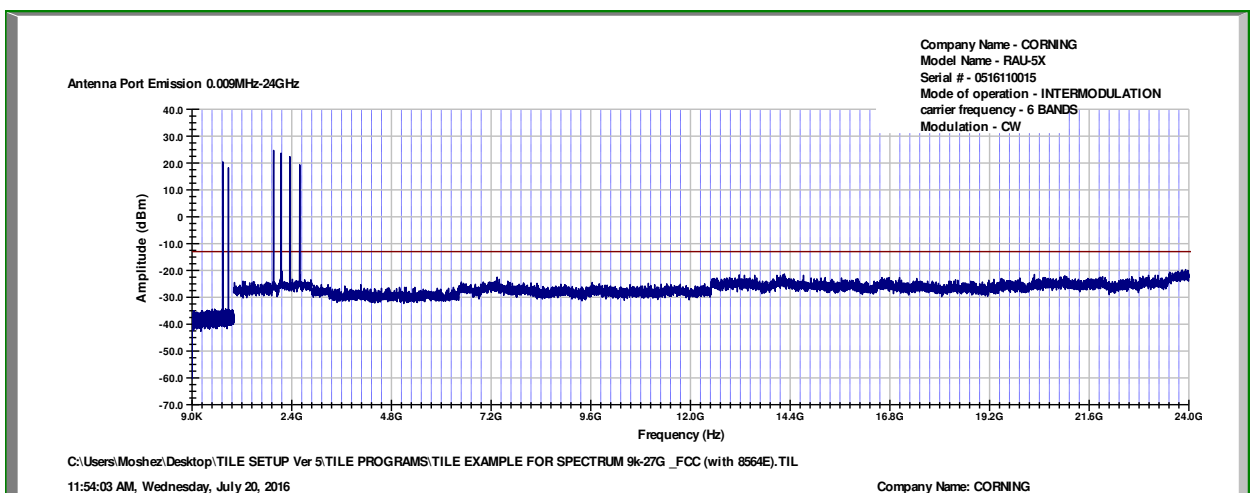

Figure 61 Intermodulation Conducted



9.4 Test Equipment Used; Intermodulation Conducted

Instrument	Manufacturer	Model	Serial Number	Calibration	
				Last Calibration Date	Next Calibration Due
Spectrum Analyzer	HP	8564E	3442A00275	March 10, 2016	March 10, 2017
EXG Vector Signal Generator	Agilent	N5172B	TE4384	July 1, 2016	July 1, 2017
EXG Vector Signal Generator	Agilent	N5172B	MY513500584	July 1, 2016	July 1, 2017
MXG Vector Signal Generator	Agilent	N5182A	MY48180244	July 1, 2016	July 1, 2017
MXG Vector Signal Generator	Agilent	N5182A	MY49060440	July 1, 2016	July 1, 2017
Signal Generator	HP	E4432B	GB40050998	July 1, 2016	July 1, 2017
ESG Vector Signal Generator	Agilent	E4438C	MY45094064	July 1, 2016	July 1, 2017
30 dB Attenuator	MCL	BW-S30W5	533	July 5, 2016	July 5, 2017
6 dB Attenuator	Weinschel Associates	WA 40-6-34	568	July 6, 2016	July 6, 2017

Figure 62 Test Equipment Used



10. Intermodulation Radiated

10.1 Test Procedure

(Temperature (27°C)/ Humidity (68%RH))

The test method was based on ANSI/TIA-603-D: 2010, Section 2.2.12 Unwanted Emissions: Radiated Spurious.

For measurements between 0.009MHz-30.0MHz:

The E.U.T was tested inside the shielded room at a distance of 3 meters and the E.U.T was placed on a non-metallic table, 1.5 meters above the ground. The frequency range 0.009MHz-30MHz was scanned. The readings were maximized by the turntable azimuth between 0-360°, and the antenna polarization.

The emissions were measured at a distance of 3 meters.

For measurements between 30.0MHz-1.0GHz:

A preliminary measurement to characterize the E.U.T was performed inside the shielded room at a distance of 3 meters, using peak detection mode and broadband antennas. The preliminary measurements produced a list of the highest emissions. The E.U.T was then transferred to the open site, and placed on a remote-controlled turntable. The E.U.T was placed on a non-metallic table, 0.8 meters above the ground. The frequency range 30.0MHz -1.0GHz was scanned and the list of the highest emissions was verified and updated accordingly.

The readings were maximized by adjusting the antenna height between 1-4 meters, the turntable azimuth between 0-360°, and the antenna polarization.

The emissions were measured at a distance of 3 meters.

For measurements between 1.0GHz-24.0GHz:

The E.U.T was tested inside the shielded room at a distance of 3 meters and the E.U.T was placed on a non-metallic table, 1.5 meters above the ground. The frequency range 1.0GHz -24.0GHz was scanned. The readings were maximized by the turntable azimuth between 0-360°, and the antenna polarization.

The emissions were measured at a distance of 3 meters.

The E.U.T. was replaced by a substitution antenna (dipole 30MHz-1GHz, Horn Antenna above 1GHz) driven by a signal generator. The height was readjusted for maximum reading. The signal generator level was adjusted to obtain the same reading on the EMI receiver as in step (a).

The signals observed in step (a) were converted to radiated power using:

$$P_d(\text{dBm}) = P_g(\text{dBm}) - \text{Cable Loss (dB)} + \text{Substitution Antenna Gain (dBd)}$$

P_d = Dipole equivalent power (result).

P_g = Signal generator output level.

6 input signals were sent simultaneously to the E.U.T. as follows:

LTE band: 742.0 MHz, 0 dBm

CELL&ESMR band: 878.0 MHz, 0 dBm

PCS band: 1962.5 MHz, 0 dBm

AWS-3 band: 2145.0MHz, 0 dBm

WCS band: 2355.0MHz, 0 dBm

TDD 2.5G band: 2593.0MHz, 0 dBm



A Peak detector was used for this test.

The test was performed in 3 operation frequencies: low, mid and high.

Testing was performed when the RF port was connected to 50 Ω termination.

The table below describe only results with the highest radiation.

10.2 Test Limit

The power of any emission outside of the authorized operating frequency ranges (MHz) must be attenuated below the transmitting power (P) by a factor of at least $43 + 10 \log (P)$ dB, yielding -13dBm.

10.3 Test Results

JUDGEMENT: Passed

Freq.	Antenna Pol.	Maximum Peak Level	Signal Generator RF Output	Cable Loss	Antenna Gain	Effective Radiated Power Level	Limit	Margin
(MHz)	(V/H)	(dBμV/m)	(dBm)	(dB)	(dBd)	(dBm)	(dBm)	(dB)
1009.0	V	50.0	-49.6	0.5	6.0	-44.1	-13.0	-31.1
1009.0	H	50.0	-49.2	0.5	6.0	-43.7	-13.0	-30.7
1332.0	V	50.3	-49.1	0.5	6.0	-43.6	-13.0	-30.6
1332.0	H	50.2	-49.2	0.5	6.0	-43.7	-13.0	-30.7
1372.5	V	50.4	-49.1	0.5	6.0	-43.6	-13.0	-30.6
1372.5	H	50.3	-49.2	0.5	6.0	-43.7	-13.0	-30.7
2093.5	V	50.5	-50.2	0.5	7.0	-43.7	-13.0	-30.7
2093.5	H	50.4	-49.6	0.5	7.0	-43.1	-13.0	-30.1
2565.0	V	53.7	-47.0	0.5	7.0	-40.5	-13.0	-27.5
2565.0	H	53.4	-46.6	0.5	7.0	-40.1	-13.0	-27.1
3223.5	V	56.4	-48.5	0.5	10.0	-39.0	-13.0	-26
3223.5	H	56.3	-48.2	0.5	10.0	-38.7	-13.0	-25.7
3413.0	V	56.5	-48.5	0.5	10.0	-39.0	-13.0	-26
3413.0	H	56.5	-48.2	0.5	10.0	-38.7	-13.0	-25.7
3832.0	V	56.2	-42.7	0.5	9.5	-33.7	-13.0	-20.7
3832.0	H	56.3	-42.4	0.5	9.5	-33.4	-13.0	-20.4
4444.0	V	56.5	-42.3	0.5	9.5	-33.3	-13.0	-20.3
4444.0	H	56.6	-42.1	0.5	9.5	-33.1	-13.0	-20.1
5099.0	V	56.9	-46.2	0.5	10.8	-35.9	-13.0	-22.9
5099.0	H	56.7	-45.0	0.5	10.8	-34.7	-13.0	-21.7

Figure 63 Intermodulation Radiated Results



10.4 Test Instrumentation Used; Radiated Measurements Intermodulation

Instrument	Manufacturer	Model	Serial Number	Calibration	
				Last Calibration Date	Next Calibration Due
EMI Receiver	HP	85422E	3906A00276	March 3, 2016	March 3, 2017
RF Filter Section	HP	85420E	3705A00248	March 3, 2016	March 3, 2017
EMI Receiver	R&S	ESCI7	100724	February 29, 2016	March 1, 2017
Spectrum Analyzer	HP	8593EM	3536A00120ADI	March 10, 2016	March 10, 2017
Active Loop Antenna	EMCO	6502	9506-2950	November 5, 2015	November 30, 2016
Antenna Biconical	EMCO	3110B	9912-3337	March 24, 2016	March 24, 2018
Antenna Log Periodic	EMCO	3146	9505-4081	April 23, 2016	April 23, 2017
Horn Antenna 1G-18G	ETS	3115	29845	May 19, 2015	May 19, 2018
Horn Antenna 18G-26G	ARA	SWH-28	1007	March 30, 2014	September 30, 2016
Low Noise Amplifier	Narda	LNA-DBS-0411N313	013	March 1, 2015	September 30, 2016
Low Noise Amplifier	Sophia Wireless	LNA 28-B	232	March 1, 2015	September 30, 2016
Signal Generator	Marconi	2022D	119196015	March 1, 2016	March 1, 2017
Signal Generator	HP	8648C	3623A04126	February 29, 2016	March 1, 2017
Signal Generator	HP	ESG-4000A/E4422A	US36220118	February 29, 2016	March 1, 2017
MXG Vector Signal Generator	Agilent	N5182A	MY49060440	July 1, 2016	July 1, 2017
ESG Vector Signal Generator	Agilent	E4438C	MY45094064	July 1, 2016	July 1, 2017
Signal Generator	Agilent	E4432B	GB40050998	July 1, 2016	July 1, 2017
Semi Anechoic Civil Chamber	ETS	S81	SL 11643	N/A	N/A
Antenna Mast	ETS	2070-2	-	N/A	N/A
Turntable	ETS	2087	-	N/A	N/A
Mast & Table Controller	ETS/EMCO	2090	9608-1456	N/A	N/A

Figure 64 Intermodulation Radiated Results



11. Out-of-Band Rejection (LTE)

11.1 Test Specification

KDB 935210 D05 v01r01, Section 3.3

11.2 Test Procedure

(Temperature (21°C)/ Humidity (35%RH))

The E.U.T. antenna terminal was connected to the spectrum analyzer through an external attenuator and an appropriate coaxial cable (max Loss= 31.0 dB).

The signal and spectrum analyzer frequency range was set to $\pm 250\%$ of the passband, Dwell time set to approximately 10msec.

RBW was set between 1% to 5% of the E.U.T passband and VBW set to $\geq 3 * RBW$.

11.3 Test Limit

N/A

11.4 Test Results

JUDGEMENT: Passed

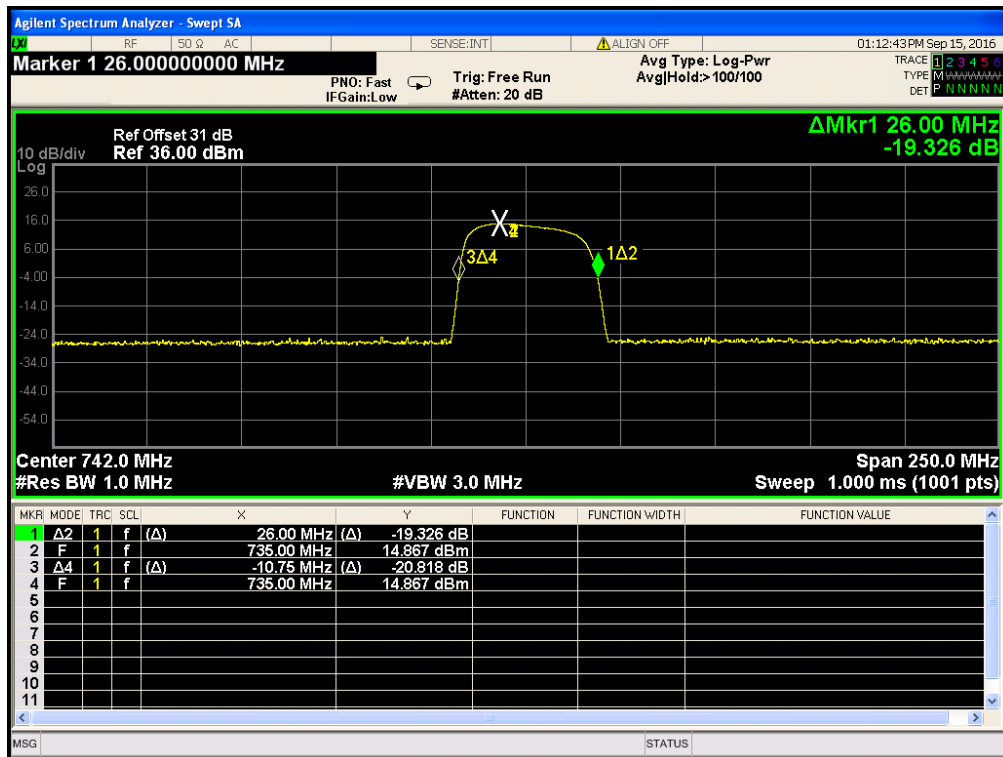

Figure 65. — Out-of-Band Rejection Plot



11.5 Test Equipment Used; Out-of-Band Rejection

Instrument	Manufacturer	Model	Serial Number	Calibration	
				Last Calibration Date	Next Calibration Date
EXA Spectrum Analyzer	Agilent	N9010A	MY48030391	March 16, 2016	March 16, 2018
EXG Vector Signal Generator	Agilent	N5172B	MY49060440	November 19, 2014	November 19, 2017
30 dB Attenuator	MCL	BW-S30W5	533	July 5, 2016	July 5, 2017

Figure 66 Test Equipment Used



12. APPENDIX A - CORRECTION FACTORS

12.1 Correction factors for *RF OATS Cable 35m* *ITL #1784*

Frequency (MHz)	Cable loss (dB)
10.0	0.3
20.0	0.2
50.0	-0.1
100.0	-0.6
200.0	-1.2
500.0	-2.3
1000.0	-3.6



12.2 Correction factors for RF OATS Cable 10m
ITL #1794

Frequency(MHz)	Cable loss(dB)
10.0	-0.3
20.0	-0.3
50.0	-0.5
100.0	-0.7
200.0	-1.1
500.0	-1.8
1000.0	-2.7



12.3 Correction factors for

**Horn Antenna
Model: SWH-28
at 1 meter range.**

FREQUENCY (GHz)	AFE (dB /m)	Gain (dB1)
18.0	40.3	16.1
19.0	40.3	16.3
20.0	40.3	16.1
21.0	40.3	16.3
22.0	40.4	16.8
23.0	40.5	16.4
24.0	40.5	16.6
25.0	40.5	16.7
26.0	40.6	16.4



12.4 Correction factors for Horn ANTENNA
Model: 3115
Antenna serial number: 29845
3 meter range

f(GHz)	AF(dB/m)	GA(dB)
0.75	25	3
1G	23.5	7
1.5G	26	8
2G	29	7
2.5G	27.5	10
3G	30	10
3.5G	31.5	10
4G	32.5	9.5
4.5G	32.5	10.5
5G	33	10.5
5.5G	35	10.5
6G	36.5	9.5
6.5G	36.5	10
7G	37.5	10
7.5G	37.5	10
8G	37.5	11
8.5G	38	11
9G	37.5	11.5
9.5G	38	11.5
10G	38.5	11.5
10.5G	38.5	12
11G	38.5	12.5
11.5G	38.5	13
12G	38	13.5
12.5G	38.5	13
13G	40	12
13.5G	41	12
14G	40	13
14.5G	39	14
15G	38	15.5
15.5G	37.5	16
16G	37.5	16
16.5G	39	15
17G	40	15
17.5G	42	13.5
18G	42.5	13



**12.5 Correction factors for Log Periodic Antenna
EMCO, Model 3146,
Serial #9505-4081**

Frequency [MHz]	AF [dB/m]
200.0	11.47
250.0	12.06
300.0	14.77
400.0	15.77
500.0	18.01
600.0	18.84
700.0	20.93
800.0	21.27
900.0	22.44
1000.0	24.10



**12.6 Correction factors for Biconical Antenna
EMCO, Model 3110B,
Serial #9912-3337**

Frequency [MHz]	AF [dB/m]
30.0	14.18
35.0	13.95
40.0	12.84
45.0	11.23
50.0	11.10
60.0	10.39
70.0	9.34
80.0	9.02
90.0	9.31
100.0	8.95
120.0	11.53
140.0	12.20
160.0	12.56
180.0	13.49
200.0	15.27



12.7 Correction factors for ACTIVE LOOP ANTENNA
Model 6502
S/N 9506-2950

f(MHz)	MAF(dBs/m)	AF(dB/m)
0.01	-33.1	18.4
0.02	-37.2	14.3
0.03	-38.2	13.3
0.05	-39.8	11.7
0.1	-40.1	11.4
0.2	-40.3	11.2
0.3	-40.3	11.2
0.5	-40.3	11.2
0.7	-40.3	11.2
1	-40.1	11.4
2	-40	11.5
3	-40	11.5
4	-40.1	11.4
5	-40.2	11.3
6	-40.4	11.1
7	-40.4	11.1
8	-40.4	11.1
9	-40.5	11
10	-40.5	11
20	-41.5	10
30	-43.5	8