



DATE: 14 June 2017

**I.T.L. (PRODUCT TESTING) LTD.
FCC Radio Test Report**

for

**Corning Optical Communication Wireless
Equipment under test:**

ONE - Optical Network Evolution Wireless

**MRU (Mid Power Remote Unit)
(AWS-3 Section)**

Tested by:

M. Zohar

Approved by:

I. Raz

This report must not be reproduced, except in full, without the written permission of I.T.L. (Product Testing) Ltd.

This report relates only to items tested.



Measurement/Technical Report for
Corning Optical Communication Wireless
ONE - Optical Network Evolution Wireless
MRU (Mid Power Remote Unit)
AWS-3 Section

FCC ID: OJF1MRU21-3CR

This report concerns: Original Grant: X
 Class II change:
 Class I change:

Equipment type: Part 20 Industrial Booster (CMRS)

Limits used: 47CFR Parts 2; 27

Measurement procedure used is KDB 971168 D03 v01 and KDB 935210 D05 v01r01

Substitution Method used as in ANSI/TIA-603-D: 2010.

Application for Certification

prepared by:

R. Pinchuck
ITL (Product Testing) Ltd.
1 Bat Sheva St.
Lod 7120101
Israel
e-mail rpinchuck@itl.co.il

Applicant for this device:

(different from "prepared by")

Habib Riazi
Corning Optical Communication Wireless Inc.
13221 Woodland Park Rd., Suite #400
Herndon, VA. 20171
U.S.A.
Tel: +1-541-758-2880
Fax: +1-703-848-0260
e-mail: RiaziH@corning.com



TABLE OF CONTENTS

1.	GENERAL INFORMATION -----	5
1.1	Administrative Information.....	5
1.2	List of Accreditations	6
1.3	Product Description	7
1.4	Test Methodology	7
1.5	Test Facility	7
1.6	Measurement Uncertainty	7
2.	SYSTEM TEST CONFIGURATION -----	8
2.1	Justification.....	8
2.2	EUT Exercise Software	8
2.3	Special Accessories	8
2.4	Equipment Modifications	8
2.5	Configuration of Tested System.....	9
3.	TEST SET-UP PHOTOS -----	11
4.	RF POWER OUTPUT AWS-3 -----	14
4.1	Test Specification	14
4.2	Test Procedure.....	14
4.3	Test Limit.....	14
4.4	Test Results.....	14
4.5	Test Equipment Used; RF Power Output.....	20
5.	OCCUPIED BANDWIDTH AWS-3 -----	21
5.1	Test Specification	21
5.2	Test Procedure.....	21
5.3	Test Limit.....	21
5.4	Test Results.....	21
5.5	Test Equipment Used; Occupied Bandwidth.....	31
6.	SPURIOUS EMISSIONS AT ANTENNA TERMINALS AWS-3 -----	32
6.1	Test Specification	32
6.2	Test Procedure.....	32
6.3	Test Limit.....	32
6.4	Test Results.....	32
6.5	Test Equipment Used; Spurious Emissions at Antenna Terminals AWS-3....	36
7.	BAND EDGE SPECTRUM AWS-3 -----	37
7.1	Test Specification	37
7.2	Test Procedure.....	37
7.3	Test Limit.....	37
7.4	Test Results.....	37
7.5	Test Equipment Used; Band Edge Spectrum AWS-3.....	41
8.	SPURIOUS RADIATED EMISSION AWS-3 -----	42
8.1	Test Specification	42
8.2	Test Procedure.....	42
8.3	Test Limit.....	43
8.4	Test Results.....	43
8.5	Test Instrumentation Used, Radiated Measurements AWS-3	44
9.	OUT-OF-BAND REJECTION - AWS-3 -----	45
9.1	Test Specification	45
9.2	Test Procedure.....	45
9.3	Test Limit.....	45
9.4	Test Results.....	45
9.5	Test Equipment Used; Out-of-Band Rejection	46



10. APPENDIX A - CORRECTION FACTORS -----47

- 10.1 Correction factors for RF OATS Cable 35m.....47
- 10.2 Correction factors for biconical antenna – ITL # 135648
- 10.3 Correction factors for log periodic antenna – ITL # 1349.....49
- 10.4 Correction factors for Active Loop Antenna50
- 10.5 Correction factors for Horn ANTENNA.....51
- 10.6 Correction factors for Horn Antenna52
- 10.7 Correction factor for RF CABLE for Semi Anechoic Chamber.....53



1. General Information

1.1 Administrative Information

Manufacturer: Corning Optical Communication
Wireless

Manufacturer's Address: 13221 Woodland Park Rd., Suite #400
Herndon, VA. 20171
U.S.A.
Tel: +1-541-758-2880
Fax: +1-703-848-0260

Manufacturer's Representative: Habib Riazi

Equipment Under Test (E.U.T): ONE - Optical Network Evolution
Wireless

Equipment Model No.: MRU (Mid Power Remote Unit)

Equipment Serial No.: Not designated

Date of Receipt of E.U.T: May 8, 2017

Start of Test: May 8, 2017

End of Test: May 11, 2017

Test Laboratory Location: I.T.L (Product Testing) Ltd.
1 Batsheva St,
Lod,
Israel 7116002

Test Specifications: FCC Parts 2, 27



1.2 List of Accreditations

The EMC laboratory of I.T.L. is accredited by/registered with the following bodies:

1. The American Association for Laboratory Accreditation (A2LA) (U.S.A.), Certificate No. 1152.01.
2. The Federal Communications Commission (FCC) (U.S.A.), FCC Designation Number is IL1005.
3. The Israel Ministry of the Environment (Israel), Registration No. 1104/01.
4. Industry Canada (Canada), IC File No.: 46405-4025; Site No. IC 4025A-1, IC 4025A-2.

I.T.L. Product Testing Ltd. is accredited by the American Association for Laboratory Accreditation (A2LA) and the results shown in this test report have been determined in accordance with I.T.L.'s terms of accreditation unless stated otherwise in the report.



1.3 Product Description

Corning's mid-power remote unit (MRU) provides remote indoor and outdoor coverage for the Corning ONE™ wireless platform. It is a fiber-fed, compact, and scalable multiservice solution designed to complement the Corning ONE wireless platform by providing complete RF open space coverage for large-scale public venues such as campus applications.

1.4 Test Methodology

Both conducted and radiated testing were performed according to the procedures in KDB 971168 D03 v01, KDB 935210 D05 v01r01 and ANSI/TIA-603-D: 2010. Radiated testing was performed at an antenna to EUT distance of 3 meters.

1.5 Test Facility

Both conducted and radiated emissions tests were performed at I.T.L.'s testing facility in Lod, Israel. I.T.L.'s EMC Laboratory is accredited by A2LA, certificate No. 1152.01 and its FCC Designation Number is IL1005.

1.6 Measurement Uncertainty

Conducted Emission (CISPR 11, EN 55011, CISPR 22, EN 55022, ANSI C63.4)

0.15 – 30 MHz:

Expanded Uncertainty (95% Confidence, K=2):

± 3.44 dB

Radiated Emission (CISPR 11, EN 55011, CISPR 22, EN 55022, ANSI C63.4)
for open site 30-1000MHz:

Expanded Uncertainty (95% Confidence, K=2):

± 4.98 dB

2. System Test Configuration

2.1 Justification

The test setup was configured to closely resemble the standard installation. The EUT consists of the MRU (Mid-Power Remote Module) which is connected with the head-end ONE equipment using fiber optic cable. The RF source signals are represented in the setup by appropriate signal generators. An “Exercise” SW on the computer was used to enable/disable transmission of the EUT, while the EUT output was connected to the spectrum analyzer. The system was tested under maximum gain conditions. Testing was performed on the following configuration:

Frequency Range (MHz)		
Service/Band	Downlink (DL)	Technology
AWS-3	2110-2180	LTE

2.2 EUT Exercise Software

The Element Management System ver. 2.0 used for commands delivery. These commands are used to enable/disable the EUT transmission. EUT Embedded SW versions is mru_da64_20_02.bin.

2.3 Special Accessories

No special accessories were needed in order to achieve compliance.

2.4 Equipment Modifications

No modifications were necessary in order to achieve compliance.

2.5 Configuration of Tested System

Product Name	ONE Wireless Platform
Model Name	MRU (Mid Power Remote Unit)
Working voltage	100-240VAC/50-60Hz 48VDC
Mode of operation	Industrial Booster for AWS-3 band
Modulations	WCDMA, LTE(64QAM), GSM
Assigned Frequency Range	2110MHz-2180MHz
Transmit power	~34.0dBm
Antenna Gain	12.5dBi
DATA rate	N/A
Modulation BW	0.5MHz(GSM), 5MHz(WCDMA); 10MHz(LTE)
DC Voltage and DC current applied to the final amplifying device	1.4A @ 28VDC

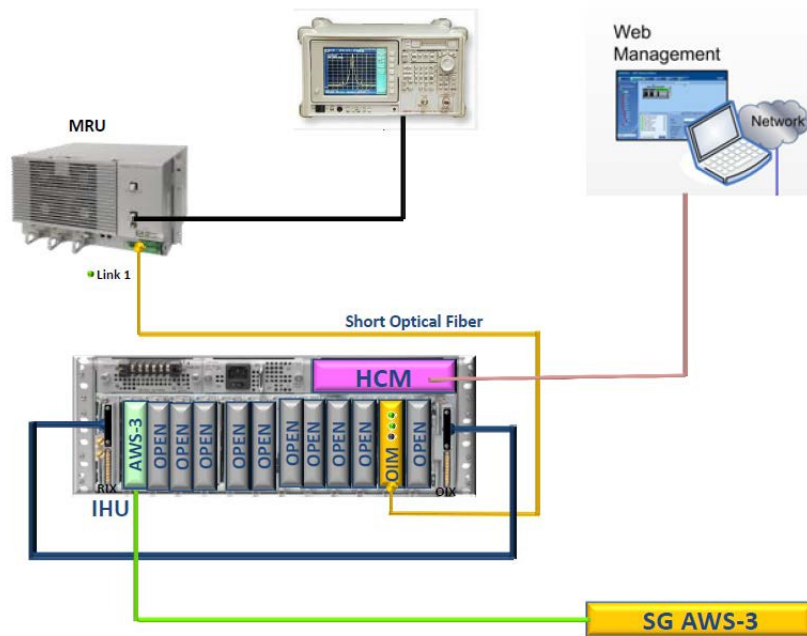

Figure 1. Conducted Test Set-Up

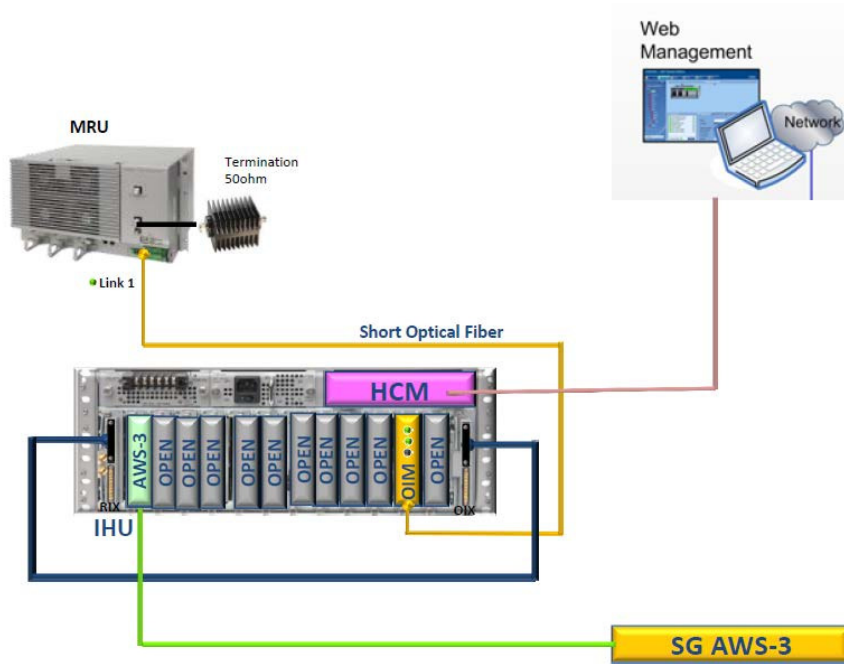

Figure 2. Radiated Test Set-Up

3. Test Set-Up Photos

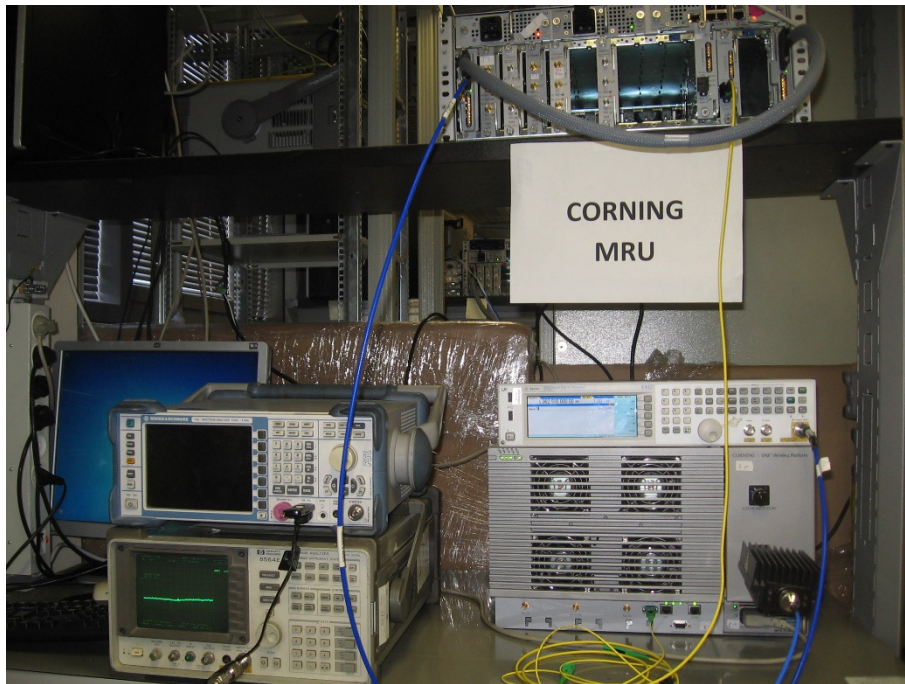

Figure 3. Conducted Emission from Antenna Ports Test



Figure 4. Radiated Emission Test



Figure 5. Radiated Emission Test



Figure 6. Radiated Emission Test

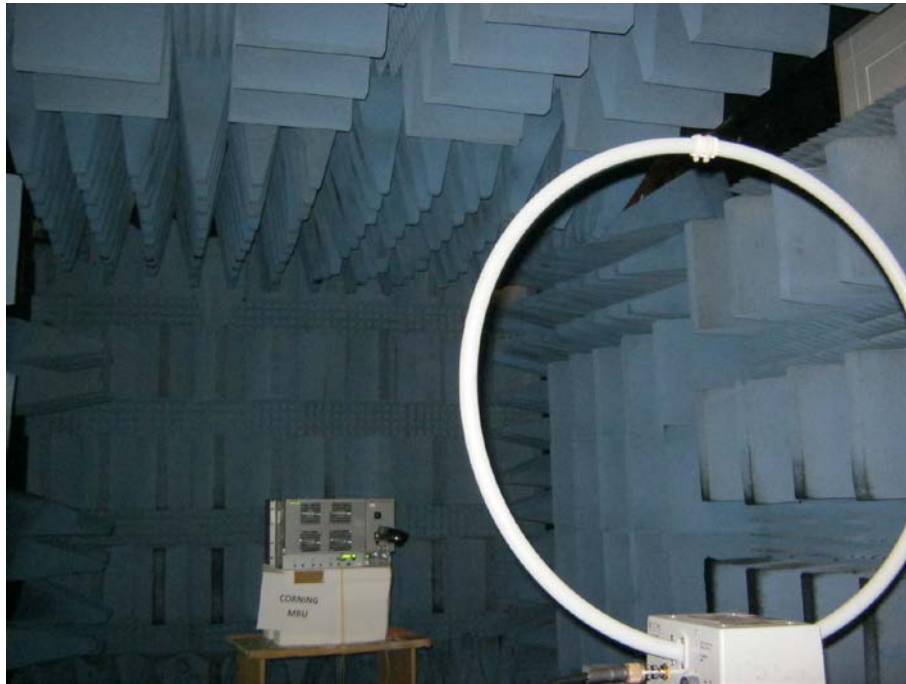

Figure 7. Radiated Emission Test



Figure 8. Radiated Emission Test

4. RF Power Output AWS-3

4.1 Test Specification

FCC Part 27, Subpart C, Section: 27.50(d)

4.2 Test Procedure

(Temperature (20°C)/ Humidity (35%RH))

The E.U.T. antenna terminal was connected to the Spectrum Analyzer through an external attenuator (total loss= 41.5dB) and an appropriate coaxial cable. Special attention was taken to prevent Spectrum Analyzer RF input overload.

4.3 Test Limit

The power limit is 1640W (62.1 dBm).

4.4 Test Results

Modulation	Operation Frequency (MHz)	Reading (dBm)	Antenna Gain (dBi)	EIRP (dBm)	Limit (dBm)	Margin (dB)
GSM	2111.2	34.3	12.5	46.8	62.1	-15.3
	2145.0	34.8	12.5	47.3	62.1	-14.8
	2178.8	34.2	12.5	46.7	62.1	-15.4
LTE 64QAM	2115.0	34.5	12.5	47.0	62.1	-15.1
	2145.0	34.5	12.5	47.0	62.1	-15.1
	2175.0	35.0	12.5	47.5	62.1	-14.6
W-CDMA	2112.5	34.8	12.5	47.3	62.1	-14.8
	2145.0	34.7	12.5	47.2	62.1	-14.9
	2177.5	34.6	12.5	47.1	62.1	-15.0

Figure 9 RF Power Output AWS-3

JUDGEMENT: Passed

See additional information in *Figure 10* to *Figure 18*.

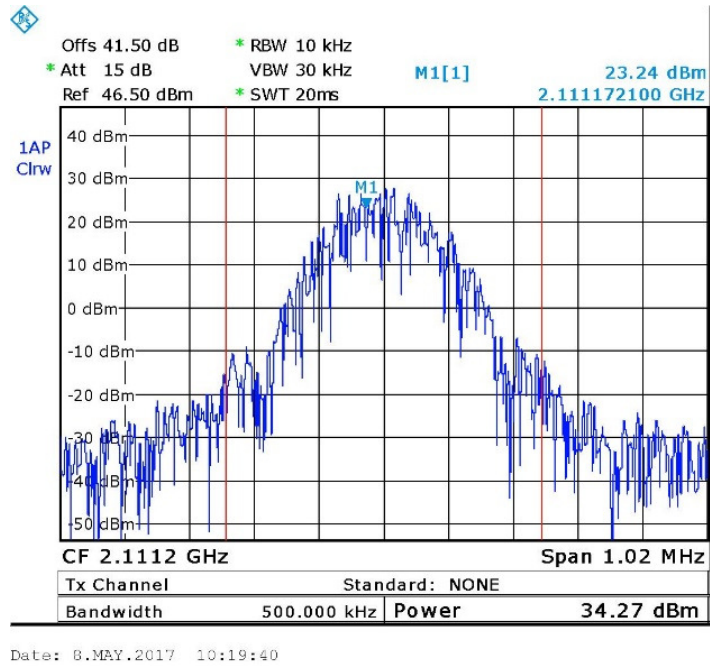

Figure 10. — GSM (2111.2 MHz)

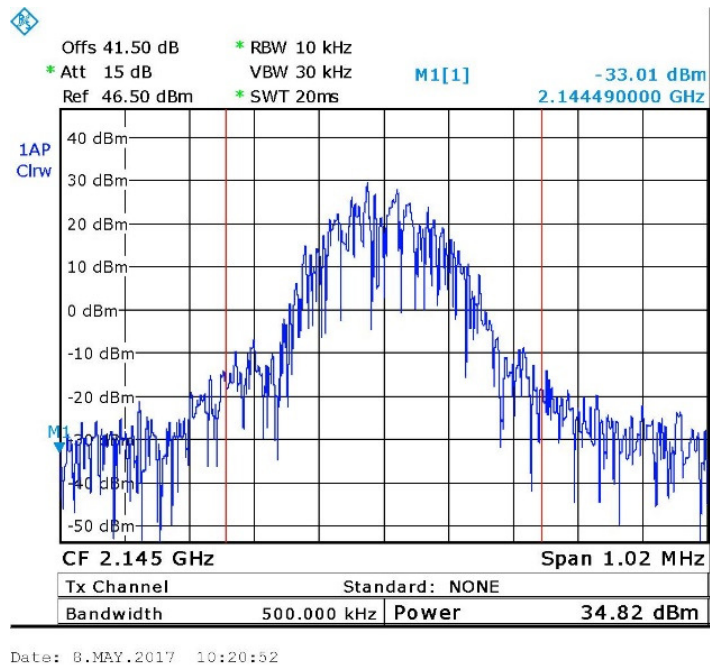
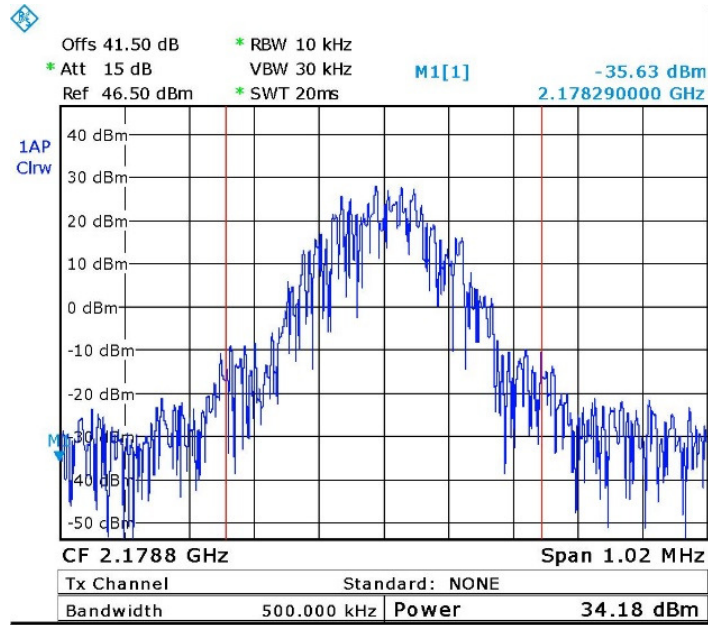
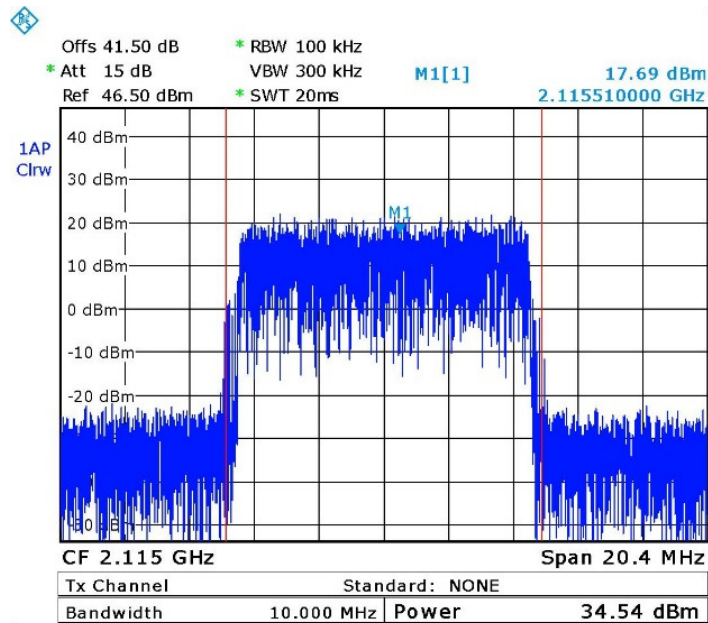

Figure 11. — GSM (2145.0MHz)



Date: 8.MAY.2017 10:22:17

Figure 12. — GSM (2178.8 MHz)



Date: 8.MAY.2017 10:24:03

Figure 13. — LTE 64QAM (2115.0 MHz)

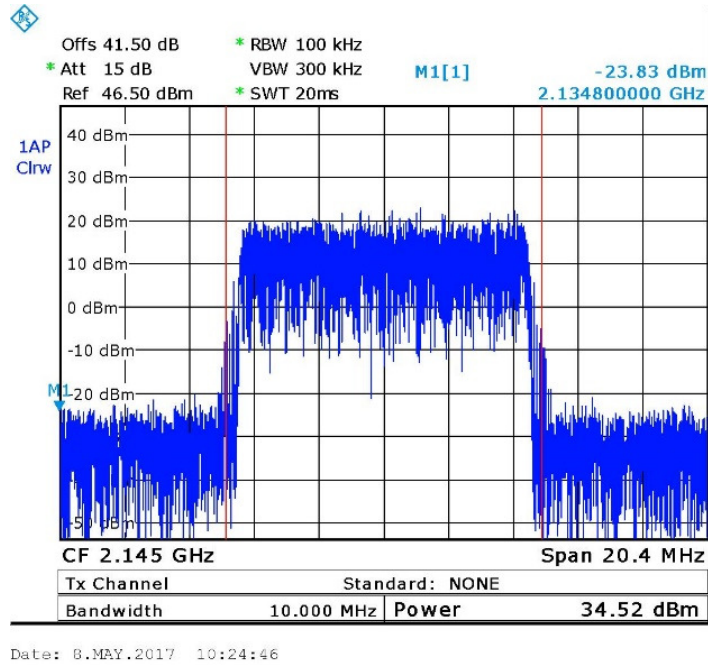

Figure 14. — LTE 64QAM (2145.0MHz)

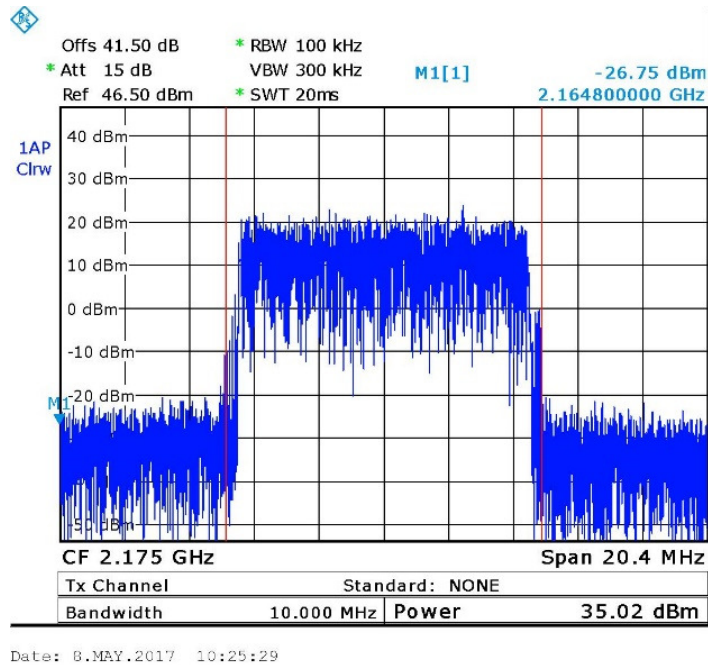
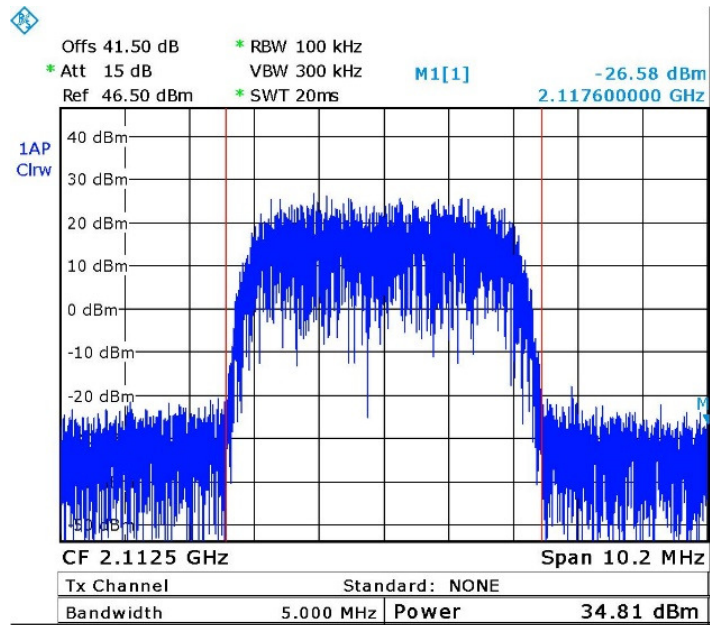
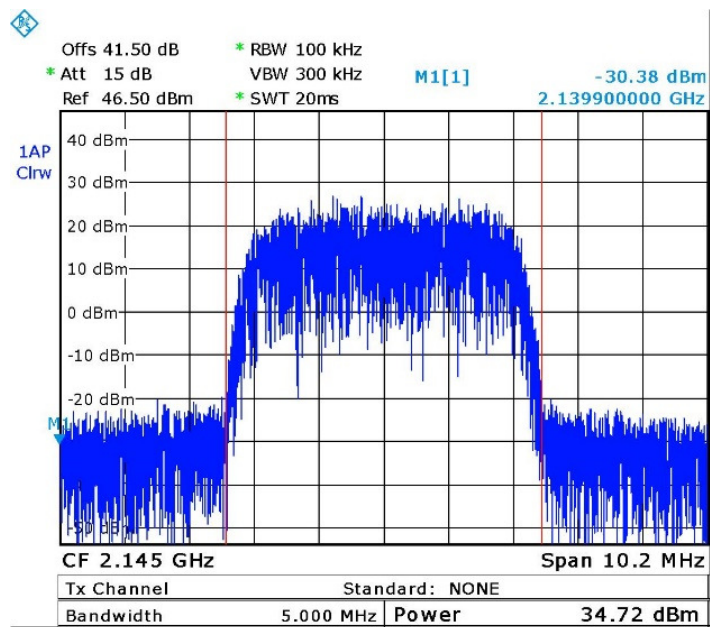

Figure 15. — LTE 64QAM (2175.0MHz)



Date: 8.MAY.2017 10:27:24

Figure 16. — W-CDMA (2112.5 MHz)



Date: 8.MAY.2017 10:28:16

Figure 17. — W-CDMA (2145.0MHz)

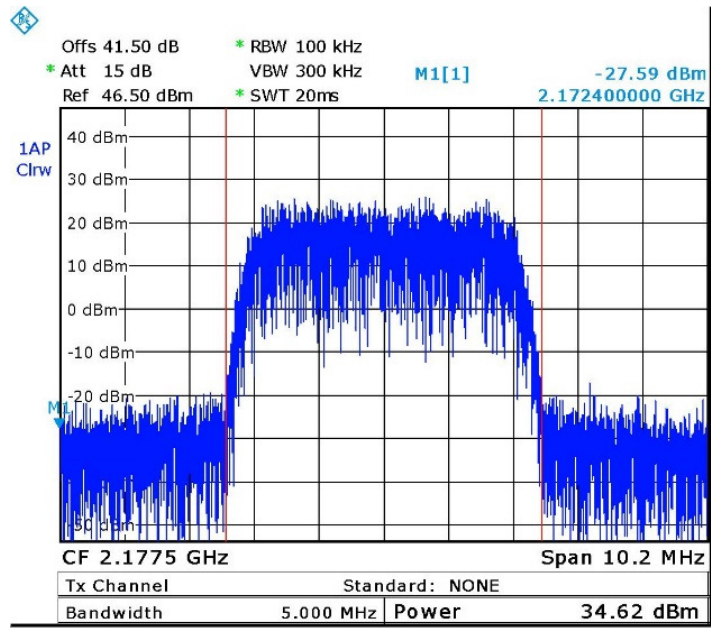

Date: 8.MAY.2017 10:28:58

Figure 18. — W-CDMA (2177.5MHz)



4.5 Test Equipment Used; RF Power Output

Instrument	Manufacturer	Model	Serial Number	Calibration	
				Last Calibration Date	Next Calibration Due
Spectrum Analyzer	R&S	FSL6	100194	March 2, 2017	March 2, 2018
EXG Vector Signal Generator	Agilent	N5172B	MY53050697	June 19, 2016	June 19, 2019
40 dB Attenuator	Weinschel	WA 39-40-33	A1323	August 8, 2016	August 8, 2017

Figure 19 Test Equipment Used

5. Occupied Bandwidth AWS-3

5.1 Test Specification

FCC Part 2, Section 2.1049

5.2 Test Procedure

(Temperature (20°C)/ Humidity (35%RH))

The E.U.T. antenna terminal was connected to the spectrum analyzer through an external attenuator and an appropriate coaxial cable (total loss=41.5 dB). The spectrum analyzer was set to proper resolution B.W.

OBW function (99%) was employed for this evaluation.

Occupied bandwidth measured was repeated in the input terminal of the E.U.T.

5.3 Test Limit

N/A

5.4 Test Results

Modulation	Port	Operating Frequency	Reading
	(Input/ Output)	(MHz)	(MHz)
LTE 64QAM	Input	2115.0	9.0
	Output	2115.0	9.0
	Input	2145.0	9.0
	Output	2145.0	9.0
	Input	2175.0	9.0
	Output	2175.0	9.0
GSM	Input	2111.2	0.2
	Output	2111.2	0.2
	Input	2145.0	0.2
	Output	2145.0	0.2
	Input	2178.8	0.2
	Output	2178.8	0.2
W-CDMA	Input	2112.5	4.2
	Output	2112.5	4.2
	Input	2145.0	4.2
	Output	2145.0	4.2
	Input	2177.5	4.2
	Output	2177.5	4.2

Figure 20 Occupied Bandwidth AWS-3

JUDGEMENT: Passed

See additional information in *Figure 21* to *Figure 38*.

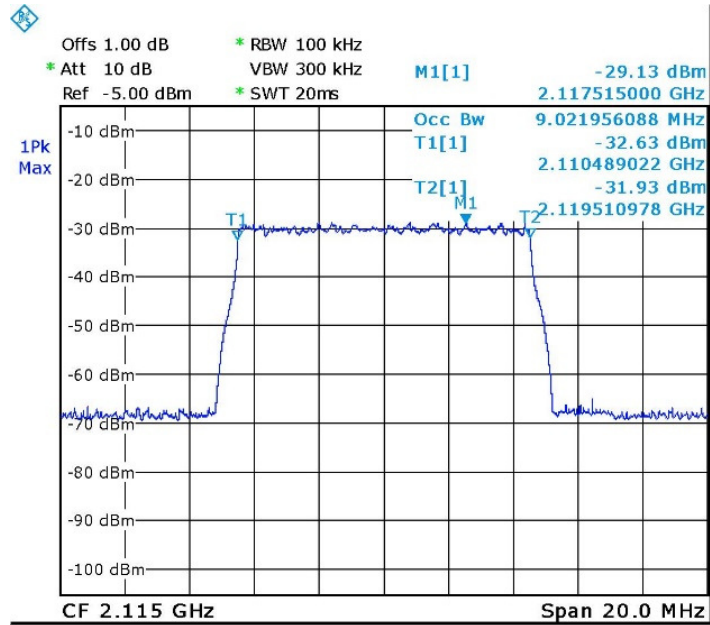

Date: 8.MAY.2017 10:55:02

Figure 21. — LTE 64QAM (2115.0 MHz) IN

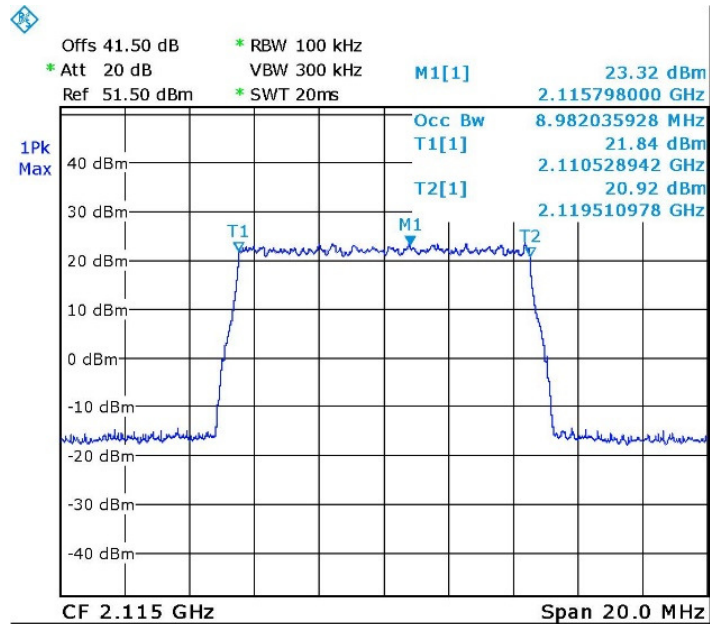

Date: 8.MAY.2017 10:40:49

Figure 22. — LTE 64QAM (2115.0 MHz) OUT

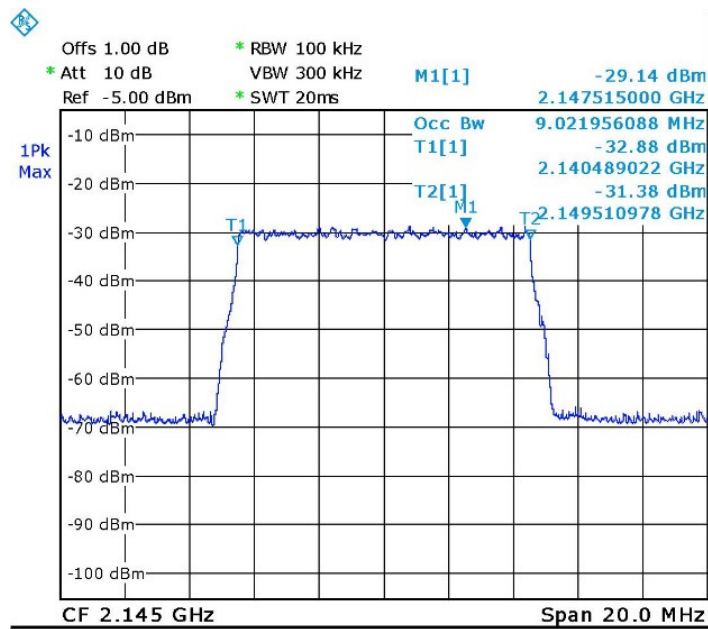

Date: 8.MAY.2017 10:55:34

Figure 23. — LTE 64QAM (2145.0MHz) IN

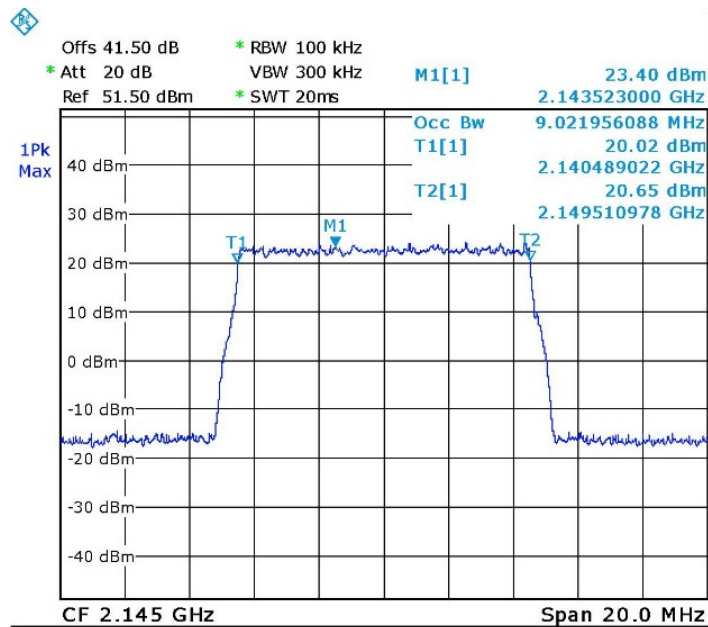

Date: 8.MAY.2017 10:41:20

Figure 24. — LTE 64QAM (2145.0MHz) OUT

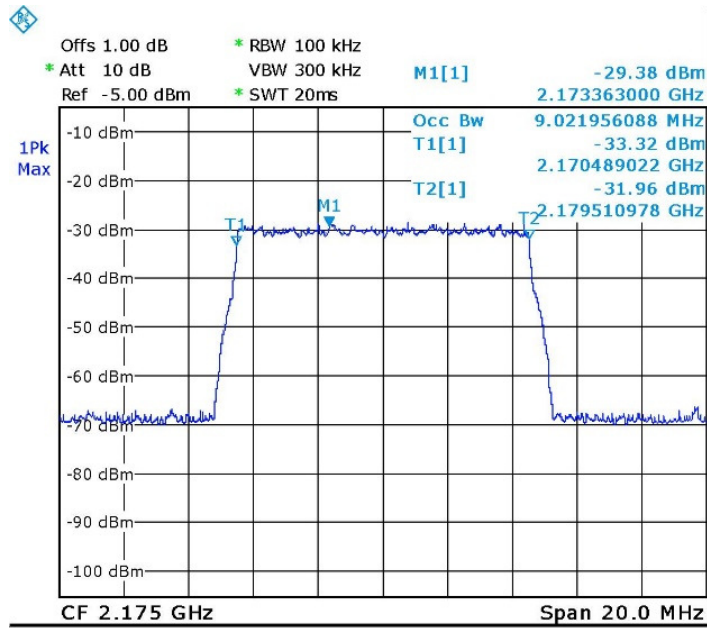

Date: 8.MAY.2017 11:09:50

Figure 25. — LTE 64QAM (2175.0 MHz) IN

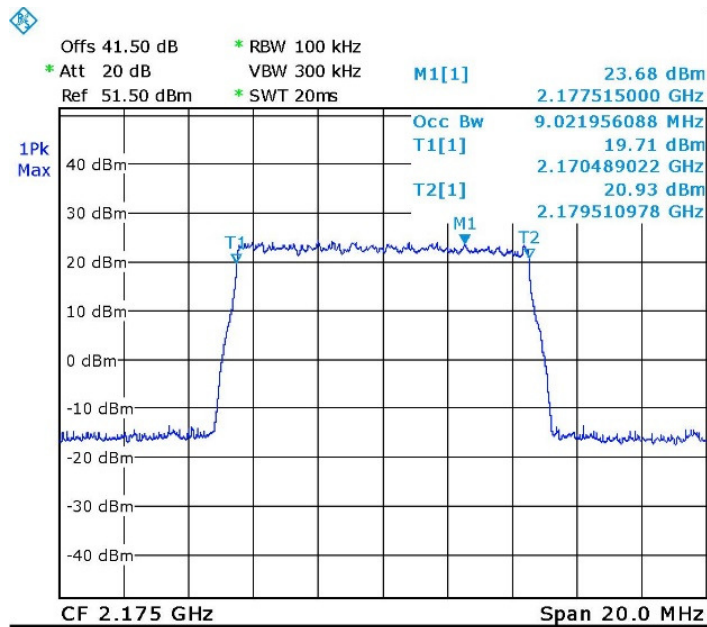

Date: 8.MAY.2017 10:42:12

Figure 26. — LTE 64QAM (2175.0 MHz) OUT

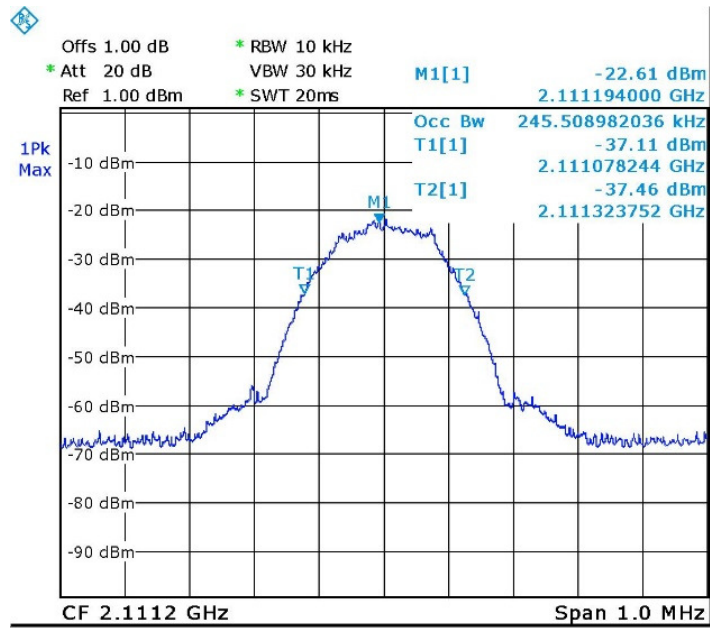

Date: 8.MAY.2017 10:49:58

Figure 27. — GSM (2111.2 MHz) IN

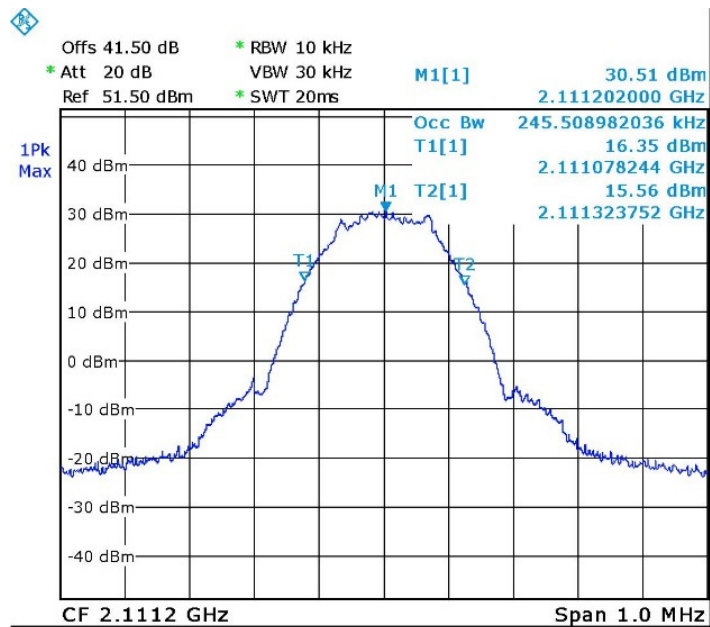

Date: 8.MAY.2017 10:43:59

Figure 28. — GSM (2111.2 MHz) OUT

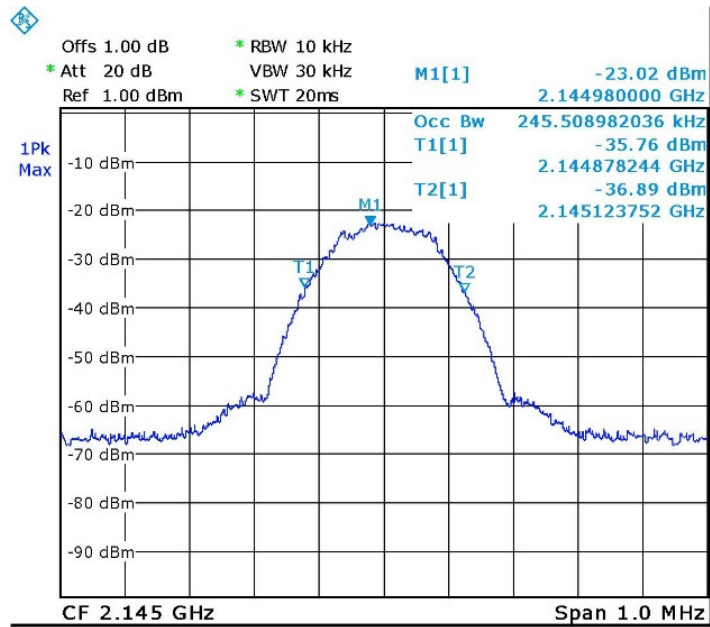

Date: 8.MAY.2017 10:49:21

Figure 29. — GSM (2145.0MHz) IN

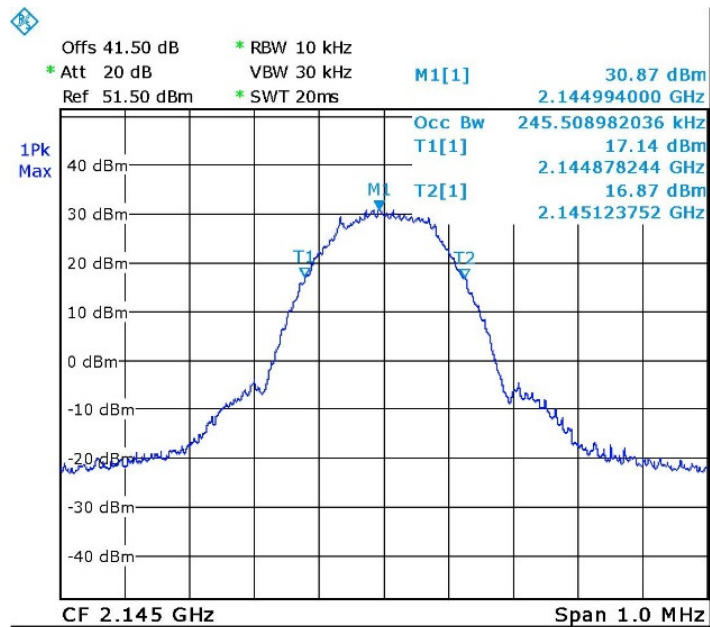

Date: 8.MAY.2017 10:44:39

Figure 30. — GSM (2145.0MHz) OUT

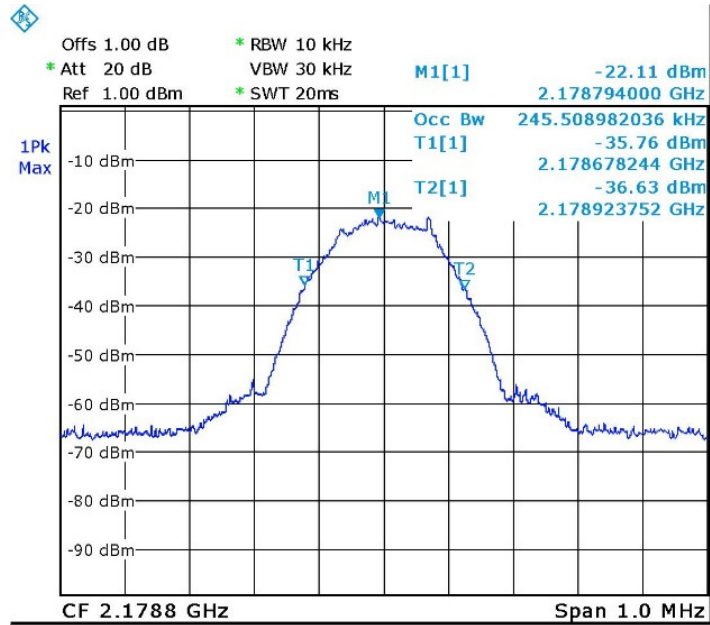

Date: 8.MAY.2017 10:48:31

Figure 31. — GSM (2178.8 MHz) IN

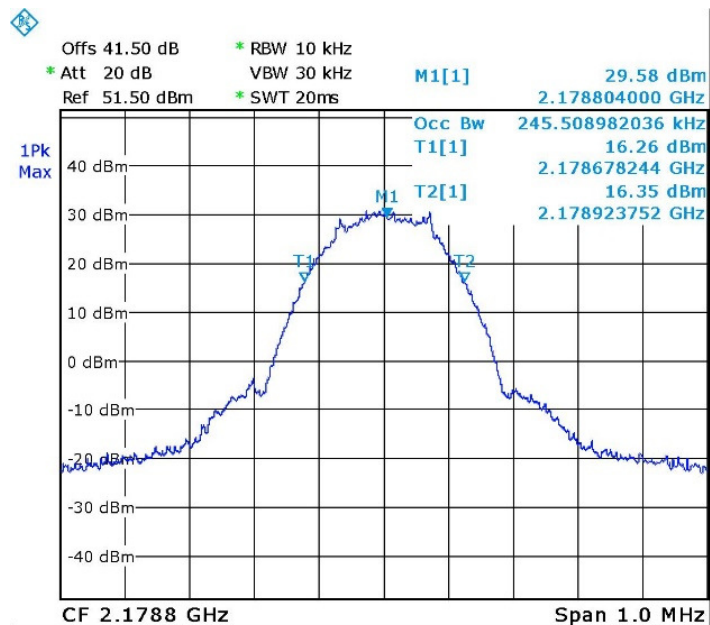

Date: 8.MAY.2017 10:45:27

Figure 32. — GSM (2178.8 MHz) OUT

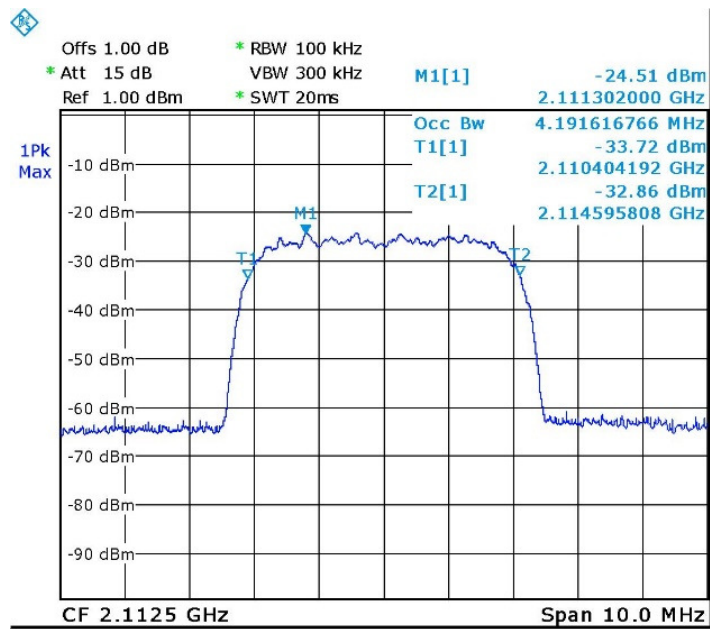

Date: 8.MAY.2017 10:51:37

Figure 33. — W-CDMA (2112.5 MHz) IN

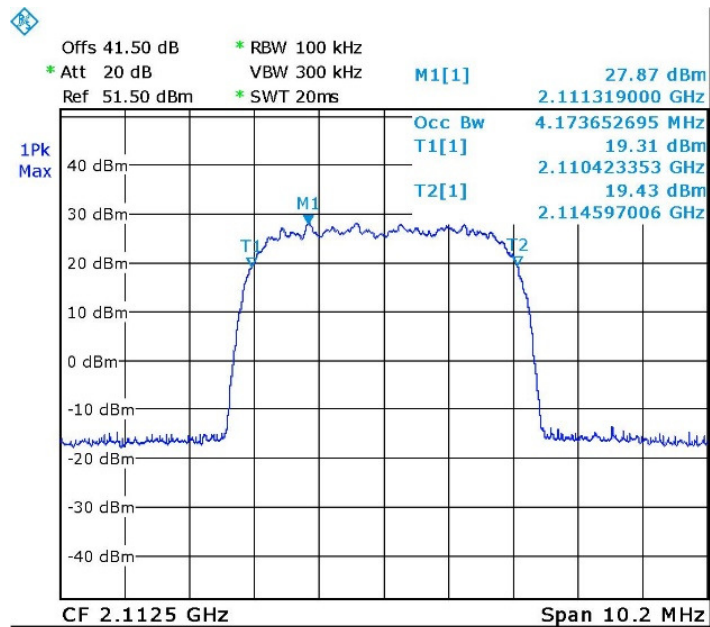

Date: 8.MAY.2017 10:39:29

Figure 34. — W-CDMA (2112.5 MHz) OUT

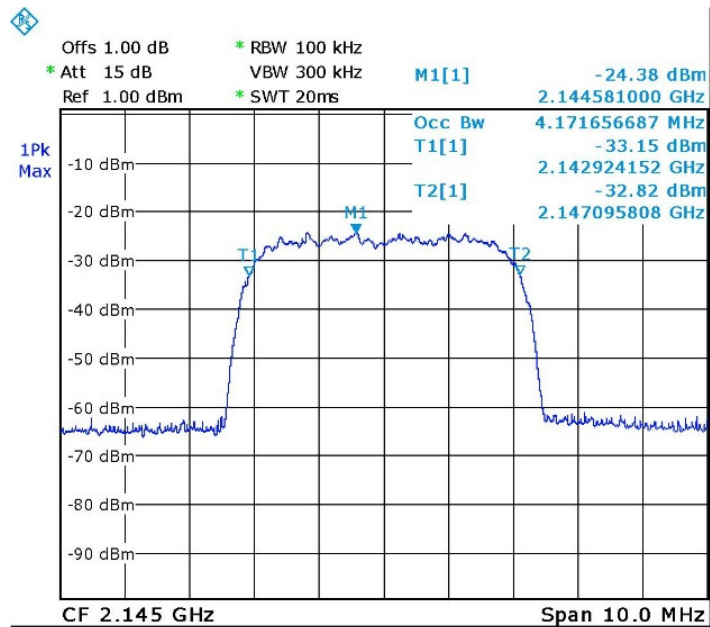

Date: 8.MAY.2017 10:52:17

Figure 35. — W-CDMA (2145.0MHz) IN

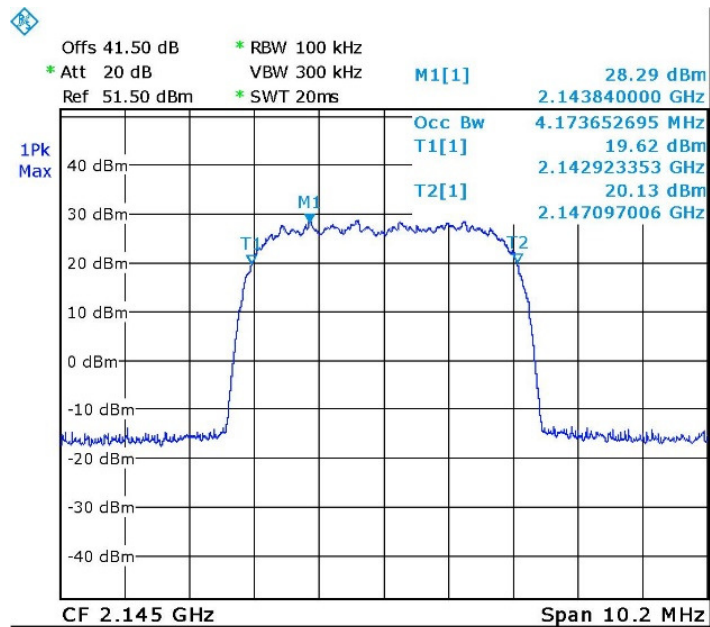

Date: 8.MAY.2017 10:38:39

Figure 36. — W-CDMA (2145.0MHz) OUT

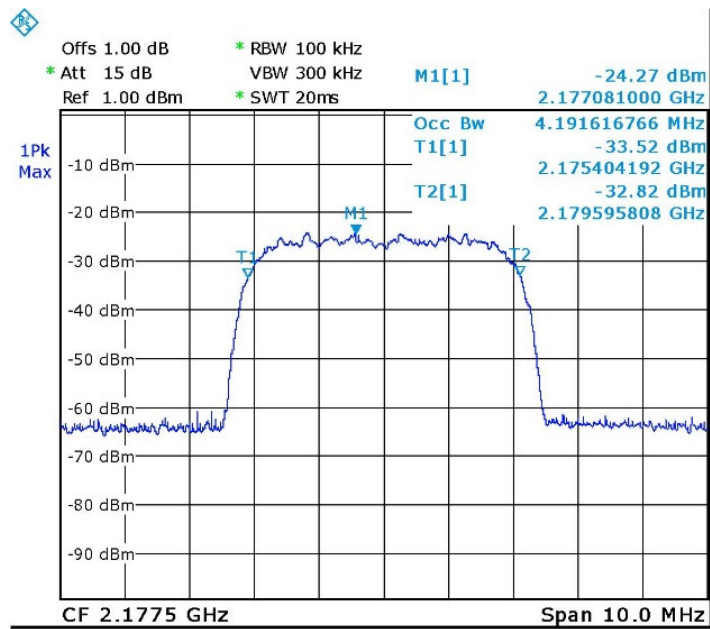

Date: 8.MAY.2017 10:53:07

Figure 37. — W-CDMA (2177.5 MHz) IN

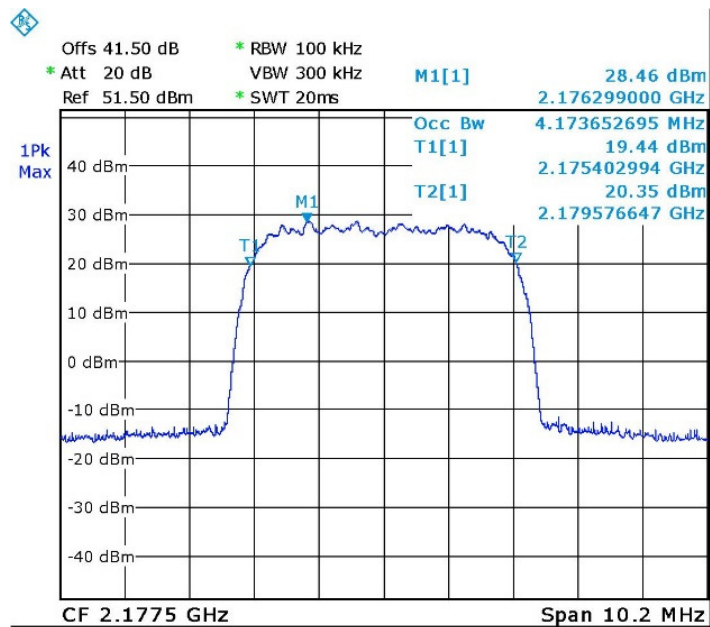

Date: 8.MAY.2017 10:38:02

Figure 38. — W-CDMA (2177.5 MHz) OUT



5.5 Test Equipment Used; Occupied Bandwidth

Instrument	Manufacturer	Model	Serial Number	Calibration	
				Last Calibration Date	Next Calibration Due
Spectrum Analyzer	R&S	FSL6	100194	March 2, 2017	March 2, 2018
EXG Vector Signal Generator	Agilent	N5172B	MY53050697	June 19, 2016	June 19, 2019
40 dB Attenuator	Weinschel	WA 39-40-33	A1323	August 8, 2016	August 8, 2017

Figure 39 Test Equipment Used



6. Spurious Emissions at Antenna Terminals AWS-3

6.1 Test Specification

FCC Part 27, Subpart C, Section: 27.53(h)

6.2 Test Procedure

(Temperature (23°C)/ Humidity (48%RH))

The E.U.T. antenna terminal was connected to the spectrum analyzer through an external attenuator and an appropriate coaxial cable (max loss =44.0 dB). The spectrum analyzer was set to 300Hz RBW for the frequency range 9.0-150.0 kHz, 10kHz for the frequency range 150.0kHz–30.0MHz, 100kHz for the frequency range 30.0–1000.0MHz, and 1MHz for the frequency range 1.0- 22.0 GHz.

6.3 Test Limit

The power of any emission outside of the authorized operating frequency ranges (2110-2180MHz) must be attenuated below the transmitting power (P) by a factor of at least $43 + 10 \cdot \log(P)$ dB, yielding -13dBm .

6.4 Test Results

JUDGEMENT: Passed

See additional information in *Figure 40* to *Figure 48*.

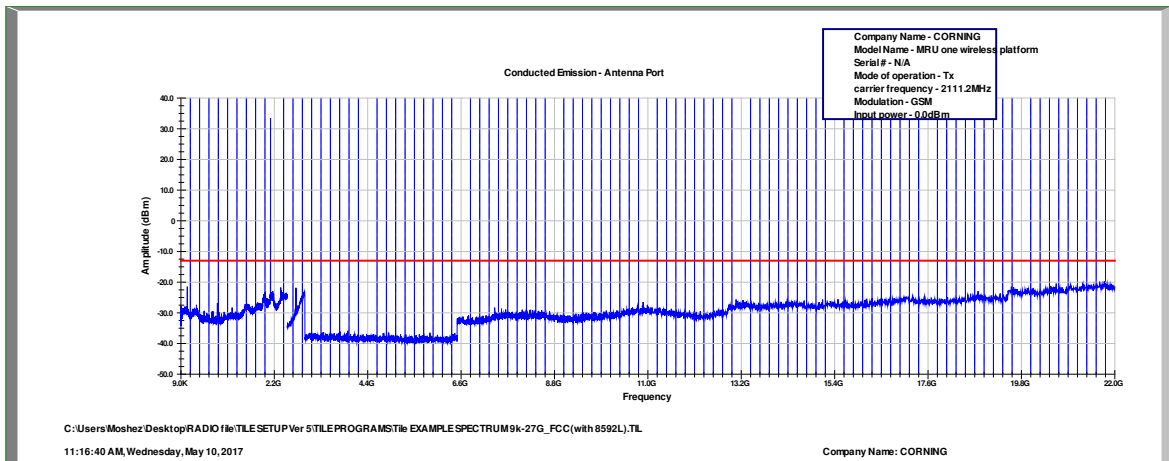

Figure 40 Spurious Emissions at Antenna Terminals GSM, 2111.2MHz

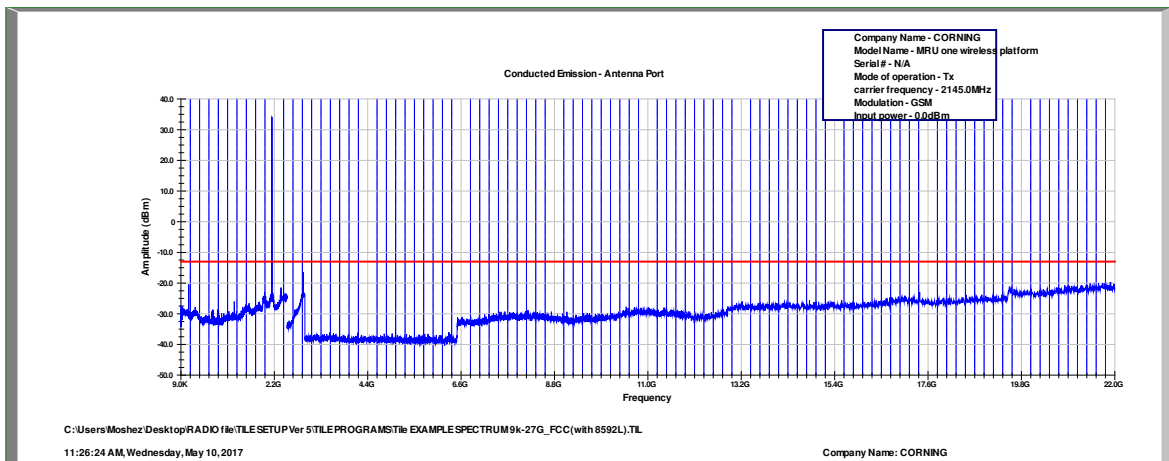

Figure 41 Spurious Emissions at Antenna Terminals GSM, 2145.0MHz

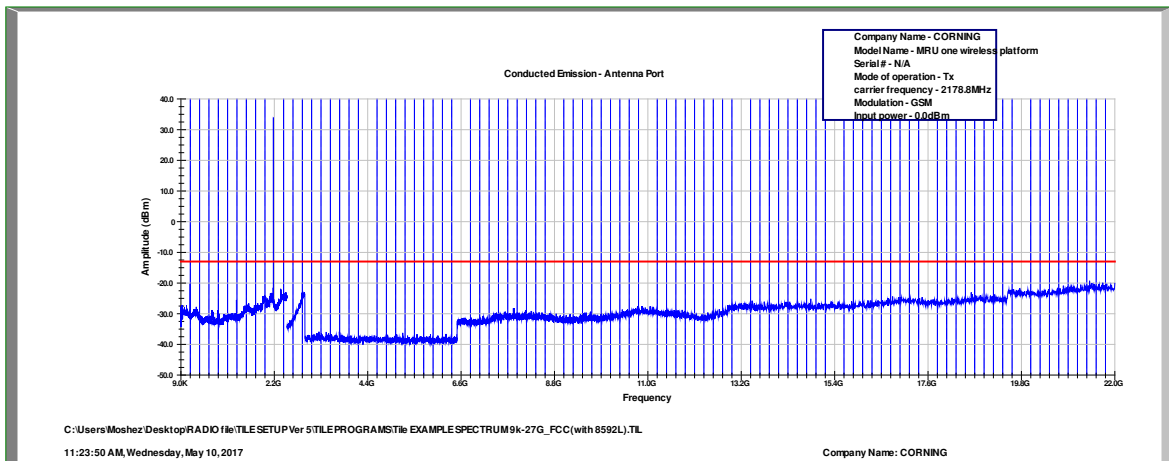

Figure 42 Spurious Emissions at Antenna Terminals GSM, 2178.8MHz

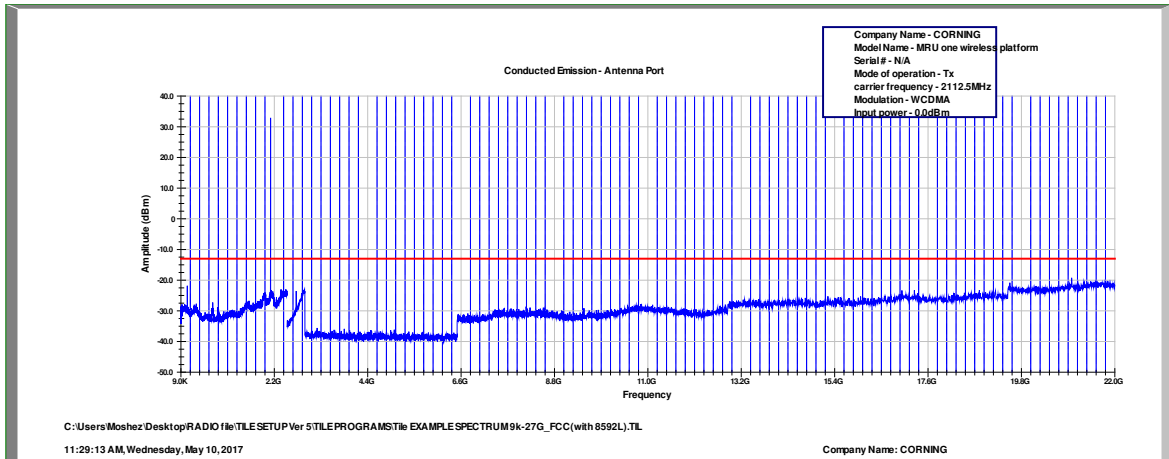

Figure 43 Spurious Emissions at Antenna Terminals WCDMA, 2112.5MHz

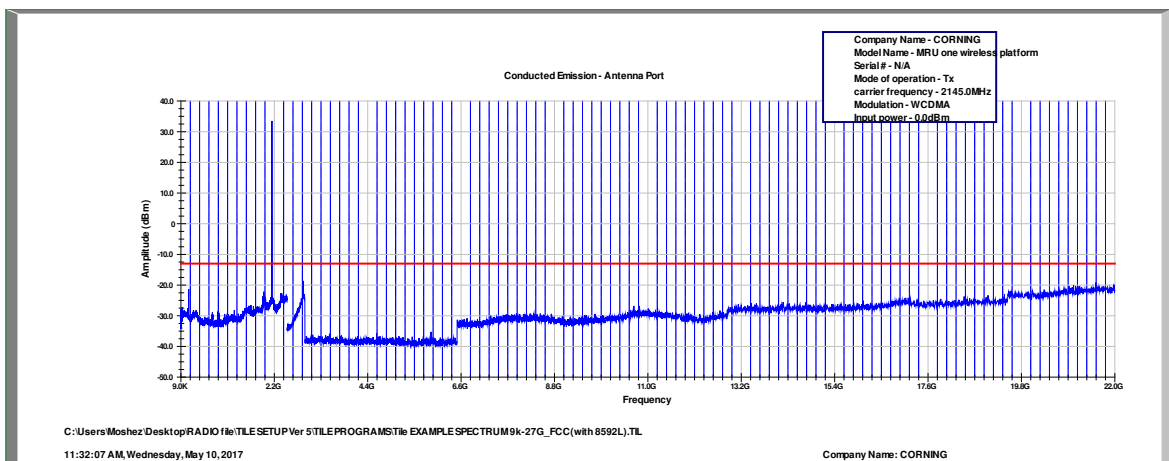

Figure 44 Spurious Emissions at Antenna Terminals WCDMA, 2145.0MHz

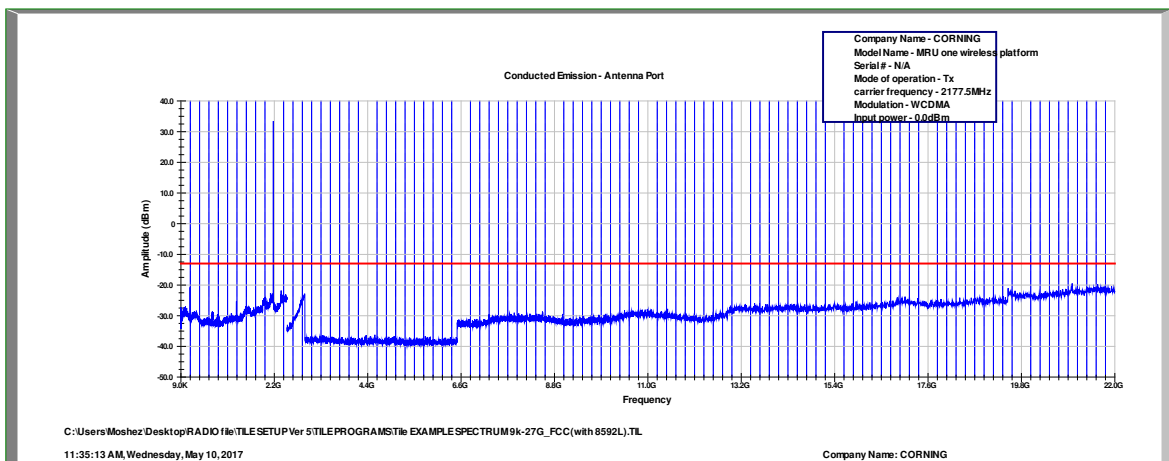

Figure 45 Spurious Emissions at Antenna Terminals WCDMA, 2177.5MHz

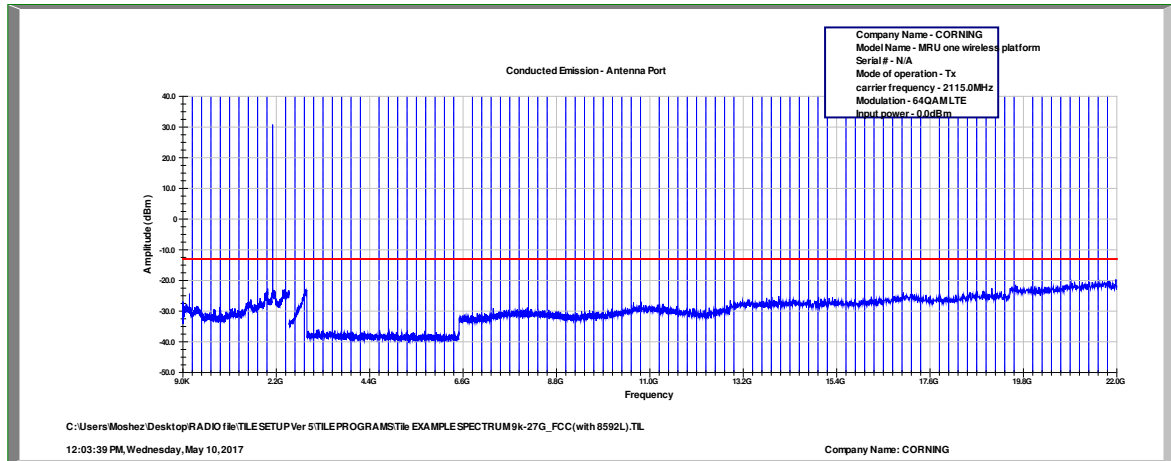

Figure 46 Spurious Emissions at Antenna Terminals LTE, 2115.0MHz

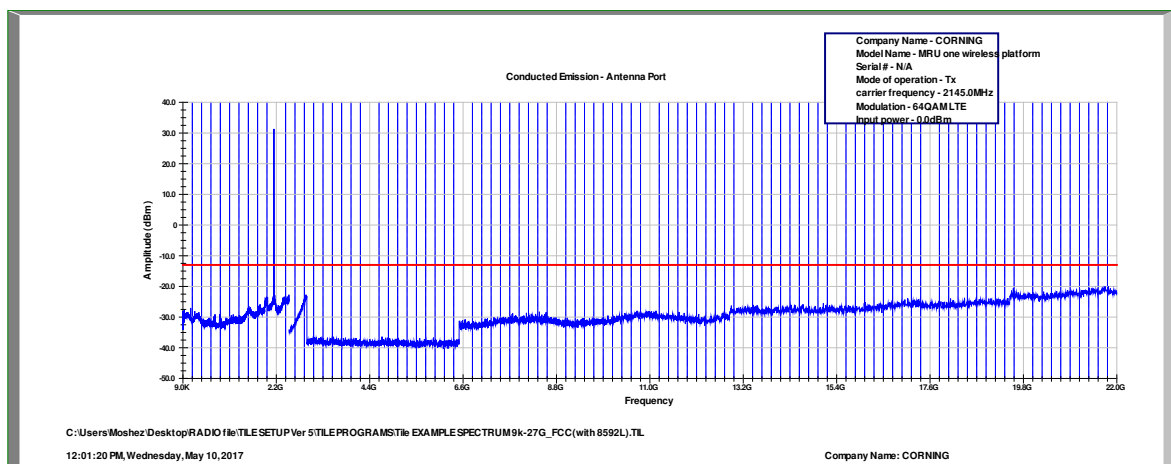

Figure 47 Spurious Emissions at Antenna Terminals LTE, 2145.0MHz

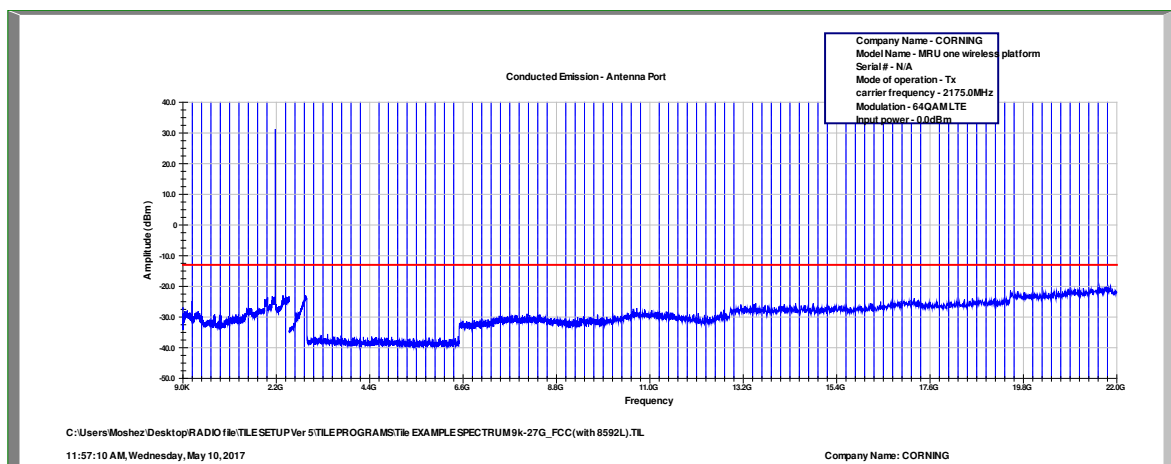

Figure 48 Spurious Emissions at Antenna Terminals LTE, 2175.0MHz



6.5 Test Equipment Used; Spurious Emissions at Antenna Terminals AWS-3

Instrument	Manufacturer	Model	Serial Number	Calibration	
				Last Calibration Date	Next Calibration Due
EXG Vector Signal Generator	Agilent	N5172B	MY53050697	June 19, 2016	June 19, 2019
Spectrum Analyzer	HP	8592L	3826A01204	March 13, 2017	March 13, 2018
40 dB Attenuator	Weinschel	WA 39-40-33	A1323	August 8, 2016	August 8, 2017

Figure 49 Test Equipment Used

7. Band Edge Spectrum AWS-3

7.1 Test Specification

FCC Part 27, Subpart C, Section 27.53(h)

7.2 Test Procedure

(Temperature (20°C)/ Humidity (35%RH))

The E.U.T. antenna terminal was connected to the spectrum analyzer through an external attenuator and an appropriate coaxial cable (total loss = 41.5 dB).

RBW was set to 100kHz.

7.3 Test Limit

The power of any emission outside of the authorized operating frequency ranges (2110-2180MHz) must be attenuated below the transmitting power (P) by a factor of at least $43 + 10 \cdot \log(P)$ dB, yielding -13dBm.

7.4 Test Results

Modulation	Operation Frequency (MHz)	Band Edge Frequency (MHz)	Reading (dBm)	Limit (dBm)	Margin (dB)
LTE 64QAM	2115.0	2110.0	-19.8	-13.0	-6.8
LTE 64QAM	2175.0	2180.0	-20.6	-13.0	-7.6
GSM	2111.2	2110.0	-20.5	-13.0	-7.5
GSM	2178.8	2180.0	-20.1	-13.0	-7.1
W-CDMA	2112.5	2110.0	-22.7	-13.0	-9.7
W-CDMA	2177.5	2180.0	-21.0	-13.0	-8.0

Figure 50 Band Edge Spectrum Results AWS

JUDGEMENT: Passed by 6.8 dB

See additional information in *Figure 51* to *Figure 56*.

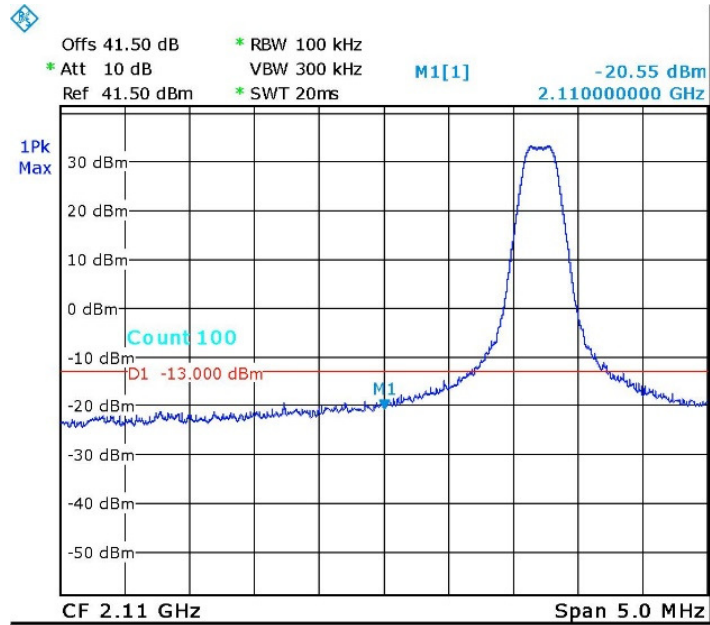

Date: 8.MAY.2017 11:31:06

Figure 51. — GSM 2111.2 MHz

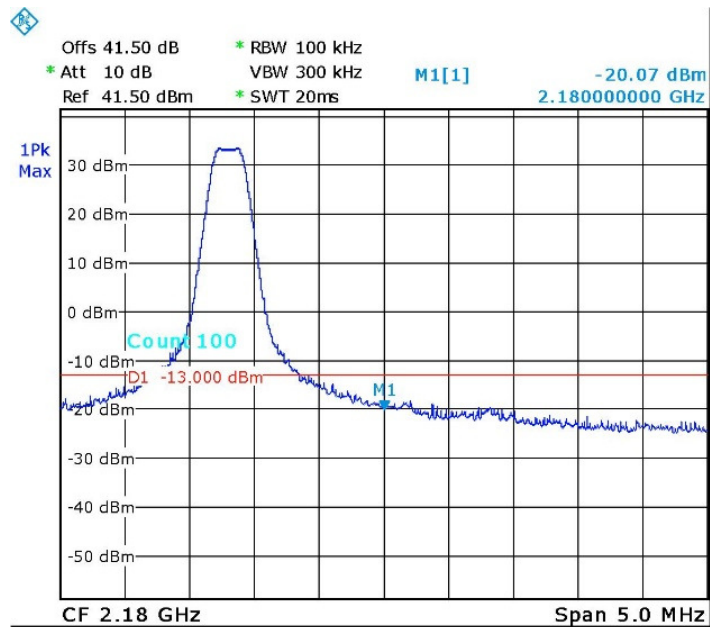

Date: 8.MAY.2017 11:32:16

Figure 52. — GSM 2178.8 MHz

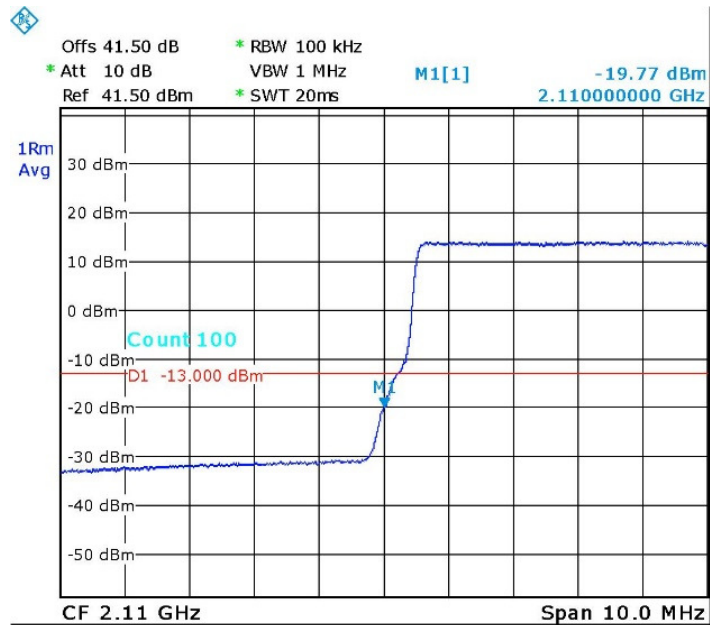

Date: 8.MAY.2017 11:28:28

Figure 53. — LTE 64QAM 2115.0 MHz

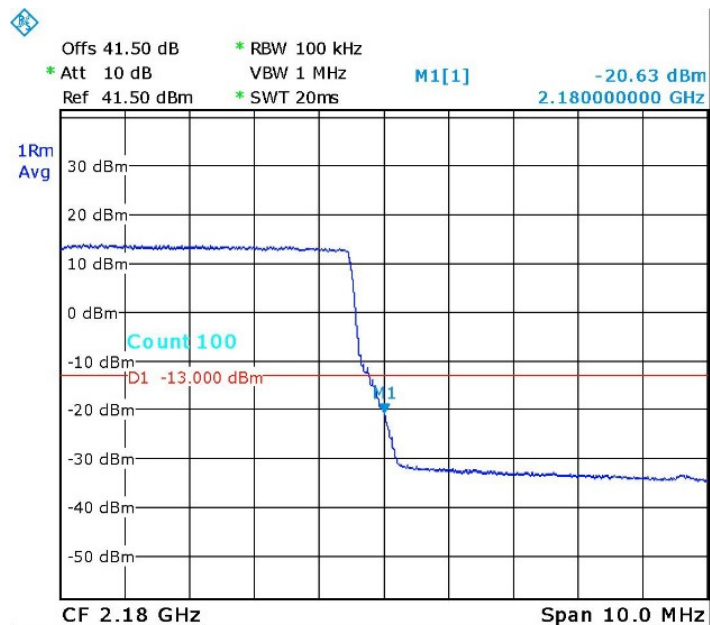

Date: 8.MAY.2017 11:27:10

Figure 54. — LTE 64QAM 2175.0 MHz

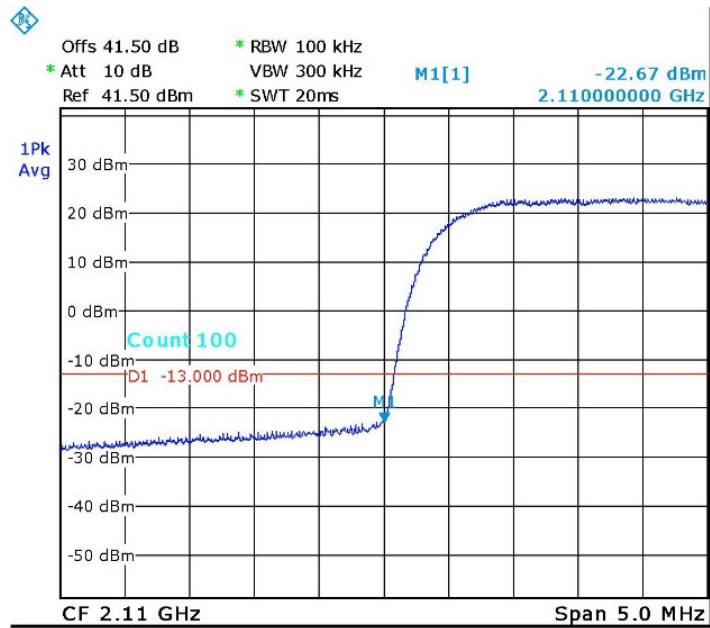

Date: 8.MAY.2017 11:35:08

Figure 55. — W-CDMA 2112.5 MHz

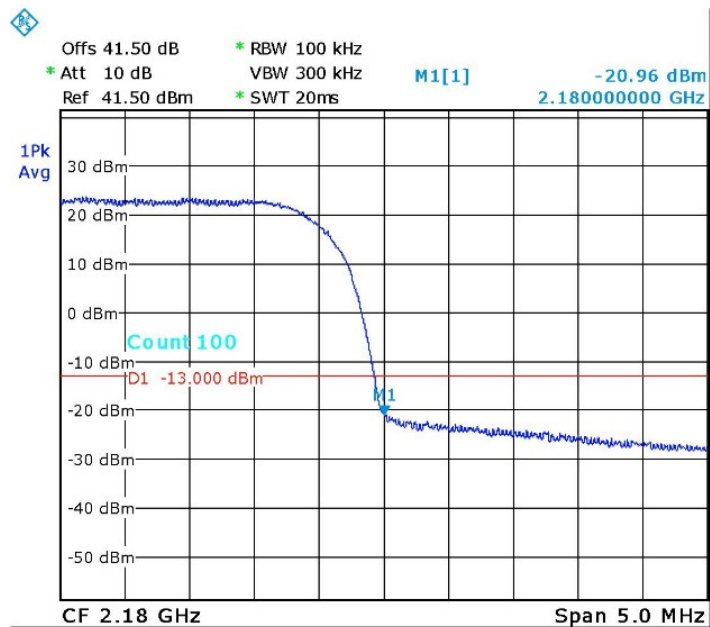

Date: 8.MAY.2017 11:34:18

Figure 56. — W-CDMA 2177.5 MHz



7.5 Test Equipment Used; Band Edge Spectrum AWS-3

Instrument	Manufacturer	Model	Serial Number	Calibration	
				Last Calibration Date	Next Calibration Due
Spectrum Analyzer	R&S	FSL6	100194	March 2, 2017	March 2, 2018
EXG Vector Signal Generator	Agilent	N5172B	MY53050697	June 19, 2016	June 19, 2019
40 dB Attenuator	Weinschel	WA 39-40-33	A1323	August 8, 2016	August 8, 2017

Figure 57 Test Equipment Used



8. Spurious Radiated Emission AWS-3

8.1 Test Specification

FCC, Part 27, Subpart C, Section 27.53(h)

8.2 Test Procedure

(Temperature (28°C)/ Humidity (50%RH))

The test method was based on ANSI/TIA-603-D: 2010, Section 2.2.12 Unwanted Emissions: Radiated Spurious.

The E.U.T. operation mode and test set-up are as described in Section 2 of this report.

For measurements between 0.009MHz-30.0MHz:

The E.U.T was tested inside the shielded room at a distance of 3 meters and the E.U.T was placed on a non-metallic table, 1.5 meters above the ground. The frequency range 0.009MHz-30MHz was scanned. The readings were maximized by the turntable azimuth between 0-360°, and the antenna polarization. The emissions were measured at a distance of 3 meters.

For measurements between 30.0MHz-1.0GHz:

A preliminary measurement to characterize the E.U.T was performed inside the shielded room at a distance of 3 meters, using peak detection mode and broadband antennas. The preliminary measurements produced a list of the highest emissions. The E.U.T was then transferred to the open site, and placed on a remote-controlled turntable. The E.U.T was placed on a non-metallic table, 0.8 meters above the ground. The frequency range 30.0MHz -1.0GHz was scanned and the list of the highest emissions was verified and updated accordingly. The readings were maximized by adjusting the antenna height between 1-4 meters, the turntable azimuth between 0-360°, and the antenna polarization. The emissions were measured at a distance of 3 meters.

For measurements between 1.0GHz-22.0GHz:

The E.U.T was tested inside the shielded room at a distance of 3 meters and the E.U.T was placed on a non-metallic table, 1.5 meters above the ground. The frequency range 1.0GHz -22.0GHz was scanned. The readings were maximized by the turntable azimuth between 0-360°, and the antenna polarization. The emissions were measured at a distance of 3 meters.

The E.U.T. was replaced by a substitution antenna (dipole 30MHz-1GHz, Horn Antenna above 1GHz) driven by a signal generator. The height was readjusted for maximum reading. The signal generator level was adjusted to obtain the same reading on the EMI receiver as in step (a).

The signals observed in step (a) were converted to radiated power using:

$$P_d(\text{dBm}) = P_g(\text{dBm}) - \text{Cable Loss (dB)} + \text{Substitution Antenna Gain (dBd)}$$

P_d = Dipole equivalent power (result).

P_g = Signal generator output level.

A Peak detector was used for this test.

The test was performed in 3 operation frequencies: low, mid and high.

Testing was performed when the RF port was connected to 50 Ω termination.

The table below describe only results with the highest radiation(GSM mode)

8.3 Test Limit

The power of any emission outside of the authorized operating frequency ranges (2110-2180 MHz) must be attenuated below the transmitting power (P) by a factor of at least $43 + 10 \log (P)$ dB, yielding -13dBm.

8.4 Test Results

Carrier Channel	Freq.	Antenna Pol.	Maximum Peak Level	Signal Generator RF Output	Cable Loss	Antenna Gain	Effective Radiated Power Level	Limit	Margin
(MHz)	(MHz)	(V/H)	(dBμV/m)	(dBm)	(dB)	(dBd)	(dBm)	(dBm)	(dB)
2111.2	4222.4	V	43.0	-62.2	0.5	7.4	-55.3	-13.0	-42.3
	4222.4	H	43.1	-62.0	0.5	7.4	-55.1	-13.0	-42.1
2145.0	4290.0	V	42.9	-62.2	0.5	7.4	-55.3	-13.0	-42.3
	4290.0	H	43.2	-62.0	0.5	7.4	-55.1	-13.0	-42.1
2178.8	4357.6	V	44.6	-60.0	0.5	7.4	-53.1	-13.0	-40.1
	4357.6	H	44.5	-60.0	0.5	7.4	-53.1	-13.0	-40.1

Figure 58 Spurious Radiated Emission AWS-3

JUDGEMENT: Passed by 40.1dB

The E.U.T met the requirements of the FCC, Part 27, Subpart C, Section 27.53 (h) specifications.



8.5 Test Instrumentation Used, Radiated Measurements AWS-3

Instrument	Manufacturer	Model	Serial Number	Calibration	
				Last Calibration Date	Next Calibration Due
EMI Receiver	HP	85422E	3906A00276	March 1, 2017	March 1, 2018
RF Filter Section	HP	85420E	3705A00248	March 1, 2017	March 1, 2018
EMI Receiver	R&S	ESCI7	100724	February 28, 2017	February 28, 2018
Spectrum Analyzer	HP	8593EM	3536A00120ADI	February 28, 2017	February 28, 2018
Active Loop Antenna	EMCO	6502	9506-2950	September 12, 2016	September 12, 2017
Antenna Biconical	EMCO	3110B	9912-3337	March 24, 2016	March 24, 2018
Antenna Log Periodic	EMCO	3146	9505-4081	April 23, 2016	May 31, 2017
Horn Antenna 1G-18G	ETS	3115	29845	May 19, 2015	May 19, 2018
Horn Antenna 18G-26G	ARA	SWH-28	1007	March 30, 2014	September 30, 2017
Low Noise Amplifier	Narda	LNA-DBS-0411N313	013	August 8, 2016	August 8, 2017
Low Noise Amplifier	Sophia Wireless	LNA 28-B	232	August 8, 2016	August 8, 2017
EXG Vector Signal Generator	Agilent	N5172B	MY53050697	June 19, 2016	June 19, 2019
40 dB Attenuator	Weinschel	WA 39-40-33	A1323	August 8, 2016	August 8, 2017
Semi Anechoic Civil Chamber	ETS	S81	SL 11643	N/A	N/A
Antenna Mast	ETS	2070-2	-	N/A	N/A
Turntable	ETS	2087	-	N/A	N/A
Mast & Table Controller	ETS/EMCO	2090	9608-1456	N/A	N/A

Figure 59 Test Equipment Used

9. Out-of-Band Rejection - AWS-3

9.1 Test Specification

KDB 935210 D05 v01r01, Section 3.3

9.2 Test Procedure

(Temperature (20°C)/ Humidity (35%RH))

The E.U.T. antenna terminal was connected to the spectrum analyzer through an external attenuator and an appropriate coaxial cable (max Loss= 41.5 dB).

The signal and spectrum analyzer frequency range was set to $\pm 250\%$ of the passband, Dwell time set to approximately 10msec.

RBW was set between 1% to 5% of the E.U.T passband and VBW set to $\geq 3 \cdot RBW$.

9.3 Test Limit

N/A

9.4 Test Results

JUDGEMENT: Passed

For additional information see *Figure 60* below.

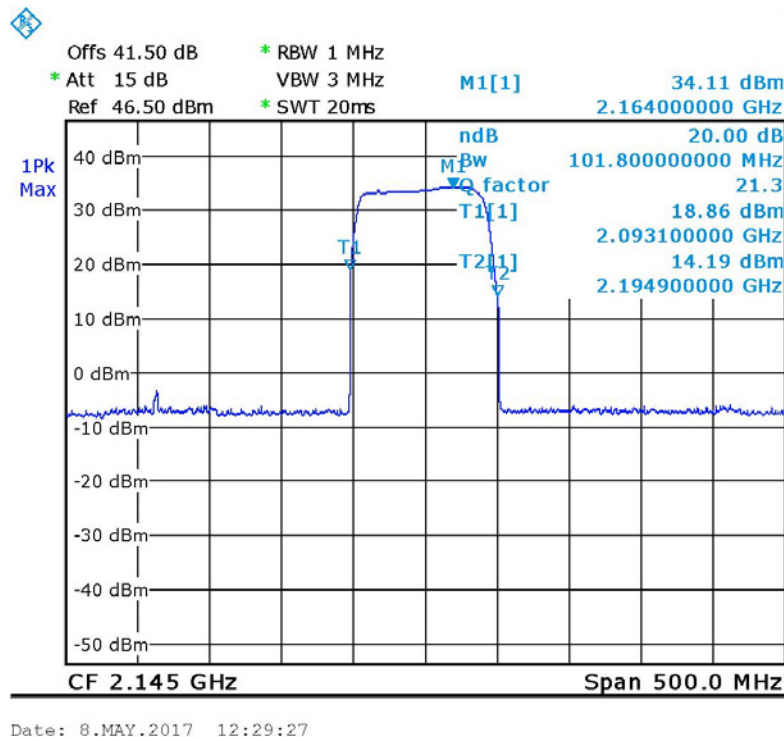

Figure 60. — Out-of-Band Rejection Plot



9.5 Test Equipment Used; Out-of-Band Rejection

Instrument	Manufacturer	Model	Serial Number	Calibration	
				Last Calibration Date	Next Calibration Due
Spectrum Analyzer	R&S	FSL6	100194	March 2, 2017	March 2, 2018
EXG Vector Signal Generator	Agilent	N5172B	MY53050697	June 19, 2016	June 19, 2019
40 dB Attenuator	Weinschel	WA 39-40-33	A1323	August 8, 2016	August 8, 2017

Figure 61 Test Equipment Used



10. APPENDIX A - CORRECTION FACTORS

10.1 Correction factors for RF OATS Cable 35m

ITL #1879

Frequency (MHz)	Cable loss (dB)
30.0	1.1
50.0	1.1
100.0	1.7
150.0	2.1
200.0	2.5
250.0	2.7
300.0	2.9
350.0	3.1
400.0	3.5
450.0	3.7
500.0	3.9
550.0	4.0
600.0	4.2
650.0	4.4
700.0	4.9
750.0	5.0
800.0	5.0
850.0	4.9
900.0	5.0
950.0	5.1
1000.0	5.4



10.2 Correction factors for biconical antenna – ITL # 1356

Model: EMCO 3110B

Serial No.:9912-3337

Frequency [MHz]	AF [dB/m]
30.0	14.18
35.0	13.95
40.0	12.84
45.0	11.23
50.0	11.10
60.0	10.39
70.0	9.34
80.0	9.02
90.0	9.31
100.0	8.95
120.0	11.53
140.0	12.20
160.0	12.56
180.0	13.49
200.0	15.27



10.3 Correction factors for log periodic antenna – ITL # 1349

Model: EMCO 3146

Serial No.:9505-4081

Frequency [MHz]	AF [dB/m]
200.0	11.47
250.0	12.06
300.0	14.77
400.0	15.77
500.0	18.01
600.0	18.84
700.0	20.93
800.0	21.27
900.0	22.44
1000.0	24.10



10.4 Correction factors for Active Loop Antenna
Model 6502 S/N 9506-2950
ITL # 1075:

f(MHz)	MAF(dBs/m)	AF(dB/m)
0.01	-33.1	18.4
0.02	-37.2	14.3
0.03	-38.2	13.3
0.05	-39.8	11.7
0.1	-40.1	11.4
0.2	-40.3	11.2
0.3	-40.3	11.2
0.5	-40.3	11.2
0.7	-40.3	11.2
1	-40.1	11.4
2	-40	11.5
3	-40	11.5
4	-40.1	11.4
5	-40.2	11.3
6	-40.4	11.1
7	-40.4	11.1
8	-40.4	11.1
9	-40.5	11
10	-40.5	11
20	-41.5	10
30	-43.5	8



10.5 Correction factors for Horn ANTENNA

Model: 3115

Serial number: 6142

3 meter range; ITL # 1352

f(GHz)	AF(dB/m)	GA(dB)
0.75	25	3
1G	23.5	7
1.5G	26	8
2G	29	7
2.5G	27.5	10
3G	30	10
3.5G	31.5	10
4G	32.5	9.5
4.5G	32.5	10.5
5G	33	10.5
5.5G	35	10.5
6G	36.5	9.5
6.5G	36.5	10
7G	37.5	10
7.5G	37.5	10
8G	37.5	11
8.5G	38	11
9G	37.5	11.5
9.5G	38	11.5
10G	38.5	11.5
10.5G	38.5	12
11G	38.5	12.5
11.5G	38.5	13
12G	38	13.5
12.5G	38.5	13
13G	40	12
13.5G	41	12
14G	40	13
14.5G	39	14
15G	38	15.5
15.5G	37.5	16
16G	37.5	16
16.5G	39	15
17G	40	15
17.5G	42	13.5
18G	42.5	13



10.6 Correction factors for

**Horn Antenna
Model: SWH-28
at 1 meter range.
ITL #:1353**

Frequency, MHz	Measured antenna factor, dB/ m ¹⁾
18000	33.0
18500	32.9
19000	33.1
19500	33.3
20000	33.6
20500	33.6
21000	33.4
21500	33.8
22000	33.7
22500	33.9
23000	34.8
23500	34.5
24000	34.2
24500	34.8
25000	34.4
25500	35.2
26000	35.9
26500	36.0



**10.7 Correction factor for RF CABLE for Semi Anechoic Chamber
ITL # 1841**

FREQ (MHz)	LOSS (dB)
1000.0	1.5
2000.0	2.1
3000.0	2.7
4000.0	3.1
5000.0	3.5
6000.0	4.1
7000.0	4.6
8000.0	4.9
9000.0	5.7
10000.0	5.7
11000.0	6.1
12000.0	6.1
13000.0	6.2
14000.0	6.7
15000.0	7.4
16000.0	7.5
17000.0	7.9
18000.0	8.1
19000.0	8.8
20000.0	9.1