

CORNING

# Building Wireless System (BWS) v1.0

Low Power Remote (LPR) User Manual



Corning Optical  
Communications  
[www.corning.com](http://www.corning.com)

# Building Wireless System (BWS®) v1.0 Low Power Remote (LPR) User Manual

BWS-006-AEN  
Issue 1

Related Literature | Search [www.corning.com/opcomm](http://www.corning.com/opcomm). Click "Resources/Standard Recommended Procedures."

## Proprietary Information

The information contained in this document is the sole property of Corning. The Disclosure of this information does not constitute the release of any proprietary rights therein. Permission to reproduce this information or parts disclosed herein must be obtained in writing from Corning.

# Preface Material

## Warranties

### ***Hardware Warranty***

Corning Optical Communications Wireless, Inc. (“Corning”) warrants to the original purchaser (“Customer”) that for the duration of the warranty period, one (1) year, commencing on the date of shipment of the Hardware, unless otherwise agreed in writing by Corning (the “Hardware Warranty Period”), the Hardware furnished by Corning shall be free in all material respects from defects in material and workmanship, and shall conform to the applicable portions of the Specifications, as defined below (the “Hardware Warranty”). If notified by Customer of any such defects in material or workmanship or nonconformity with applicable portions of the Specifications within the Hardware Warranty Period, Corning shall promptly, at its own election and expense, repair or replace any such Hardware proven to be defective under the terms of this Hardware Warranty. Such repair or replacement shall be Customer’s sole remedy and Corning’s sole obligation in the event this Hardware Warranty is invoked. If any components comprising a part of the Hardware are replaced or repaired during the Hardware Warranty Period, the Hardware Warranty Period for such repaired or replaced components shall extend to the longer of (i) the balance of the Hardware Warranty Period or (ii) three (3) months from the date of repair or replacement. For purposes of this Warranty, “Specifications” shall mean the specifications and performance standards of the Products as set forth in documents published by Corning and delivered to Customer which contain technical specifications or performance standards for the Products.

If Customer invokes this Hardware Warranty, it shall notify Corning promptly of the claimed defect. Customer will allow Corning to inspect the Hardware at Customer’s location, or to return the Hardware to Corning’s closest repair facility. For Hardware returned to Corning’s repair facility, Customer shall be responsible for payment of all transportation and freight costs (including insurance) to Corning’s repair facility, and Corning shall be responsible for all transportation and freight costs (including insurance) incurred in connection with the shipment of such Hardware to other repair facilities of Corning and/or its return to Customer.

Notwithstanding the foregoing, in no event will Corning be liable for damage to Products resulting from improper handling during or after shipment, misuse, neglect, improper installation, operation or repair (other than by authorized Corning personnel), alteration, accident, or for any other cause not attributable to defects in materials or workmanship on the part of Corning. Corning shall not reimburse or make any allowance to Customer for any labor charges incurred by Customer for replacement or repair of any goods unless such charges are authorized in advance in writing by Corning.

### ***Software Warranty***

Corning warrants to the original purchaser (“Customer”) that for the duration of the warranty period, one (1) year, commencing on the date of shipment of the Software, unless otherwise agreed in writing by Corning (the “Software Warranty Period”), the Software shall conform with, and perform the functions set forth in the Specifications, and shall be free from defects in material or workmanship (the “Software Warranty”). In the event the Software is proven to be defective under the terms of this Software Warranty, Corning shall correct such defects or failure and ensure that the Software conforms with, and performs the functions set forth in, the Specifications. Customer will allow Corning to inspect the Software at Customer’s location or to return it to Corning’s closest repair facility. Notwithstanding the foregoing, Corning shall have no obligation under the Software Warranty if the Software is modified or used with hardware or software not supplied or approved by Corning or if the Software is subject to abuse, improper installation or application, accident, electrical or environmental over-stress, negligence in use, storage, transportation or handling. Third-party software distributed with the Software may carry certain warranties which, to the maximum extent allowed by law, Corning hereby assigns, transfers and otherwise conveys to Customer, provided, however, that Corning itself provides no warranty of any kind, express, implied, statutory or otherwise, for any third-party software provided hereunder.

Corning does not warrant any hardware, software or services not provided by Corning.

THIS WARRANTY IS THE ONLY WARRANTY MADE BY CORNING AND IS IN LIEU OF ALL OTHER WARRANTIES, EXPRESS OR IMPLIED INCLUDING, BUT NOT LIMITED TO, THE IMPLIED WARRANTIES OF MERCHANTABILITY AND FITNESS FOR A PARTICULAR PURPOSE. CORNING SHALL NOT BE LIABLE FOR ANY OTHER DAMAGE INCLUDING, BUT NOT LIMITED TO, INDIRECT, SPECIAL OR CONSEQUENTIAL DAMAGES ARISING OUT OF OR IN CONNECTION WITH FURNISHING OF GOODS, PARTS AND SERVICE HEREUNDER, OR THE PERFORMANCE, USE OF, OR INABILITY TO USE THE GOODS, PARTS AND SERVICE. CORNING SALES AGENTS OR REPRESENTATIVES ARE NOT AUTHORIZED TO MAKE COMMITMENTS ON WARRANTY RETURNS.

### ***Returns***

above warranty, the following procedure shall be followed:

1. Return authorization is to be received from Corning prior to returning any unit. Advise Corning of the model, serial number, and discrepancy. The unit may then be forwarded to Corning, transportation prepaid. Devices returned collect or without authorization may not be accepted.
2. Prior to repair, Corning will advise the customer of our test results and any charges for repairing customer-caused problems or out-of-warranty conditions etc.

3. Repaired products are warranted for the balance of the original warranty period, or at least 90 days from date of shipment.

## **Limitations of Liabilities**

Corning's liability on any claim, of any kind, including negligence for any loss or damage arising from, connected with, or resulting from the purchase order, contract, quotation, or from the performance or breach thereof, or from the design, manufacture, sale, delivery, installation, inspection, operation or use of any equipment covered by or furnished under this contact, shall in no case exceed the purchase price of the device which gives rise to the claim.

Except as expressly provided herein, Corning makes no warranty, expressed or implied, with respect to any goods, parts and services provided in connection with this agreement including, but not limited to, the implied warranties of merchantability and fitness for a particular purpose.

Corning shall not be liable for any other damage including, but not limited to, indirect, special or consequential damages arising out of or in connection with furnishing of goods, parts and service hereunder, or the performance, use of, or inability to use the goods, parts and service.

## **Reporting Defects**

The units were inspected before shipment and found to be free of mechanical and electrical defects. Examine the units for any damage that may have been caused in transit. If damage is discovered, file a claim with the freight carrier immediately. Notify Corning as soon as possible in writing.

Note: Keep all packing material until you have completed the inspection.

## **Warnings and Admonishments**

There may be situations, particularly for workplace environments near high-powered RF sources, where recommended limits for safe exposure of human beings to RF energy could be exceeded. In such cases, restrictive measures or actions may be necessary to ensure the safe use of RF energy.

The equipment has been designed and constructed to prevent, as far as reasonably, practicable danger. Any work activity on or near equipment involving installation, operation or maintenance must be, as far as reasonably, free from danger.

Where there is a risk of damage to electrical systems involving adverse weather, extreme temperatures, wet, corrosive or dirty conditions, flammable or explosive atmospheres, the system must be suitably installed to prevent danger.

Equipment provided for the purpose of protecting individuals from electrical risk must be suitable for the purpose and properly maintained and used. This covers a range of activities including lifting, lowering, pushing, pulling, carrying, moving, holding or restraining an object, animal or person from the equipment. It also covers activities that require the use of force or effort, such as pulling a lever, or operating power tools.

Where some of the abovementioned activities are required, the equipment must be handled with care to avoid being damaged.

Observe standard precautions for handling ESD-sensitive devices. Assume that all solid-state electronic devices are ESD-sensitive.

Ensure the use of a grounded wrist strap or equivalent while working with ESD-sensitive devices. Transport, store, and handle ESD-sensitive devices in static-safe environments.

### **WARNINGS!**

- This is NOT a CONSUMER device. It is designed for installation by FCC LICENSEES and QUALIFIED INSTALLERS. You MUST have an FCC LICENSE or express consent of an FCC License to operate this device. Unauthorized use may result in significant forfeiture penalties, including penalties in excess of \$100,000 for each continuing violation.

## **RF Safety**

To comply with FCC RF exposure compliance requirement, adhere to the following warnings:

**Warning!** This product includes internal antennas, and must be fixed mounted on indoor permanent structures, providing a separation distance of at least 20 cm from all persons during normal operation.

**Warning!** Each product includes an internal antenna and must not be co-located with any other antenna for meeting RF exposure requirements.

**Warning!** The design of the antenna installation needs to be implemented in such a way so as to ensure RF radiation safety levels and non-environmental pollution during operation.

Compliance with RF Safety Requirements:

- Corning products have no inherent significant RF radiation.
- The RF level on the downlink is very low at the downlink ports. Therefore, there is no dangerous RF radiation when the antenna is not connected.

### **CAUTION!**

Use of controls, adjustments or performance of procedures other than those specified herein may result in hazardous radiation exposure.

Power Requirements for DC Inputs

**Warning!** Only use a special DC supply cable with connector

**Warning!** Always keep DC IN connectors connected during the product operation

**Warning!** Disconnect all power from the equipment by means of an external circuit breaker before connecting or disconnecting the DC IN connectors.

## ***Compliance with RF Safety Requirements:***

- Corning products have no inherent significant RF radiation.
- The RF level on the downlink is very low at the downlink ports. Therefore, there is no dangerous RF radiation when the antenna is not connected.

### **CAUTION!**

Use of controls, adjustments or performance of procedures other than those specified herein may result in hazardous radiation exposure.

Power Requirements for DC Inputs

**Warning!** Only use a special DC supply cable with connector

**Warning!** Always keep DC IN connectors connected during the product operation

**Warning!** Disconnect all power from the equipment by means of an external circuit breaker before connecting or disconnecting the DC IN connectors.

## ***Laser Safety***

- Fiber optic ports of the Corning BWS™ system emit invisible laser radiation.
- External optical power is less than 10 mW, Internal optical power is less than 500 mW.
- To avoid eye injury never look directly into the optical ports, patchcords or optical cables. Do not stare into beam or view directly with optical instruments. Always assume that optical outputs are on.
- Only technicians familiar with fiber optic safety practices and procedures should perform optical fiber connections and disconnections of Corning BWS devices and the associated cables.
- Corning BWS has been tested and certified as a Class 1 Laser product to IEC/EN 60825-1 (2007). It also meets the requirements for a Hazard Level 1 laser product to IEC/EN 60825-2: 2004 to the same degree.
- Corning BWS complies with 21 CFR 1040.10 and 1040.11 except for deviations pursuant to Laser Notice No. 50 (2007).

Care of Fiber Optic Connectors

- Do not remove the protective covers on the fiber optic connectors until a connection is ready to be made.

Do not leave connectors uncovered when not connected.

- The tip of the fiber optic connector should not come into contact with any object or dust.
- Refer to the cleaning procedure for information on the cleaning of the fiber tip.

## ***Company Certification***

Corning products have met the approvals of the following certifying organizations:

### ***Certification***

ISO 9001:2015

### ***Licensee Contact Information***

Industrial Boosters may only be used by FCC licensees or those given express (individualized) consent of license. Corning Optical Communications Wireless certifies all of the VARs listed as licensed installers for Corning. For the list of licensed VARs, please contact the Tech Support Hotline: (US) 410-553-2086 or 800-787-1266.

About This Guide

This user guide provides all the information necessary to understand the architecture and general installation procedures and requirements of Corning BWS™ Wireless Platform.

Note: The commissioning procedure, monitoring, and management capabilities and configuration options of the Corning BWS™ Wireless Platform elements are described in a dedicated User Manual (Corning BWS User Manual).

## ***Copyright***

Copyright © 2020 Corning., All Rights Reserved

## ***Conventions***

Important information is highlighted in a frame, as explained below:



---

*Warning: Actions requiring special attention to avoid serious bodily injury;*

*For example, working with high voltage components*

---



---

*Caution: Actions requiring special attention, to avoid possible damage to equipment*

---



---

*Note: Hints and recommendations for working efficiently*

---

## ***About This Manual***

This user manual provides all the information necessary to perform the Corning® Building Wireless Services (BWS™) solutions LPR management connections.

## ***Intended Users and Scope***

This manual is intended for Corning technicians and users. It is assumed that the user is familiar with the system and its units, and understands the basic functionality of the system.

## ***Contacting Technical Support HelpDesk***

Corning technical support contact information:

**email:** [cmatsg@corning.com](mailto:cmatsg@corning.com)

**Tel:** [800] 787 1266

## Revision History

Revision	Date	Created by	Reviewed by	Changes
0.1	January 2020	Christian Duran	Christian S Duran	First issue

## Table of Contents

1.	Introduction .....	9
1.1	Definitions, Acronyms, and Abbreviations .....	9
1.2	Applicable Documents .....	10
1.3	Overview: about BWS 1.0 Architecture .....	11
2.	General System Specifications and Requirements .....	14
2.1	Environmental and Regulatory Specifications .....	14
2.2	Power Specifications .....	14
2.3	System Level RF Parameters per Service .....	15
2.4	Dimensions and Weight of Units .....	16
2.5	Optical Specifications .....	16
3.	System Installation .....	17
3.2	LEDs .....	20
3.3	LPR Sub Elements .....	21
3.4	LPR Installation Steps .....	23
4.	Post Installation Steps .....	25
4.1	Unit Management .....	25



# 1. Introduction

Corning's BWS™ platform 1.0 is the first fully-digital, end-to-end in-building cellular solution, for medium size venues. It provides coverage of 200,000 – 500,000 square feet, of mobile communication voice and data traffic, covering a wide range of frequencies. Being a pure digital system dramatically reduces system costs, and the system foot print.

Corning's Low Power Remote (LPR) units are the end-point antennas connected by optical cable to the BWS system Digital Router Unit (DRU) (distribution/routing of RF samples via CPRI stream), and to the system Power Supply Unit (PSU) for power. The LPR units are installed underneath the frame of the acoustic or drop ceiling. LPR units provide plug-and-play, cost-effective processing while minimizing power loss and noise.

This chapter provides an overview of LPR interfaces, management and usage.

## 1.1 Definitions, Acronyms, and Abbreviations

Table 1 Abbreviations

Abbreviation	Description
BWS	Building Wireless System
DL	Down Link
UL	Up Link
DRU	Digital Router Unit
EBBU	Enterprise Base-Band Unit
LPR	Low Power Remote
CPRI	Common Public Radio Interface
EPC	Evolved Packet Core
GE / GigE	Gigabit Ethernet
MNO	Mobile Network Operator
RF	Radio Frequency
RN	Radio Node
SCPS	SpiderCloud Provisioning System
RF Channel / Cell Layer	Spectrum portion defined by specific RF CF (Center Frequency) and RF BW (Radio Bandwidth) licensed by particular MNO (Mobile Network Operator).  <i>Note: Internal EBBU/DRU APIs use actual Center Frequency (with 100 kHz granularity) and RF BW (MHz) units for RF Channel configuration.</i>
Cell	Radio network area, that can be uniquely identified by a User Equipment (Mobile Device).  The MNO distributes information of its users as cells (e.g.: if the EBBU has. EBBU can process up to 12 cells simultaneously. From DRU point of view, a cell is an information unit, transferred through the fiber cable.

Abbreviation	Description
	The DRU logic determines how to distribute the information internally, via the <b>clusterization</b> logic (see term below). A Cell is either FDD or TDD mode (also referred to as Sector).
Cluster	A group of LPRs, to which the data is distributed from a single cell. This is a DRU-level term.
AxC Channel	<ul style="list-style-type: none"> <li>Digital representation of RF data associated with particular EBBU cell signal and transmitted in CPRI data-frame (according to format defined in CPRI spec).</li> <li>One 2x2 MIMO RF channel is represented as 2 AxC channels in CPRI frame.</li> </ul>
DRU Cluster	<ul style="list-style-type: none"> <li>Sub-set of LPRs connected to specific DRU and associated with one specific EBBU cell.</li> <li>No intersection between clusters of specific RF channel is allowed</li> </ul>

## 1.2 Applicable Documents

*Table 2: References*

Document Name	Document #
LPR QUIS	BWS-005-AEN
LPR Specification sheet	BWS-004-AEN

### 1.3 Overview: about BWS 1.0 Architecture

BWS fully digital platform incorporates integrated capacity source Enterprise Base Band Units (EBBU) with the digital distribution units – Digital Router Unit (DRU) and Low Power Remote (LPR) units. The solution enables multi band and multi operator support, high scalability (both, in capacity and coverage) and provides simple migration paths to future technologies.

BWS 1.0 supports:

- EBBUs: Up to four high capacity sources per DRU
- LPR (Remotes): Up to 32 low power units per DRU
- DRUs: Up to four DRUs connected per EBBU
- Synchronization: 10 MHz clock domain

#### 1.3.1 Architecture and Interfaces

BWS system connects externally, through the EBBU, towards Core Network Providers’ Evolved Packet Core (EPC), over the S1 interface.

Internally, the BWS units are connected via Common Public Radio Interface (CPRI) lines.

The system internal configuration and management allows user access flexibility, and is done through EBBU and DRU units, according to the needs.

The following figure shows an example of the system’s internal and external connectivity.

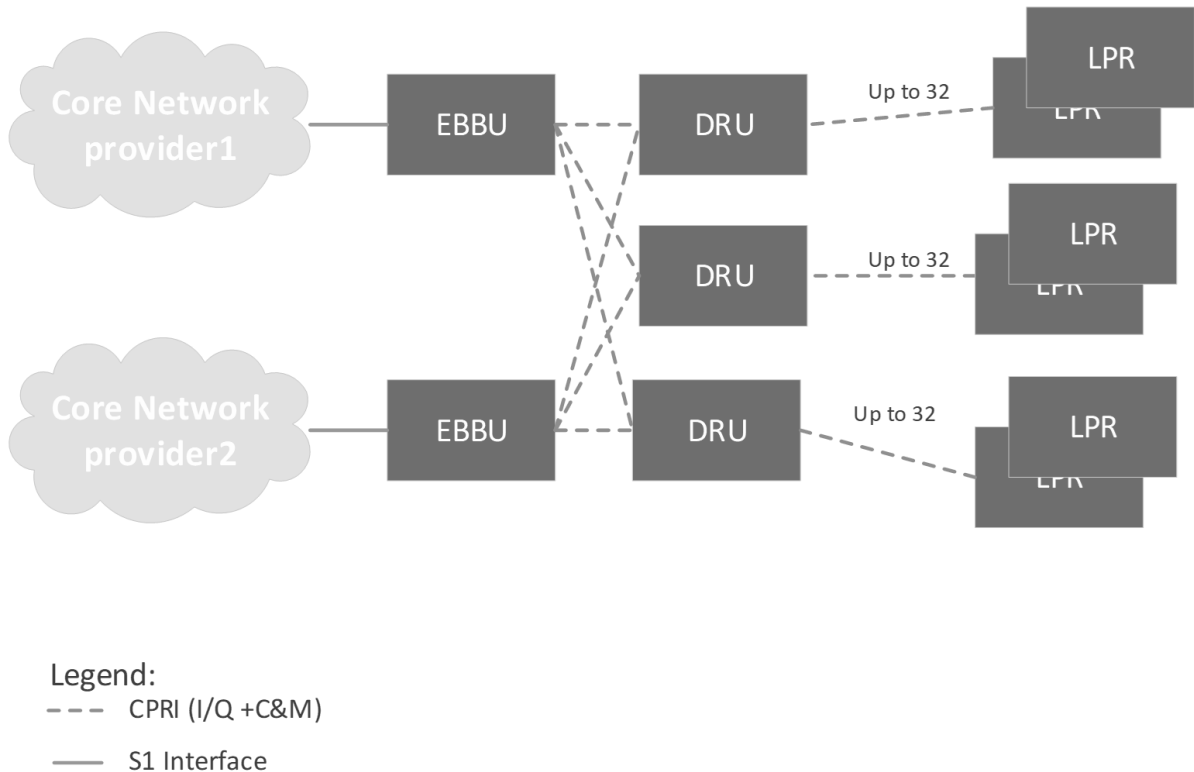





Figure 1 System Block Diagram

### 1.3.2 System Sub-Units

BWS includes three basic elements: Enterprise Base-Band Unit (EBBU), Digital Router Unit (DRU), Low Power Remote (LPR). The units and their general functionality are described in the following table.

Table 3: BWS Basic Units

Unit Name	Picture	Description
EBBU		<p>This unit connects to the core-network provider's base station, receives the RF signals, and distributes it towards BWS internal units.</p> <p>It connects to an operator's Evolved Packet Core (EPC) over the S1 interface. It connects to Corning's family of digital remotes using the Common Public Radio Interface (CPRI) through the DRU.</p>
DRU		<p>A fully-digital radio routing platform, performing distribution and routing of RF samples via CPRI stream, providing signal processing while minimizing power loss.</p>
LPR		<p>A digital radio remote unit, providing plug-and-play processing.</p> <p>LPR includes internal antennas, and supports the following frequencies: 5 MHz, 10 MHz, 15 MHz, 20 MHz</p> <p>Max coverage range for BWS 1.0: 5000 square feet.</p>

### 1.3.3 System Management Model

BWS internal configuration and management are done through two interfaces:

- Through the EBBU: using the EBBU GUI application named: Spider Cloud Provisioning Service (SCPS)
- Through DRU units: using the DRU GUI application.

---

*Note: LPRs do not have direct management ports, and are each managed through the DRU unit to which the LPR is physically connected.*

---

The system includes a single management user (type admin), and only one management session may be open at a time, to avoid conflicts, and provide better control of the system.

To manage the system, the user connects a computer to the management port of the relevant unit (DRU or EBBU), opens a session and updates the required parameters through the GUI, where:

- EBBU UI updates are done through the core network provider's network.
- DRU UI updates are performed directly through the DRU.

Two basic management states are distinguished:

- **Connectivity updates:** includes first time deployment and provisioning, connectivity changes. For these use cases, the EBBU calculates and distributes system schemes and maps to the connected DRUs.

The first-time provisioning includes:

1. Entering the EBBU data into:
  - a. The provider's network
  - b. The EBBU itself (via SCPS application)
2. The EBBU initiates an identification procedure of its MAC address.

As a result, the EBBU and the network "know" how to communicate.

- **On-going updates:** includes SW management, parameter settings, alarm monitoring etc. These actions are performed via the DRU.

---

*Note: the system management has a single user, of type Admin. Only one management session may be active at a time.*

---

The following figure shows the system management points.

## 2. General System Specifications and Requirements

### 2.1 Environmental and Regulatory Specifications

#### 2.1.1 Temperature and Humidity

The environmental specifications listed below are relevant to all Corning BWS™ solution devices.

*Table 4: Temperature and Humidity Specifications*

Attribute	Description
Operating temperature	0C to 40°C
Storage temperature	-40°C to 70°C
Humidity	Humidity 5% to 95%, non-condensing

#### 2.1.2 Safety and Regulatory Approvals

The safety and regulatory specifications listed below are relevant to all Corning BWS™ solution devices.

*Table 5: Safety and Regulatory Approvals*

Attribute	Description
EMC	FCC 47 CFR Part 15 Subpart B
ESD	IEC 61000-4-2
Safety compliance	IEC 62368-1/ cTUVus

### 2.2 Power Specifications

#### 2.2.1 LPR Power Input and Consumption

*Table 6: Units Power Consumption*

Attribute	Description
DC power source:	36-60 V DC
Max Power consumption	65W
Max input current	2A

## 2.3 System Level RF Parameters per Service

Service/Band	AWS+AWS3 1700 MHz		PCS 1900 MHz		WCS 2300 MHz	
	DL	UL	DL	UL	DL	UL
Frequency Range (MHz)	2110-2180	1710-1780	1930-1995	1850-1915	2350 - 2360	2305 – 2315
Maximum Output Power Per Antenna Port (dBm)	20		20		17	
Typical Antenna Gain (dBi)	1.25		0		3	
Maximum Intermod Distortion [dBm]	-13		-13		-13	
UL NF+(dB)		7		5		7.5
Gain Flatness/Ripple (dB)	±1.5		±2.0		±0.5	
UL Sensitivity		According to 3GPP 38.104 standard		According to 3GPP 38.104 standard		According to 3GPP 38.104 standard

### 2.3.1 Cable Gauge Requirements

The following table provides the information required to calculate the required power supply for the remote units.

Table 7: Required Cable Gauge

Unit	LPR (ft)
22 AWG	540

### 2.4 Dimensions and Weight of Units

The following figure provides the physical specifications of the Corning BWS™ LPR units

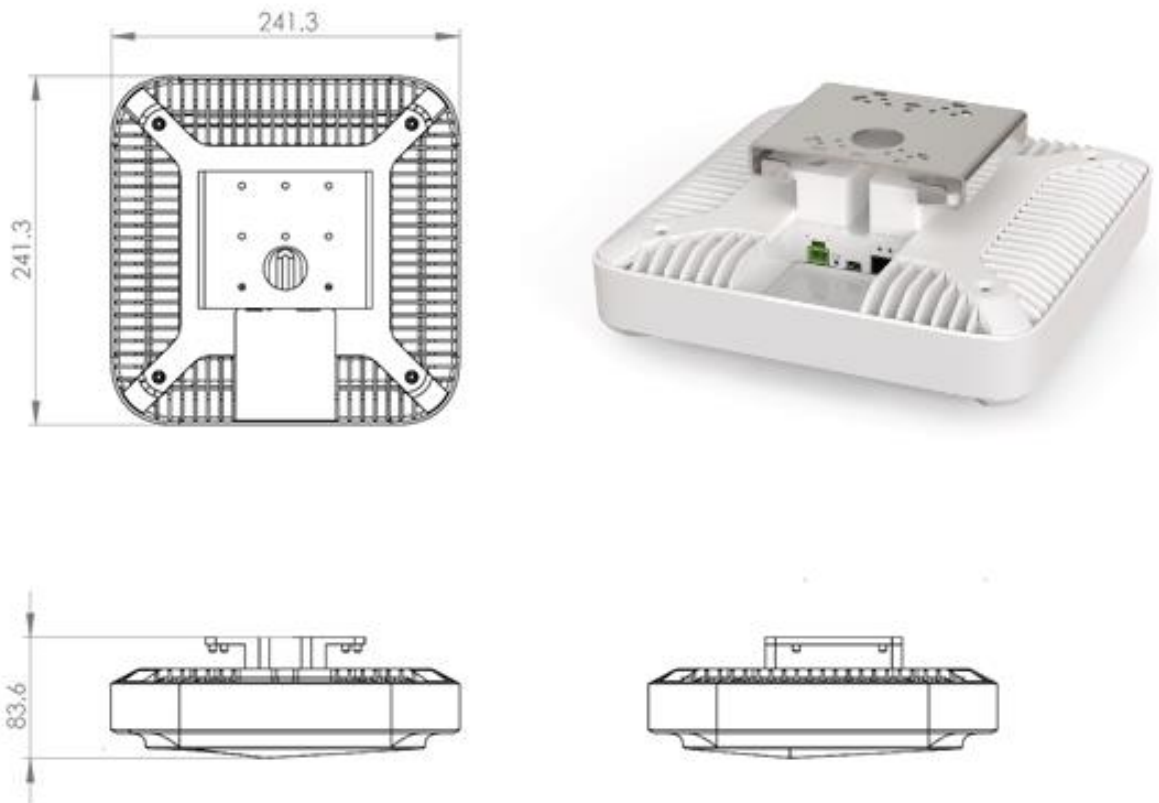

### 2.5 Optical Specifications

Supported SFP: 1 SFP port: 10.1 Gbps (CPRI Rate 8)



### **3. System Installation**

The system installation includes mounting of all the hardware units, connecting the wires, powering up (quick start), and software configuration.

These steps are described in the system UM. The specific installation steps per unit are detailed in its corresponding UM.

This chapter provides the interfaces of all the system units, and the detailed installation instructions of the LPR.

➤ HW Components and Interfaces

3.1.1 LPR interfaces in DRU

The following images indicate the DRU interfaces towards LPRs

➤ Front view

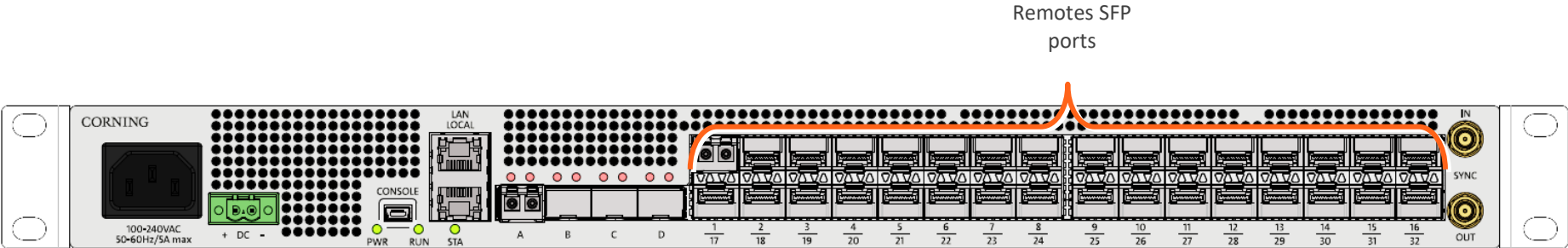

### 3.1.2 LPR External HW Interfaces

#### ➤ Connectors and LEDs

The following table and figure describe the LPR LEDs and the LED behaviour:

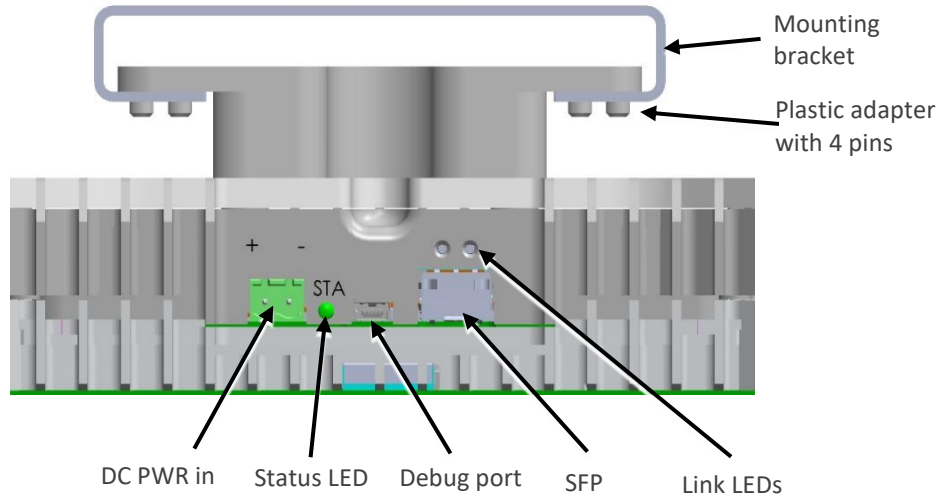

Attribute	Description	Number	Purpose
Power connector (DC PWR in)	2 pin DC feed- -36-60V connector	1	power
Status (STA) LED	Visual	1	LPR power & system live status and alarm
UART Debug port	Mini USB	1	ATE/Debug
Optical Port	SFP: Small form-factor pluggable SFP+ 10 Gbps	1	CPRI
2 SFP link LEDs	Visual	2	CPRI link LED status

## 3.2 LEDs

### 3.2.1 LPR LEDs



Status	Description	Color	State
Power Up	The LPR was powered up	Green	Solid
RUN	The system is up and running	Green	Blinking (1Hz)
Identify	Identify RU was activated	Green	Blinking (2Hz)
Over temperature	The LPR temperature exceeded the max. range	Red	Blinking (1Hz)
HW Failure	HW failure occurred	Red	Solid



### 3.2.2 SFP LEDs

Status	Description	LED State	
		Green	Amber
SFP Plugout	SFP Plugout	<i>OFF</i>	<i>OFF</i>
Optic Link Fail	<ul style="list-style-type: none"> <li>• Optic cable disconnected</li> <li>• SFP fail               <ul style="list-style-type: none"> <li>• SFP fault</li> <li>• SFP warning</li> <li>• SFP alarm</li> </ul> </li> </ul>	<i>OFF</i>	ON
	<ul style="list-style-type: none"> <li>• CPRI link down</li> </ul>		
Optic Link Ok	<ul style="list-style-type: none"> <li>• Optic cable connected</li> <li>• SFP ok</li> <li>• CPRI link down</li> </ul>	ON	ON
CPRI Link Ok	<ul style="list-style-type: none"> <li>• Optic cable connected</li> <li>• SFP ok</li> <li>• CPRI link up</li> </ul>	ON	<i>OFF</i>

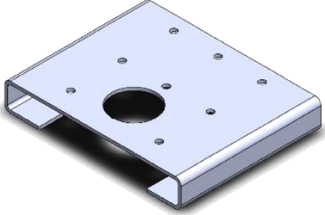
### 3.3 LPR Sub Elements

The following table indicates the included and required items for installing the LPR unit.

Item	Quantity	Image	Part Number
<b>HARDWARE – provided in the box</b>			
LPR unit	1		LPR-3C-2A2P2W-10
Mounting Bracket	1		264A358921
DC Power Adapter			255760003

Item	Quantity	Image	Part Number
<b>HARDWARE – not provided</b>			
4 screws #8 or 4mm (for attachment to ceiling)	4		
<b>SFP external connectors</b> (hot-pluggable optical module transceiver optical/digital); Support for CPRI option8 line-rate 10.1 GHz, single mode			
<b>SOFTWARE</b>			
NA			
<b>Required TOOLS</b>			
Phillips Screwdriver			

### 3.4 LPR Installation Steps

The following sections detail the LPR installation steps

#### 3.4.1 Mount the LPR

1. Connect the bracket to the mounting bracket to the frame below the acoustic or drop ceiling, using 4 mounting screws

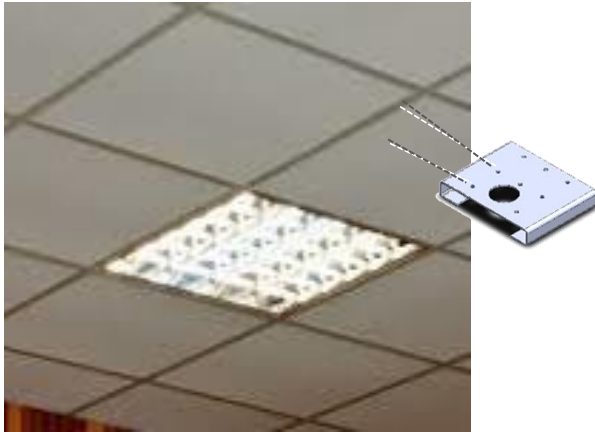

2. Slide the unit's plastic adapter into the mounting bracket rail, until the adapter's pins fall into the 4 holes in the bracket rail (Figure 1) ('click' sound)

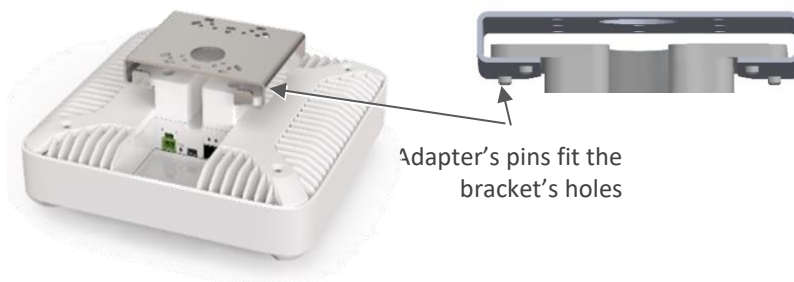

#### 3.4.2 Route the Cables

Route the optic cable and the power cable through the drop ceiling in to the designated slot in the mounting bracket

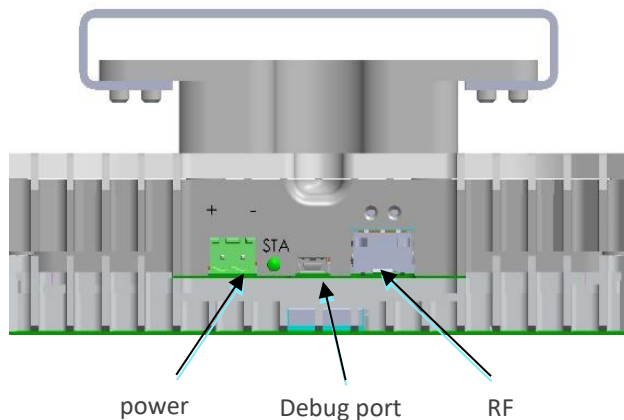

### 3.4.3 Connect the Cables

1. **Power:** Connect the DC wire pair (48V) to the LPR connectors panel, via the DC power adapter (terminal block connector).
2. **Optic cable:**
  - Remove the rubber stopper from the SFP connector located in the LPR RF port
  - Connect the optic cable to the LPR optic connector.
3. **LEDs:** Verify the power and link LEDs are lit green.

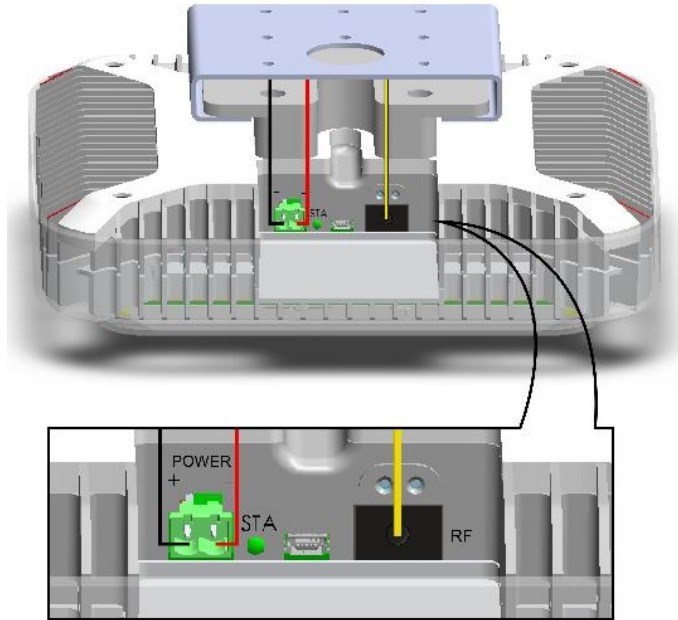

### 3.4.4 Verify Normal Operation

Verify the status LED blinking in green.

Verify CPRI link behaviour:

- If there is a CPRI link – the green LED above the SFP will light.
- If the optical cable is connected but the CPRI link was not established yet – the green and the amber LEDs will light together.



## 4. Post Installation Steps

After installing connecting and powering-on the LPRs, configure the LPR via the DRU connected to that specific LPR. Refer to the system UM for configuration and management needs.

### 4.1 Unit Management

To configure and manage the LPR and DRU units, the user needs to access the relevant DRU unit to which the LPR is physically connected. Another option is to access the overall system management mechanism, through the EBBU (refer to EBBU UM).

The user connects a laptop computer to the DRU management port, opens a session and updates the required parameters through the GUI.

2 RJ45: LAN for management  
Local for debug

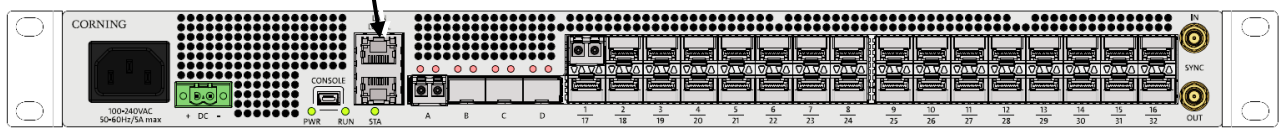

For further details refer to the system UM.