

400mm

100mm

175.8mm

351.6mm

Product: Power plug(US)
Model No.: G-809



Thunder
maunal



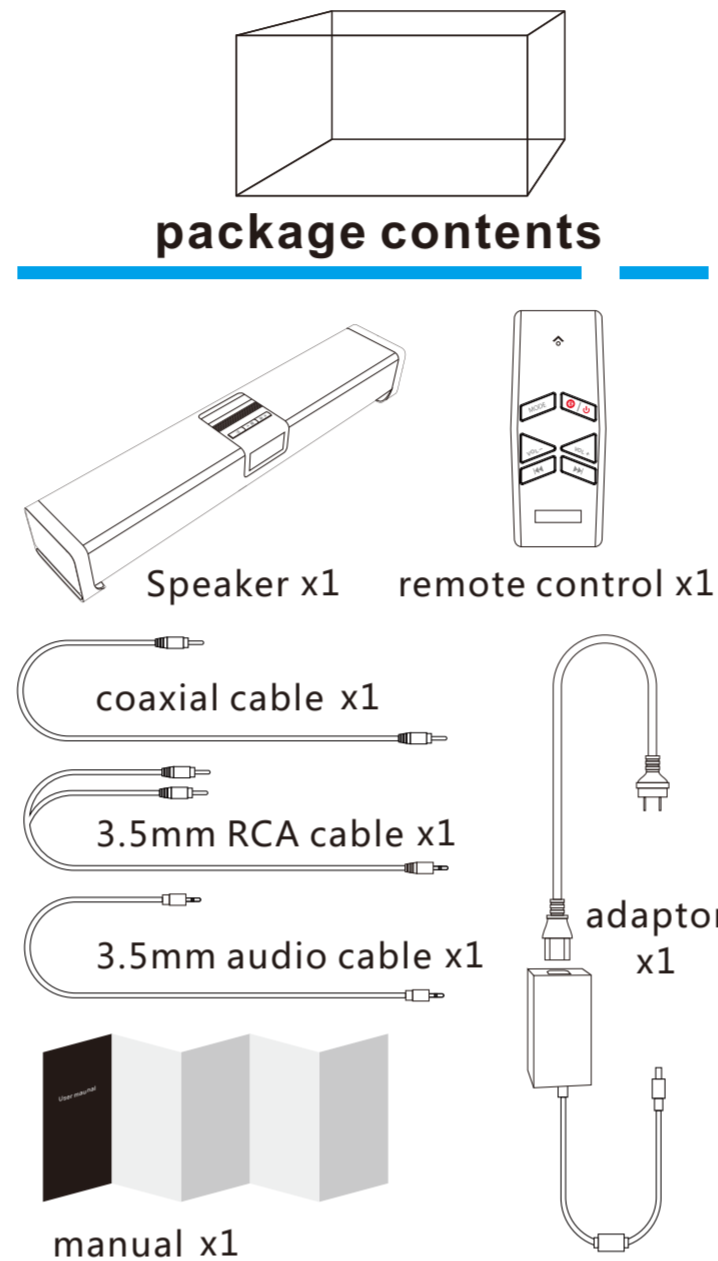

package contents



Keys

Power on/off, Pause

- ① **Long press:** power on/off
- ② **short press:** change different mode

mode sequence:
Bluetooth(screen display )→Aux in(screen display )→coaxial(screen display )→USB(screen display ) ,if have not insert USB,then speaker will not voice this mode.



Volume decrease/previous

- ① **Long press:** vloume decrease
- ② **Short:** previous songs

Next/Volume increase

- ① **Long press:** vloume increase
- ② **Short:** next songs

remote control can come ture

Remote control keys

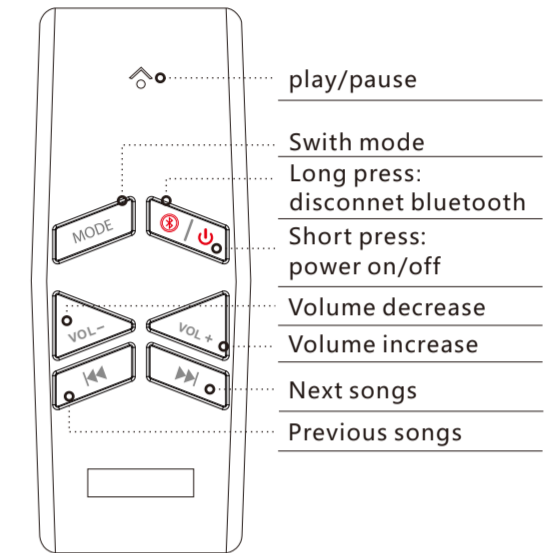

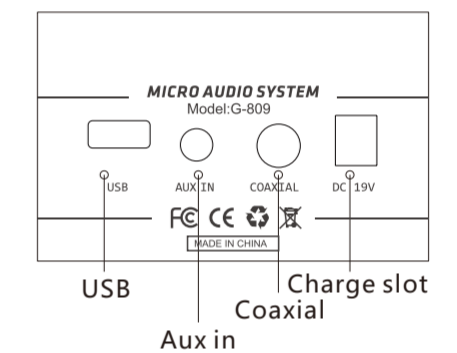

Slots



Remote controller Operate

① Power on/off & Disconnect Bluetooth

Short press: power on the speaker, then you can hear the voice guide(screen display ) , and twinkle), means the speaker waiting connect with other device, if not twinkle, means connected success. if press again, then power off this speaker.

Long press: disconnect the device, and searhing other bluetooth device(screen display ) ,and twinkle), if you want disconnect this device with exist device, just long press this button, then disconnect.

② Mode Switch

Mode sequence: **Bluetooth**→**Aux in**→**Coaxial**→**USB**

If have not insert USB, then speaker will not voice this mode.

③ Play/Pause/Mute

Short press this button to pause the music(screen dispaly ) , and twinkle),if press again, then playing music continue. Short press the button to come ture mute under Aux in mode or coaxial mode.

④ Volume adjust

Short press this button to adjust the volume(screen will display the volume number1-31),when max volume, the speaker will voice "du du" .

⑤ Previous/Next

Short press to change the previous and next sound (under Bluetooth, USB, Micro SD mode)

Operation instruction

Bluetooth: Power on this speaker, speaker will enter into Bluetooth mode, the speaker will voice guide(screen display ) , and twinkle)

① **Connect:** please turn on the Bluetooth function of you mobile/other devices. the "Thunder" will be found, please connect it, The mobile may remind you to input the pairing code, The speaker' s default pairing code is "0000".

② Press  choose the songs, press  play/pause



Aux in mode:

Use the 3.5mm audio cable included to speaker to an audio source(PC, MP3/MP4, mobile phone), Short press the **MODE** button to enter "AUX IN" mode(screen display ) , The speaker will play the music from the aduio source.

Coaxial mode:

Use the coaxial cable connect with device, short press the **MODE** button to switch to Coaxial (screen dispaly ) , then you can play the music or watch TV.

USB mode:

Insert USB after power on, press MODE button enter into USB mode(screen display ) , press  to choose the music, press  play/pause.

Technical Data

Impedance	6Ω(2pcs bass frequency speaker) 8Ω(4pcs full frequency speaker)
Output power	30W*2
Voltage	DC 19V
THD	H+R < 0.8%
Buletooth Version	Support Bluetooth V4.0
N.W	4.2Kg
Size	620*110*90mm

Features

- 1. Bluetooth connect**
Support 4.0 bluetooth version connect.
- 2. Aux in connect**
Work as the external speaker by connecting to the audio source of computer, mobile, PSP/MP3/MP4 etc.
- 3. LCD digital display**
Display the work mode, easy operate
- 4. USB flash music play**
Support MP3/WMA/APE music formate, max 32G
- 5. Remote control**
Support remote control to come ture different functon.
- 6. Coaxial decode function**
Support high quality Coaxial decode function.

Service

FCC NOTE:
This device complies with Part 15 of the FCC Rules. Operation is subject to the following two conditions: (1) this device may not cause harmful interference, and (2) this device must accept any interference received, including interference that may cause undesired operation.

THE MANUFACTURER IS NOT RESPONSIBLE FOR ANY RADIO OR TV INTERFERENCE CAUSED BY UNAUTHORIZED MODIFICATIONS OR CHANGE TO THIS EQUIPMENT. SUCH MODIFICATIONS OR CHANGE COULD VOID THE USER'S AUTHORITY TO OPERATE THE EQUIPMENT.

This equipment has been tested and found to comply with the limits for a Class B digital device, pursuant to part 15 of the FCC Rules. These limits are designed to provide reasonable protection against harmful interference in a residential installation. This equipment generates, uses and can radiate radio frequency energy and, if not installed and used in accordance with the instructions, may cause harmful interference to radio communications. However, there is no guarantee that interference will not occur in a particular installation. If this equipment does cause harmful interference to radio or television reception, which can be determined by turning the equipment off and on, the user is encouraged to try to correct the interference by one or more of the following measures:

- Reorient or relocate the receiving antenna.
- Increase the separation between the equipment and receiver.
- Connect the equipment into an outlet on a circuit different from that to which the receiver is connected.
- Consult the dealer or an experienced radio/TV technician for help.

This equipment complies with FCC radiation exposure limits set forth for an uncontrolled environment .The device has been evaluated to meet general RF exposure requirement. The device can be used in portable exposure condition without restriction.