

# FCC Radio Test Report

## FCC ID: OIE55926TR

### Original Grant

Report No. : TB-FCC178042  
Applicant : LB Technology Co., Ltd  
Equipment Under Test (EUT)  
EUT Name : Video Baby Monitor  
Model No. : JLB55926T  
Series Model No. : LB55926(BS)T, LB55926(CE)T  
Brand Name : LBtech, JLBtech, JLB7tech  
Sample ID : 20201214-22-1#  
Receipt Date : 2020-12-30  
Test Date : 2020-12-30 to 2021-01-21  
Issue Date : 2021-01-22  
Standards : FCC Part 15, Subpart C 15.247  
Test Method : ANSI C63.10: 2013  
Conclusions : **PASS**

In the configuration tested, the EUT complied with the standards specified above,  
The EUT technically complies with the FCC requirements

Test/Witness Engineer : Rebecca  
Engineer Supervisor : Ivan Su  
Engineer Manager : Ray Lai



This report details the results of the testing carried out on one sample. The results contained in this test report do not relate to other samples of the same product. The manufacturer should ensure that all products in series production are in conformity with the product sample detailed in the report.



---

---

## Contents

//

<b>CONTENTS</b> .....	<b>2</b>
<b>1. GENERAL INFORMATION ABOUT EUT</b> .....	<b>5</b>
1.1 Client Information.....	5
1.2 General Description of EUT (Equipment Under Test) .....	5
1.3 Block Diagram Showing the Configuration of System Tested.....	6
1.4 Description of Support Units .....	6
1.5 Description of Test Mode.....	7
1.6 Description of Test Software Setting .....	8
1.7 Measurement Uncertainty .....	8
1.8 Test Facility.....	9
<b>2. TEST SUMMARY</b> .....	<b>10</b>
<b>3. TEST SOFTWARE</b> .....	<b>10</b>
<b>4. TEST EQUIPMENT</b> .....	<b>11</b>
<b>5. CONDUCTED EMISSION TEST</b> .....	<b>12</b>
5.1 Test Standard and Limit.....	12
5.2 Test Setup.....	12
5.3 Test Procedure.....	13
5.4 Deviation From Test Standard.....	13
5.5 EUT Operating Mode .....	13
5.6 Test Data.....	13
<b>6. RADIATED EMISSION TEST</b> .....	<b>14</b>
6.1 Test Standard and Limit.....	14
6.2 Test Setup.....	15
6.3 Test Procedure.....	16
6.4 Deviation From Test Standard.....	17
6.5 EUT Operating Condition .....	17
6.6 Test Data.....	17
<b>7. RESTRICTED BANDS AND BAND-EDGE TEST</b> .....	<b>18</b>
7.1 Test Standard and Limit.....	18
7.2 Test Setup.....	18
7.3 Test Procedure.....	19
7.4 Deviation From Test Standard.....	19
7.5 EUT Operating Condition .....	19
7.6 Test Data.....	19
<b>8. NUMBER OF HOPPING CHANNEL</b> .....	<b>20</b>
8.1 Test Standard and Limit.....	20
8.2 Test Setup.....	20
8.3 Test Procedure.....	20



---

8.4 Deviation From Test Standard.....	20
8.5 EUT Operating Condition .....	20
8.6 Test Data.....	20
<b>9. AVERAGE TIME OF OCCUPANCY.....</b>	<b>21</b>
9.1 Test Standard and Limit.....	21
9.2 Test Setup.....	21
9.3 Test Procedure.....	21
9.4 EUT Operating Condition .....	21
9.4 Deviation From Test Standard.....	21
9.5 Test Data.....	21
<b>10. CHANNEL SEPARATION AND BANDWIDTH TEST .....</b>	<b>22</b>
10.1 Test Standard and Limit .....	22
10.2 Test Setup.....	22
10.3 Test Procedure.....	22
10.4 Deviation From Test Standard.....	22
10.5 EUT Operating Condition .....	22
10.6 Test Data.....	22
<b>11. PEAK OUTPUT POWER TEST.....</b>	<b>23</b>
11.1 Test Standard and Limit .....	23
11.2 Test Setup.....	23
11.3 Test Procedure.....	23
11.4 Deviation From Test Standard.....	23
11.5 EUT Operating Condition .....	23
11.6 Test Data.....	23
<b>12. ANTENNA REQUIREMENT.....</b>	<b>24</b>
12.1 Standard Requirement.....	24
12.2 Deviation From Test Standard.....	24
12.3 Antenna Connected Construction.....	24
12.4 Result.....	24
<b>ATTACHMENT A-- CONDUCTED EMISSION TEST DATA .....</b>	<b>25</b>
<b>ATTACHMENT B-- RADIATED EMISSION TEST DATA .....</b>	<b>27</b>
<b>ATTACHMENT C-- RESTRICTED BANDS REQUIREMENT TEST DATA.....</b>	<b>32</b>
<b>ATTACHMENT D-- NUMBER OF HOPPING CHANNEL TEST DATA.....</b>	<b>38</b>
<b>ATTACHMENT E-- AVERAGE TIME OF OCCUPANCY TEST DATA.....</b>	<b>39</b>
<b>ATTACHMENT F-- CHANNEL SEPARATION AND BANDWIDTH TEST DATA.....</b>	<b>41</b>
<b>ATTACHMENT G-- PEAK OUTPUT POWER TEST DATA .....</b>	<b>45</b>

## Revision History

Report No.	Version	Description	Issued Date
TB-FCC178042	Rev.01	Initial issue of report	2021-01-22



# 1. General Information about EUT

## 1.1 Client Information

<b>Applicant</b>	:	LB Technology Co., Ltd
<b>Address</b>	:	No. 5 of Xiaoyang Rd, First Industrial Park, Tanzhou Town, Zhongshan City, Guangdong, China
<b>Manufacturer</b>	:	LB Technology Co., Ltd
<b>Address</b>	:	No. 5 of Xiaoyang Rd, First Industrial Park, Tanzhou Town, Zhongshan City, Guangdong, China

## 1.2 General Description of EUT (Equipment Under Test)

<b>EUT Name</b>	:	Video Baby Monitor	
<b>Models No.</b>	:	JLB55926T, LB55926(BS)T, LB55926(CE)T	
<b>Model Difference</b>	:	All these models are identical in the same PCB, layout and electrical circuit, The only difference is brand name.	
<b>Product Description</b>	:	Operation Frequency:	2406MHz~2475MHz
	:	Number of Channel:	24 Channels <small>See Note 2</small>
	:	Max Peak Output Power:	18.638dBm
	:	Antenna Gain:	3dBi FPC Antenna
	:	Modulation Type:	GFSK (4Mbps)
<b>Power Rating</b>	:	DC 5V from Adapter(ZD5C050100USW) Input: 100-240V~, 50/60Hz, 0.2A Output: DC 5V 1000mA	
<b>Software Version</b>	:	VC0902	
<b>Hardware Version</b>	:	V1.0.0	
<b>Remark</b>	:	The adapter and antenna gain provided by the applicant, the verified for the RF conduction test provided by TOBY test lab.	

**Note:**

- (1) For a more detailed features description, please refer to the manufacturer's specifications or the User's Manual.

(2) Channel List:

Channel List					
Channel	Frequency (MHz)	Channel	Frequency (MHz)	Channel	Frequency (MHz)
01	2406	09	2430	17	2454
02	2409	10	2433	18	2457
03	2412	11	2436	19	2460
04	2415	12	2439	20	2463
05	2418	13	2442	21	2466
06	2421	14	2445	22	2469
07	2424	15	2448	23	2472
08	2427	16	2451	24	2475

Note: Test frequencies are lowest channel: 2406 MHz, middle channel: 2442 MHz and highest channel: 2475 MHz.

(3) The Antenna information about the equipment is provided by the applicant.

1.3 Block Diagram Showing the Configuration of System Tested

**Adapter & TX Mode**

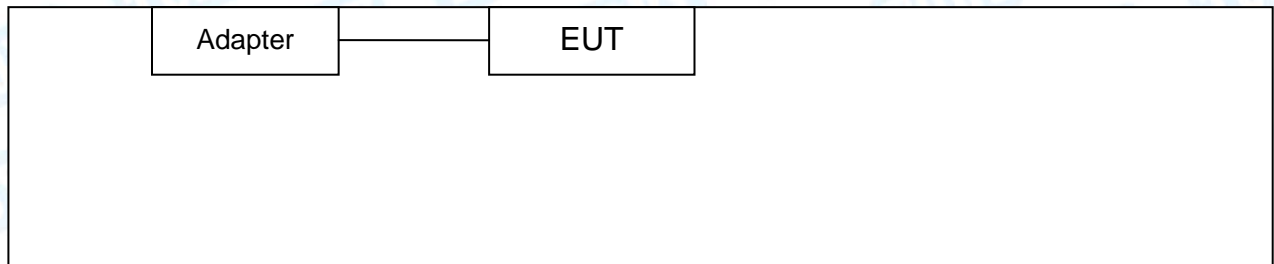

1.4 Description of Support Units

The EUT has been tested as an independent unit.



## 1.5 Description of Test Mode

To investigate the maximum EMI emission characteristics generates from EUT, the test system was pre-scanning tested base on the consideration of following EUT operation mode or test configuration mode which possible have effect on EMI emission level. Each of these EUT operation mode(s) or test configuration mode(s) mentioned follow was evaluated respectively.

For Conducted Test	
Final Test Mode	Description
Mode 1	Adapter+ TX Mode

For Radiated Test	
Final Test Mode	Description
Mode 1	TX GFSK Mode
Mode 2	TX Mode(GFSK) Channel 01/13/24

**Note:**

- (1) For all test, we have verified the construction and function in typical operation. And all the test modes were carried out with the EUT in transmitting operation in maximum power with all kinds of data rate. We have pretested all the test modes above.  
According to ANSI C63.10 standards, the measurements are performed at the highest, middle, lowest available channels, and the worst case data rate as follows:  
TX Mode: GFSK (4Mbps)
- (2) The EUT is considered a Mobile unit; it was pre-tested on the positioned of each 3 axis, X-plane, Y-plane and Z-plane. The worst case was found positioned on X-plane as the normal use. Therefore only the test data of this X-plane was used for radiated emission measurement test.



## 1.6 Description of Test Software Setting

During testing channel power controlling software provided by the customer was used to control the operating channel as well as the output power level. The RF output power selection is for the setting of RF output power expected by the customer and is going to be fixed on the firmware of the final end product power parameters of Bluetooth mode.

Test Software Version	Control by pressing the button		
Frequency	2406 MHz	2442 MHz	2475 MHz
GFSK	DEF	DEF	DEF

## 1.7 Measurement Uncertainty

The reported uncertainty of measurement  $y \pm U$ , where expanded uncertainty  $U$  is based on a standard uncertainty multiplied by a coverage factor of  $k=2$ , providing a level of confidence of approximately 95 %.

Test Item	Parameters	Expanded Uncertainty ( $U_{Lab}$ )
Conducted Emission	Level Accuracy: 9kHz~150kHz 150kHz to 30MHz	$\pm 3.50$ dB $\pm 3.10$ dB
Radiated Emission	Level Accuracy: 9kHz to 30 MHz	$\pm 4.60$ dB
Radiated Emission	Level Accuracy: 30MHz to 1000 MHz	$\pm 4.50$ dB
Radiated Emission	Level Accuracy: Above 1000MHz	$\pm 4.20$ dB



## 1.8 Test Facility

The testing report were performed by the Shenzhen Toby Technology Co., Ltd., in their facilities located at 1A/F., Bldg.6, Yusheng Industrial Zone, The National Road No.107 Xixiang Section 467, Xixiang, Bao'an, Shenzhen, Guangdong, China. At the time of testing, the following bodies accredited the Laboratory:

### **CNAS (L5813)**

The Laboratory has been accredited by CNAS to ISO/IEC 17025: 2017 General Requirements for the Competence of Testing and Calibration Laboratories for the competence in the field of testing. And the Registration No.: CNAS L5813.

### **A2LA Certificate No.: 4750.01**

The laboratory has been accredited by American Association for Laboratory Accreditation(A2LA) to ISO/IEC 17025: 2017 General Requirements for the Competence of Testing and Calibration Laboratories for the technical competence in the field of Electrical Testing. And the A2LA Certificate No.: 4750.01. FCC Accredited Test Site Number: 854351. Designation Number: CN1223.

### **IC Registration No.: (11950A)**

The Laboratory has been registered by Certification and Engineering Bureau of Industry Canada for radio equipment testing. The site registration: Site# 11950A.



## 2. Test Summary

FCC Part 15 Subpart C(15.247)/ RSS 247 Issue 2					
Standard Section		Test Item	Test Sample(s)	Judgment	Remark
FCC	IC				
15.203		Antenna Requirement	20201214-22-1#	PASS	N/A
15.207	RSS-GEN 7.2.2	Conducted Emission	20201214-22-1#	PASS	N/A
15.205	RSS-Gen 7.2.3	Restricted Bands	20201214-22-1#	PASS	N/A
15.247(a)(1)	RSS 247 5.1 (2)	Hopping Channel Separation	20201214-22-1#	PASS	N/A
15.247(a)(1)	RSS 247 5.1 (4)	Dwell Time	20201214-22-1#	PASS	N/A
15.247(b)(1)	RSS 247 5.4 (2)	Peak Output Power	20201214-22-1#	PASS	N/A
15.247(b)(1)	RSS 247 5.1 (4)	Number of Hopping Frequency	20201214-22-1#	PASS	N/A
15.247(d)	RSS 247 5.5	Band Edge	20201214-22-1#	PASS	N/A
15.247(c)& 15.209	RSS 247 5.5	Radiated Spurious Emission	20201214-22-1#	PASS	N/A
15.247(a)	RSS 247 5.1 (1)	99% Occupied Bandwidth & 20dB Bandwidth	20201214-22-1#	PASS	N/A

**Note:** N/A is an abbreviation for Not Applicable.

## 3. Test Software

Test Item	Test Software	Manufacturer	Version No.
Conducted Emission	EZ-EMC	EZ	CDI-03A2
Radiation Emission	EZ-EMC	EZ	FA-03A2RE
RF Conducted Measurement	MTS-8310	MWRfTest	V2.0.0.0



## 4. Test Equipment

Conducted Emission Test					
Equipment	Manufacturer	Model No.	Serial No.	Last Cal.	Cal. Due Date
EMI Test Receiver	Rohde & Schwarz	ESCI	100321	Jul. 06, 2020	Jul. 05, 2021
RF Switching Unit	Compliance Direction Systems Inc	RSU-A4	34403	Jul. 06, 2020	Jul. 05, 2021
AMN	SCHWARZBECK	NNBL 8226-2	8226-2/164	Jul. 06, 2020	Jul. 05, 2021
LISN	Rohde & Schwarz	ENV216	101131	Jul. 06, 2020	Jul. 05, 2021
Radiation Emission Test					
Equipment	Manufacturer	Model No.	Serial No.	Last Cal.	Cal. Due Date
Spectrum Analyzer	Agilent	E4407B	MY45106456	Jul. 06, 2020	Jul. 05, 2021
EMI Test Receiver	Rohde & Schwarz	ESPI	100010/007	Jul. 06, 2020	Jul. 05, 2021
Spectrum Analyzer	Rohde & Schwarz	FSVR	102197	Jul. 06, 2020	Jul. 05, 2021
Bilog Antenna	ETS-LINDGREN	3142E	00117537	Mar.01, 2020	Feb. 28, 2022
Horn Antenna	ETS-LINDGREN	3117	00143207	Mar.01, 2020	Feb. 28, 2022
Horn Antenna	ETS-LINDGREN	BBHA 9170	BBHA9170582	Mar.01, 2020	Feb. 28, 2022
Loop Antenna	SCHWARZBECK	FMZB 1519 B	1519B-059	Jul. 07, 2020	Jul. 06, 2021
Pre-amplifier	Sonoma	310N	185903	Mar.01, 2020	Feb. 28, 2021
Pre-amplifier	HP	8449B	3008A00849	Mar.01, 2020	Feb. 28, 2021
Cable	HUBER+SUHNER	100	SUCOFLEX	Mar.01, 2020	Feb. 28, 2021
Positioning Controller	ETS-LINDGREN	2090	N/A	N/A	N/A
Antenna Conducted Emission					
Equipment	Manufacturer	Model No.	Serial No.	Last Cal.	Cal. Due Date
Spectrum Analyzer	Agilent	E4407B	MY45106456	Jul. 06, 2020	Jul. 05, 2021
Spectrum Analyzer	Rohde & Schwarz	ESCI	100010/007	Jul. 06, 2020	Jul. 05, 2021
MXA Signal Analyzer	Agilent	N9020A	MY49100060	Sep. 11, 2020	Sep. 10, 2021
Vector Signal Generator	Agilent	N5182A	MY50141294	Sep. 11, 2020	Sep. 10, 2021
Analog Signal Generator	Agilent	N5181A	MY50141953	Sep. 11, 2020	Sep. 10, 2021
RF Power Sensor	DARE!! Instruments	RadiPowerRPR3006W	17100015SNO26	Sep. 11, 2020	Sep. 10, 2021
	DARE!! Instruments	RadiPowerRPR3006W	17100015SNO29	Sep. 11, 2020	Sep. 10, 2021
	DARE!! Instruments	RadiPowerRPR3006W	17100015SNO31	Sep. 11, 2020	Sep. 10, 2021
	DARE!! Instruments	RadiPowerRPR3006W	17100015SNO33	Sep. 11, 2020	Sep. 10, 2021



# 5. Conducted Emission Test

## 5.1 Test Standard and Limit

5.1.1 Test Standard  
FCC Part 15.207/RSS-GEN 8.8

5.1.2 Test Limit

**Conducted Emission Test Limit**

Frequency	Maximum RF Line Voltage (dB $\mu$ V)	
	Quasi-peak Level	Average Level
150kHz~500kHz	66 ~ 56 *	56 ~ 46 *
500kHz~5MHz	56	46
5MHz~30MHz	60	50

Notes:

- (1) \*Decreasing linearly with logarithm of the frequency.
- (2) The lower limit shall apply at the transition frequencies.
- (3) The limit decrease in line with the logarithm of the frequency in the range of 0.15 to 0.50MHz.

## 5.2 Test Setup

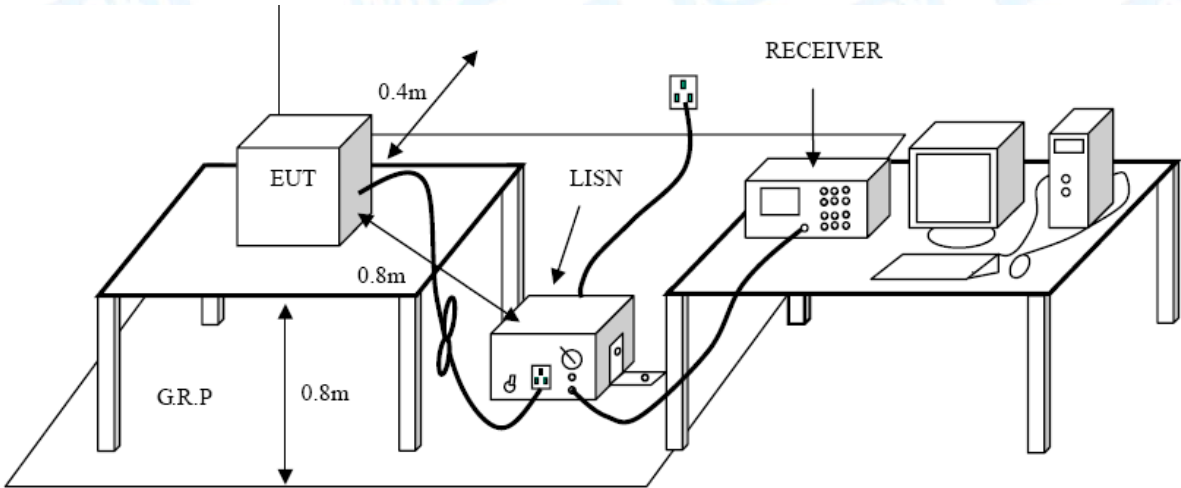



### 5.3 Test Procedure

The EUT was placed 0.8 meters from the horizontal ground plane with EUT being connected to the power mains through a line impedance stabilization network (LISN). All other support equipments powered from additional LISN(s). The LISN provide 50 Ohm/50uH of coupling impedance for the measuring instrument.

Interconnecting cables that hang closer than 40 cm to the ground plane shall be folded back and forth in the center forming a bundle 30 to 40 cm long.

I/O cables that are not connected to a peripheral shall be bundled in the center. The end of the cable may be terminated, if required, using the correct terminating impedance. The overall length shall not exceed 1 m.

LISN at least 80 cm from nearest part of EUT chassis

The bandwidth of EMI test receiver is set at 9kHz, and the test frequency band is from 0.15MHz to 30MHz.

### 5.4 Deviation From Test Standard

No deviation

### 5.5 EUT Operating Mode

Please refer to the description of test mode.

### 5.6 Test Data

Please refer to the Attachment A.



## 6. Radiated Emission Test

### 6.1 Test Standard and Limit

#### 6.1.1 Test Standard

FCC Part 15.209/RSS-GEN 8.9

#### 6.1.2 Test Limit

#### Radiated Emission Limit (9 kHz~1000MHz)

Frequency (MHz)	Field Strength (microvolt/meter)	Measurement Distance (meters)
0.009~0.490	2400/F(KHz)	300
0.490~1.705	24000/F(KHz)	30
1.705~30.0	30	30
30~88	100	3
88~216	150	3
216~960	200	3
Above 960	500	3

#### Radiated Emission Limit (Above 1000MHz)

Frequency (MHz)	Distance Meters(at 3m)	
	Peak	Average
Above 1000	74	54

**Note:**

- (1) The tighter limit applies at the band edges.
- (2) Emission Level (dBuV/m)=20log Emission Level (uV/m)



6.2 Test Setup

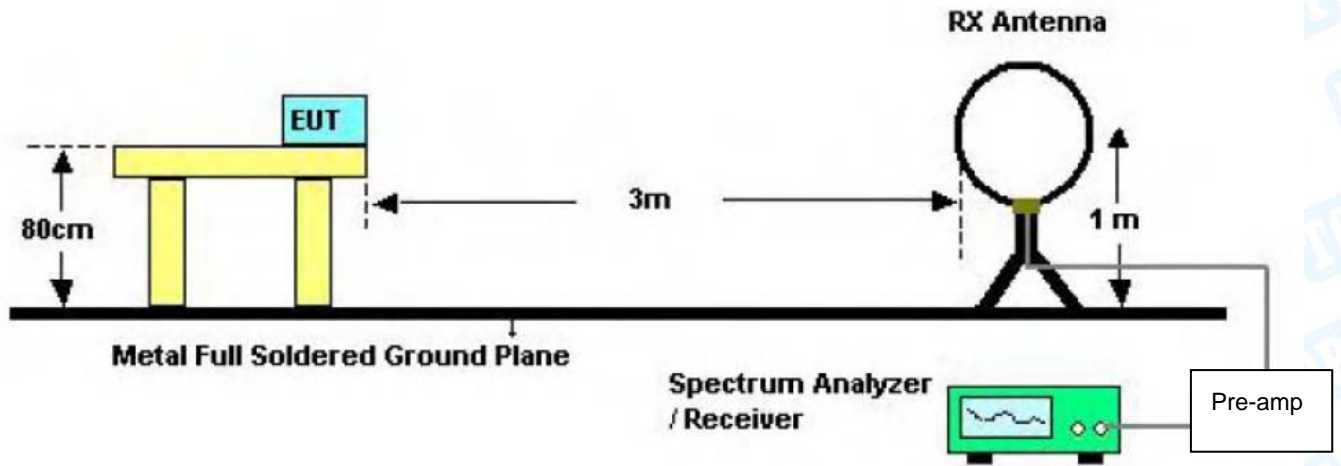

Below 30MHz Test Setup

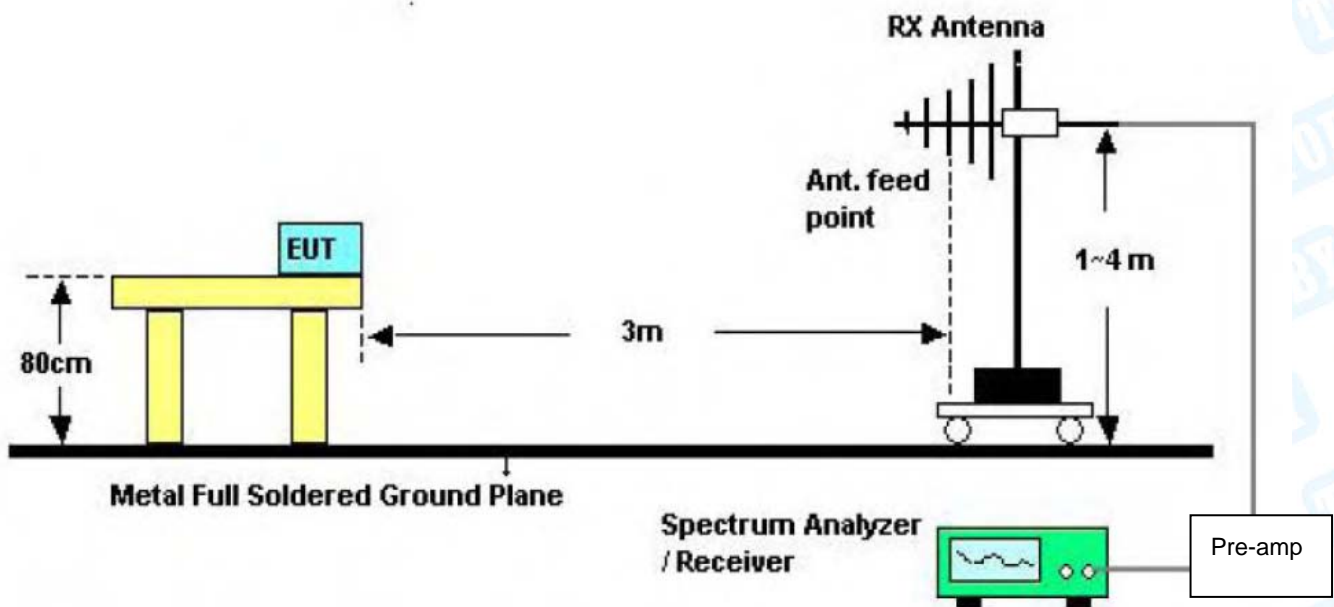

Below 1000MHz Test Setup

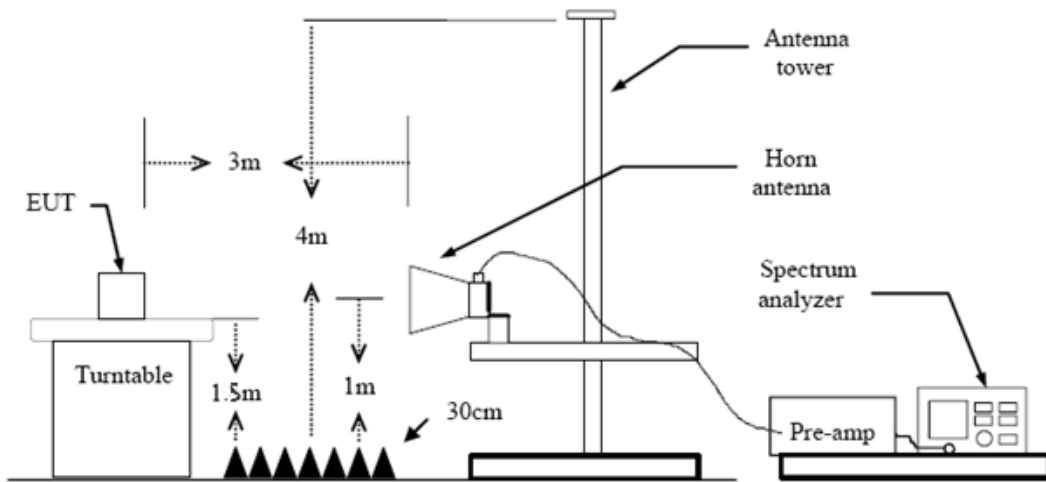

Above 1GHz Test Setup

### 6.3 Test Procedure

- (1) Measurements at frequency above 1GHz. The EUT was placed on a rotating 1.5m high above the ground. RF absorbers covered the ground plane with a minimum area of 3.0m by 3.0m between the EUT and measurement receiver antenna. The RF absorber shall not exceed 30cm in high above the conducting floor. The table was rotated 360 degrees to determine the position of the highest radiation.
- (2) Measurements at frequency Below 1GHz. The EUT was placed on a rotating 0.8m high above the ground. RF absorbers covered the ground plane with a minimum area of 3.0m by 3.0m between the EUT and measurement receiver antenna. The RF absorber shall not exceed 30cm in high above the conducting floor. The table was rotated 360 degrees to determine the position of the highest radiation.
- (3) The Test antenna shall vary between 1m and 4m, Both Horizontal and Vertical antenna are set to make measurement.
- (4) The initial step in collecting conducted emission data is a spectrum analyzer peak detector mode pre-scanning the measurement frequency range. Significant peaks are then marked and then Quasi Peak detector mode re-measured.
- (5) If the Peak Mode measured value compliance with and lower than Quasi Peak Mode Limit Bellow 1 GHz, the EUT shall be deemed to meet QP Limits and then no additional QP Mode measurement performed. But the Peak Value and average value both need to comply with applicable limit above 1 GHz.
- (6) Testing frequency range below 1GHz the measuring instrument use VBW=120 kHz with Quasi-peak detection.
- (7) Testing frequency range above 1GHz the measuring instrument use RBW=1 MHz and VBW=3 MHz with Peak Detector for Peak Values, and use RBW=1 MHz and VBW=10 Hz with Peak Detector for Average Values.
- (8) For the actual test configuration, please see the test setup photo.



## 6.4 Deviation From Test Standard

No deviation

## 6.5 EUT Operating Condition

The Equipment Under Test was set to Continual Transmitting in maximum power.

## 6.6 Test Data

Remark: During testing above 1GHz the measuring instrument use RBW=1 MHz and VBW=3 MHz with Peak Detector for Peak Values, and use RBW=1 MHz and VBW=10 Hz with Peak Detector for Average Values.

Please refer to the Attachment B.

## 7. Restricted Bands and Band-edge test

### 7.1 Test Standard and Limit

- 7.1.1 Test Standard  
FCC Part 15.209&15.205  
RSS-GEN 8.9&8.10
- 7.1.2 Test Limit

Restricted Frequency Band (MHz)	Distance Meters(at 3m)	
	Peak	Average
2310 ~2390	74	54
2483.5 ~2500	74	54

**Note: All restriction bands have been tested, only the worst case is reported.**

### 7.2 Test Setup

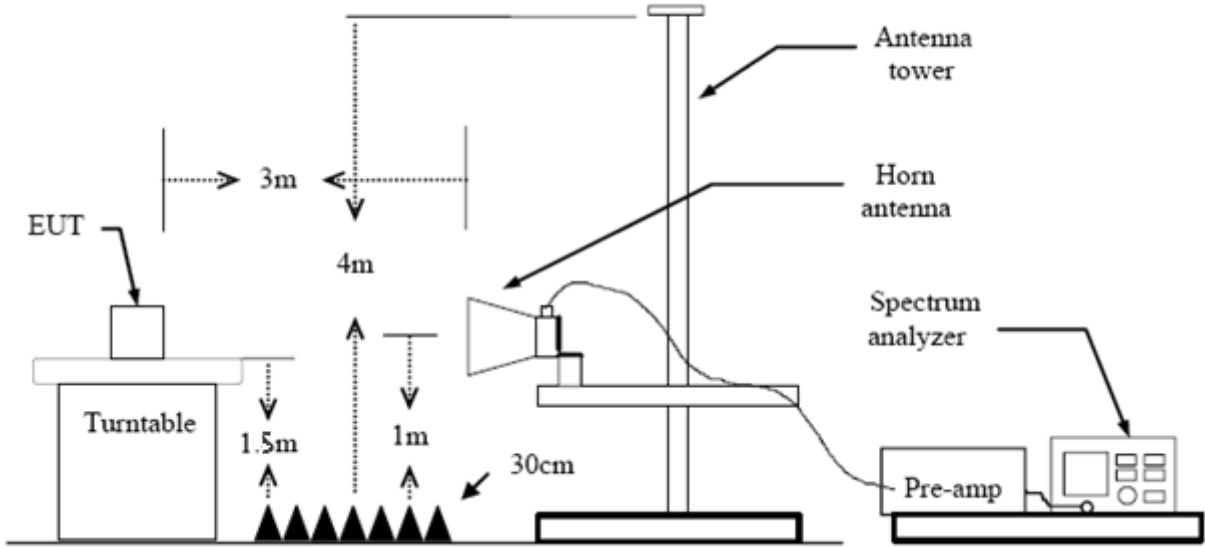



### 7.3 Test Procedure

- (1) The measuring distance of 3m shall be used for measurements at frequency up to 1GHz and above 1 GHz. The EUT was placed on a rotating 0.8m high above ground, the table was rotated 360 degrees to determine the position of the highest radiation.
- (2) Measurements at frequency above 1GHz. The EUT was placed on a rotating 1.5m high above the ground. RF absorbers covered the ground plane with a minimum area of 3.0m by 3.0m between the EUT and measurement receiver antenna. The RF absorber shall not exceed 30cm in high above the conducting floor. The table was rotated 360 degrees to determine the position of the highest radiation.
- (3) The Test antenna shall vary between 1m and 4m, Both Horizontal and Vertical antenna are set to make measurement.
- (4) The initial step in collecting conducted emission data is a spectrum analyzer peak detector mode pre-scanning the measurement frequency range. Significant peaks are then marked and then Quasi Peak detector mode re-measured.
- (5) If the Peak Mode measured value compliance with and lower than Quasi Peak Mode Limit Bellow 1 GHz, the EUT shall be deemed to meet QP Limits and then no additional QP Mode measurement performed. But the Peak Value and average value both need to comply with applicable limit above 1 GHz.
- (6) Testing frequency range below 1GHz the measuring instrument use VBW=120 kHz with Quasi-peak detection.
- (7) Testing frequency range above 1GHz the measuring instrument use RBW=1 MHz and VBW=3 MHz with Peak Detector for Peak Values, and use RBW=1 MHz and VBW=10 Hz with AVG Detector for Average Values.
- (8) For the actual test configuration, please see the test setup photo.

### 7.4 Deviation From Test Standard

No deviation

### 7.5 EUT Operating Condition

The Equipment Under Test was set to Continual Transmitting in maximum power.

### 7.6 Test Data

Remark: During testing above 1GHz the measuring instrument use RBW=1 MHz and VBW=3 MHz with Peak Detector for Peak Values, and use RBW=1 MHz and VBW=10 Hz with Peak Detector for Average Values.

All restriction bands have been tested, only the worst case is reported.

Please refer to the Attachment C.



## 8. Number of Hopping Channel

### 8.1 Test Standard and Limit

#### 8.1.1 Test Standard

FCC Part 15.247 (a)(1) / RSS 247 5.1(4)

#### 8.1.2 Test Limit

Section	Test Item	Limit
15.247	Number of Hopping Channel	>15

### 8.2 Test Setup

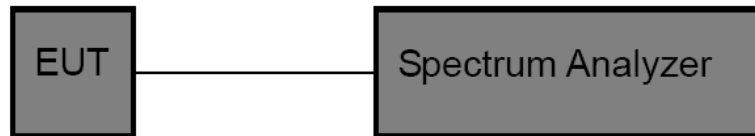

### 8.3 Test Procedure

- (1) The EUT was directly connected to the spectrum analyzer and antenna output port as show in the block diagram above.
- (2) Spectrum Setting: RBW=100 KHz, VBW=100 KHz, Sweep time= Auto.

### 8.4 Deviation From Test Standard

No deviation

### 8.5 EUT Operating Condition

The EUT was set to the Hopping Mode by the Customer.

### 8.6 Test Data

Please refer to the Attachment D.



## 9. Average Time of Occupancy

### 9.1 Test Standard and Limit

#### 9.1.1 Test Standard

FCC Part 15.247 (a)(1) / RSS 247 5.1(d)

#### 9.1.2 Test Limit

Test Item	Limit
Average Time of Occupancy	0.4 sec

### 9.2 Test Setup

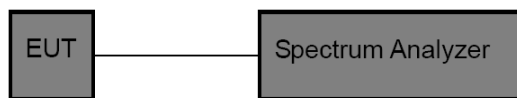

### 9.3 Test Procedure

- (1) The EUT was directly connected to the spectrum analyzer and antenna output port as show in the block diagram above.
- (2) Spectrum Setting: RBW=100KHz, VBW=300KHz.
- (3) Use video trigger with the trigger level set to enable triggering only on full pulses.
- (4) Sweep Time is more than once pulse time.
- (5) Set the center frequency on any frequency would be measure and set the frequency span to zero.
- (6) Measure the maximum time duration of one single pulse.
- (7) Set the EUT for packet transmitting.
- (8) Measure the maximum time duration of one single pulse.

### 9.4 EUT Operating Condition

The average time of occupancy on any channel within the Period can be calculated with formulas:

The Dwell Time = Burst Width \* Total Hops. The detailed calculations are showed as follows:

The duration for dwell time calculation:  $0.4 [s] * \text{hopping number} = 0.4 [s] * 20 [ch] = 8.0 [s*ch]$ ;

The burst width, which is directly measured, refers to the duration on one channel hop.

The maximum number of hopping channels in 8.0s  $= 3 * (8.0/0.24) = 100$

The lowest, middle and highest channels are selected to perform testing to record the dwell time of each occupation measured in this channel, which is called Pulse Time here.

The EUT was set to the Hopping Mode by the Customer.

### 9.4 Deviation From Test Standard

No deviation

### 9.5 Test Data

Please refer to the Attachment E.



## 10. Channel Separation and Bandwidth Test

### 10.1 Test Standard and Limit

#### 10.1.1 Test Standard

FCC Part 15.247/RSS 247 5.1(b)

#### 10.1.2 Test Limit

Test Item	Limit	Frequency Range(MHz)
Bandwidth	$\leq 1$ MHz (20dB bandwidth)	2400~2483.5
Channel Separation	$>25$ KHz or $>$ two-thirds of the 20 dB bandwidth Which is greater	2400~2483.5

### 10.2 Test Setup

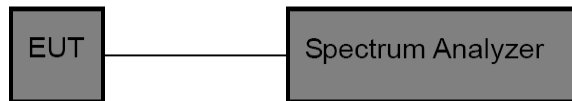

### 10.3 Test Procedure

- (1) The EUT was directly connected to the spectrum analyzer and antenna output port as show in the block diagram above.
- (2) Spectrum Setting:  
Channel Separation: RBW=100 kHz, VBW=100 kHz.  
Bandwidth: RBW=30 kHz, VBW=100 kHz.
- (3) The bandwidth is measured at an amplitude level reduced 20dB from the reference level. The reference level is the level of the highest amplitude signal observed from the transmitter at the fundamental frequency. Once the reference level is established, the equipment is conditioned with typical modulating signal to produce the worst –case (i.e the widest) bandwidth.
- (4) Measure the channel separation the spectrum analyzer was set to Resolution Bandwidth:30 kHz, and Video Bandwidth:100 kHz. Sweep Time set auto.

### 10.4 Deviation From Test Standard

No deviation

### 10.5 EUT Operating Condition

The EUT was set to the Hopping Mode for Channel Separation Test and continuously transmitting for the Bandwidth Test.

### 10.6 Test Data

Please refer to the Attachment F.



## 11. Peak Output Power Test

### 11.1 Test Standard and Limit

#### 11.1.1 Test Standard

FCC Part 15.247 (b) (1)/RSS 247 5.4(b)

#### 11.1.2 Test Limit

Test Item	Limit	Frequency Range(MHz)
Peak Output Power	Hopping Channels>75 Power<1W(30dBm) Other <125 mW(21dBm)	2400~2483.5

### 11.2 Test Setup

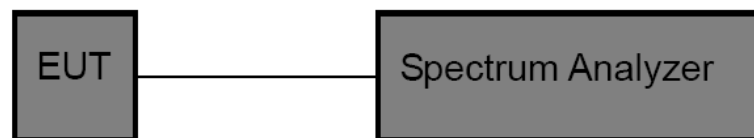

### 11.3 Test Procedure

- (1) The EUT was directly connected to the spectrum analyzer and antenna output port as show in the block diagram above.
- (2) Spectrum Setting:  
Peak Detector: RBW=1 MHz, VBW=3 MHz for bandwidth less than 1MHz.  
RBW=3 MHz, VBW=3 MHz for bandwidth more than 1MHz.

### 11.4 Deviation From Test Standard

No deviation

### 11.5 EUT Operating Condition

The EUT was set to continuously transmitting in the max power during the test.

### 11.6 Test Data

Please refer to the Attachment G.

## 12. Antenna Requirement

### 12.1 Standard Requirement

#### 12.1.1 Standard

FCC Part 15.203

#### 12.1.2 Requirement

An intentional radiator shall be designed to ensure that no antenna other than that furnished by the responsible party shall be used with the device. The use of a permanently attached antenna or of an antenna that uses a unique coupling to the intentional radiator shall be considered sufficient to comply with the provisions of this Section. The manufacturer may design the unit so that a broken antenna can be replaced by the user, but the use of a standard antenna jack or electrical connector is prohibited.

### 12.2 Deviation From Test Standard

No deviation

### 12.3 Antenna Connected Construction

The gains of the antenna used for transmitting is 3dBi, and the antenna connector is de-signed with permanent attachment and no consideration of replacement. Please see the EUT photo for details.

### 12.4 Result

The EUT antenna is a FPC Antenna. It complies with the standard requirement.

Antenna Type
<input type="checkbox"/> Permanent attached antenna
<input checked="" type="checkbox"/> Unique connector antenna
<input type="checkbox"/> Professional installation antenna



## Attachment A-- Conducted Emission Test Data

<b>Temperature:</b>	23.8°C	<b>Relative Humidity:</b>	41%
<b>Test Voltage:</b>	AC 120V/60Hz		
<b>Terminal:</b>	Line		
<b>Test Mode:</b>	TX GFSK Mode 2408MHz		
<b>Remark:</b>	All channels have been tested and Shows only the worst channels.		

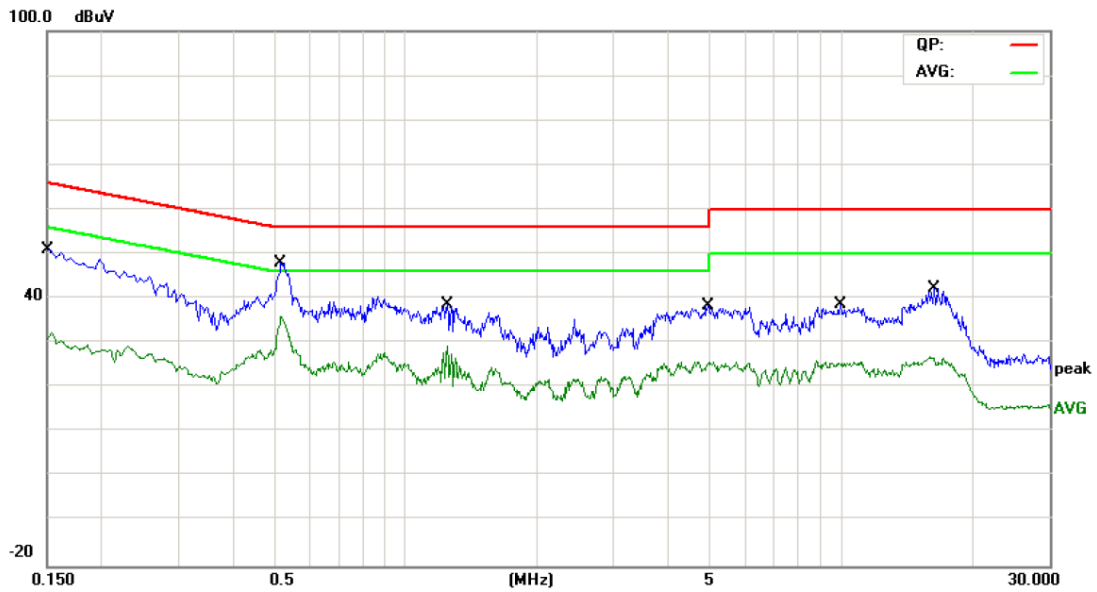

No.	Mk.	Freq. MHz	Reading Level dBuV	Correct Factor dB	Measure- ment dBuV	Limit dBuV	Over dB	Detector
1		0.1500	33.09	9.70	42.79	65.99	-23.20	QP
2		0.1500	16.58	9.70	26.28	55.99	-29.71	AVG
3		0.5180	34.00	9.70	43.70	56.00	-12.30	QP
4	*	0.5180	25.24	9.70	34.94	46.00	-11.06	AVG
5		1.2460	20.26	9.78	30.04	56.00	-25.96	QP
6		1.2460	13.13	9.78	22.91	46.00	-23.09	AVG
7		4.9340	22.82	9.90	32.72	56.00	-23.28	QP
8		4.9340	14.23	9.90	24.13	46.00	-21.87	AVG
9		9.9260	22.13	9.80	31.93	60.00	-28.07	QP
10		9.9260	14.42	9.80	24.22	50.00	-25.78	AVG
11		16.3500	23.72	10.00	33.72	60.00	-26.28	QP
12		16.3500	14.34	10.00	24.34	50.00	-25.66	AVG

**Remark:**

1. Corr. Factor (dB) = LISN Factor (dB) + Cable Loss (dB)
2. Margin (dB) = QuasiPeak/Average (dBuV) - Limit (dBuV)

<b>Temperature:</b>	23.8°C	<b>Relative Humidity:</b>	41%
<b>Test Voltage:</b>	AC 120V/60Hz		
<b>Terminal:</b>	Neutral		
<b>Test Mode:</b>	TX GFSK Mode 2408MHz		
<b>Remark:</b>	All channels have been tested and Shows only the worst channels.		

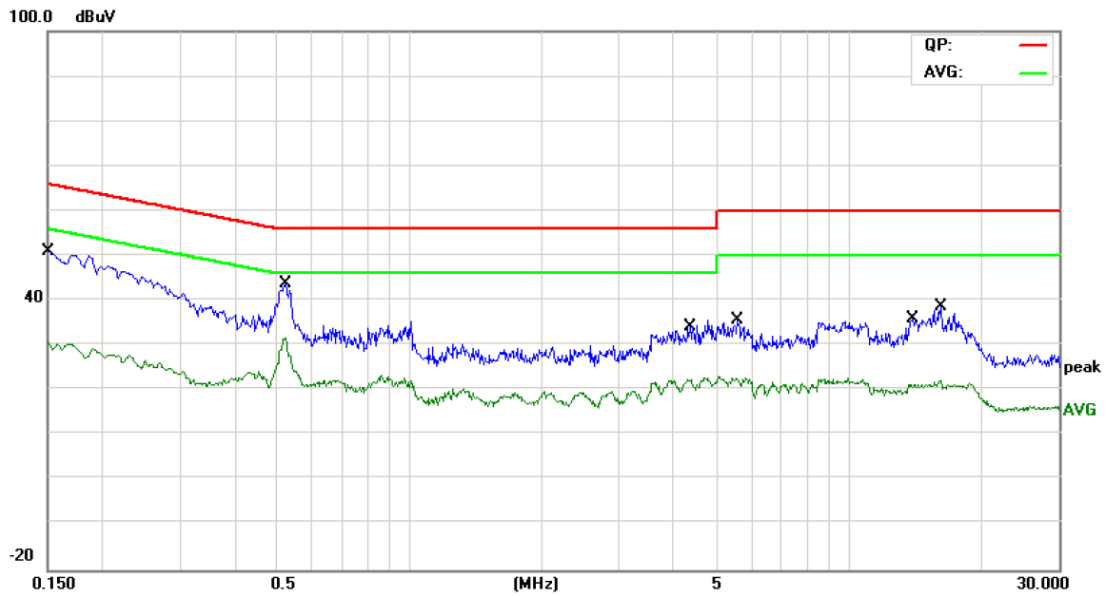

No.	Mk.	Freq. MHz	Reading Level dBuV	Correct Factor dB	Measure- ment dBuV	Limit dBuV	Over dB	Detector
1		0.1500	37.13	9.80	46.93	65.99	-19.06	QP
2		0.1500	20.02	9.80	29.82	55.99	-26.17	AVG
3		0.5220	29.29	9.80	39.09	56.00	-16.91	QP
4	*	0.5220	20.32	9.80	30.12	46.00	-15.88	AVG
5		4.3540	14.68	9.80	24.48	56.00	-31.52	QP
6		4.3540	10.40	9.80	20.20	46.00	-25.80	AVG
7		5.5660	17.68	9.83	27.51	60.00	-32.49	QP
8		5.5660	11.45	9.83	21.28	50.00	-28.72	AVG
9		13.9780	14.95	9.98	24.93	60.00	-35.07	QP
10		13.9780	8.54	9.98	18.52	50.00	-31.48	AVG
11		16.1580	16.17	10.00	26.17	60.00	-33.83	QP
12		16.1580	9.40	10.00	19.40	50.00	-30.60	AVG

**Remark:**  
 1. Corr. Factor (dB) = LISN Factor (dB) + Cable Loss (dB)  
 2. Margin (dB) = QuasiPeak/Average (dBuV) - Limit (dBuV)



## Attachment B-- Radiated Emission Test Data

### 9KHz~30MHz

From 9KHz to 30MHz: Conclusion: PASS

Note: The amplitude of spurious emissions which are attenuated by more than 20dB below the permissible value has no need to be reported.

### 30MHz~1GHz

<b>Temperature:</b>	23.2°C	<b>Relative Humidity:</b>	41%
<b>Test Voltage:</b>	AC 120V/60Hz		
<b>Ant. Pol.</b>	Horizontal		
<b>Test Mode:</b>	TX GFSK Mode 2406MHz		
<b>Remark:</b>	Only worse case is reported		

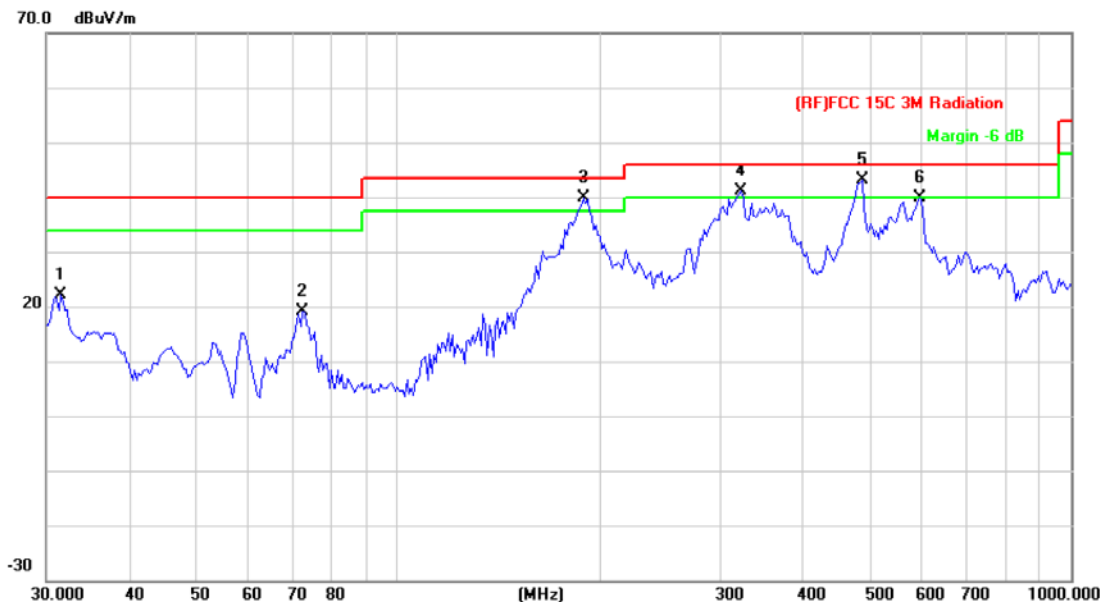

No.	Mk.	Freq. MHz	Reading Level dBuV	Correct Factor dB/m	Measure- ment dBuV/m	Limit dBuV/m	Over dB	Detector
1		31.5095	36.24	-14.08	22.16	40.00	-17.84	peak
2		72.0843	42.42	-23.20	19.22	40.00	-20.78	peak
3	!	188.4125	59.62	-19.85	39.77	43.50	-3.73	peak
4	!	323.3204	56.60	-15.53	41.07	46.00	-4.93	peak
5	*	489.0269	53.84	-10.80	43.04	46.00	-2.96	peak
6		595.1329	48.34	-8.37	39.97	46.00	-6.03	peak

\*:Maximum data    x:Over limit    !:over margin

**Remark:**

1. Corr. = Antenna Factor (dB/m) + Cable Loss (dB)
2. QuasiPeak (dBμV/m)= Corr. (dB/m)+ Read Level (dBμV)
3. Margin (dB) = QuasiPeak (dBμV/m)-Limit QPK(dBμV/m)

Temperature:	23.2°C	Relative Humidity:	41%
Test Voltage:	AC 120V/60Hz		
Ant. Pol.	Vertical		
Test Mode:	TX GFSK Mode 2406MHz		
Remark:	Only worse case is reported		

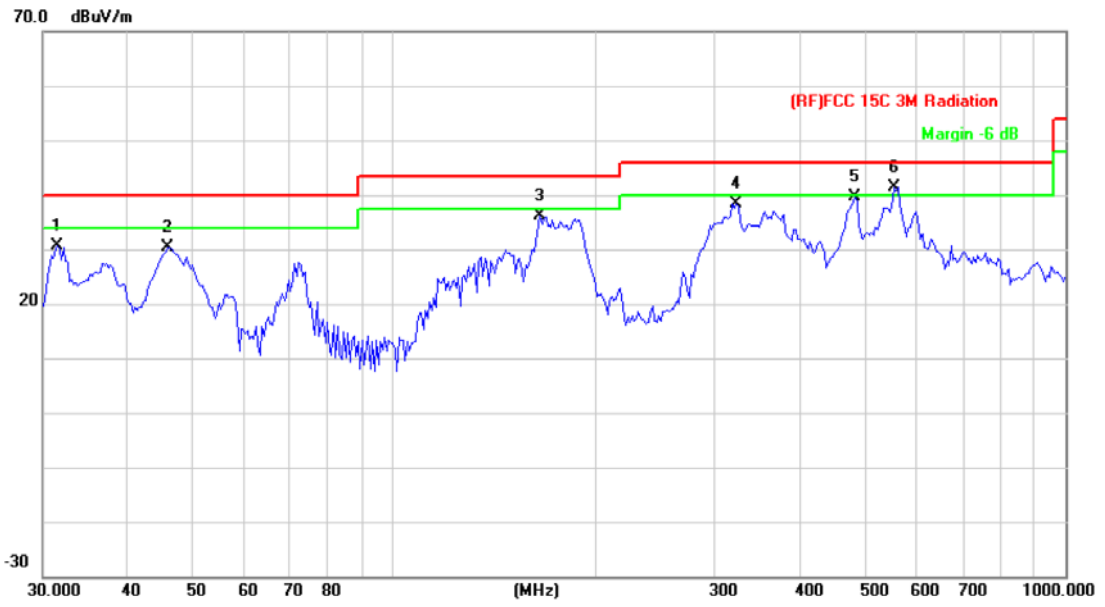

No.	Mk.	Freq. MHz	Reading Level dBuV	Correct Factor dB/m	Measure- ment dBuV/m	Limit dBuV/m	Over dB	Detector
1		31.5095	44.70	-14.08	30.62	40.00	-9.38	peak
2		46.0164	52.10	-21.76	30.34	40.00	-9.66	peak
3		164.9075	56.65	-20.63	36.02	43.50	-7.48	peak
4		323.3204	53.91	-15.53	38.38	46.00	-7.62	peak
5		485.6093	50.60	-10.88	39.72	46.00	-6.28	peak
6	*	554.8254	50.22	-8.87	41.35	46.00	-4.65	peak

\*:Maximum data    x:Over limit    !:over margin

**Remark:**  
 1. Corr. = Antenna Factor (dB/m) + Cable Loss (dB)  
 2. QuasiPeak (dBμV/m)= Corr. (dB/m)+ Read Level (dBμV)  
 3. Margin (dB) = QuasiPeak (dBμV/m)-Limit QPK(dBμV/m)



**Above 1GHz (Only worse case is reported)**

<b>Temperature:</b>	23.2°C	<b>Relative Humidity:</b>	41%
<b>Test Voltage:</b>	AC 120V/60Hz		
<b>Ant. Pol.</b>	Horizontal		
<b>Test Mode:</b>	TX GFSK Mode 2406MHz		
<b>Remark:</b>	No report for the emission which more than 10 dB below the prescribed limit.		

No.	Mk.	Freq.	Reading Level	Correct Factor	Measurement	Limit	Over	Detector
		MHz	dBuV	dB/m	dBuV/m	dBuV/m	dB	
1	*	4811.688	34.51	13.07	47.58	54.00	-6.42	AVG
2		4812.328	48.27	13.07	61.34	74.00	-12.66	peak

**Remark:**  
 1. Corr. = Antenna Factor (dB/m) + Cable Loss (dB)  
 2. Peak/AVG (dBuV/m)= Corr. (dB/m)+ Read Level (dBuV)  
 3. Margin (dB) = Peak/AVG (dBuV/m)-Limit PK/AVG(dBuV/m)

<b>Temperature:</b>	23.2°C	<b>Relative Humidity:</b>	41%
<b>Test Voltage:</b>	AC 120V/60Hz		
<b>Ant. Pol.</b>	Vertical		
<b>Test Mode:</b>	TX GFSK Mode 2406MHz		
<b>Remark:</b>	No report for the emission which more than 10 dB below the prescribed limit.		

No.	Mk.	Freq.	Reading Level	Correct Factor	Measurement	Limit	Over	Detector
		MHz	dBuV	dB/m	dBuV/m	dBuV/m	dB	
1		4811.918	52.14	13.07	65.21	74.00	-8.79	peak
2	*	4812.026	37.25	13.07	50.32	54.00	-3.68	AVG

**Remark:**  
 1. Corr. = Antenna Factor (dB/m) + Cable Loss (dB)  
 2. Peak/AVG (dBuV/m)= Corr. (dB/m)+ Read Level (dBuV)  
 3. Margin (dB) = Peak/AVG (dBuV/m)-Limit PK/AVG(dBuV/m)

<b>Temperature:</b>	23.2°C	<b>Relative Humidity:</b>	41%
<b>Test Voltage:</b>	AC 120V/60Hz		
<b>Ant. Pol.</b>	Horizontal		
<b>Test Mode:</b>	TX GFSK Mode 2442MHz		
<b>Remark:</b>	No report for the emission which more than 10 dB below the prescribed limit.		

No.	Mk.	Freq.	Reading Level	Correct Factor	Measurement	Limit	Over	Detector
		MHz	dBuV	dB/m	dBuV/m	dBuV/m	dB	
1	*	4884.014	35.14	13.60	48.74	54.00	-5.26	AVG
2		4884.310	48.83	13.61	62.44	74.00	-11.56	peak

**Remark:**  
 1. Corr. = Antenna Factor (dB/m) + Cable Loss (dB)  
 2. Peak/AVG (dBμV/m)= Corr. (dB/m)+ Read Level (dBμV)  
 3. Margin (dB) = Peak/AVG (dBμV/m)-Limit PK/AVG(dBμV/m)

<b>Temperature:</b>	23.2°C	<b>Relative Humidity:</b>	41%
<b>Test Voltage:</b>	AC 120V/60Hz		
<b>Ant. Pol.</b>	Vertical		
<b>Test Mode:</b>	TX GFSK Mode 2442MHz		
<b>Remark:</b>	No report for the emission which more than 10 dB below the prescribed limit.		

No.	Mk.	Freq.	Reading Level	Correct Factor	Measurement	Limit	Over	Detector
		MHz	dBuV	dB/m	dBuV/m	dBuV/m	dB	
1		4883.638	48.74	13.59	62.33	74.00	-11.67	peak
2	*	4884.330	35.17	13.61	48.78	54.00	-5.22	AVG

**Remark:**  
 1. Corr. = Antenna Factor (dB/m) + Cable Loss (dB)  
 2. Peak/AVG (dBμV/m)= Corr. (dB/m)+ Read Level (dBμV)  
 3. Margin (dB) = Peak/AVG (dBμV/m)-Limit PK/AVG(dBμV/m)



<b>Temperature:</b>	23.2°C	<b>Relative Humidity:</b>	41%
<b>Test Voltage:</b>	AC 120V/60Hz		
<b>Ant. Pol.</b>	Horizontal		
<b>Test Mode:</b>	TX GFSK Mode 2475MHz		
<b>Remark:</b>	No report for the emission which more than 10 dB below the prescribed limit.		

No.	Mk.	Freq.	Reading Level	Correct Factor	Measurement	Limit	Over	Detector
		MHz	dBuV	dB/m	dBuV/m	dBuV/m	dB	
1		4949.966	48.15	14.08	62.23	74.00	-11.77	peak
2	*	4950.104	34.90	14.08	48.98	54.00	-5.02	AVG

**Remark:**  
1. Corr. = Antenna Factor (dB/m) + Cable Loss (dB)  
2. Peak/AVG (dBμV/m)= Corr. (dB/m)+ Read Level (dBμV)  
3. Margin (dB) = Peak/AVG (dBμV/m)-Limit PK/AVG(dBμV/m)

<b>Temperature:</b>	23.2°C	<b>Relative Humidity:</b>	41%
<b>Test Voltage:</b>	AC 120V/60Hz		
<b>Ant. Pol.</b>	Vertical		
<b>Test Mode:</b>	TX GFSK Mode 2475MHz		
<b>Remark:</b>	No report for the emission which more than 10 dB below the prescribed limit.		

No.	Mk.	Freq.	Reading Level	Correct Factor	Measurement	Limit	Over	Detector
		MHz	dBuV	dB/m	dBuV/m	dBuV/m	dB	
1		4949.640	48.35	14.08	62.43	74.00	-11.57	peak
2	*	4949.888	35.02	14.08	49.10	54.00	-4.90	AVG

**Remark:**  
1. Corr. = Antenna Factor (dB/m) + Cable Loss (dB)  
2. Peak/AVG (dBμV/m)= Corr. (dB/m)+ Read Level (dBμV)  
3. Margin (dB) = Peak/AVG (dBμV/m)-Limit PK/AVG(dBμV/m)

## Attachment C-- Restricted Bands Requirement Test Data

### (1) Radiation Test

Temperature:	23.2°C	Relative Humidity:	41%
Test Voltage:	AC 120V/60Hz		
Ant. Pol.	Horizontal		
Test Mode:	TX GFSK Mode 2406MHz		
Remark:	Only worse case is reported		

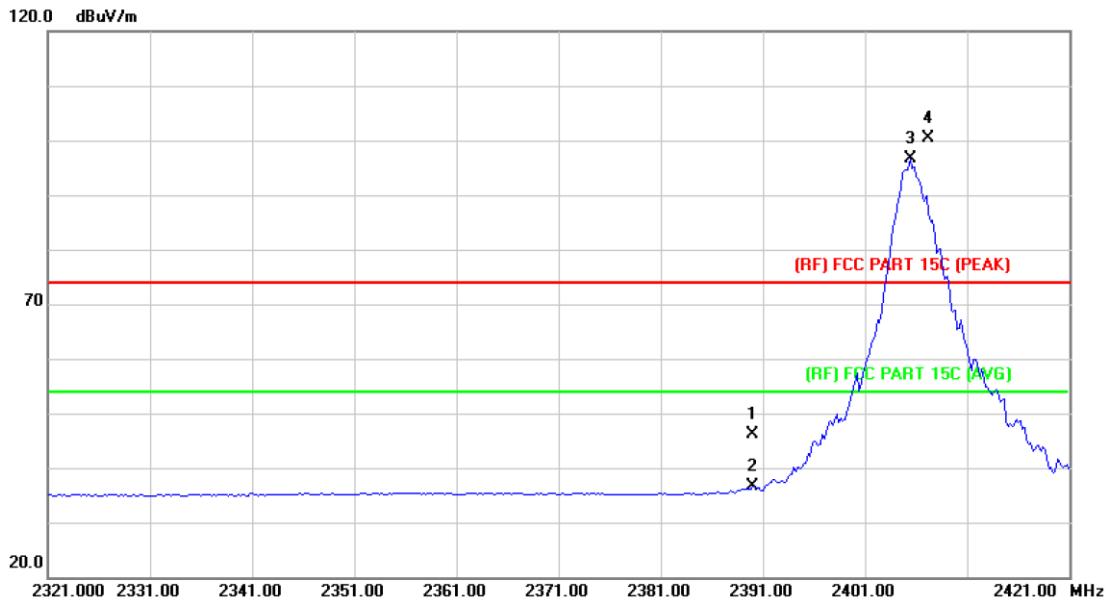

No.	Mk.	Freq. MHz	Reading Level dBuV	Correct Factor dB/m	Measure- ment dBuV/m	Limit dBuV/m	Over dB	Detector
1		2390.000	44.87	1.28	46.15	74.00	-27.85	peak
2		2390.000	35.30	1.28	36.58	54.00	-17.42	AVG
3	*	2405.400	95.17	1.35	96.52	Fundamental Frequency		AVG
4	X	2407.200	99.00	1.36	100.36	Fundamental Frequency		peak

**Remark:**

1. Corr. = Antenna Factor (dB/m) + Cable Loss (dB)
2. Peak/AVG (dBuV/m) = Corr. (dB/m) + Read Level (dBuV)
3. Margin (dB) = Peak/AVG (dBuV/m) - Limit PK/AVG (dBuV/m)



<b>Temperature:</b>	23.2°C	<b>Relative Humidity:</b>	41%
<b>Test Voltage:</b>	AC 120V/60Hz		
<b>Ant. Pol.</b>	Vertical		
<b>Test Mode:</b>	TX GFSK Mode 2406MHz		
<b>Remark:</b>	Only worse case is reported		

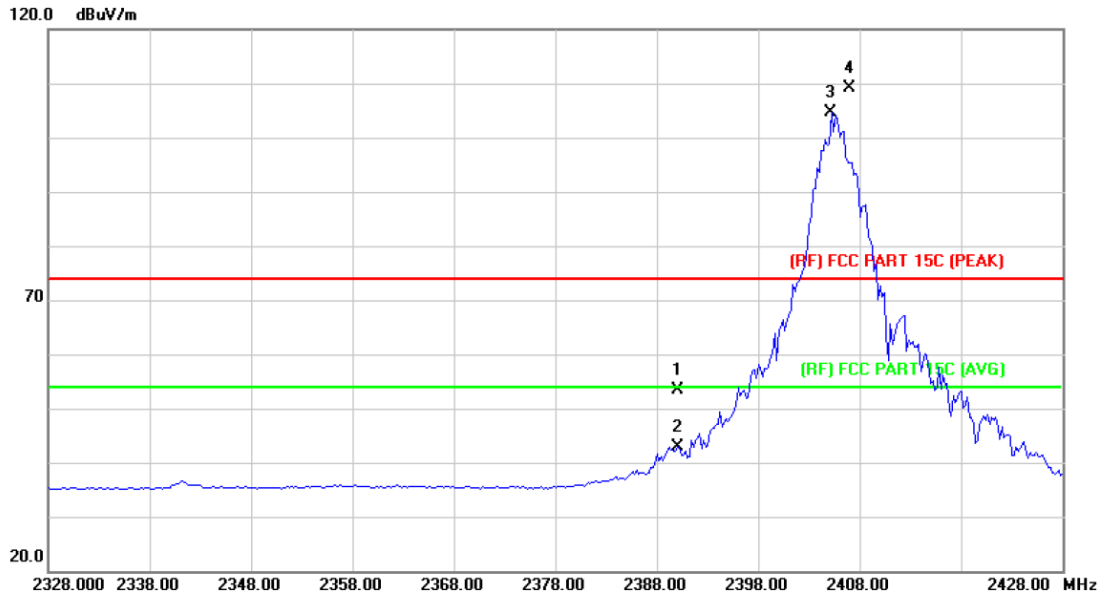

No.	Mk.	Freq. MHz	Reading Level dBuV	Correct Factor dB/m	Measurement dBuV/m	Limit dBuV/m	Over dB	Detector
1		2390.000	52.04	1.28	53.32	74.00	-20.68	peak
2		2390.000	41.55	1.28	42.83	54.00	-11.17	AVG
3	*	2405.200	103.32	1.35	104.67	Fundamental Frequency		AVG
4	X	2407.000	107.79	1.35	109.14	Fundamental Frequency		peak

**Remark:**

1. Corr. = Antenna Factor (dB/m) + Cable Loss (dB)
2. Peak/AVG (dBμV/m) = Corr. (dB/m) + Read Level (dBμV)
3. Margin (dB) = Peak/AVG (dBμV/m) - Limit PK/AVG (dBμV/m)

<b>Temperature:</b>	23.2°C	<b>Relative Humidity:</b>	41%
<b>Test Voltage:</b>	AC 120V/60Hz		
<b>Ant. Pol.</b>	Horizontal		
<b>Test Mode:</b>	TX GFSK Mode 2475 MHz		
<b>Remark:</b>	Only worse case is reported		

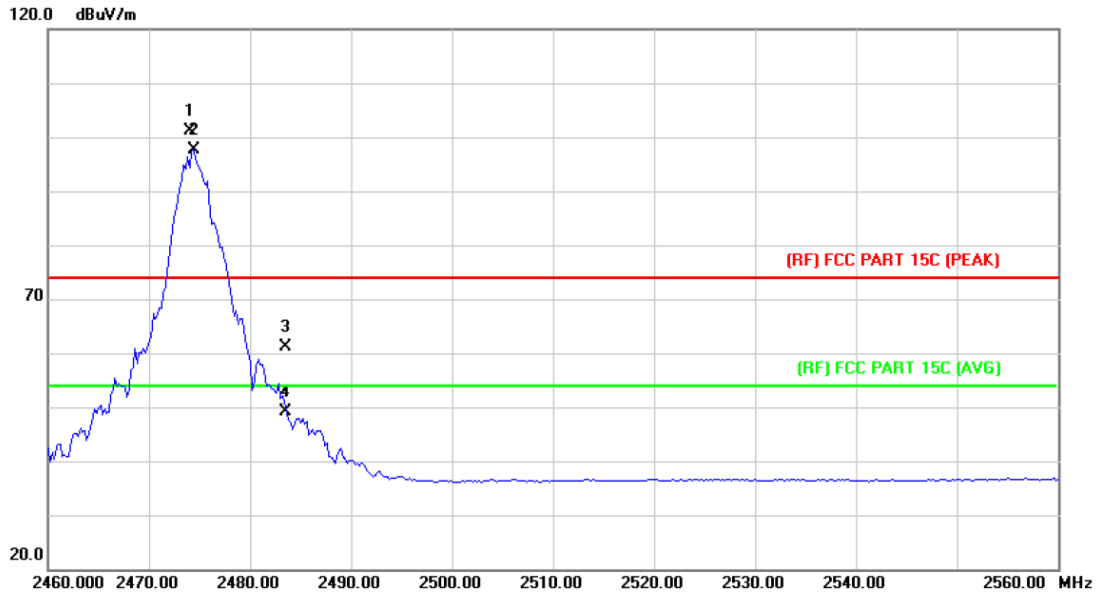

No.	Mk.	Freq. MHz	Reading Level dBuV	Correct Factor dB/m	Measure- ment dBuV/m	Limit dBuV/m	Over dB	Detector
1	X	2474.000	99.24	1.81	101.05	Fundamental Frequency		peak
2	*	2474.400	95.87	1.82	97.69	Fundamental Frequency		AVG
3		2483.500	59.16	1.88	61.04	74.00	-12.96	peak
4		2483.500	47.31	1.88	49.19	54.00	-4.81	AVG

**Remark:**

1. Corr. = Antenna Factor (dB/m) + Cable Loss (dB)
2. Peak/AVG (dBμV/m) = Corr. (dB/m) + Read Level (dBμV)
3. Margin (dB) = Peak/AVG (dBμV/m) - Limit PK/AVG (dBμV/m)



Temperature:	23.2°C	Relative Humidity:	41%
Test Voltage:	AC 120V/60Hz		
Ant. Pol.	Vertical		
Test Mode:	TX GFSK Mode 2475 MHz		
Remark:	Only worse case is reported		

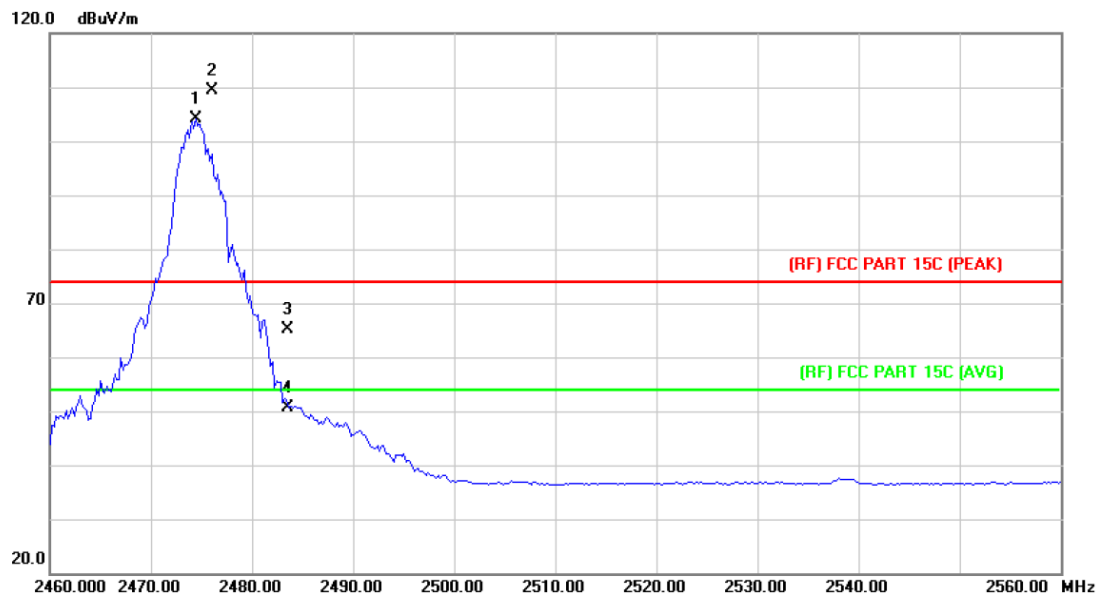

No.	Mk.	Freq. MHz	Reading Level dBuV	Correct Factor dB/m	Measure- ment dBuV/m	Limit dBuV/m	Over dB	Detector
1	*	2474.400	102.41	1.82	104.23	Fundamental Frequency		AVG
2	X	2476.000	107.52	1.83	109.35	Fundamental Frequency		peak
3		2483.500	63.34	1.88	65.22	74.00	-8.78	peak
4		2483.500	48.76	1.88	50.64	54.00	-3.36	AVG

**Remark:**  
 1. Corr. = Antenna Factor (dB/m) + Cable Loss (dB)  
 2. Peak/AVG (dBμV/m)= Corr. (dB/m)+ Read Level (dBμV)  
 3. Margin (dB) = Peak/AVG (dBμV/m)-Limit PK/AVG(dBμV/m)

**(2) Conducted Band Edge Test**

Temperature:	25°C	Relative Humidity:	55%
Test Voltage:	AC 120V/60Hz		
Test Mode:	TX Mode 2406MHz/2475MHz		
Remark:	Only worse case is reported		

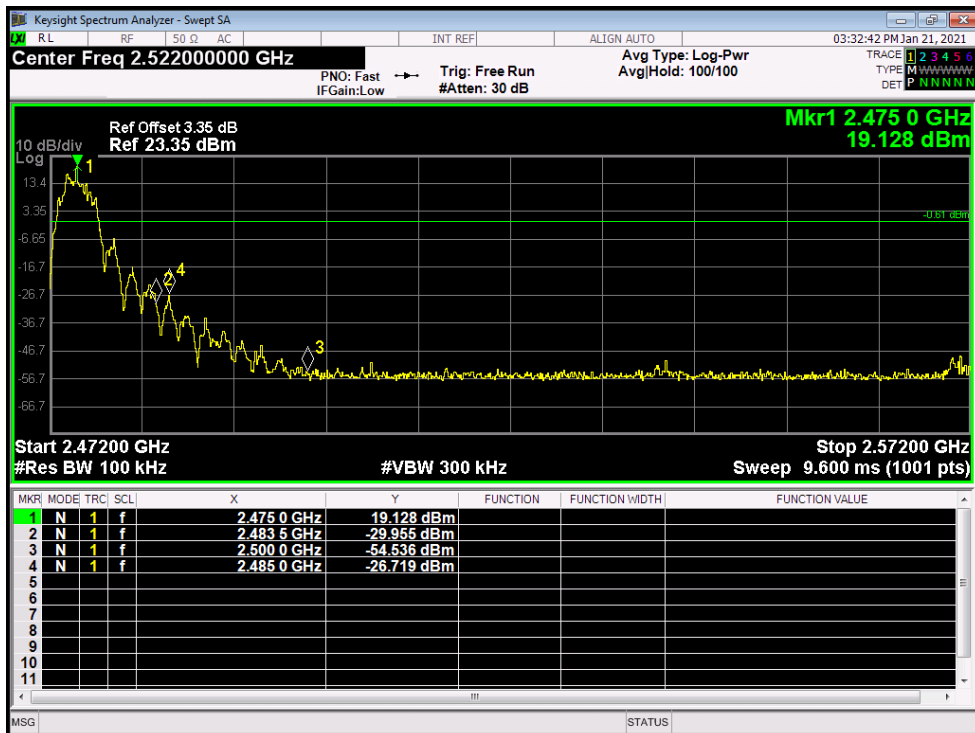
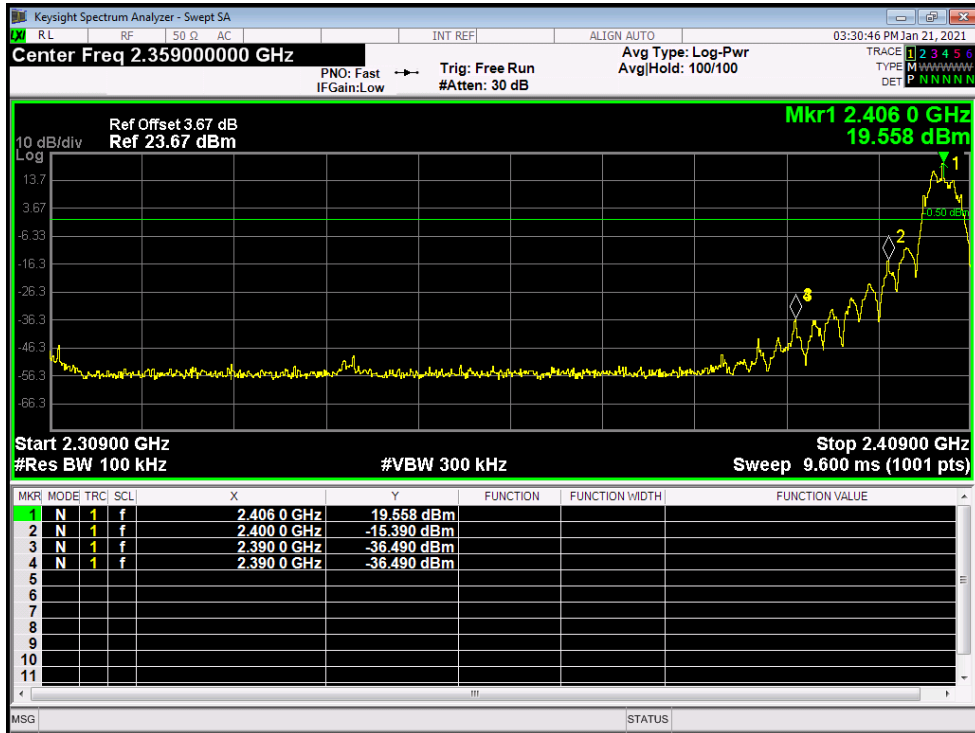



Temperature:	25°C	Relative Humidity:	55%
Test Voltage:	AC 120V/60Hz		
Test Mode:	Hopping Mode		
Remark:	Only worse case is reported		

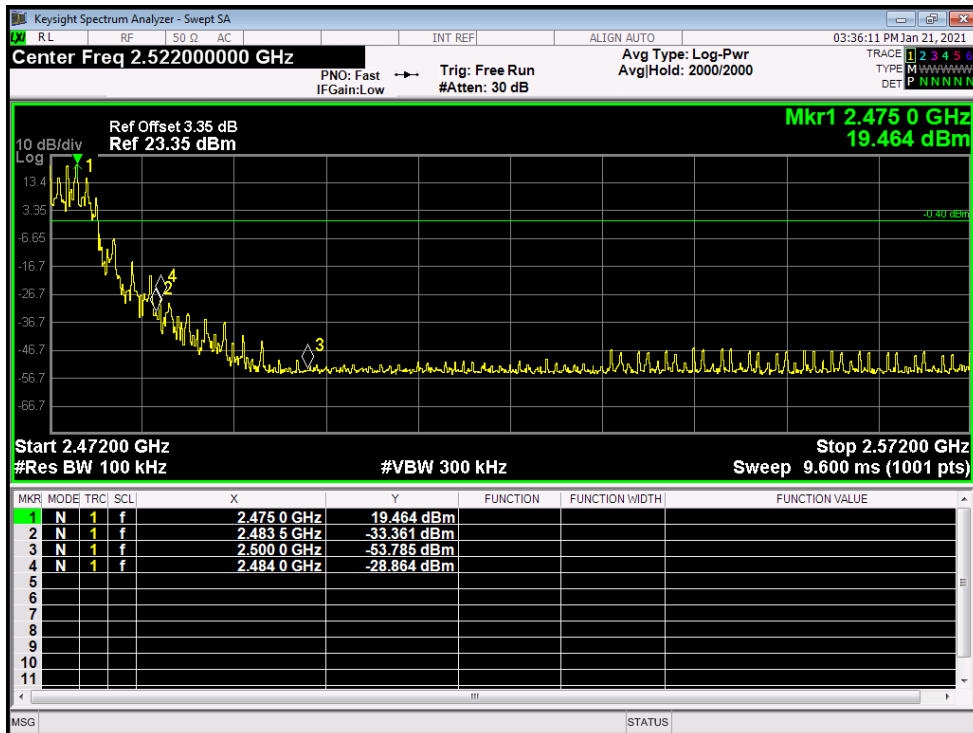
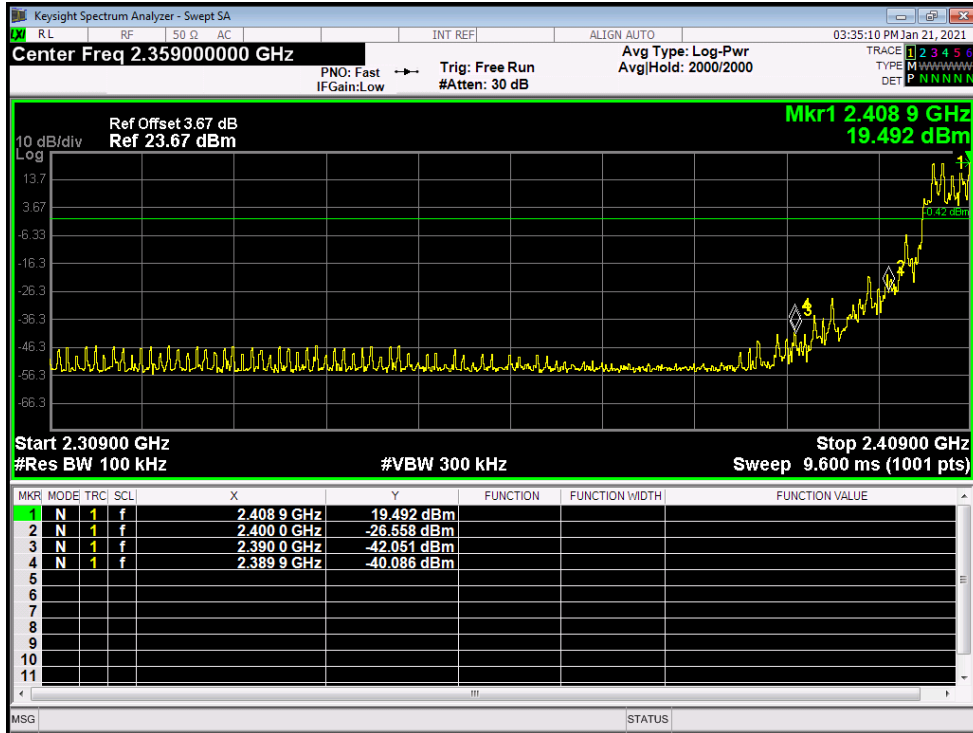

## Attachment D-- Number of Hopping Channel Test Data

Temperature:	25°C	Relative Humidity:	55%
Test Voltage:	AC 120V/60Hz		
Test Mode:	Hopping Mode		
Frequency Range	Test Mode	Quantity of Hopping Channel	Limit
2406MHz~2475MHz	GFSK	16	>15

### GFSK Mode

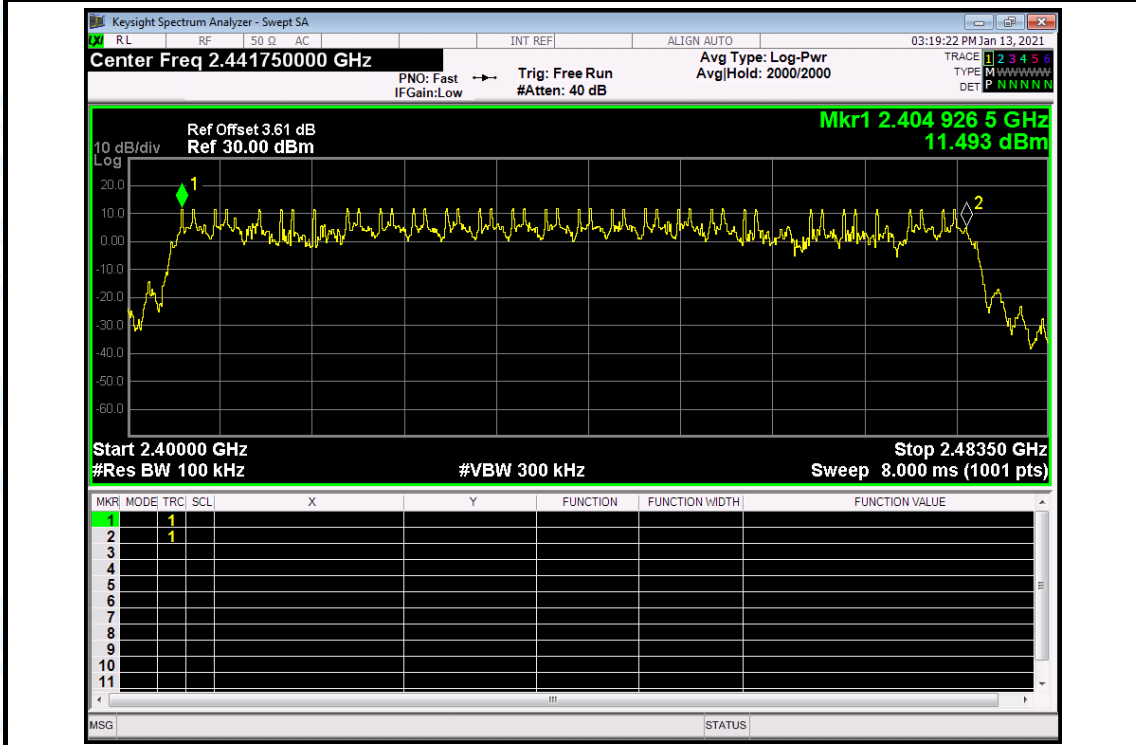



## Attachment E-- Average Time of Occupancy Test Data

<b>Temperature:</b>	25°C	<b>Relative Humidity:</b>	55%
<b>Test Voltage:</b>	AC 120V/60Hz		
<b>Test Mode:</b>	Hopping Mode (GFSK)		
<b>Remark:</b>	The number of total hopping frequencies up to 24.		

Test Mode	Channel (MHz)	Reading Time (ms)	Total hops (N)	Test Result (ms)	Limit (ms)	Result
GFSK	2442	0.471	24	51.81	400	PASS

The Dwell Time = Burst Width \* Total Hops. The detailed calculations are showed as follows:

The duration for dwell time calculation: 0.4 [s] \* hopping number = 0.4 [s] \* 24[ch] =9.6[s\*ch];

The burst width, which is directly measured, refers to the duration on one channel hop.

The maximum number of hopping channels in 9.6s is 110.

Reading Time=0.471ms\*110=51.81ms

### Hopping Channels in 9.6s

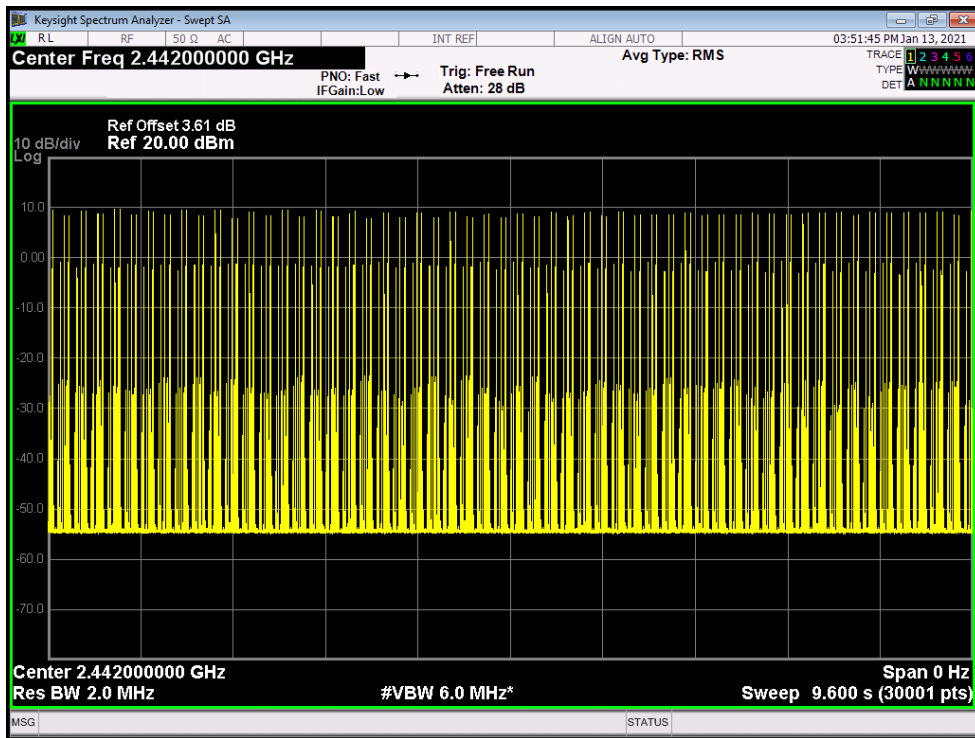

**GFSK Hopping Mode**

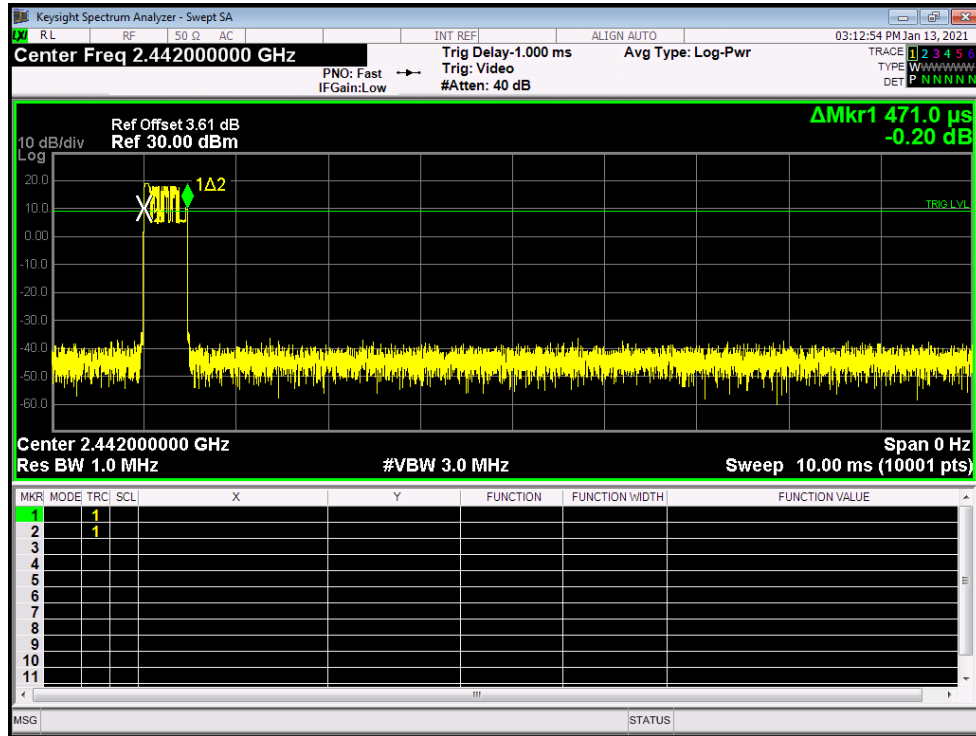



## Attachment F-- Channel Separation and Bandwidth Test Data

Temperature:	25°C	Relative Humidity:	55%
Test Voltage:	AC 120V/60Hz		
Test Mode:	TX Mode (GFSK)		
Channel frequency (MHz)	99% OBW (kHz)	20dB Bandwidth (kHz)	20dB Bandwidth *2/3 (kHz)
2406	4335.9	4344	2896.00
2442	4366.9	4422	2948.00
2475	4421.7	4432	2954.67

**GFSK TX Mode**

**2406 MHz**

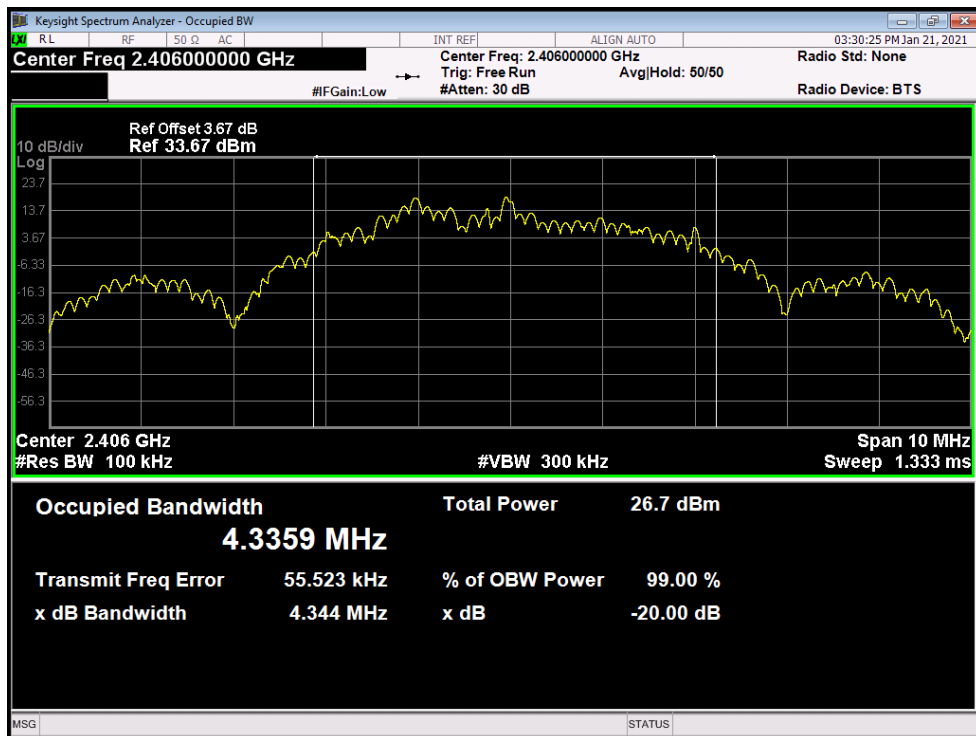

**GFSK TX Mode**

**2442 MHz**

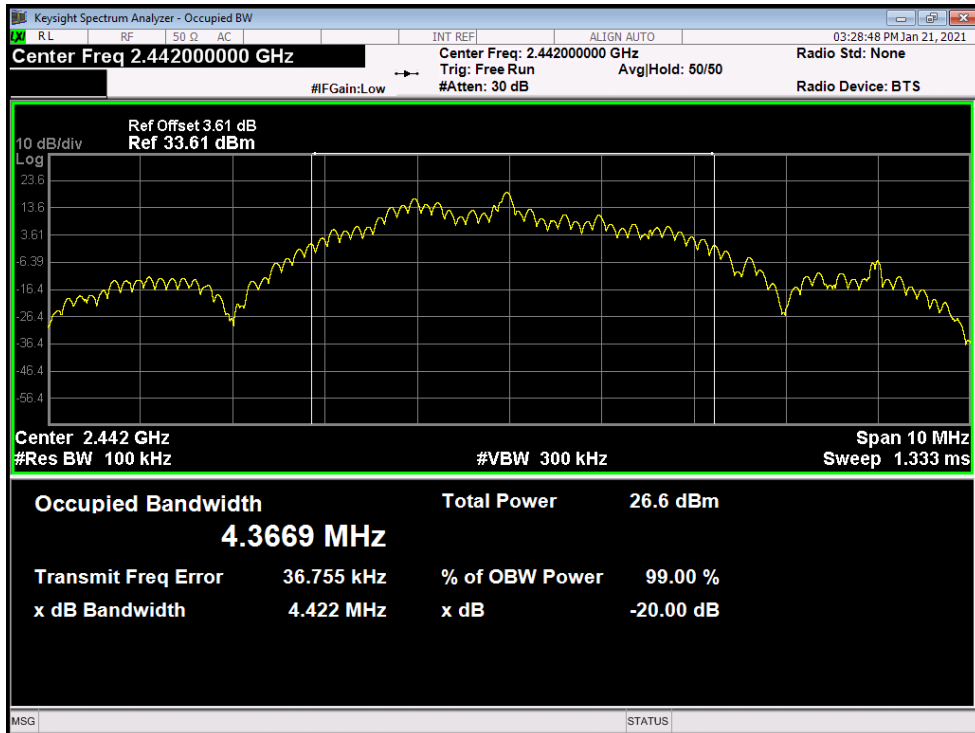

**GFSK TX Mode**

**2475 MHz**

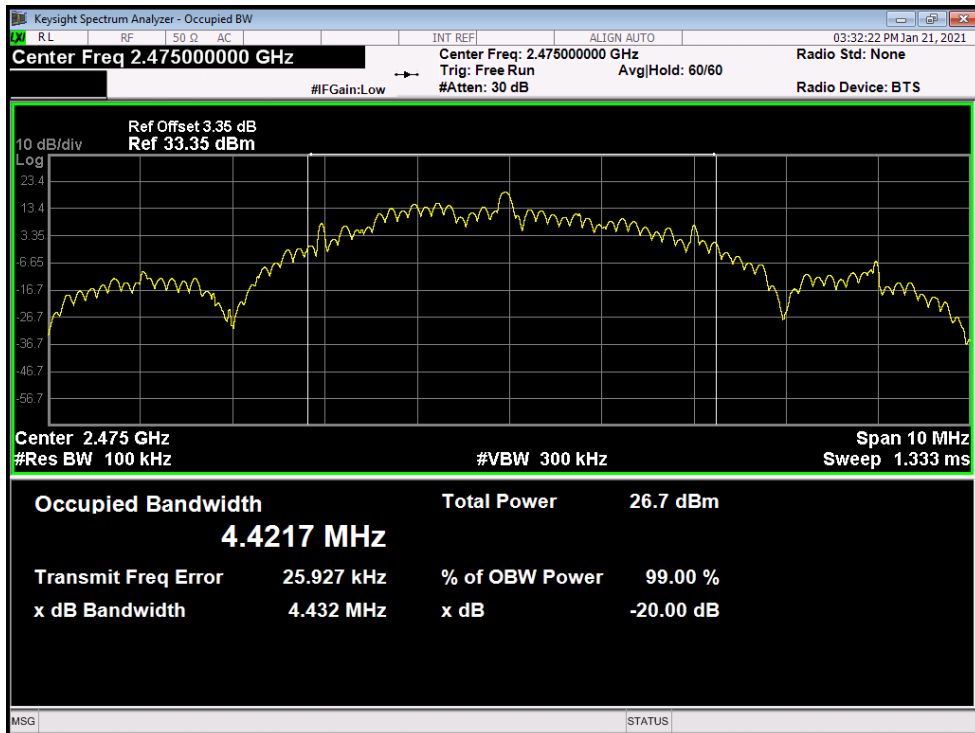



**Channel Separation Test data:**

<b>Temperature:</b>	25°C	<b>Relative Humidity:</b>	55%
<b>Test Voltage:</b>	AC 120V/60Hz		
<b>Test Mode:</b>	Hopping Mode (GFSK)		
<b>Remark:</b>	We test all channel and worse case recorded in the report.		
Channel frequency (MHz)	Separation Read Value (kHz)	Separation Limit (kHz)	
2406	3090	2896.00	
2442	2970	2948.00	
2475	3050	2954.67	
<b>Hopping Mode</b>			
<b>2406 MHz</b>			

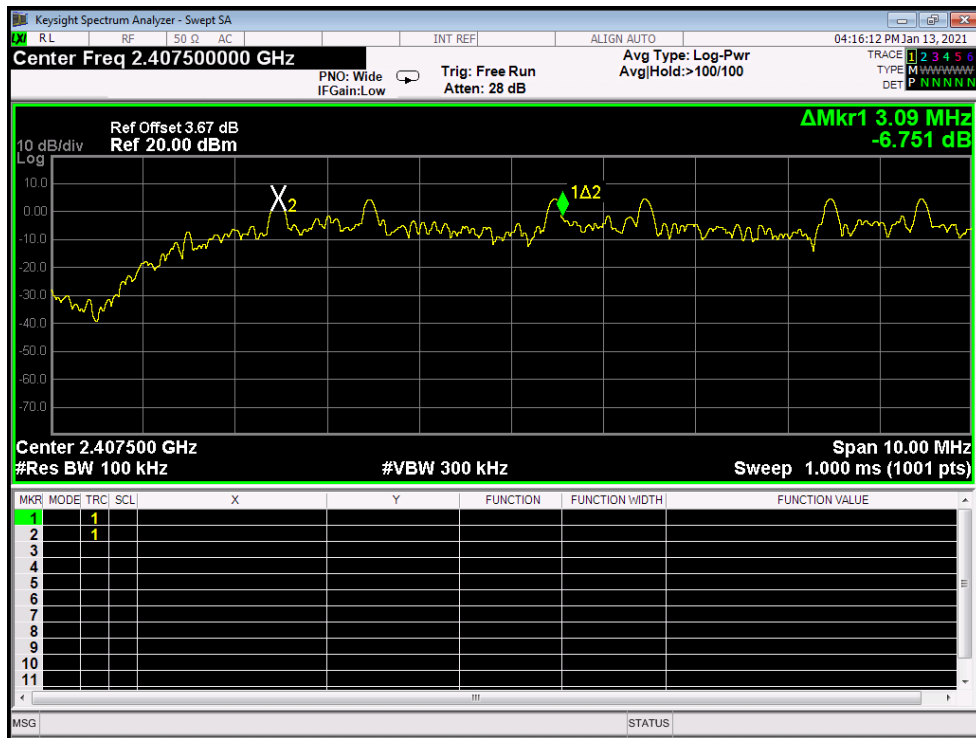

## 2442MHz

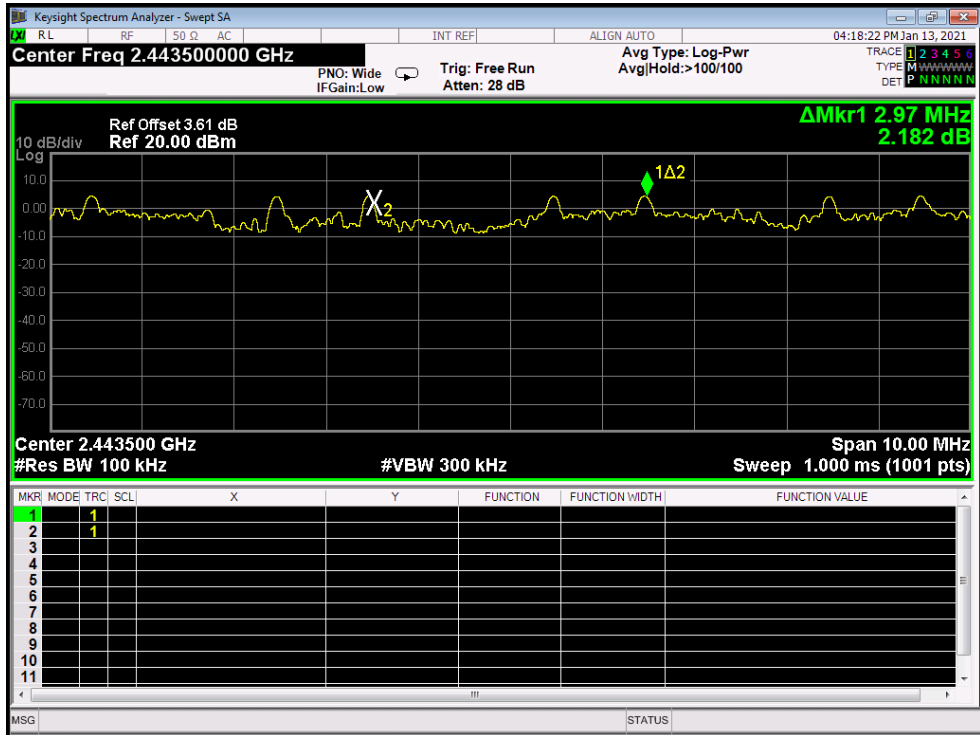

## 2475MHz

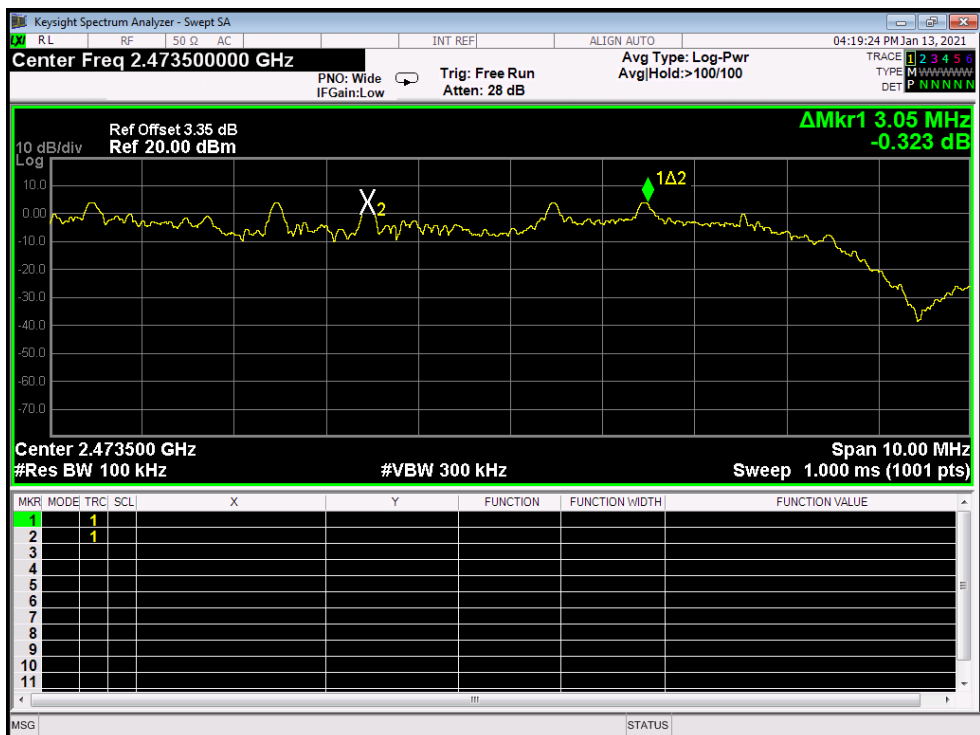



## Attachment G-- Peak Output Power Test Data

<b>Temperature:</b>	25°C	<b>Relative Humidity:</b>	55%
<b>Test Voltage:</b>	AC 120V/60Hz		
<b>Test Mode:</b>	TX Mode (GFSK)		
Channel frequency (MHz)	Test Result (dBm)	Limit (dBm)	
2406	18.638	30	
2442	18.391		
2475	18.270		

**GFSK TX Mode**

**2406 MHz**



**GFSK TX Mode**

**2442 MHz**

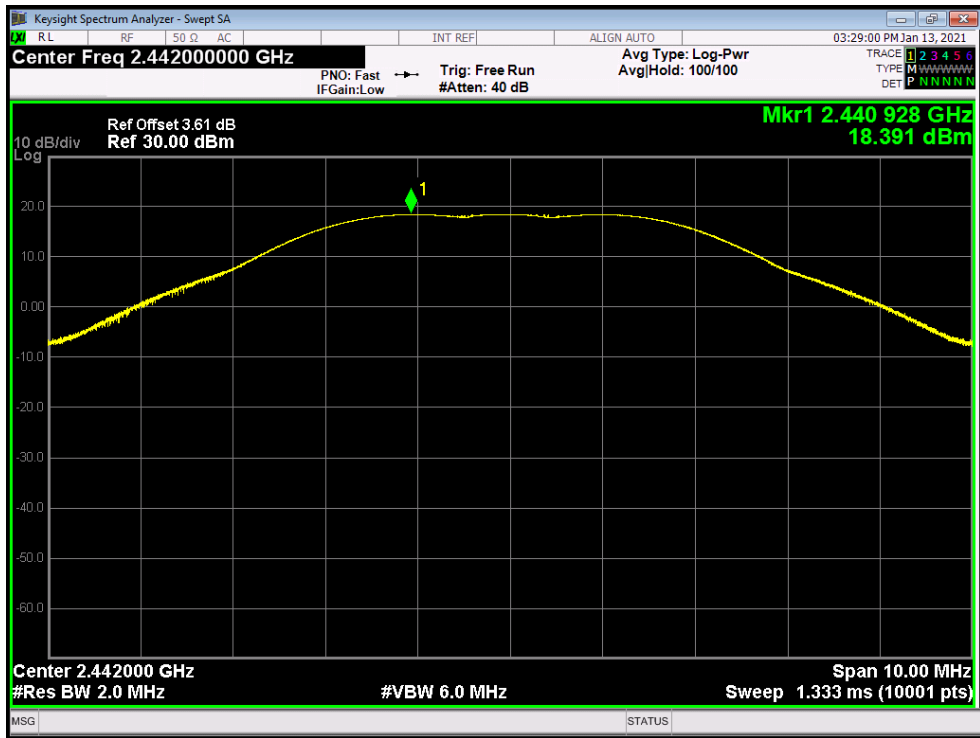

**GFSK TX Mode**

**2475MHz**

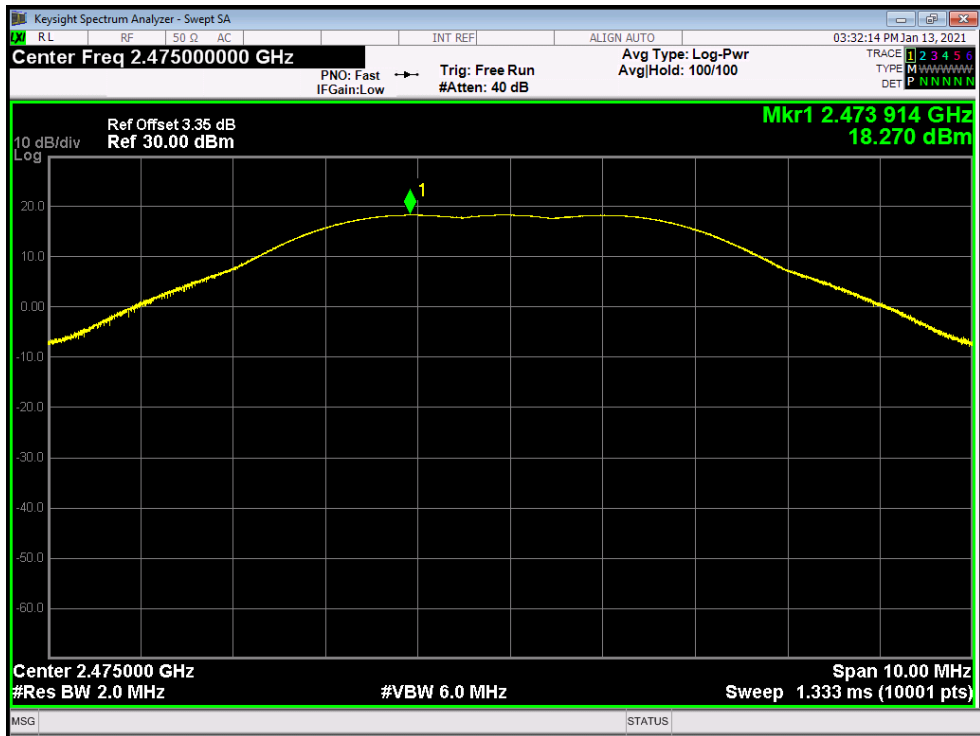

-----END OF REPORT-----