



FCC TEST REPORT

**Test report
On Behalf of
LB Technology Co., Ltd.
For**

Video Door Phone

**Model No.: MZ96319NW-CEM, RK96359NW-CEMP,
RK96378NTW-CEMP, 96379NTW-CEM, 96377NW-CEM,
IRS96321NW-CEMP, IRS96357NTW-CEMP, RK96349NTW-CEMP**

FCC ID: OIE-MZ96319NW

Prepared for : LB Technology Co., Ltd.

**No. 5 of Xiaoyang Rd, First Industrial Park, Tanzhou Town, Zhongshan City,
Guangdong, China**

Prepared By : Shenzhen HUAK Testing Technology Co., Ltd.

**1-2/F., Building B2, Junfeng Zhongcheng Zhizao Innovation Park, Heping,
Fuhai Street, Bao'an District, Shenzhen, Guangdong, China**

Date of Test: Dec. 01, 2021 ~ Dec. 08, 2021

Date of Report: Dec. 08, 2021

Report Number: HK2112014695-E



TEST RESULT CERTIFICATION

Applicant's name: LB Technology Co., Ltd.
Address: No. 5 of Xiaoyang Rd, First Industrial Park, Tanzhou Town, Zhongshan City, Guangdong, China
Manufacture's Name.....: LB Technology Co., Ltd.
Address: No. 5 of Xiaoyang Rd, First Industrial Park, Tanzhou Town, Zhongshan City, Guangdong, China

Product description

Trade Mark: LBTECH
Product name.....: Video Door Phone
Model and/or type reference : MZ96319NW-CEM, RK96359NW-CEMP, RK96378NTW-CEMP, 96379NTW-CEM, 96377NW-CEM, IRS96321NW-CEMP, IRS96357NTW-CEMP, RK96349NTW-CEMP
Standards: FCC Rules and Regulations Part 15 Subpart C Section 15.247
 ANSI C63.10: 2013

This publication may be reproduced in whole or in part for non-commercial purposes as long as the Shenzhen HUAK Testing Technology Co., Ltd. is acknowledged as copyright owner and source of the material. Shenzhen HUAK Testing Technology Co., Ltd. takes no responsibility for and will not assume liability for damages resulting from the reader's interpretation of the reproduced material due to its placement and context.

Date of Test:
Date (s) of performance of tests: **Dec. 01, 2021 ~ Dec. 08, 2021**
Date of Issue.....: **Dec. 08, 2021**
Test Result.....: **Pass**

Testing Engineer : *Gary Qian*
 (Gary Qian)

Technical Manager : *Zden Hu*
 (Eden Hu)

Authorized Signatory : *Jason Zhou*
 (Jason Zhou)

The results shown in this test report refer only to the sample(s) tested unless otherwise stated and the sample(s) are retained for 30 days only. The document is issued by HUAK, this document cannot be reproduced except in full with our prior written permission. The more details and the authenticity of the report will be confirmed at <http://www.cer-mark.com>.



TABLE OF CONTENTS

- 1. Test Result Summary 5**
 - 1.1. TEST PROCEDURES AND RESULTS..... 5
 - 1.2. INFORMATION OF THE TEST LABORATORY..... 5
 - 1.3. MEASUREMENT UNCERTAINTY 6
- 2. EUT Description 7**
 - 2.1. GENERAL DESCRIPTION OF EUT 7
 - 2.2. OPERATION OF EUT DURING TESTING 8
 - 2.3. DESCRIPTION OF TEST SETUP 9
- 3. Test Environment Information..... 10**
 - 3.1. TEST ENVIRONMENT AND MODE 10
 - 3.2. DESCRIPTION OF SUPPORT UNITS 12
- 4. Test Results and Measurement Data 13**
 - 4.1. CONDUCTED EMISSION 13
 - 4.2. TEST RESULT 15
 - 4.3. MAXIMUM CONDUCTED OUTPUT POWER 17
 - 4.4. EMISSION BANDWIDTH..... 19
 - 4.5. POWER SPECTRAL DENSITY 25
 - 4.6. CONDUCTED BAND EDGE AND SPURIOUS EMISSION MEASUREMENT 31
 - 4.7. RADIATED SPURIOUS EMISSION MEASUREMENT 41
 - 4.8. ANTENNA REQUIREMENT 67
 - 4.9. PHOTOGRAPH OF TEST..... 68
 - 4.10. PHOTOS OF THE EUT 70

The results shown in this test report refer only to the sample(s) tested unless otherwise stated and the sample(s) are retained for 30 days only. The document is issued by HUAK, this document cannot be reproduced except in full with our prior written permission. The more details and the authenticity of the report will be confirmed at <http://www.cer-mark.com>.

HUAK Testing Lab TEL : +86-755 2302 9901 FAX : +86-755 2302 9901 E-mail : service@cer-mark.com

1-2/F., Building B2, Junfeng Zhongcheng Zhizao Innovation Park, Heping, Fuhai Street, Bao'an District, Shenzhen, Guangdong, China



**** Modified History ****

Revision	Description	Issued Data	Remark
Revision 1.0	Initial Test Report Release	Dec. 08, 2021	Jason Zhou

The results shown in this test report refer only to the sample(s) tested unless otherwise stated and the sample(s) are retained for 30 days only. The document is issued by HUAK, this document cannot be reproduced except in full with our prior written permission. The more details and the authenticity of the report will be confirmed at <http://www.cer-mark.com>.

HUAK Testing Lab TEL : +86-755 2302 9901 FAX : +86-755 2302 9901 E-mail : service@cer-mark.com

1-2/F., Building B2, Junfeng Zhongcheng Zhizao Innovation Park, Heping, Fuhai Street, Bao'an District, Shenzhen, Guangdong, China



1. Test Result Summary

1.1. TEST PROCEDURES AND RESULTS

Requirement	CFR 47 Section	Result
Antenna requirement	§15.203/§15.247(b)(4)	PASS
AC Power Line Conducted Emission	§15.207	PASS
Conducted Peak Output Power	§15.247 (b)(3)	PASS
6dB Emission Bandwidth	§15.247 (a)(2)	PASS
Power Spectral Density	§15.247 (e)	PASS
Band Edge	1§5.247(d)	PASS
Spurious Emission	§15.205/§15.209	PASS

Note:

1. PASS: Test item meets the requirement.
2. Fail: Test item does not meet the requirement.
3. N/A: Test case does not apply to the test object.
4. The test result judgment is decided by the limit of test standard.

1.2. INFORMATION OF THE TEST LABORATORY

Shenzhen HUAK Testing Technology Co., Ltd.
 Add.: 1-2/F., Building B2, Junfeng Zhongcheng Zhizao Innovation Park, Heping,
 Fuhai Street, Bao'an District, Shenzhen, Guangdong, China

Testing Laboratory Authorization :

A2LA Accreditation Code is 4781.01.
 FCC Designation Number is CN1229.
 Canada IC CAB identifier is CN0045.
 CNAS Registration Number is L9589.



1.3. Measurement Uncertainty

The reported uncertainty of measurement $y \pm U$, where expanded uncertainty U is based on a standard uncertainty multiplied by a coverage factor of $k=2$, providing a level of confidence of approximately 95 %.

No.	Item	MU
1	Conducted Emission	$\pm 2.71\text{dB}$
2	RF power, conducted	$\pm 0.37\text{dB}$
3	Spurious emissions, conducted	$\pm 0.11\text{dB}$
4	All emissions, radiated(<1G)	$\pm 3.90\text{dB}$
5	All emissions, radiated(>1G)	$\pm 4.28\text{dB}$
6	Temperature	$\pm 0.1^\circ\text{C}$
7	Humidity	$\pm 1.0\%$



2. EUT Description

2.1. GENERAL DESCRIPTION OF EUT

Equipment	Video Door Phone
Model Name	MZ96319NW-CEM
Serial Model	RK96359NW-CEMP, RK96378NTW-CEMP, 96379NTW-CEM, 96377NW-CEM, IRS96321NW-CEMP, IRS96357NTW-CEMP, RK96349NTW-CEMP
Model Difference	All model's the function, software and electric circuit are the same, only with a product color, appearance and model named different. Test sample model: MZ96319NW-CEM
FCC ID	OIE-MZ96319NW
Antenna Type	Internal Antenna
Antenna Gain	0dBi
Operation frequency	802.11b/g/n 20:2412~2462 MHz 802.11n 40: 2422~2452MHz
Number of Channels	802.11b/g/n20: 11CH 802.11n 40: 7CH
Modulation Type	CCK/OFDM/DBPSK/DAPSK
Power Source	DC 12V 2000mA from Adapter with 100-240V~50/60Hz 0.6A Max
Power Rating	DC 12V 2000mA from Adapter with 100-240V~50/60Hz 0.6A Max

The results shown in this test report refer only to the sample(s) tested unless otherwise stated and the sample(s) are retained for 30 days only. The document is issued by HUAK, this document cannot be reproduced except in full with our prior written permission. The more details and the authenticity of the report will be confirmed at <http://www.cer-mark.com>.



Carrier Frequency of Channels

Channel List for 802.11b/802.11g/802.11n (HT20)							
Channel	Frequency (MHz)	Channel	Frequency (MHz)	Channel	Frequency (MHz)	Channel	Frequency (MHz)
01	2412	04	2427	07	2442	10	2457
02	2417	05	2432	08	2447	11	2462
03	2422	06	2437	09	2452		

Channel List For 802.11n (HT40)							
Channel	Frequency (MHz)	Channel	Frequency (MHz)	Channel	Frequency (MHz)	Channel	Frequency (MHz)
--	--	04	2427	07	2442	--	--
--	--	05	2432	08	2447	--	--
03	2422	06	2437	09	2452		

Note:

In section 15.31(m), regards to the operating frequency range over 10 MHz, the Lowest frequency, the middle frequency, and the highest frequency of channel were selected to perform the test, and the selected channel see below:

2.2. Operation of EUT during testing

Operating Mode

The mode is used: **Transmitting mode for 802.11b/802.11g/802.11n (HT20)**

- Low Channel: 2412MHz
- Middle Channel: 2437MHz
- High Channel: 2462MHz

The mode is used: Transmitting mode for 802.11n (HT40)

- Low Channel: 2422MHz
- Middle Channel: 2437MHz
- High Channel: 2452MHz



2.3. DESCRIPTION OF TEST SETUP

Operation of EUT during conducted testing and radiation testing:



Adapter Information

Model: FJ-SW1202000U

Input: 100-240V~50/60Hz 0.6A Max

Output: 12V 2000mA

The sample was placed (0.8m below 1GHz, 1.5m above 1GHz) above the ground plane of 3m chamber. Measurements in both horizontal and vertical polarities were performed. During the test, each emission was maximized by: having the EUT continuously working, investigated all operating modes, rotated about all 3 axis (X, Y & Z) and considered typical configuration to obtain worst position, manipulating interconnecting cables, rotating the turntable, varying antenna height from 1m to 4m in both horizontal and vertical polarizations. The emissions worst-case are shown in Test Results of the following pages. The worst case is Z position.



3. General Information

3.1. Test environment and mode

Operating Environment:	
Temperature:	25.0 °C
Humidity:	56 % RH
Atmospheric Pressure:	1010 mbar
Test Mode:	
Engineering mode:	Keep the EUT in continuous transmitting by select channel and modulations(The value of duty cycle is 98.46%)
<p>The sample was placed (0.8m below 1GHz, 1.5m above 1GHz) above the ground plane of 3m chamber. Measurements in both horizontal and vertical polarities were performed. During the test, each emission was maximized by: having the EUT continuously working, investigated all operating modes, rotated about all 3 axis (X, Y & Z) and considered typical configuration to obtain worst position, manipulating interconnecting cables, rotating the turntable, varying antenna height from 1m to 4m in both horizontal and vertical polarizations. The emissions worst-case are shown in Test Results of the following pages. For the full battery state and The output power to the maximum state.</p>	



We have verified the construction and function in typical operation. All the test modes were carried out with the EUT in transmitting operation, which was shown in this test report and defined as follows:

Per-scan all kind of data rate in lowest channel, and found the follow list which it was worst case.

Mode	Data rate
802.11b	1Mbps
802.11g	6Mbps
802.11n(H20)	6.5Mbps
802.11n(H40)	13.5Mbps

Final Test Mode:

Operation mode:	Keep the EUT in continuous transmitting with modulation
-----------------	---------------------------------------------------------

1. For WIFI function, the engineering test program was provided and enabled to make EUT continuous transmit/receive.

2. According to ANSI C63.10 standards, the test results are both the “worst case” and “worst setup” 1Mbps for 802.11b, 6Mbps for 802.11g, 6.5Mbps for 802.11n(H20), 13.5Mbps for 802.11(H40). Duty cycle setting during the transmission is 98.5% with maximum power setting for all modulations.



3.2. Description of Support Units

The EUT has been tested as an independent unit together with other necessary accessories or support units. The following support units or accessories were used to form a representative test configuration during the tests.

Equipment	Model No.	Serial No.	FCC ID	Trade Name
/	/	/	/	/

Note:

1. All the equipment/cables were placed in the worst-case configuration to maximize the emission during the test.
2. Grounding was established in accordance with the manufacturer's requirements and conditions for the intended use.
3. For conducted measurements (Output Power, 6dB Emission Bandwidth, Power Spectral Density, Spurious Emissions), the antenna of EUT is connected to the test equipment via temporary antenna connector, the antenna connector is soldered on the antenna port of EUT, and the temporary antenna connector is listed in the Test Instruments.



4. Test Results and Measurement Data

4.1. Conducted Emission

Test Specification

Test Requirement:	FCC Part15 C Section 15.207														
Test Method:	ANSI C63.10:2013														
Frequency Range:	150 kHz to 30 MHz														
Receiver setup:	RBW=9 kHz, VBW=30 kHz, Sweep time=auto														
Limits:	<table border="1"> <thead> <tr> <th rowspan="2">Frequency range (MHz)</th> <th colspan="2">Limit (dBuV)</th> </tr> <tr> <th>Quasi-peak</th> <th>Average</th> </tr> </thead> <tbody> <tr> <td>0.15-0.5</td> <td>66 to 56*</td> <td>56 to 46*</td> </tr> <tr> <td>0.5-5</td> <td>56</td> <td>46</td> </tr> <tr> <td>5-30</td> <td>60</td> <td>50</td> </tr> </tbody> </table>	Frequency range (MHz)	Limit (dBuV)		Quasi-peak	Average	0.15-0.5	66 to 56*	56 to 46*	0.5-5	56	46	5-30	60	50
	Frequency range (MHz)		Limit (dBuV)												
		Quasi-peak	Average												
	0.15-0.5	66 to 56*	56 to 46*												
0.5-5	56	46													
5-30	60	50													
Test Setup:	<p>Reference Plane</p> <p>40cm</p> <p>80cm</p> <p>E.U.T</p> <p>AC power</p> <p>Test table/Insulation plane</p> <p>LISN</p> <p>Filter</p> <p>AC power</p> <p>EMI Receiver</p> <p><i>Remark</i> E.U.T: Equipment Under Test LISN: Line Impedance Stabilization Network Test table height=0.8m</p>														
Test Mode:	Charging + transmitting with modulation														
Test Procedure:	<ol style="list-style-type: none"> 1. The E.U.T is connected to the main power through a line impedance stabilization network (L.I.S.N.). This provides a 50ohm/50uH coupling impedance for the measuring equipment. 2. The peripheral devices are also connected to the main power through a LISN that provides a 50ohm/50uH coupling impedance with 50ohm termination. (Please refer to the block diagram of the test setup and photographs). 3. Both sides of A.C. line are checked for maximum conducted interference. In order to find the maximum emission, the relative positions of equipment and all of the interface cables must be changed according to ANSI C63.10: 2013 on conducted measurement. 														
Test Result:	PASS														

The results shown in this test report refer only to the sample(s) tested unless otherwise stated and the sample(s) are retained for 30 days only. The document is issued by HUAK, this document cannot be reproduced except in full with our prior written permission. The more details and the authenticity of the report will be confirmed at <http://www.cer-mark.com>.



Test Instruments

Conducted Emission Shielding Room Test Site (843)

Equipment	Manufacturer	Model	Serial Number	Calibration Date	Calibration Due
Receiver	R&S	ESCI 7	HKE-010	Dec. 10, 2020	Dec. 09, 2021
LISN	R&S	ENV216	HKE-002	Dec. 10, 2020	Dec. 09, 2021
Coax cable (9KHz-30MHz)	Times	381806-002	N/A	Dec. 10, 2020	Dec. 09, 2021
Conducted test software	Tonscend	TS+ Rev 2.5.0.0	HKE-081	N/A	N/A

Note: The calibration interval of the above test instruments is 12 months and the calibrations are traceable to international system unit (SI).



4.2. Test Result

Test Specification: Line

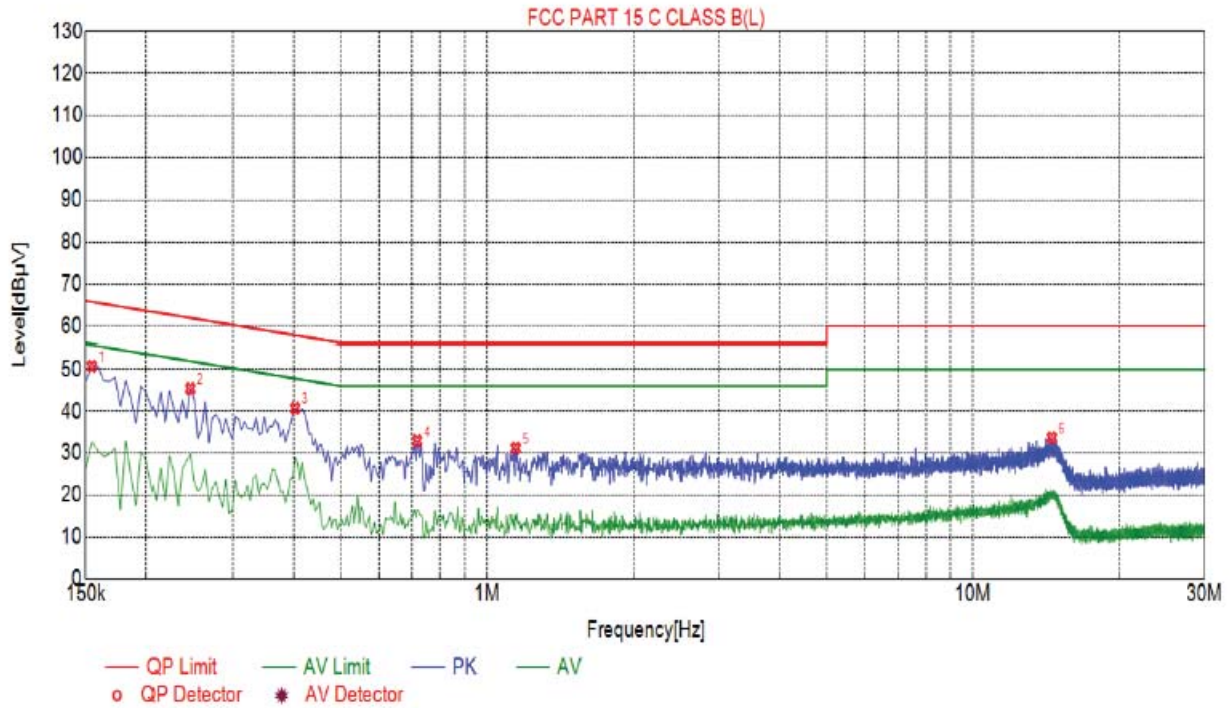

Suspected List								
NO.	Freq. [MHz]	Level [dBµV]	Factor [dB]	Limit [dBµV]	Margin [dB]	Reading [dBµV]	Detector	Type
1	0.1545	50.73	20.03	65.75	15.02	30.70	PK	L
2	0.2445	45.41	20.03	61.94	16.53	25.38	PK	L
3	0.4020	40.73	20.04	57.81	17.08	20.69	PK	L
4	0.7170	32.95	20.05	56.00	23.05	12.90	PK	L
5	1.1445	31.23	20.09	56.00	24.77	11.14	PK	L
6	14.5545	33.67	19.95	60.00	26.33	13.72	PK	L

Remark: Margin = Limit - Level
 Correction factor = Cable lose + LISN insertion loss
 Level=Test receiver reading + correction factor

Notes:

1. An initial pre-scan was performed on the line and neutral lines with peak detector.
2. Quasi-Peak and Average measurement were performed at the frequencies with maximized peak emission.
3. Final Level = Receiver Read level + LISN Factor + Cable Loss
4. If the average limit is met when using a quasi-peak detector receiver, the EUT shall be deemed to meet both limits and measurement with the average detector receiver is unnecessary.

The results shown in this test report refer only to the sample(s) tested unless otherwise stated and the sample(s) are retained for 30 days only. The document is issued by HUAK, this document cannot be reproduced except in full with our prior written permission. The more details and the authenticity of the report will be confirmed at <http://www.cer-mark.com>.



Test Specification: Neutral

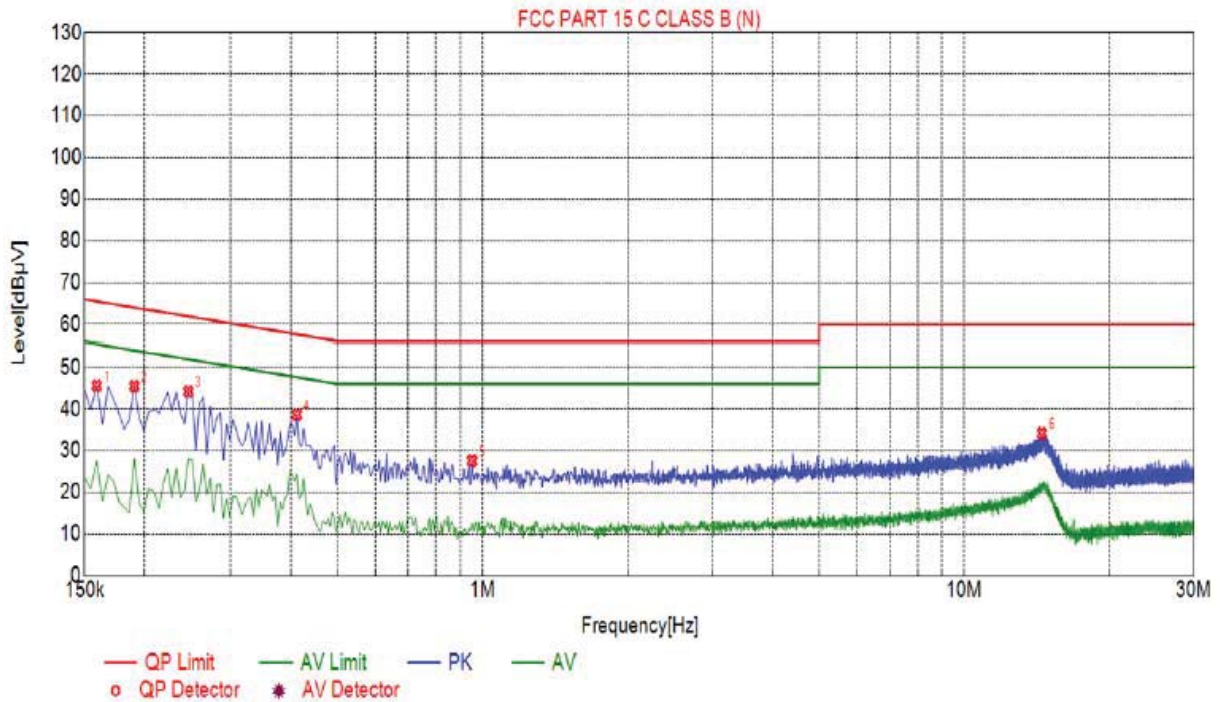

Suspected List								
NO.	Freq. [MHz]	Level [dBµV]	Factor [dB]	Limit [dBµV]	Margin [dB]	Reading [dBµV]	Detector	Type
1	0.1590	45.56	20.01	65.52	19.96	25.55	PK	N
2	0.1905	45.48	20.04	64.01	18.53	25.44	PK	N
3	0.2445	44.20	20.03	61.94	17.74	24.17	PK	N
4	0.4110	38.62	20.03	57.63	19.01	18.59	PK	N
5	0.9510	27.64	20.06	56.00	28.36	7.58	PK	N
6	14.5095	34.17	19.95	60.00	25.83	14.22	PK	N

Remark: Margin = Limit - Level
 Correction factor = Cable lose + LISN insertion loss
 Level=Test receiver reading + correction factor

Notes:

1. An initial pre-scan was performed on the line and neutral lines with peak detector.
 2. Quasi-Peak and Average measurement were performed at the frequencies with maximized peak emission.
 3. Final Level = Receiver Read level + LISN Factor + Cable Loss.
- If the average limit is met when using a quasi-peak detector receiver, the EUT shall be deemed to meet both limits and measurement with the average detector receiver is unnecessary.

4.3. Maximum Conducted Output Power

Test Specification

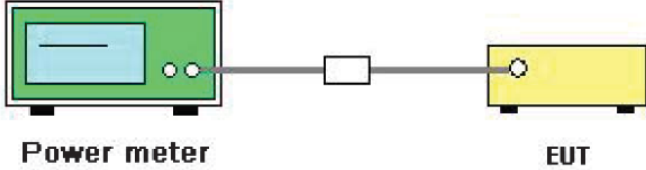
Test Requirement:	FCC Part15 C Section 15.247 (b)(3)
Test Method:	KDB 558074
Limit:	30dBm
Test Setup:	 <p style="text-align: center;"> Power meter EUT </p>
Test Mode:	Transmitting mode with modulation
Test Procedure:	<ol style="list-style-type: none"> 1. The testing follows the Measurement Procedure of FCC KDB 558074 D01 15.247 Meas Guidance v05r02. 2. The RF output of EUT was connected to the power meter by RF cable and attenuator. The path loss was compensated to the results for each measurement. 3. Set to the maximum power setting and enable the EUT transmit continuously. 4. Measure the Peak output power and record the results in the test report.
Test Result:	PASS

Test Instruments

RF Test Room					
Equipment	Manufacturer	Model	Serial Number	Calibration Date	Calibration Due
Spectrum analyzer	Agilent	N9020A	HKE-048	Dec. 10, 2020	Dec. 09, 2021
Power meter	Agilent	E4419B	HKE-085	Dec. 10, 2020	Dec. 09, 2021
Power Sensor	Agilent	E9300A	HKE-086	Dec. 10, 2020	Dec. 09, 2021
RF cable	Times	1-40G	HKE-034	Dec. 10, 2020	Dec. 09, 2021
RF automatic control unit	Tonscend	JS0806-2	HKE-060	Dec. 10, 2020	Dec. 09, 2021

Note: The calibration interval of the above test instruments is 12 months and the calibrations are traceable to international system unit (SI).



Test Data

TX 802.11b Mode			
Test Channel	Frequency	Maximum Peak Conducted Output Power	LIMIT
	(MHz)	(dBm)	dBm
CH01	2412	12.27	30
CH06	2437	12.22	30
CH11	2462	13.05	30
TX 802.11g Mode			
CH01	2412	12.06	30
CH06	2437	11.82	30
CH11	2462	11.46	30
TX 802.11n20 Mode			
CH01	2412	11.67	30
CH06	2437	11.38	30
CH11	2462	11.11	30
TX 802.11n40 Mode			
CH03	2422	10.77	30
CH06	2437	10.68	30
CH09	2452	10.35	30

The results shown in this test report refer only to the sample(s) tested unless otherwise stated and the sample(s) are retained for 30 days only. The document is issued by HUAK, this document cannot be reproduced except in full with our prior written permission. The more details and the authenticity of the report will be confirmed at <http://www.cer-mark.com>.



Test data

Test channel	6dB Emission Bandwidth (MHz)			
	802.11b	802.11g	802.11n(H20)	802.11n(H40)
Lowest	8.520	16.360	17.560	35.600
Middle	8.040	16.360	17.560	35.920
Highest	8.120	16.360	17.560	36.000
Limit:	>500k			
Test Result:	PASS			

Test plots as follows:



802.11b Modulation

Lowest channel



Middle channel



Highest channel



The results shown in this test report refer only to the sample(s) tested unless otherwise stated and the Δmkr(s) are retained for 30 days only. The document is issued by HUAKE, this document cannot be reproduced except in full with our prior written permission. The more details and the authenticity of the report will be confirmed at <http://www.cer-mark.com>.



802.11g Modulation

Lowest channel



Middle channel



Highest channel



The results shown in this test report refer only to the sample(s) tested unless otherwise stated and the sample(s) are retained for 30 days only. The document is issued by HUAKE, this document cannot be reproduced except in full with our prior written permission. The more details and the authenticity of the report will be confirmed at <http://www.cer-mark.com>.



802.11n (HT20) Modulation

Lowest channel



Middle channel



Highest channel



The results shown in this test report refer only to the sample(s) tested unless otherwise stated and the sample(s) are retained for 30 days only. The document is issued by HUAKE, this document cannot be reproduced except in full with our prior written permission. The more details and the authenticity of the report will be confirmed at <http://www.cer-mark.com>.



802.11n (HT40) Modulation

Lowest channel

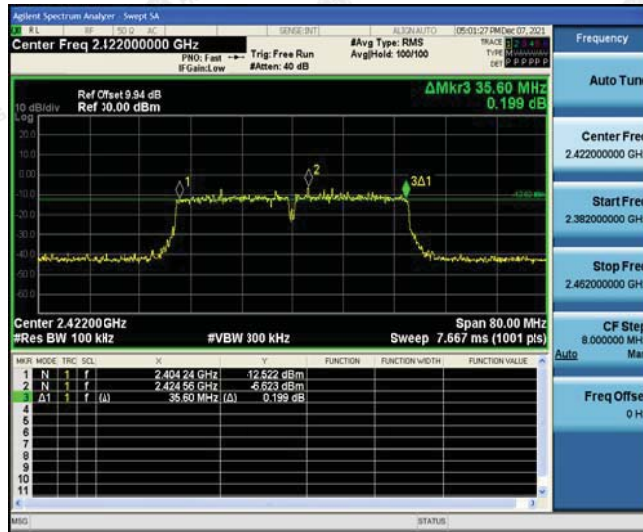

Middle channel

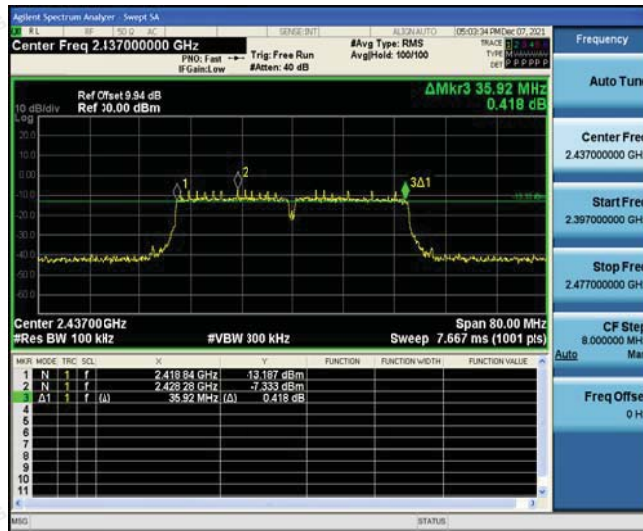

Highest channel



The results shown in this test report refer only to the sample(s) tested unless otherwise stated and the sample(s) are retained for 30 days only. The document is issued by HUAKE, this document cannot be reproduced except in full with our prior written permission. The more details and the authenticity of the report will be confirmed at <http://www.cer-mark.com>.



4.5. Power Spectral Density

Test Specification

Test Requirement:	FCC Part15 C Section 15.247 (e)
Test Method:	KDB 558074
Limit:	The average power spectral density shall not be greater than 8dBm in any 3kHz band at any time interval of continuous transmission.
Test Setup:	 <p style="text-align: center;">Spectrum Analyzer EUT</p>
Test Mode:	Transmitting mode with modulation
Test Procedure:	<ol style="list-style-type: none"> 1. The testing follows Measurement procedure 10.2 method PKPSD of FCC KDB Publication 558074 D01 15.247 Meas Guidance v05r02 2. The RF output of EUT was connected to the spectrum analyzer by RF cable and attenuator. The path loss was compensated to the results for each measurement. 3. Set to the maximum power setting and enable the EUT transmit continuously. 4. Make the measurement with the spectrum analyzer's resolution bandwidth (RBW): $3\text{ kHz} \leq \text{RBW} \leq 100\text{ kHz}$. Video bandwidth $\text{VBW} \geq 3 \times \text{RBW}$. Set the span to at least 1.5 times the OBW. 5. Detector = Peak, Sweep time = auto couple. 6. Employ trace averaging (Peak) mode over a minimum of 100 traces. Use the peak marker function to determine the maximum power level. 6. Measure and record the results in the test report.
Test Result:	PASS

Test Instruments

RF Test Room					
Equipment	Manufacturer	Model	Serial Number	Calibration Date	Calibration Due
Spectrum analyzer	Agilent	N9020A	HKE-048	Dec. 10, 2020	Dec. 09, 2021
RF Cable (9KHz-26.5GHz)	Tonscend	170660	N/A	Dec. 10, 2020	Dec. 09, 2021
RF automatic control unit	Tonscend	JS0806-2	HKE-060	Dec. 10, 2020	Dec. 09, 2021
RF test software	Tonscend	JS1120-B Version 2.6	HKE-083	N/A	N/A

The results shown in this test report refer only to the sample(s) tested unless otherwise stated and the sample(s) are retained for 30 days only. This document is issued by HUAKE, this document cannot be reproduced except in full with our prior written permission. The more details and the authenticity of the report will be confirmed at <http://www.cer-mark.com>.



Note: The calibration interval of the above test instruments is 12 months and the calibrations are traceable to international system unit (SI).

Test data

EUT Set Mode	Channel	Result (dBm/30kHz)	Result (dBm/3kHz)
802.11b	Lowest	-0.75	-10.75
	Middle	-0.7	-10.7
	Highest	-0.5	-10.5
802.11g	Lowest	-8.83	-18.83
	Middle	-9.22	-19.22
	Highest	-9.05	-19.05
802.11n(H20)	Lowest	-9.77	-19.77
	Middle	-9.64	-19.64
	Highest	-10.12	-20.12
802.11n(H40)	Lowest	-11.45	-21.45
	Middle	-11.67	-21.67
	Highest	-12.17	-22.17
PSD test result (dBm/3kHz)= PSD test result (dBm/30kHz)-10			
Limit: 8dBm/3kHz			
Test Result:	PASS		

Test plots as follows:



802.11b Modulation

Lowest channel



Middle channel



Highest channel



The results shown in this test report refer only to the sample(s) tested unless otherwise stated and the sample(s) are retained for 30 days only. The document is issued by HUAKE, this document cannot be reproduced except in full with our prior written permission. The more details and the authenticity of the report will be confirmed at <http://www.cer-mark.com>.



802.11g Modulation

Lowest channel

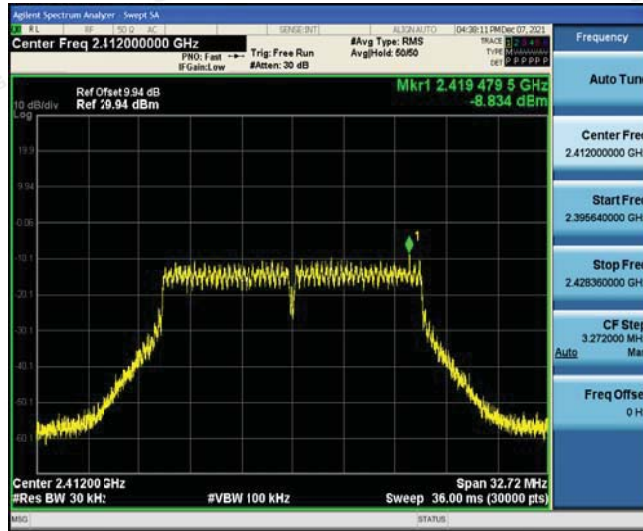

Middle channel

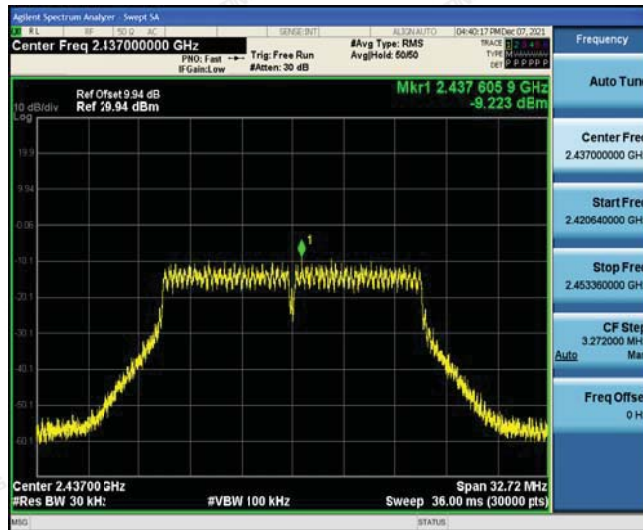

Highest channel



The results shown in this test report refer only to the sample(s) tested unless otherwise stated and the sample(s) are retained for 30 days only. The document is issued by HUAK, this document cannot be reproduced except in full with our prior written permission. The more details and the authenticity of the report will be confirmed at <http://www.cer-mark.com>.



802.11n (HT20) Modulation

Lowest channel



Middle channel



Highest channel

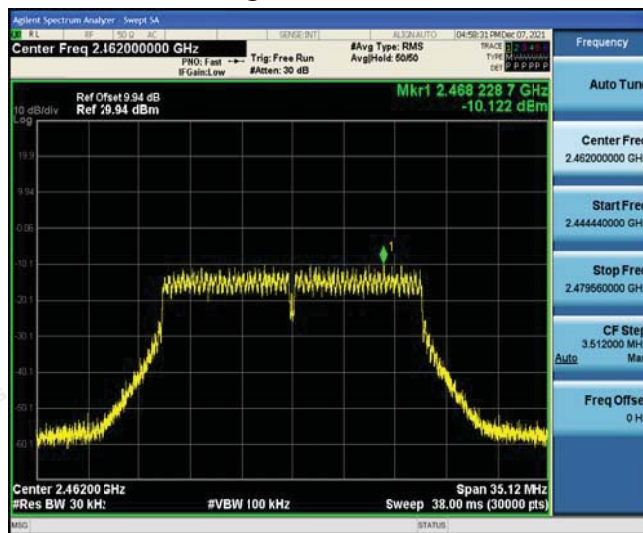

The results shown in this test report refer only to the sample(s) tested unless otherwise stated and the sample(s) are retained for 30 days only. The document is issued by HUAK, this document cannot be reproduced except in full with our prior written permission. The more details and the authenticity of the report will be confirmed at <http://www.cer-mark.com>.



802.11n (HT40) Modulation

Lowest channel

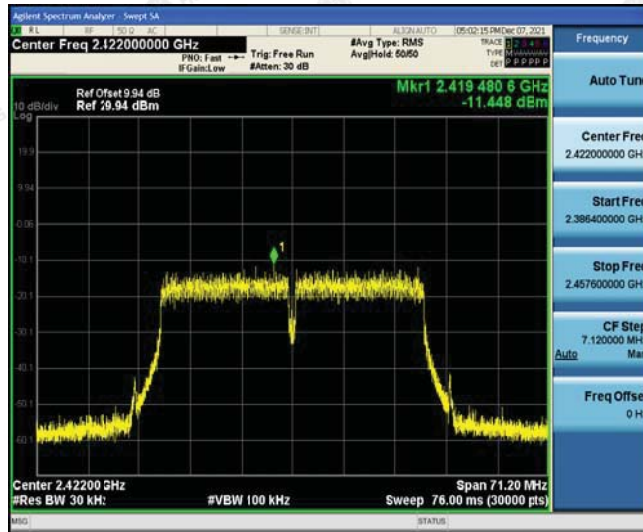

Middle channel

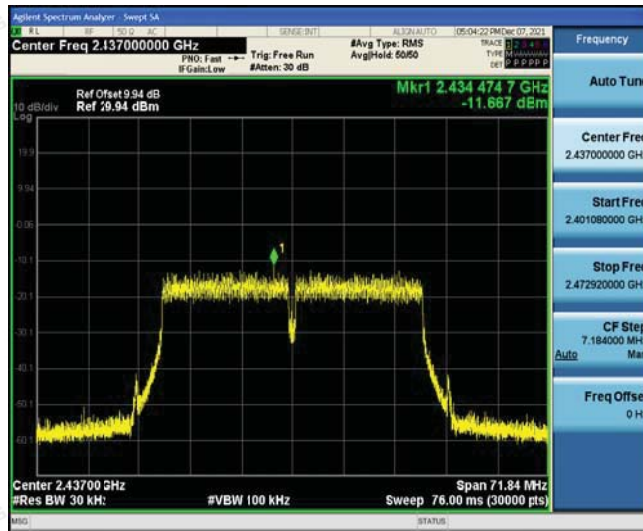

Highest channel

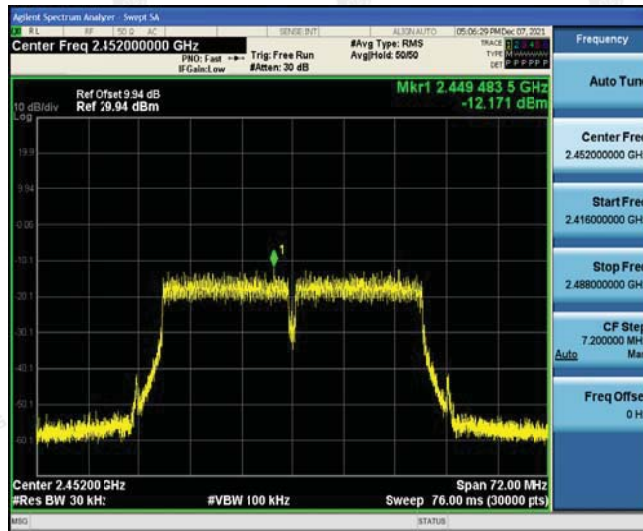

The results shown in this test report refer only to the sample(s) tested unless otherwise stated and the sample(s) are retained for 30 days only. The document is issued by HUAKE, this document cannot be reproduced except in full with our prior written permission. The more details and the authenticity of the report will be confirmed at <http://www.cer-mark.com>.

4.6. Conducted Band Edge and Spurious Emission Measurement

Test Specification

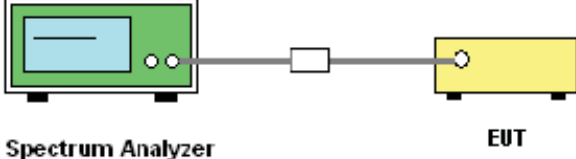
Test Requirement:	FCC Part15 C Section 15.247 (d)
Test Method:	KDB558074
Limit:	In any 100 kHz bandwidth outside of the authorized frequency band, the emissions which fall in the non-restricted bands shall be attenuated at least 20 dB / 30dB relative to the maximum PSD level in 100 kHz by RF conducted measurement and radiated emissions which fall in the restricted bands, as defined in Section 15.205(a), must also comply with the radiated emission limits specified in Section 15.209(a).
Test Setup:	 <p style="text-align: center;"> Spectrum Analyzer EUT </p>
Test Mode:	Transmitting mode with modulation
Test Procedure:	<ol style="list-style-type: none"> 1. The testing follows FCC KDB Publication 558074 D01 15.247 Meas Guidance v05r02. 2. The RF output of EUT was connected to the spectrum analyzer by RF cable and attenuator. The path loss was compensated to the results for each measurement. 3. Set to the maximum power setting and enable the EUT transmit continuously. 4. Set RBW = 100 kHz, VBW=300 kHz, Peak Detector. Unwanted Emissions measured in any 100 kHz bandwidth outside of the authorized frequency band shall be attenuated by at least 20 dB relative to the maximum in-band peak PSD level in 100 kHz when maximum peak conducted output power procedure is used. If the transmitter complies with the conducted power limits based on the use of RMS averaging over a time interval, the attenuation required under this paragraph shall be 30 dB instead of 20 dB per 15.247(d). 5. Measure and record the results in the test report. 6. The RF fundamental frequency should be excluded against the limit line in the operating frequency band.
Test Result:	PASS



Test Instruments

RF Test Room					
Equipment	Manufacturer	Model	Serial Number	Calibration Date	Calibration Due
Spectrum analyzer	Agilent	N9020A	HKE-048	Dec. 10, 2020	Dec. 09, 2021
High pass filter unit	Tonscend	JS0806-F	HKE-055	Dec. 10, 2020	Dec. 09, 2021
RF Cable (9KHz-26.5GHz)	Tonscend	170660	N/A	Dec. 10, 2020	Dec. 09, 2021
RF automatic control unit	Tonscend	JS0806-2	HKE-060	Dec. 10, 2020	Dec. 09, 2021
RF test software	Tonscend	JS1120-B Version 2.6	HKE-083	N/A	N/A

Note: The calibration interval of the above test instruments is 12 months and the calibrations are traceable to international system unit (SI).



Test Data

802.11b Modulation

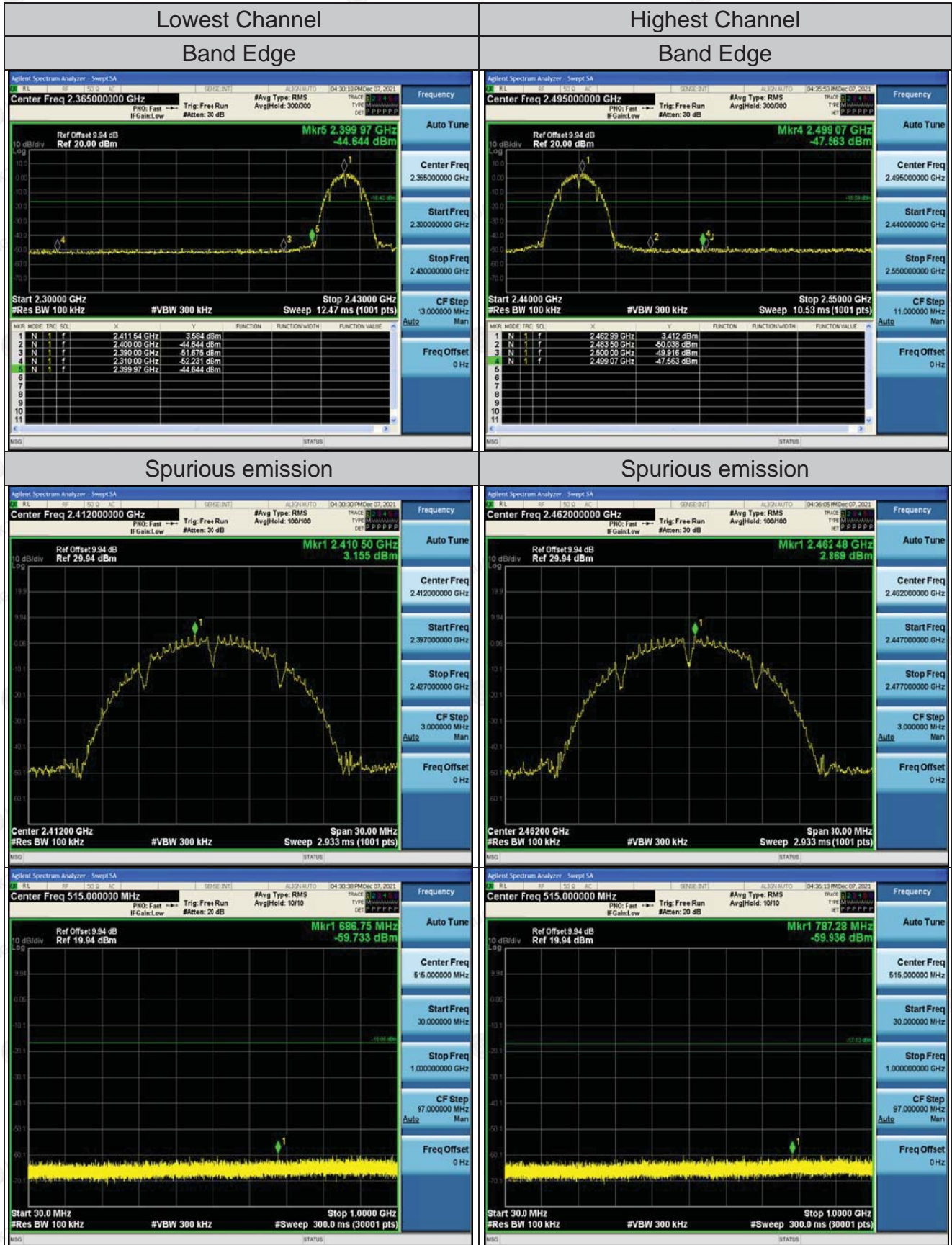

The results shown in this test report refer only to the sample(s) unless otherwise stated and the sample(s) are retained for 30 days only. The document is issued by HUAKE, this document cannot be reproduced except in full with our prior written permission. The more details and the authenticity of the report will be confirmed at <http://www.cer-mark.com>.

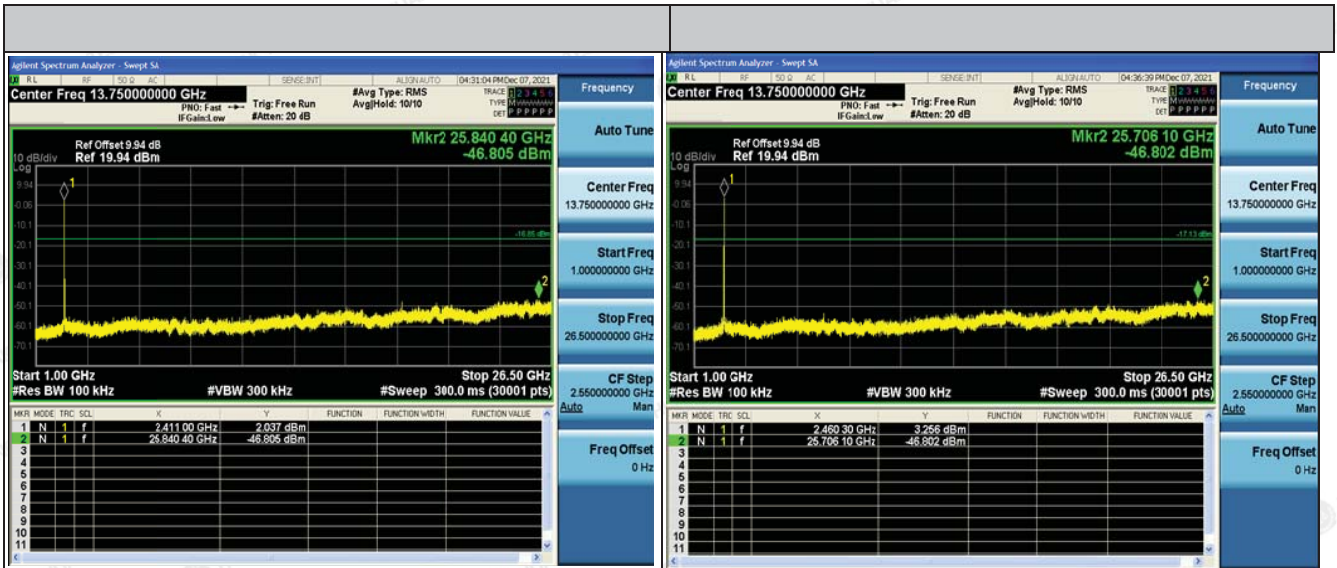

middle Channel
Spurious emission

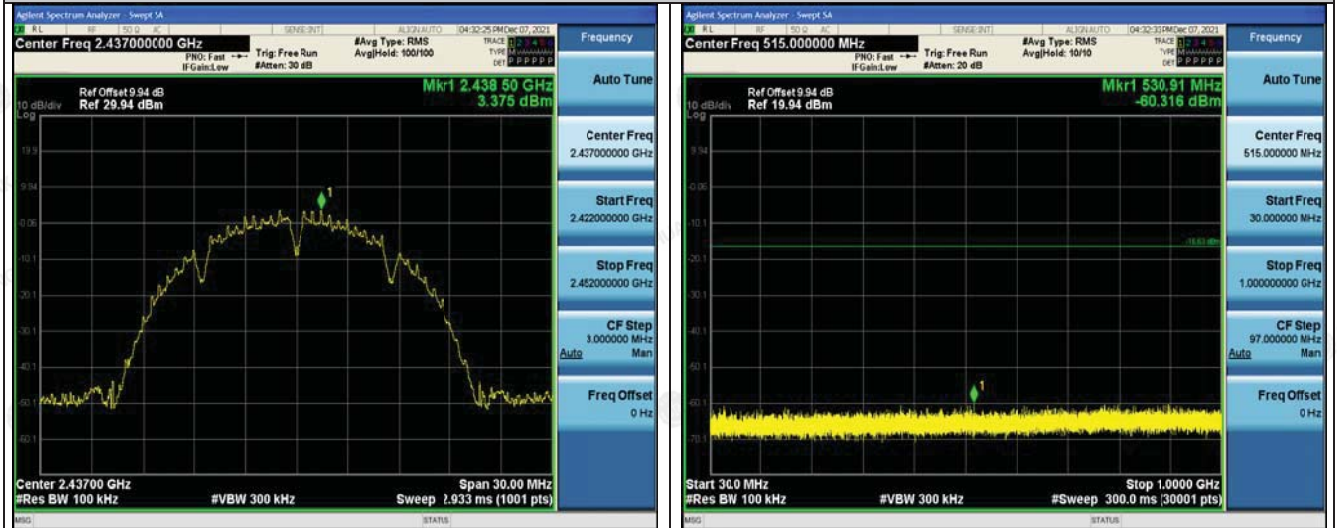

The results shown in this test report refer only to the sample(s) tested unless otherwise stated and the sample(s) are retained for 30 days only. The document is issued by HUAKE, this document cannot be reproduced except in full with our prior written permission. The more details and the authenticity of the report will be confirmed at <http://www.cer-mark.com>.



802.11g Modulation

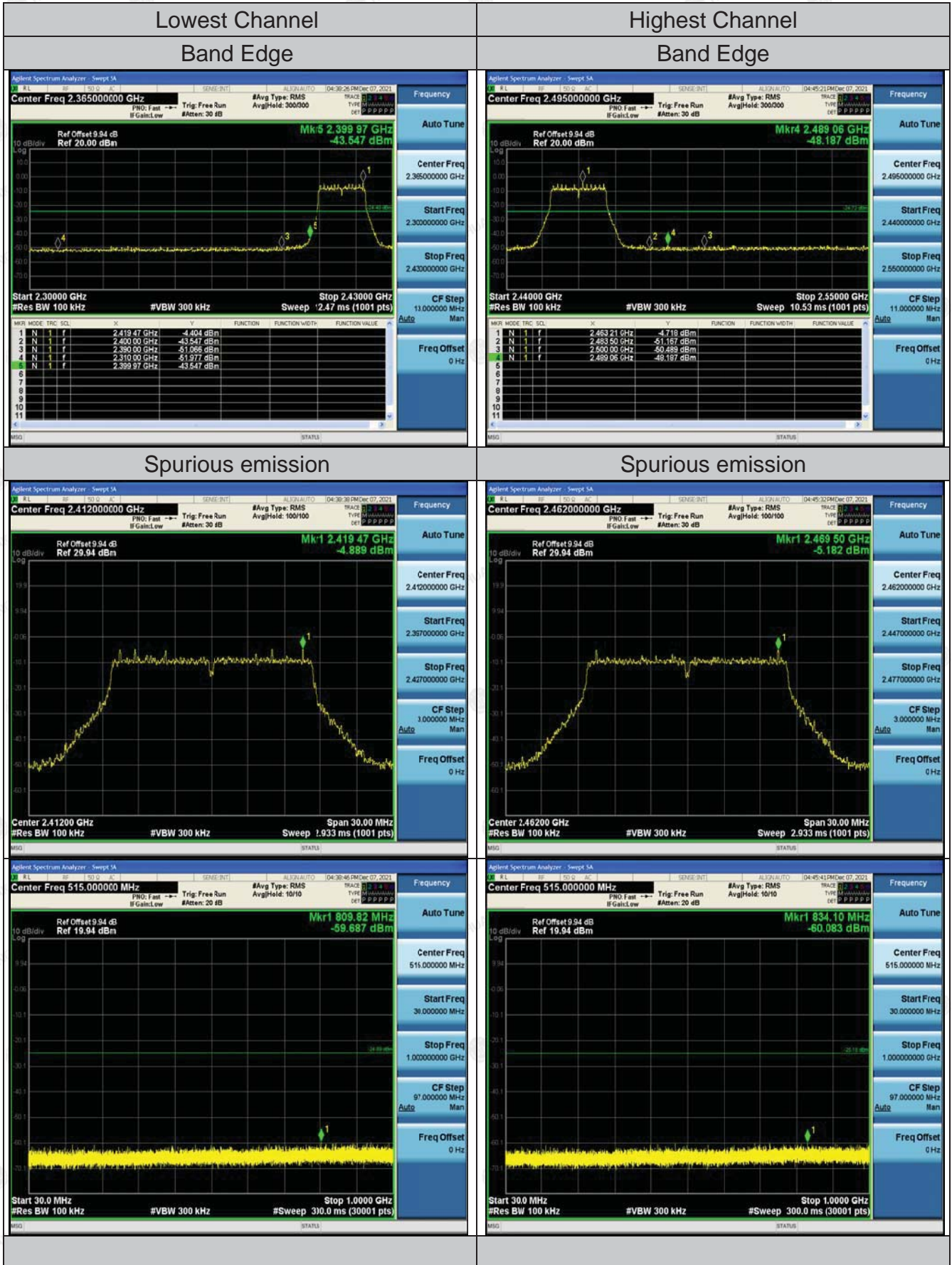

The results shown in this test report refer only to the sample(s) tested unless otherwise stated and the sample(s) are retained for 30 days only. This document is issued by HUAKE, this document cannot be reproduced except in full with our prior written permission. The more details and the authenticity of the report will be confirmed at <http://www.cer-mark.com>.

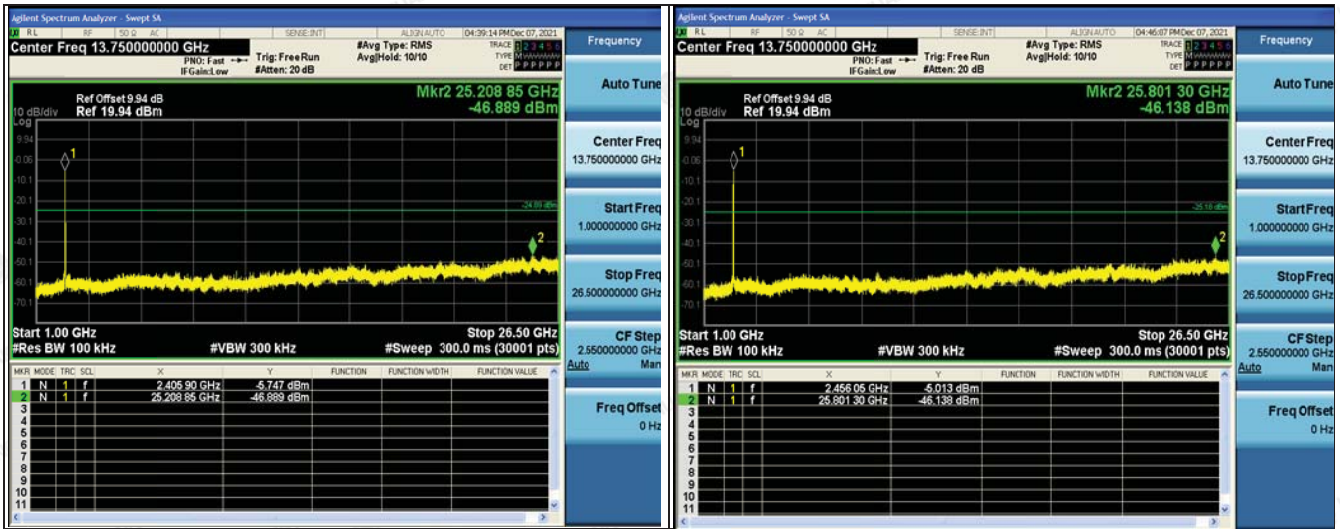

middle Channel
Spurious emission

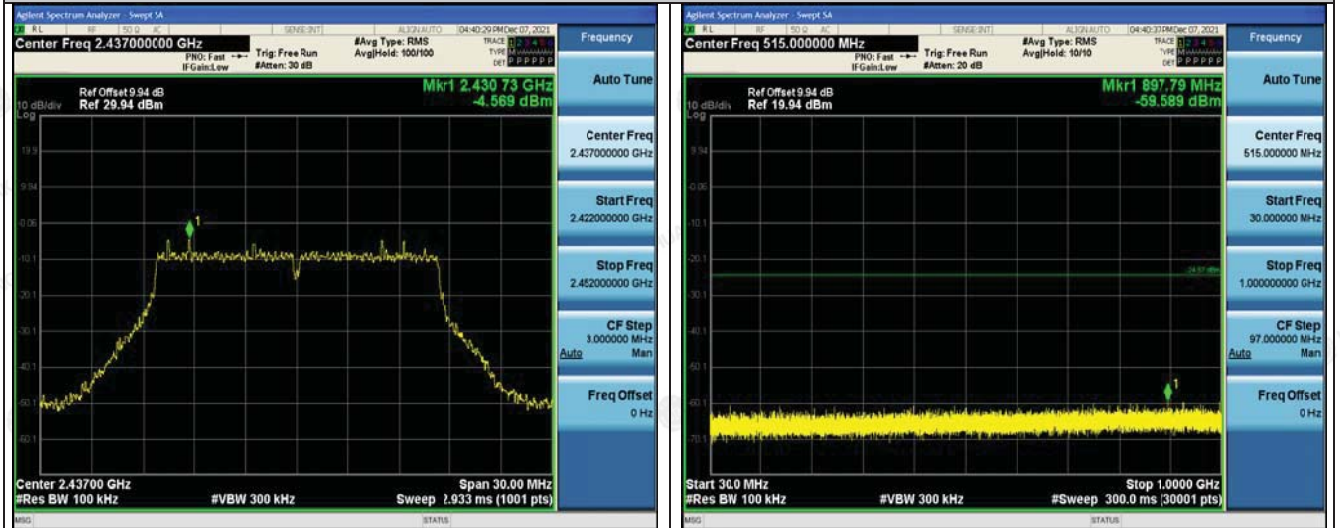

The results shown in this test report refer only to the sample(s) tested unless otherwise stated and the sample(s) are retained for 30 days only. The document is issued by HUAKE, this document cannot be reproduced except in full with our prior written permission. The more details and the authenticity of the report will be confirmed at <http://www.cer-mark.com>.



802.11n (HT20) Modulation

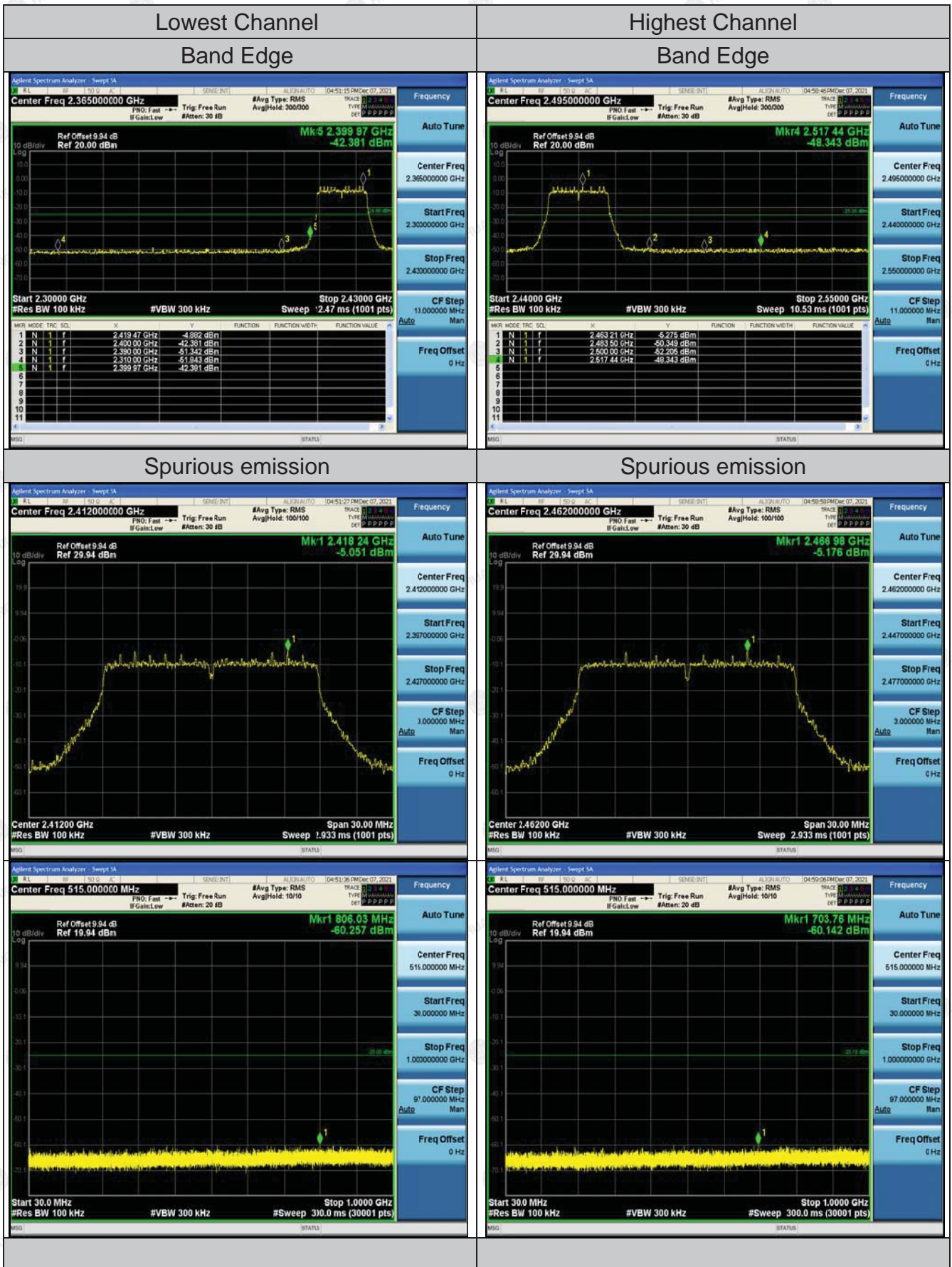

The results shown in this test report refer only to the sample(s) tested unless otherwise stated and the sample(s) are retained for 30 days only. The document is issued by HUAKE, this document cannot be reproduced except in full with our prior written permission. The more details and the authenticity of the report will be confirmed at <http://www.cer-mark.com>.

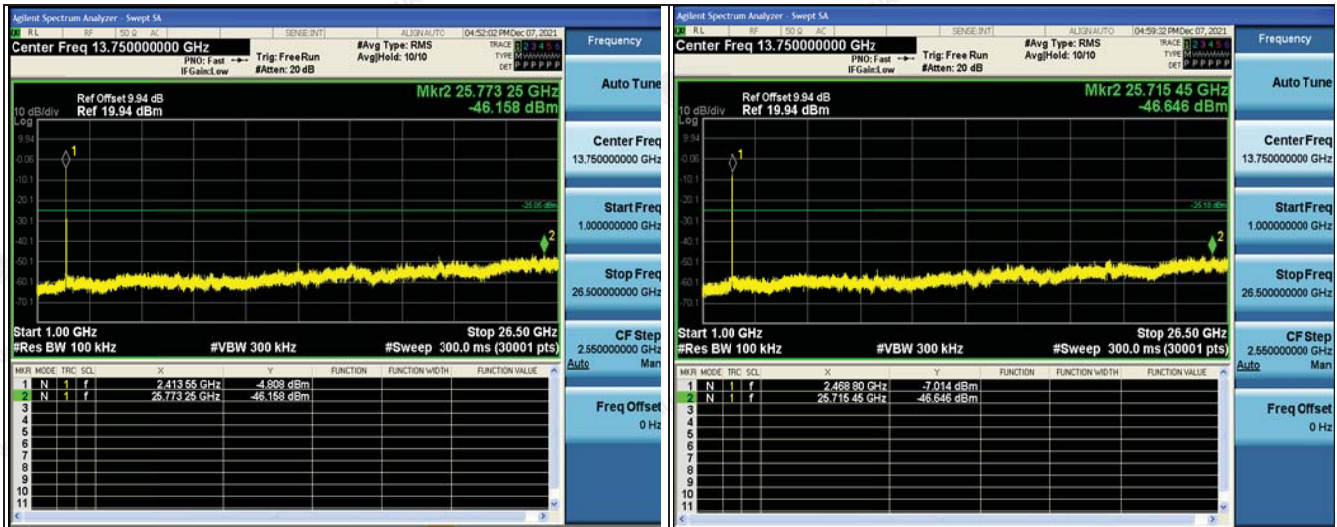

middle Channel
Spurious emission

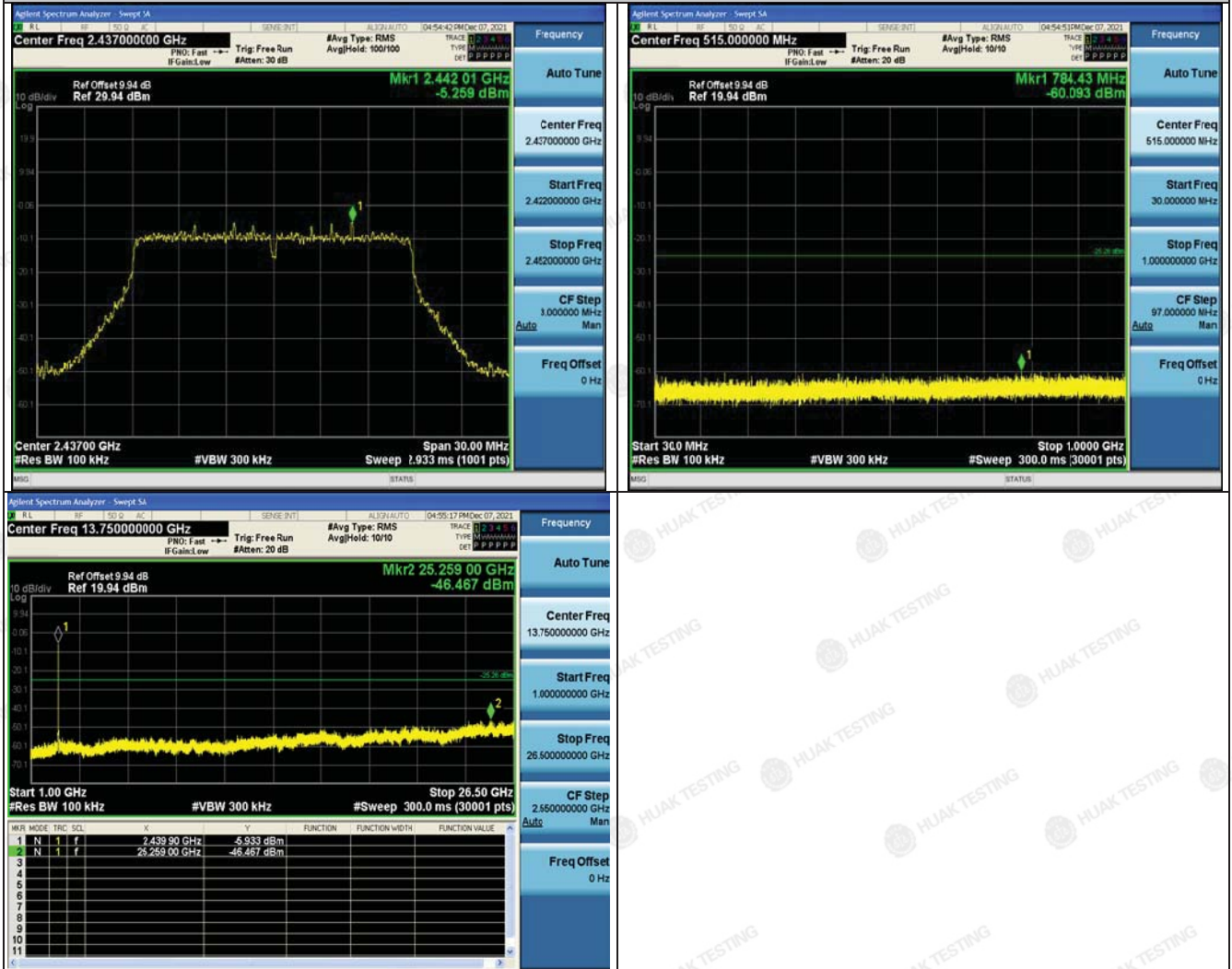

The results shown in this test report refer only to the sample(s) tested unless otherwise stated and the sample(s) are retained for 30 days only. The document is issued by HUAJ, this document cannot be reproduced except in full with our prior written permission. The more details and the authenticity of the report will be confirmed at <http://www.cer-mark.com>.



802.11n (HT40) Modulation

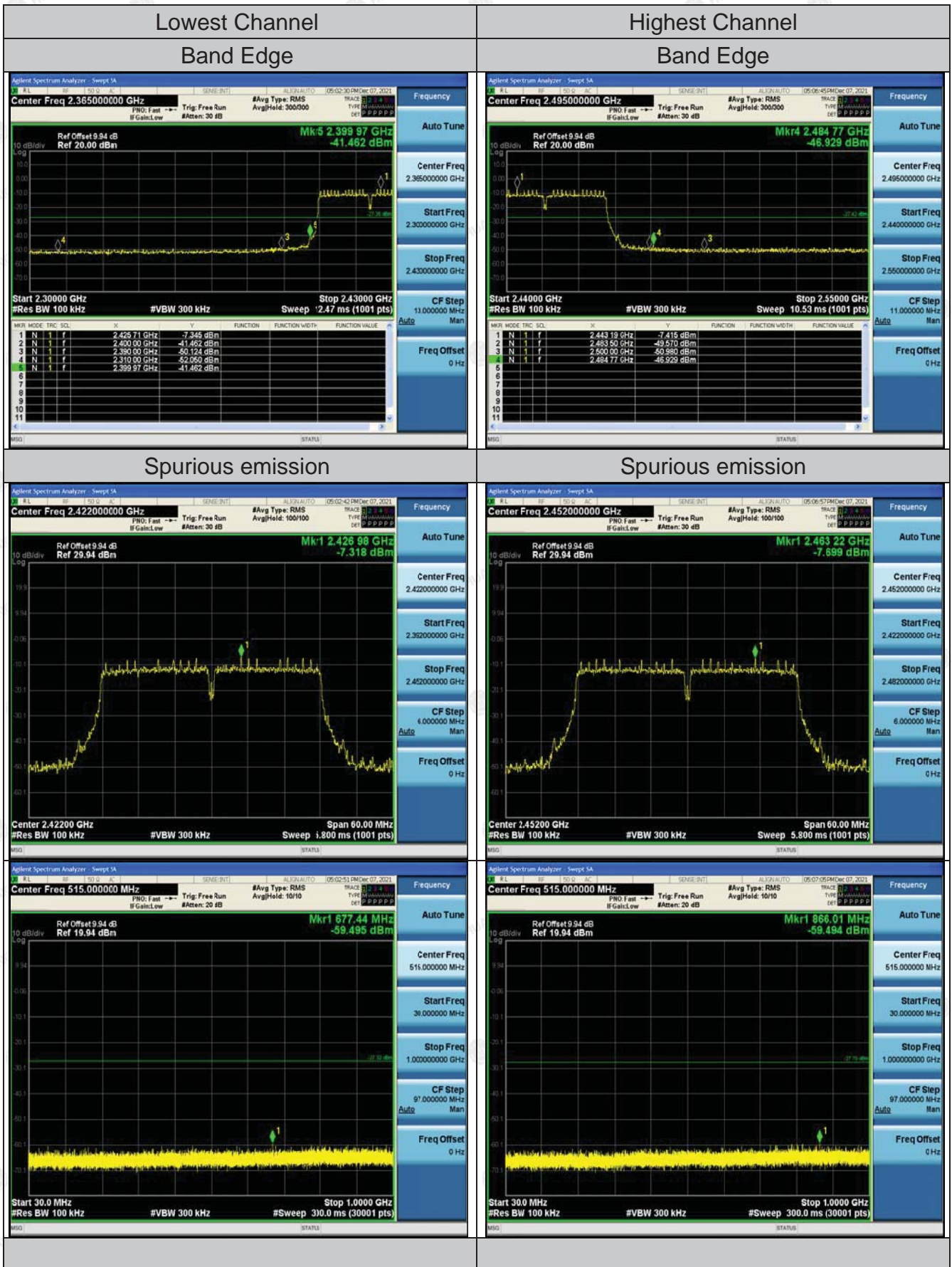

The results shown in this test report refer only to the sample(s) tested unless otherwise stated and the sample(s) are retained for 30 days only. This document is issued by HUAKE, this document cannot be reproduced except in full with our prior written permission. The more details and the authenticity of the report will be confirmed at <http://www.cer-mark.com>.

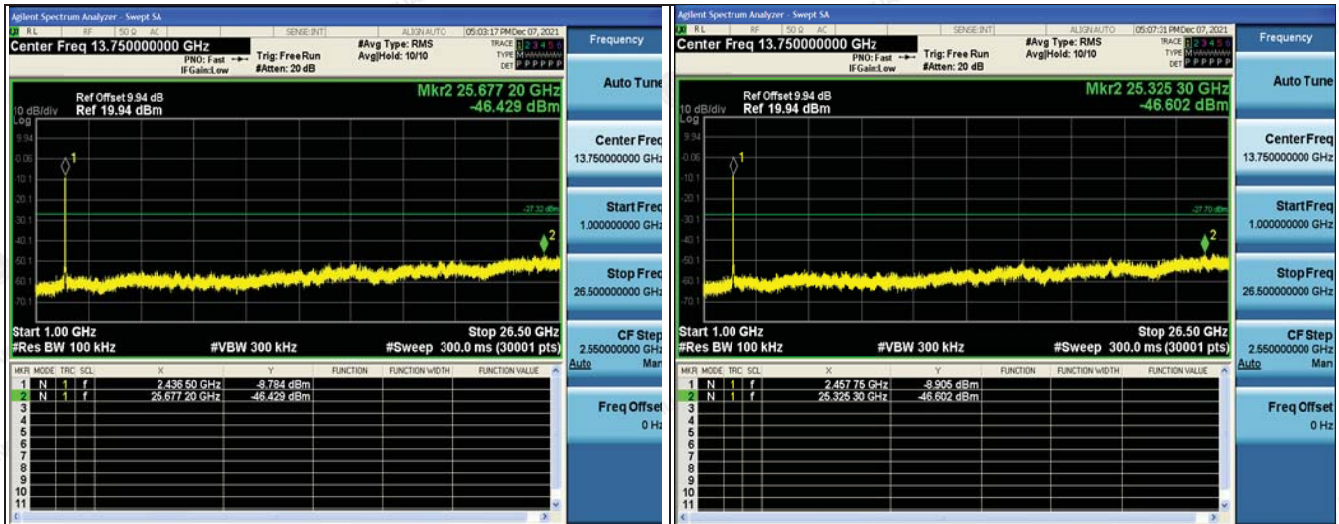

middle Channel
Spurious emission

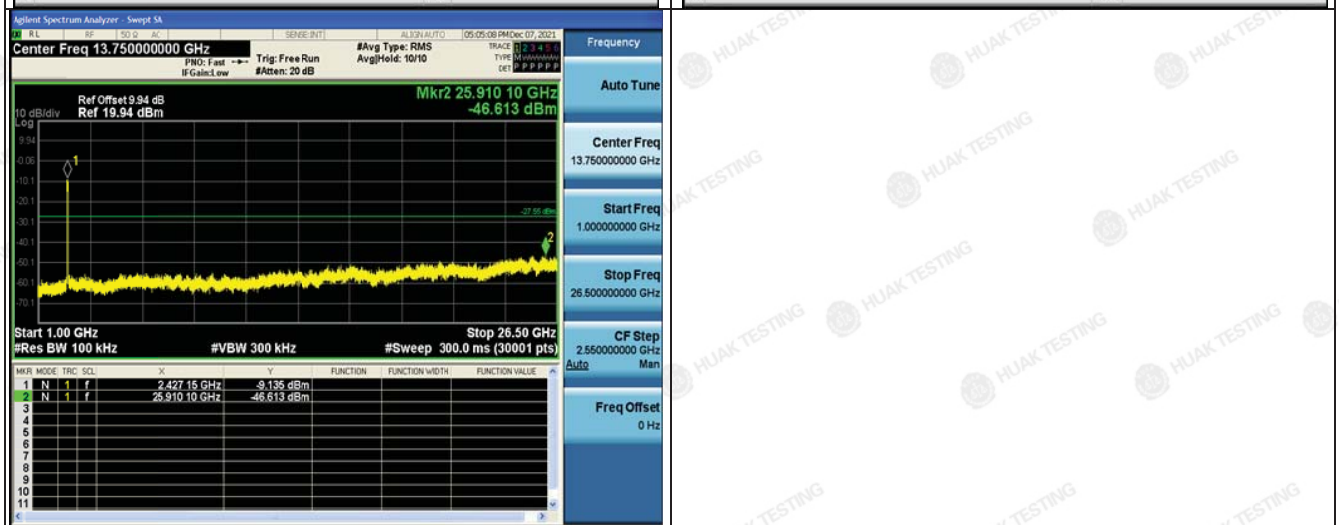
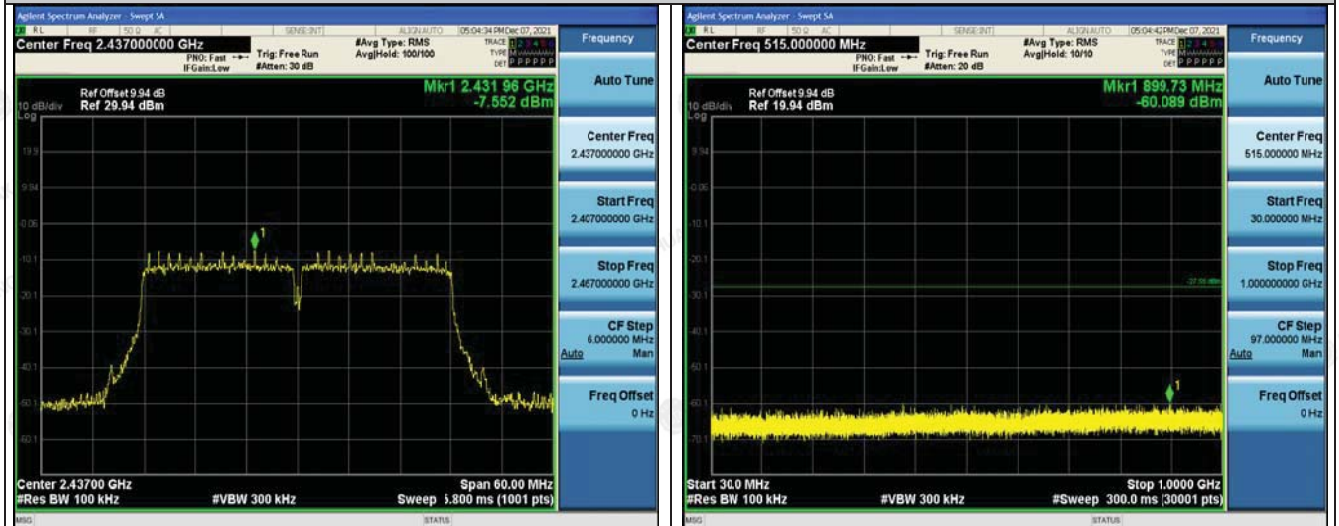

The results shown in this test report refer only to the sample(s) tested unless otherwise stated and the sample(s) are retained for 30 days only. The document is issued by HUAKE, this document cannot be reproduced except in full with our prior written permission. The more details and the authenticity of the report will be confirmed at <http://www.cer-mark.com>.

4.7. Radiated Spurious Emission Measurement

Test Specification

Test Requirement:	FCC Part15 C Section 15.209				
Test Method:	ANSI C63.10: 2013				
Frequency Range:	9 kHz to 25 GHz				
Measurement Distance:	3 m				
Antenna Polarization:	Horizontal & Vertical				
Operation mode:	Transmitting mode with modulation				
Receiver Setup:	Frequency	Detector	RBW	VBW	Remark
	9kHz- 150kHz	Quasi-peak	200Hz	1kHz	Quasi-peak Value
	150kHz- 30MHz	Quasi-peak	9kHz	30kHz	Quasi-peak Value
	30MHz-1GHz	Quasi-peak	120KHz	300KHz	Quasi-peak Value
	Above 1GHz	Peak	1MHz	3MHz	Peak Value
Peak		1MHz	10Hz	Average Value	
Limit:	Frequency	Field Strength (microvolts/meter)	Measurement Distance (meters)		
	0.009-0.490	2400/F(KHz)	300		
	0.490-1.705	24000/F(KHz)	30		
	1.705-30	30	30		
	30-88	100	3		
	88-216	150	3		
	216-960	200	3		
	Above 960	500	3		
	Frequency	Field Strength (microvolts/meter)	Measurement Distance (meters)	Detector	
	Above 1GHz	500	3	Average	
	5000	3	Peak		
Test setup:	For radiated emissions below 30MHz				
	30MHz to 1GHz				

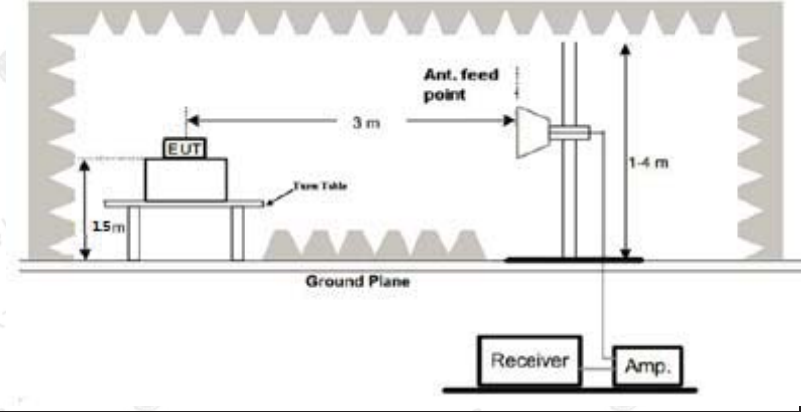
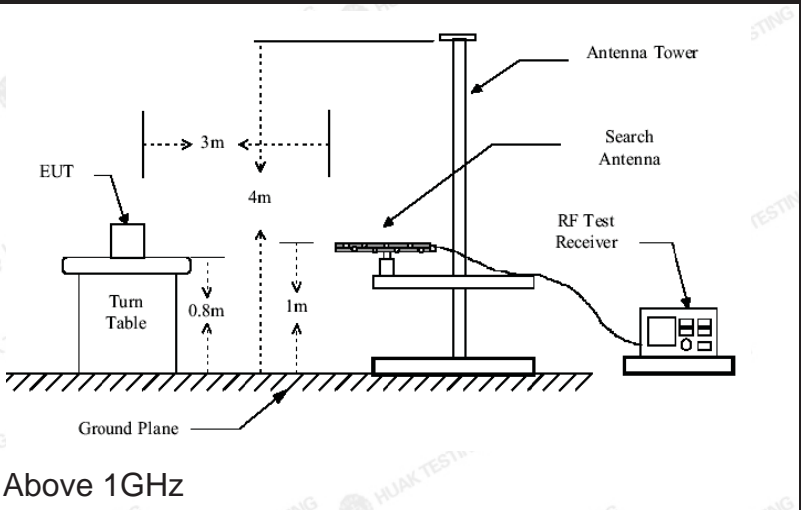

Test Procedure:

1. For the radiated emission test below 1GHz:
 The EUT was placed on a turntable with 0.8 meter above ground. The EUT was set 3 meters from the interference receiving antenna, which was mounted on the top of a variable height antenna tower. The EUT was arranged to its worst case and then tune the antenna tower (from 1 m to 4 m) and turntable (from 0 degree to 360 degrees) to find the maximum reading. A pre-amp and a high PASS filter are used for the test in order to get better signal level.

For the radiated emission test above 1GHz:
 Place the measurement antenna on a turntable with 1.5 meter above ground, which is away from each area of the EUT determined to be a source of emissions at the specified measurement distance, while keeping the measurement antenna aimed at the source of emissions at each frequency of significant emissions, with polarization oriented for maximum response. The measurement antenna may have to be higher or lower than the EUT,



	<p>depending on the radiation pattern of the emission and staying aimed at the emission source for receiving the maximum signal. The final measurement antenna elevation shall be that which maximizes the emissions. The measurement antenna elevation for maximum emissions shall be restricted to a range of heights of from 1 m to 4 m above the ground or reference ground plane.</p> <ol style="list-style-type: none"> 3. Corrected Reading: Antenna Factor + Cable Loss + Read Level - Preamp Factor = Level 4. For measurement below 1GHz, If the emission level of the EUT measured by the peak detector is 3 dB lower than the applicable limit, the peak emission level will be reported. Otherwise, the emission measurement will be repeated using the quasi-peak detector and reported. 5. Use the following spectrum analyzer settings: <ol style="list-style-type: none"> (1) Span shall wide enough to fully capture the emission being measured; (2) Set RBW=120 kHz for $f < 1$ GHz; $VBW \geq RBW$; Sweep = auto; Detector function = peak; Trace = max hold; (3) Set RBW = 1 MHz, $VBW = 3$ MHz for $f \geq 1$ GHz for peak measurement. <p>For average measurement: $VBW = 10$ Hz, when duty cycle is no less than 98 percent. $VBW \geq 1/T$, when duty cycle is less than 98 percent where T is the minimum transmission duration over which the transmitter is on and is transmitting at its maximum power control level for the tested mode of operation.</p>
Test results:	PASS



Test Instruments

Radiated Emission Test Site (966)

Name of Equipment	Manufacturer	Model	Serial Number	Calibration Date	Calibration Due
Receiver	R&S	ESCI 7	HKE-010	Dec. 10, 2020	Dec. 09, 2021
Spectrum analyzer	Agilent	N9020A	HKE-048	Dec. 10, 2020	Dec. 09, 2021
Spectrum analyzer	R&S	FSP40	HKE-025	Dec. 10, 2020	Dec. 09, 2021
High gain antenna	Schwarzbeck	LB-180400KF	HKE-054	Dec. 10, 2020	Dec. 09, 2021
Preamplifier	Schwarzbeck	BBV 9743	HKE-006	Dec. 10, 2020	Dec. 09, 2021
Preamplifier	EMCI	EMC051845S E	HKE-015	Dec. 10, 2020	Dec. 09, 2021
Preamplifier	Agilent	83051A	HKE-016	Dec. 10, 2020	Dec. 09, 2021
Loop antenna	Schwarzbeck	FMZB 1519 B	HKE-014	Dec. 10, 2020	Dec. 09, 2021
Broadband antenna	Schwarzbeck	VULB 9163	HKE-012	Dec. 10, 2020	Dec. 09, 2021
Horn antenna	Schwarzbeck	9120D	HKE-013	Dec. 10, 2020	Dec. 09, 2021
High pass filter unit	Tonscend	JS0806-F	HKE-055	Dec. 10, 2020	Dec. 09, 2021
Antenna Mast	Keleto	CC-A-4M	N/A	N/A	N/A
Position controller	Taiwan MF	MF7802	HKE-011	Dec. 10, 2020	Dec. 09, 2021
Radiated test software	Tonscend	TS+ Rev 2.5.0.0	HKE-082	N/A	N/A
RF cable	Times	9kHz-1GHz	HKE-117	Dec. 10, 2020	Dec. 09, 2021
RF cable	Times	1-40G	HKE-034	Dec. 10, 2020	Dec. 09, 2021
Horn Antenna	Schwarzbeck	BBHA 9170	HKE-017	Dec. 10, 2020	Dec. 09, 2021

Note: The calibration interval of the above test instruments is 12 months and the calibrations are traceable to international system unit (SI).



Test Data

All the test modes completed for test. only the worst result of (802.11b at 2412MHz) was reported as below:

Below 1GHz

Horizontal

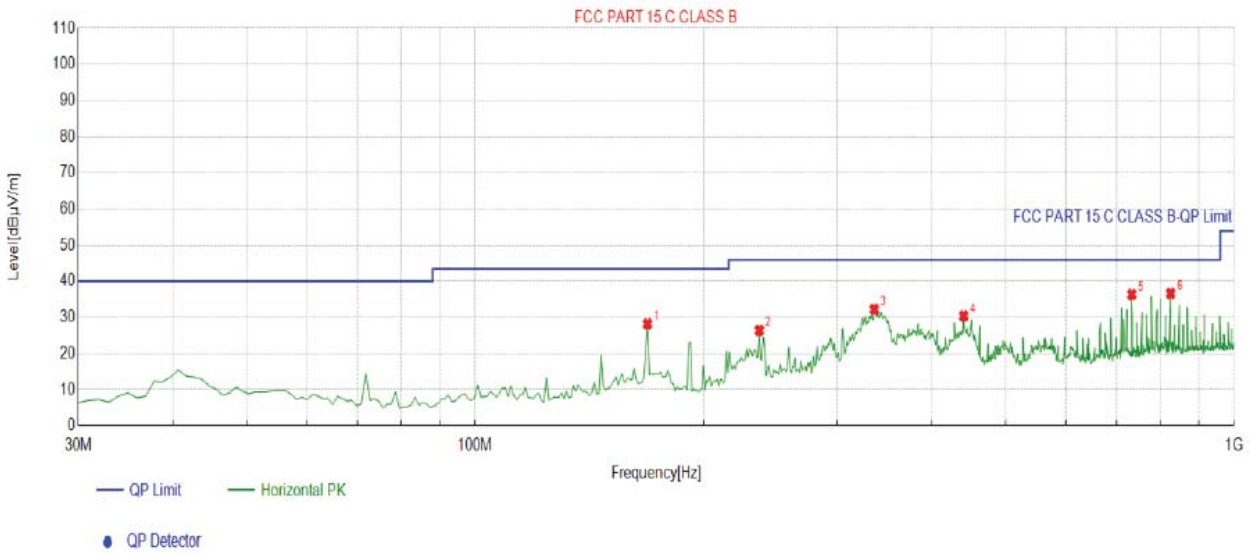

Suspected List									
NO.	Freq. [MHz]	Factor [dB]	Reading [dBµV/m]	Level [dBµV/m]	Limit [dBµV/m]	Margin [dB]	Height [cm]	Angle [°]	Polarity
1	168.8488	-17.41	45.62	28.21	43.50	15.29	100	272	Horizontal
2	236.8168	-14.00	40.41	26.41	46.00	19.59	100	103	Horizontal
3	335.8559	-11.62	43.83	32.21	46.00	13.79	100	259	Horizontal
4	440.7207	-9.39	39.80	30.41	46.00	15.59	100	283	Horizontal
5	733.9540	-4.38	40.71	36.33	46.00	9.67	100	325	Horizontal
6	825.2252	-2.56	39.20	36.64	46.00	9.36	100	158	Horizontal

Remark: Factor = Cable loss + Antenna factor - Preamplifier; Level = Reading + Factor; Margin = Limit - Level



Vertical

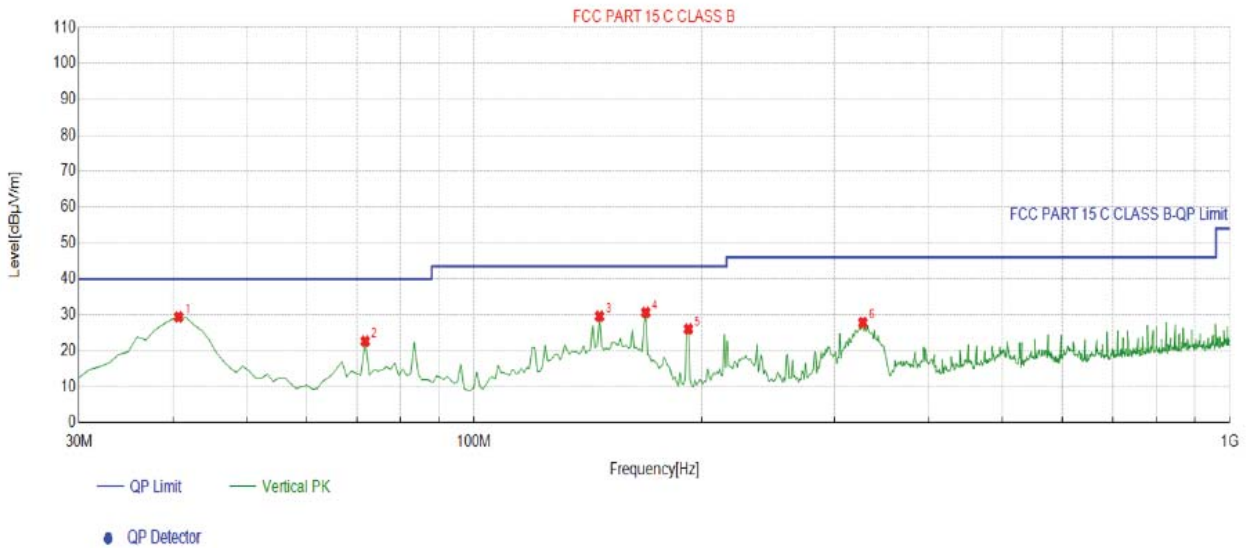

Suspected List									
NO.	Freq. [MHz]	Factor [dB]	Reading [dBµV/m]	Level [dBµV/m]	Limit [dBµV/m]	Margin [dB]	Height [cm]	Angle [°]	Polarity
1	40.6807	-14.42	43.85	29.43	40.00	10.57	100	6	Vertical
2	71.7518	-17.99	40.69	22.70	40.00	17.30	100	119	Vertical
3	146.5165	-19.02	48.65	29.63	43.50	13.87	100	344	Vertical
4	168.8488	-17.41	48.10	30.69	43.50	12.81	100	286	Vertical
5	192.1522	-15.81	41.89	26.08	43.50	17.42	100	238	Vertical
6	327.1171	-11.74	39.59	27.85	46.00	18.15	100	2	Vertical

Remark: Factor = Cable loss + Antenna factor - Preamplifier; Level = Reading + Factor; Margin = Limit - Level

Harmonics and Spurious Emissions

Frequency Range (9 kHz-30MHz)

Frequency (MHz)	Level@3m (dBµV/m)	Limit@3m (dBµV/m)
--	--	--
--	--	--
--	--	--
--	--	--

- Note:** 1. Emission Level=Reading+ Cable loss-Antenna factor-Amp factor
 2. The emission levels are 20 dB below the limit value, which are not reported. It is deemed to comply with the requirement



Above 1GHz

RADIATED EMISSION TEST

LOW CH1 (802.11b Mode)/2412

Horizontal:

Frequency (MHz)	Reading Result (dBµV)	Factor (dB)	Emission Level (dBµV/m)	Limits (dBµV/m)	Margin (dB)	Detector Type
4824	59.37	-3.64	55.73	74	-18.27	peak
4824	44.15	-3.64	40.51	54	-13.49	AVG
7236	55.28	-0.95	54.33	74	-19.67	peak
7236	43.35	-0.95	42.4	54	-11.6	AVG

Remark: Factor = Antenna Factor + Cable Loss – Pre-amplifier.

Vertical:

Frequency (MHz)	Reading Result (dBµV)	Factor (dB)	Emission Level (dBµV/m)	Limits (dBµV/m)	Margin (dB)	Detector Type
4824	58.64	-3.64	55	74	-19	peak
4824	45.62	-3.64	41.98	54	-12.02	AVG
7236	56.37	-0.95	55.42	74	-18.58	peak
7236	43.34	-0.95	42.39	54	-11.61	AVG

Remark: Factor = Antenna Factor + Cable Loss – Pre-amplifier.



MID CH6 (802.11b Mode)/2437

Horizontal:

Frequency	Reading Result	Factor	Emission Level	Limits	Margin	Detector Type
(MHz)	(dBµV)	(dB)	(dBµV/m)	(dBµV/m)	(dB)	
4874	59.17	-3.51	55.66	74	-18.34	peak
4874	45.16	-3.51	41.65	54	-12.35	AVG
7311	57.57	-0.82	56.75	74	-17.25	peak
7311	43.28	-0.82	42.46	54	-11.54	AVG

Remark: Factor = Antenna Factor + Cable Loss – Pre-amplifier.

Vertical:

Frequency	Reading Result	Factor	Emission Level	Limits	Margin	Detector Type
(MHz)	(dBµV)	(dB)	(dBµV/m)	(dBµV/m)	(dB)	
4874	58.58	-3.51	55.07	74	-18.93	peak
4874	45.65	-3.51	42.14	54	-11.86	AVG
7311	58.72	-0.82	57.9	74	-16.1	peak
7311	42.16	-0.82	41.34	54	-12.66	AVG

Remark: Factor = Antenna Factor + Cable Loss – Pre-amplifier.



HIGH CH11 (802.11b Mode)/2462

Horizontal:

Frequency (MHz)	Reading Result (dBμV)	Factor (dB)	Emission Level (dBμV/m)	Limits (dBμV/m)	Margin (dB)	Detector Type
4924	60.37	-3.43	56.94	74	-17.06	peak
4924	45.19	-3.43	41.76	54	-12.24	AVG
7386	56.22	-0.75	55.47	74	-18.53	peak
7386	43.34	-0.75	42.59	54	-11.41	AVG

Remark: Factor = Antenna Factor + Cable Loss – Pre-amplifier.

Vertical:

Frequency (MHz)	Reading Result (dBμV)	Factor (dB)	Emission Level (dBμV/m)	Limits (dBμV/m)	Margin (dB)	Detector Type
4924	59.38	-3.43	55.95	74	-18.05	peak
4924	45.62	-3.43	42.19	54	-11.81	AVG
7386	56.38	-0.75	55.63	74	-18.37	peak
7386	42.35	-0.75	41.6	54	-12.4	AVG

Remark: Factor = Antenna Factor + Cable Loss – Pre-amplifier.

Remark:

- (1) Measuring frequencies from 1 GHz to the 25 GHz.
- (2) "F" denotes fundamental frequency; "H" denotes spurious frequency. "E" denotes bandedge frequency.
- (3) * denotes emission frequency which appearing within the Restricted Bands specified in provision of 15.205, then the general radiated emission limits in 15.209 apply.
- (4) The emissions are attenuated more than 20dB below the permissible limits are not recorded in the report.
- (5) The IF bandwidth of EMI Test Receiver between 30MHz to 1GHz was 120KHz, 1 MHz for measuring above 1 GHz, below 30MHz was 10KHz.
- (6) When the test results of Peak Detected below the limits of Average Detected, the Average Detected is not need completed. For example: Top Channel at Fundamental 73.16dBuV/m(PK Value) <93.98(AV Limit), at harmonic 53.20 dBuV/m(PK Value) <54dBuV/m(AV Limit), the Average Detected not need to completed.
- (7) All modes of operation were investigated and worst-case emissions are reported.



LOW CH1 (802.11g Mode)/2412

Horizontal:

Frequency	Reading Result	Factor	Emission Level	Limits	Margin	Detector Type
(MHz)	(dBμV)	(dB)	(dBμV/m)	(dBμV/m)	(dB)	
4824	62.38	-3.64	58.74	74	-15.26	peak
4824	45.12	-3.64	41.48	54	-12.52	AVG
7236	55.38	-0.95	54.43	74	-19.57	peak
7236	42.35	-0.95	41.4	54	-12.6	AVG

Remark: Factor = Antenna Factor + Cable Loss – Pre-amplifier.

Vertical:

Frequency	Reading Result	Factor	Emission Level	Limits	Margin	Detector Type
(MHz)	(dBμV)	(dB)	(dBμV/m)	(dBμV/m)	(dB)	
4824	59.17	-3.64	55.53	74	-18.47	peak
4824	45.16	-3.64	41.52	54	-12.48	AVG
7236	55.98	-0.95	55.03	74	-18.97	peak
7236	42.30	-0.95	41.35	54	-12.65	AVG

Remark: Factor = Antenna Factor + Cable Loss – Pre-amplifier.



MID CH6 (802.11g Mode)/2437

Horizontal:

Frequency	Reading Result	Factor	Emission Level	Limits	Margin	Detector Type
(MHz)	(dBμV)	(dB)	(dBμV/m)	(dBμV/m)	(dB)	
4874	60.37	-3.51	56.86	74	-17.14	peak
4874	47.58	-3.51	44.07	54	-9.93	AVG
7311	56.22	-0.82	55.4	74	-18.6	peak
7311	42.69	-0.82	41.87	54	-12.13	AVG

Remark: Factor = Antenna Factor + Cable Loss – Pre-amplifier.

Vertical:

Frequency	Reading Result	Factor	Emission Level	Limits	Margin	Detector Type
(MHz)	(dBμV)	(dB)	(dBμV/m)	(dBμV/m)	(dB)	
4874	61.34	-3.51	57.83	74	-16.17	peak
4874	45.12	-3.51	41.61	54	-12.39	AVG
7311	57.69	-0.82	56.87	74	-17.13	peak
7311	42.05	-0.82	41.23	54	-12.77	AVG

Remark: Factor = Antenna Factor + Cable Loss – Pre-amplifier.



HIGH CH11 (802.11g Mode)/2462

Horizontal:

Frequency	Reading Result	Factor	Emission Level	Limits	Margin	Detector Type
(MHz)	(dBμV)	(dB)	(dBμV/m)	(dBμV/m)	(dB)	
4924	59.37	-3.43	55.94	74	-18.06	peak
4924	45.17	-3.43	41.74	54	-12.26	AVG
7386	55.01	-0.75	54.26	74	-19.74	peak
7386	40	-0.75	39.25	54	-14.75	AVG

Remark: Factor = Antenna Factor + Cable Loss – Pre-amplifier.

Vertical:

Frequency	Reading Result	Factor	Emission Level	Limits	Margin	Detector Type
(MHz)	(dBμV)	(dB)	(dBμV/m)	(dBμV/m)	(dB)	
4924	57.62	-3.43	54.19	74	-19.81	peak
4924	47.25	-3.43	43.82	54	-10.18	AVG
7386	56.23	-0.75	55.48	74	-18.52	peak
7386	43.35	-0.75	42.6	54	-11.4	AVG

Remark: Factor = Antenna Factor + Cable Loss – Pre-amplifier.

Remark:

- (1) Measuring frequencies from 1 GHz to the 25 GHz.
- (2) "F" denotes fundamental frequency; "H" denotes spurious frequency. "E" denotes bandedge frequency.
- (3) * denotes emission frequency which appearing within the Restricted Bands specified in provision of 15.205, then the general radiated emission limits in 15.209 apply.
- (4) The emissions are attenuated more than 20dB below the permissible limits are not recorded in the report.
- (5) The IF bandwidth of EMI Test Receiver between 30MHz to 1GHz was 120KHz, 1 MHz for measuring above 1 GHz, below 30MHz was 10KHz.
- (6) When the test results of Peak Detected below the limits of Average Detected, the Average Detected is not need completed. For example: Top Channel at Fundamental 73.16dBuV/m(PK Value) <93.98(AV Limit), at harmonic 53.20 dBuV/m(PK Value) <54dBuV/m(AV Limit), the Average Detected not need to completed.
- (7) All modes of operation were investigated and worst-case emissions are reported.



LOW CH1 (802.11n/H20 Mode)/2412

Horizontal:

Frequency	Reading Result	Factor	Emission Level	Limits	Margin	Detector Type
(MHz)	(dBμV)	(dB)	(dBμV/m)	(dBμV/m)	(dB)	
4824	60.37	-3.64	56.73	74	-17.27	peak
4824	42.24	-3.64	38.6	54	-15.4	AVG
7236	56.19	-0.95	55.24	74	-18.76	peak
7236	42.05	-0.95	41.1	54	-12.9	AVG

Remark: Factor = Antenna Factor + Cable Loss – Pre-amplifier.

Vertical:

Frequency	Reading Result	Factor	Emission Level	Limits	Margin	Detector Type
(MHz)	(dBμV)	(dB)	(dBμV/m)	(dBμV/m)	(dB)	
4824	58.39	-3.64	54.75	74	-19.25	peak
4824	47.25	-3.64	43.61	54	-10.39	AVG
7236	56.98	-0.95	56.03	74	-17.97	peak
7236	42.15	-0.95	41.2	54	-12.8	AVG

Remark: Factor = Antenna Factor + Cable Loss – Pre-amplifier.



MID CH6 (802.11n/H20 Mode)/2437

Horizontal:

Frequency (MHz)	Reading Result (dBμV)	Factor (dB)	Emission Level (dBμV/m)	Limits (dBμV/m)	Margin (dB)	Detector Type
4874	59.27	-3.51	55.76	74.00	-18.24	peak
4874	45.25	-3.51	41.74	54.00	-12.26	AVG
7311	56.33	-0.82	55.51	74.00	-18.49	peak
7311	42.97	-0.82	42.15	54.00	-11.85	AVG

Remark: Factor = Antenna Factor + Cable Loss – Pre-amplifier.

Vertical:

Frequency (MHz)	Reading Result (dBμV)	Factor (dB)	Emission Level (dBμV/m)	Limits (dBμV/m)	Margin (dB)	Detector Type
4874	59.17	-3.51	55.66	74.00	-18.34	peak
4874	43.25	-3.51	39.74	54.00	-14.26	AVG
7311	57.69	-0.82	56.87	74.00	-17.13	peak
7311	43.31	-0.82	42.49	54.00	-11.51	AVG

Remark: Factor = Antenna Factor + Cable Loss – Pre-amplifier.



HIGH CH11 (802.11n/H20 Mode)/2462

Horizontal:

Frequency	Reading Result	Factor	Emission Level	Limits	Margin	Detector Type
(MHz)	(dBμV)	(dB)	(dBμV/m)	(dBμV/m)	(dB)	
4924	58.69	-3.43	55.26	74	-18.74	peak
4924	45.17	-3.43	41.74	54	-12.26	AVG
7386	55.32	-0.75	54.57	74	-19.43	peak
7386	42.16	-0.75	41.41	54	-12.59	AVG

Remark: Factor = Antenna Factor + Cable Loss – Pre-amplifier.

Vertical:

Frequency	Reading Result	Factor	Emission Level	Limits	Margin	Detector Type
(MHz)	(dBμV)	(dB)	(dBμV/m)	(dBμV/m)	(dB)	
4924	58.97	-3.43	55.54	74	-18.46	peak
4924	45.16	-3.43	41.73	54	-12.27	AVG
7386	55.28	-0.75	54.53	74	-19.47	peak
7386	43.26	-0.75	42.51	54	-11.49	AVG

Remark: Factor = Antenna Factor + Cable Loss – Pre-amplifier.



LOW CH3 (802.11n/H40 Mode)/2422

Horizontal:

Frequency (MHz)	Reading Result (dBμV)	Factor (dB)	Emission Level (dBμV/m)	Limits (dBμV/m)	Margin (dB)	Detector Type
4844	60.28	-3.63	56.65	74	-17.35	
4844	47.96	-3.63	44.33	54	-9.67	AVG
7266	57.16	-0.94	56.22	74	-17.78	peak
7266	44.35	-0.94	43.41	54	-10.59	AVG

Remark: Factor = Antenna Factor + Cable Loss – Pre-amplifier.

Vertical:

Frequency (MHz)	Reading Result (dBμV)	Factor (dB)	Emission Level (dBμV/m)	Limits (dBμV/m)	Margin (dB)	Detector Type
4844	58.64	-3.63	55.01	74	-18.99	
4844	45.16	-3.63	41.53	54	-12.47	AVG
7266	57.69	-0.94	56.75	74	-17.25	peak
7266	42.33	-0.94	41.39	54	-12.61	AVG

Remark: Factor = Antenna Factor + Cable Loss – Pre-amplifier.



MID CH6 (802.11n/H40 Mode)/2437

Horizontal:

Frequency	Reading Result	Factor	Emission Level	Limits	Margin	Detector Type
(MHz)	(dBμV)	(dB)	(dBμV/m)	(dBμV/m)	(dB)	
4874	60.38	-3.51	56.87	74	-17.13	peak
4874	45.12	-3.51	41.61	54	-12.39	AVG
7311	57.96	-0.82	57.14	74	-16.86	peak
7311	43.01	-0.82	42.19	54	-11.81	AVG

Remark: Factor = Antenna Factor + Cable Loss – Pre-amplifier.

Vertical:

Frequency	Reading Result	Factor	Emission Level	Limits	Margin	Detector Type
(MHz)	(dBμV)	(dB)	(dBμV/m)	(dBμV/m)	(dB)	
4874	58.67	-3.51	55.16	74	-18.84	peak
4874	44.19	-3.51	40.68	54	-13.32	AVG
7311	56.32	-0.82	55.5	74	-18.5	peak
7311	44.05	-0.82	43.23	54	-10.77	AVG

Remark: Factor = Antenna Factor + Cable Loss – Pre-amplifier.



HIGH CH9 (802.11n/H40 Mode)/2452

Horizontal:

Frequency	Reading Result	Factor	Emission Level	Limits	Margin	Detector Type
(MHz)	(dBμV)	(dB)	(dBμV/m)	(dBμV/m)	(dB)	
4904	58.72	-3.43	55.29	74	-18.71	peak
4904	43.62	-3.43	40.19	54	-13.81	AVG
7356	56.89	-0.75	56.14	74	-17.86	peak
7356	43.25	-0.75	42.5	54	-11.5	AVG

Remark: Factor = Antenna Factor + Cable Loss – Pre-amplifier.

Vertical:

Frequency	Reading Result	Factor	Emission Level	Limits	Margin	Detector Type
(MHz)	(dBμV)	(dB)	(dBμV/m)	(dBμV/m)	(dB)	
4904	58.71	-3.43	55.28	74	-18.72	peak
4904	45.29	-3.43	41.86	54	-12.14	AVG
7356	57.69	-0.75	56.94	74	-17.06	peak
7356	41.26	-0.75	40.51	54	-13.49	AVG

Remark: Factor = Antenna Factor + Cable Loss – Pre-amplifier.

Remark:

- (1) Measuring frequencies from 1 GHz to the 25 GHz.
- (2) "F" denotes fundamental frequency; "H" denotes spurious frequency. "E" denotes band edge frequency.
- (3) * denotes emission frequency which appearing within the Restricted Bands specified in provision of 15.205, then the general radiated emission limits in 15.209 apply.
- (4) The emissions are attenuated more than 20dB below the permissible limits are not recorded in the report.
- (5) The IF bandwidth of EMI Test Receiver between 30MHz to 1GHz was 120KHz, 1 MHz for measuring above 1 GHz, below 30MHz was 10KHz.
- (6) When the test results of Peak Detected below the limits of Average Detected, the Average Detected is not need completed. For example: Top Channel at Fundamental 73.16dBuV/m(PK Value) <93.98(AV Limit), at harmonic 53.20 dBuV/m(PK Value) <54 dBuV/m(AV Limit), the Average Detected not need to completed.
- (7) All modes of operation were investigated and worst-case emissions are reported.



Test Result of Radiated Spurious at Band edges

Operation Mode:
802.11b Mode TX CH Low (2412MHz)

Horizontal

Frequency (MHz)	Reading Result (dBμV)	Factor (dB)	Emission Level (dBμV/m)	Limits (dBμV/m)	Margin (dB)	Detector Type
2310.00	60.28	-5.81	54.47	74	-19.53	peak
2310.00	46.32	-5.81	40.51	54	-13.49	AVG
2390.00	61.22	-5.84	55.38	74	-18.62	peak
2390.00	47.28	-5.84	41.44	54	-12.56	AVG

Remark: Factor = Antenna Factor + Cable Loss – Pre-amplifier.

Vertical:

Frequency (MHz)	Reading Result (dBμV)	Factor (dB)	Emission Level (dBμV/m)	Limits (dBμV/m)	Margin (dB)	Detector Type
2310.00	61.35	-5.81	55.54	74	-18.46	peak
2310.00	47.25	-5.81	41.44	54	-12.56	AVG
2390.00	62.35	-5.84	56.51	74	-17.49	peak
2390.00	49.33	-5.84	43.49	54	-10.51	AVG

Remark: Factor = Antenna Factor + Cable Loss – Pre-amplifier.



Operation Mode: TX CH High (2462MHz)

Horizontal

Frequency	Reading Result	Factor	Emission Level	Limits	Margin	Detector Type
(MHz)	(dBµV)	(dB)	(dBµV/m)	(dBµV/m)	(dB)	
2483.50	60.12	-5.81	54.31	74	-19.69	peak
2483.50	47.58	-5.81	41.77	54	-12.23	AVG
2500.00	60.33	-6.06	54.27	74	-19.73	peak
2500.00	45.89	-6.06	39.83	54	-14.17	AVG

Remark: Factor = Antenna Factor + Cable Loss – Pre-amplifier.

Vertical:

Frequency	Reading Result	Factor	Emission Level	Limits	Margin	Detector Type
(MHz)	(dBµV)	(dB)	(dBµV/m)	(dBµV/m)	(dB)	
2483.50	61.38	-5.81	55.57	74	-18.43	peak
2483.50	47.58	-5.81	41.77	54	-12.23	AVG
2500.00	60.22	-6.06	54.16	74	-19.84	peak
2500.00	48.96	-6.06	42.9	54	-11.1	AVG

Remark: Factor = Antenna Factor + Cable Loss – Pre-amplifier.

Remark: All the other emissions not reported were too low to read and deemed to comply with FCC limit.



Operation Mode: 802.11g Mode TX CH Low (2412MHz)

Horizontal

Frequency	Reading Result	Factor	Emission Level	Limits	Margin	Detector Type
(MHz)	(dBμV)	(dB)	(dBμV/m)	(dBμV/m)	(dB)	
2310.00	60.37	-5.81	54.56	74	-19.44	peak
2310.00	46.19	-5.81	40.38	54	-13.62	AVG
2390.00	60.22	-5.84	54.38	74	-19.62	peak
2390.00	46.82	-5.84	40.98	54	-13.02	AVG

Remark: Factor = Antenna Factor + Cable Loss – Pre-amplifier.

Vertical:

Frequency	Reading Result	Factor	Emission Level	Limits	Margin	Detector Type
(MHz)	(dBμV)	(dB)	(dBμV/m)	(dBμV/m)	(dB)	
2310.00	61.37	-5.81	55.56	74	-18.44	peak
2310.00	45.92	-5.81	40.11	54	-13.89	AVG
2390.00	60.14	-5.84	54.3	74	-19.7	peak
2390.00	47.28	-5.84	41.44	54	-12.56	AVG

Remark: Factor = Antenna Factor + Cable Loss – Pre-amplifier.



Operation Mode: TX CH High (2462MHz)

Horizontal

Frequency	Reading Result	Factor	Emission Level	Limits	Margin	Detector Type
(MHz)	(dBμV)	(dB)	(dBμV/m)	(dBμV/m)	(dB)	
2483.50	61.35	-5.65	55.7	74	-18.3	peak
2483.50	45.78	-5.65	40.13	54	-13.87	AVG
2500.00	60.34	-5.65	54.69	74	-19.31	peak
2500.00	44.25	-5.65	38.6	54	-15.4	AVG

Remark: Factor = Antenna Factor + Cable Loss – Pre-amplifier.

Vertical:

Frequency	Reading Result	Factor	Emission Level	Limits	Margin	Detector Type
(MHz)	(dBμV)	(dB)	(dBμV/m)	(dBμV/m)	(dB)	
2483.50	60.38	-5.65	54.73	74	-19.27	peak
2483.50	47.58	-5.65	41.93	54	-12.07	AVG
2500.00	62.34	-5.65	56.69	74	-17.31	peak
2500.00	45.89	-5.65	40.24	54	-13.76	AVG

Remark: Factor = Antenna Factor + Cable Loss – Pre-amplifier.

Remark: All the other emissions not reported were too low to read and deemed to comply with FCC limit.



Operation Mode: 802.11n/H20 Mode TX CH Low (2412MHz)

Horizontal

Frequency (MHz)	Reading Result (dBμV)	Factor (dB)	Emission Level (dBμV/m)	Limits (dBμV/m)	Margin (dB)	Detector Type
2310.00	60.37	-5.81	54.56	74	-19.44	peak
2310.00	47.85	-5.81	42.04	54	-11.96	AVG
2390.00	62.35	-5.84	56.51	74	-17.49	peak
2390.00	48.27	-5.84	42.43	54	-11.57	AVG

Remark: Factor = Antenna Factor + Cable Loss – Pre-amplifier.

Vertical:

Frequency (MHz)	Reading Result (dBμV)	Factor (dB)	Emission Level (dBμV/m)	Limits (dBμV/m)	Margin (dB)	Detector Type
2310.00	60.35	-5.81	54.54	74	-19.46	peak
2310.00	46.19	-5.81	40.38	54	-13.62	AVG
2390.00	60.28	-5.84	54.44	74	-19.56	peak
2390.00	45.98	-5.84	40.14	54	-13.86	AVG

Remark: Factor = Antenna Factor + Cable Loss – Pre-amplifier.



Operation Mode: TX CH High (2462MHz)

Horizontal

Frequency	Reading Result	Factor	Emission Level	Limits	Margin	Detector Type
(MHz)	(dBµV)	(dB)	(dBµV/m)	(dBµV/m)	(dB)	
2483.50	60.37	-5.65	54.72	74	-19.28	peak
2483.50	47.28	-5.65	41.63	54	-12.37	AVG
2500.00	62.14	-5.65	56.49	74	-17.51	peak
2500.00	49.34	-5.65	43.69	54	-10.31	AVG

Remark: Factor = Antenna Factor + Cable Loss – Pre-amplifier.

Vertical:

Frequency	Reading Result	Factor	Emission Level	Limits	Margin	Detector Type
(MHz)	(dBµV)	(dB)	(dBµV/m)	(dBµV/m)	(dB)	
2483.50	61.07	-5.65	55.42	74	-18.58	peak
2483.50	45.89	-5.65	40.24	54	-13.76	AVG
2500.00	62.34	-5.65	56.69	74	-17.31	peak
2500.00	46.11	-5.65	40.46	54	-13.54	AVG

Remark: Factor = Antenna Factor + Cable Loss – Pre-amplifier.

Remark: All the other emissions not reported were too low to read and deemed to comply with FCC limit.



Operation Mode: 802.11n/H40 Mode TX CH Low (2422MHz)

Horizontal

Frequency	Reading Result	Factor	Emission Level	Limits	Margin	Detector Type
(MHz)	(dBµV)	(dB)	(dBµV/m)	(dBµV/m)	(dB)	
2310.00	57.32	-5.81	51.51	74	-22.49	peak
2310.00	/	-5.81	/	54	/	AVG
2390.00	58.00	-5.84	52.16	74	-21.84	peak
2390.00	/	-5.84	/	54	/	AVG

Remark: Factor = Antenna Factor + Cable Loss – Pre-amplifier.

Vertical:

Frequency	Reading Result	Factor	Emission Level	Limits	Margin	Detector Type
(MHz)	(dBµV)	(dB)	(dBµV/m)	(dBµV/m)	(dB)	
2310.00	57.62	-5.81	51.81	74	-22.19	peak
2310.00	/	-5.81	/	54	/	AVG
2390.00	56.33	-5.84	50.49	74	-23.51	peak
2390.00	/	-5.84	/	54	/	AVG

Remark: Factor = Antenna Factor + Cable Loss – Pre-amplifier.

The results shown in this test report refer only to the sample(s) tested unless otherwise stated and the sample(s) are retained for 30 days only. The document is issued by HUAJ, this document cannot be reproduced except in full with our prior written permission. The more details and the authenticity of the report will be confirmed at <http://www.cer-mark.com>.



Operation Mode: TX CH High (2452MHz)

Horizontal

Frequency (MHz)	Reading Result (dBμV)	Factor (dB)	Emission Level (dBμV/m)	Limits (dBμV/m)	Margin (dB)	Detector Type
2483.50	57.46	-5.65	51.81	74	-22.19	
2483.50	/	-5.65	/	54	/	AVG
2500.00	56.98	-5.65	51.33	74	-22.67	peak
2500.00	/	-5.65	/	54	/	AVG

Remark: Factor = Antenna Factor + Cable Loss – Pre-amplifier.

Vertical:

Frequency (MHz)	Reading Result (dBμV)	Factor (dB)	Emission Level (dBμV/m)	Limits (dBμV/m)	Margin (dB)	Detector Type
2483.50	56.37	-5.65	50.72	74	-23.28	
2483.50	/	-5.65	/	54	/	AVG
2500.00	57.14	-5.65	51.49	74	-22.51	peak
2500.00	/	-5.65	/	54	/	AVG

Remark: Factor = Antenna Factor + Cable Loss – Pre-amplifier.

Remark: All the other emissions not reported were too low to read and deemed to comply with FCC limit.

4.8. ANTENNA REQUIREMENT

Standard Applicable

For intentional device, according to FCC 47 CFR Section 15.203, an intentional radiator shall be designed to ensure that no antenna other than that furnished by the responsible party shall be used with the device. And according to FCC 47 CFR Section 15.247, if transmitting antennas of directional gain greater than 6dBi are used, the power shall be reduced by the amount in dB that the directional gain of the antenna exceeds 6dBi.

Refer to statement below for compliance.

The manufacturer may design the unit so that the user can replace a broken antenna, but the use of a standard antenna jack or electrical connector is prohibited. Further, this requirement does not apply to intentional radiators that must be professionally installed.

Antenna Connected Construction

The antenna used in this product is a Internal Antenna which permanently attached. It conforms to the standard requirements. The directional gains of antenna used for transmitting is 0dBi.

WIFI ANTENNA

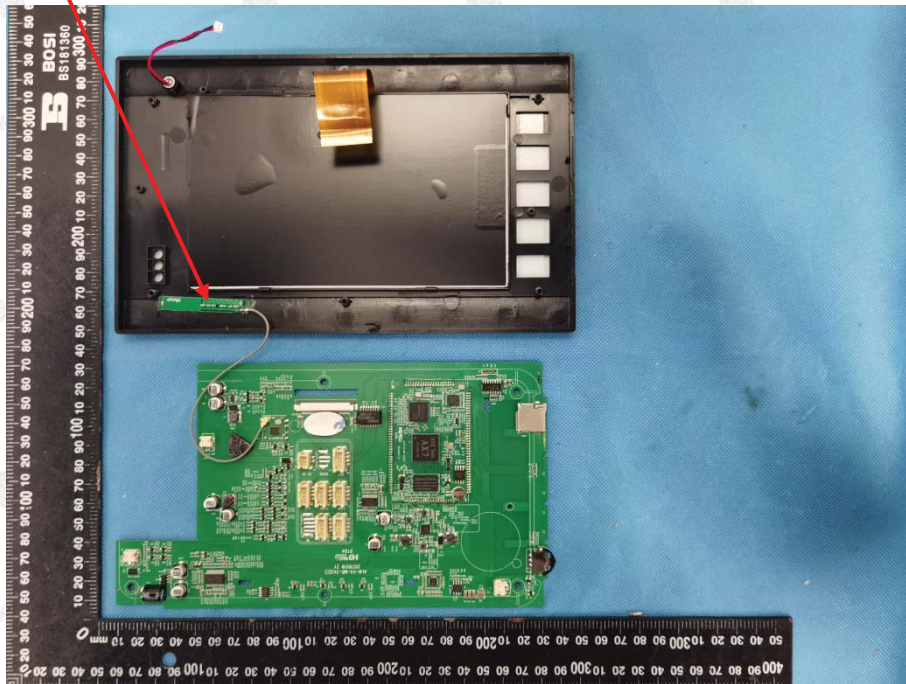



4.9. PHOTOGRAPH OF TEST

Spurious Emission

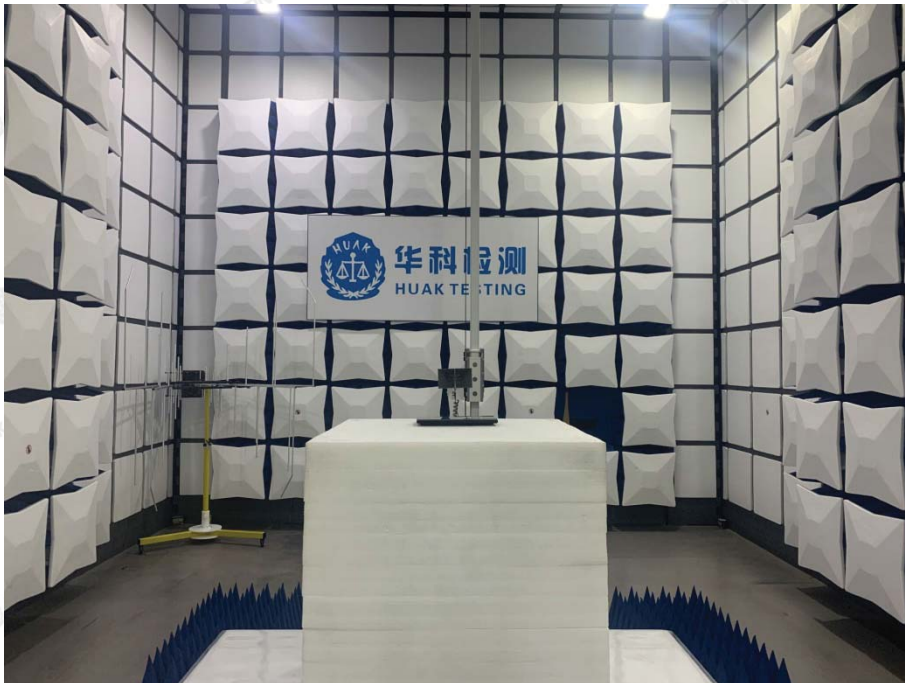
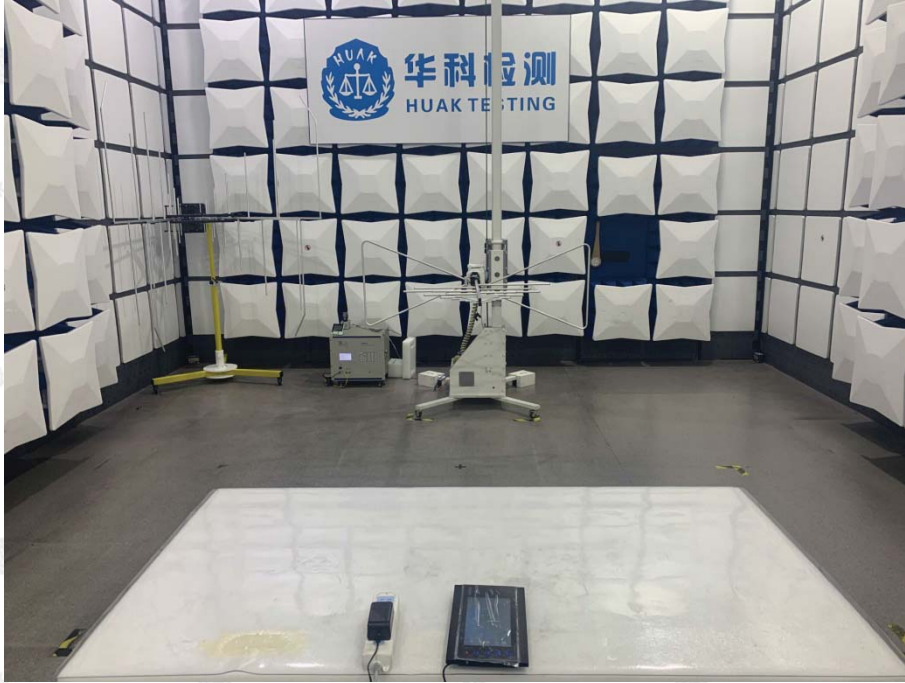

The results shown in this test report refer only to the sample(s) tested unless otherwise stated and the sample(s) are retained for 30 days only. The document is issued by HUAK, this document cannot be reproduced except in full with our prior written permission. The more details and the authenticity of the report will be confirmed at <http://www.cer-mark.com>.

HUAK Testing Lab TEL : +86-755 2302 9901 FAX : +86-755 2302 9901 E-mail : service@cer-mark.com

1-2/F., Building B2, Junfeng Zhongcheng Zhizao Innovation Park, Heping, Fuhai Street, Bao'an District, Shenzhen, Guangdong, China



Conducted Emission



The results shown in this test report refer only to the sample(s) tested unless otherwise stated and the sample(s) are retained for 30 days only. The document is issued by HUAK, this document cannot be reproduced except in full with our prior written permission. The more details and the authenticity of the report will be confirmed at <http://www.cer-mark.com>.

HUAK Testing Lab TEL : +86-755 2302 9901 FAX : +86-755 2302 9901 E-mail : service@cer-mark.com

1-2/F., Building B2, Junfeng Zhongcheng Zhizao Innovation Park, Heping, Fuhai Street, Bao'an District, Shenzhen, Guangdong, China



4.10. PHOTOS OF THE EUT

Reference to the report: ANNEX A of external photos and ANNEX B of internal photos

-----End of test report-----

