

AIR/LINKER

User's Manual

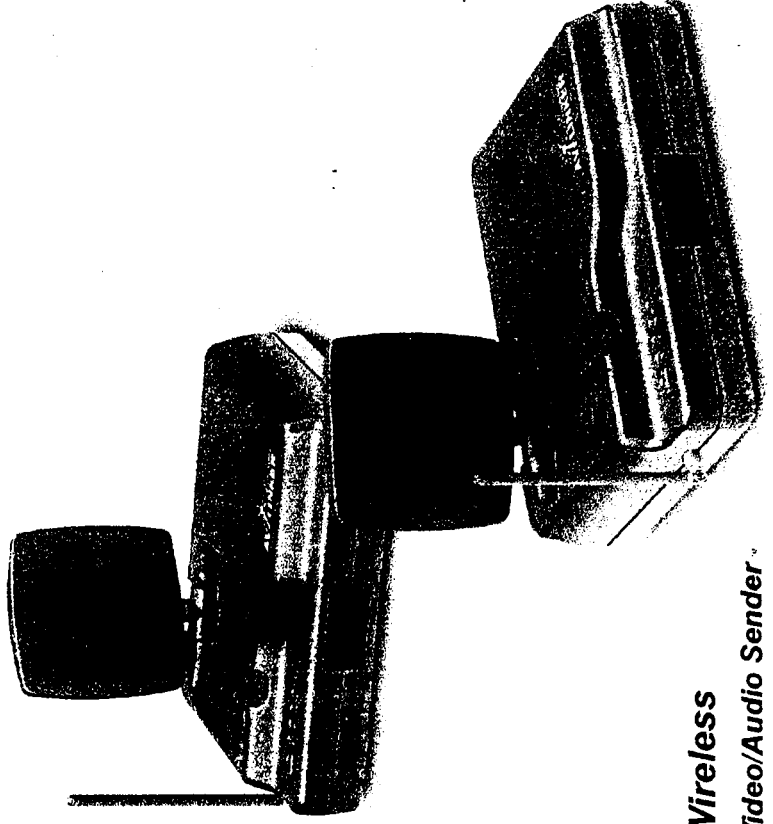

**Wireless
Video/Audio Sender**



No. 213, New-Pu Road, Hsinchu, Taiwan, R.O.C.

Tel: 886-3-539-6663

Fax: 886-3-539-6739

<http://www.kalink.com>

E-Mail: kalink@tpts5.seed.net.tw

**INSTRUCTIONS-MANUAL
FEDERAL COMMUNICATIONS COMMISSION
INTERFERENCE STATEMENT**

This equipment has been tested and found to comply with the limits for a Class B digital device, pursuant to Part 15 of the FCC Rules. These limits are designed to provide reasonable protection against harmful interference in a residential installation. This equipment generates, uses and can radiate radio frequency energy and, if not installed and used in accordance with the instructions, may cause harmful interference to radio communications. However, there is no guarantee that interference will not occur in a particular installation. If this equipment does cause harmful interference to radio or television reception, which can be determined by turning the equipment off and on, the user is encouraged to try to correct the interference by one or more of the following measures:

- Reorient or relocate the receiving antenna.
- Increase the separation between the equipment and receiver.
- Connect the equipment into an outlet on a circuit different from that to which the receiver is connected.
- Consult the dealer or an experienced radio/TV technician for help.

CAUTION:

To assure continued FCC compliance:

- (1) Any changes or modifications not expressly approved by the grantee of this device could void the user's authority to operate the equipment.

FCC Label Compliance Statement:

This device complies with Part 15 of the FCC Rules. Operation is subject to the following two conditions: (1) this device may not cause harmful interference, and (2) this device must accept any interference received, including interference that may cause undesired operation.

Contents

<i>Important Safety Instructions</i>	2
<i>Introduction to AV-Linker</i>	3
<i>List of Packaged Contents</i>	4
<i>Controls and Features</i>	6
<i>Setting Up Units</i>	7
<i>Connecting the Sender to the AV Sources</i>	8
<i>Connecting the Receiver to the AV Displays</i>	11
<i>Orienting Antenna of AV-Linker for Optimizing Performance</i>	13
<i>Orienting the Remote Control Antenna (for model AVL-s1 only)</i>	14
<i>Using the Remote Control Extender Feature</i>	15
<i>Troubleshooting</i>	16
<i>Specifications</i>	17
<i>Ordering Information</i>	18

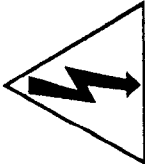
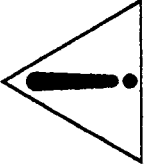
	
CAUTION RISK OF ELECTRIC SHOCK DO NOT OPEN	
CAUTION: DO NOT REMOVE THE COVER FOR REDUCING THE RISK OF ELECTRIC SHOCK. NO USER-SERVICEABLE PARTS INSIDE REFER SERVICING TO QUALIFIED SERVICE PERSONNEL	

WARNING

Do not expose this product to rain or moisture environment for reducing the risk of fire or electric shock as well as preventing the damage that it may brought to this product.

IMPORTANT SAFETY INSTRUCTIONS

1. All the safety and operating instructions should be read before the product is operated.
2. The installation guide should be retained for future reference.
3. All warnings on the product and in the operating instructions should be adhered to.
4. All operating and use instructions should be followed.
5. Turn OFF power to this product from the wall outlet before cleaning. Use a damp cloth for cleaning. Do not use liquid cleaners or aerosol cleaners.
6. For preventing any factors that may cause serious damage to the product or human, do not place this product on an unstable cart, stand, tripod, bracket, or table in case of accidental falling. Use only with a cart, stand, tripod, bracket, or table recommended by the manufacturer.
7. A product and cart combination should be moved with care.
8. To ensure reliable operation of the product and to protect it from overheating, the openings must not be blocked or covered. The openings should never be blocked by placing the product on a bed, sofa, rug, or other similar surface. This product should not be placed in a built-in installation such as a bookcase or rack unless proper ventilation is provided or the manufacturer's instructions have been adhered to.
9. This product should be operated only from the type of power source indicated on the marking label. If you are not sure of the type of power supply to your home, consult your product dealer or local power station.
10. For adding protection to this product during a lightning storm, or when it is left unattended and unused for long periods of time, unplug it from the wall outlet and disconnect the antenna or cable system. This will prevent damage to the product due to lightning and power-line surges.
11. Do not overload wall outlets, extension cords, or integral convenience receptacles as they can result in a risk of fire or electric shock.
12. Never push objects or spill liquid of any kind into this product.

Introduction to AV-Linker

AV-Linker applies the advanced wireless technology to offer the users the ability to link all kinds of Audio and Video sources to TV, Monitors, and Personal Computers without wires and cables. It is developed using the 2.4GHz radio frequency technology. AV-Linker is easy to install completely within minutes. This plug-and-play feature helps you expand your freedom in your home entertainment and enhance your home security.

Applications

- ◆ Works as the wireless remote unit for the expensive A/V equipment such as IRD & DVD.
- ◆ Applies as a wireless security system.
- ◆ Uses as a baby siter to watch your baby anytime and anywhere in your home.
- ◆ Monitors and records meeting from another room.
- ◆ Uses multi-receivers for broadcasting to numerous TV sets in other rooms.
- ◆ Applies the data transmission (optional function).

Features

- ◆ 4 selectable channels prevent the interference and to operate 4 pairs of AV-Linker simultaneously.
- ◆ Easy installation, just plug in and play within minutes.
- ◆ Works with all kinds of Audio and Video equipment in your home.
- ◆ Penetrates walls, floors, and ceilings without damaging your home.
- ◆ Crystal quality of Audio and Video signals.

List of Packaged Contents

The following devices should be included in the box. Please check that you have them all before installation.

1. One set of Sender

The Sender emits Audio and Video signals over 2.4GHz radio frequency carrier and receives UHF remote control signal from the Receiver.

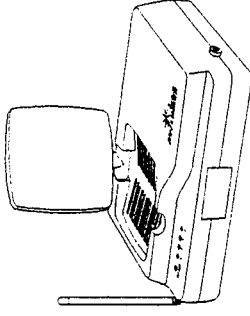

2. One set of Receiver

The Receiver receives 2.4GHz wireless Audio and Video signals from the Sender and sends UHF remote control signal to the Sender.

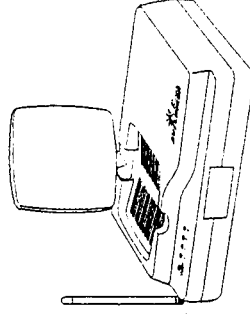

3. Two power adapters

These power adapters supply the +12Vdc power to the Sender and the Receiver.

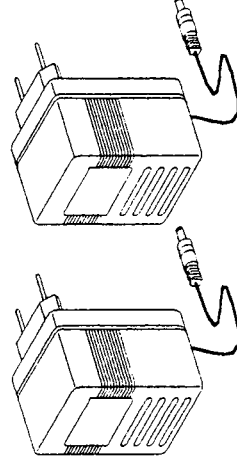

4. Two Audio/Video (A/V) cables

These two pairs of cables are used to connect the Sender and the Receiver to you A/V devices.

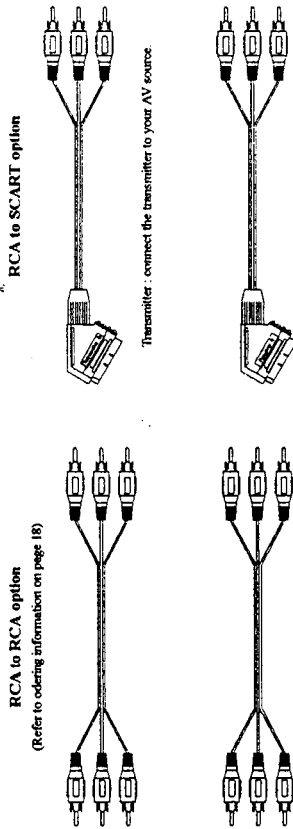

5. Infrared extender (for Model AVL-S1 Only)

Emits infrared remote control signal to control you A/V devices.

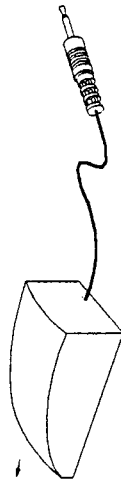

6. Fasten strips (for Model AVL-S1 Only)

These strips are used to mount IR extender and secure units.



Controls and Features

The Sender and the Receiver look alike, and you can distinguish through the logo on the units. The other differences are indicated below.

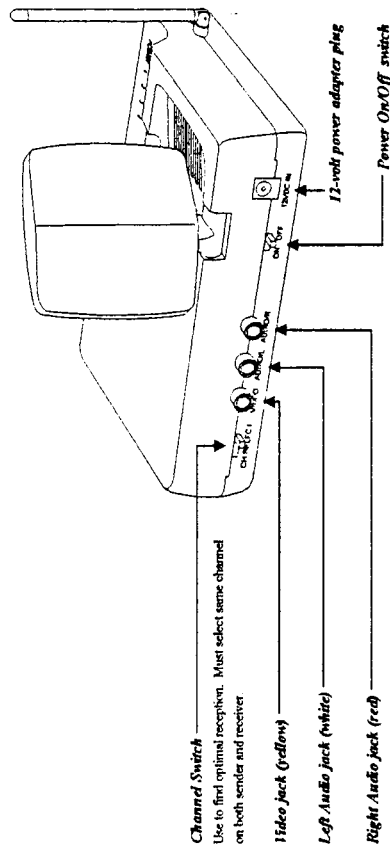
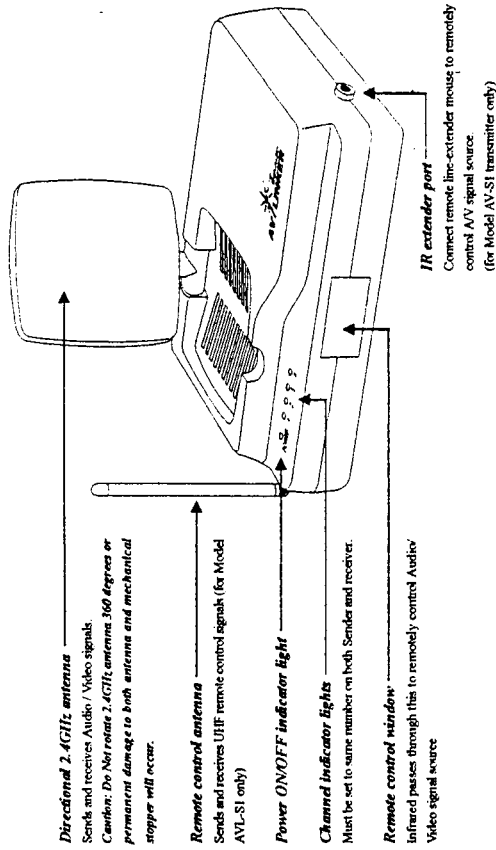

Setting Up Units

Setting up AV-Linker is extremely easy. It takes only few minutes to connect the senders to your A/V sources you want to view or hear at another location, and then connect the receiver to the TV set, monitors, and speakers located at your site.

Turning on the power switches of the sender and the receiver, you are ready to enjoy the A/V signals via the wireless technology.

The AV-Linker is suitable for all kinds of the A/V source and display with standard RCA output connectors. For the A/V equipment with different output connectors, such as SCART, the optional adapters are available upon request. Hereinafter, we define the A/V sources and the A/V displays as follows:

The A/V sources are:

- VCR
- TV set
- Digital/Analogue Satellite Receivers
- Cable TV Box
- Digital Video Disc Player
- Laser Disc Player
- CD Player
- Camcorder
- Security Camera
- Computer
- Wireless Cable Box
- Cassette Deck
- Stereo Receiver

The A/V displays are:

- TV set
- Monitor
- Speaker

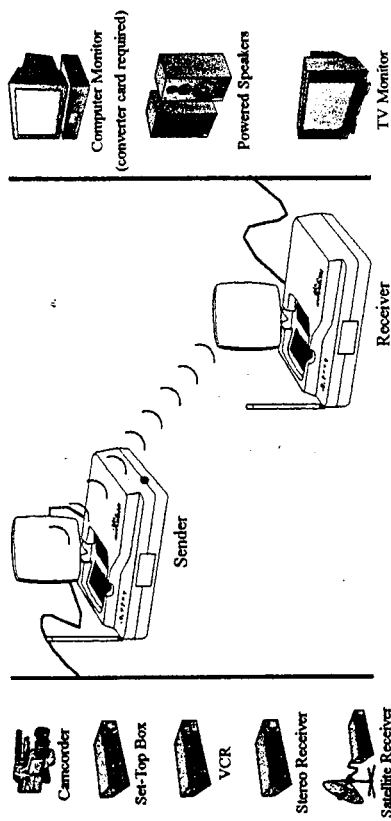

Connection the Sender to the A/V Sources

Before connecting the AV-Linker sender, make sure the ON/OFF switch is in the OFF position. Connect one set of A/V cables to the A/V jacks of sender and to the A/V jacks on the A/V output of the A/V sources. There are three kinds of colors for the connectors of A/V cables. Make sure the yellow, white, and red plugs match the yellow, white and red jacks on both the sender and the A/V sources.

Before plug in the power adapter into the AV-Linker sender, make sure the power rating is matching the power standard of your country. For example, the Italy is using 220V and you shall have two power adapters with A/C power rating 230V/AC. After plug in the power adapter into the AV-Linker sender and wall outlet as shown below, turn the ON/OFF switch to ON position and the Power On/Off indicator light should be lit.

To optimize the performance of AV-Linker sender, you may need to orient the antenna of the AV-Linker. Please refer to the section of this manual titled "Orienting Unit/Antenna for Optimizing Performance."

A. How To Send Audio/Video from Your Satellite Receiver or Laser Disc Player

You can send audio/video either directly from your satellite receiver or laser disc player, or by connection them to your VCR. To send directly from your satellite receiver or laser disc player, follow the instructions below.

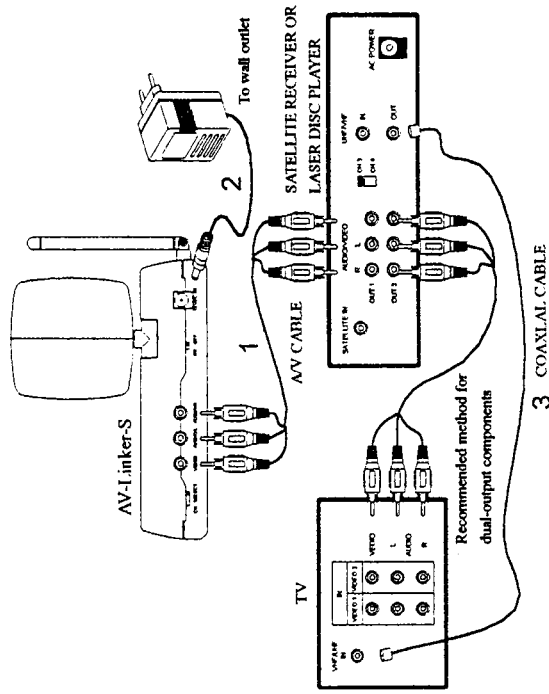

B. How To Send Audio/Video from Your VCR or DVD

1. Connect the coaxial IN, CATV IN or VHF/UHF IN from/on your VCR to TV antenna, coaxial OUT of the Set-top Box or CATV coaxial outlet.
 2. Use AVV cable to connect AVV OUT from your VCR to AVV IN on the sender. Be sure to match audio(R&L) and video jacks on both VCR and sender correctly.
 3. Plug the DC adapter into a wall AC power line outlet.
- Note. You may use coaxial OUT to correct coaxial OUT of your VCR to VHF/UHF IN or CATV IN on a nearby TV set. If there are two line out on your VCR, you can connect the other line out to your TV Set.

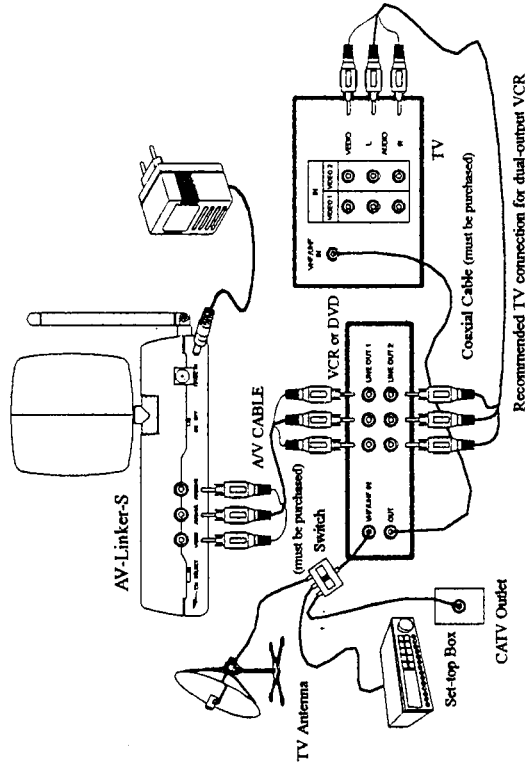

Recommended TV connection for dual-output VCR

C. How to Connect the Sender to Your Camcorder

1. Use AVV cable to connect AVV out on your camcorder to AVV IN on the sender.
2. Plug the DC adapter into a wall AC power line outlet.

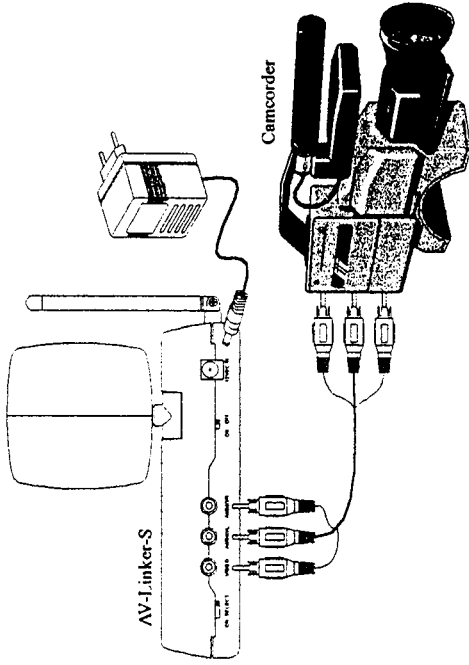

D. How To Send Audio from Your CD Player or Cassette Deck

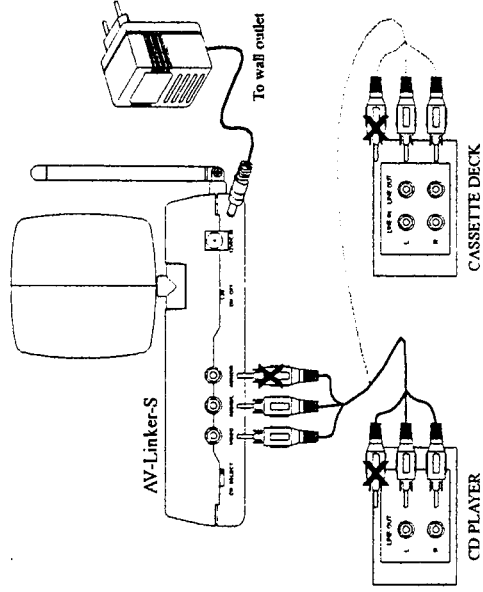

Connecting the Receiver to the AV displays

Before connecting the AV-Linker receiver, make sure the ON/OFF switch is in the OFF position. Connect one set of AV cables to the AV jacks of receiver and to the AV jacks on the AV input of the AV displays. There are three kinds of colors for the connectors of AV cables. Make sure the yellow, white, and red plugs match the yellow, white, and red jacks on both the sender and the AV sources.

Before plug in the power adapter into the AV-Linker receiver, make sure the power rating is matching the power standard of your country. For example, the Italy is using 220V and you shall have two power adapters with A/C power rating 230V/AC. After plug in the power adapter into the AV-Linker sender and wall outlet as shown below, turn the ON/OFF switch to ON position and the Power On/Off indicator light should be lit.

To optimize the performance of AV-Linker receiver, you may need to orient the antenna of the AV-Linker receiver. Please refer to the section of this manual titled "Orienting Unit/Antenna for Optimizing Performance."

A. How To Connect the Receiver to Your TV

1. Use AV cable to connect AV OUT from/on the receiver to AV IN from/on your TV. Be sure to match audio(R&L) and video jacks on both receiver and TV correctly.
2. Plug the DC adapter into a wall power line outlet.

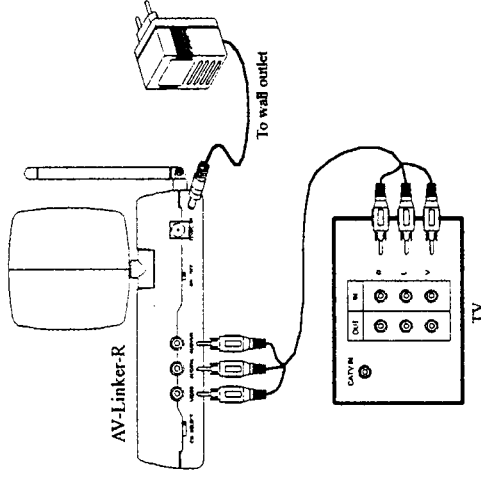

B. How to Receive Audio on Remote Speaker.

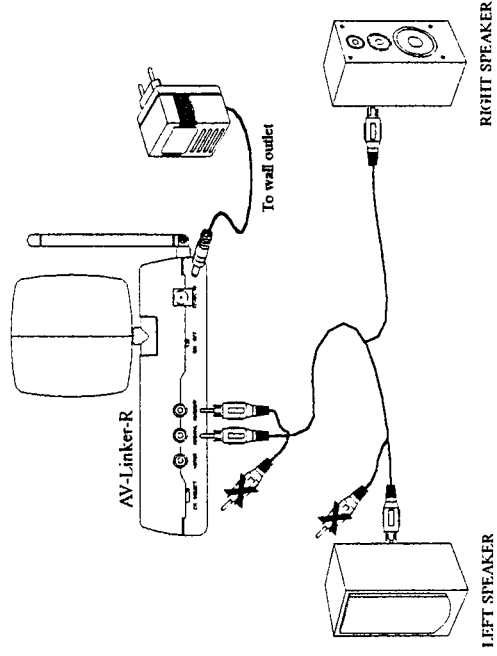

Orienting Antenna of AV-Linker for Optimizing Performance

There are two kinds of antenna in the AV-Linker. One is the flat antenna for sending and receiving AV signals. The other one is remote control antenna for sending and receiving the remote control signal.

For optimizing the performance, the flat antenna has to be adjusted and oriented as described below. The number of obstacles between the sender and receivers will affect the performance. Minimizing the number of obstacles as many as possible. In addition, try to place the AV-Linker as high as possible to prevent interference from walking people between the sender and the receiver.

Orienting the flat antenna

The AV-Linker broadcasting their AV signals through the flat antenna, which is directional antenna. Therefore, the flat antenna must be oriented in certain configurations for the best results. The front side of antenna is the flat side of the antenna. This side is using for aligning the best orientating of broadcasting signals from AV-Linker. The flat antenna is designed to pivot and have limited rotations in either clockwise or counterclockwise directions.

Warning : Follow the instruction shown below for rotating the flat antenna. Gently rotating the flat antenna is required. While rotating, you will feel there is a stop around $\pm 75^\circ$. Do not force to pass the stop. Rotating the flat antenna beyond the specified range will result in permanent damage to the flat antenna.

In most cases, the flat side of the flat antenna on both the sender and receiver should be facing each other. Two examples are shown below (refer to Fig. 1 & 2.) Since all homes are different, for optimizing performance, slight pivots or rotations of the flat antenna and the AV-Linker may be necessary. If the distance between the sender and the receiver is less than 15 feet apart, keep the flat antenna in their casings.

Orienting the Remote Control Antenna (for model AVL-s1 only)

For most applications, both of the remote control antennas should also be oriented vertically with respect to the main housing (refer to Fig. 1 & 2).

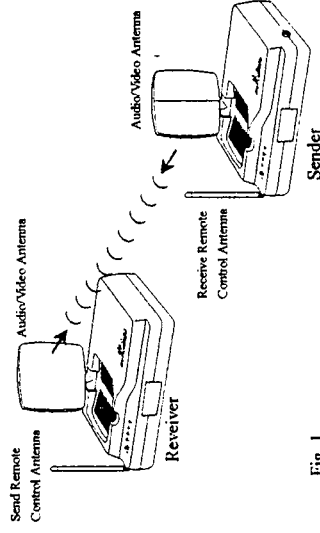

Fig. 1

If your remote control function is not working satisfactorily, first rotate the send remote control antenna (located on AV-Linker Receiver) to different positions (refer to Fig. 3).

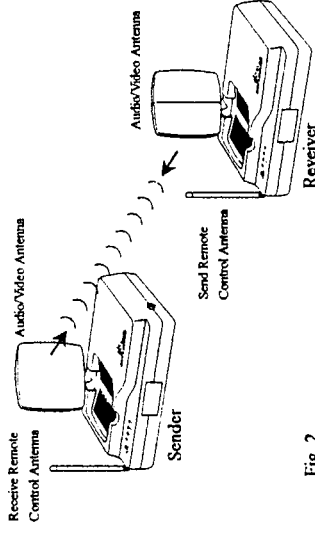

Fig. 2

If you notice improved performance, keep this orientation. If not, the receive remote control antenna (located on AV-Linker Receiver) then can be adjusted to optimize the performance.

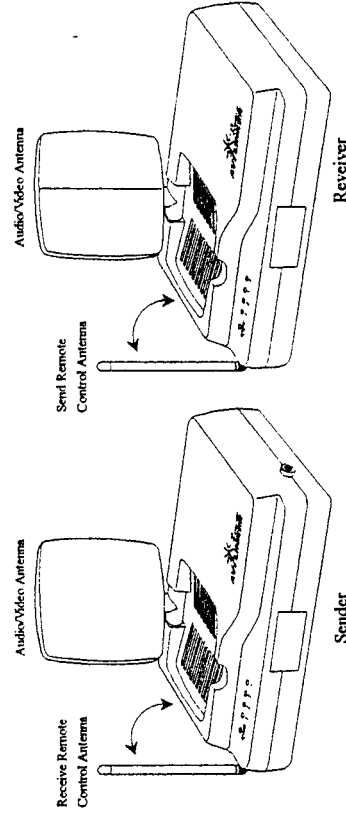
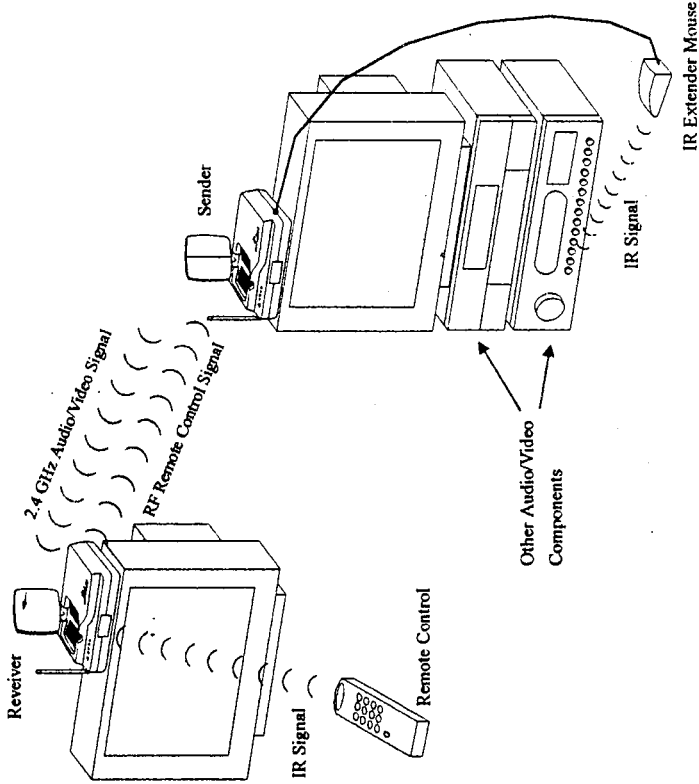

Fig. 3

Using the Remote Control Extender Feature (for Model AVL-S1 only)

1. Plugging the IR extender mouse connector to its special jack at the side of the AV-Linker senders.
2. Locate the IR sensor on the AV source equipment you wish to control. You can find the location of the IR sensor either by user's manual of the AV source equipment.
3. Pointing the IR extender mouse housing to the general direction of the IR sensors of the AV source equipment you wish to control. Cut a piece of provided fastener strip to secure the IR extender mouse to the appropriated location.
4. Position the AV-Linker receiver to allow your remote control signal can strike the IR window on the bottom front of the receiver. To perform the remote control feature, point the remote control to the front of the AV-Linker receiver.



Troubleshooting

Please read this user's manual carefully before using the AV-Linker. If you still have difficulties to use the AV-Linker, consult the following syndrome, which will guide you to solve most common problems.

A. No picture or sound

1. Check the power on/off switches on the back side of the sender and receiver.
2. Check the audio and video sources (TV, VCR, LD player, Satellite Receiver, etc.)
3. Make sure all cables are connected correctly.
4. Make sure the channel selection matches the sender and receiver.

B. Noisy picture or audio

1. Adjust the receiver antenna.
2. Adjust the sender antenna direction.
3. If using the microwave oven close by, please turn the microwave oven off.
4. Change different channel to avoid interference from other devices.

C. Remote Control Extender does not work

1. Check the path between the sender and the audio/video source and clear unnecessary obstructions.
2. Make sure the IR extender mouse is pointing toward the sensor on the source component you want to control.
3. Adjust remote control antenna (refer to page 14 for "Orienting The Remote Control Antenna")

Care and Maintenance

Clean the plastic casings with a soft cloth lightly. The moistened and wet cloth may damage the AV-Linker. Abrasive powder or solvent is not allowed to apply to the AV-Linker.

Specification

Sender:

- 1. Frequency : 2.4GHz-2.4835GHz
- 2. Channel : 4 selectable channels
- 3. Modulation type : FM
- Input level : Video -1 Vp-p
Audio -1 Vp-p
- Impedance : Video-75ohms
Audio-600ohms
- 4. Input port : AV jack -RCA to RCA line jacks
-RCA to SCART line jacks (optional)
- 5. Antenna : Directional flat antenna
- 6. Power supply : DC 12V power adapter

Receiver:

- 1. Frequency : 2.4GHz-2.4835GHz
- 2. Channel : 4 selectable channels
- 3. Output port : AV Jack -RCA to RCA line jacks
-RCA to SCART line jacks (optional)
- 4. Antenna : Directional flat antenna
- 5. Power supply : DC 12V power adapter

Ordering Information

Model No.

AVL-SX

- 0: Without Remote Extender
1: With Remote Extender