



Willow Run Test Labs, LLC
 8501 Beck Road, Building 2227
 Belleville, Michigan 48111 USA
 Tel: (734) 252-9785
 Fax: (734) 926-9785
 e-mail: info@wrtest.com

Testing of
Electromagnetic Emissions

per

USA: CFR Title 47, Part 15.231
 Canada: IC RSS-210/GENe

are herein reported for

Strattec Security Corporation
MP FlipKey

Test Report No.: 20160225-RPTWAC010017Ar0
 Copyright © 2016

Applicant/Provider:
 Strattec Security Corporation
 3333 West Good Hope Road, Milwaukee Wisconsin United States
 Phone: 414 247-3333, Fax: 414 247-3329
 Contact Person: Brian Reetz; breetz@strattec.com

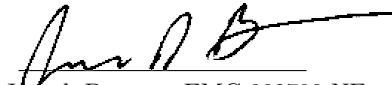
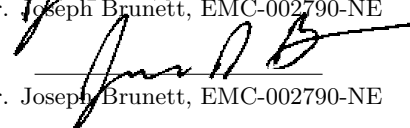
Measured by:		Report Approved by:	
	Dr. Joseph Brunett, EMC-002790-NE		Dr. Joseph Brunett, EMC-002790-NE
Report by:		Report Date of Issue:	February 25, 2016
	Dr. Joseph Brunett, EMC-002790-NE		

Results of testing completed on (or before) February 24, 2016 are as follows.

Emissions: The transmitter intentional emissions **COMPLY** with the regulatory limit(s) by no less than 2.8 dB. Transmit chain spurious or harmonic emissions **COMPLY** by no less than 1.1 dB. Unintentional spurious emissions from digital circuitry **COMPLY** with radiated emission limit(s) by at least 20 dB.

Contents

1	Test Specifications, General Procedures, and Location	4
1.1	Test Specification and General Procedures	4
1.2	Test Location and Equipment Used	5
2	Configuration and Identification of the Equipment Under Test	6
2.1	Description and Declarations	6
2.1.1	EUT Configuration	6
2.1.2	Modes of Operation	6
2.1.3	Variants	6
2.1.4	Test Samples	7
2.1.5	Functional Exerciser	7
2.1.6	Modifications Made	7
2.1.7	Production Intent	7
2.1.8	Declared Exemptions and Additional Product Notes	7
3	Emissions	8
3.1	General Test Procedures	8
3.1.1	Radiated Test Setup and Procedures	8
3.1.2	Conducted Emissions Test Setup and Procedures	10
3.1.3	Power Supply Variation	10
3.1.4	Thermal Variation	10
3.2	Intentional Emissions	11
3.2.1	Fundamental Emission Pulsed Operation	11
3.2.2	Fundamental Emission Bandwidth	13
3.2.3	Fundamental Emission Field Strength	14
3.3	Unintentional Emissions	15
3.3.1	Transmit Chain Spurious Emissions	15
3.3.2	Radiated Digital Spurious	16

List of Tables

1	Willow Run Test Labs, LLC Equipment List	5
2	EUT Declarations.	6
3	Fundamental Emission Pulsed Operation.	11
4	Fundamental Emission Bandwidth.	13
5	Fundamental Emission Field Strength.	14
6	Transmit Chain Spurious Emissions.	15

List of Figures

1	Photos of EUT.	6
2	EUT Test Configuration Diagram.	7
3	Radiated Emissions Diagram of the EUT.	8
4	Radiated Emissions Test Setup Photograph(s).	9
5	Fundamental Emission Pulsed Operation.	12
6	Fundamental Emission Bandwidth.	13

1 Test Specifications, General Procedures, and Location

1.1 Test Specification and General Procedures

The ultimate goal of Strattec Security Corporation is to demonstrate that the Equipment Under Test (EUT) complies with the Rules and/or Directives below. Detailed in this report are the results of testing the Strattec Security Corporation MP FlipKey for compliance to:

Country/Region	Rules or Directive	Referenced Section(s)
United States	Code of Federal Regulations	CFR Title 47, Part 15.231
Canada	Industry Canada	IC RSS-210/GENe

Strattec Security Corporation has determined that the equipment under test is subject to the rules and directives above at the date of this testing. In conjunction with these rules and directives, the following specifications and procedures are followed herein to demonstrate compliance (in whole or in part) with these regulations.

ANSI C63.4:2014	"Methods of Measurement of Radio-Noise Emissions from Low-Voltage Electrical and Electronic Equipment in the Range of 9 kHz to 40 GHz"
ANSI C63.10:2013 (USA)	"American National Standard of Procedures for Compliance Testing of Unlicensed Wireless Devices"
Industry Canada	"The Measurement of Occupied Bandwidth"
ICES-003; Issue 5 (2012)	"Information Technology Equipment (ITE) Limits and methods of measurement"

1.2 Test Location and Equipment Used

Test Location The EUT was fully tested by **Willow Run Test Labs, LLC**, 8501 Beck Road, Building 2227, Belleville, Michigan 48111 USA. The Test Facility description and attenuation characteristics are on file with the FCC Laboratory, Columbia, Maryland (FCC Reg. No: 688478) and with Industry Canada, Ottawa, ON (File Ref. No: IC 8719A-1).

Test Equipment Pertinent test equipment used for measurements at this facility is listed in Table 1. The quality system employed at Willow Run Test Labs, LLC has been established to ensure all equipment has a clearly identifiable classification, calibration expiry date, and that all calibrations are traceable to the SI through NIST, other recognized national laboratories, accepted fundamental or natural physical constants, ratio type of calibration, or by comparison to consensus standards.

Table 1: Willow Run Test Labs, LLC Equipment List

Description	Manufacturer/Model	SN	Quality Num.	Last Cal By / Date Due
Spectrum Analyzer	Rhode-Schwarz / FSV30	101660	RSFSV30001	RS / Apr-2016
Dipole Set (20-1000 MHz)	EMCO / 3121C	9504-1121	DIPEMC001	Liberty Labs / Sep-2016
Quad Ridge Horn	ETS Lind. / 3164-04	00066988	HRNQR316401	Lib. Labs / Apr-2016

2 Configuration and Identification of the Equipment Under Test

2.1 Description and Declarations

The equipment under test is an automotive Remote Keyless Entry transmitter. The EUT is approximately 4 x 2.5 x 1 cm (approx.) in dimension, and is depicted in Figure 1. It is powered by a 3 VDC Lithium cell battery. In use, this device is hand held. Table 2 outlines provider declared EUT specifications.



Figure 1: Photos of EUT.

Table 2: EUT Declarations.

General Declarations			
Equipment Type:	RKE Transmitter	Country of Origin:	Not Declared
Nominal Supply:	3 VDC	Oper. Temp Range:	Not Declared
Frequency Range:	433.92 MHz	Antenna Dimension:	Not Declared
Antenna Type:	integral	Antenna Gain:	Not Declared
Number of Channels:	1	Channel Spacing:	Not Applicable
Alignment Range:	Not Declared	Type of Modulation:	FSK
United States			
FCC ID Number:	OHT1270254	Classification:	DSC
Canada			
IC Number:	5461A-1270254	Classification:	Remote Control Device, Vehicular Device

2.1.1 EUT Configuration

The EUT is configured for testing as depicted in Figure 2.

2.1.2 Modes of Operation

There is only a single mode of operation. When manually activated by button press the EUT transmits a finite set of ASK frames in Remote Keyless Entry (RKE) mode.

2.1.3 Variants

There are four variants of the EUT that differ only in the number of surface mount switches deployed on the PCB and the silkscreen labels on the housing buttons. Part Number 5XK74TRMAA has only two SMT switches

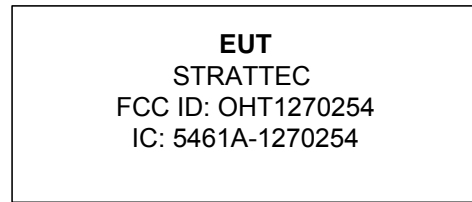

Figure 2: EUT Test Configuration Diagram.

populated, part number 5XK75TRMAA and 5XK76TRMAA have three SMT switches populated, and part number 5XK77TRMAA employs the full 4 SMT push buttons.

2.1.4 Test Samples

Seven samples in total were provided. Three samples (one for each button population) programmed for CW transmission, one normal operating sample capable of manually activated transmissions, and three additional samples to be dismantled for testing and photographs.

2.1.5 Functional Exerciser

Normal operating EUT functionality was verified by observation of transmitted signal.

2.1.6 Modifications Made

There were no modifications made to the EUT by this laboratory.

2.1.7 Production Intent

The EUT appears to be a production ready sample.

2.1.8 Declared Exemptions and Additional Product Notes

None.

3 Emissions

3.1 General Test Procedures

3.1.1 Radiated Test Setup and Procedures

Radiated electromagnetic emissions from the EUT are first pre-scanned in our shielded anechoic chamber. Spectrum and modulation characteristics of all emissions are recorded. Instrumentation, including spectrum analyzers and other test equipment as detailed in Section 1.2 are employed. After indoor pre-scans, emission measurements are made on our outdoor 3-meter Open Area Test Site (OATS). If the EUT connects to auxiliary equipment and is table or floor standing, the configurations prescribed in relevant test standards are followed. Alternatively, a layout closest to normal use (as declared by the provider) is employed if the resulting emissions appear to be worst-case in such a configuration. See Figure 3. All intentionally radiating elements that are not fixed-mounted in use are placed on the test table lying flat, on their side, and on their end (3-axes) and the resulting worst case emissions are recorded. If the EUT is fixed-mounted in use, measurements are made with the device oriented in the manner consistent with installation and then emissions are recorded.

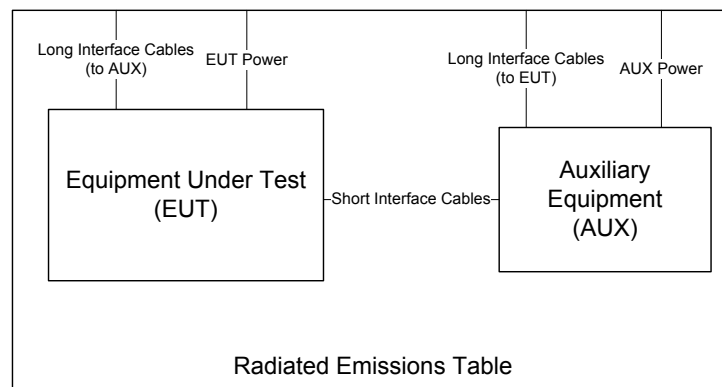

Figure 3: Radiated Emissions Diagram of the EUT.

If the EUT exhibits spurious emissions due to internal receiver circuitry, such emissions are measured with an appropriate carrier signal applied. For devices with intentional emissions below 30 MHz, a shielded loop antenna is used. It is placed at a 1 meter receive height. Emissions between 30 MHz and 1 GHz are measured using tuned dipoles and/or calibrated broadband antennas. For both horizontal and vertical polarizations, the test antenna is raised and lowered from 1 to 4 m in height until a maximum emission level is detected. The EUT is then rotated through 360° in azimuth until the highest emission is detected. The test antenna is then raised and lowered one last time from 1 to 4 m and the worst case value is recorded. Emissions above 1 GHz are characterized using standard gain horn antennas or calibrated broadband ridge-horn antennas on our OATS with a 4×5 m rectangle of AN-79 and/or H-4 absorber placed over the ground screen covering the OATS ground screen. Care is taken to ensure that test receiver resolution and video bandwidths meet the regulatory requirements, and that the emission bandwidth of the EUT is not reduced. Photographs of the test setup employed are depicted in Figure 4.

Where regulations allow for direct measurement of field strength, power values (dBm) measured on the test receiver / analyzer are converted to $\text{dB}\mu\text{V}/\text{m}$ at the regulatory distance, using

$$E_{dist} = 107 + P_R + K_A - K_G + K_E - C_F$$

where P_R is the power recorded on spectrum analyzer, in dBm, K_A is the test antenna factor in dB/m, K_G is the combined pre-amplifier gain and cable loss in dB, K_E is duty correction factor (when applicable) in dB, and C_F is a distance conversion (employed only if limits are specified at alternate distance) in dB. This field strength value is then compared with the regulatory limit. If effective isotropic radiated power (EIRP) is computed, it is computed as

$$EIRP(\text{dBm}) = E_{3m}(\text{dB}\mu\text{V}/\text{m}) - 95.2.$$

When presenting data at each frequency, the highest measured emission under all possible EUT orientations (3-axes) is reported.



Figure 4: Radiated Emissions Test Setup Photograph(s).

3.1.2 Conducted Emissions Test Setup and Procedures

Battery Power Conducted Spurious The EUT is not subject to measurement of power line conducted emissions as it is powered solely by its internal battery.

3.1.3 Power Supply Variation

Tests at extreme supply voltages are made if required by the the procedures specified in the test standard, and results of this testing are detailed in this report.

In the case the EUT is designed for operation from a battery power source, the extreme test voltages are evaluated over the range specified in the test standard; no less than $\pm 10\%$ of the nominal battery voltage declared by the manufacturer. For all battery operated equipment, worst case intentional and spurious emissions are re-checked employing a new (fully charged) battery.

3.1.4 Thermal Variation

Tests at extreme temperatures are made if required by the procedures specified in the test standard, and results of this testing are detailed in this report. The provider has declared that the EUT is designed for operation over the temperature range Not Declared. Before any temperature measurements are made, the equipment is allowed to reach a thermal balance in the test chamber, temperature and humidity are recorded, and thermal balance is verified via a thermocouple-based probe.

3.2 Intentional Emissions

3.2.1 Fundamental Emission Pulsed Operation

Test Setup & Procedure The test equipment and facilities were setup in accordance with the standards and procedures listed in Section 1.1. Environmental conditions were set at the appropriate temperature and thermal balance was checked with a thermocouple based probe. Duty cycle is reported for all relevant modes of operation. The test equipment employed includes RSFSV30001, DIPEMC001.

Measurement Results The details and results of testing the EUT are summarized in Table 3. Plots showing the measurements made to obtain these values are provided in Figure 5.

Table 3: Fundamental Emission Pulsed Operation.

Detector	Span	IF Bandwidth	Video Bandwidth	Test Date:	2-Feb-16
Pk	0	1 MHz	3 MHz	Test Engineer:	Joseph Brunett
				EUT:	Strattec MP Flipkey
				EUT Mode:	Modulated
				Meas. Distance:	10 cm

FCC/IC									
#	EUT Test Mode*	Overall Transmission			Internal Frame Characteristics			Computed Duty Cycle	
		Min. Repetition Rate (sec)	Max. No. of Frames	Total Transmission Length (sec)	Max. Frame Length (ms)	Min. Frame Period (ms)	Frame Encoding	(%)	(dB)
1	Worst-Case Manual Button Press	Single	4	0.38	44.5	93.2	When manually actuated button press the EUT transmits 4 frames FSK data. Each frame is 44.5 ms in duration with a minimum period of 93.2 ms.	47.7	-6.4

Example Calculation: Worst Case Duty (%) = 44.5 ms / 93.2 ms = 47.7 %
 Equipment Used: DIPEMC001, RSFSV30001

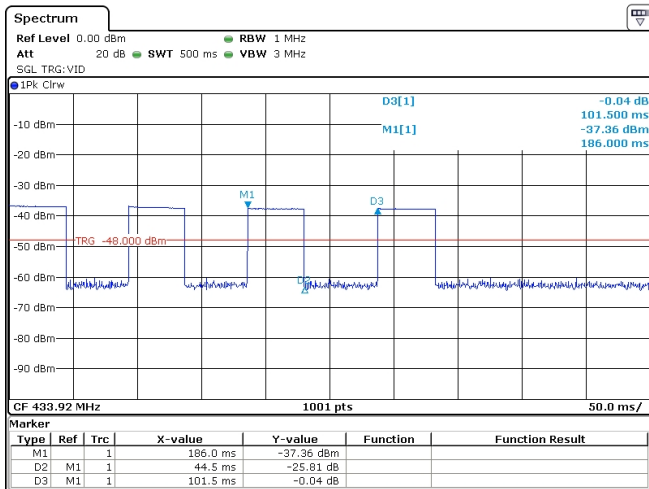
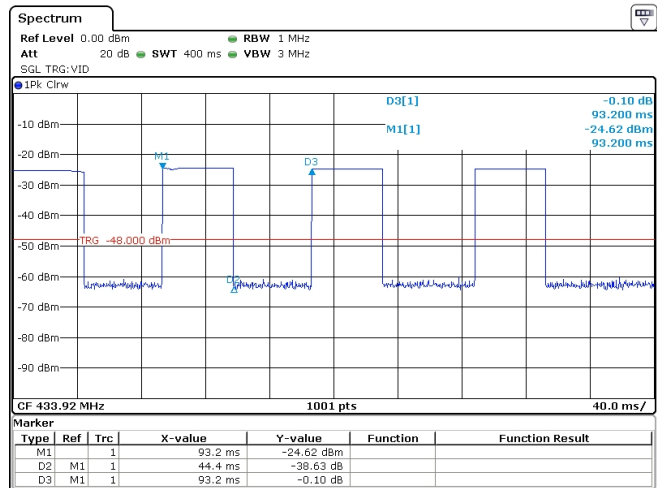
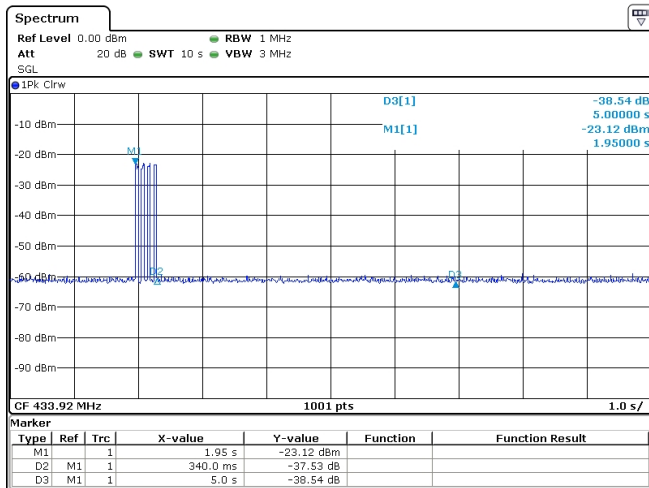

Figure 5: Fundamental Emission Pulsed Operation.

3.2.2 Fundamental Emission Bandwidth

Test Setup & Procedure The test equipment and facilities were setup in accordance with the standards and procedures listed in Section 1.1. Environmental conditions were set at the appropriate temperature and thermal balance was checked with a thermocouple based probe. Emission bandwidth (EBW) of the EUT is measured with the device placed in the test mode(s) with the shortest available frame length and minimum frame spacing. The 20 dB EBW is measured as the max-held peak-detected signal when the IF bandwidth is greater than or equal to 1% of the receiver span. For complex modulations other than ASK and FSK, the 99% emission bandwidth per IC test procedures has a different result, and is also reported. The test equipment employed includes RSFSV30001, DIPEMC001.

Measurement Results The details and results of testing the EUT are summarized in Table 4. Plots showing the measurements made to obtain these values are provided in Figure 6.

Table 4: Fundamental Emission Bandwidth.

Detector Pk	IF Bandwidth 10 kHz	Video Bandwidth 30 kHz	Test Date: 2-Feb-16
			Test Engineer: Joseph Brunett
			EUT: Strattec MP Flipkey
			EUT Mode: Modulated
			Meas. Distance: 10 cm

FCC/IC						
#	Modulation	Center Frequency (MHz)	20 dB EBW (MHz)	EBW Limit (MHz)	99% OBW (MHz)	
1	FSK	433.92	0.0619	1.0848	0.0519	
2						

Equipment Used: DIPEMC001, RSFSV30001

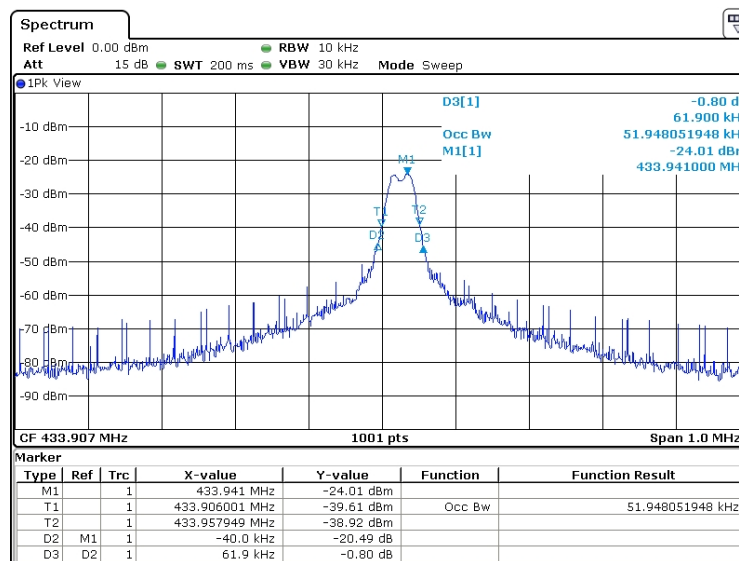

Figure 6: Fundamental Emission Bandwidth.

3.2.3 Fundamental Emission Field Strength

Test Setup & Procedure The test equipment and facilities were setup in accordance with the standards and procedures listed in Section 1.1. Environmental conditions were set at the appropriate temperature and thermal balance was checked with a thermocouple based probe. Fundamental emissions are measured at the regulatory distance on our OATS. The test equipment employed includes RSFSV30001, DIPEMC001.

Measurement Results The details and results of testing the EUT are summarized in Table 5.

Table 5: Fundamental Emission Field Strength.

Frequency Range	Det	IF Bandwidth	Video Bandwidth	Test Date:	2-Feb-16
25 MHz f 1 000 MHz	Pk/QPk	120 kHz	300 kHz	Test Engineer:	Joseph Brunett
f > 1 000 MHz	Pk	1 MHz	3 MHz	EUT:	Strattec MP Flipkey
f > 1 000 MHz	Avg	1 MHz	10 kHz	EUT Mode:	CW
				Meas. Distance:	3 meters

FCC/IC												
#	Freq. MHz	Ant. Used	Ant. Pol.	Pr (Pk) dBm	Pr (Avg)* dBm	Ka dB/m	Kg dB	E3(Pk) dBµV/m	E3(Avg) dBµV/m	FCC/IC E3(Avg) Lim. dBµV/m	Pass dB	Comments
1	Key Out (4 BTN)											
2	433.92	Dip	H	-11.9	-18.3	21.5	33.2	83.4	77.0	80.8	3.8	
3	433.92	Dip	V	-11.9	-18.3	21.5	33.2	83.4	77.0	80.8	3.8	
4	Key In (4 BTN)											
5	433.92	Dip	H	-11.6	-18.0	21.5	33.2	83.7	77.3	80.8	3.5	
6	433.92	Dip	V	-10.9	-17.3	21.5	33.2	84.4	78.0	80.8	2.8	
7												
8	Key In (3 BTN)											
9	433.92	Dip	V	-11.2	-17.6	21.5	33.2	84.1	77.7	80.8	3.1	
10	Key In (2 BTN)											
11	433.92	Dip	V	-11.1	-17.5	21.5	33.2	84.2	77.8	80.8	3.0	
12												
#	Freq. MHz	DC Supply Voltage		Relative Pr (Pk) dBm**								
13	433.92	2.60		-18.2								
14	433.92	2.80		-17.5								
15	433.92	3.00		-17.3								
16	433.92	3.15		-17.2								
17	433.92	3.30		-17.0								

*Avg data computed from Peak Measured Data and EUT Duty Cycle. EUT in CW mode.

3.3 Unintentional Emissions

3.3.1 Transmit Chain Spurious Emissions

Test Setup & Procedure The test equipment and facilities were setup in accordance with the standards and procedures listed in Section 1.1. Environmental conditions were set at the appropriate temperature and thermal balance was checked with a thermocouple based probe. Spurious radiated emissions measurements are performed to 10 times the highest fundamental operating frequency. The test equipment employed includes RSFSV30001, DIPEMC001, HRNQR316401.

Measurement Results The details and results of testing the EUT are summarized in Table 6.

Table 6: Transmit Chain Spurious Emissions.

Frequency Range	Det	IF Bandwidth	Video Bandwidth	Test Date:	5-Feb-16
25 MHz f 1 000 MHz	Pk/QPk	120 kHz	300 kHz	Test Engineer:	Joseph Brunett
f > 1 000 MHz	Pk	1 MHz	3 MHz	EUT:	Strattec MP Flipkey
f > 1 000 MHz	Avg	1 MHz	10kHz	EUT Mode:	CW
				Meas. Distance:	3 meters

Transmitter Unintentional Spurious Emissions												FCC/IC
#	Freq. MHz	Ant. Used	Ant. Pol.	Pr (Pk) dBm	Pr (Avg)* dBm	Ka dB/m	Kg dB	E3(Pk) dBµV/m	E3(Avg) dBµV/m	FCC/IC E3lim (Avg) dBµV/m	Pass dB	Comments
1	Key Out (4 BTN)											
2	867.8	Dip	H	-54.9	-61.3	27.8	26.8	53.1	46.7	60.9	14.1	max all
3	867.8	Dip	V	-56.2	-62.6	24.8	26.8	48.8	42.4	60.9	18.5	max all
4	1301.8	R-Horn	H/V	-79.6	-86.0	25.4	-0.2	53.0	46.6	60.9	14.3	max all
5	1735.7	R-Horn	H/V	-89.3	-95.7	28.7	-0.2	46.6	40.2	60.9	20.7	max all
6	2169.6	R-Horn	H/V	-85.9	-92.3	30.7	-0.3	52.0	45.6	60.9	15.2	max all
7	2603.5	R-Horn	H/V	-93.9	-100.3	33.8	-0.3	47.2	40.8	60.9	20.0	max all
8	3037.4	R-Horn	H/V	-95.6	-102.0	36.5	-0.3	48.2	41.8	60.9	19.0	max all
9	3471.4	R-Horn	H/V	-95.8	-102.2	36.0	-0.4	47.6	41.1	60.9	19.7	max all
10	3905.3	R-Horn	H/V	-75.2	-81.6	33.9	-0.4	66.1	59.7	60.9	1.1	max all
11	4339.2	R-Horn	H/V	-94.8	-101.2	33.1	-0.4	45.7	39.3	60.9	21.6	max all
12												
13												
14												
15	Key In (4 BTN)											
16	867.8	Dip	H	-53.2	-59.6	27.8	26.8	54.8	48.4	60.9	12.4	max all
17	867.8	Dip	V	-55.9	-62.3	27.8	26.8	52.1	45.7	60.9	15.1	max all
18	1301.8	R-Horn	H/V	-74.1	-80.5	25.4	-0.2	58.5	52.1	60.9	8.8	max all
19	1735.7	R-Horn	H/V	-92.5	-98.9	28.7	-0.2	43.4	37.0	60.9	23.9	max all
20	2169.6	R-Horn	H/V	-86.5	-92.9	30.7	-0.3	51.4	45.0	60.9	15.8	max all
21	2603.5	R-Horn	H/V	-97.4	-103.8	33.8	-0.3	43.7	37.3	60.9	23.5	max all
22	3037.4	R-Horn	H/V	-95.2	-101.6	36.5	-0.3	48.6	42.2	60.9	18.6	max all
23	3471.4	R-Horn	H/V	-95.4	-101.8	36.0	-0.4	48.0	41.5	60.9	19.3	max all
24	3905.3	R-Horn	H/V	-76.1	-82.5	33.9	-0.4	65.2	58.8	60.9	2.0	max all
25	4339.2	R-Horn	H/V	-91.4	-97.8	33.1	-0.4	49.1	42.7	60.9	18.2	max all
26												
27												
28												

*Avg data computed from Peak Measured Data and EUT Duty Cycle. EUT in CW mode.

Equipment Used: DIPEMC001, UMHORN005, RSFSV30001

3.3.2 Radiated Digital Spurious

The results for the measurement of digital spurious emissions are not reported herein as all digital emissions were greater than 20 dB below the regulatory limit. Radiation from digital components was measured to 4 GHz, or to five times the maximum digital component operating frequency, whichever is greater.