

FCC RADIO TEST REPORT

FCC 47 CFR PART 15 SUBPART C

Test Standard	FCC Part 15.247
FCC ID	OHBUPCCHTGPS01
Brand name	AAEON
Product name	UP-Core board
Model No.	xUPC-CHT01x (x-where x may be any combination of alphanumeric characters or "--" or blank)
Test Result	Pass

The test Result was tested by Compliance Certification Services Inc. The test data, data evaluation, test procedures, and equipment configurations shown in this report were given in ANSI C63.10: 2013 and compliance standards.

The test results of this report relate only to the tested sample (EUT) identified in this report.

The test Report of full or partial shall not copy. Without written approval of Compliance Certification Services Inc.(Wugu Laboratory)



Approved by:

Tested by:

A handwritten signature in black ink, appearing to read "Sam Chuang".

A handwritten signature in black ink, appearing to read "Jerry Chuang".

Sam Chuang
Manager

Jerry Chuang
Engineer

Revision History

Rev.	Issue Date	Revisions	Revised By
00	January 16, 2018	Initial Issue	May Lin

Table of contents

1.	GENERAL INFORMATION	4
1.1	EUT INFORMATION.....	4
1.2	EUT CHANNEL INFORMATION	5
1.3	ANTENNA INFORMATION	5
1.4	MEASUREMENT UNCERTAINTY	6
1.5	FACILITIES AND TEST LOCATION	7
1.6	INSTRUMENT CALIBRATION	7
1.7	SUPPORT AND EUT ACCESSORIES EQUIPMENT.....	8
1.8	TEST METHODOLOGY AND APPLIED STANDARDS.....	8
2.	TEST SUMMERY.....	9
3.	DESCRIPTION OF TEST MODES	10
3.1	THE WORST MODE OF OPERATING CONDITION.....	10
3.2	THE WORST MODE OF MEASUREMENT	11
3.3	EUT DUTY CYCLE	12
4.	TEST RESULT.....	13
4.1	AC POWER LINE CONDUCTED EMISSION.....	13
4.2	6DB BANDWIDTH AND OCCUPIED BANDWIDTH(99%).....	16
4.3	OUTPUT POWER MEASUREMENT	21
4.4	POWER SPECTRAL DENSITY.....	23
4.5	CONDUCTED BANDEDGE AND SPURIOUS EMISSION	28
4.6	RADIATION BANDEDGE AND SPURIOUS EMISSION.....	38
	APPENDIX I PHOTOGRAPHS OF EUT	

1. GENERAL INFORMATION

1.1 EUT INFORMATION

Applicant	AAEON Technology Inc. 5F, No.135, Lane 235, Pao Chiao Rd, Hsin-Tien Dist., New Taipei City, Taiwan, R.O.C
Manufacturer	AAEON Technology Inc. 5F, No.135, Lane 235, Pao Chiao Rd, Hsin-Tien Dist., New Taipei City, Taiwan, R.O.C
Equipment	UP-Core board
Model No.	xUPC-CHT01x (x-where x may be any combination of alphanumeric characters or "-" or blank)
Model Discrepancy	All the above models are identical except for the designation of model numbers. The suffix of (x-where x may be any combination of alphanumeric characters or "-" or blank) on model number is just for marketing purpose only.
Received Date	October 27, 2017
Date of Test	November 10, 2017 ~ January 11, 2018
Output Power(W)	IEEE 802.11b mode: 0.0655 IEEE 802.11g mode: 0.1047 IEEE 802.11n HT 20 MHz mode : 0.0942
Power Supply	5VDC from AC adapter I/P:100~240VAC 0.6A 50~60Hz O/P: 5VDC 4A

1.2 EUT CHANNEL INFORMATION

Frequency Range	2412MHz-2462MHz
Modulation Type	1. IEEE 802.11b mode: CCK 2. IEEE 802.11g mode: OFDM 3. IEEE 802.11n HT 20 MHz mode : OFDM
Bandwidth	1. IEEE 802.11b mode: 11 Channels 2. IEEE 802.11g mode: 11 Channels 3. IEEE 802.11n HT 20 MHz mode : 11 Channels

Remark:

Refer as ANSI 63.10:2013 clause 5.6.1 Table 4 for test channels

Number of frequencies to be tested		
Frequency range in which device operates	Number of frequencies	Location in frequency range of operation
<input type="checkbox"/> 1 MHz or less	1	Middle
<input type="checkbox"/> 1 MHz to 10 MHz	2	1 near top and 1 near bottom
<input checked="" type="checkbox"/> More than 10 MHz	3	1 near top, 1 near middle, and 1 near bottom

1.3 ANTENNA INFORMATION

Antenna Type	<input type="checkbox"/> PIFA <input type="checkbox"/> PCB <input checked="" type="checkbox"/> Dipole <input type="checkbox"/> Coils
Antenna Gain	Gain: 2dBi

1.4 MEASUREMENT UNCERTAINTY

PARAMETER	UNCERTAINTY
AC Powerline Conducted Emission	+/- 2.96
Emission bandwidth, 20dB bandwidth	+/- 1.4003
RF output power, conducted	+/- 1.1372
Power density, conducted	+/- 1.4003
3M Semi Anechoic Chamber / 30M~200M	+/- 4.0138
3M Semi Anechoic Chamber / 200M~1000M	+/- 3.9483
3M Semi Anechoic Chamber / 1G~8G	+/- 2.5975
3M Semi Anechoic Chamber / 8G~18G	+/- 2.6112
3M Semi Anechoic Chamber / 18G~26G	+/- 2.7389
3M Semi Anechoic Chamber / 26G~40G	+/- 2.9683
3M Semi Anechoic Chamber / 40G~60G	+/- 1.8509
3M Semi Anechoic Chamber / 60G~75G	+/- 1.9869
3M Semi Anechoic Chamber / 75G~110G	+/- 2.9651
3M Semi Anechoic Chamber / 110G~170G	+/- 2.7807
3M Semi Anechoic Chamber / 170G~220G	+/- 3.6437
3M Semi Anechoic Chamber / 220G~325G	+/- 4.2982

Remark:

1. This uncertainty represents an expanded uncertainty expressed at approximately the 95% confidence level using a coverage factor of $k=2$
2. ISO/IEC 17025 requires that an estimate of the measurement uncertainties associated with the emissions test results be included in the report.

1.5 FACILITIES AND TEST LOCATION

All measurement facilities used to collect the measurement data are located at
 No.11, Wugong 6th Rd., Wugu Dist., New Taipei City 24891, Taiwan. (R.O.C.)

Test site	Test Engineer	Remark
AC Conduction Room	Jerry Chuang	-
Radiation	Jerry Chuang	-
RF Conducted	Jerry Chuang	-

Remark: The sites are constructed in conformance with the requirements of ANSI C63.7, ANSI C63.4 and CISPR Publication 22.

1.6 INSTRUMENT CALIBRATION

RF Conducted Test Site					
Equipment	Manufacturer	Model	S/N	Cal Date	Cal Due
Power Meter	Anritsu	ML2495A	1033009	04/11/2017	04/10/2018
Power Sensor	Anritsu	MA2411B	917072	07/03/2017	07/02/2018
Spectrum Analyzer	Keysight	N9010B	MY55460167	06/14/2017	06/13/2018
Thermostatic/Hrgros atic Chamber	GWINSTEK	GTC-288MH-CC	TH160402	05/23/2017	05/22/2018

3M 966 Chamber Test Site					
Equipment	Manufacturer	Model	S/N	Cal Date	Cal Due
Bilog Antenna	Sunol Sciences	JB3	A030105	06/20/2017	06/19/2018
Horn Antenna	EMCO	3117	00055165	02/20/2017	02/19/2018
Pre-Amplifier	EMCI	EMC 012635	980151	08/01/2017	07/31/2018
Pre-Amplifier	EMEC	EM330	060609	06/07/2017	06/06/2018
Spectrum Analyzer	Agilent	E4446A	US42510252	11/27/2017	11/26/2018
Antenna Tower	CCS	CC-A-1F	N/A	N.C.R	N.C.R
Controller	CCS	CC-C-1F	N/A	N.C.R	N.C.R
Turn Table	CCS	CC-T-1F	N/A	N.C.R	N.C.R

AC Conduction Test Room					
Name of Equipment	Manufacturer	Model	S/N	Cal Date	Cal Due
LISN	R&S	ENV216	101054	05/18/2017	05/17/2018
LISN	SCHWARZBECK	NSLK 8127	8127-541	02/14/2017	02/13/2018
EMI Test Receiver	R&S	ESCI	100064	05/17/2017	05/16/2018

Remark:

- Each piece of equipment is scheduled for calibration once a year and Precision Dipole is scheduled for calibration once three years.
- N.C.R. = No Calibration Request.

1.7 SUPPORT AND EUT ACCESSORIES EQUIPMENT

EUT Accessories Equipment					
No.	Equipment	Brand	Model	Series No.	FCC ID
	N/A				

Support Equipment					
No.	Equipment	Brand	Model	Series No.	FCC ID
1	AC power Source	Extech	6805	N/A	N/A

1.8 TEST METHODOLOGY AND APPLIED STANDARDS

The test methodology, setups and results comply with all requirements in accordance with ANSI C63.10:2013, FCC Part 2, FCC Part 15.247, KDB 558074 D01 v04.

2. TEST SUMMERY

FCC Standard Section	Report Section	Test Item	Result
15.203	1.3	Antenna Requirement	Pass
15.207(a)	4.1	AC Conducted Emission	Pass
15.247(a)(2)	4.2	6 dB Bandwidth	Pass
15.247(b)	4.3	Output Power Measurement	Pass
15.247(e)	4.4	Power Spectral Density	Pass
15.247(d)	4.5	Conducted Band Edge	Pass
15.247(d)	4.5	Conducted Emission	Pass
15.247(d)	4.6	Radiation Band Edge	Pass
15.247(d)	4.6	Radiation Spurious Emission	Pass

3. DESCRIPTION OF TEST MODES

3.1 THE WORST MODE OF OPERATING CONDITION

<p>Operation mode</p>	<p>IEEE 802.11b mode :1Mbps IEEE 802.11g mode :6Mbps IEEE 802.11n HT20 mode: MCS0</p>
<p>Test Channel Frequencies</p>	<p>IEEE 802.11b mode: 1. Lowest Channel: 2412MHz 2. Middle Channel: 2437MHz 3. Highest Channel: 2462MHz IEEE 802.11g mode: 1. Lowest Channel: 2412MHz 2. Middle Channel: 2437MHz 3. Highest Channel: 2462MHz IEEE 802.11n HT20 mode: 1. Lowest Channel: 2412MHz 2. Middle Channel: 2437MHz 3. Highest Channel: 2462MHz</p>
<p>Operation Transmitter</p>	<p>IEEE 802.11b mode: 1T1R IEEE 802.11g mode: 1T1R IEEE 802.11n HT20 mode: 1T1R</p>

Remark:

1. EUT pre-scanned data rate of output power for each mode, the worst data rate were recorded in this report.

3.2 THE WORST MODE OF MEASUREMENT

AC Power Line Conducted Emission	
Test Condition	AC Power line conducted emission for line and neutral
Voltage/Hz	120V / 60Hz
Test Mode	Mode 1: EUT power by AC adapter via power cable.
Worst Mode	<input checked="" type="checkbox"/> Mode 1 <input type="checkbox"/> Mode 2 <input type="checkbox"/> Mode 3 <input type="checkbox"/> Mode 4

Radiated Emission Measurement Above 1G	
Test Condition	Band edge, Emission for Unwanted and Fundamental
Voltage/Hz	120V / 60Hz
Test Mode	Mode 1: EUT power by AC adapter via power cable.
Worst Mode	<input checked="" type="checkbox"/> Mode 1 <input type="checkbox"/> Mode 2 <input type="checkbox"/> Mode 3 <input type="checkbox"/> Mode 4
Worst Position	<input type="checkbox"/> Placed in fixed position. <input checked="" type="checkbox"/> Placed in fixed position at X-Plane (E2-Plane) <input type="checkbox"/> Placed in fixed position at Y-Plane (E1-Plane) <input type="checkbox"/> Placed in fixed position at Z-Plane (H-Plane)
Worst Polarity	<input checked="" type="checkbox"/> Horizontal <input type="checkbox"/> Vertical

Radiated Emission Measurement Below 1G	
Test Condition	Radiated Emission Below 1G
Voltage/Hz	120V / 60Hz
Test Mode	Mode 1: EUT power by AC adapter via power cable.
Worst Mode	<input checked="" type="checkbox"/> Mode 1 <input type="checkbox"/> Mode 2 <input type="checkbox"/> Mode 3 <input type="checkbox"/> Mode 4

Remark:

- 1. The worst mode was record in this test report.*
- 2. EUT pre-scanned in three axis, X, Y, Z and two polarity, Horizontal and Vertical for radiated measurement. The worst case (X-Plane and Horizontal) were recorded in this report*
- 3. For below 1G, AC power line conducted emission and radiation emission were performed the EUT transmit at the highest output power channel as worse case.*

3.3 EUT DUTY CYCLE

Duty Cycle				
Configuration	TX ON (ms)	TX ALL (ms)	Duty Cycle (%)	Duty Factor(dB)
802.11b	8.4400	8.5100	99.18%	0.04
802.11g	1.4500	1.5300	94.77%	0.23
802.11n HT20	1.3300	1.4100	94.33%	0.25

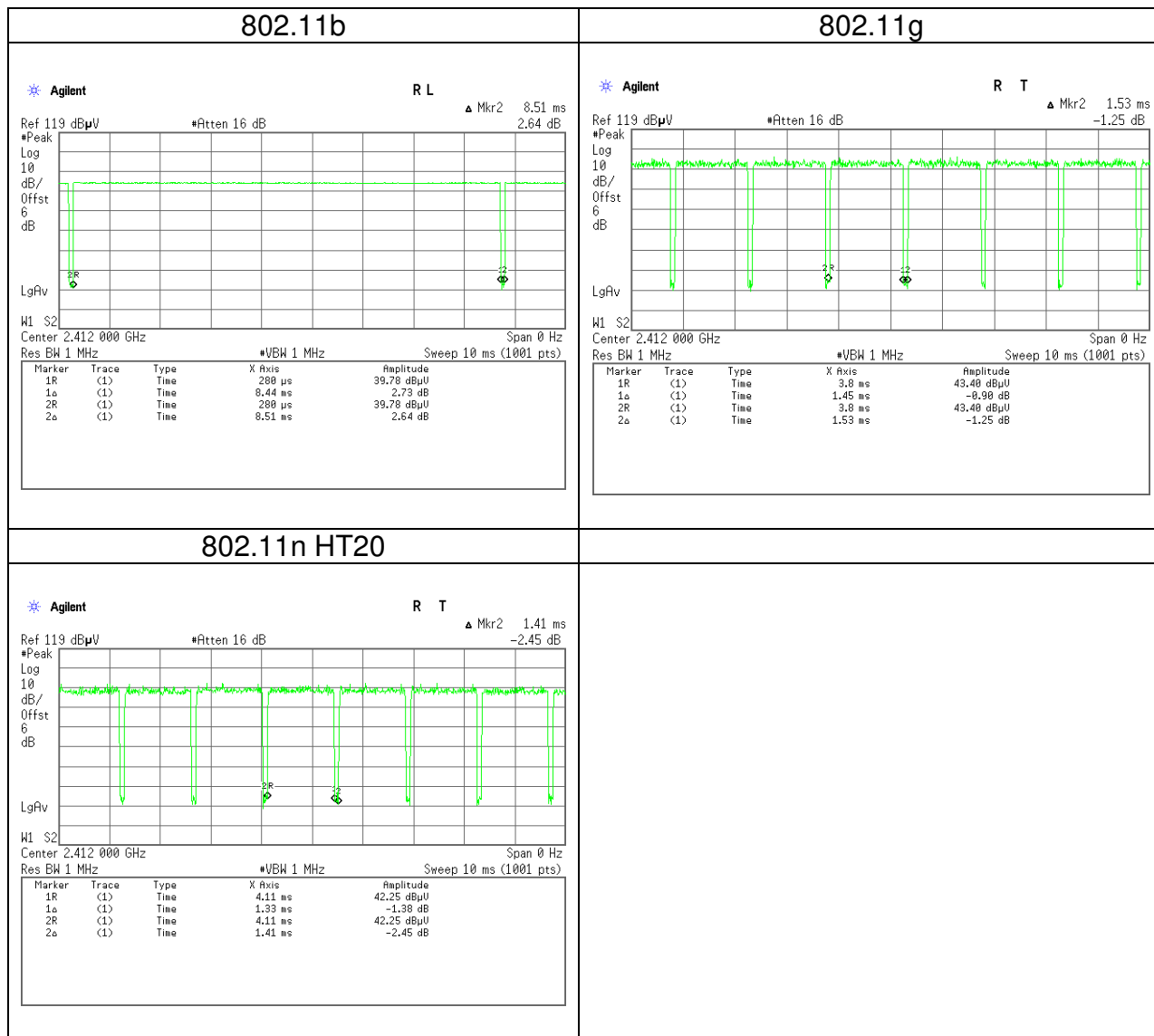

4. TEST RESULT

4.1 AC POWER LINE CONDUCTED EMISSION

4.1.1 Test Limit

According to §15.207(a)(2)

Frequency Range (MHz)	Limits(dBμV)	
	Quasi-peak	Average
0.15 to 0.50	66 to 56*	56 to 46*
0.50 to 5	56	46
5 to 30	60	50

* Decreases with the logarithm of the frequency.

4.1.2 Test Procedure

Test method Refer as ANSI 63.10:2013 clause 6.2,

1. The EUT was placed on a non-conducted table, which is 0.8m above horizontal ground plane and 0.4m above vertical ground plane.
2. EUT connected to the line impedance stabilization network (LISN)
3. Receiver set RBW of 9kHz and Detector Peak, and note as quasi-peak and average.
4. Maximum procedure was performed on the six highest emissions to ensure EUT compliance.
5. Recorded Line for Neutral and Line.

4.1.3 Test Setup

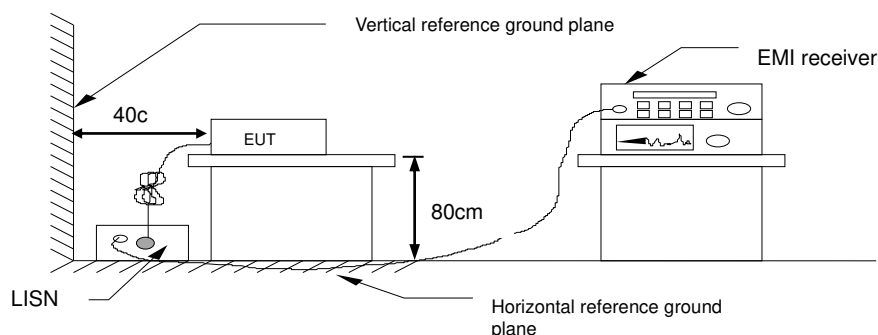

4.1.4 Test Result

Pass.

Test Data

Test Mode:	Mode 1	Temp/Hum	24(°C)/ 50%RH
Test Voltage:	120Vac / 60Hz	Test Date	November 14, 2017
Phase:	Line	Test Engineer	Jerry Chuang

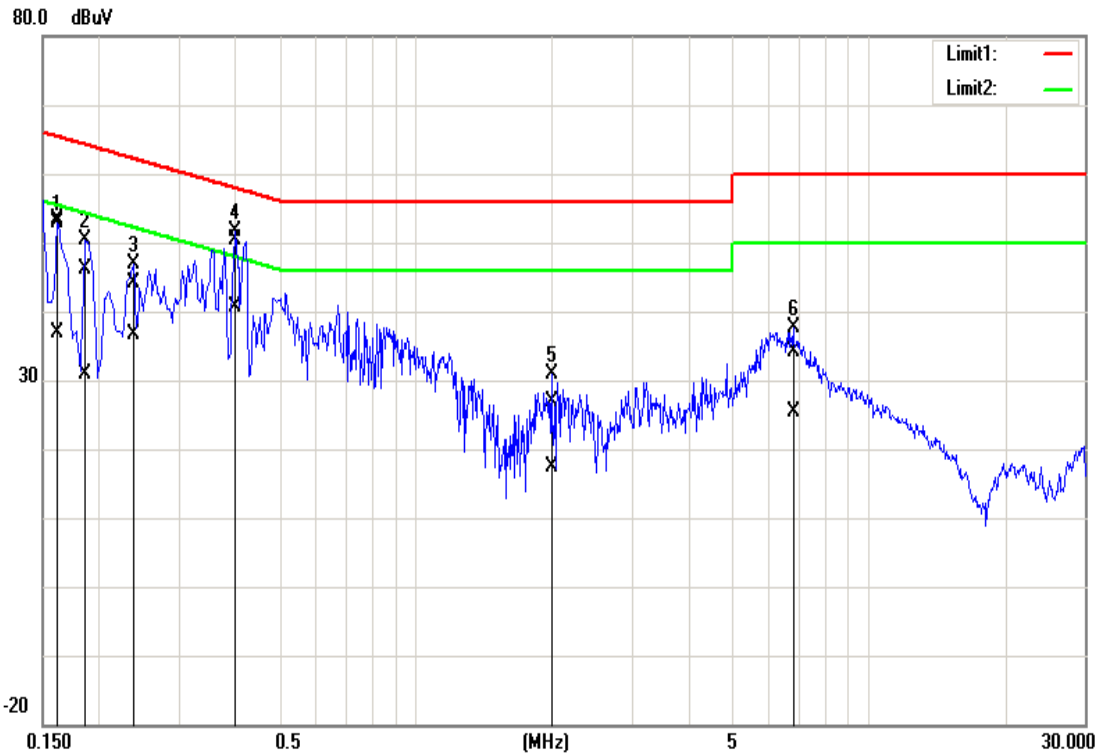

No.	Frequency (MHz)	QuasiPeak reading (dBuV)	Average reading (dBuV)	Correction factor (dB)	QuasiPeak result (dBuV)	Average result (dBuV)	QuasiPeak limit (dBuV)	Average limit (dBuV)	QuasiPeak margin (dB)	Average margin (dB)
1	0.1620	53.37	36.84	-0.02	53.35	36.82	65.36	55.36	-12.01	-18.54
2	0.1860	46.08	30.87	-0.03	46.05	30.84	64.21	54.21	-18.16	-23.37
3	0.2380	44.21	36.73	-0.03	44.18	36.70	62.17	52.17	-17.99	-15.47
4	0.3980	50.38	40.62	-0.05	50.33	40.57	57.90	47.90	-7.57	-7.33
5	1.9980	27.04	17.42	-0.06	26.98	17.36	56.00	46.00	-29.02	-28.64
6	6.8260	34.11	25.28	0.07	34.18	25.35	60.00	50.00	-25.82	-24.65

Test Mode:	Mode 1	Temp/Hum	24(°C)/ 50%RH
Test Voltage:	120Vac / 60Hz	Test Date	November 14, 2017
Phase:	Neutral	Test Engineer	Jerry Chuang

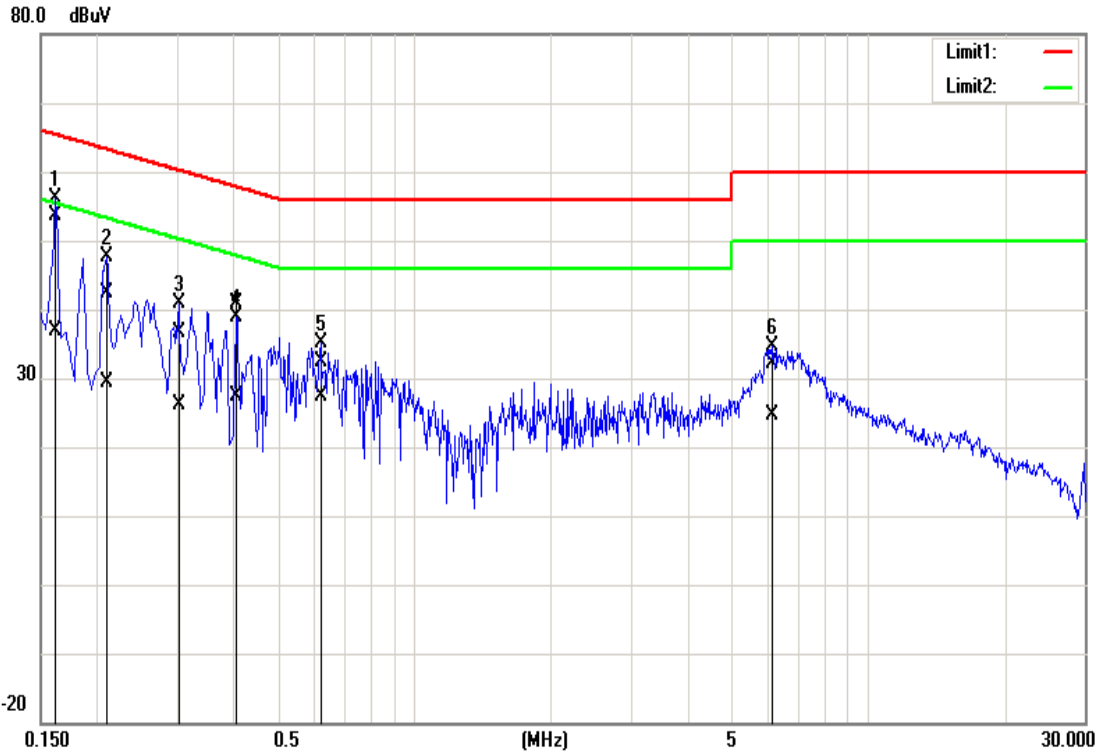

No.	Frequency (MHz)	QuasiPeak reading (dBuV)	Average reading (dBuV)	Correction factor (dB)	QuasiPeak result (dBuV)	Average result (dBuV)	QuasiPeak limit (dBuV)	Average limit (dBuV)	QuasiPeak margin (dB)	Average margin (dB)
1	0.1620	53.76	36.92	-0.09	53.67	36.83	65.36	55.36	-11.69	-18.53
2	0.2100	42.43	29.52	-0.10	42.33	29.42	63.21	53.21	-20.88	-23.79
3	0.3020	36.63	26.37	-0.12	36.51	26.25	60.19	50.19	-23.68	-23.94
4	0.4060	40.99	27.53	-0.13	40.86	27.40	57.73	47.73	-16.87	-20.33
5	0.6220	32.50	27.39	-0.13	32.37	27.26	56.00	46.00	-23.63	-18.74
6	6.1740	32.28	24.73	-0.17	32.11	24.56	60.00	50.00	-27.89	-25.44

4.2 6DB BANDWIDTH AND OCCUPIED BANDWIDTH (99%)

4.2.1 Test Limit

According to §15.247(a)(2)

6 dB Bandwidth :

Limit	Shall be at least 500kHz
-------	--------------------------

Occupied Bandwidth(99%) : For reporting purposes only.

4.2.2 Test Procedure

Test method Refer as KDB 558074 D01 v04, Section 8.1 and ANSI 63.10:2013 clause 6.9.2,

1. The EUT RF output connected to the spectrum analyzer by RF cable.
2. Setting maximum power transmit of EUT
3. SA set RBW = 100kHz, VBW = 300kHz and Detector = Peak, to measurement 6 dB Bandwidth and 99% Bandwidth.
4. Measure and record the result of 6 dB Bandwidth and 99% Bandwidth. in the test report.

4.2.3 Test Setup

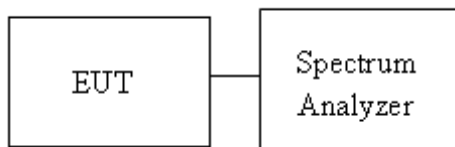

4.2.4 Test Result

Test mode: IEEE 802.11b mode / 2412-2462 MHz						
Channel	Frequency (MHz)	Chain 0 OBW(99%) (MHz)	Chain 1 OBW(99%) (MHz)	Chain 0 6dB BW (MHz)	Chain 1 6dB BW (MHz)	6dB limit (kHz)
Low	2412	14.0665	--	9.0435	--	≥500
Mid	2437	14.0231	--	9.5652	--	
High	2462	14.0231	--	9.0435	--	

Test mode: IEEE 802.11g mode / 2412-2462 MHz						
Channel	Frequency (MHz)	Chain 0 OBW(99%) (MHz)	Chain 1 OBW(99%) (MHz)	Chain 0 6dB BW (MHz)	Chain 1 6dB BW (MHz)	6dB limit (kHz)
Low	2412	16.7149	--	15.7391	--	≥500
Mid	2437	16.6714	--	15.8261	--	
High	2462	16.7149	--	15.8696	--	

Test mode: IEEE 802.11n HT 20 MHz mode / 2412-2462 MHz						
Channel	Frequency (MHz)	Chain 0 OBW(99%) (MHz)	Chain 1 OBW(99%) (MHz)	Chain 0 6dB BW (MHz)	Chain 1 6dB BW (MHz)	6dB limit (kHz)
Low	2412	17.8871	--	17.5652	--	≥500
Mid	2437	17.8437	--	16.5652	--	
High	2462	17.8437	--	17.5652	--	

Test Data

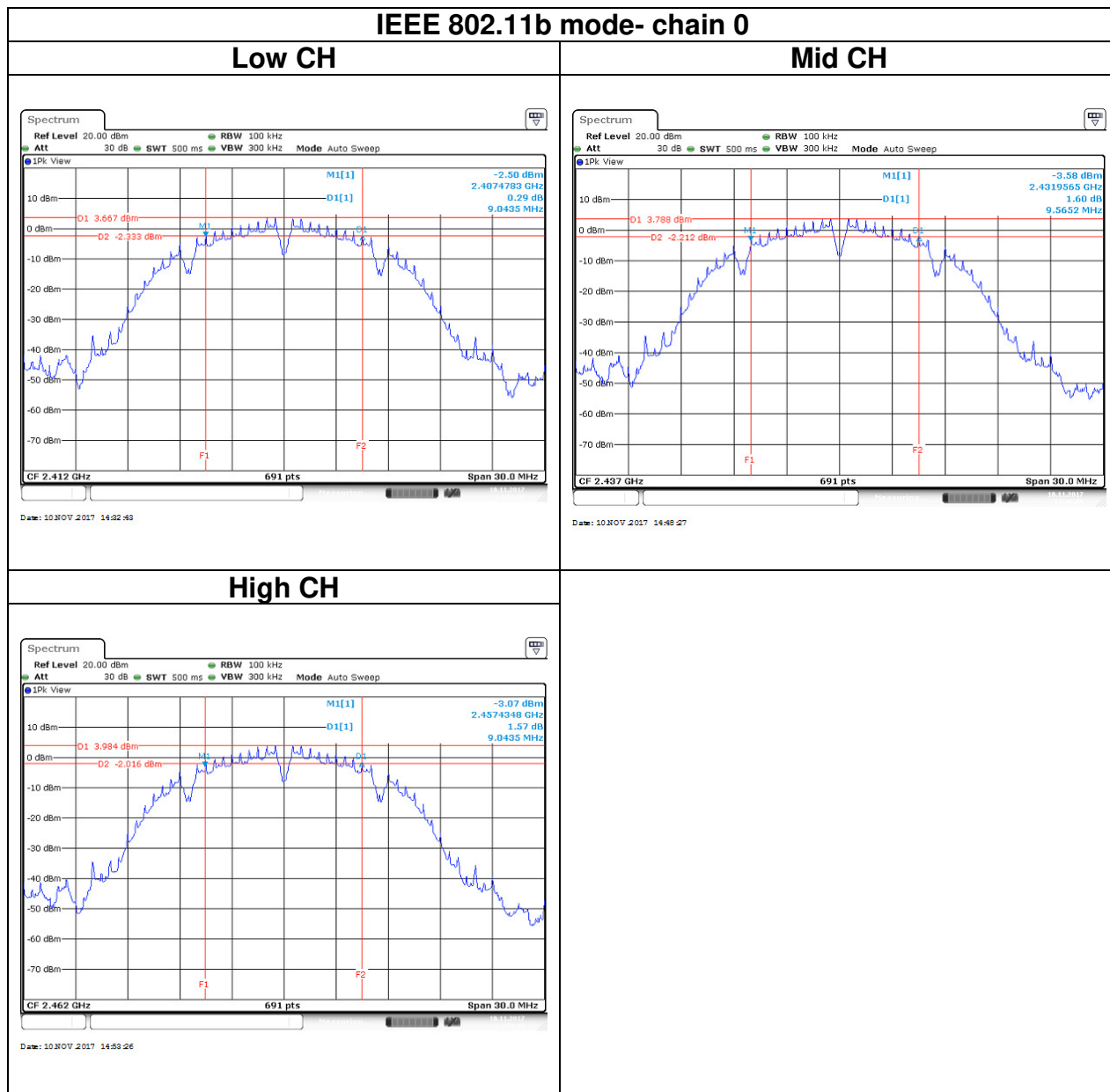

IEEE 802.11g mode- chain 0

Low CH

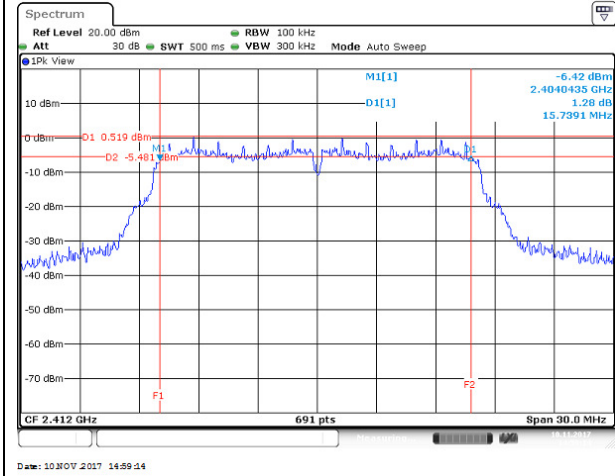

Mid CH

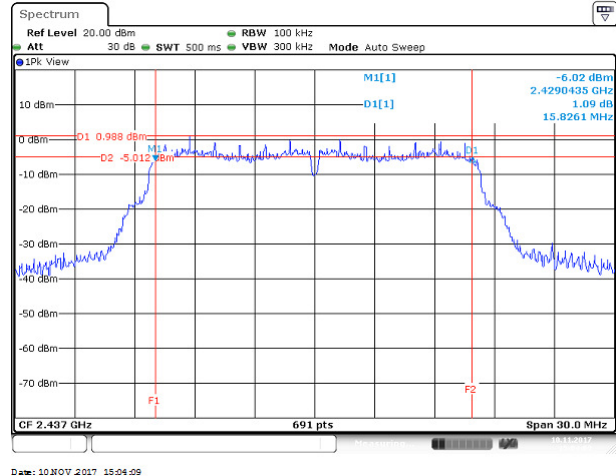

High CH

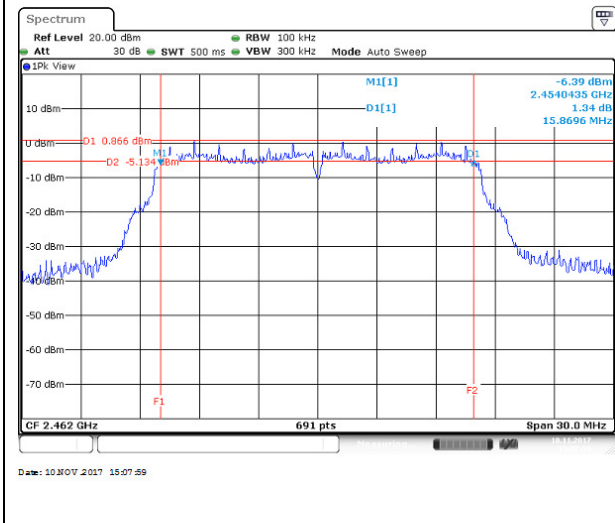

IEEE 802.11n HT20 mode- chain 0

Low CH

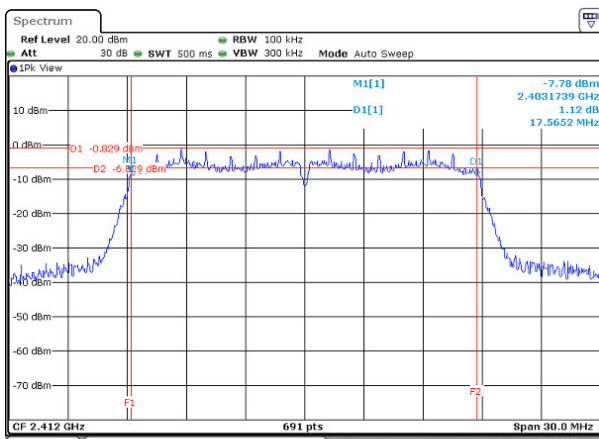

Date: 10 NOV 2017 15:13:23

Mid CH

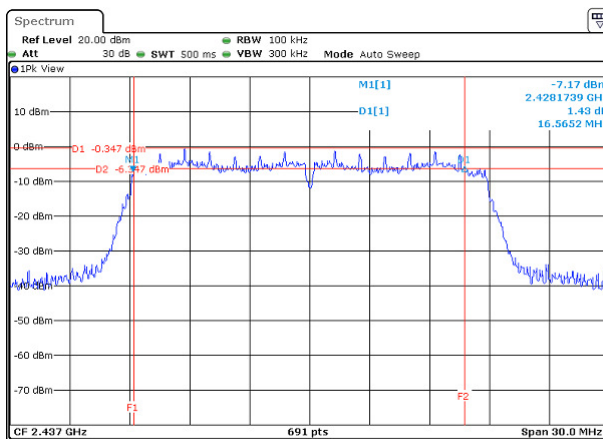

Date: 10 NOV 2017 15:18:16

High CH

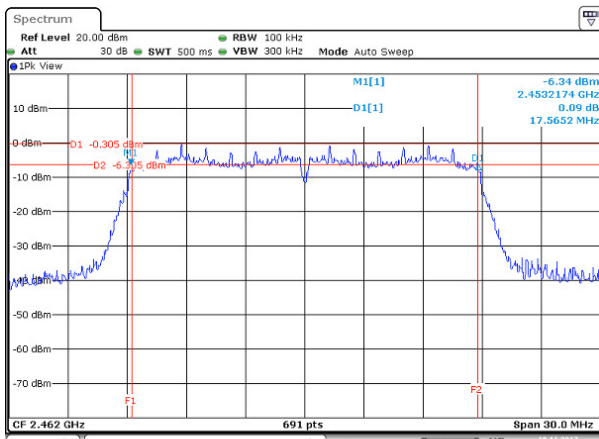

Date: 10 NOV 2017 15:21:56

4.3 OUTPUT POWER MEASUREMENT

4.3.1 Test Limit

According to §15.247(b)

Peak output power :

For systems using digital modulation in the 2400-2483.5 MHz, and 5725-5850 MHz bands: 1 Watt(30 dBm) and the e.i.r.p. shall not exceed 4Watt(36 dBm), base on the use of antennas with directional gain not exceed 6 dBi If transmitting antennas of directional gain greater than 6dBi are used the peak output power the conducted output power from the intentional radiator shall be reduced by the amount in dB that the directional gain of the antenna exceeds 6 dBi. In case of point-to-point operation, the limit has to be reduced by 1dB for every 3 dB that the directional gain of the antenna exceeds 6 dBi.

Limit	<input checked="" type="checkbox"/> Antenna not exceed 6 dBi : 30dBm <input type="checkbox"/> Antenna with DG greater than 6 dBi : [Limit = 30 – (DG – 6)] <input type="checkbox"/> Point-to-point operation :
-------	---

Average output power : For reporting purposes only.

4.3.2 Test Procedure

Test method Refer as KDB 558074 D01 v04, Section 9.1.2.

1. The EUT RF output connected to the power meter by RF cable.
2. Setting maximum power transmit of EUT.
3. The path loss was compensated to the results for each measurement.
4. Measure and record the result of Peak output power and Average output power. in the test report.

4.3.3 Test Setup

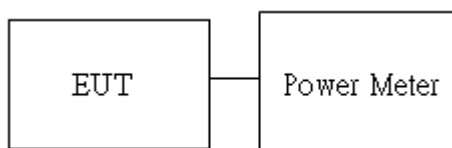

4.3.4 Test Result

Peak output power :

Wifi 2.4G									
Config	CH	Freq. (MHz)	power set		PK Power(dBm)		PK Total Power (dBm)	PK Total Power (W)	Limit (dBm)
			chain0	chain1	chain0	chain1			
IEEE 802.11b Data rate: 1Mbps	Low	2412	-1	-	17.09	-	17.09	0.0512	30
	Mid	2437	-1	-	17.53	-	17.53	0.0566	
	High	2462	-1	-	18.16	-	18.16	0.0655	
IEEE 802.11g Data rate: 6Mbps	Low	2412	-1	-	19.35	-	19.35	0.0861	
	Mid	2437	-1	-	19.42	-	19.42	0.0875	
	High	2462	-1	-	20.20	-	20.20	0.1047	
IEEE 802.11n HT20 Data rate: MCS 0	Low	2412	-1	-	18.04	-	18.04	0.0637	
	Mid	2437	-1	-	19.74	-	19.74	0.0942	
	High	2462	-1	-	19.66	-	19.66	0.0925	

Average output power :

Wifi 2.4G					
Config	CH	Freq. (MHz)	AV Power(dBm)		AV Total Power (dBm)
			chain0	chain1	
IEEE 802.11b Data rate: 1Mbps	Low	2412	11.60	-	11.60
	Mid	2437	12.11	-	12.11
	High	2462	12.64	-	12.64
IEEE 802.11g Data rate: 6Mbps	Low	2412	11.54	-	11.54
	Mid	2437	12.36	-	12.36
	High	2462	12.68	-	12.68
IEEE 802.11n HT20 Data rate: MCS 0	Low	2412	10.35	-	10.35
	Mid	2437	11.10	-	11.10
	High	2462	11.30	-	11.30

4.4 POWER SPECTRAL DENSITY

4.4.1 Test Limit

According to §15.247(e)

For digitally modulated systems, the power spectral density conducted from the intentional radiator to the antenna shall not be greater than 8 dBm in any 3 kHz band during any time interval of continuous transmission.

Limit	<input checked="" type="checkbox"/> Antenna not exceed 6 dBi : 8dBm <input type="checkbox"/> Antenna with DG greater than 6 dBi : [Limit = 8 – (DG – 6)] <input type="checkbox"/> Point-to-point operation :
-------	---

4.4.2 Test Procedure

Test method Refer as KDB 558074 D01 v04, Section 10.2

1. The EUT RF output connected to the spectrum analyzer by RF cable.
2. Setting maximum power transmit of EUT
3. SA set RBW = 3kHz, VBW = 30kHz, Span = 1.5 times DTS Bandwidth (6 dB BW), Detector = Peak, Sweep Time = Auto and Trace = Max hold.
4. The path loss and Duty Factor were compensated to the results for each measurement by SA.
5. Mark the maximum level.
6. Measure and record the result of power spectral density, in the test report.

4.4.3 Test Setup

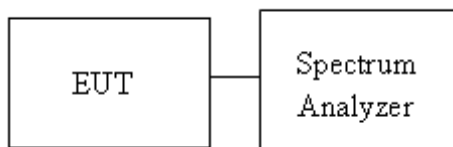

4.4.4 Test Result

Test mode: IEEE 802.11b mode / 2412-2462 MHz					
Channel	Frequency (MHz)	Chain 0 PPSD (dBm)	Chain 1 PPSD (dBm)	Total PSSD (dBm)	Limit (dBm)
Low	2412	-8.71	-	-8.71	8
Mid	2437	-9.08	-	-9.08	
High	2462	-8.48	-	-8.48	

Test mode: IEEE 802.11g mode / 2412-2462 MHz					
Channel	Frequency (MHz)	Chain 0 PPSD (dBm)	Chain 1 PPSD (dBm)	Total PSSD (dBm)	Limit (dBm)
Low	2412	-12.73	-	-12.73	8
Mid	2437	-12.31	-	-12.31	
High	2462	-12.18	-	-12.18	

Test mode: IEEE 802.11n HT 20 MHz mode / 2412-2462 MHz					
Channel	Frequency (MHz)	Chain 0 PPSD (dBm)	Chain 1 PPSD (dBm)	Total PSSD (dBm)	Limit (dBm)
Low	2412	-13.86	-	-13.86	8
Mid	2437	-13.19	-	-13.19	
High	2462	-13.73	-	-13.73	

Test Data

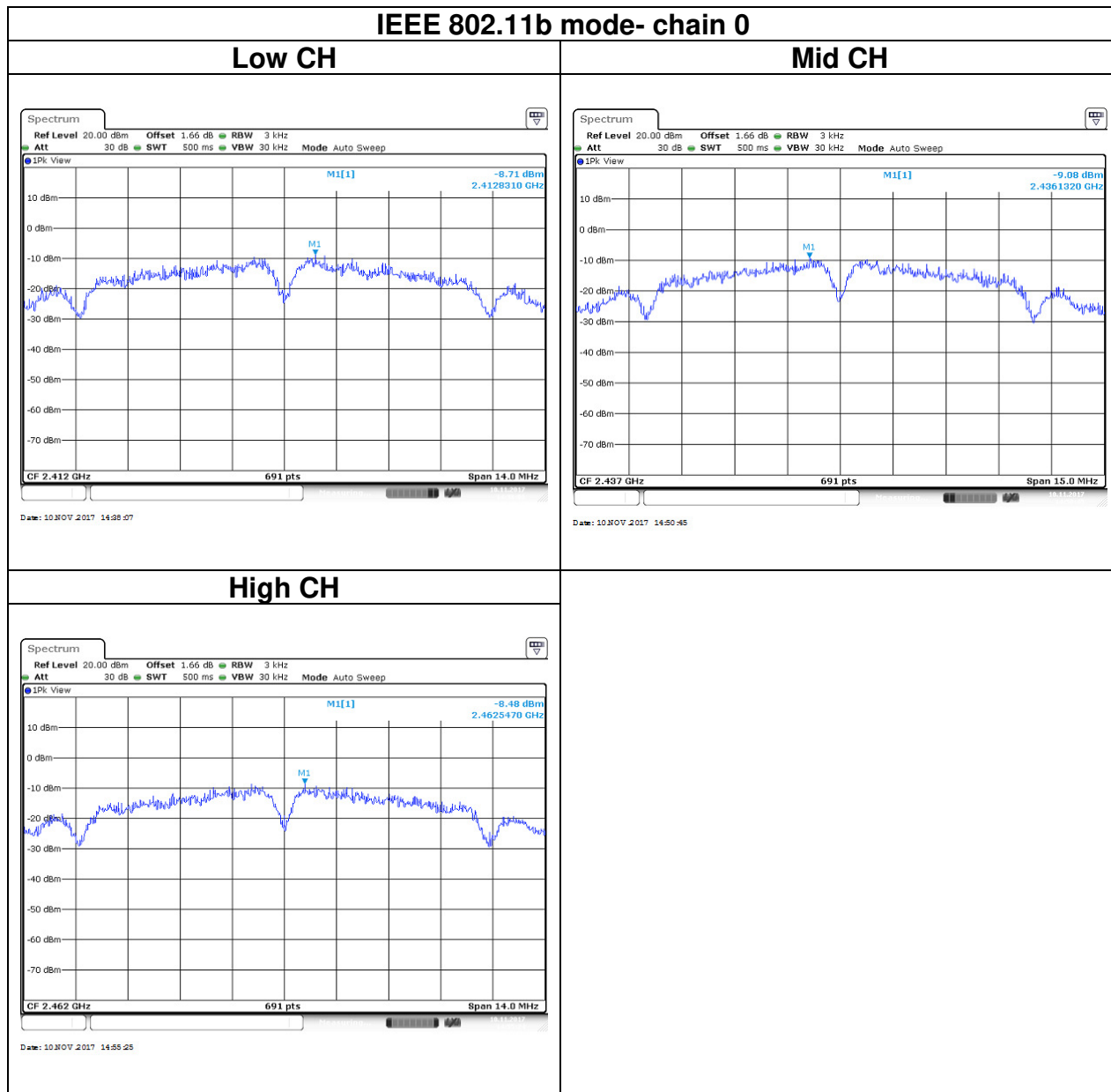

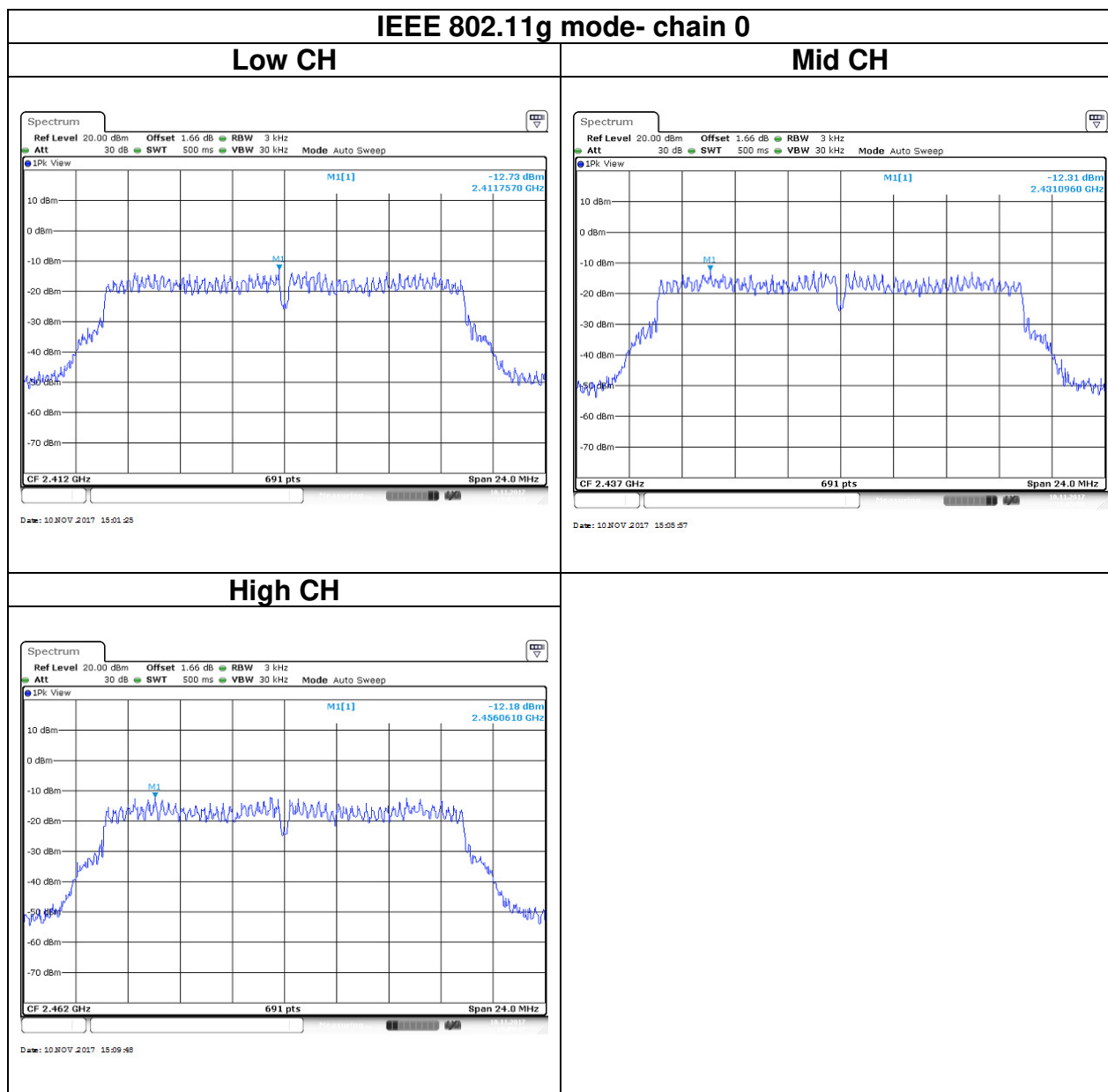

IEEE 802.11n HT20 mode- chain 0

Low CH

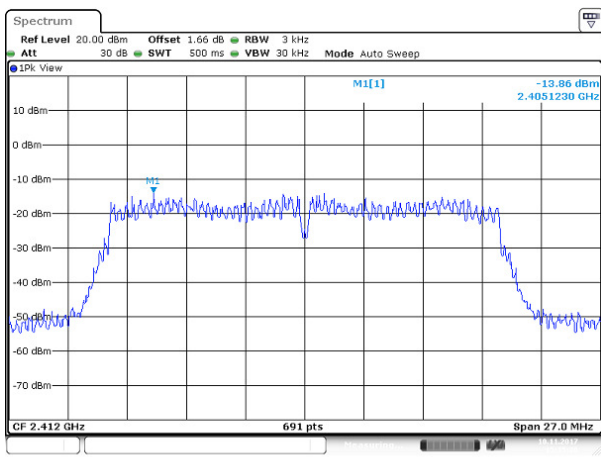

Date: 10 NOV 2017 15:55:27

Mid CH

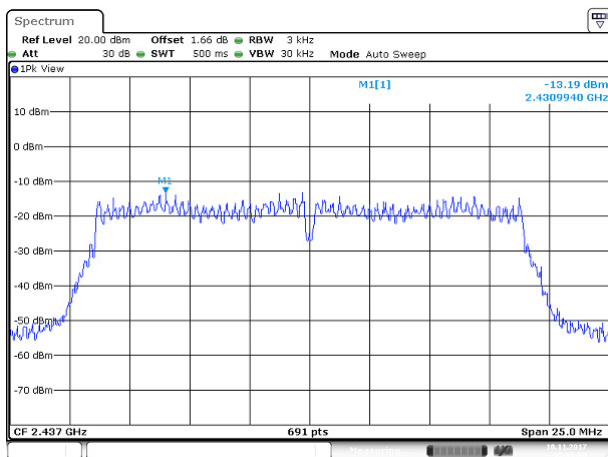

Date: 10 NOV 2017 15:59:51

High CH

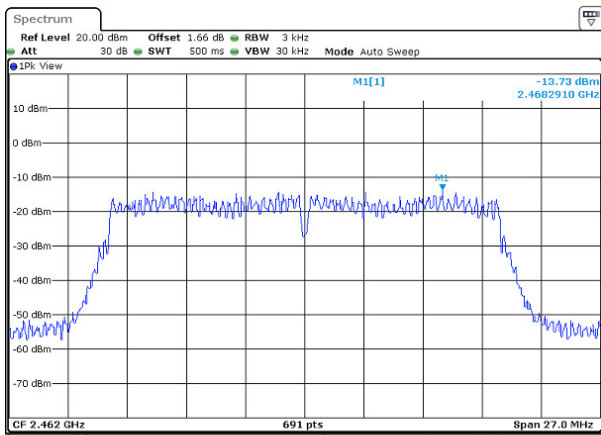

Date: 10 NOV 2017 15:23:42

4.5 CONDUCTED BANDEDGE AND SPURIOUS EMISSION

4.5.1 Test Limit

According to §15.247(d)

In any 100 kHz bandwidth outside the authorized frequency band,

Non-restricted bands shall be attenuated at least 20 dB/30 dB relative to the maximum PSD level in 100 kHz by RF conducted or a radiated measurement which fall in the restricted bands, as defined in §15.205(a), must also comply with the radiated emission limits specified in §15.209(a).

4.5.2 Test Procedure

Test method Refer as KDB 558074 D01 v04, Section 11.

1. EUT RF output port connected to the SA by RF cable, and the path loss was compensated to result.
2. SA setting, RBW=100kHz, VBW=300kHz, Detector=Peak, Trace mode = max hold, SWT = Auto.
3. In any 100 kHz bandwidth outside the authorized frequency band, shall be attenuated at least 20 dB relative to the maximum in-band peak PSD level in 100 kHz when conducted power procedure is used. If the transmitter complies with the conducted power limits based on the use of RMS averaging over a time interval, the attenuation required under this paragraph shall be 30 dB instead of 20 dB.

4.5.3 Test Setup

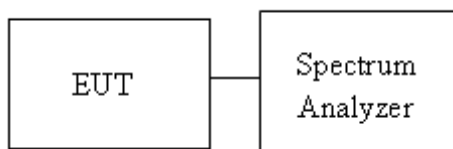

4.5.4 Test Result

Test Data

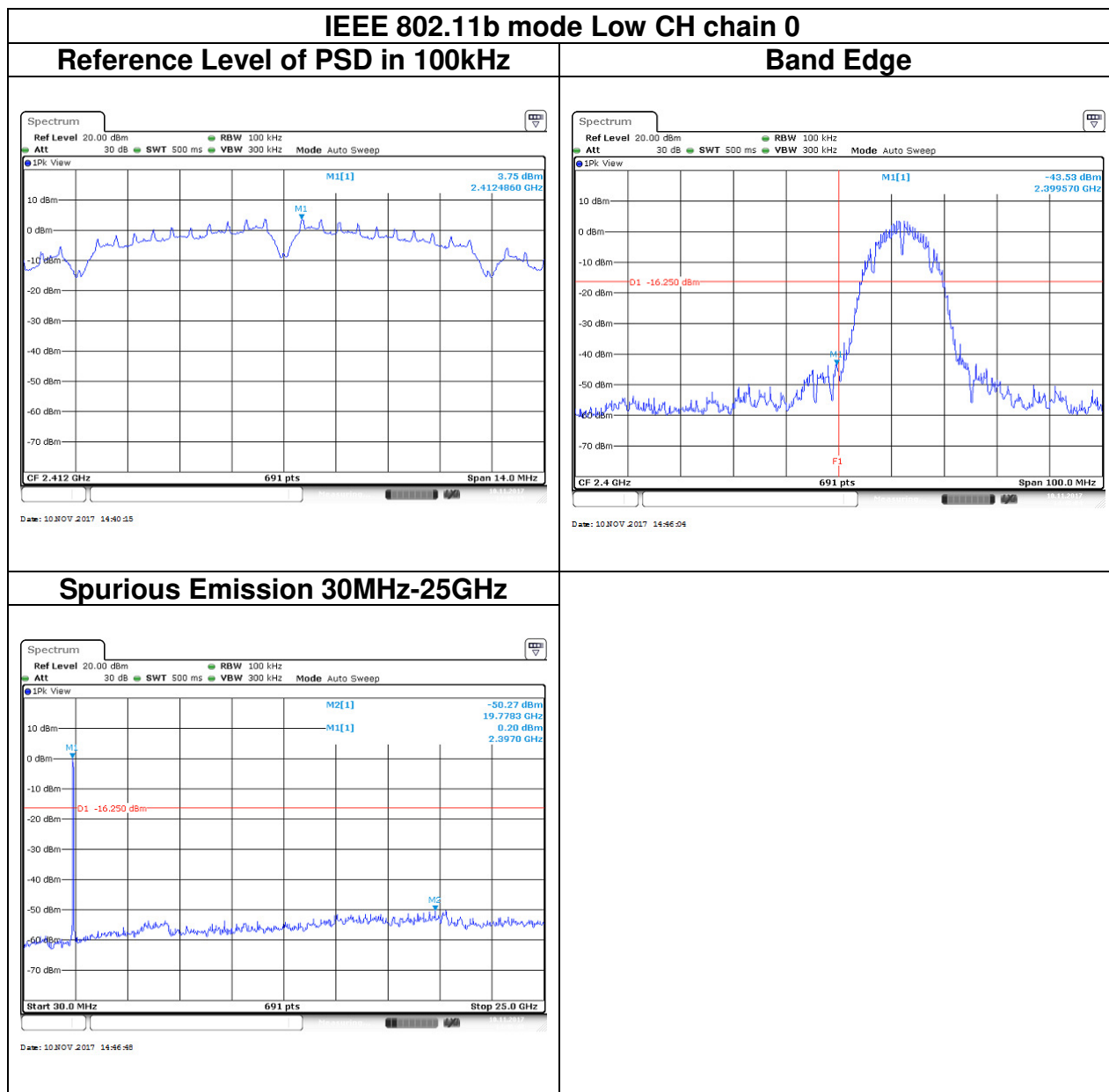

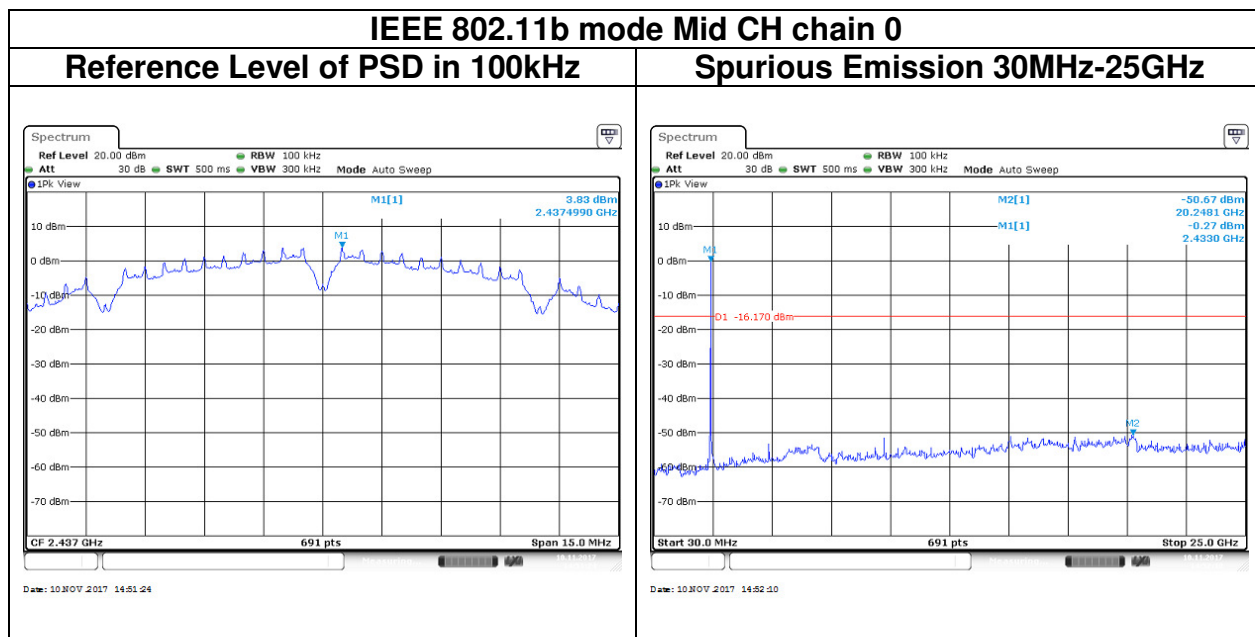

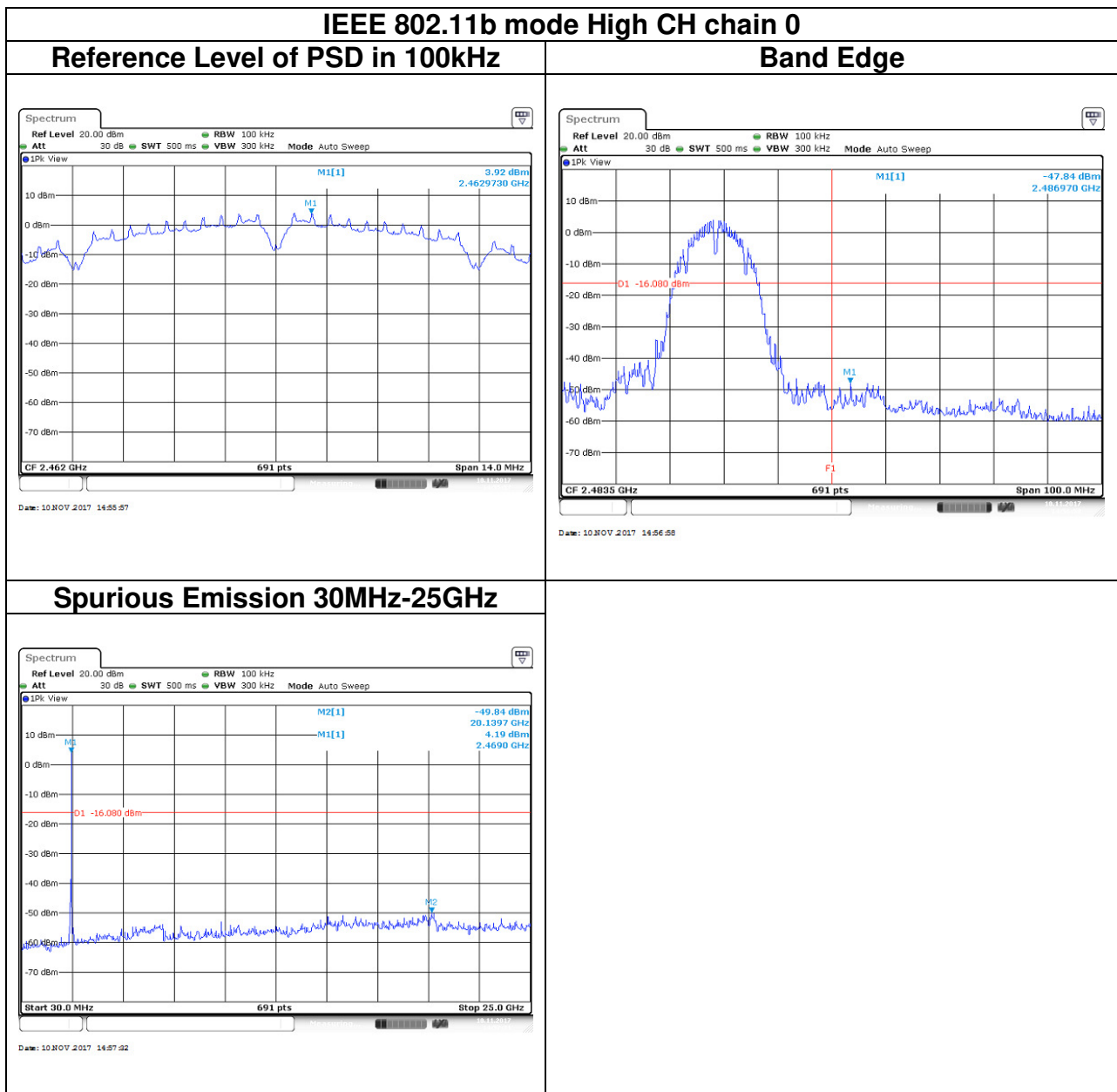

IEEE 802.11g mode Low CH chain 0

Reference Level of PSD in 100kHz

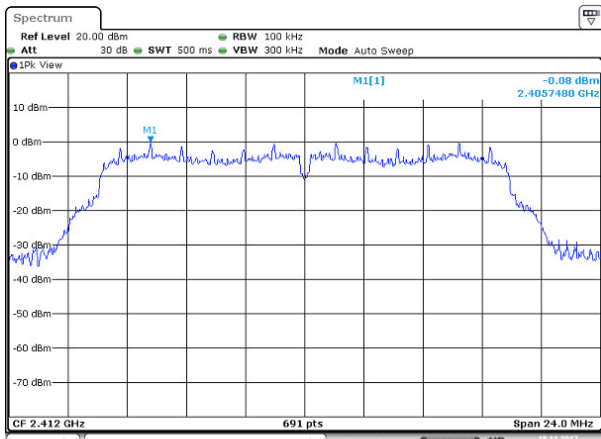

Date: 10 NOV 2017 15:01:54

Band Edge

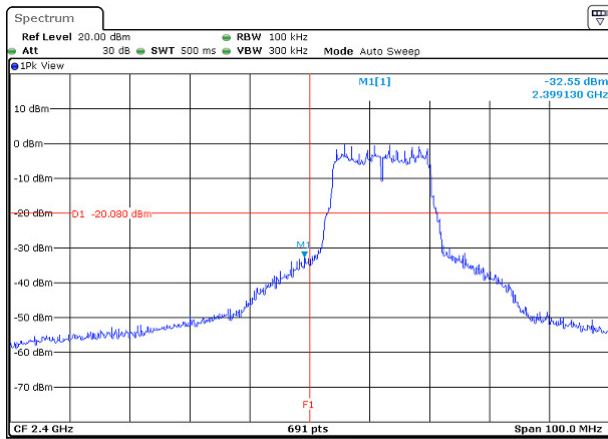

Date: 10 NOV 2017 15:02:49

Spurious Emission 30MHz-25GHz

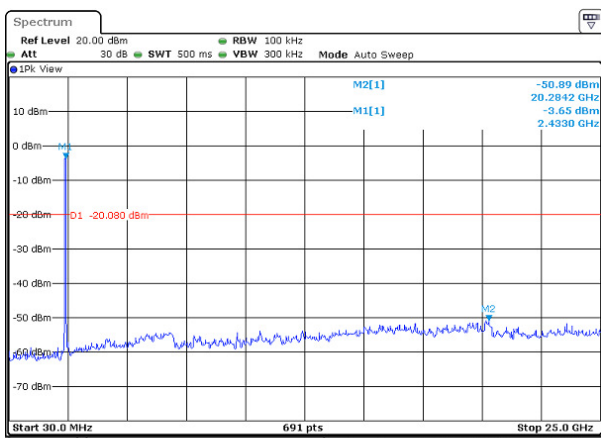

Date: 10 NOV 2017 15:03:20

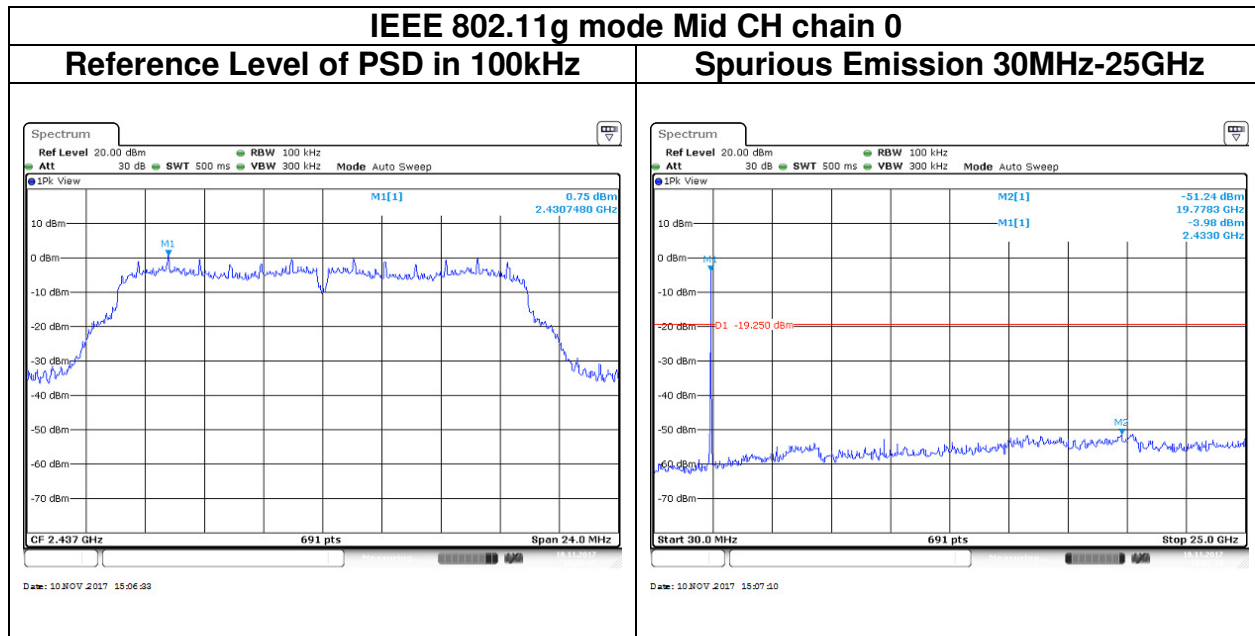

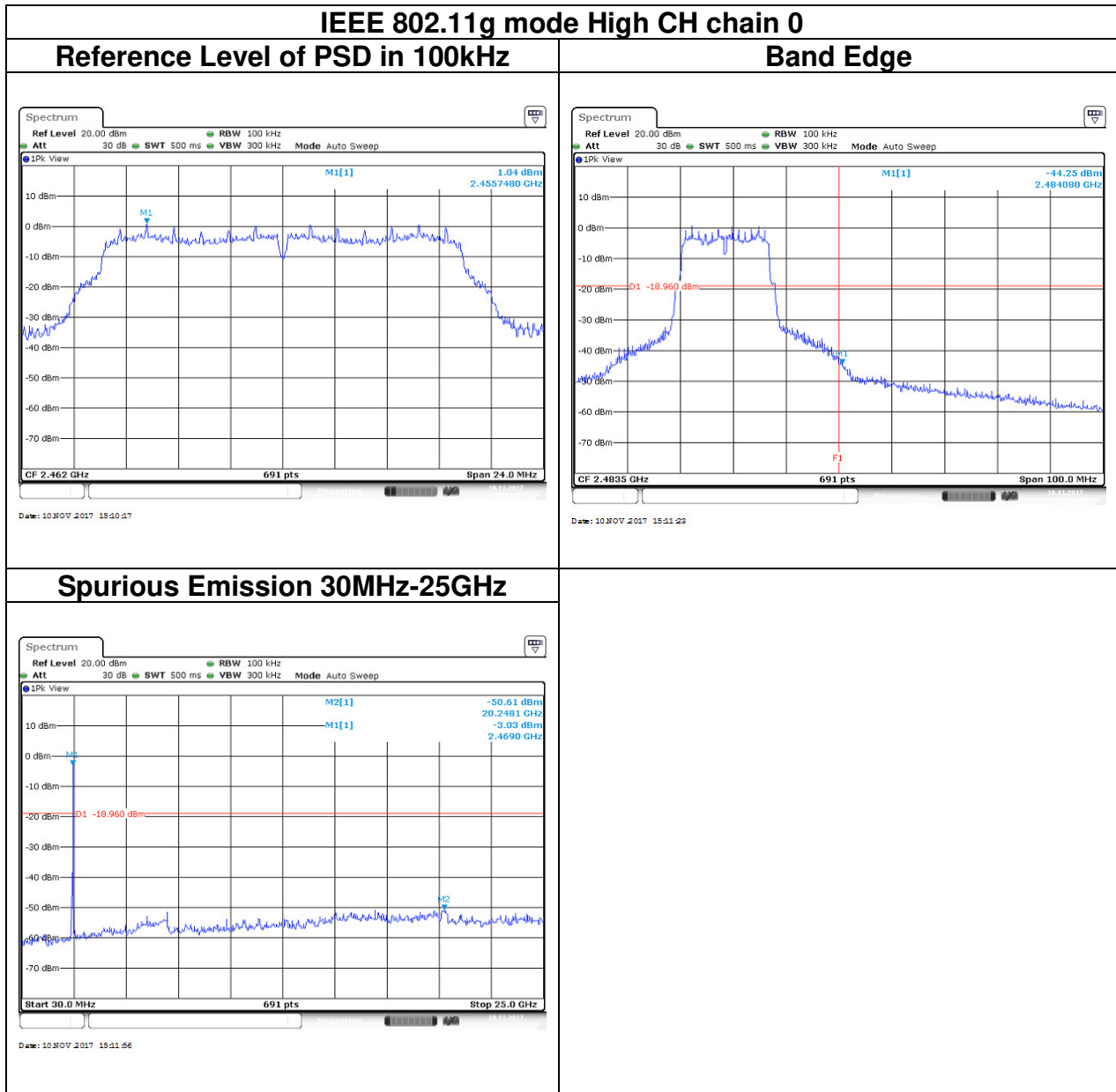

IEEE 802.11 n HT20 mode Low CH chain 0

Reference Level of PSD in 100kHz

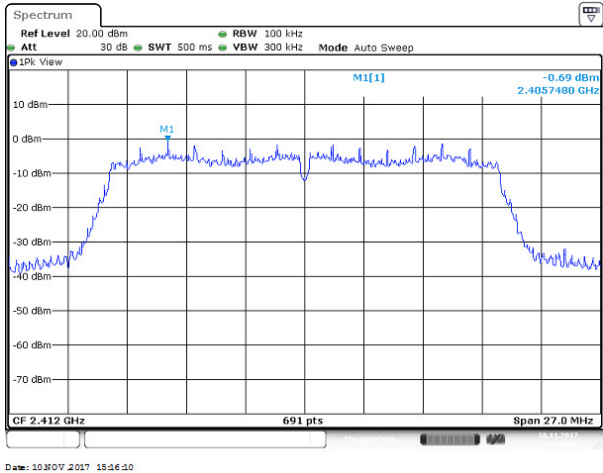

Band Edge

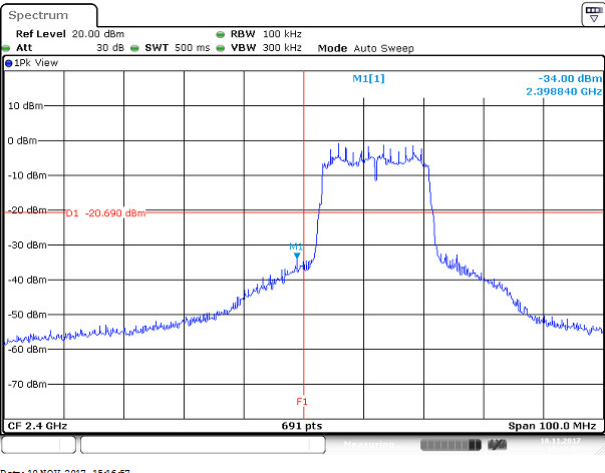

Spurious Emission 30MHz-25GHz

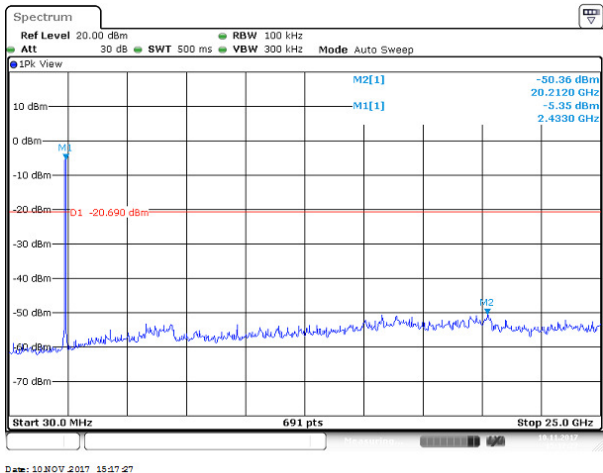

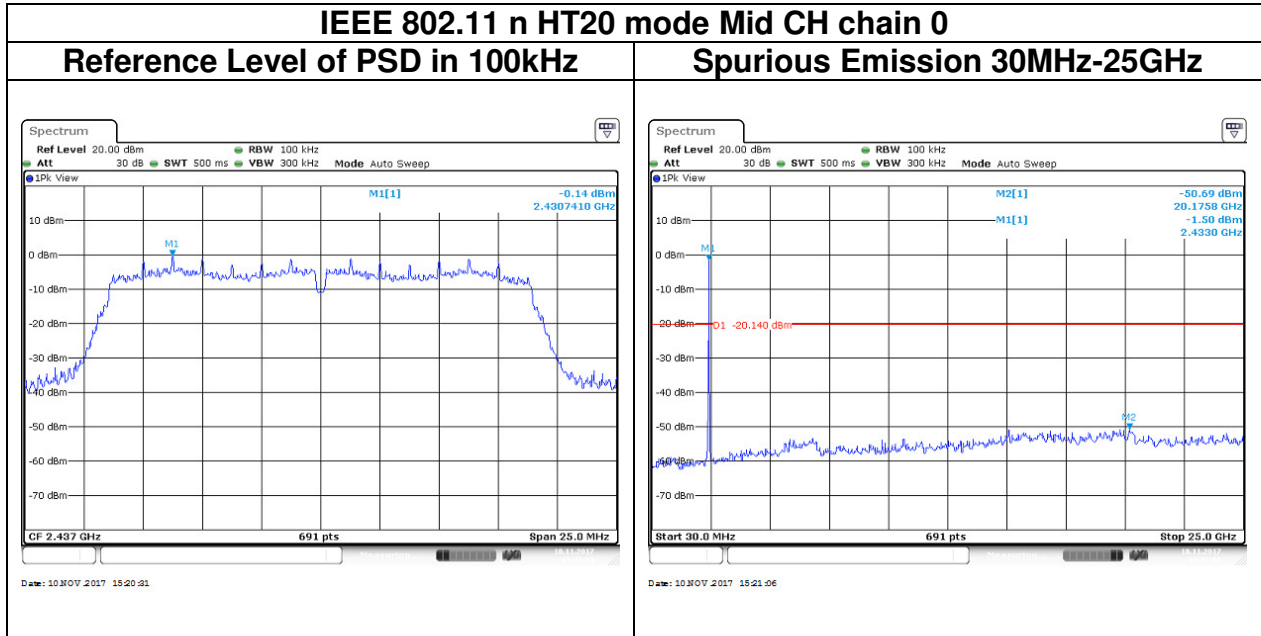

IEEE 802.11n HT20 mode High CH chain 0

Reference Level of PSD in 100kHz

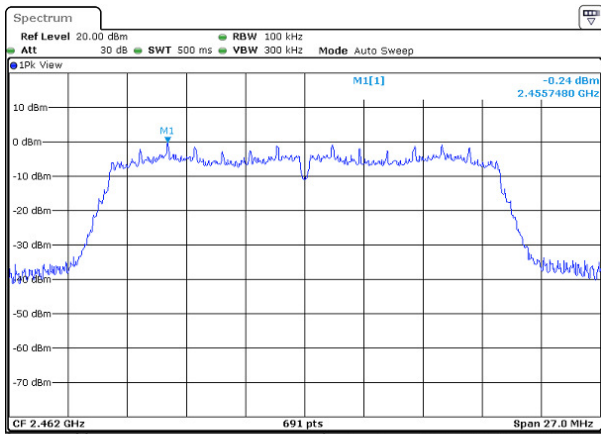

Date: 10 NOV 2017 15:24:49

Band Edge

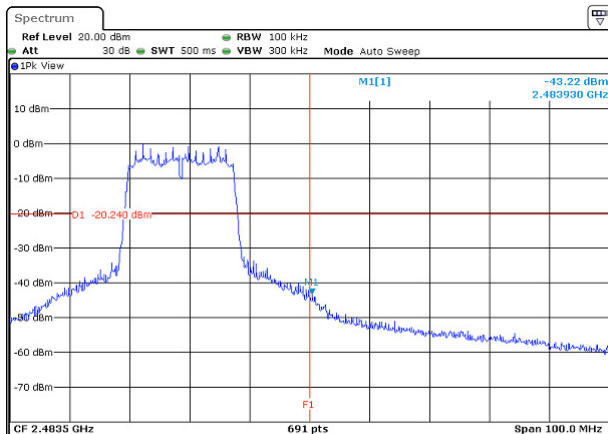

Date: 10 NOV 2017 15:25:28

Spurious Emission 30MHz-25GHz

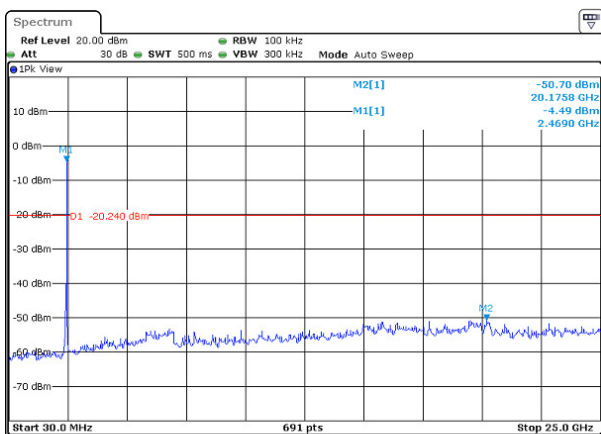

Date: 10 NOV 2017 15:26:09

4.6 RADIATION BANDEDGE AND SPURIOUS EMISSION

4.6.1 Test Limit

FCC according to §15.247(d), §15.209 and §15.205,

In any 100 kHz bandwidth outside the authorized frequency band, all harmonic and spurious must be least 20 dB below the highest emission level with the authorized frequency band. Radiation emission which fall in the restricted bands must also follow the FCC section 15.209 as below limit in table.

Below 30 MHz

Frequency	Field Strength (microvolts/m)	Magnetic H-Field (microamperes/m)	Measurement Distance (metres)
9-490 kHz	2,400/F (F in kHz)	2,400/F (F in kHz)	300
490-1,705 kHz	24,000/F (F in kHz)	24,000/F (F in kHz)	30
1.705-30 MHz	30	N/A	30

Above 30 MHz

Frequency	Field Strength (microvolts/m)	Measurement Distance (metres)
30-88	100	3
88-216	150	3
216-960	200	3
Above 960	500	3

4.6.2 Test Procedure

Test method Refer as KDB 558074 D01 v04, Section 12.1.

1. The EUT is placed on a turntable, Above 1 GHz is 1.5m and below 1 GHz is 0.8m above ground plane. The EUT Configured un accordance with ANSI C63.10, and the EUT set in a continuous mode.
2. The turntable shall be rotated for 360 degrees to determine the position of maximum emission level. And EUT is set 3m away from the receiving antenna, which is scanned from 1m to 4m above the ground plane to find out the highest emissions. Measurement are made polarized in both the vertical and the horizontal positions with antenna.
3. Span shall wide enough to full capture the emission measured. The SA from 9kHz to 26.5GHz set to the low, Mid and High channels with the EUT transmit.

Note: No emission found between lowest internal used/generated frequency to 30MHz (9KHz~30MHz)

5. The SA setting following :

- (1) Below 1G : RBW = 100kHz, VBW \geq 3 RBW, Sweep = Auto, Detector = Peak, Trace = Max hold.
- (2) Above 1G :
 - (2.1) For Peak measurement : RBW = 1MHz, VBW \geq 3 RBW, Sweep = Auto, Detector = Peak, Trace = Max hold.
 - (2.2) For Average measurement : RBW = 1MHz, VBW
 - If Duty Cycle \geq 98%, VBW=10Hz.
 - If Duty Cycle < 98%, VBW=1/T.

Configuration	Duty Cycle (%)	T(ms)	1/T (kHz)	VBW Setting
802.11b	99%	8.4400	-	300Hz
802.11g	95%	1.4500	0.690	750Hz
802.11n HT20	94%	1.3300	0.752	820Hz

4.6.3 Test Setup

9kHz ~ 30MHz

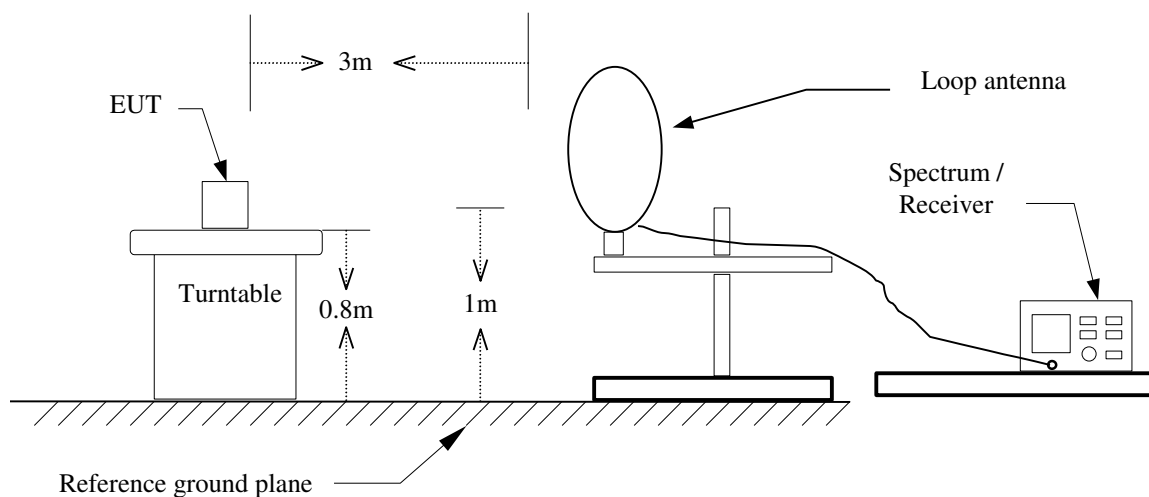

30MHz ~ 1GHz

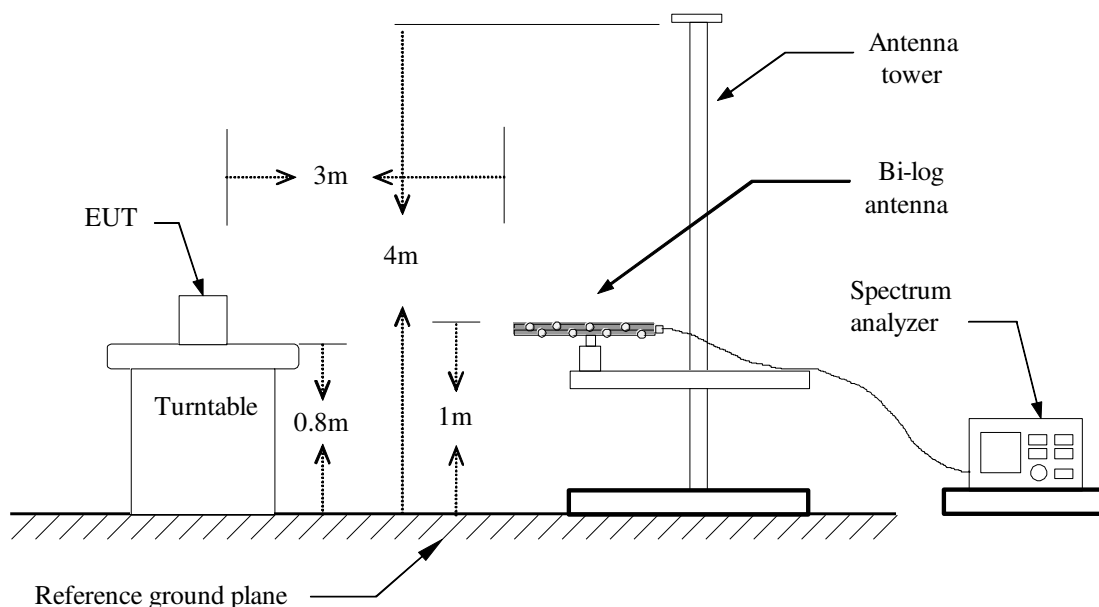

Above 1 GHz

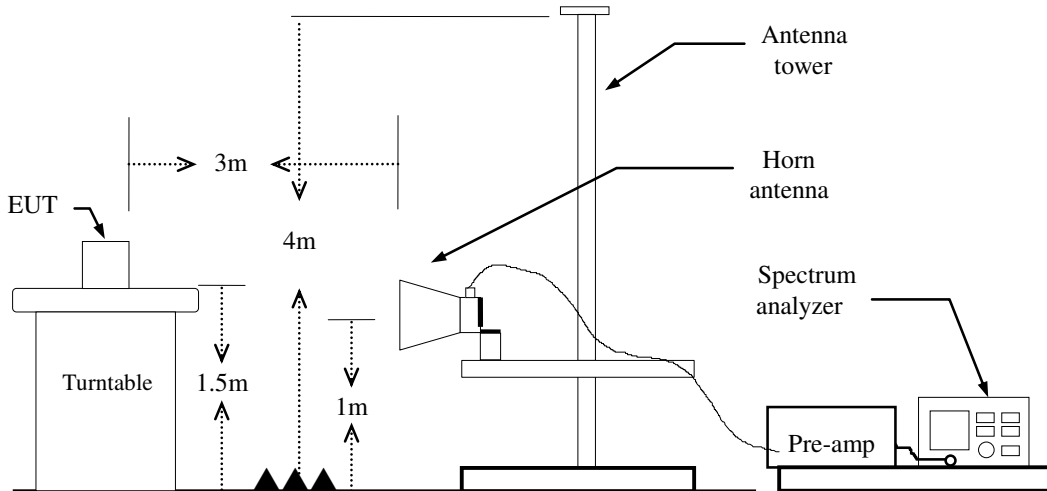

4.6.4 Test Result

Band Edge Test Data

Test Mode	IEEE 802.11b Low CH	Temp/Hum	24(°C)/ 33%RH
Test Item	Band Edge	Test Date	December 26, 2017
Polarize	Horizontal	Test Engineer	Jerry Chuang
Detector	Peak	Test Voltage	120V



Frequency (MHz)	Reading (dBuV)	Correct Factor (dB/m)	Result (dBuV/m)	Limit (dBuV/m)	Margin (dB)	Remark
2375.072	57.98	-3.02	54.96	74.00	-19.04	peak
2412.144	108.24	-2.91	105.33	-	-	peak

Test Mode	IEEE 802.11b Low CH	Temperature:	24(°C)/ 33%RH
Test Item	Band Edge	Test Date	December 26, 2017
Polarize	Horizontal	Test Engineer	Jerry Chuang
Detector	Average	Test Voltage	120V

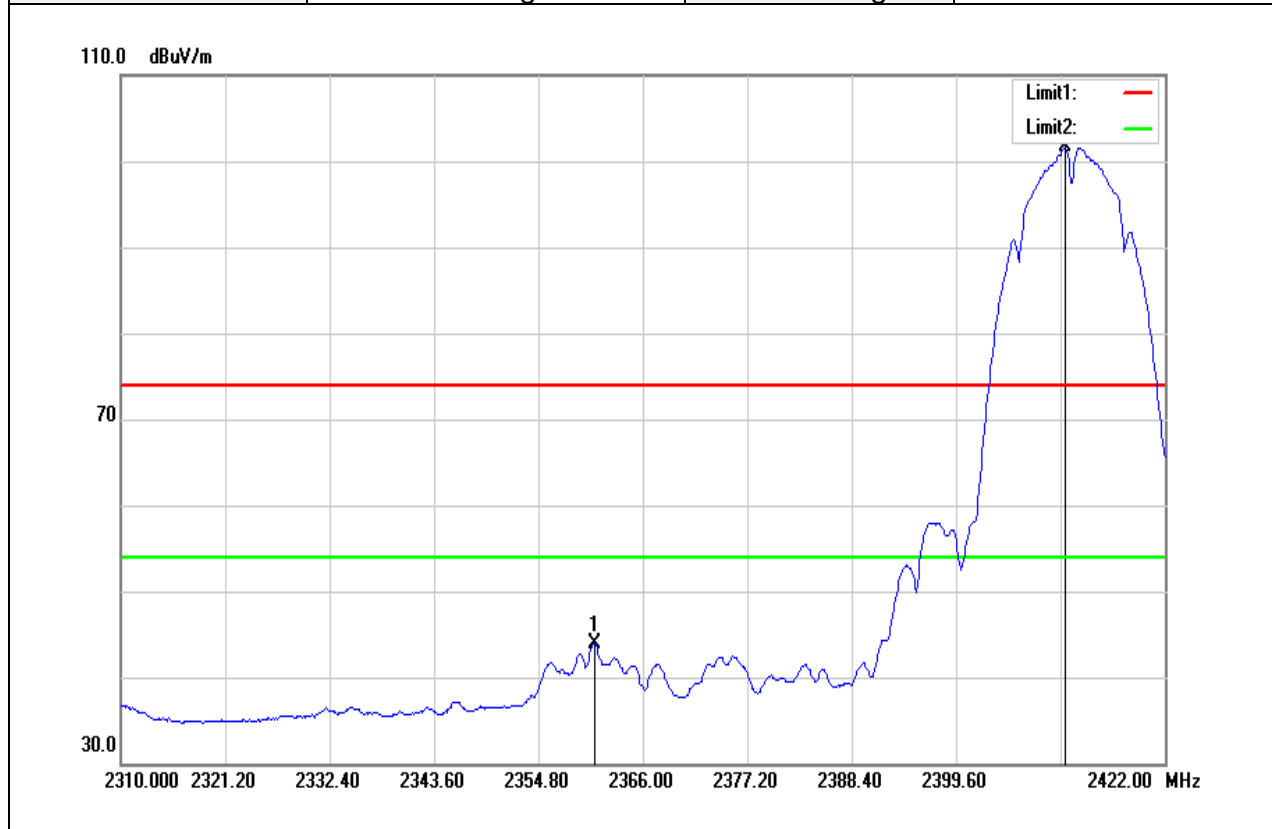

Frequency (MHz)	Reading (dBuV)	Correct Factor (dB/m)	Result (dBuV/m)	Limit (dBuV/m)	Margin (dB)	Remark
2360.848	47.07	-3.08	43.99	54.00	-10.01	AVG
2411.248	104.53	-2.92	101.61	-	-	AVG

Test Mode	IEEE 802.11b High CH	Temp/Hum	24(°C)/ 33%RH
Test Item	Band Edge	Test Date	December 26, 2017
Polarize	Horizontal	Test Engineer	Jerry Chuang
Detector	Peak	Test Voltage	120V

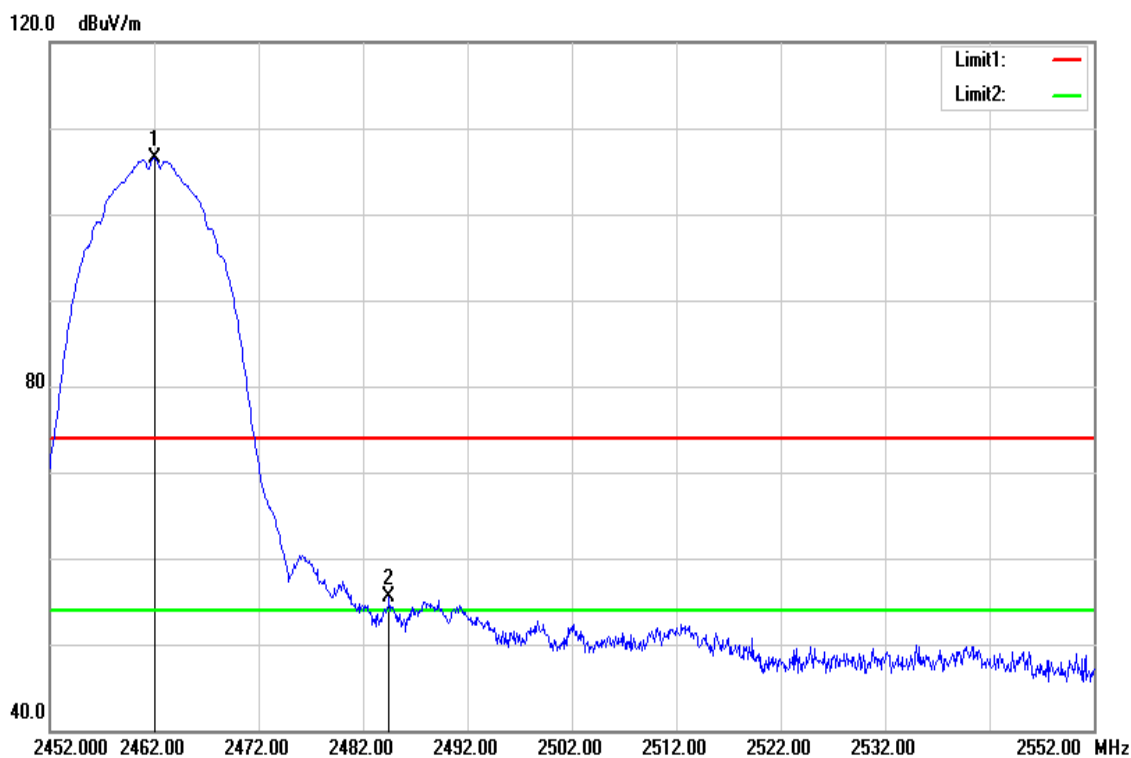

Frequency (MHz)	Reading (dBuV)	Correct Factor (d / m)	Result (dBuV/m)	Limit (dBuV/m)	Margin (dB)	Remark
2462.000	109.20	-2.76	106.44	-	-	peak
2484.500	58.23	-2.69	55.54	74.00	-18.46	peak

Test Mode	IEEE 802.11b High CH	Temperature:	24(°C)/ 33%RH
Test Item	Band Edge	Test Date	December 26, 2017
Polarize	Horizontal	Test Engineer	Jerry Chuang
Detector	Average	Test Voltage	120V

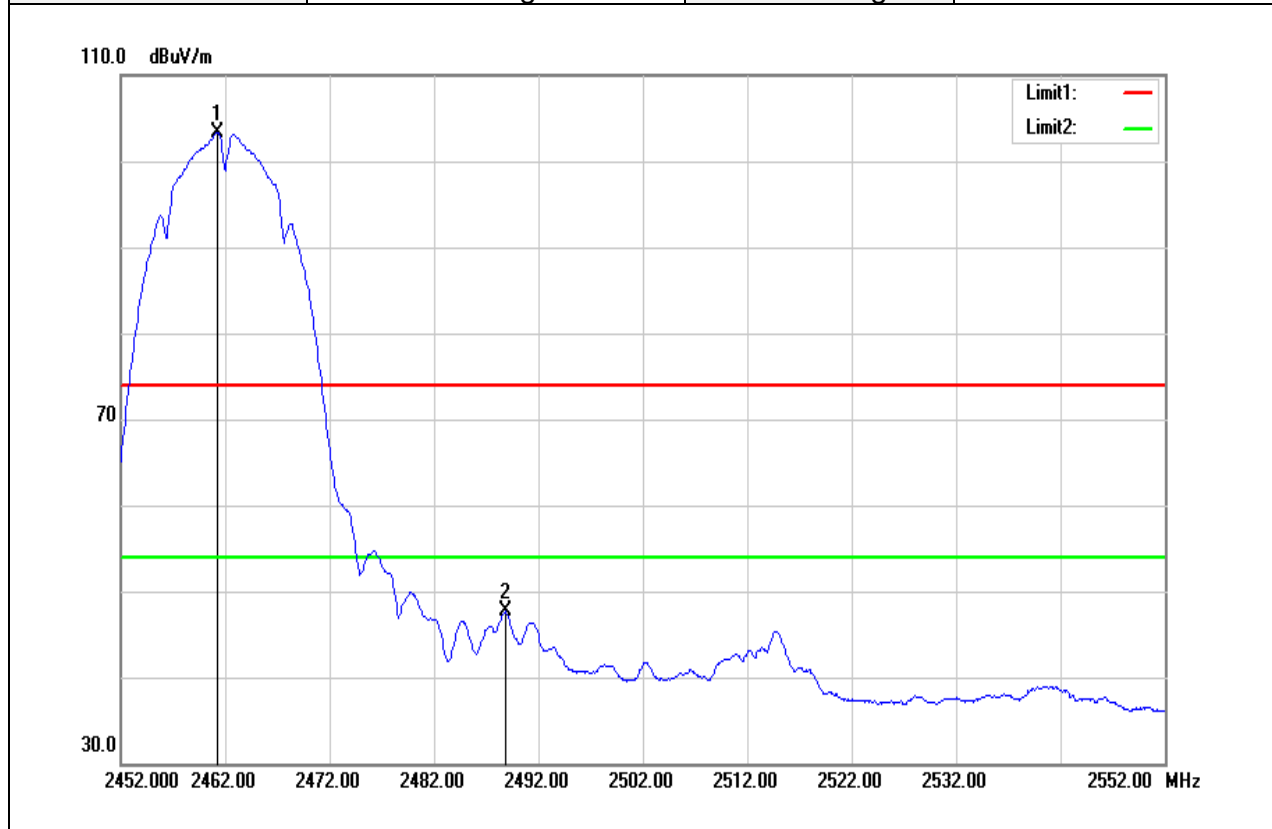

Frequency (MHz)	Reading (dBuV)	Correct Factor (dB/m)	Result (dBuV/m)	Limit (dBuV/m)	Margin (dB)	Remark
2461.300	106.12	-2.76	103.36	-	-	AVG
2488.800	50.28	-2.67	47.61	54.00	-6.39	AVG

Test Mode	IEEE 802.11g Low CH	Temp/Hum	24(°C)/ 33%RH
Test Item	Band Edge	Test Date	December 26, 2017
Polarize	Horizontal	Test Engineer	Jerry Chuang
Detector	Peak	Test Voltage	120V

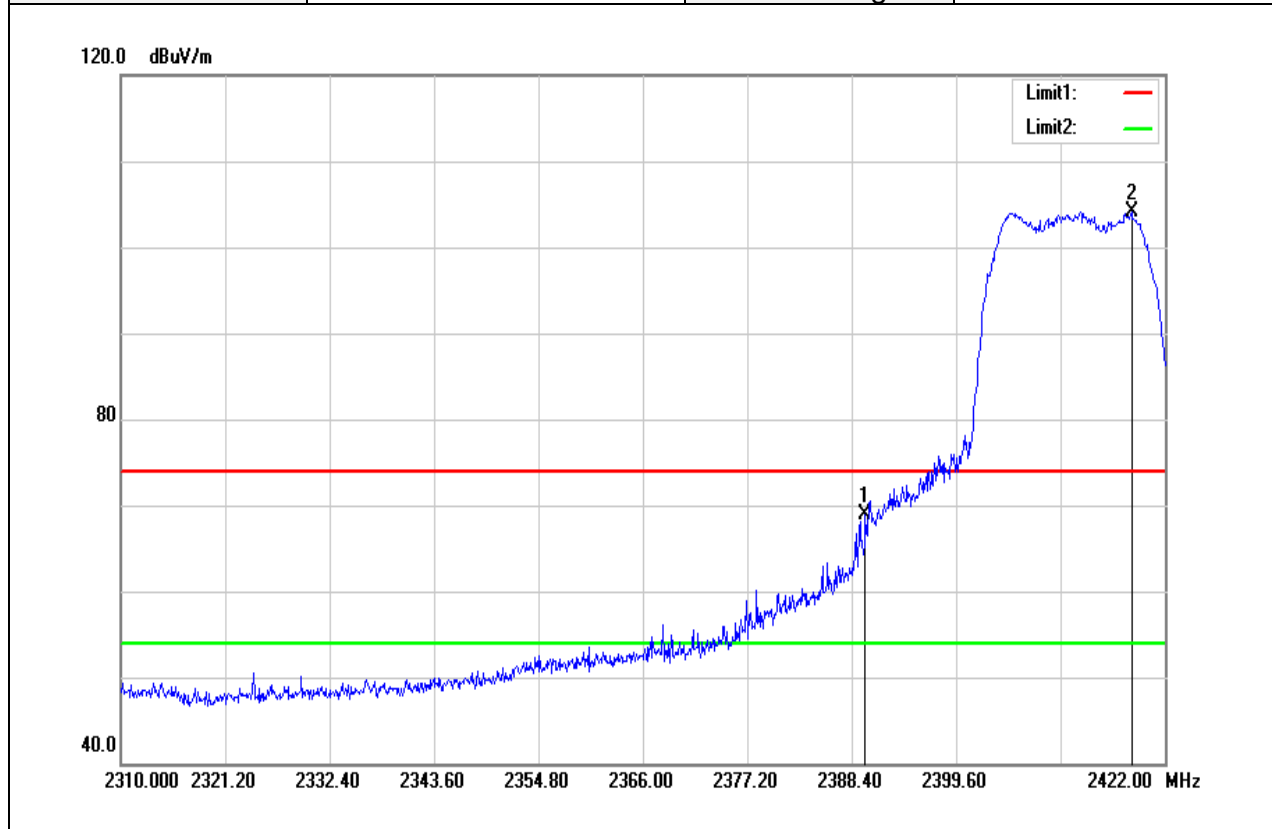

Frequency (MHz)	Reading (dBuV)	Correct Factor (dB/m)	Result (dBuV/m)	Limit (dBuV/m)	Margin (dB)	Remark
2389.856	71.88	-2.98	68.90	74.00	-5.10	peak
2418.416	106.93	-2.89	104.04	-	-	peak

Test Mode	IEEE 802.11g Low CH	Temperature:	24(°C)/ 33%RH
Test Item	Band Edge	Test Date	December 26, 2017
Polarize	Horizontal	Test Engineer	Jerry Chuang
Detector	Average	Test Voltage	120V

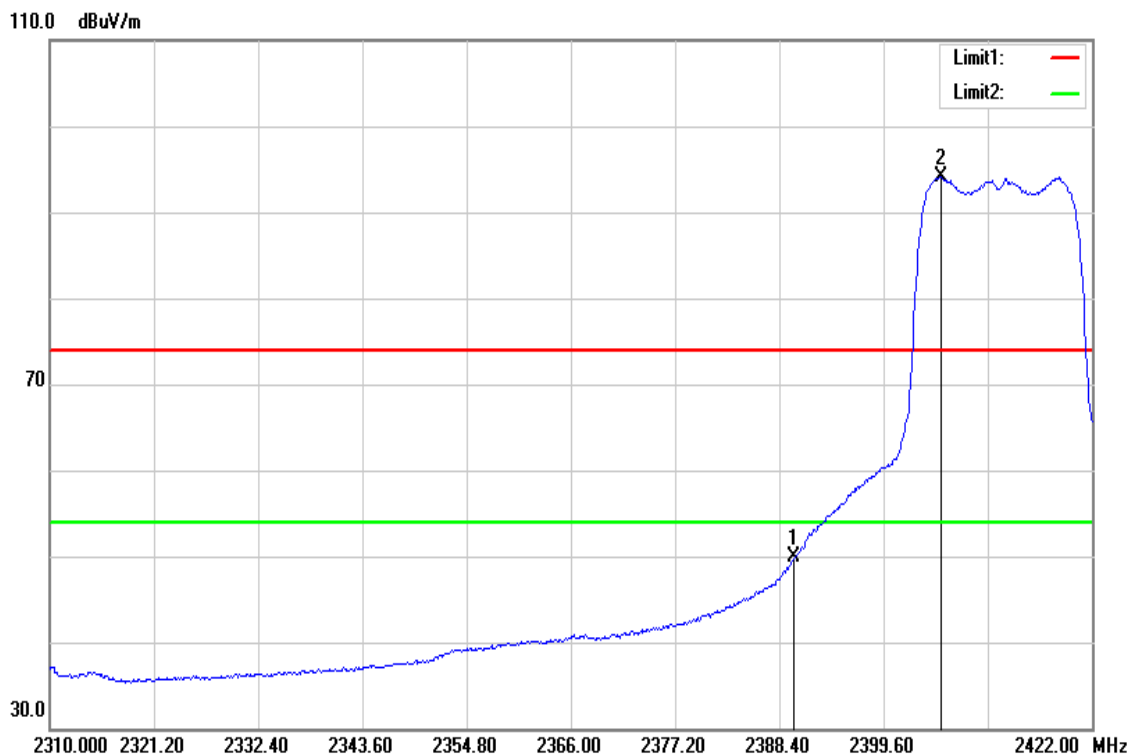

Frequency (MHz)	Reading (dBuV)	Correct Factor (dB/m)	Result (dBuV/m)	Limit (dBuV/m)	Margin (dB)	Remark
2390.000	52.94	-2.98	49.96	54.00	-4.04	AVG
2405.760	96.99	-2.93	94.06	-	-	AVG

Test Mode	IEEE 802.11g High CH	Temp/Hum	24(°C)/ 33%RH
Test Item	Band Edge	Test Date	December 26, 2017
Polarize	Horizontal	Test Engineer	Jerry Chuang
Detector	Peak	Test Voltage	120V

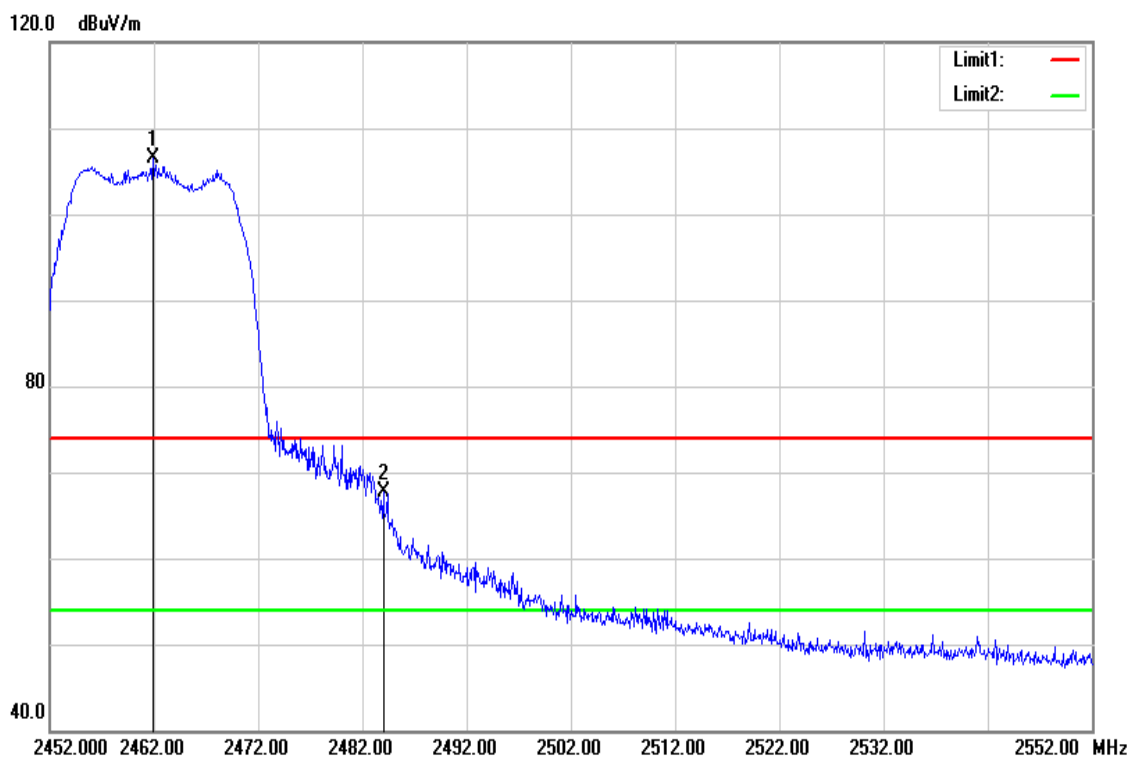

Frequency (MHz)	Reading (dBuV)	Correct Factor (dB/m)	Result (dBuV/m)	Limit (dBuV/m)	Margin (dB)	Remark
2461.900	109.17	-2.76	106.41	-	-	peak
2484.000	70.38	-2.69	67.69	74.00	-6.31	peak

Test Mode	IEEE 802.11g High CH	Temperature:	24(°C)/ 33%RH
Test Item	Band Edge	Test Date	December 26, 2017
Polarize	Horizontal	Test Engineer	Jerry Chuang
Detector	Average	Test Voltage	120V

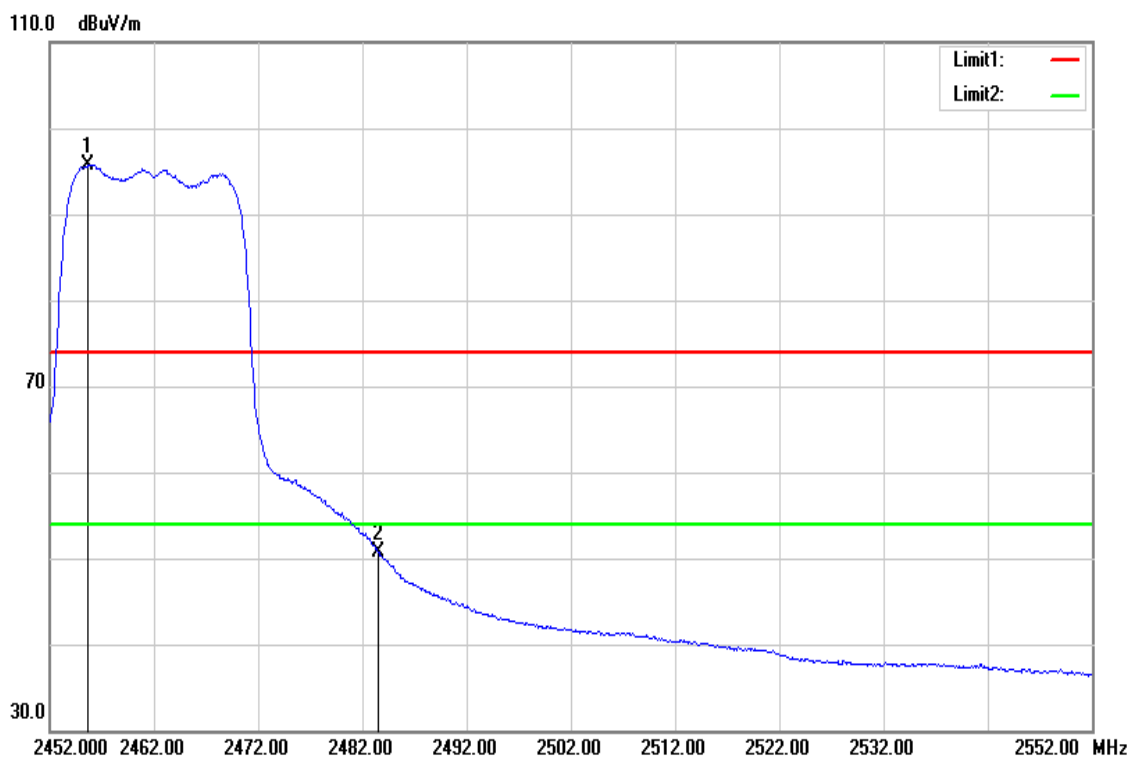

Frequency (MHz)	Reading (dBuV)	Correct Factor (dB/m)	Result (dBuV/m)	Limit (dBuV/m)	Margin (dB)	Remark
2455.700	98.49	-2.78	95.71	-	-	AVG
2483.500	53.45	-2.69	50.76	54.00	-3.24	AVG

Test Mode	IEEE 802.11n HT20 Low CH	Temp/Hum	24(°C)/ 33%RH
Test Item	Band Edge	Test Date	December 26, 2017
Polarize	Horizontal	Test Engineer	Jerry Chuang
Detector	Peak	Test Voltage	120V

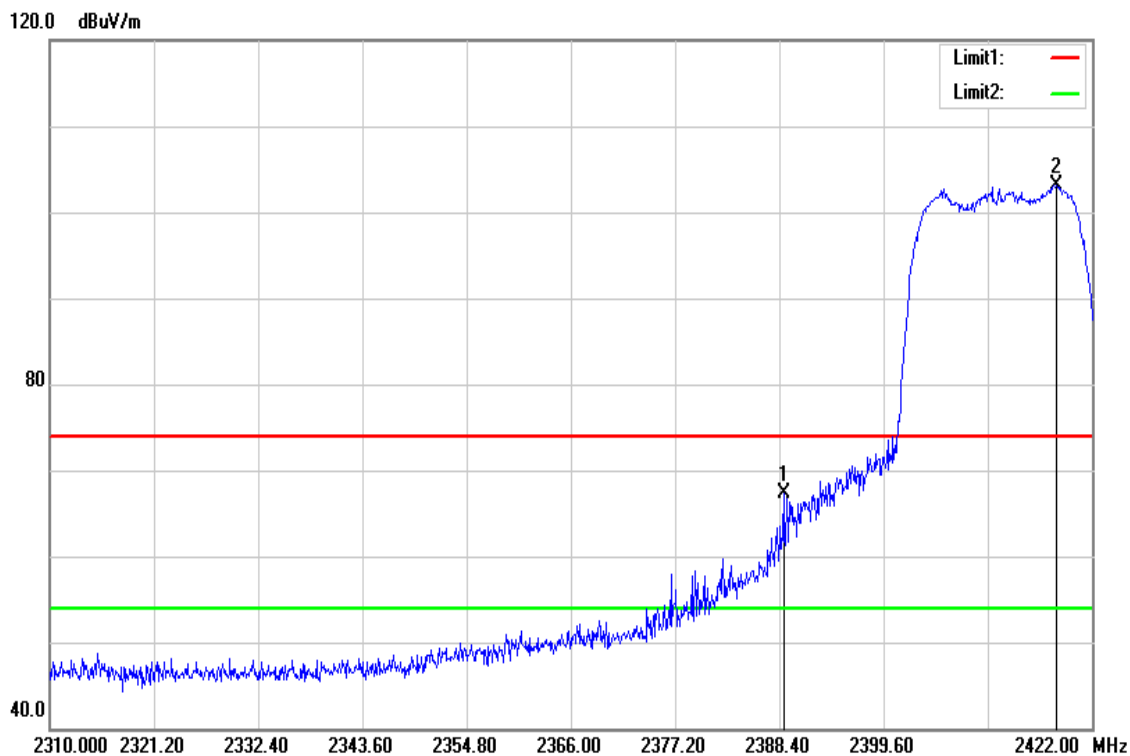

Frequency (MHz)	Reading (dBuV)	Correct Factor (dB/m)	Result (dBuV/m)	Limit (dBuV/m)	Margin (dB)	Remark
2388.848	70.24	-2.98	67.26	74.00	-6.74	peak
2418.192	106.00	-2.89	103.11	-	-	peak

Test Mode	IEEE 802.11n HT20 Low CH	Temperature:	24(°C)/ 33%RH
Test Item	Band Edge	Test Date	December 26, 2017
Polarize	Horizontal	Test Engineer	Jerry Chuang
Detector	Average	Test Voltage	120V

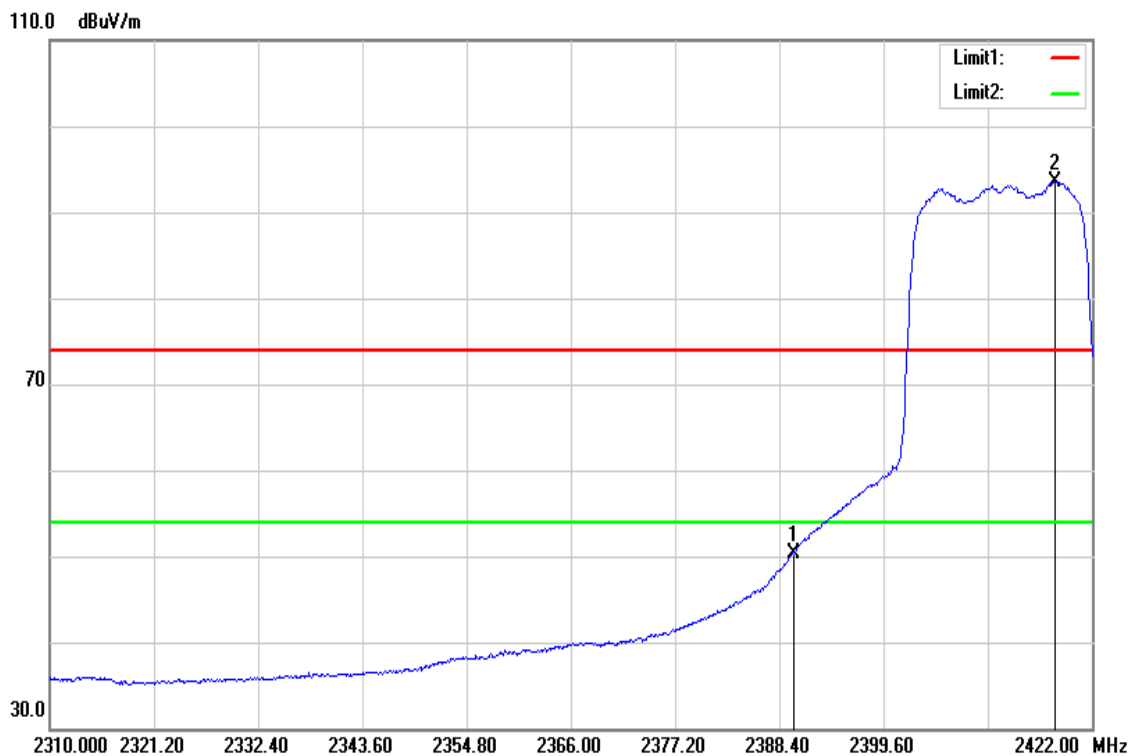

Frequency (MHz)	Reading (dBuV)	Correct Factor (dB/m)	Result (dBuV/m)	Limit (dBuV/m)	Margin (dB)	Remark
2390.000	53.27	-2.98	50.29	54.00	-3.71	AVG
2418.080	96.47	-2.89	93.58	-	-	AVG

Test Mode	IEEE 802.11n HT20 High CH	Temp/Hum	24(°C)/ 33%RH
Test Item	Band Edge	Test Date	December 26, 2017
Polarize	Horizontal	Test Engineer	Jerry Chuang
Detector	Peak	Test Voltage	120V

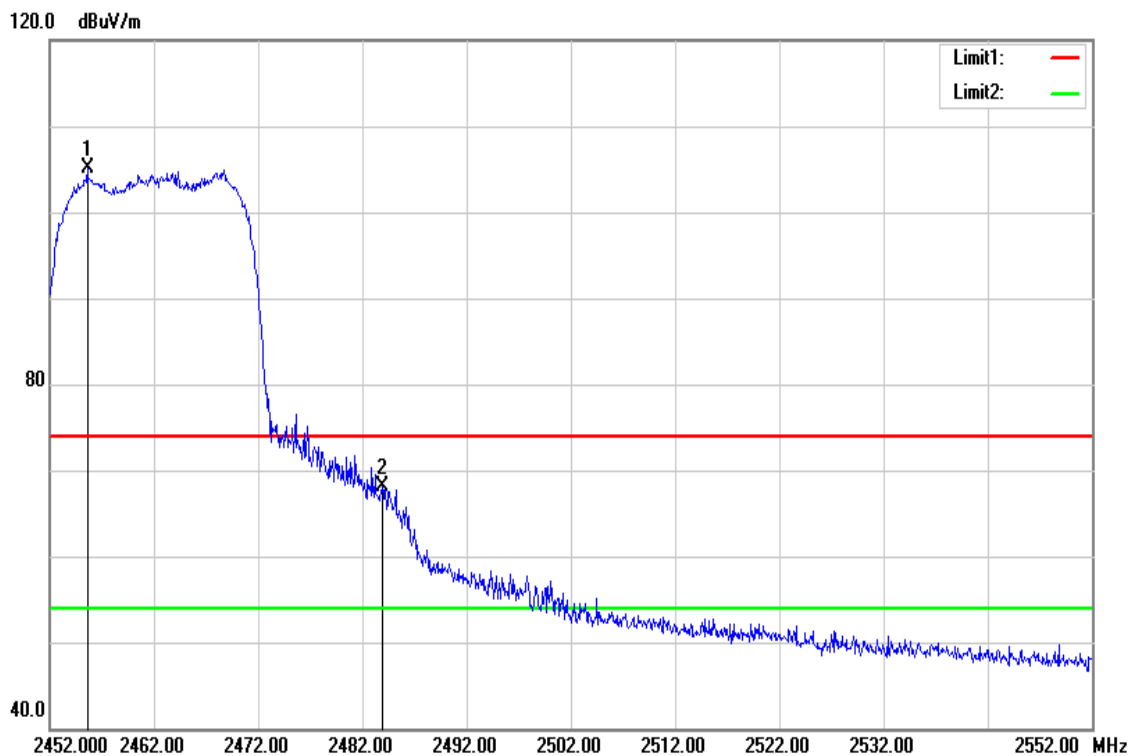

Frequency (MHz)	Reading (dBuV)	Correct Factor (dB/m)	Result (dBuV/m)	Limit (dBuV/m)	Margin (dB)	Remark
2455.600	107.89	-2.78	105.11	-	-	peak
2483.900	70.74	-2.69	68.05	74.00	-5.95	peak

Test Mode	IEEE 802.11n HT20 High CH	Temperature:	24(°C)/ 33%RH
Test Item	Band Edge	Test Date	December 26, 2017
Polarize	Horizontal	Test Engineer	Jerry Chuang
Detector	Average	Test Voltage	120V

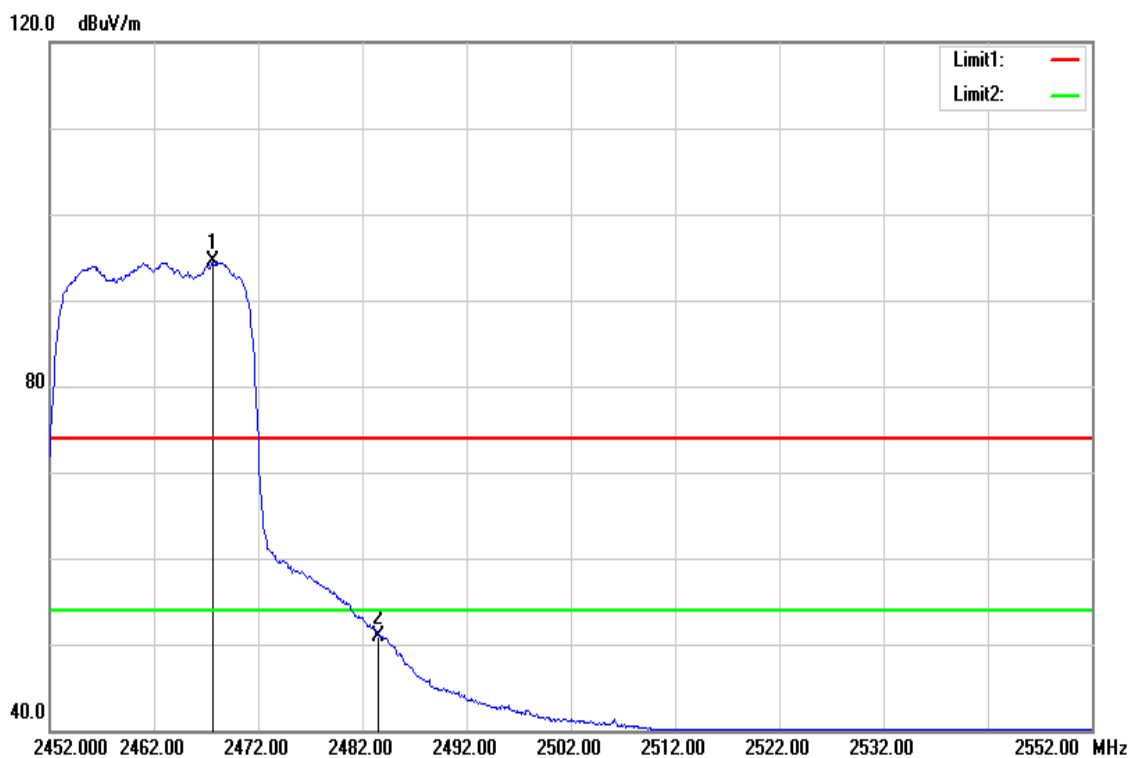

Frequency (MHz)	Reading (dBuV)	Correct Factor (dB/m)	Result (dBuV/m)	Limit (dBuV/m)	Margin (dB)	Remark
2467.700	97.29	-2.73	94.56	-	-	AVG
2483.500	53.58	-2.69	50.89	54.00	-3.11	AVG

Below 1G Test Data

Test Mode	Mode 1	Temp/Hum	24(°C)/ 33%RH
Test Item	30MHz-1GHz	Test Date	January 11, 2018
Polarize	Vertical	Test Engineer	Jerry Chuang
Detector	Peak	Test Voltage	120V

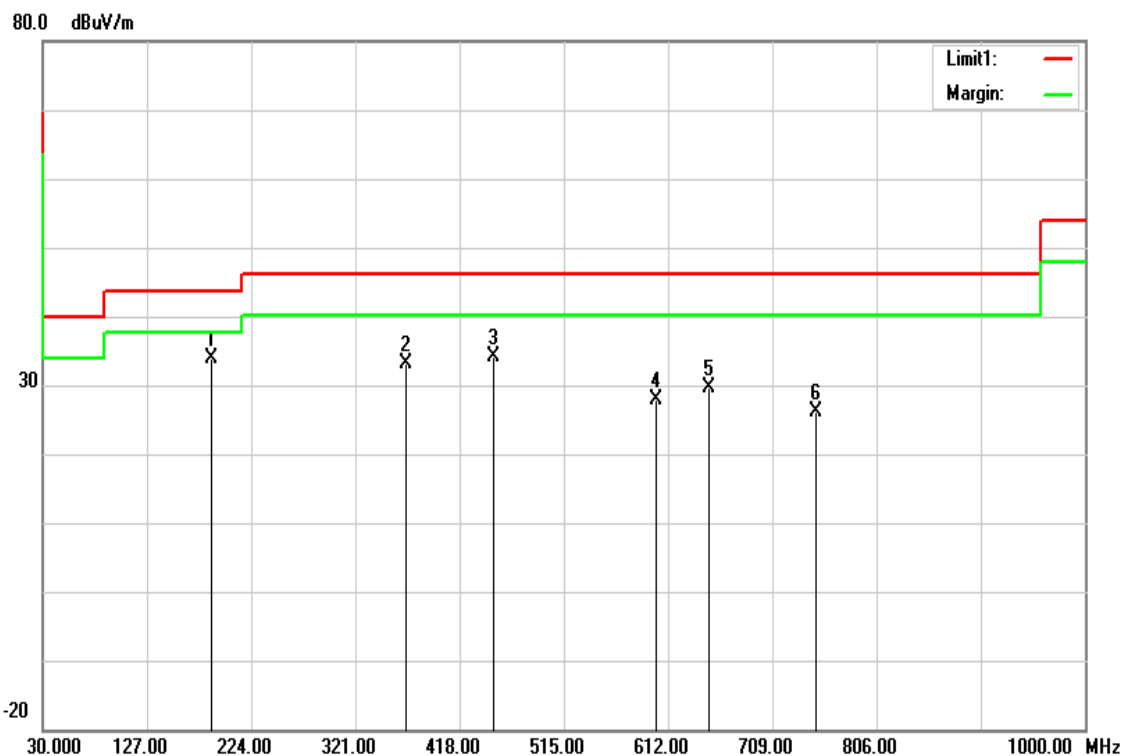

Frequency (MHz)	Reading (dBuV)	Correct Factor (dB/m)	Result (dBuV/m)	Limit (dBuV/m)	Margin (dB)	Remark
187.1400	50.46	-16.49	33.97	43.52	-9.55	peak
368.5300	45.55	-12.39	33.16	46.02	-12.86	peak
450.0100	43.77	-9.60	34.17	46.02	-11.85	peak
600.3600	34.86	-6.92	27.94	46.02	-18.08	peak
649.8300	35.30	-5.55	29.75	46.02	-16.27	peak
749.7400	30.39	-4.29	26.10	46.02	-19.92	peak

Test Mode	Mode 1	Temp/Hum	24(°C)/ 33%RH
Test Item	30MHz-1GHz	Test Date	January 11, 2018
Polarize	Horizontal	Test Engineer	Jerry Chuang
Detector	Peak	Test Voltage	120V

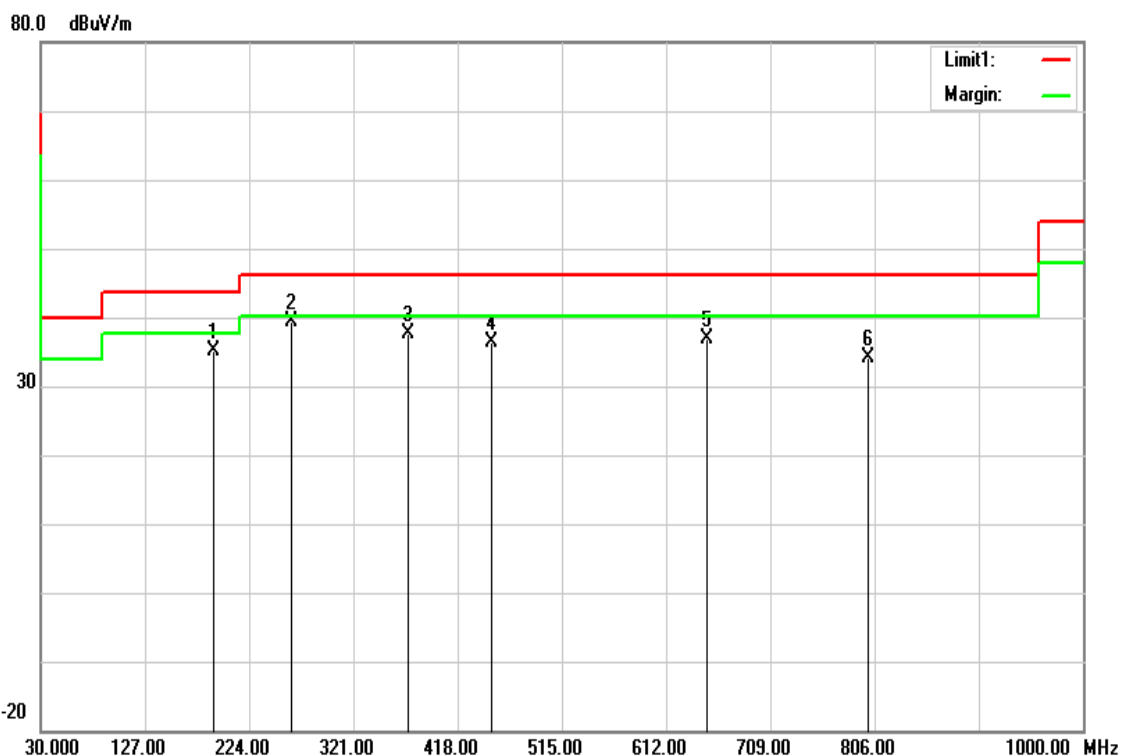

Frequency (MHz)	Reading (dBuV)	Correct Factor (dB/m)	Result (dBuV/m)	Limit (dBuV/m)	Margin (dB)	Remark
191.0200	51.32	-16.12	35.20	43.52	-8.32	QP
263.7700	54.67	-15.29	39.38	46.02	-6.64	peak
371.4400	50.01	-12.30	37.71	46.02	-8.31	peak
450.0100	46.09	-9.60	36.49	46.02	-9.53	peak
649.8300	42.51	-5.55	36.96	46.02	-9.06	peak
800.1800	37.41	-3.38	34.03	46.02	-11.99	peak

Above 1G Test Data

Test Mode	IEEE 802.11b Low CH	Temp/Hum	24(°C)/ 33%RH
Test Item	Harmonic	Test Date	December 26, 2017
Polarize	Vertical	Test Engineer	Jerry Chuang
Detector	Peak and Average	Test Voltage	120V

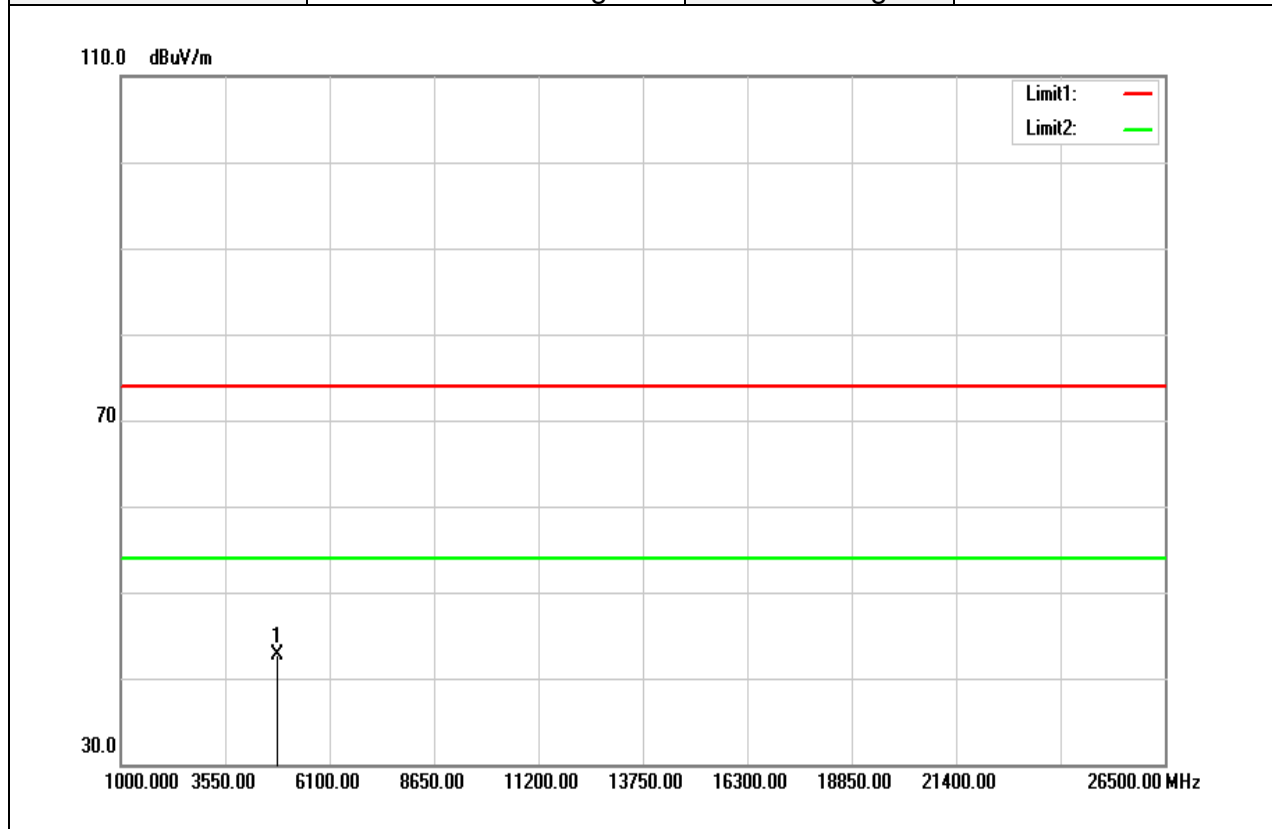

Frequency (MHz)	Reading (dBuV)	Correct Factor (dB/m)	Result (dBuV/m)	Limit (dBuV/m)	Margin (dB)	Remark
4824.000	38.23	4.38	42.61	74.00	-31.39	peak
N/A						

Remark:

1. Measuring frequencies from 1 GHz to the 10th harmonic of highest fundamental frequency.
2. For above 1GHz, the EUT peak value was under average limit, therefore the Average value compliance with the average limit

Test Mode	IEEE 802.11b Low CH	Temp/Hum	24(°C)/ 33%RH
Test Item	Harmonic	Test Date	December 26, 2017
Polarize	Horizontal	Test Engineer	Jerry Chuang
Detector	Peak and Average	Test Voltage	120V

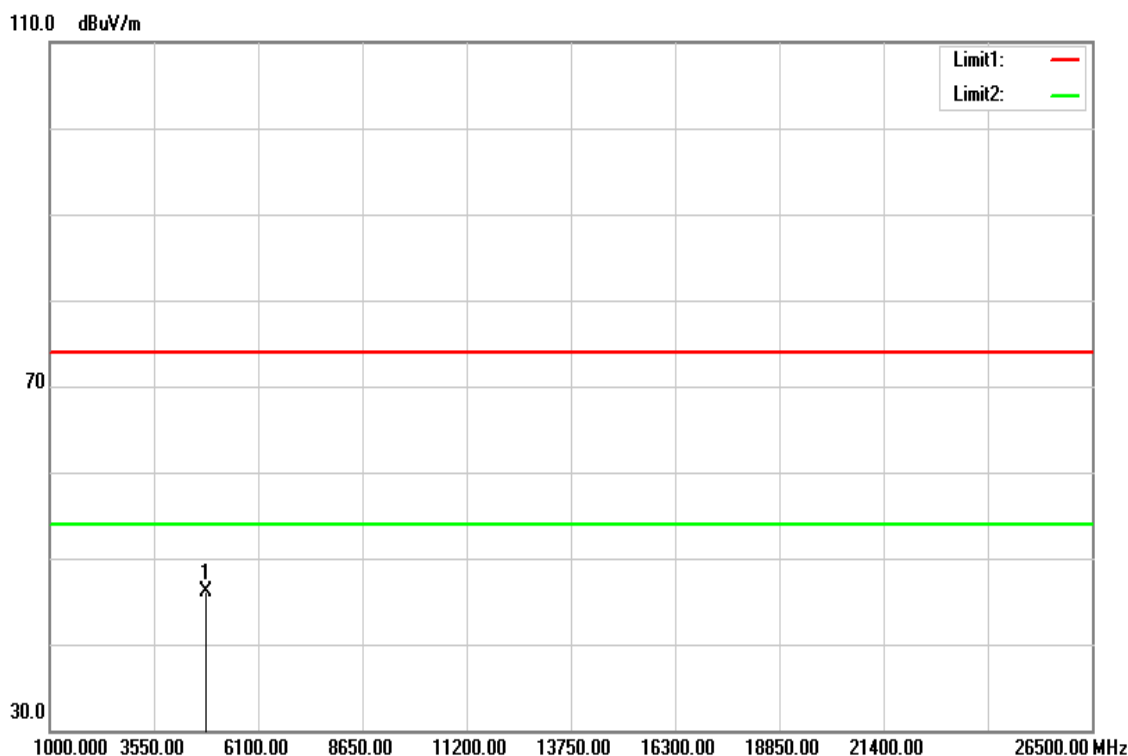

Frequency (MHz)	Reading (dBuV)	Correct Factor (dB/m)	Result (dBuV/m)	Limit (dBuV/m)	Margin (dB)	Remark
4827.000	41.64	4.38	46.02	74.00	-27.98	peak
N/A						

Remark:

1. Measuring frequencies from 1 GHz to the 10th harmonic of highest fundamental frequency.
2. For above 1GHz, the EUT peak value was under average limit, therefore the Average value compliance with the average limit

Test Mode	IEEE 802.11b Mid CH	Temp/Hum	24(°C)/ 33%RH
Test Item	Harmonic	Test Date	December 26, 2017
Polarize	Vertical	Test Engineer	Jerry Chuang
Detector	Peak and Average	Test Voltage	120V

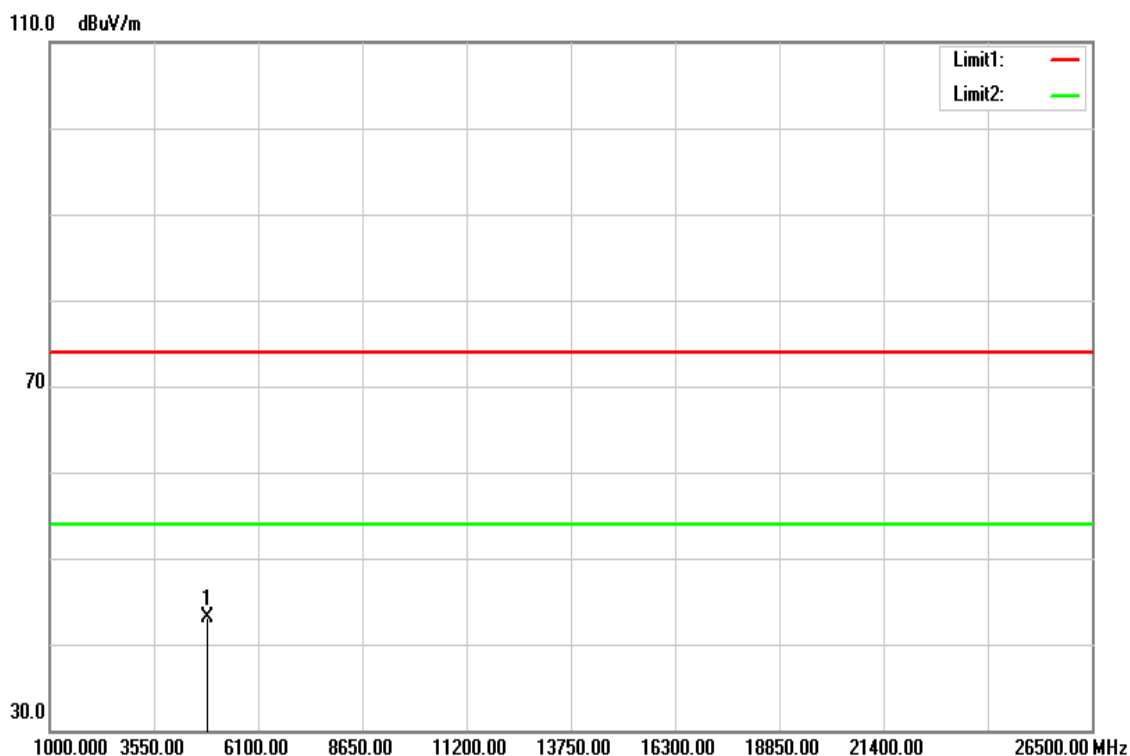

Frequency (MHz)	Reading (dBuV)	Correct Factor (dB/m)	Result (dBuV/m)	Limit (dBuV/m)	Margin (dB)	Remark
4874.000	38.54	4.47	43.01	74.00	-30.99	peak
N/A						

Remark:

1. Measuring frequencies from 1 GHz to the 10th harmonic of highest fundamental frequency.
2. For above 1GHz, the EUT peak value was under average limit, therefore the Average value compliance with the average limit

Test Mode	IEEE 802.11b Mid CH	Temp/Hum	24(°C)/ 33%RH
Test Item	Harmonic	Test Date	December 26, 2017
Polarize	Horizontal	Test Engineer	Jerry Chuang
Detector	Peak and Average	Test Voltage	120V

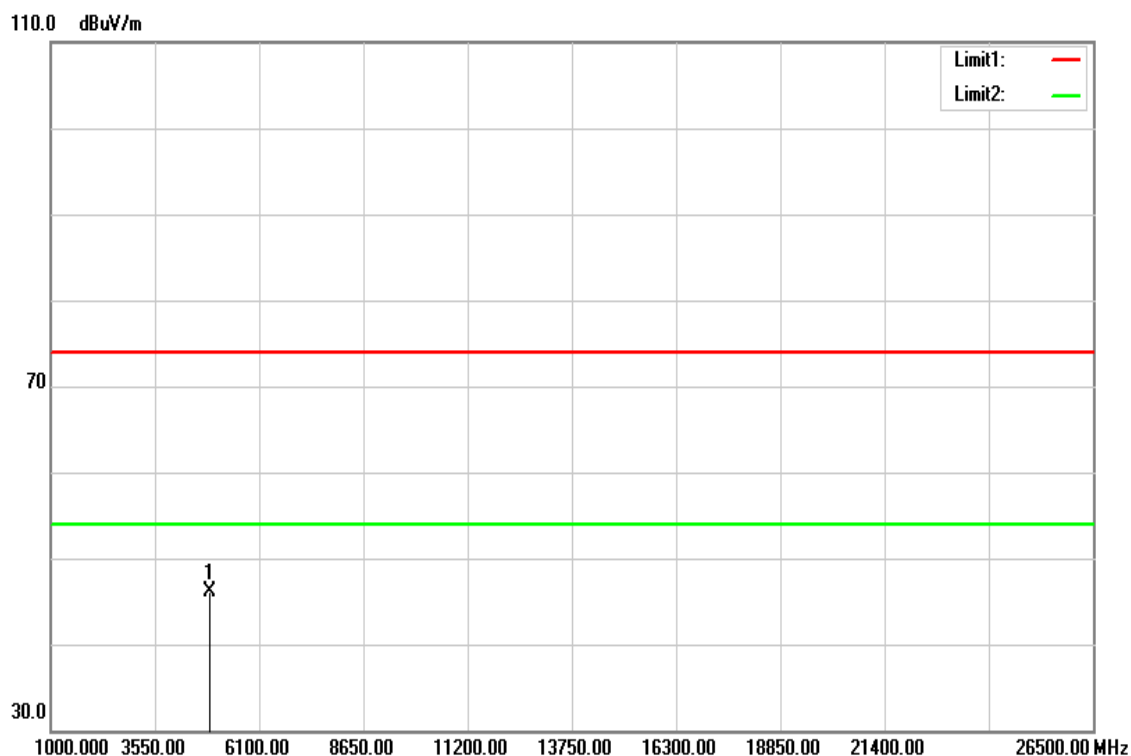

Frequency (MHz)	Reading (dBuV)	Correct Factor (dB/m)	Result (dBuV/m)	Limit (dBuV/m)	Margin (dB)	Remark
4876.000	41.71	4.47	46.18	74.00	-27.82	peak
N/A						

Remark:

1. Measuring frequencies from 1 GHz to the 10th harmonic of highest fundamental frequency.
2. For above 1GHz, the EUT peak value was under average limit, therefore the Average value compliance with the average limit

Test Mode	IEEE 802.11b High CH	Temp/Hum	24(°C)/ 33%RH
Test Item	Harmonic	Test Date	December 26, 2017
Polarize	Vertical	Test Engineer	Jerry Chuang
Detector	Peak and Average	Test Voltage	120V

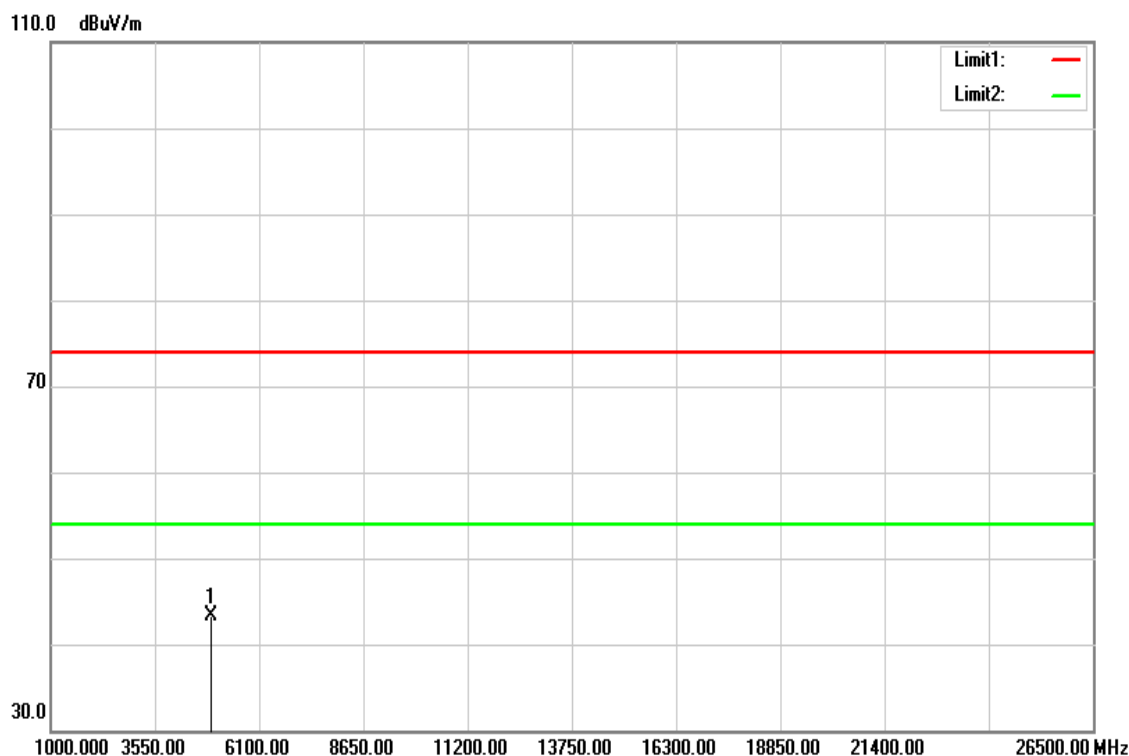

Frequency (MHz)	Reading (dBuV)	Correct Factor (dB/m)	Result (dBuV/m)	Limit (dBuV/m)	Margin (dB)	Remark
4924.000	38.76	4.55	43.31	74.00	-30.69	peak
N/A						

Remark:

1. Measuring frequencies from 1 GHz to the 10th harmonic of highest fundamental frequency.
2. For above 1GHz, the EUT peak value was under average limit, therefore the Average value compliance with the average limit

Test Mode	IEEE 802.11b High CH	Temp/Hum	24(°C)/ 33%RH
Test Item	Harmonic	Test Date	December 26, 2017
Polarize	Horizontal	Test Engineer	Jerry Chuang
Detector	Peak and Average	Test Voltage	120V

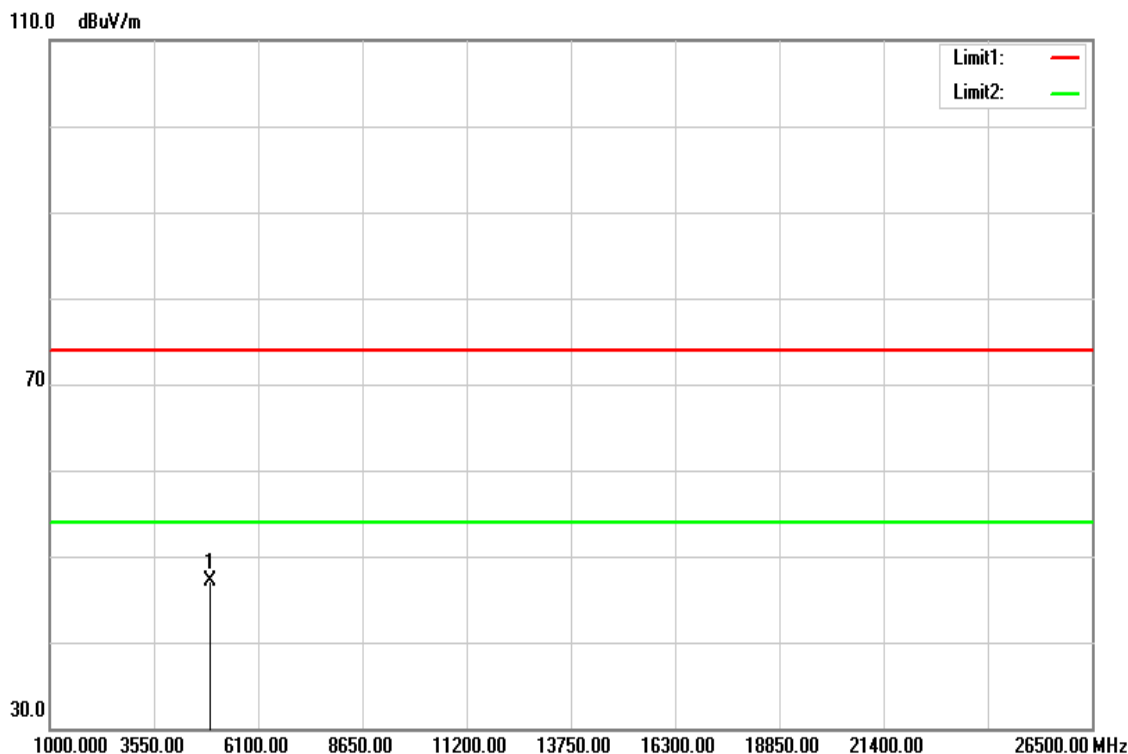

Frequency (MHz)	Reading (dBuV)	Correct Factor (dB/m)	Result (dBuV/m)	Limit (dBuV/m)	Margin (dB)	Remark
4925.000	42.49	4.55	47.04	74.00	-26.96	peak
N/A						

Remark:

1. Measuring frequencies from 1 GHz to the 10th harmonic of highest fundamental frequency.
2. For above 1GHz, the EUT peak value was under average limit, therefore the Average value compliance with the average limit

Test Mode	IEEE 802.11g Low CH	Temp/Hum	24 (°C)/ 33%RH
Test Item	Harmonic	Test Date	December 26, 2017
Polarize	Vertical	Test Engineer	Jerry Chuang
Detector	Peak and Average	Test Voltage	120V

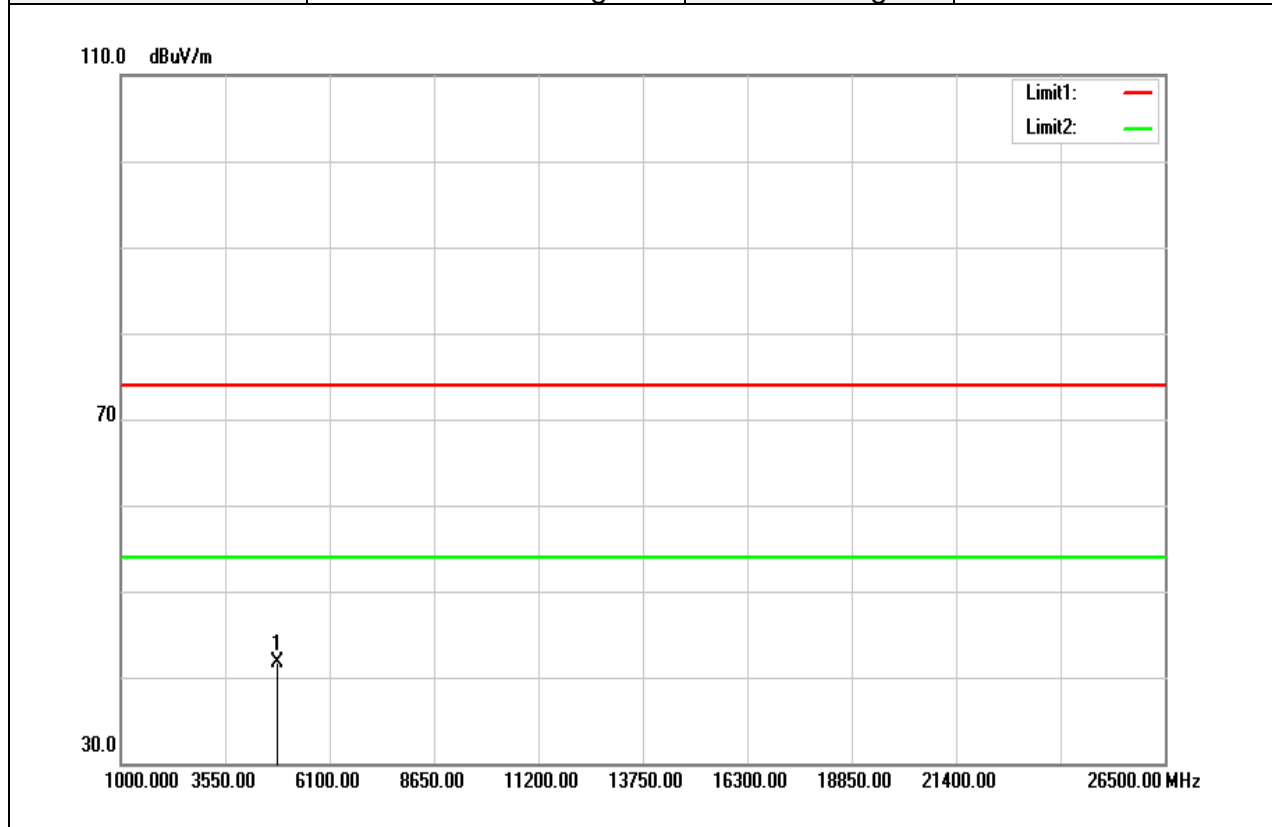

Frequency (MHz)	Reading (dBuV)	Correct Factor (dB/m)	Result (dBuV/m)	Limit (dBuV/m)	Margin (dB)	Remark
4824.000	37.25	4.38	41.63	74.00	-32.37	peak
N/A						

Remark:

1. Measuring frequencies from 1 GHz to the 10th harmonic of highest fundamental frequency.
2. For above 1GHz, the EUT peak value was under average limit, therefore the Average value compliance with the average limit

Test Mode	IEEE 802.11g Low CH	Temp/Hum	24 (°C)/ 33%RH
Test Item	Harmonic	Test Date	December 26, 2017
Polarize	Horizontal	Test Engineer	Jerry Chuang
Detector	Peak and Average	Test Voltage	120V

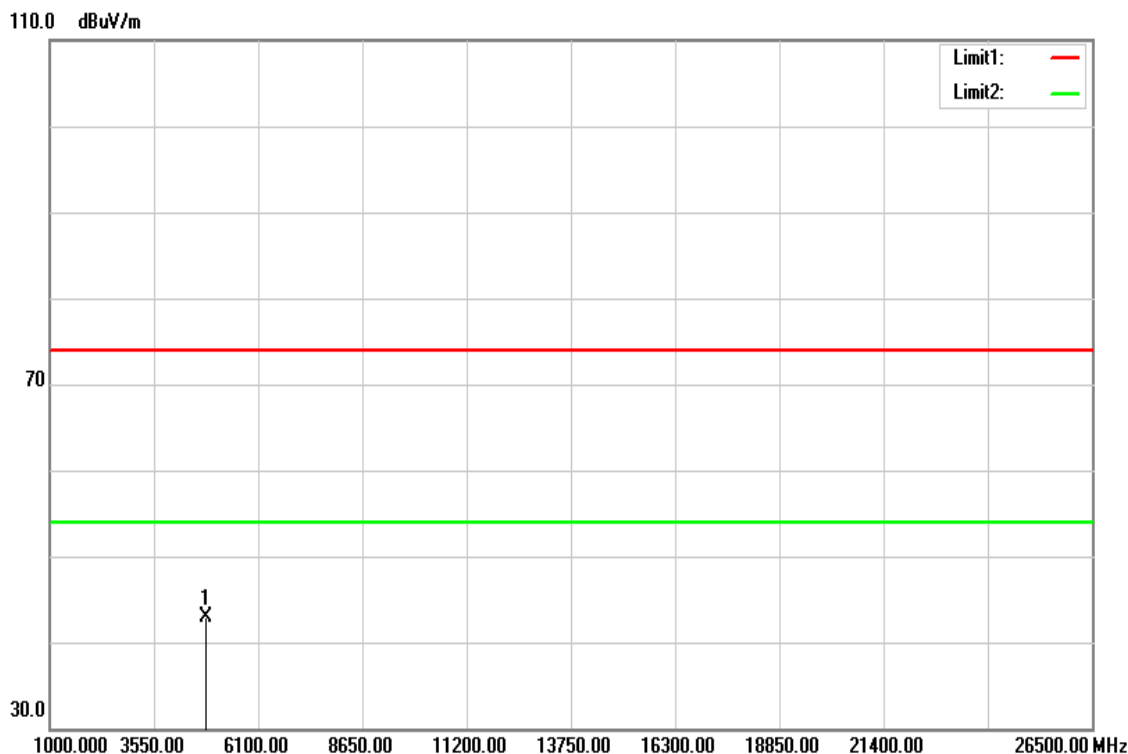

Frequency (MHz)	Reading (dBuV)	Correct Factor (dB/m)	Result (dBuV/m)	Limit (dBuV/m)	Margin (dB)	Remark
4824.000	38.45	4.38	42.83	74.00	-31.17	peak
N/A						

Remark:

1. Measuring frequencies from 1 GHz to the 10th harmonic of highest fundamental frequency.
2. For above 1GHz, the EUT peak value was under average limit, therefore the Average value compliance with the average limit

Test Mode	IEEE 802.11g Mid CH	Temp/Hum	24 (°C)/ 33%RH
Test Item	Harmonic	Test Date	December 26, 2017
Polarize	Vertical	Test Engineer	Jerry Chuang
Detector	Peak and Average	Test Voltage	120V

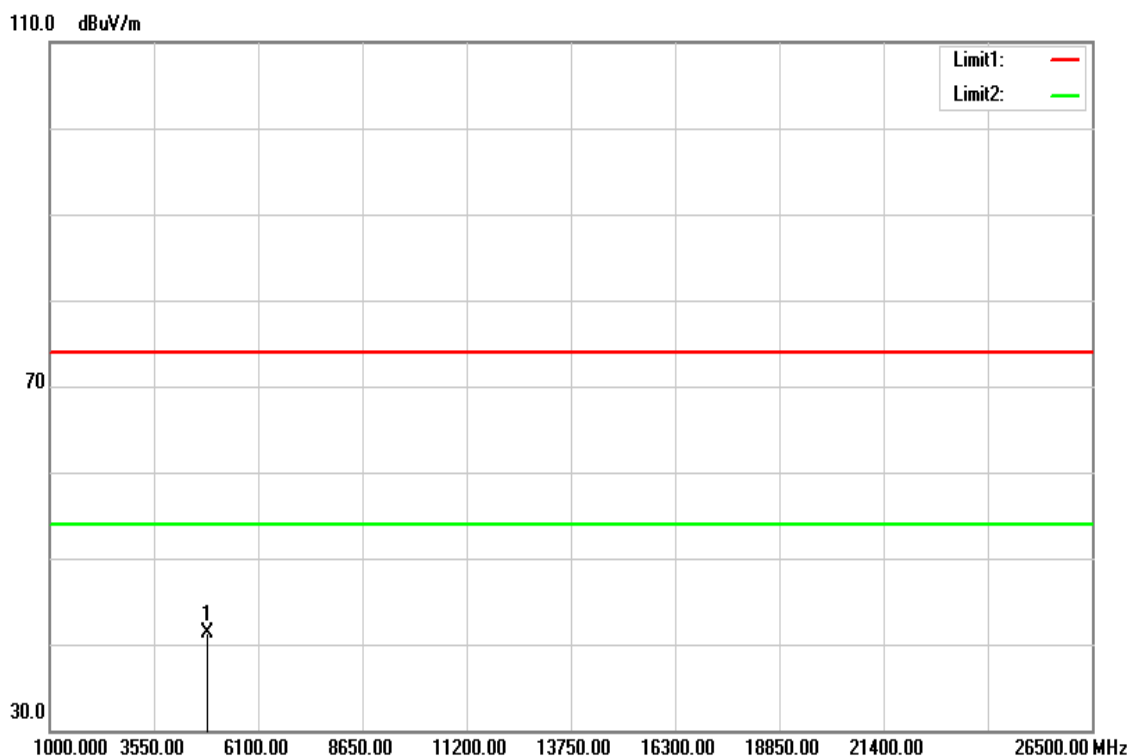

Frequency (MHz)	Reading (dBuV)	Correct Factor (dB/m)	Result (dBuV/m)	Limit (dBuV/m)	Margin (dB)	Remark
4874.000	36.91	4.47	41.38	74.00	-32.62	peak
N/A						

Remark:

1. Measuring frequencies from 1 GHz to the 10th harmonic of highest fundamental frequency.
2. For above 1GHz, the EUT peak value was under average limit, therefore the Average value compliance with the average limit

Test Mode	IEEE 802.11g Mid CH	Temp/Hum	24 (°C)/ 33%RH
Test Item	Harmonic	Test Date	December 26, 2017
Polarize	Horizontal	Test Engineer	Jerry Chuang
Detector	Peak and Average	Test Voltage	120V

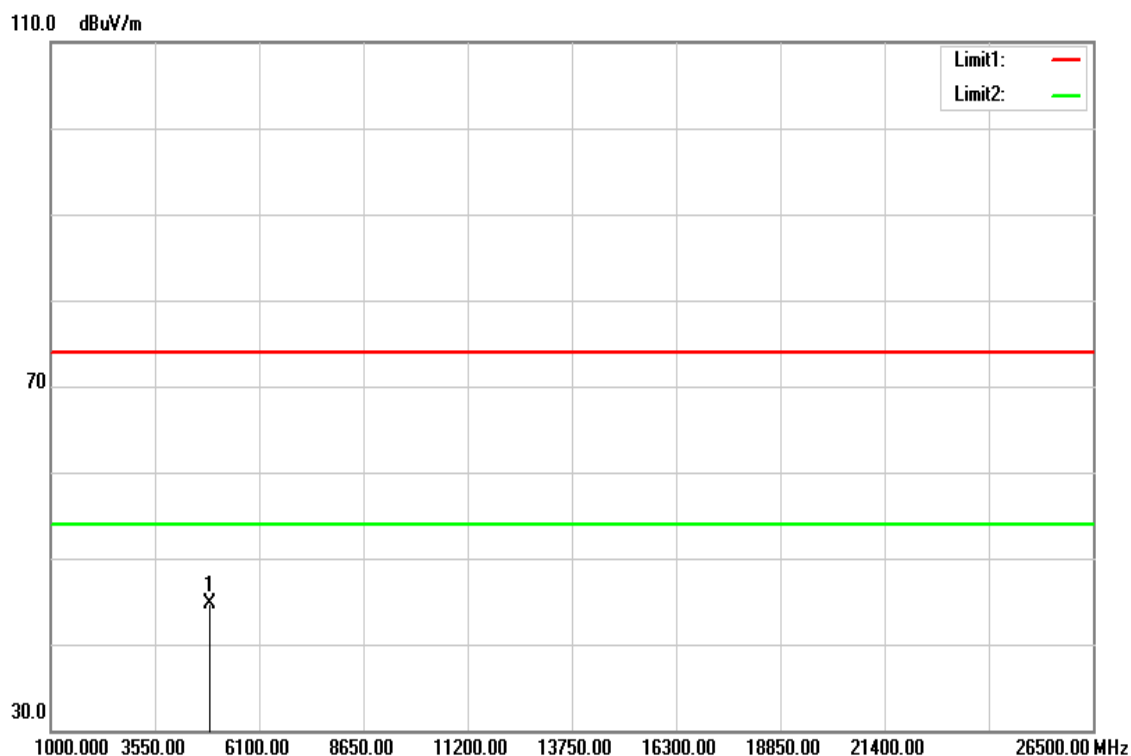

Frequency (MHz)	Reading (dBuV)	Correct Factor (dB/m)	Result (dBuV/m)	Limit (dBuV/m)	Margin (dB)	Remark
4883.000	40.14	4.49	44.63	74.00	-29.37	peak
N/A						

Remark:

1. Measuring frequencies from 1 GHz to the 10th harmonic of highest fundamental frequency.
2. For above 1GHz, the EUT peak value was under average limit, therefore the Average value compliance with the average limit

Test Mode	IEEE 802.11g High CH	Temp/Hum	24 (°C)/ 33%RH
Test Item	Harmonic	Test Date	December 26, 2017
Polarize	Vertical	Test Engineer	Jerry Chuang
Detector	Peak and Average	Test Voltage	120V

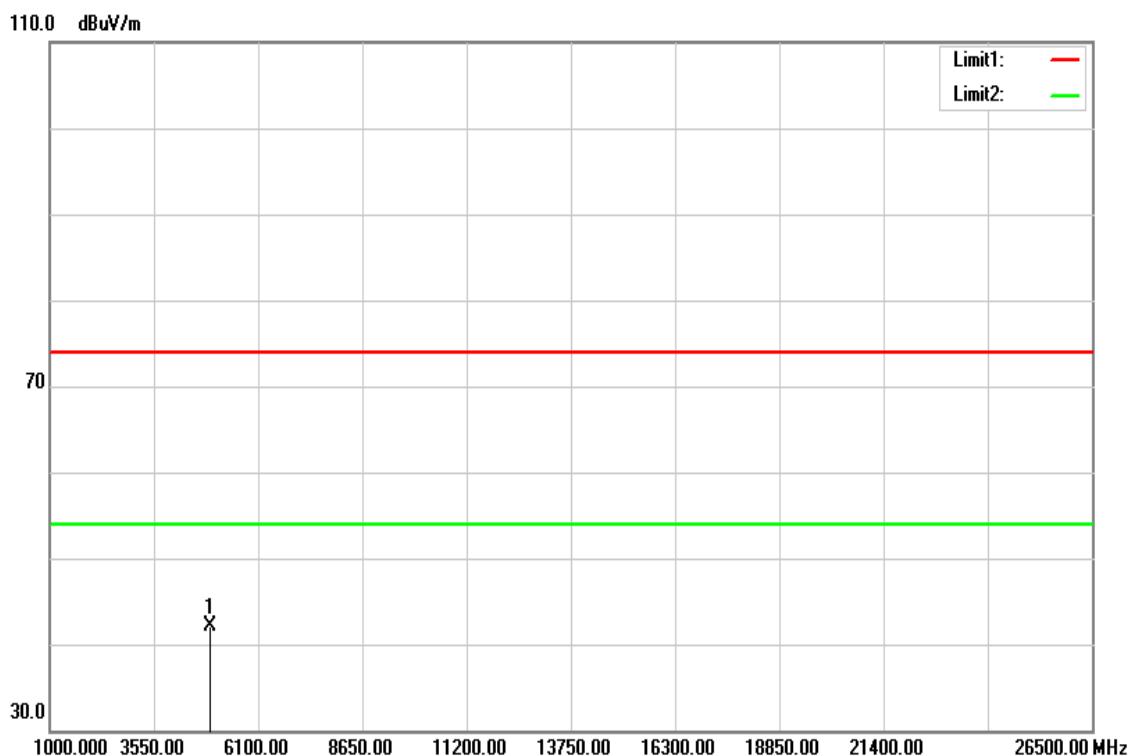

Frequency (MHz)	Reading (dBuV)	Correct Factor (dB/m)	Result (dBuV/m)	Limit (dBuV/m)	Margin (dB)	Remark
4924.000	37.58	4.55	42.13	74.00	-31.87	peak
N/A						

Remark:

1. Measuring frequency from 1 GHz to the 10th harmonic of highest fundamental frequency.
2. For above 1GHz, the EUT peak value was under average limit, therefore the Average value compliance with the average limit

Test Mode	IEEE 802.11g High CH	Temp/Hum	24 (°C)/ 33%RH
Test Item	Harmonic	Test Date	December 26, 2017
Polarize	Horizontal	Test Engineer	Jerry Chuang
Detector	Peak and Average	Test Voltage	120V

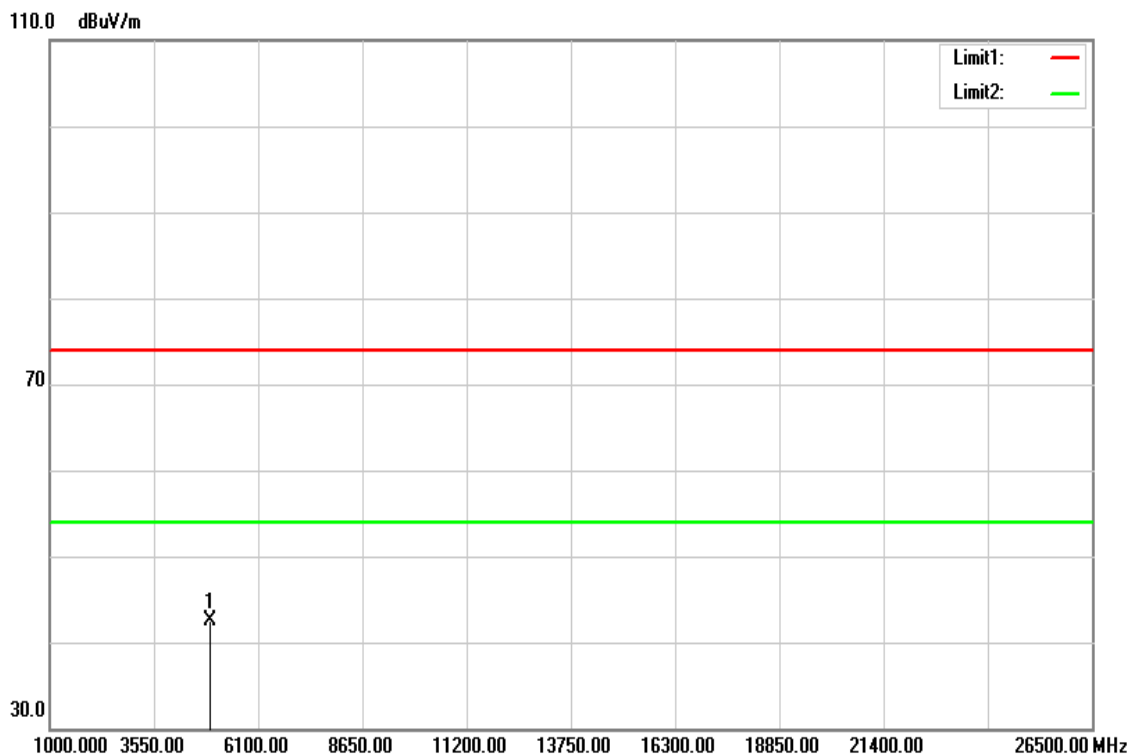

Frequency (MHz)	Reading (dBuV)	Correct Factor (dB/m)	Result (dBuV/m)	Limit (dBuV/m)	Margin (dB)	Remark
4924.000	38.02	4.55	42.57	74.00	-31.43	peak
N/A						

Remark:

1. Measuring frequencies from 1 GHz to the 10th harmonic of highest fundamental frequency.
2. For above 1GHz, the EUT peak value was under average limit, therefore the Average value compliance with the average limit

Test Mode	IEEE 802.11n HT20 Low CH	Temp/Hum	24 (°C)/ 33%RH
Test Item	Harmonic	Test Date	December 26, 2017
Polarize	Vertical	Test Engineer	Jerry Chuang
Detector	Peak and Average	Test Voltage	120V

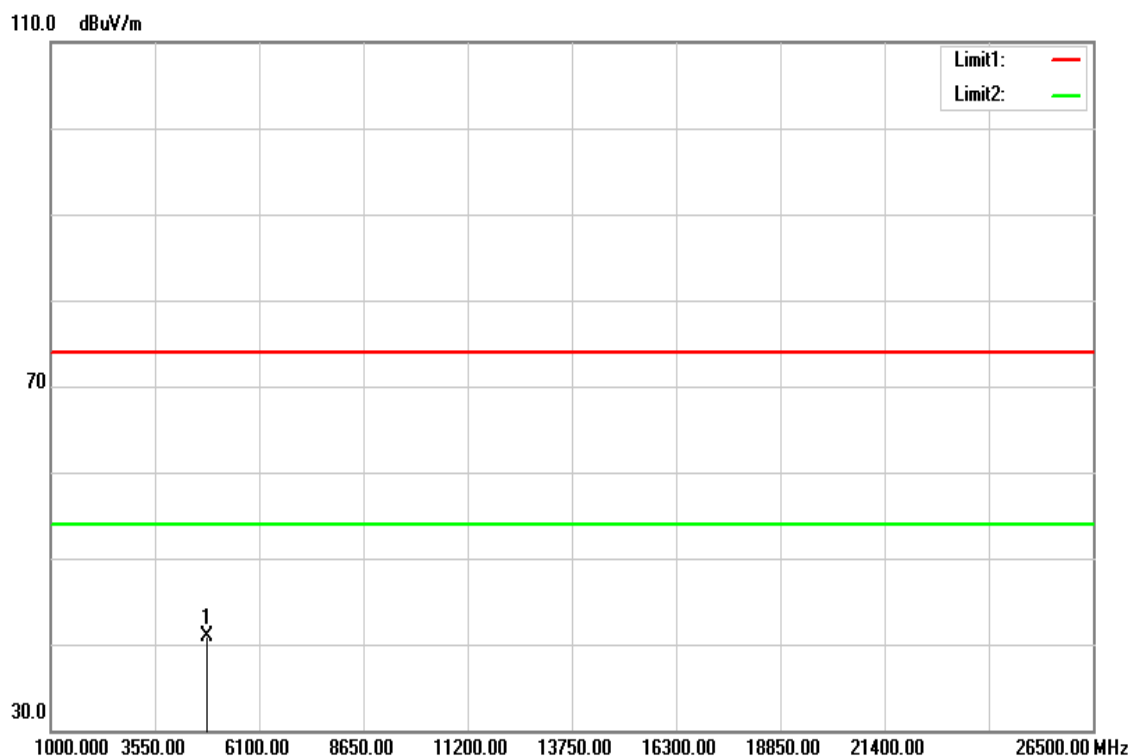

Frequency (MHz)	Reading (dBuV)	Correct Factor (dB/m)	Result (dBuV/m)	Limit (dBuV/m)	Margin (dB)	Remark
4824.000	36.46	4.38	40.84	74.00	-33.16	peak
N/A						

Remark:

1. Measuring frequencies from 1 GHz to the 10th harmonic of highest fundamental frequency.
2. For above 1GHz, the EUT peak value was under average limit, therefore the Average value compliance with the average limit

Test Mode	IEEE 802.11n HT20 Low CH	Temp/Hum	24 (°C)/ 33%RH
Test Item	Harmonic	Test Date	December 26, 2017
Polarize	Horizontal	Test Engineer	Jerry Chuang
Detector	Peak and Average	Test Voltage	120V

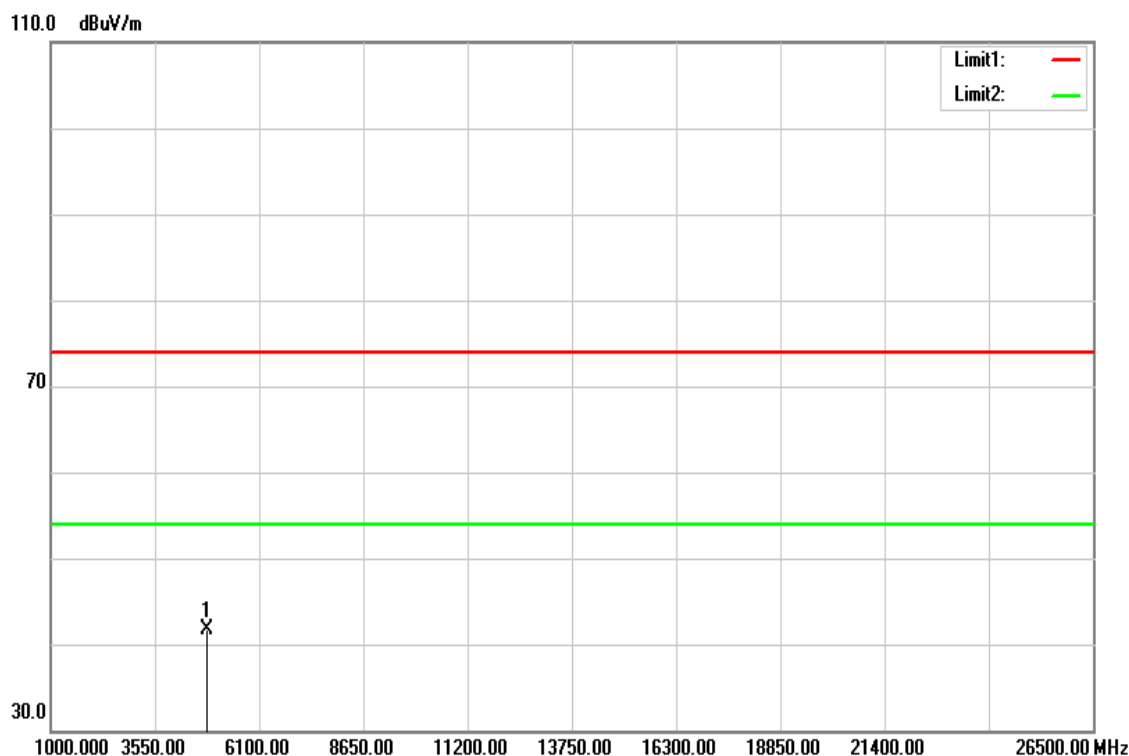

Frequency (MHz)	Reading (dBuV)	Correct Factor (dB/m)	Result (dBuV/m)	Limit (dBuV/m)	Margin (dB)	Remark
4824.000	37.35	4.38	41.73	74.00	-32.27	peak
N/A						

Remark:

1. Measuring frequencies from 1 GHz to the 10th harmonic of highest fundamental frequency.
2. For above 1GHz, the EUT peak value was under average limit, therefore the Average value compliance with the average limit

Test Mode	IEEE 802.11n HT20 Mid CH	Temp/Hum	24 (°C)/ 33%RH
Test Item	Harmonic	Test Date	December 26, 2017
Polarize	Vertical	Test Engineer	Jerry Chuang
Detector	Peak and Average	Test Voltage	120V

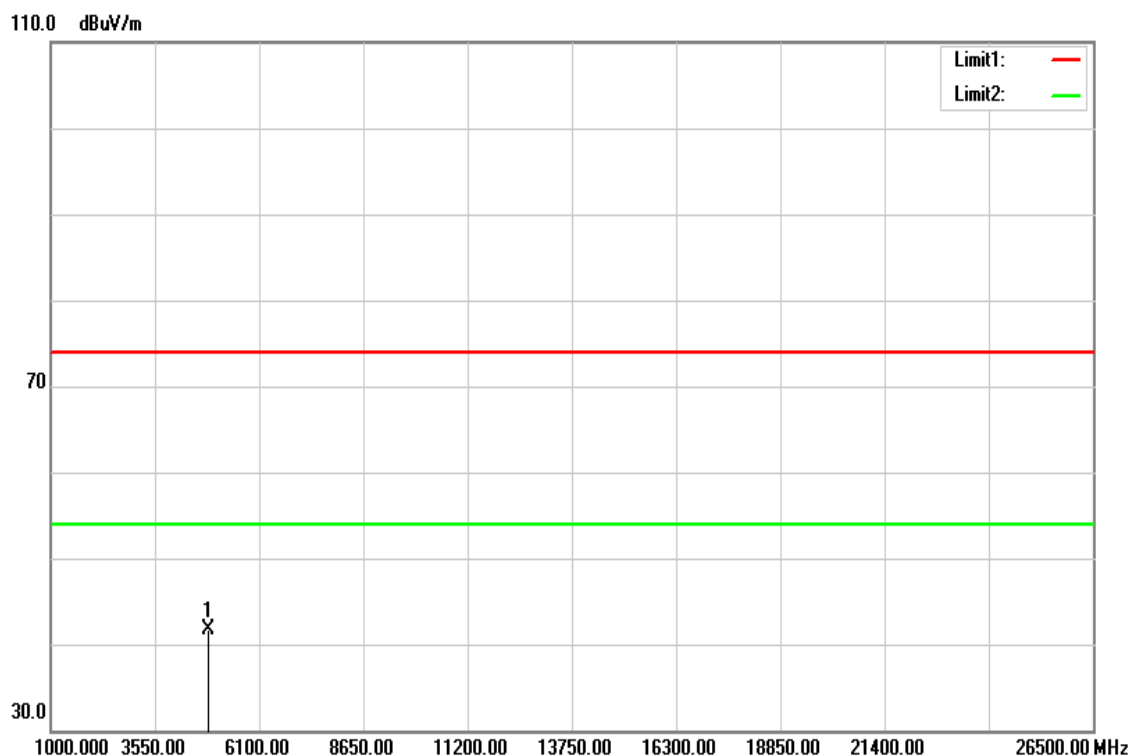

Frequency (MHz)	Reading (dBuV)	Correct Factor (dB/m)	Result (dBuV/m)	Limit (dBuV/m)	Margin (dB)	Remark
4874.000	37.22	4.47	41.69	74.00	-32.31	peak
N/A						

Remark:

1. Measuring frequencies from 1 GHz to the 10th harmonic of highest fundamental frequency.
2. For above 1GHz, the EUT peak value was under average limit, therefore the Average value compliance with the average limit

Test Mode	IEEE 802.11n HT20 Mid CH	Temp/Hum	24 (°C)/ 33%RH
Test Item	Harmonic	Test Date	December 26, 2017
Polarize	Horizontal	Test Engineer	Jerry Chuang
Detector	Peak and Average	Test Voltage	120V

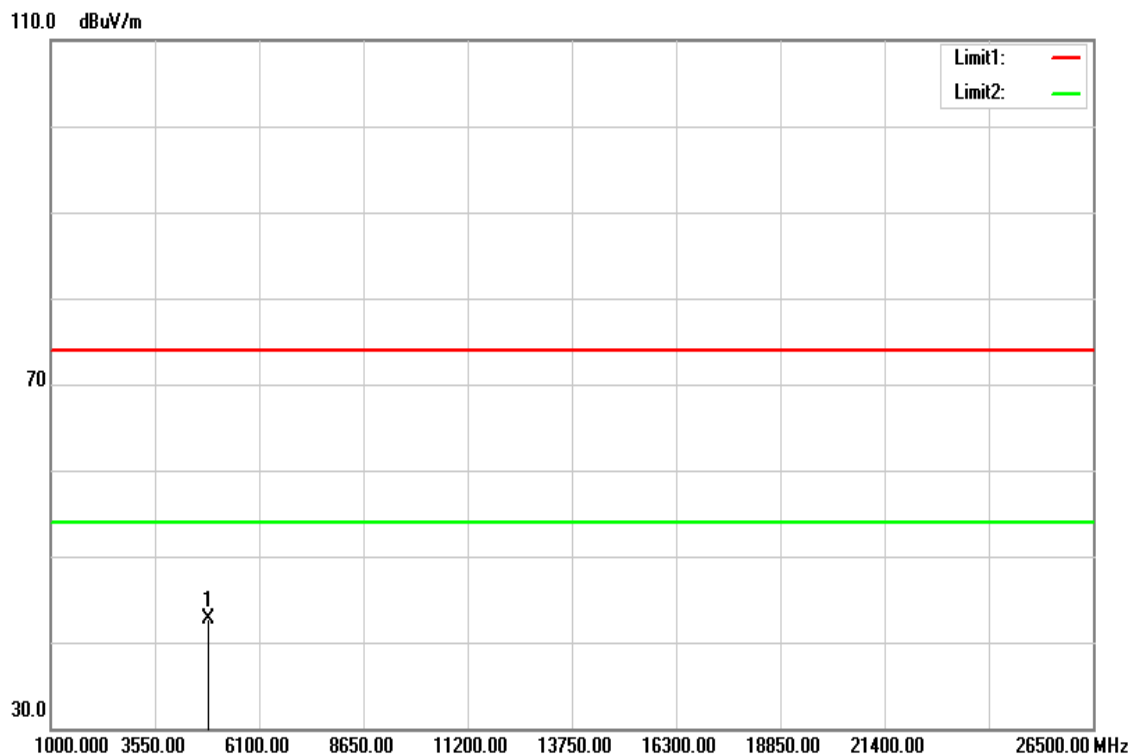

Frequency (MHz)	Reading (dBuV)	Correct Factor (dB/m)	Result (dBuV/m)	Limit (dBuV/m)	Margin (dB)	Remark
4874.000	38.26	4.47	42.73	74.00	-31.27	peak
N/A						

Remark:

1. Measuring frequencies from 1 GHz to the 10th harmonic of highest fundamental frequency.
2. For above 1GHz, the EUT peak value was under average limit, therefore the Average value compliance with the average limit

Test Mode	IEEE 802.11n HT20 High CH	Temp/Hum	24 (°C)/ 33%RH
Test Item	Harmonic	Test Date	December 26, 2017
Polarize	Vertical	Test Engineer	Jerry Chuang
Detector	Peak and Average	Test Voltage	120V

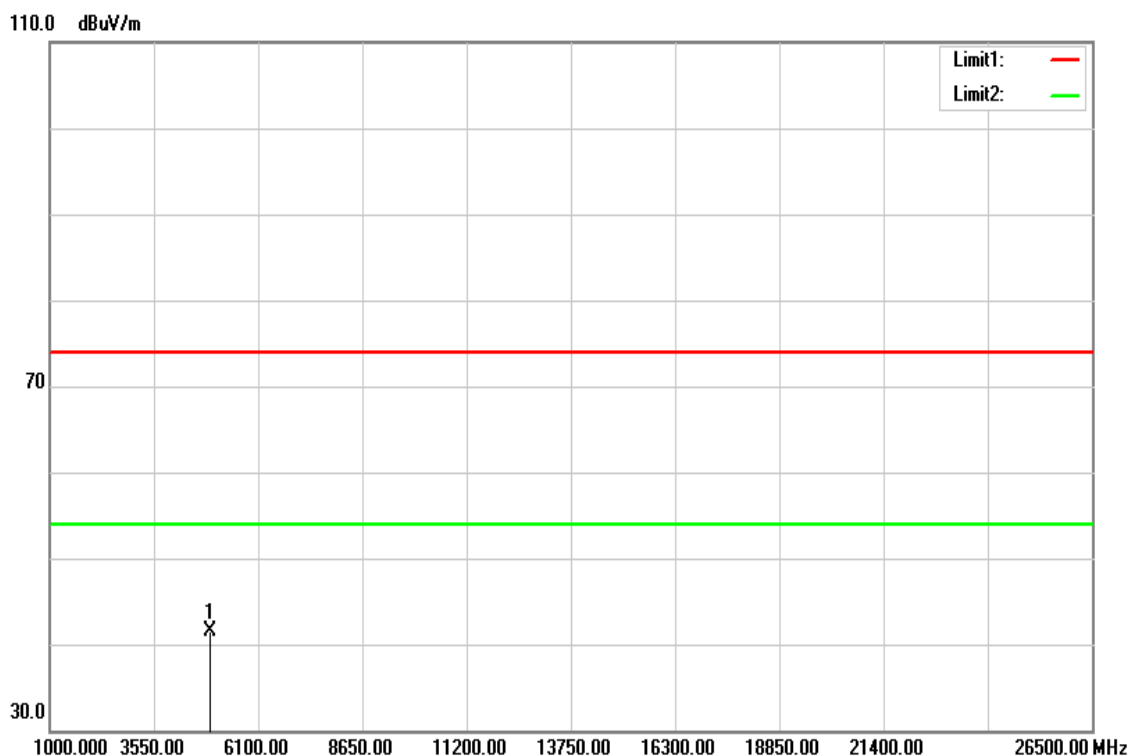

Frequency (MHz)	Reading (dBuV)	Correct Factor (dB/m)	Result (dBuV/m)	Limit (dBuV/m)	Margin (dB)	Remark
4924.000	36.93	4.55	41.48	74.00	-32.52	peak
N/A						

Remark:

1. Measuring frequencies from 1 GHz to the 10th harmonic of highest fundamental frequency.
2. For above 1GHz, the EUT peak value was under average limit, therefore the Average value compliance with the average limit

Test Mode	IEEE 802.11n HT20 High CH	Temp/Hum	24 (°C)/ 33%RH
Test Item	Harmonic	Test Date	December 26, 2017
Polarize	Horizontal	Test Engineer	Jerry Chuang
Detector	Peak and Average	Test Voltage	120V

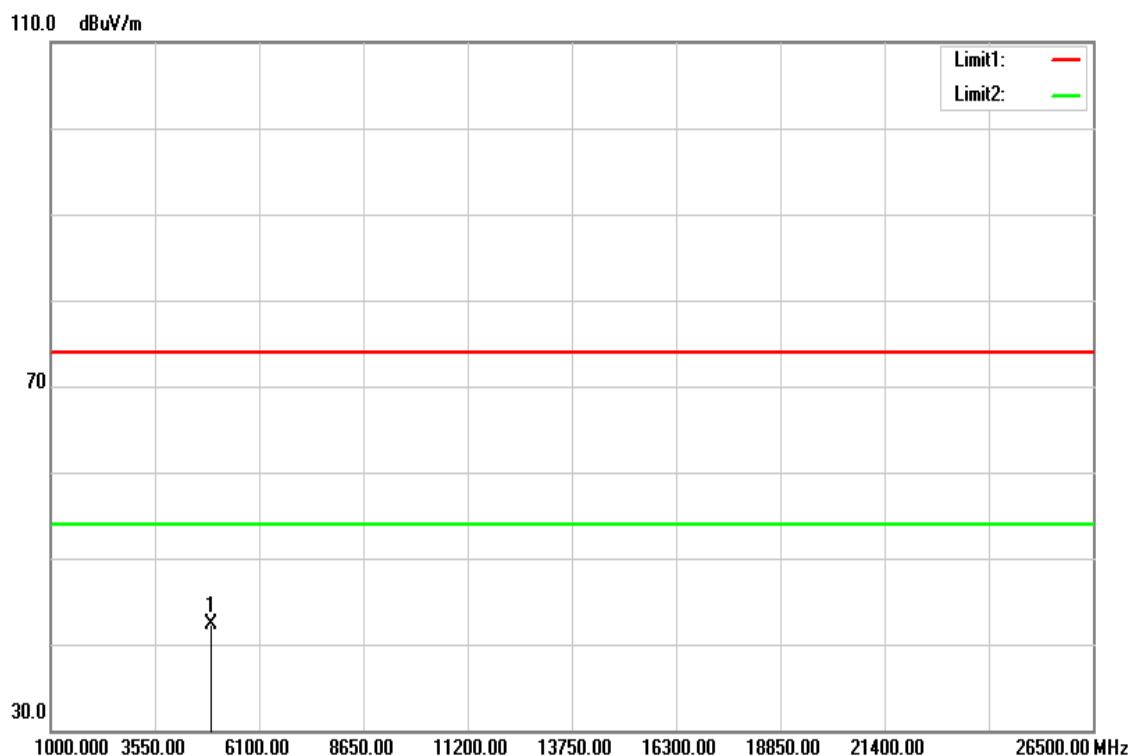

Frequency (MHz)	Reading (dBuV)	Correct Factor (dB/m)	Result (dBuV/m)	Limit (dBuV/m)	Margin (dB)	Remark
4924.000	37.65	4.55	42.20	74.00	-31.80	peak
N/A						

Remark:

1. Measuring frequencies from 1 GHz to the 10th harmonic of highest fundamental frequency.
2. For above 1GHz, the EUT peak value was under average limit, therefore the Average value compliance with the average limit