

Radio Test Report

Equipment : Rugged Tablet Computer
Brand Name : AAEON
Model No. : xRTC-1200x (x - Where x may be any combination of alphanumeric characters or "-" or blank.)
FCC ID : OHBRTC1200WBGH
Standard : 47 CFR FCC Part 22(H), 24(E)
WCDMA Band : II, V
FCC Classification : PCB
Applicant / Manufacturer : **AAEON Technology Inc.**
5F, No. 135, Lane 235, Pao Chiao Rd.,
Hsin-Tien Dist., New Taipei City 23145, Taiwan, R.O.C

The product sample received on Nov. 21, 2016 and completely tested on Dec. 12, 2016. We, SPORTON, would like to declare that the tested sample has been evaluated in accordance with the procedures given in ANSI/TIA-603-D-2010, ANSI C63.4 and shown compliance with the applicable technical standards.

The test results in this report apply exclusively to the tested model / sample. Without written approval of SPORTON INTERNATIONAL INC., the test report shall not be reproduced except in full.

Reviewed by:



Phoenix Chen / Assistant Manager





Table of Contents

1	GENERAL DESCRIPTION	5
1.2	Accessories and Support Equipment	7
1.3	Testing Applied Standards	7
1.4	Testing Location Information	7
1.5	Measurement Uncertainty	8
2	TEST CONFIGURATION OF EUT.....	9
2.1	The Worst Case Measurement Configuration.....	9
2.2	Test Setup Diagram	10
3	TRANSMITTER TEST RESULT	11
3.1	Emission Bandwidth	11
3.2	Transmitter Conducted Output Power.....	13
3.3	Effective Radiated Power	15
3.4	Effective Isotropic Radiated Power	17
3.5	Transmitter Conducted Unwanted Emissions	19
3.6	Transmitter Conducted Bandedge Emissions.....	21
3.7	Transmitter Radiated Unwanted Emissions	23
3.8	Frequency Stability.....	30
4	TEST EQUIPMENT AND CALIBRATION DATA.....	32

Appendix A. Test Result

Appendix EP. Photographs Of EUT v01

Summary of Test Result

Test Specifications					
Report Clause	FCC Std. Clause	Description	Measured	Limit	Result
3.1	2.1049 22.917(a) 24.238(a)	Emission Bandwidth	Bandwidth F9W=4.2178MHz	Information for Emission Designator	Complied
3.1.6	2.1047	Emission Designator	F9W	Information only	Complied
3.2	2.1046	Transmitter Conducted Output Power	Conducted Power [dBm] Cellular: 22.54 PCS: 23.43	Information for RF exposure	Complied
3.2.7	24.232(d)	Peak to Average Ratio	3.51dB	≤13dB	Complied
3.3	22.913(a)	Effective Radiated Power (ERP)	ERP [dBm] Cellular:12.15	≤7W[38.45dBm]	Complied
3.4	24.232(c)	Effective Isotropic Radiated Power (EIRP)	EIRP [dBm] PCS: 20.37	PCS: ≤2W[33.01dBm] AWS: ≤1W[30.00dBm]	Complied
3.5	2.1051 22.917(a) 24.238(a)	Transmitter Conducted Unwanted Emissions	refer to test data	≤43+10log(P) [-13dBm] P=TX Power in Watts	Complied
3.6	2.1051 22.917(a) 24.238(a)	Transmitter Conducted Bandedge Emissions	refer to test data	≤43+10log(P) [-13dBm] P=TX Power in Watts	Complied
3.7	2.1053 22.917(a) 24.238(a)	Transmitter Radiated Unwanted Emissions	[dBm]: 30.000MHz 35.81 (Margin 4.19dB)	≤43+10log(P) [-13dBm] P=TX Power in Watts	Complied
3.8	2.1055 22.355 24.353	Frequency Stability	Cellular: 0.0221ppm PCS: 0.0119ppm	≤ ± 2.5ppm within band	Complied



Revision History

Report No.	Version	Description	Issued Date
FG6N1002	Rev. 01	Initial issue of report	Jan. 10, 2017

1 General Description

1.1.1 RF General Information

Function	Class/Category	
<input checked="" type="checkbox"/> HSDPA	Category	10
<input checked="" type="checkbox"/> HSUPA	Category	6

RF General Information							
Freq. Band	Mode	TX Ch. Freq. (MHz)	Channel Number	BW (MHz)	Emission Designator	Max. ERP/EIRP	
						(dBm)	(W)
Cellular	WCDMA850	826.4-846.6	4132-4233	5	4M17F9W	14.48	0.0281
PCS	WCDMA1900	1852.4-1907.6	9262-9538	5	4M21F9W	23.63	0.2307

Note 1: WCDMA Rel.99 mode consists of QPSK modulation and HSDPA Rel. 5 mode consists of QPSK and 16QAM modulation.
 Note 2: WCDMA850 (WCDMA Band V), WCDMA1900 (WCDMA Band II)

1.1.2 Antenna Information

Antenna Category	
<input checked="" type="checkbox"/>	Integral antenna (antenna permanently attached)
<input checked="" type="checkbox"/>	Temporary RF connector provided
<input type="checkbox"/>	No temporary RF connector provided Transmit chains bypass antenna and soldered temporary RF connector provided for connected measurement. In case of conducted measurements the transmitter shall be connected to the measuring equipment via a suitable attenuator and correct for all losses in the RF path.

Antenna General Information				
Operating Band	Ant. Cat.	Ant. Type	Connector	Gain (dBi)
Band V	Integral	PCB	I-pex	-8.24
Band II	Integral	PCB	I-pex	-3.06

1.1.3 Type of EUT

Identify EUT	
Presentation of Equipment	<input checked="" type="checkbox"/> Production ; <input type="checkbox"/> Pre-Production ; <input type="checkbox"/> Prototype
Type of EUT	
<input checked="" type="checkbox"/>	Stand-alone
<input type="checkbox"/>	Combined (EUT where the radio part is fully integrated within another device) Combined Equipment - Brand Name / Model No.: ...
<input type="checkbox"/>	Plug-in radio (EUT intended for a variety of host systems) Host System - Brand Name / Model No.: ...
<input type="checkbox"/>	Other:

1.1.4 EUT Operational Condition

Supply Voltage	<input checked="" type="checkbox"/> AC mains	<input checked="" type="checkbox"/> DC	
Type of DC Source	<input type="checkbox"/> Internal DC supply	<input checked="" type="checkbox"/> External AC adapter	<input checked="" type="checkbox"/> Battery
Test Voltage	<input checked="" type="checkbox"/> Vnom (14.4 V)	<input checked="" type="checkbox"/> Vmax (16.8 V)	<input checked="" type="checkbox"/> Vmin (13 V)
Test Climatic	<input checked="" type="checkbox"/> Tnom (20°C)	<input checked="" type="checkbox"/> Tmax (50°C)	<input checked="" type="checkbox"/> Tmin (-20°C)

1.2 Accessories and Support Equipment

Accessories Information				
AC Adapter	Brand Name	FSP	Model Name	FSP065-REBN2
	Power Rating	I/P: 100 - 240 Vac, 1.5 A, O/P: 19 Vdc, 3.42 A		
	Power Cord	1.2 meter, non-shielded cable, with one ferrite core		
Battery 1	Brand Name	AAEON	Model Name	RTC1200
	Power Rating	14.4 Vdc, 2270 mAh	Type	Li-ion, 4S1P
Battery 2	Brand Name	AAEON	Model Name	RTC1200
	Power Rating	14.4 Vdc, 2270 mAh	Type	Li-ion, 4S1P
LCD Panel	Brand Name	LITEMAX	Model Name	OLP1167-ITN-A01

Reminder: Regarding to more detail and other information, please refer to user manual.

Support Equipment			
No.	Equipment	Brand Name	Model Name
1	SIM card	R&S	-

1.3 Testing Applied Standards

According to the specifications of the manufacturer, the EUT must comply with the requirements of the following standards:

- ◆ Part 22(H), 24(E)
- ◆ ANSI/TIA-603-D-2010
- ◆ KDB 971168 D01 v02r02
- ◆ KDB 412172 D01 v01r01

1.4 Testing Location Information

Testing Location					
<input checked="" type="checkbox"/>	HWA YA	ADD	:	No. 52, Hwa Ya 1st Rd., Hwa Ya Technology Park, Kwei-Shan District, Tao Yuan City, Taiwan, R.O.C.	
		TEL	:	886-3-327-3456	FAX : 886-3-327-0973
Test Site Registration Number: FCC 553509					
Test Condition	Test Site No.	Test Engineer	Test Environment	Test Date	
RF Conducted	TH07-HY	Candy	22°C / 63.2%	12/12/2016	
Radiated Emission	03CH03-HY	Jeff	21.5°C / 58%	18/08/2016	

1.5 Measurement Uncertainty



ISO/IEC 17025 requires that an estimate of the measurement uncertainties associated with the emissions test results be included in the report. The measurement uncertainties given below are based on a 95% confidence level (based on a coverage factor (k=2))

Measurement Uncertainty		
Test Item		Uncertainty
Emission bandwidth		±1.4 %
RF output power, conducted		±0.6 dB
Unwanted emissions, conducted	30 – 1000 MHz	±0.5 dB
	1 – 18 GHz	±0.6 dB
	18 – 40 GHz	±0.8 dB
	40 – 200 GHz	N/A
All emissions, radiated	30 – 1000 MHz	±2.5 dB
	1 – 18 GHz	±3.5 dB
	18 – 40 GHz	±3.8 dB
	40 – 200 GHz	N/A
Temperature		±0.8 °C
Humidity		±3 %
DC and low frequency voltages		±3 %
Time		±1.4 %
Duty Cycle		±1.4 %

2 Test Configuration of EUT

2.1 The Worst Case Measurement Configuration

The Worst Case Mode for Following Conformance Tests	
Tests Item	Emission Bandwidth, Transmitter Conducted Output Power, Peak-Average Ratio, Transmitter Conducted Bandedge Emissions Transmitter Conducted Unwanted Emissions, Frequency Stability
Test Condition	Conducted measurement at transmit chains
Modulation Mode	WCDMA

The Worst Case Mode for Following Conformance Tests			
Tests Item	Effective Radiated Power (ERP) Effective Isotropic Radiated Power (EIRP) Transmitter Radiated Unwanted Emissions		
Test Condition	Radiated measurement If EUT consist of multiple antenna assembly (multiple antenna are used in EUT regardless of spatial multiplexing MIMO configuration), the radiated test should be performed with highest antenna gain of each antenna type.		
Modulation Mode	WCDMA		
User Position	<input type="checkbox"/> EUT will be placed in fixed position.		
	<input type="checkbox"/> EUT will be placed in mobile position and operating multiple positions.		
	<input checked="" type="checkbox"/> EUT will be a hand-held or body-worn battery-powered devices and operating multiple positions.		
Orthogonal Planes of EUT	X Plane	Y Plane	Z Plane
			
Worst Planes of EUT		V	

2.2 Test Setup Diagram

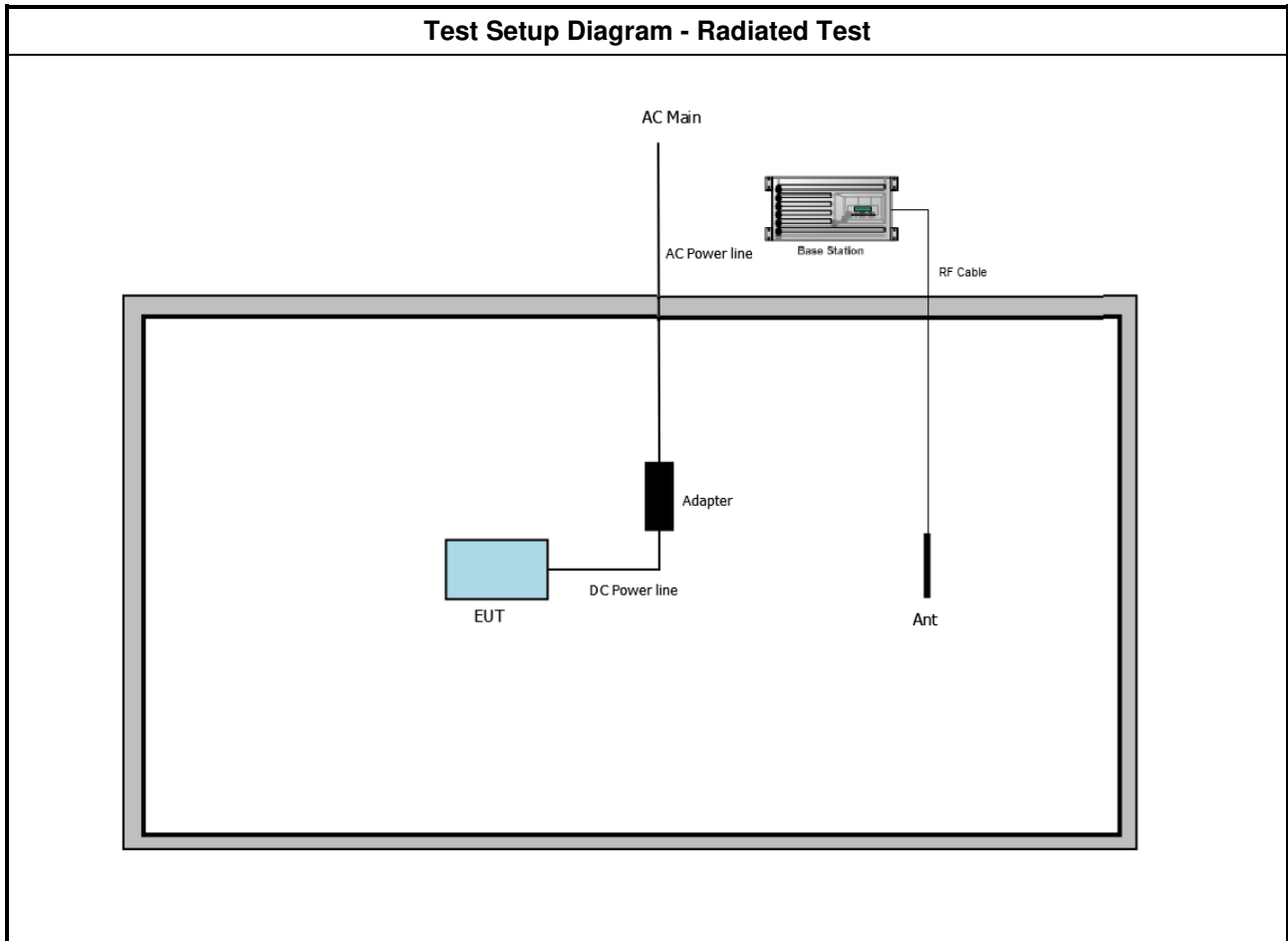

3 Transmitter Test Result

3.1 Emission Bandwidth

3.1.1 Emission Bandwidth Limit

Emission Bandwidth Limit
Information for Emission Designator.
Note 1: The 99% occupied bandwidth is the frequency bandwidth of the signal power at the 99% channel power of occupied bandwidth when resolution bandwidth should be approximately 1 % to 5 % of the span. These measurements shall also be performed at normal test conditions.

3.1.2 Measuring Instruments

Refer a test equipment and calibration data table in this test report.

3.1.3 Test Procedures

Test Method
<input checked="" type="checkbox"/> For the emission bandwidth shall be measured using one of the options below:
<input checked="" type="checkbox"/> Refer as ANSI/TIA-603-D, clause 1.3.4.4 for test bandwidth. <input checked="" type="checkbox"/> Refer as KDB 971168, clause 4 for signal bandwidth. <input type="checkbox"/> Refer as IC RSS-Gen, clause 6.6 for emission bandwidth.
<input checked="" type="checkbox"/> For conducted measurement.
<input checked="" type="checkbox"/> If EUT supports single transmit chain and measurements performed on this transmit chain. <input type="checkbox"/> If EUT supports diversity transmitting and the results on transmit chain port 1 is the worst case. <input type="checkbox"/> If EUT supports multiple transmit chains using options given below:
<input type="checkbox"/> Option 1: Multiple transmit chains measurements need to be performed on one of the active transmit chains (antenna outputs). All measurement had be performed on transmit chains 1. <input type="checkbox"/> Option 2: Multiple transmit chains measurements need to be performed on each transmit chains individually (antenna outputs). All measurement had be performed on all transmit chains.
<input type="checkbox"/> For radiated measurement. The equipment to be measured and the test antenna shall be oriented to obtain the maximum emitted power level.

3.1.4 Test Setup

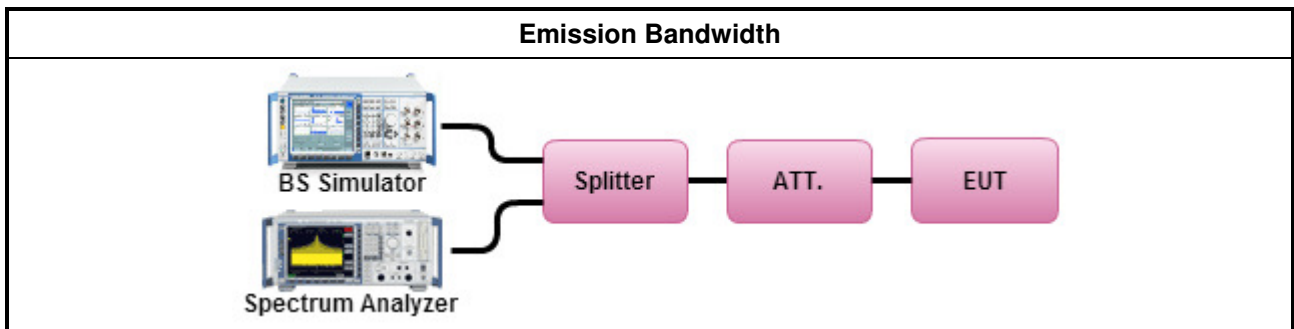

3.1.5 Test Result of Emission Bandwidth

Emission Bandwidth Result				
Mode	Ch.	Freq. (MHz)	26dB Bandwidth (MHz)	99% Bandwidth (MHz)
WCDMA850	4132	826.4	4.655	4.1179
	4182	836.4	4.645	4.1479
	4233	846.6	4.640	4.1779
WCDMA1900	9262	1852.4	4.695	4.1529
	9400	1880.0	4.710	4.2178
	9538	1907.6	4.700	4.1879
Limit			N/A	
Result			Complied	

3.1.6 Emission Designator

Emission Designator	
Mode	Emission Designator
WCDMA850	4M17F9W
WCDMA1900	4M21F9W

Note 1: WCDMA 99% BW, F = Frequency Modulation, 9 = Composite Digital Info, W = Combination (Audio/Data)

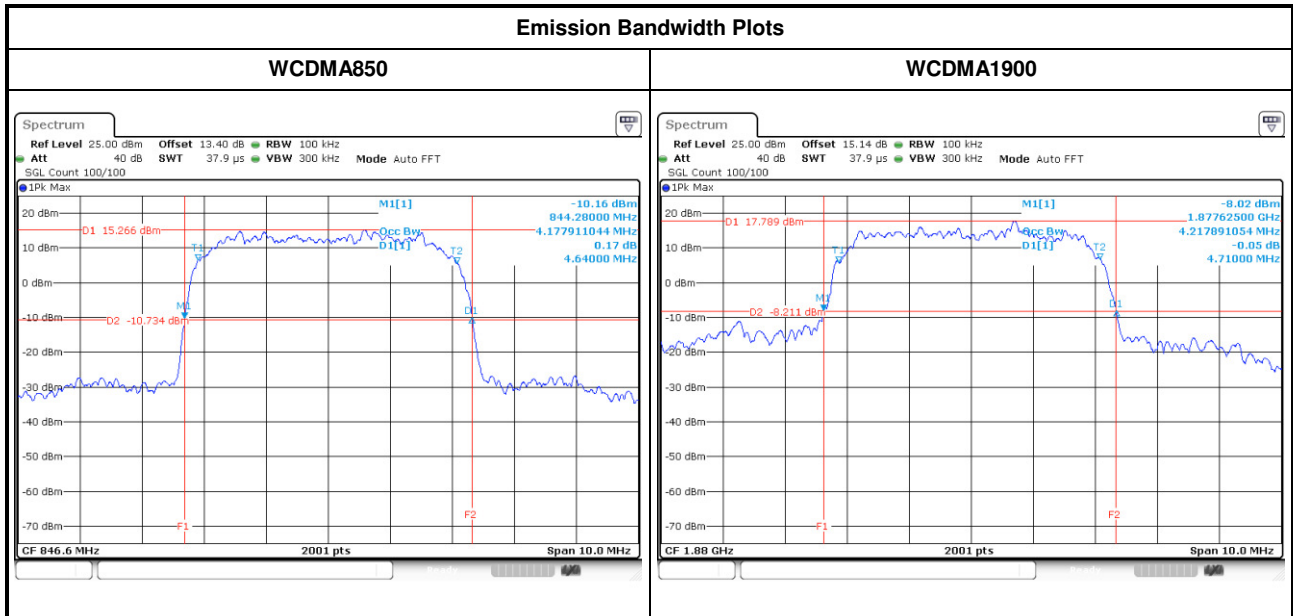

3.2 Transmitter Conducted Output Power

3.2.1 Transmitter Conducted Output Power Limit

Transmitter Conducted Output Power Limit
Information for RF exposure

3.2.2 Transmitter Peak to Average Ratio Limit

Transmitter Peak to Average Ratio Limit
PAR ≤ 13dB

3.2.3 Measuring Instruments

Refer a test equipment and calibration data table in this test report.

3.2.4 Test Procedures

Test Method	
<input checked="" type="checkbox"/>	Transmitter Conducted Output Power
<input type="checkbox"/>	Refer as KDB 941225 D01 clause 5 for GSM GPRS EDGE modes.
<input type="checkbox"/>	Refer as KDB 941225 D01 clause 5 for GSM/(E)GPRS Dual Transfer Mode.
<input checked="" type="checkbox"/>	Refer as KDB 941225 D01 clause 4 for 3G device modes.
<input checked="" type="checkbox"/>	Refer as KDB 941225 D01 clause 4 for 3GPP R6, R7 and R8 additional information.
<input type="checkbox"/>	Refer as KDB 941225 D05 for LTE modes.
<input type="checkbox"/>	Refer as RSS-Gen, clause 6.12 for power measurement.
<input checked="" type="checkbox"/>	Transmitter Peak-Average Ratio
<input checked="" type="checkbox"/>	For WCDMA signals refer as KDB 971168, clause 5.7 for CCDF function.
<input type="checkbox"/>	For GSM signals refer average and a peak trace are used on a spectrum analyzer to determine the largest deviation between the average and the peak power.
<input checked="" type="checkbox"/>	For conducted measurement.
<input checked="" type="checkbox"/>	If EUT supports single transmit chain and measurements performed on this transmit chain.
<input type="checkbox"/>	If EUT supports diversity transmitting and the results on transmit chain port 1 is the worst case.
<input type="checkbox"/>	If EUT supports multiple transmit chains using options given below: Refer as FCC KDB 662911, In-band power measurements. Using the measure-and-sum approach, measured all transmit ports individually. Sum the power (in linear power units e.g., mW) of all ports for each individual sample and save them.

3.2.5 Test Setup

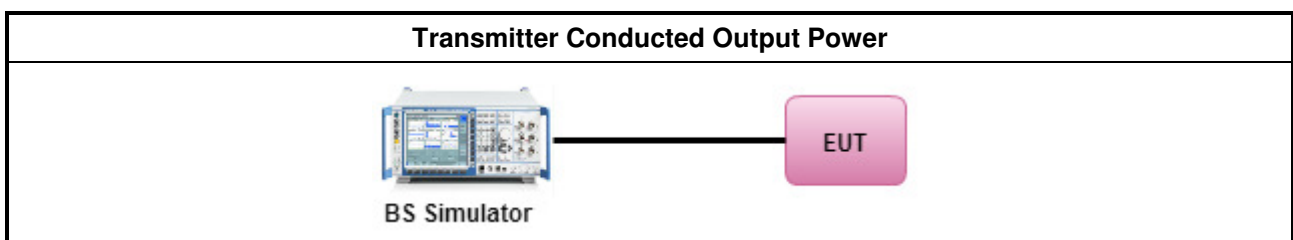

3.2.6 Test Result of Transmitter Conducted Output Power

WCDMA Worst Modulation for Output Power		
3GPP Release Ver.	Mode	Configuration
99	WCDMA	12.2kbps RMC
5	HSDPA	Subtest 1 ~ Subtest 4
6	HSUPA	Subtest 1 ~ Subtest 5

Mode	Subtest	RF Output Power [dBm]						MPR [dB]
		Band V (Cellular)			Band II (PCS)			
		4132	4182	4233	9262	9400	9538	
WCDMA	12.2 kbps RMC	22.16	22.54	21.77	23.43	22.44	22.20	0.5
HSDPA	Subtest 1	20.88	22.47	21.79	21.98	21.18	21.03	0.5
	Subtest 2	21.00	22.41	21.85	21.94	21.17	21.01	0.5
	Subtest 3	20.51	21.95	21.28	21.41	20.70	20.53	1.0
	Subtest 4	20.61	21.97	21.38	21.42	20.72	20.56	1.0
HSUPA	Subtest 1	21.88	21.80	20.91	21.54	20.65	20.56	0.0
	Subtest 2	19.95	19.93	19.84	19.95	19.97	19.89	0.0
	Subtest 3	20.97	20.93	20.59	20.98	20.59	19.91	0.0
	Subtest 4	19.99	19.95	19.85	19.99	19.97	19.94	0.0
	Subtest 5	20.92	21.61	20.60	21.51	20.50	20.46	0.0

3.2.7 Test Result of Transmitter Peak to Average Ratio

Transmitter Peak to Average Ratio Result			
Mode	Ch.	Freq. (MHz)	Peak to Average Ratio (dB)
WCDMA850	4132	826.4	3.45
	4182	836.4	3.33
	4233	846.6	3.51
WCDMA1900	9262	1852.4	2.67
	9400	1880	2.41
	9538	1907.6	2.38
Limit			13
Result			Complied

3.3 Effective Radiated Power

3.3.1 Effective Radiated Power Limit

Cellular Band Effective Radiated Power (ERP) Limit
ERP ≤ 7W [38.45dBm] (EIRP 40.6dBm [135.8 dBuV/m at 3m]).

3.3.2 Measuring Instruments

Refer a test equipment and calibration data table in this test report.

3.3.3 Test Procedures

Test Method	
<input checked="" type="checkbox"/>	For wideband (> 1 MHz) digital transmission systems power measure following as KDB 971168.
<input checked="" type="checkbox"/>	Effective Radiated Power (ERP)
<input checked="" type="checkbox"/>	Refer as KDB 412172, clause 1.2 following as power approach. e.i.r.p.= $P_T+G_T+L_C$.
<input type="checkbox"/>	Refer as KDB 412172, clause 1.1 following as field strength approach. e.i.r.p.= $(E \times d)^2 / 30$.
<input checked="" type="checkbox"/>	Refer as KDB 412172, clause 1.3 ERP = EIRP - 2.15 dB.
<input checked="" type="checkbox"/>	For radiated measurement.
<input type="checkbox"/>	Refer as KDB 412172, clause 2.2 following eirp can be used radiated test configuration.
<input checked="" type="checkbox"/>	Refer as KDB 412172, clause 2.3 following eirp can be used signal/antenna substitution techniques.
<input type="checkbox"/>	Refer as ANSI/TIA-603-D-2010, clause 2.2.17 for radiated measurement.
<input type="checkbox"/>	Refer as RSS-Gen, clause 6.12 for power measurement.

3.3.4 Test Setup

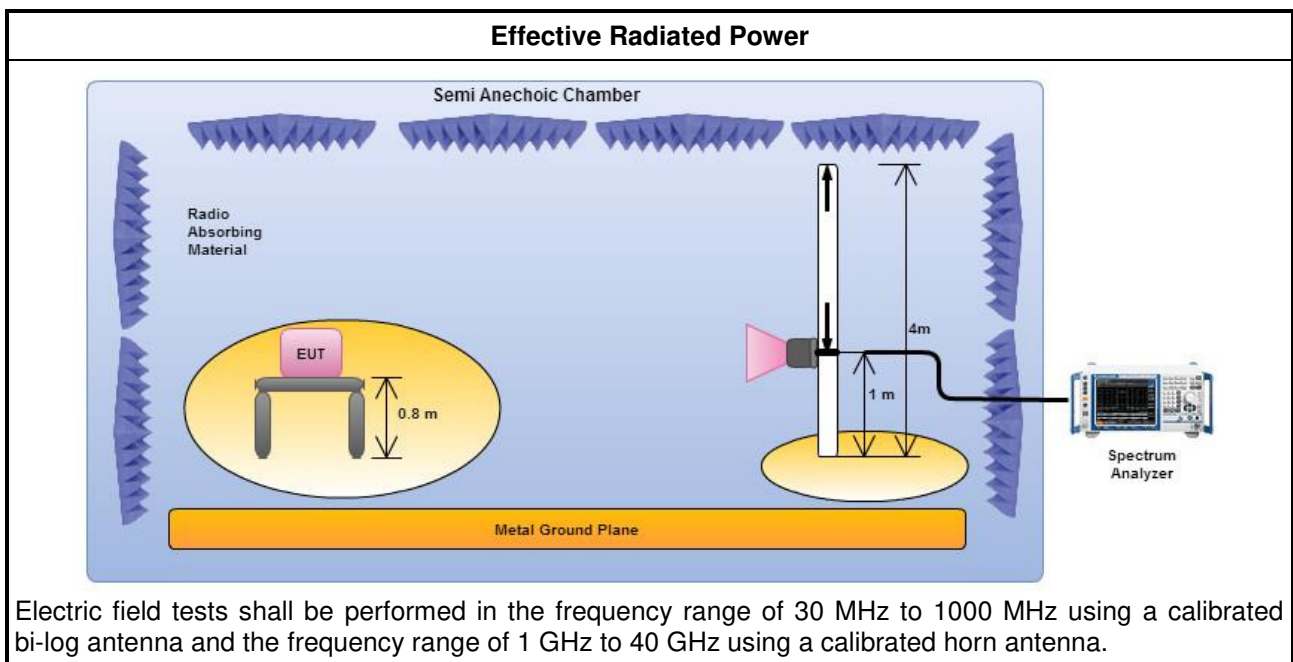



3.3.5 Test Result of Effective Radiated Power

Mode	Channel	Frequency (MHz)	ERP(dBm)	SPA Reading (dBm)	S.G. Power (dBm)	TX Cable loss (dB)	TX Antenna Gain (dBi)	Polarization (H/V)
WCDMA850	4132	826.4	12.15	-25.09	6.65	0.25	7.9	H
	4182	836.4	11.24	-26.36	5.55	0.25	8.09	H
	4233	846.6	11.94	-25.75	6.05	0.25	8.29	H

Note 1: EUT was tested in all WCDMA/HSDPA configurations and the highest power is reported in 12.2 kbps RMC and TPC bits all set "1".
Note 2: EUT was tested with its standard battery.
Note 3: Measurement worst emissions of receive antenna polarization.

3.4 Effective Isotropic Radiated Power

3.4.1 Effective Isotropic Radiated Power Limit

PCS Band and AWS Band Effective Isotropic Radiated Power (EIRP) Limit
PCS Band: EIRP ≤ 2W [33.01dBm] (128.2 dBuV/m at 3m)
AWS Band: EIRP ≤ 1W [30.00dBm] (125.2 dBuV/m at 3m)

3.4.2 Measuring Instruments

Refer a test equipment and calibration data table in this test report.

3.4.3 Test Procedures

Test Method	
<input checked="" type="checkbox"/>	For wideband (> 1 MHz) digital transmission systems power measure following as KDB 971168.
<input checked="" type="checkbox"/>	Effective Isotropic Radiated Power (EIRP)
<input checked="" type="checkbox"/>	Refer as KDB 412172, clause 1.2 following as power approach. e.i.r.p.= $P_T+G_T+L_C$.
<input type="checkbox"/>	Refer as KDB 412172, clause 1.1 following as field strength approach. e.i.r.p.= $(E \times d)^2 / 30$.
<input checked="" type="checkbox"/>	For radiated measurement.
<input type="checkbox"/>	Refer as KDB 412172, clause 2.2 following eirp can be used radiated test configuration.
<input checked="" type="checkbox"/>	Refer as KDB 412172, clause 2.3 following eirp can be used signal/antenna substitution techniques.
<input type="checkbox"/>	Refer as ANSI/TIA-603-D-2010, clause 2.2.17 for radiated measurement.
<input type="checkbox"/>	Refer as RSS-Gen, clause 6.12 for power measurement.

3.4.4 Test Setup

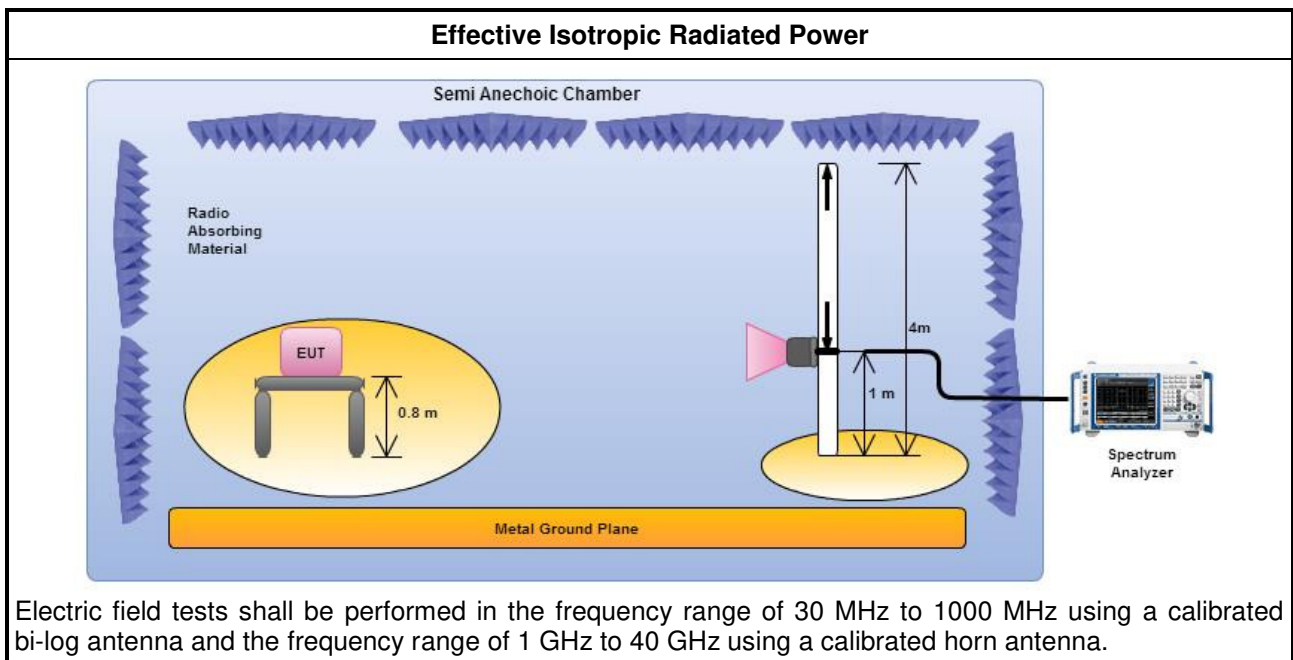



3.4.5 Test Result of Effective Isotropic Radiated Power

Mode	Channel	Frequency (MHz)	ERP(dBm)	SPA Reading (dBm)	S.G. Power (dBm)	TX Cable loss (dB)	TX Antenna Gain (dBi)	Polarization (H/V)
WCDMA1900	9262	1852.4	18.97	-19.69	17.04	2.57	4.50	V
	9400	1880.0	20.37	-18.49	18.56	2.60	4.41	V
	9538	1907.6	20.02	-18.67	18.31	2.60	4.31	V

Note 1: EUT was tested in all WCDMA/HSDPA configurations and the highest power is reported in 12.2 kbps RMC and TPC bits all set "1".

Note 2: EUT was tested with its standard battery.

Note 3: Measurement worst emissions of receive antenna polarization.

3.5 Transmitter Conducted Unwanted Emissions

3.5.1 Transmitter Conducted Unwanted Emissions Limit

Transmitter Conducted Unwanted Emissions Limit
The power of any emission outside a licensee's frequency band(s) of operation shall be attenuated below the transmitter power (P) within the licensed band(s) of operation, measured in watts, by at least $[43 + 10 \log(P)]$ (-13dBm).

3.5.2 Measuring Instruments

Refer a test equipment and calibration data table in this test report.

3.5.3 Test Procedures

Test Method		
<input checked="" type="checkbox"/> Refer as ANSI/TIA-603-D-2010, clause 3.2.13 for conducted measurement.		
<input type="checkbox"/> Refer as RSS-Gen, clause 6.13 for transmitter unwanted emissions measurement.		
<input type="checkbox"/> In case a narrower measurement bandwidth was used, the following conversion formula has to be applied: (e.g. if reference bandwidth 1 MHz and measurement bandwidth 100 kHz, then measurement bandwidth conversion factor is 10 dB); $B = A + 10 \log(BW_{ref} / BW_{measured})$ <ul style="list-style-type: none"> • A is the value at the narrower measurement bandwidth; • B is the value referred to the reference bandwidth; • Correction Factor(dB)= $10\log(1\% \text{ Emission BW/RBW})$; 		
<input checked="" type="checkbox"/> For conducted measurement.		
<input checked="" type="checkbox"/> For conducted measurements on devices with single transmit chain. <input type="checkbox"/> For conducted measurements on devices with multiple transmit chains using options given below: <table border="1" style="margin-left: 20px;"> <tr> <td><input type="checkbox"/> Option 1: measure and sum the spectra across the transmitter outputs.</td> </tr> <tr> <td><input type="checkbox"/> Option 2: N transmitter outputs, then spurious emissions limits on each individual output. Measure and add $10 \log(N)$ dB.</td> </tr> </table>	<input type="checkbox"/> Option 1: measure and sum the spectra across the transmitter outputs.	<input type="checkbox"/> Option 2: N transmitter outputs, then spurious emissions limits on each individual output. Measure and add $10 \log(N)$ dB.
<input type="checkbox"/> Option 1: measure and sum the spectra across the transmitter outputs.		
<input type="checkbox"/> Option 2: N transmitter outputs, then spurious emissions limits on each individual output. Measure and add $10 \log(N)$ dB.		

3.5.4 Test Setup

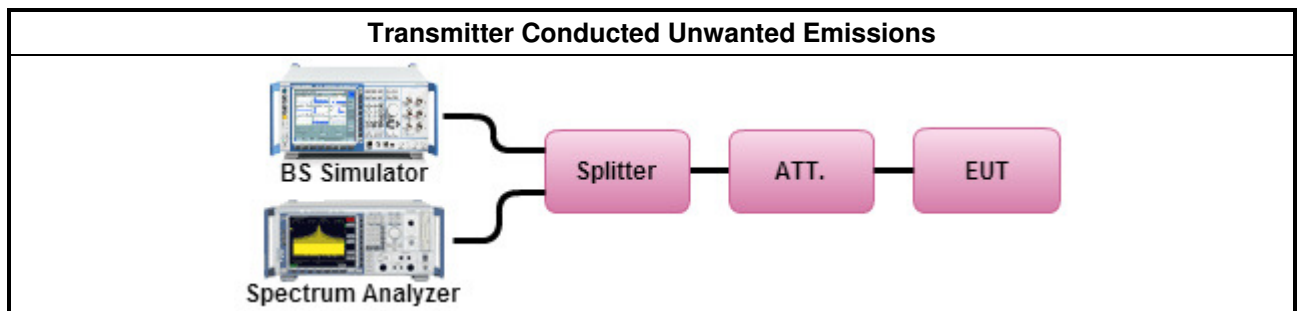



3.5.5 Test Result of Transmitter Conducted Unwanted Emissions

Transmitter Conducted Unwanted Emissions		Mode
Channel	4182	WCDMA850
		Test Range
		30 MHz - 10 harmonic
Transmitter Conducted Unwanted Emissions		Mode
Channel	9400	WCDMA1900
		Test Range
		30 MHz - 10 harmonic

Note: "ALIGN OFF" means that we turn off the auto align. We align the spectrum at each time before test.

3.6 Transmitter Conducted Bandedge Emissions

3.6.1 Transmitter Conducted Bandedge Emissions Limit

Transmitter Conducted Bandedge Emissions Limit
<p>Cellular Band:</p> <p>(i) In the first 1.0 MHz band immediately outside frequency block, the power of emissions per any 1% of the emission bandwidth shall be attenuated (in dB) below the transmitter output power P (dBW) by at least $43 + 10 \log(P)$ (watts) (-13dBm).</p> <p>(ii) After the first 1.0 MHz immediately outside frequency block, the power of emissions in any 100 kHz bandwidth shall be attenuated (in dB) below the transmitter output power P (dBW) by at least $43 + 10 \log(P)$ (watts) (-13dBm). If the measurement is performed using 1% of the emission bandwidth, power integration over 100 kHz is required.</p> <p>PCS Band:</p> <p>(i) In the 1.0 MHz bands immediately outside frequency block, the emission power per any 1% of the emission bandwidth shall be attenuated (in dB) below the transmitter output power P (dBW) by at least $43 + 10 \log(P)$ (watts) (-13dBm).</p> <p>(ii) After the first 1.0 MHz immediately outside frequency block, the power of emissions in any 1 MHz bandwidth shall be attenuated (in dB) below the transmitter output power P (dBW) by at least $43 + 10 \log(P)$ (watts) (-13dBm). If the measurement is performed using 1% of the occupied bandwidth, power integration over 1 MHz is required.</p>

3.6.2 Measuring Instruments

Refer a test equipment and calibration data table in this test report.

3.6.3 Test Procedures

Test Method	
<input checked="" type="checkbox"/>	Refer as ANSI/TIA-603-D-2010, clause 3.2.13 for conducted measurement.
<input type="checkbox"/>	Refer as RSS-Gen, clause 6.13 for transmitter unwanted emissions measurement.
<input type="checkbox"/>	<p>In case a narrower measurement bandwidth was used, the following conversion formula has to be applied: (e.g. if reference bandwidth 1 MHz and measurement bandwidth 100 kHz, then measurement bandwidth conversion factor is 10 dB); $B = A + 10 \log (BW_{ref} / BW_{measured})$</p> <ul style="list-style-type: none"> • A is the value at the narrower measurement bandwidth; • B is the value referred to the reference bandwidth; • Correction Factor(dB)= $10\log(1\% \text{ Emission BW/RBW})$;
<input checked="" type="checkbox"/>	For conducted measurement.
<input checked="" type="checkbox"/>	For conducted measurements on devices with single transmit chain.
<input type="checkbox"/>	For conducted measurements on devices with multiple transmit chains using options given below:
<input type="checkbox"/>	Option 1: measure and sum the spectra across the transmitter outputs.
<input type="checkbox"/>	Option 2: N transmitter outputs, then spurious emissions limits on each individual output. Measure and add $10 \log (N)$ dB.

3.6.4 Test Setup

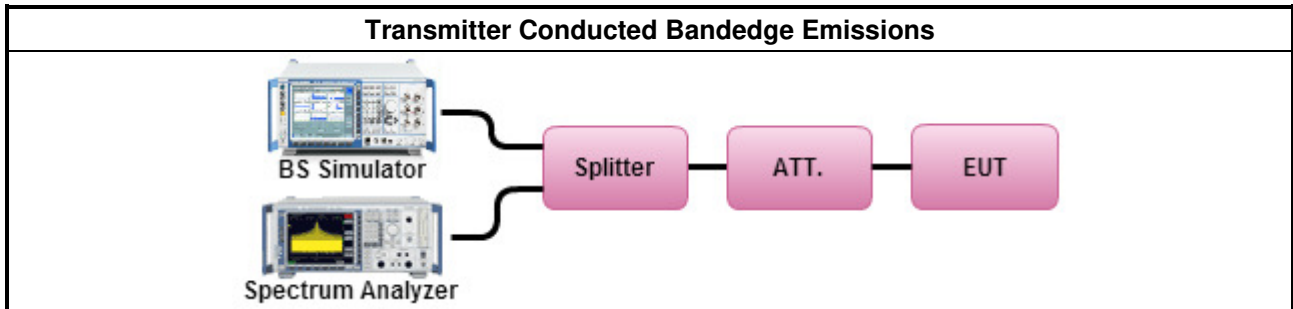

3.6.5 Test Result of Transmitter Conducted Bandedge Emissions

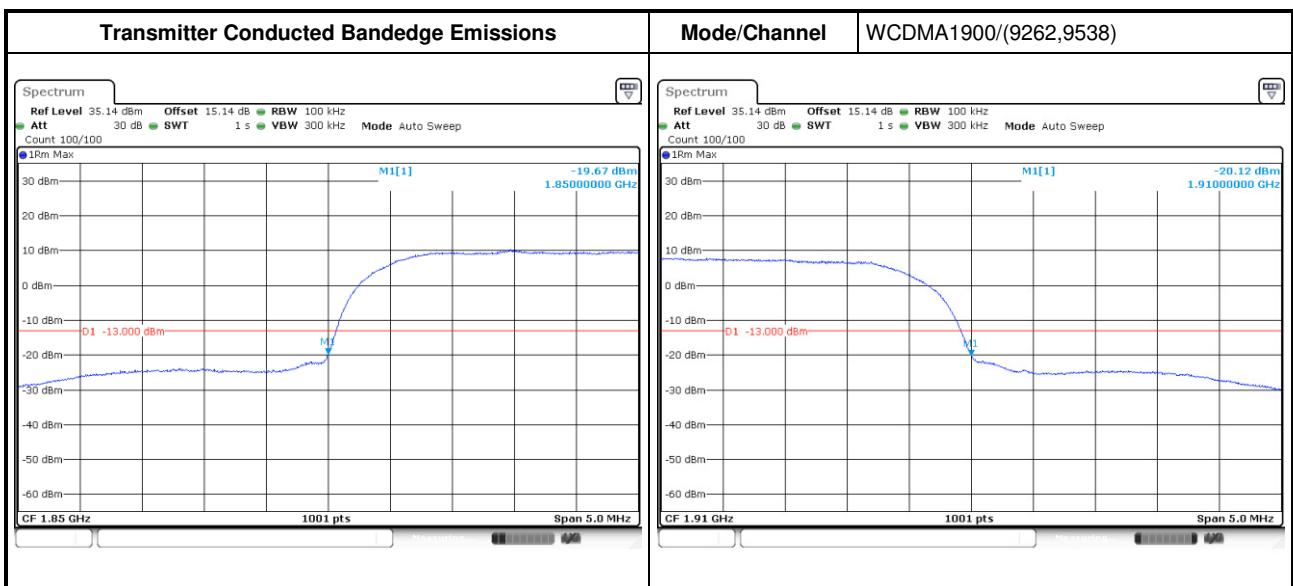
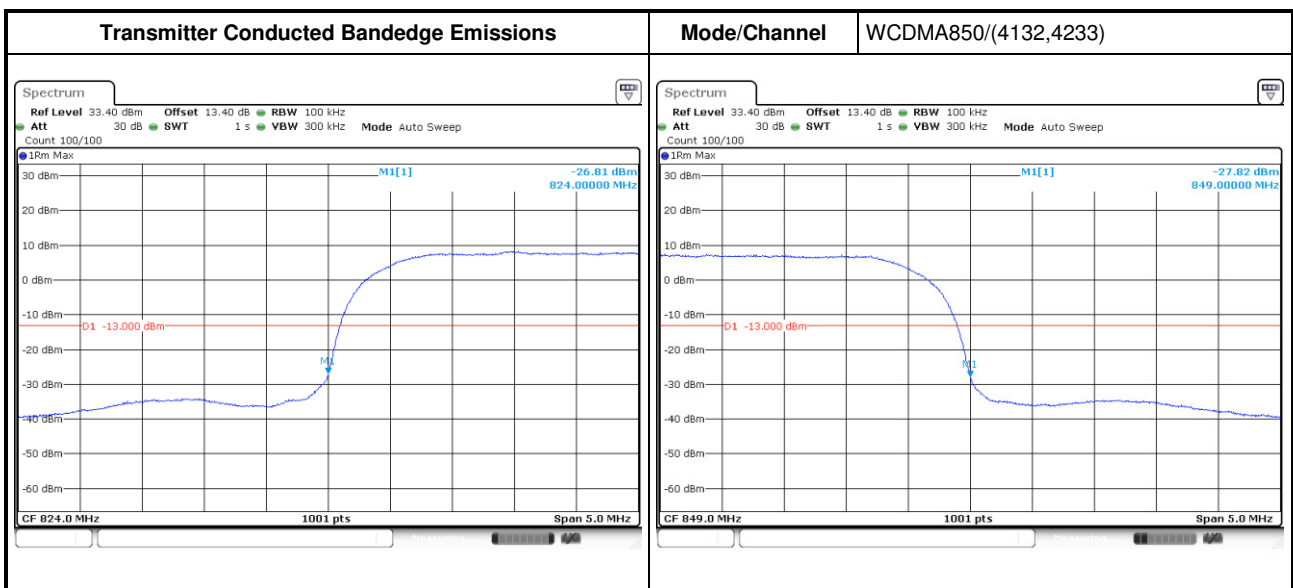

Note: "ALIGN OFF" means that we turn off the auto align. We align the spectrum at each time before test.



3.7 Transmitter Radiated Unwanted Emissions

3.7.1 Transmitter Radiated Unwanted Emissions Limit

Transmitter Radiated Unwanted Emissions Limit
The power of any emission outside a licensee's frequency band(s) of operation shall be attenuated below the transmitter power (P) within the licensed band(s) of operation, measured in watts, by at least [43 + 10 log (P)] (EIRP -13dBm).

3.7.2 Measuring Instruments

Refer a test equipment and calibration data table in this test report.

3.7.3 Test Procedures

Test Method
<input checked="" type="checkbox"/> Refer as ANSI/TIA-603-D-2010, clause 3.2.12 for radiated measurement.
<input type="checkbox"/> Refer as RSS-Gen, clause 4.9 for transmitter unwanted emissions measurement.
<input type="checkbox"/> In case a narrower measurement bandwidth was used, the following conversion formula has to be applied: (e.g. if reference bandwidth 1 MHz and measurement bandwidth 100 kHz, then measurement bandwidth conversion factor is 10 dB) $B = A + 10 \log (BW_{ref} / BW_{measured})$ • A is the value at the narrower measurement bandwidth; • B is the value referred to the reference bandwidth; • Correction Factor(dB)= 10log(1% Emission BW/RBW);
<input checked="" type="checkbox"/> Effective Isotropic Radiated Power (EIRP)
<input checked="" type="checkbox"/> Refer as KDB 412172, clause 1.2 following as power approach. e.i.r.p.= $P_T+G_T+L_C$. <input type="checkbox"/> Refer as KDB 412172, clause 1.1 following as field strength approach. e.i.r.p.= $(E \times d)^2 / 30$.
<input checked="" type="checkbox"/> For radiated measurement.
<input type="checkbox"/> Refer as KDB 412172, clause 2.2 following eirp can be used radiated test configuration. <input checked="" type="checkbox"/> Refer as KDB 412172, clause 2.3 following eirp can be used signal/antenna substitution techniques. <input type="checkbox"/> Refer as ANSI/TIA-603-D-2010, clause 2.2.17 for radiated measurement. <input type="checkbox"/> Refer as RSS-Gen, clause 6.12 for power measurement.

3.7.4 Test Setup

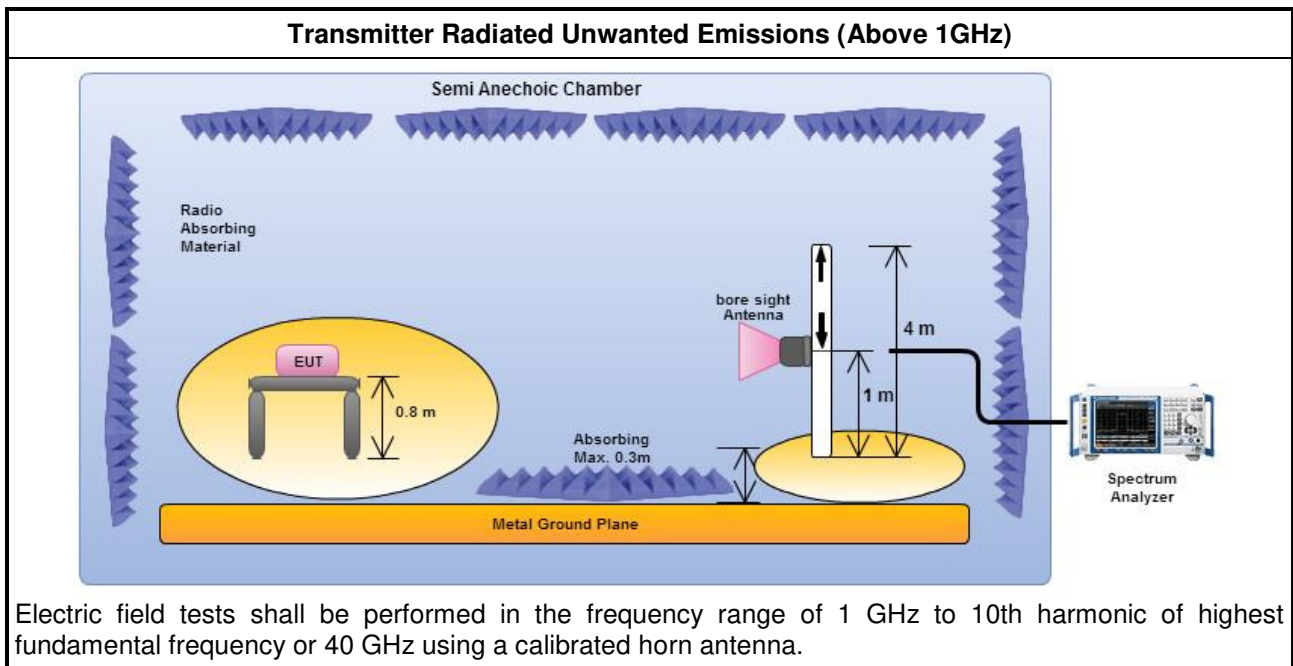
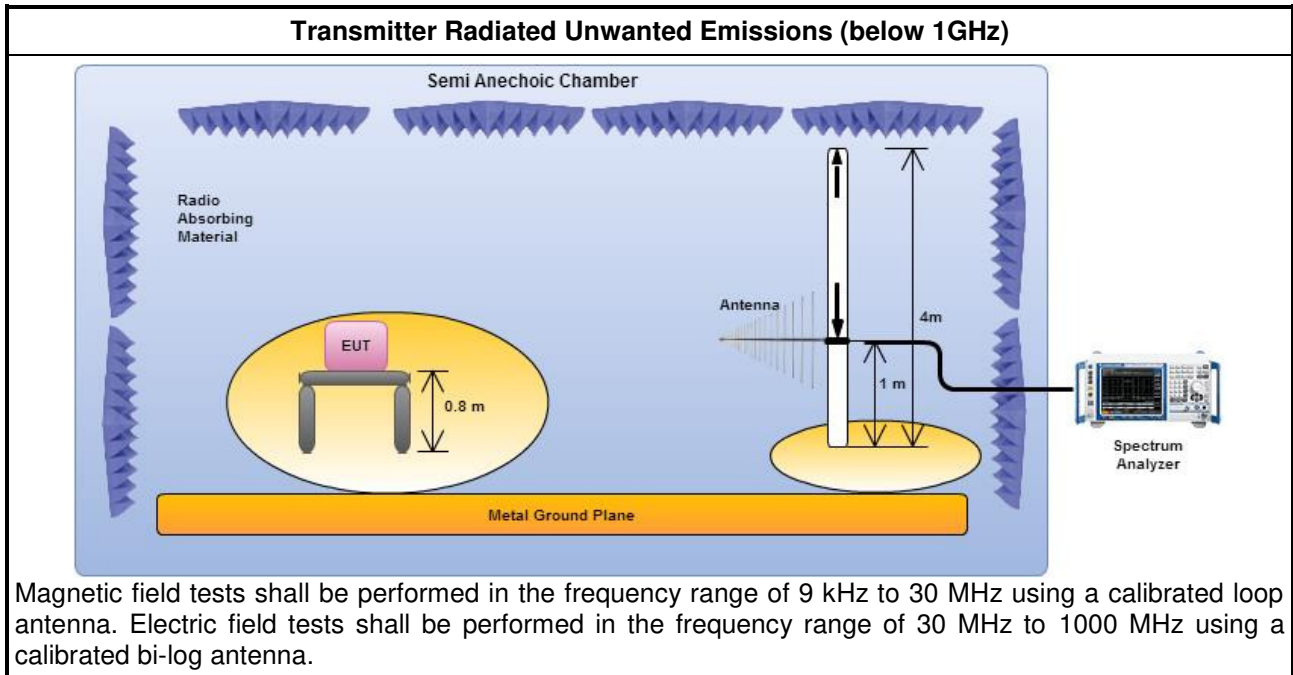



3.7.5 Test Result of Transmitter Radiated Unwanted Emissions(Below 1GHz)

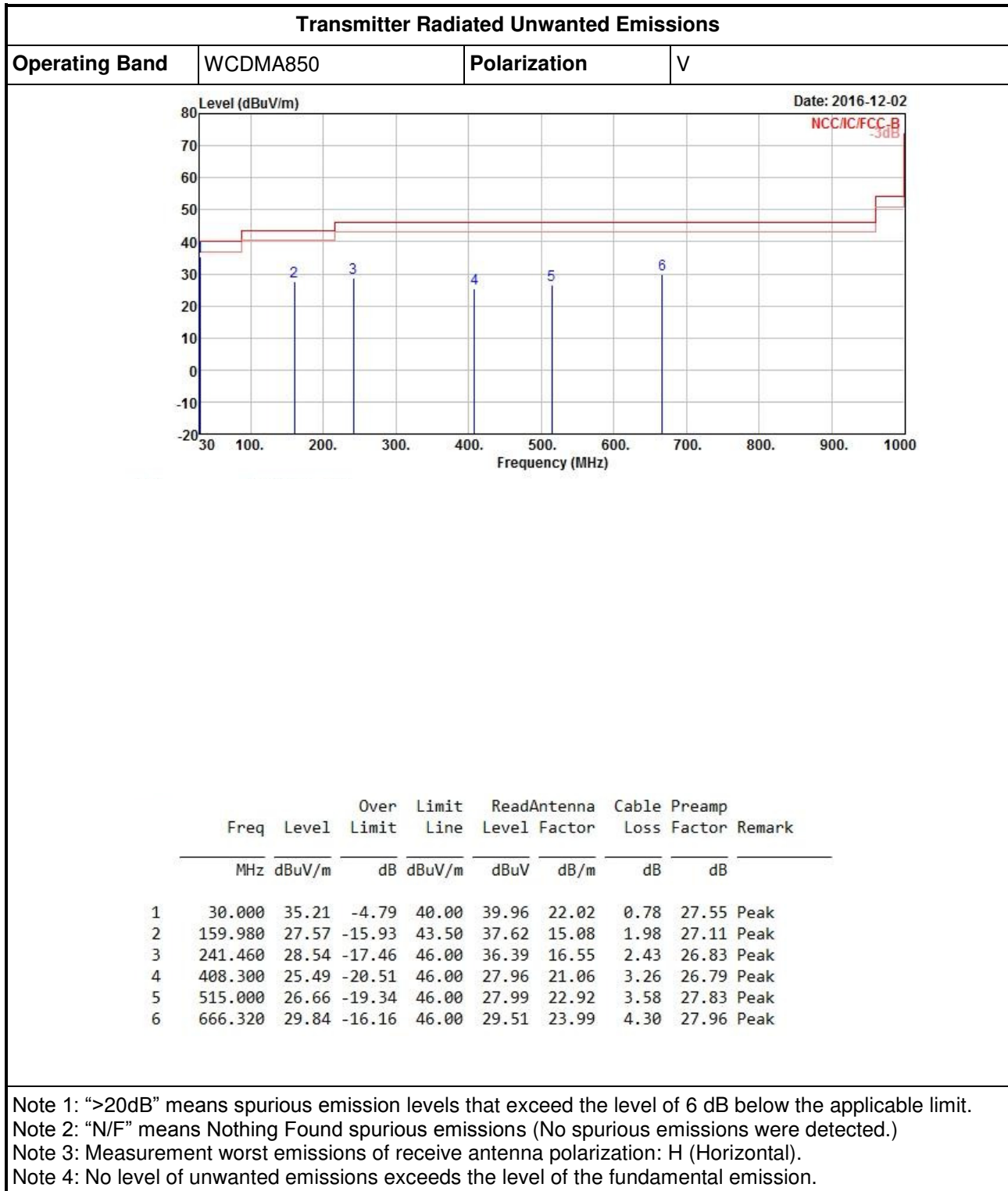



Transmitter Radiated Unwanted Emissions

Operating Band	WCDMA850	Polarization	H
----------------	----------	--------------	---

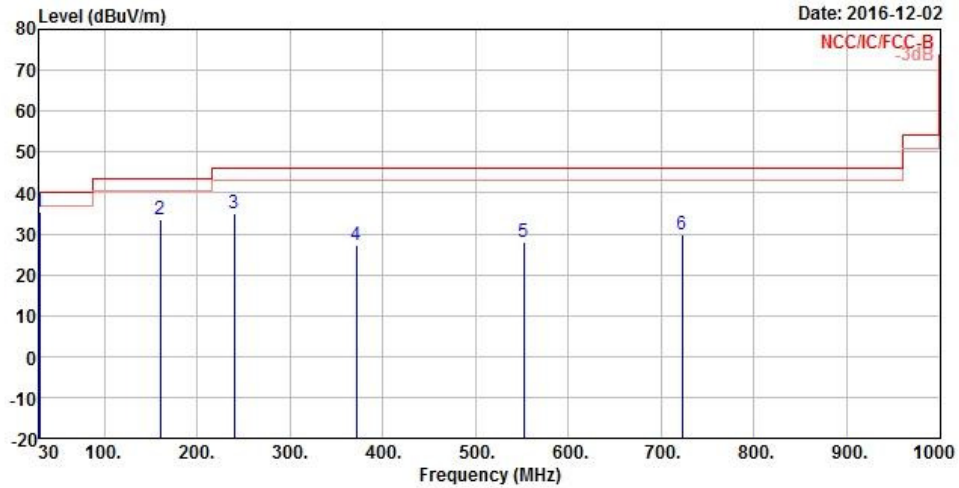

	Freq	Level	Over Limit	Limit Line	ReadAntenna Level	Antenna Factor	Cable Loss	Preamp Factor	Remark
	MHz	dBuV/m	dB	dBuV/m	dBuV	dB/m	dB	dB	
1	30.000	35.45	-4.55	40.00	40.20	22.02	0.78	27.55	Peak
2	159.980	33.64	-9.86	43.50	43.69	15.08	1.98	27.11	Peak
3	239.520	34.85	-11.15	46.00	42.91	16.35	2.42	26.83	Peak
4	371.440	27.15	-18.85	46.00	30.62	20.08	3.15	26.70	Peak
5	551.860	27.83	-18.17	46.00	28.27	23.81	3.66	27.91	Peak
6	722.580	29.81	-16.19	46.00	28.94	24.31	4.46	27.90	Peak

Note 1: ">20dB" means spurious emission levels that exceed the level of 6 dB below the applicable limit.
 Note 2: "N/F" means Nothing Found spurious emissions (No spurious emissions were detected.)
 Note 3: Measurement worst emissions of receive antenna polarization: H (Horizontal).
 Note 4: No level of unwanted emissions exceeds the level of the fundamental emission.



Transmitter Radiated Unwanted Emissions

Operating Band	WCDMA1900	Polarization	V
----------------	-----------	--------------	---

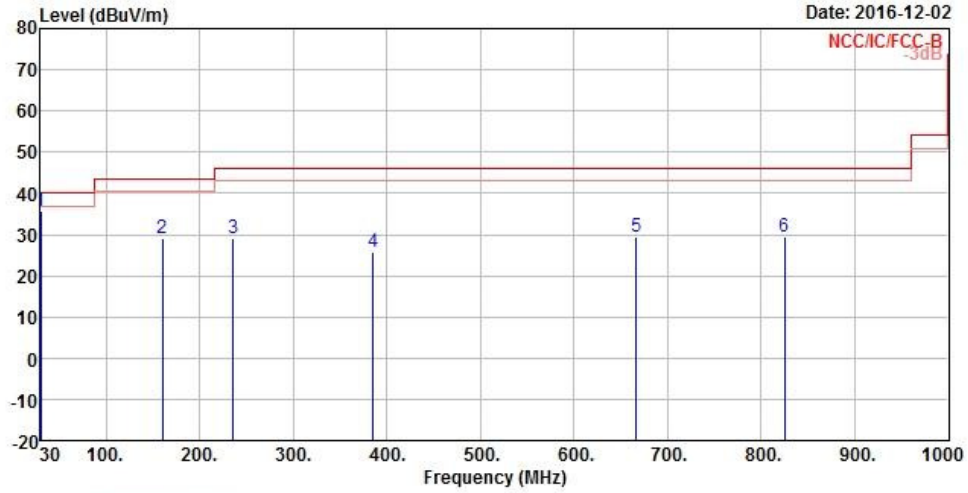

	Freq	Level	Over Limit	Limit	ReadAntenna	Cable	Preamp	Remark
	MHz	dBUV/m	dB	dBUV/m	dBuV	dB/m	dB	dB
1	30.000	35.81	-4.19	40.00	40.56	22.02	0.78	27.55 Peak
2	159.980	29.03	-14.47	43.50	39.08	15.08	1.98	27.11 Peak
3	235.640	29.21	-16.79	46.00	37.75	15.89	2.41	26.84 Peak
4	385.020	25.71	-20.29	46.00	28.74	20.48	3.19	26.70 Peak
5	666.320	29.63	-16.37	46.00	29.30	23.99	4.30	27.96 Peak
6	825.400	29.46	-16.54	46.00	27.50	25.04	4.63	27.71 Peak

Note 1: ">20dB" means spurious emission levels that exceed the level of 6 dB below the applicable limit.
 Note 2: "N/F" means Nothing Found spurious emissions (No spurious emissions were detected.)
 Note 3: Measurement worst emissions of receive antenna polarization: H (Horizontal).
 Note 4: No level of unwanted emissions exceeds the level of the fundamental emission.



Transmitter Radiated Unwanted Emissions

Operating Band	WCDMA1900	Polarization	H
----------------	-----------	--------------	---

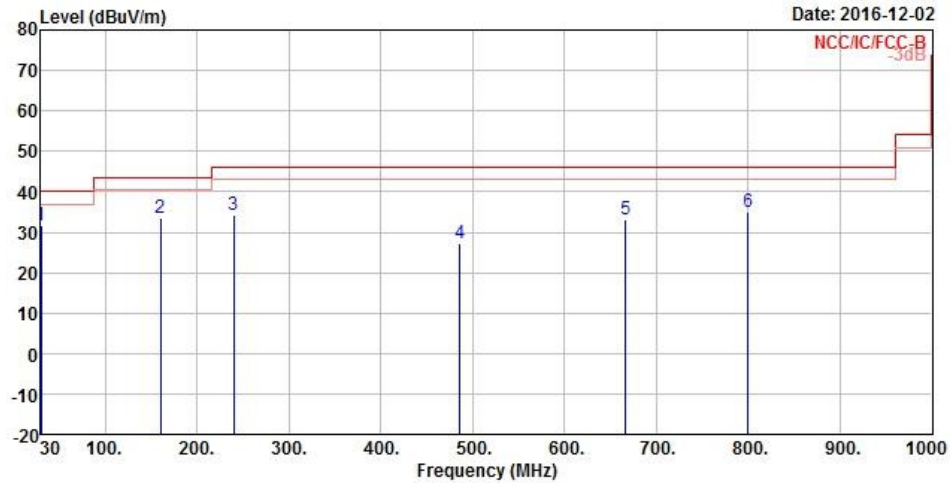

	Freq	Level	Over Limit	Limit Line	ReadAntenna Level	Cable Loss	Preamp Factor	Remark
	MHz	dBuV/m	dB	dBuV/m	dBuV	dB/m	dB	dB
1	30.000	31.53	-8.47	40.00	36.28	22.02	0.78	27.55 Peak
2	159.980	33.59	-9.91	43.50	43.64	15.08	1.98	27.11 Peak
3	239.520	34.08	-11.92	46.00	42.14	16.35	2.42	26.83 Peak
4	485.900	27.34	-18.66	46.00	29.13	22.34	3.51	27.64 Peak
5	666.320	33.00	-13.00	46.00	32.67	23.99	4.30	27.96 Peak
6	800.180	34.94	-11.06	46.00	33.34	24.82	4.56	27.78 Peak

Note 1: ">20dB" means spurious emission levels that exceed the level of 6 dB below the applicable limit.
 Note 2: "N/F" means Nothing Found spurious emissions (No spurious emissions were detected.)
 Note 3: Measurement worst emissions of receive antenna polarization: H (Horizontal).
 Note 4: No level of unwanted emissions exceeds the level of the fundamental emission.



3.7.6 Test Result of Transmitter Radiated Unwanted Emissions(Above 1GHz)

Mode	WCDMA850(BAND5)								
Frequency (MHz)	ERP(dBm)	Limit(dBm)	Over Limit (dB)	SPA. Reading (dBm)	S.G. Power (dBm)	TX Cable loss (dB)	TX Antenna Gain (dBi)	Polarization (H/V)	Result
1672.80	-66.99	-13	-53.99	-59.03	-67.53	2.42	5.11	H	PASS
2509.20	-64.39	-13	-51.39	-64.77	-64.69	3.07	5.52	H	PASS
3345.60	-65.43	-13	-52.43	-67.77	-67.5	3.48	7.70	H	PASS

Mode	WCDMA1900(BAND2)								
Frequency (MHz)	EIRP(dBm)	Limit(dBm)	Over Limit (dB)	SPA. Reading (dBm)	S.G. Power (dBm)	TX Cable loss (dB)	TX Antenna Gain (dBi)	Polarization (H/V)	Result
3760	-43.77	-13	-30.77	-59.16	-48.41	3.77	8.41	H	PASS
5640	-54.14	-13	-41.14	-66.95	-59.39	5.01	10.26	H	PASS
7520	-49.64	-13	-36.64	-66.66	-55.76	5.7	11.82	H	PASS

3.8 Frequency Stability

3.8.1 Frequency Stability Limit

Frequency Stability Limit	
<input checked="" type="checkbox"/>	The transmitter center frequency stability shall be ± 2.5 ppm maximum. The frequency stability shall be sufficient to ensure that the fundamental emissions stay within the authorized bands of operation.
<input checked="" type="checkbox"/>	Temperature:
<input checked="" type="checkbox"/>	-20°C to +50°C in 10°C step.
<input checked="" type="checkbox"/>	If the EUT cannot be turned on at -30°C, the testing lowest temperature will be raised in 10°C step until the EUT can be turned on.
<input checked="" type="checkbox"/>	Voltage:
<input type="checkbox"/>	For non hand-carried battery and AC powered equipment: 85% to 115% of the nominal value
<input checked="" type="checkbox"/>	For hand-carried, battery-powered equipment: Voltage is reduced to the battery operating end point which shall be specified by the manufacturer.
Note 1: These measurements shall also be performed at normal and extreme test conditions.	

3.8.2 Measuring Instruments

Refer a test equipment and calibration data table in this test report.

3.8.3 Test Procedures

Test Method	
<input checked="" type="checkbox"/>	Refer as ANSI/TIA-603-D-2010, clause 3.2.2 for frequency stability tests
<input type="checkbox"/>	Refer as RSS-Gen, clause 6.11 for transmitter frequency stability measurement.
<input checked="" type="checkbox"/>	Frequency stability with respect to ambient temperature
<input checked="" type="checkbox"/>	Frequency stability when varying supply voltage
<input checked="" type="checkbox"/>	For conducted measurement.
<input checked="" type="checkbox"/>	For conducted measurements on devices with multiple transmit chains: Measurements need only to be performed on one of the active transmit chains (antenna outputs)
<input type="checkbox"/>	For radiated measurement. The equipment to be measured and the test antenna shall be oriented to obtain the maximum emitted power level.

3.8.4 Test Setup

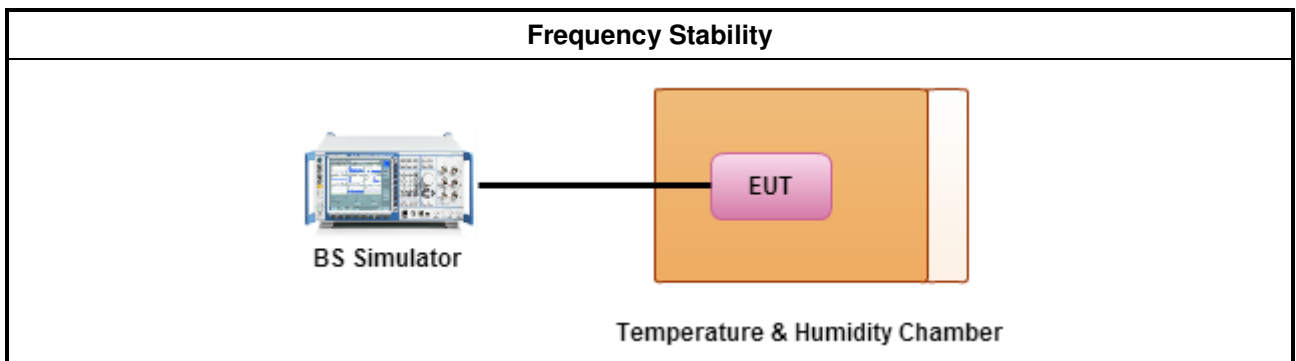



3.8.5 Test Result of Frequency Stability

Mode		WCDMA850		WCDMA1900	
Channel		4182		9400	
Frequency (MHz)		836.4		1880.0	
Temp. (°C)	Voltage (V)	Frequency Error (Hz)	Frequency Error (ppm)	Frequency Error (Hz)	Frequency Error (ppm)
50	14.4	-18.48	-0.0221	-20.83	-0.0111
40	14.4	-17.13	-0.0205	-22.16	-0.0118
30	14.4	-16.76	-0.0200	-21.49	-0.0114
20	14.4	-15.88	-0.0190	-19.94	-0.0106
10	14.4	-12.46	-0.0149	-18.63	-0.0099
0	14.4	-14.61	-0.0175	-19.37	-0.0103
-10	14.4	-15.77	-0.0189	-20.59	-0.0110
-20	14.4	-17.32	-0.0207	-22.34	-0.0119
20	16.8	-16.31	-0.0195	-20.87	-0.0111
20	14.4	-15.59	-0.0186	-19.48	-0.0104
20	13	-14.88	-0.0178	-18.92	-0.0101
Limit [ppm]		± 2.5			



4 Test Equipment and Calibration Data

RF Conducted

Instrument	Manufacturer	Model No.	Serial No.	Characteristics	Calibration Date	Calibration Due Date
Spectrum Analyzer	R&S	FSP 40	100305	9kHz~40GHz	16/02/2016	15/02/2017
Wireless communication test Set	Agilent	8960	108087	Wireless communication test	03/05/2016	02/05/2017
RF Cable-0.5m	HUBER+SUHNER	SUCOFLEX_104	MY10713/4	30MHz ~ 26.5GHz	02/10/2016	01/10/2017
RF Cable-0.5m	HUBER+SUHNER	SUCOFLEX_104	MY10714/4	30MHz ~ 26.5GHz	02/10/2016	01/10/2017
RF Cable-0.5m	HUBER+SUHNER	SUCOFLEX_104	MY10715/4	30MHz ~ 26.5GHz	02/10/2016	01/10/2017

Radiated Emissions

Instrument	Manufacturer	Model No.	Serial No.	Characteristics	Calibration Date	Calibration Due Date
3m Semi Anechoic Chamber	SIDT FRANKONIA	SAC-3M	03CH03-HY	30MHz ~ 1GHz 3m	28/11/2016	27/11/2017
3m Semi Anechoic Chamber	SIDT FRANKONIA	SAC-3M	03CH03-HY	1GHz ~ 18GHz 3m	16/12/2015	15/12/2016
Amplifier	HP	8447D	2944A08033	10kHz ~ 1.3GHz	10/05/2016	09/05/2017
Amplifier	Keysight	83017A	MY53270197	1GHz ~ 26.5GHz	29/08/2016	28/08/2017
Spectrum	R&S	FSV40	101513	9kHz ~ 40GHz	16/02/2016	15/02/2017
Bilog Antenna	SCHAFFNER	CBL 6112B	2723	30MHz ~ 1GHz	01/10/2016	30/09/2017
Horn Antenna	SCHWARZBECK	BBHA9120D	1531	1GHz ~ 18GHz	22/04/2016	21/04/2017
Horn Antenna	SCHWARZBECK	BBHA9170	BBHA9170154	18GHz ~ 40GHz	29/01/2016	28/01/2017
RF-Cable-high	SUHNER	SUHNER	CB222	1GHz ~ 40GHz	28/10/2016	27/10/2017
RF Cable-R03m	Jye Bao	RG142	CB021	9kHz ~ 1GHz	27/10/2016	26/10/2017
Loop Antenna	TESEQ	HLA 6120	31244	9 kHz~30 MHz	02/02/2015	01/02/2017
Wireless communication test Set	Agilent	8960	MY53202219	Wireless communication	03/05/2016	02/05/2017