

FCC Test Report

Equipment : Rugged Tablet Computer
Brand Name : AAEON
Model No. : xRTC-1200x
(x - Where x may be any combination of alphanumeric characters or "-" or blank.)
FCC ID : OHBRTC1200WBGH
Standard : 47 CFR FCC Part 15.225
Operating Band : 13.553 – 13.567 MHz
Applicant / Manufacturer : AAEON Technology Inc.
5F, No. 135, Lane 235, Pao Chiao Rd.,
Hsin-Tien Dist., New Taipei City 23145, Taiwan, R.O.C

The product sample received on Nov. 21, 2016 and completely tested on Dec. 09, 2016. We, SPORTON, would like to declare that the tested sample has been evaluated in accordance with the procedures given in ANSI C63.10-2013 and shown compliance with the applicable technical standards.

The test results in this report apply exclusively to the tested model / sample. Without written approval of SPORTON INTERNATIONAL INC., the test report shall not be reproduced except in full.

Reviewed by:

Phoenix Chen / Assistant Manager





Table of Contents

1	GENERAL DESCRIPTION	5
1.1	Information.....	5
1.2	Testing Applied Standards	8
1.3	Testing Location Information	8
1.4	Measurement Uncertainty	8
2	TEST CONFIGURATION OF EUT.....	9
2.1	The Worst Case Modulation Configuration	9
2.2	Test Channel Frequencies Configuration.....	9
2.3	The Worst Case Measurement Configuration.....	10
2.4	Accessories and Support Equipment	11
2.5	Test Setup Diagram	12
3	TRANSMITTER TEST RESULT	13
3.1	AC Power-line Conducted Emissions	13
3.2	Emission Bandwidth	17
3.3	Field Strength of Fundamental Emissions and Spectrum Mask	19
3.4	Transmitter Radiated Unwanted Emissions	22
3.5	Frequency Stability.....	29
4	TEST EQUIPMENT AND CALIBRATION DATA.....	31

Appendix A. Test Photos

Appendix EP. Photographs Of EUT v01



Summary of Test Result

Conformance Test Specifications					
Report Clause	Ref. Std. Clause	Description	Measured	Limit	Result
1.1.3	15.203	Antenna Requirement	Antenna connector mechanism complied	FCC 15.203	Complied
3.1	15.207	AC Power-line Conducted Emissions	[dBuV]: 18.67MHz 47.38 (Margin 12.62dB) - QP 39.52(Margin 10.48dB) - AV	FCC 15.207	Complied
3.2	15.215(c)	Emission Bandwidth	20dB Bandwidth 2.76 [kHz] F _L : 13.55896 MHz F _H : 13.56160 MHz	Fall in band F _L ≥ 13.553 MHz F _H ≤ 13.567 MHz	Complied
3.3	15.225(a)~(d)	Field Strength of Fundamental Emissions and Spectrum Mask	Fundamental Emissions peak: 63.79 dBuV/m at 3m Device complies with spectrum mask – refer to test data	124 dBuV/m at 3m	Complied
3.4	15.225(d)	Transmitter Radiated Unwanted Emissions	[dBuV/m at 3m]: 934.040MHz 39.10 (Margin 6.90dB) - PK	FCC 15.209	Complied
3.5	15.225(e)	Frequency Stability	35.40 ppm	± 0.01% (100ppm)	Complied



Revision History

Report No.	Version	Description	Issued Date
FR6N1002TW	Rev. 01	Initial issue of report	Jan. 10, 2017



1 General Description

1.1 Information

1.1.1 Product Details

The difference between the report no. : N/A	
The Difference	N/A

Evaluated Test Items	N/A
----------------------	-----

1.1.2 RF General Information

NFC Chip	Brand Name	Model Name
	NXP	NPC100

RF General Information				
Frequency Range	Modulation	Ch. Frequency (MHz)	Channel Number	Field Strength (dBuV/m)
13.553 – 13.567 MHz	ISO 18092 (ASK)	13.56	1	63.79

Note 1: Field strength performed peak level at 3m.

1.1.3 Antenna Information

Antenna Category	
<input checked="" type="checkbox"/>	Integral antenna (antenna permanently attached)
<input type="checkbox"/>	Temporary RF connector provided
<input checked="" type="checkbox"/>	No temporary RF connector provided Transmit chains bypass antenna and soldered temporary RF connector provided for connected measurement. In case of conducted measurements the transmitter shall be connected to the measuring equipment via a suitable attenuator and correct for all losses in the RF path.
<input type="checkbox"/>	External antenna (dedicated antennas)

Antenna General Information		
No.	Ant. Cat.	Ant. Type
1	Integral	Loop



1.1.4 Type of EUT

Identify EUT	
EUT Serial Number	N/A
Presentation of Equipment	<input checked="" type="checkbox"/> Production ; <input type="checkbox"/> Pre-Production ; <input type="checkbox"/> Prototype
Type of EUT	
<input checked="" type="checkbox"/>	Stand-alone
<input type="checkbox"/>	Combined (EUT where the radio part is fully integrated within another device) Combined Equipment - Brand Name / Model No.: ...
<input type="checkbox"/>	Plug-in radio (EUT intended for a variety of host systems) Host System - Brand Name / Model No.: ...
<input type="checkbox"/>	Other:

1.1.5 Test Signal Duty Cycle

Duty Cycle Operation Restriction			
The transmitter is used for		The transmitter is operated	
<input checked="" type="checkbox"/>	Inductive applications	<input checked="" type="checkbox"/>	Automatically triggered
<input type="checkbox"/>	Duty cycle fixed mode	<input checked="" type="checkbox"/>	Duty cycle random mode
Duty cycle mode - NFC-A (ISO 14443-3A)			
Declare transmitter duty cycle / 1 hour =		100%	
Duty cycle Limit			
<input type="checkbox"/>	Class 1 - < 0.1 %	<input type="checkbox"/>	Class 2 - < 1.0 %
<input type="checkbox"/>	Class 3 - < 10 %	<input checked="" type="checkbox"/>	Class 4 - Up to 100 %
Duty cycle mode - NFC-B (ISO 14443-3B)			
Declare transmitter duty cycle / 1 hour =		100%	
Duty cycle Limit			
<input type="checkbox"/>	Class 1 - < 0.1 %	<input type="checkbox"/>	Class 2 - < 1.0 %
<input type="checkbox"/>	Class 3 - < 10 %	<input checked="" type="checkbox"/>	Class 4 - Up to 100 %
Duty cycle mode - NFC-F (ISO 18092)			
Declare transmitter duty cycle / 1 hour =		100%	
Duty cycle Limit			
<input type="checkbox"/>	Class 1 - < 0.1 %	<input type="checkbox"/>	Class 2 - < 1.0 %
<input type="checkbox"/>	Class 3 - < 10 %	<input checked="" type="checkbox"/>	Class 4 - Up to 100 %
Duty cycle mode - NFC-V (ISO 15693)			
Declare transmitter duty cycle / 1 hour =		100%	
Duty cycle Limit			
<input type="checkbox"/>	Class 1 - < 0.1 %	<input type="checkbox"/>	Class 2 - < 1.0 %
<input type="checkbox"/>	Class 3 - < 10 %	<input checked="" type="checkbox"/>	Class 4 - Up to 100 %



1.1.6 EUT Operational Condition

Supply Voltage	<input checked="" type="checkbox"/> AC mains	<input checked="" type="checkbox"/> DC	
Type of DC Source	<input type="checkbox"/> Internal DC supply	<input checked="" type="checkbox"/> External AC adapter	<input checked="" type="checkbox"/> Battery
Test Voltage	<input checked="" type="checkbox"/> Vnom (14.4 V)	<input checked="" type="checkbox"/> Vmax (13.0 V)	<input checked="" type="checkbox"/> Vmin (16.8 V)
Test Climatic	<input checked="" type="checkbox"/> Tnom (20°C)	<input checked="" type="checkbox"/> Tmax (50°C)	<input checked="" type="checkbox"/> Tmin (-20°C)

1.2 Testing Applied Standards

According to the specifications of the manufacturer, the EUT must comply with the requirements of the following standards:

- ♦ 47 CFR FCC Part 15
- ♦ ANSI C63.10-2013
- ♦ KDB 174176 D01

1.3 Testing Location Information

Testing Location				
<input checked="" type="checkbox"/>	HWA YA	ADD : No. 52, Hwa Ya 1st Rd., Hwa Ya Technology Park, Kwei-Shan District, Tao Yuan City, Taiwan, R.O.C.		
		TEL : 886-3-327-3456	FAX : 886-3-327-0973	
Test Condition	Test Site No.	Test Engineer	Test Environment	Test Date
AC Conduction	CO04-HY	Ryan	23°C / 59%	09/12/2016
RF Conducted	TH01-HY	Lisa	22.7°C / 62.4%	02/12/2016
Radiated Emission	03CH03-HY	Jeff	25.6°C / 61%	09/12/2016

Test site registered number [553509] with FCC.

1.4 Measurement Uncertainty

ISO/IEC 17025 requires that an estimate of the measurement uncertainties associated with the emissions test results be included in the report. The measurement uncertainties given below are based on a 95% confidence level (based on a coverage factor (k=2))

Measurement Uncertainty		
Test Item	Uncertainty	
AC power-line conducted emissions	±2.2 dB	
Emission bandwidth	±1.4 %	
Unwanted emissions, conducted	9 – 150 kHz	±0.38 dB
	0.15 – 30 MHz	±0.42 dB
	30 – 1000 MHz	±0.51 dB
All emissions, radiated	9 – 150 kHz	±2.49 dB
	0.15 – 30 MHz	±2.28 dB
	30 – 1000 MHz	±2.56 dB
Temperature	±0.8 °C	
Humidity	±3 %	
DC and low frequency voltages	±3 %	
Time	±1.4 %	
Duty Cycle	±1.4 %	



2 Test Configuration of EUT

2.1 The Worst Case Modulation Configuration

Modulation Used for Conformance Testing	
Modulation Mode	Field Strength (dBuV/m at 3 m)
NFC-Read/Write	63.79



2.2 Test Channel Frequencies Configuration

Modulation Mode	Test Channel Frequencies (MHz)
NFC-Read/Write	13.56

2.3 The Worst Case Measurement Configuration

The Worst Case Mode for Following Conformance Tests	
Tests Item	AC power-line conducted emissions
Condition	AC power-line conducted measurement for line and neutral Test Voltage: 120Vac / 60Hz
Operating Mode	Adapter Mode
Orthogonal Planes of EUT	X Plane
	

The Worst Case Mode for Following Conformance Tests	
Tests Item	Emission Bandwidth, Frequency Stability
Test Condition	Conducted measurement

The Worst Case Mode for Following Conformance Tests			
Tests Item	Field Strength of Fundamental Emissions Spectrum Mask, Transmitter Radiated Unwanted Emissions		
Test Condition	Radiated measurement		
User Position	<input type="checkbox"/> EUT will be placed in fixed position.		
	<input type="checkbox"/> EUT will be placed in mobile position and operating multiple positions.		
	<input checked="" type="checkbox"/> EUT will be a hand-held or body-worn battery-powered devices and operating multiple positions.		
Pretest Mode	<input checked="" type="checkbox"/> 1. EUT Built in NFC A type		
	<input checked="" type="checkbox"/> 2. EUT Built in NFC B type		
	<input checked="" type="checkbox"/> 3. EUT Built in NFC F type		
	<input checked="" type="checkbox"/> 4. EUT Built in NFC V type		
Mode 3 configuration was pretested and found to be the worst case and measured during the test.			
Operating Mode < 1GHz	<input checked="" type="checkbox"/> 1. Adapter Mode		
Modulation Mode	NFC-Read/Write		
Orthogonal Planes of EUT	X Plane	Y Plane	Z Plane
			
Worst Planes of EUT			V

2.4 Accessories and Support Equipment

Accessories Information				
AC Adapter	Brand Name	FSP	Model Name	FSP065-REBN2
	Power Rating	I/P: 100 - 240Vac, 1.5A, O/P: 19Vdc, 3.42A		
	Power Cord	1.2 meter, non-shielded cable, with one ferrite core		
Battery 1	Brand Name	AAEON	Model Name	RTC1200
	Power Rating	14.4Vdc, 2270mAh	Type	Li-ion, 4S1P
Battery 2	Brand Name	AAEON	Model Name	RTC1200
	Power Rating	14.4Vdc, 2270mAh	Type	Li-ion, 4S1P
LCD Panel	Brand Name	LITEMAX	Part Number	OLP1167-ITN-A01

Reminder: Regarding to more detail and other information, please refer to user manual.

Support Equipment - AC Conduction			
No.	Equipment	Brand Name	Model Name
1	NFC Card	-	-

Support Equipment - Radiated			
No.	Equipment	Brand Name	Model Name
1	NFC Card	-	-

Support Equipment- RF Conducted			
No.	Equipment	Brand Name	Model Name
1	NFC Card	-	-

2.5 Test Setup Diagram

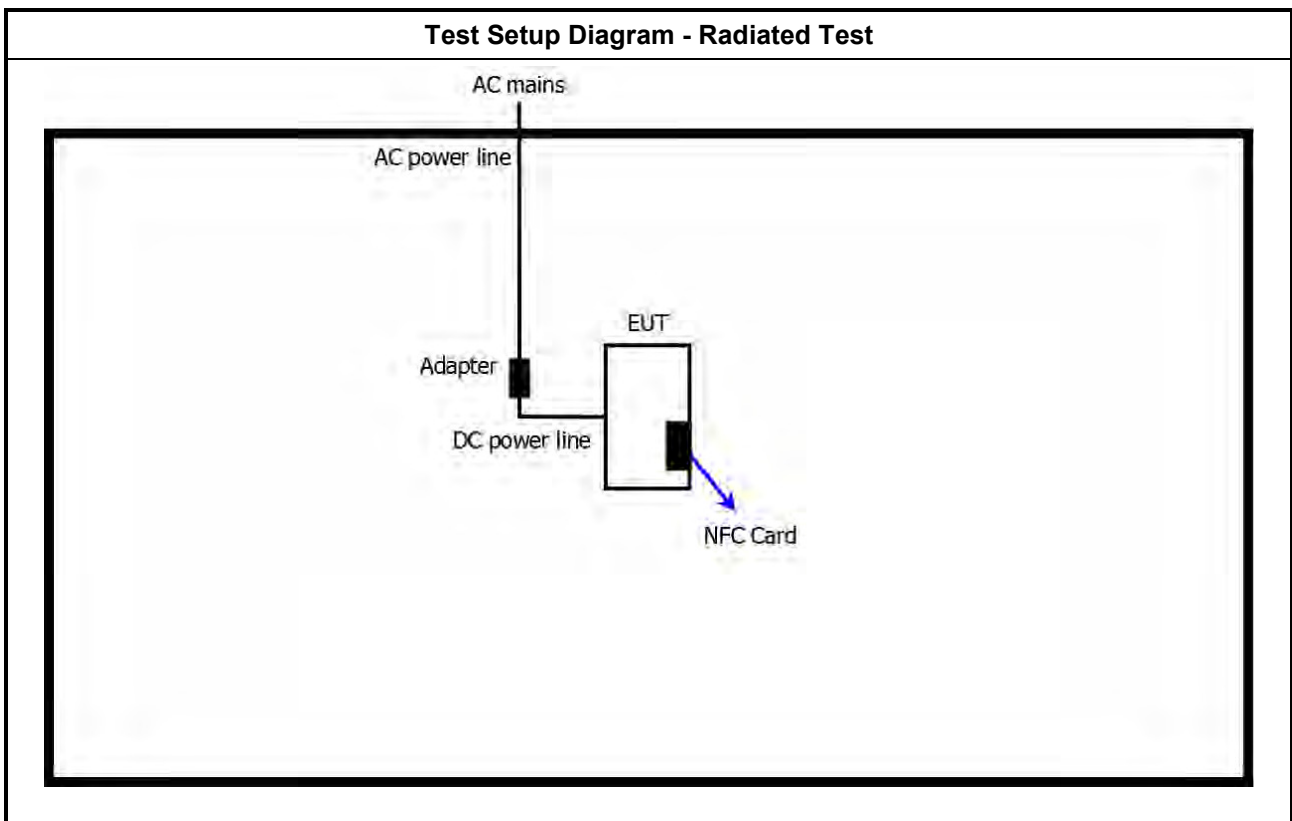
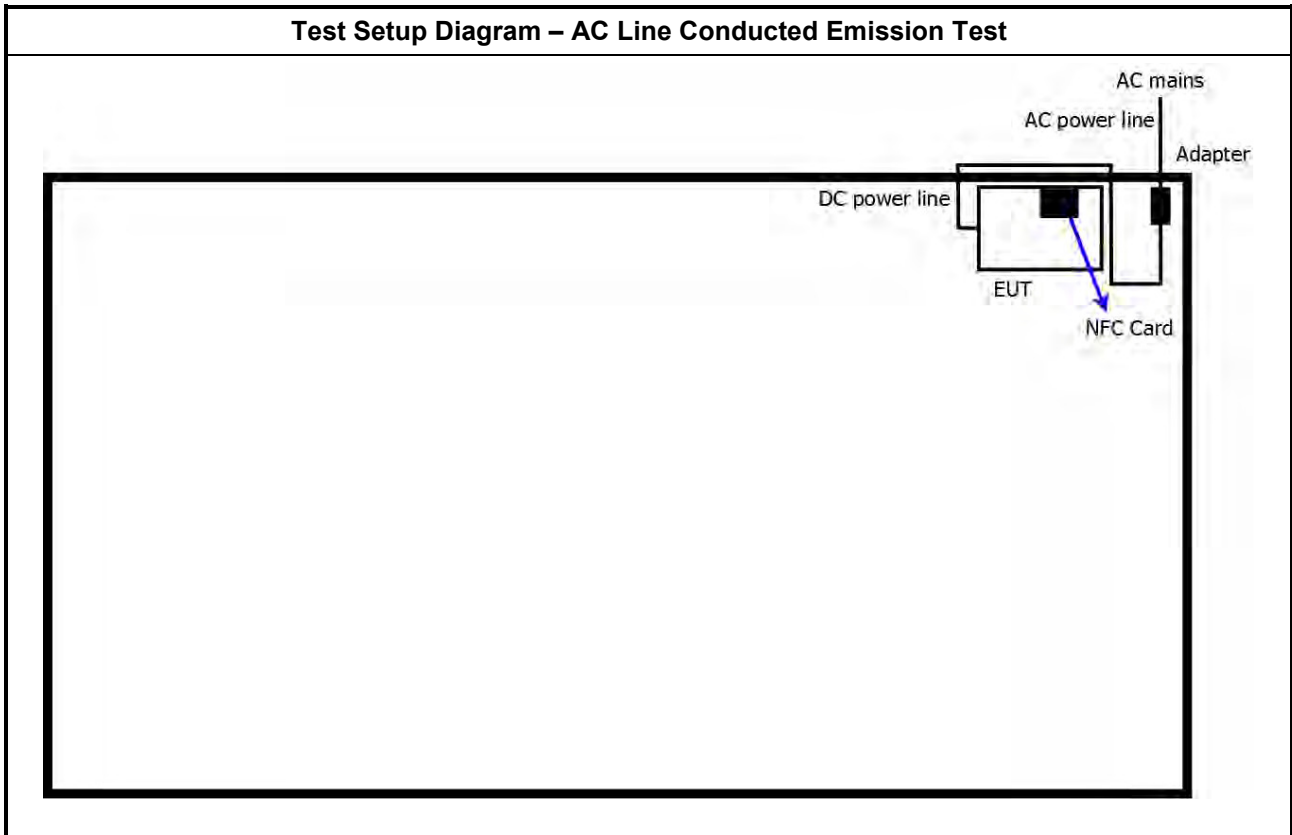

3 Transmitter Test Result

3.1 AC Power-line Conducted Emissions

3.1.1 AC Power-line Conducted Emissions Limit

AC Power-line Conducted Emissions Limit		
Frequency Emission (MHz)	Quasi-Peak	Average
0.15-0.5	66 - 56 *	56 - 46 *
0.5-5	56	46
5-30	60	50

Note 1: * Decreases with the logarithm of the frequency.

3.1.2 Measuring Instruments

Refer a test equipment and calibration data table in this test report.

3.1.3 Test Procedures

Test Method	
<input checked="" type="checkbox"/>	Refer as ANSI C63.10-2013, clause 6.2 for AC power-line conducted emissions.
<input checked="" type="checkbox"/>	If AC conducted emissions fall in operating band, then following below test method confirm final result.
<input type="checkbox"/>	Accept measurements done with a suitable dummy load replacing the antenna under the following conditions: (1) Perform the AC line conducted tests with the antenna connected to determine compliance with FCC 15.207 limits outside the transmitter's fundamental emission band; (2) Retest with a dummy load to determine compliance with FCC 15.207 limits within the transmitter's fundamental emission band.
<input checked="" type="checkbox"/>	For a device with a permanent antenna operating at or below 30 MHz, accept measurements done with a suitable dummy load, in lieu of the permanent antenna under the following conditions: (1) Perform the AC line conducted tests with the permanent antenna to determine compliance with the FCC 15.207 limits outside the transmitter's fundamental emission band; (2) Retest with a dummy load in lieu of the permanent antenna to determine compliance with the FCC 15.207 limits within the transmitter's fundamental emission band.

3.1.4 Test Setup

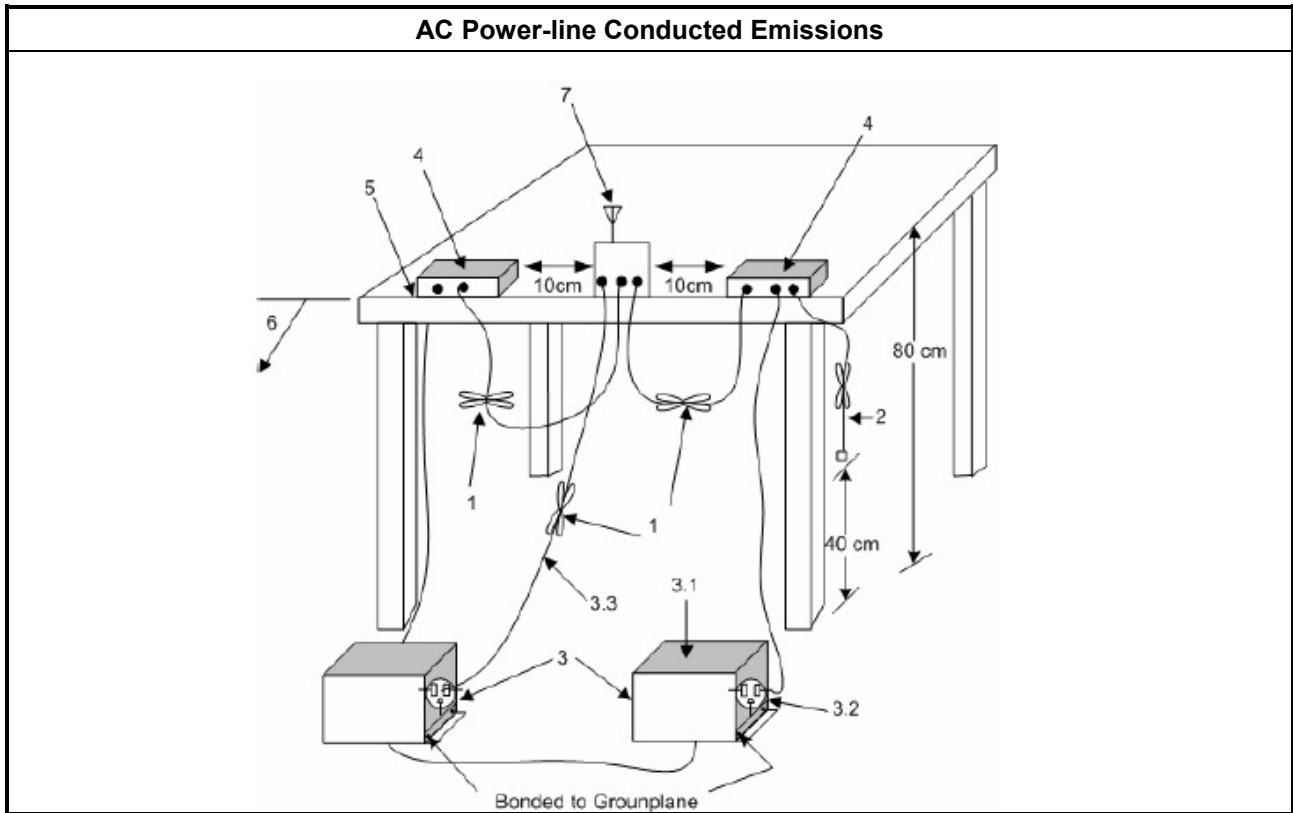

3.1.5 Test Result of AC Power-line Conducted Emissions

AC Power-line Conducted Emissions Result			
Operating Mode	1	Power Phase	Neutral
Operating Function	Adapter Mode		

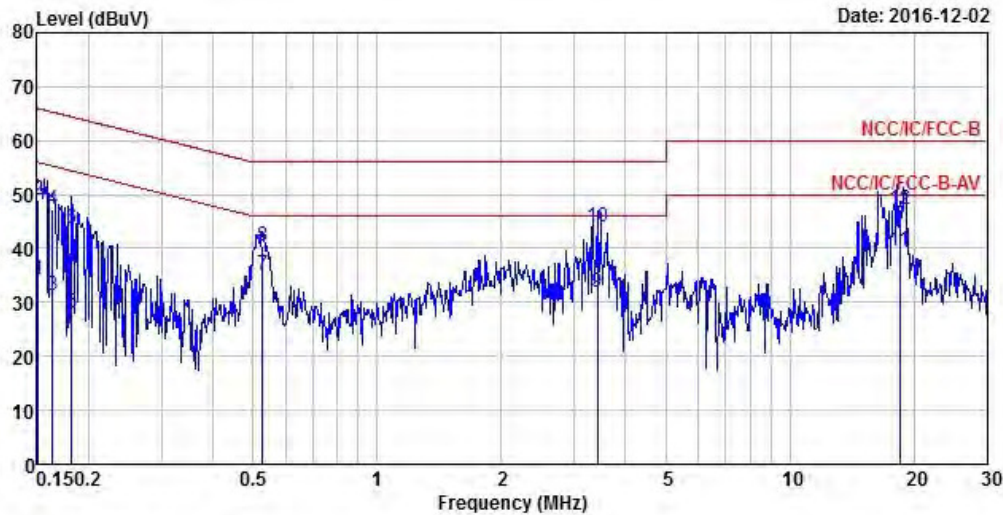

	Freq	Level	Over	Limit	Read	LISN	Cable	
	MHz	dBuV	Limit	Line	Level	Factor	Loss	Remark
			dB	dBuV	dBuV	dB	dB	
1	0.15	34.18	-21.78	55.96	33.86	0.10	0.22	Average
2	0.15	48.95	-17.01	65.96	48.63	0.10	0.22	QP
3	0.16	31.16	-24.14	55.30	30.82	0.10	0.24	Average
4	0.16	47.29	-18.01	65.30	46.95	0.10	0.24	QP
5	0.18	28.16	-26.26	54.42	27.78	0.11	0.27	Average
6	0.18	43.63	-20.79	64.42	43.25	0.11	0.27	QP
7	0.53	35.11	-10.89	46.00	34.89	0.12	0.10	Average
8	0.53	40.44	-15.56	56.00	40.22	0.12	0.10	QP
9	3.42	31.84	-14.16	46.00	31.52	0.17	0.15	Average
10	3.42	43.92	-12.08	56.00	43.60	0.17	0.15	QP
11 MAX	18.45	39.48	-10.52	50.00	38.91	0.37	0.20	Average
12	18.45	47.19	-12.81	60.00	46.62	0.37	0.20	QP

Note 1: ">20dB" means emission levels that exceed the level of 20 dB below the applicable limit.
 Note 2: "N/F" means Nothing Found emissions (No emissions were detected.)
 Note 3: When emissions are in operating band over limits, retest with a dummy load for final in-band results.



AC Power-line Conducted Emissions Result

Operating Mode	1	Power Phase	Line
Operating Function	Adapter Mode		

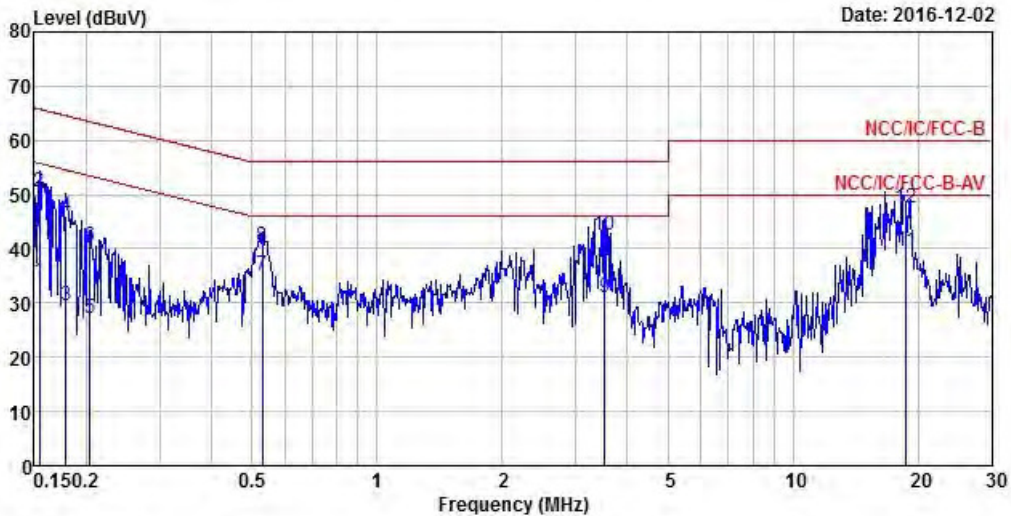

	Freq	Level	Over Limit	Limit Line	Read Level	LISN Factor	Cable Loss	Remark
	MHz	dBuV	dB	dBuV	dBuV	dB	dB	
1	0.15	33.90	-21.88	55.78	33.57	0.11	0.22	Average
2	0.15	50.40	-15.38	65.78	50.07	0.11	0.22	QP
3	0.18	29.57	-24.98	54.55	29.19	0.11	0.27	Average
4	0.18	45.93	-18.62	64.55	45.55	0.11	0.27	QP
5	0.20	27.11	-26.34	53.45	26.71	0.11	0.29	Average
6	0.20	40.45	-23.00	63.45	40.05	0.11	0.29	QP
7	0.53	35.27	-10.73	46.00	35.05	0.12	0.10	Average
8	0.53	40.48	-15.52	56.00	40.26	0.12	0.10	QP
9	3.53	30.98	-15.02	46.00	30.67	0.17	0.14	Average
10	3.53	42.49	-13.51	56.00	42.18	0.17	0.14	QP
11 MAX	18.67	39.52	-10.48	50.00	38.98	0.34	0.20	Average
12	18.67	47.38	-12.62	60.00	46.84	0.34	0.20	QP

Note 1: ">20dB" means emission levels that exceed the level of 20 dB below the applicable limit.
 Note 2: "N/F" means Nothing Found emissions (No emissions were detected.)
 Note 3: When emissions are in operating band over limits, retest with a dummy load for final in-band results.

3.2 Emission Bandwidth

3.2.1 Emission Bandwidth Limit

20dB Bandwidth Limit	
<input checked="" type="checkbox"/>	Intentional radiators must be designed to ensure that the 20 dB bandwidth of the emissions in the specific band (13.553 – 13.567 MHz).

3.2.2 Measuring Instruments

Refer a test equipment and calibration data table in this test report.

3.2.3 Test Procedures

Test Method	
<input checked="" type="checkbox"/>	For the emission bandwidth refer ANSI C63.10, clause 6.9.3 for occupied bandwidth testing.
<input checked="" type="checkbox"/>	For radiated measurement. Loop antenna was rotated about the horizontal and vertical axis and the equipment to be measured and the test antenna shall be oriented to obtain the maximum emitted field strength level.

3.2.4 Test Setup

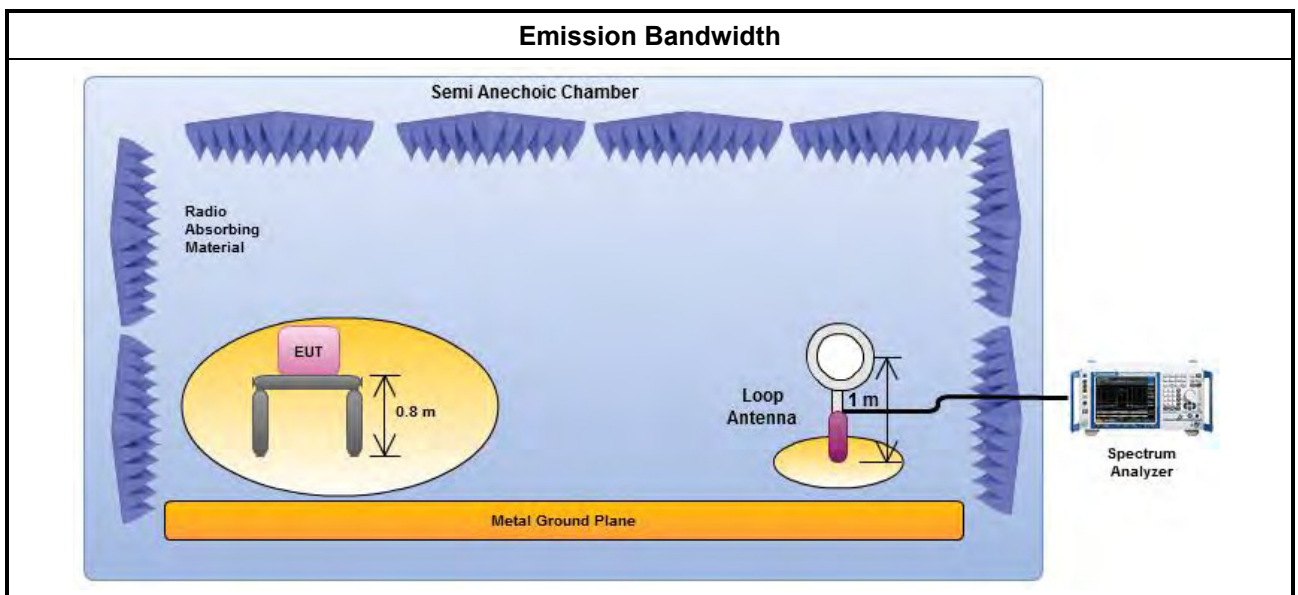

3.2.5 Test Result of Emission Bandwidth

Occupied Channel Bandwidth Result					
Modulation Mode	Frequency (MHz)	20dB Bandwidth (kHz)	F _L at 20dB BW (MHz)	F _H at 20dB BW (MHz)	99% Bandwidth (kHz)
NFC-Read/Write	13.56	2.64000	13.55896	13.56160	2.28000
Limit		N/A	13.553	13.567	N/A
Result		Complied			

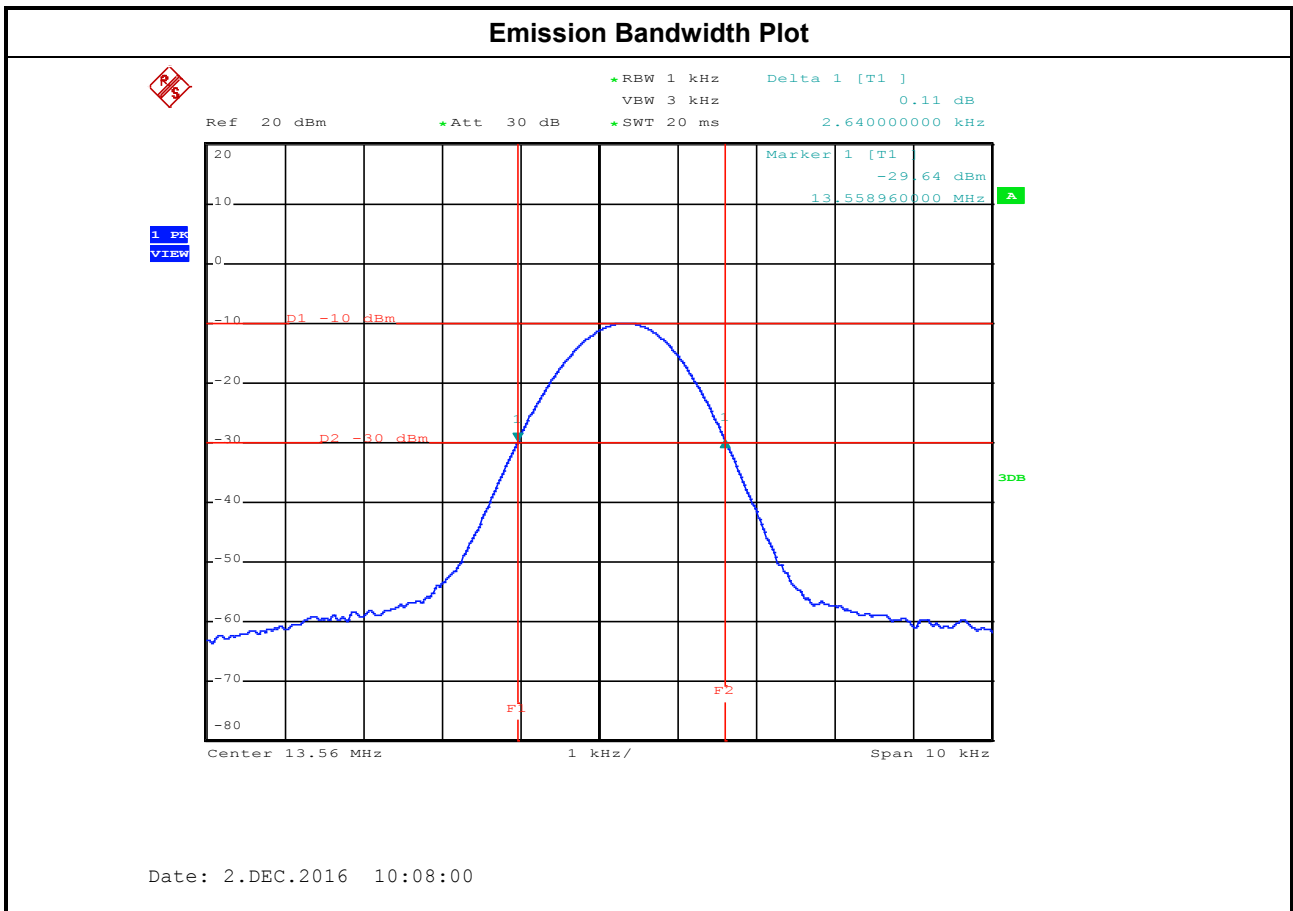

3.3 Field Strength of Fundamental Emissions and Spectrum Mask

3.3.1 Field Strength of Fundamental Emissions and Spectrum Mask Limit

Field Strength of Fundamental Emissions For FCC					
Emissions	(uV/m)@30m	(dBuV/m)@30m	(dBuV/m)@10m	(dBuV/m)@3m	(dBuV/m)@1m
fundamental	15848	84.0	103.1	124.0	143.1
Peak measurement of the fundamental.					

Spectrum Mask For FCC					
Freq. of Emission (MHz)	(uV/m)@30m	(dBuV/m)@30m	(dBuV/m)@10m	(dBuV/m)@3m	(dBuV/m)@1m
1.705~13.110	30	29.5	48.6	69.5	88.6
13.110~13.410	106	40.5	59.6	80.5	99.6
13.410~13.553	334	50.5	69.6	90.5	109.6
13.553~13.567	15848	84.0	103.1	124.0	143.1
13.567~13.710	334	50.5	69.6	90.5	109.6
13.710~14.010	106	40.5	59.6	80.5	99.6
14.010~30.000	30	29.5	48.6	69.5	88.6

3.3.2 Measuring Instruments

Refer a test equipment and calibration data table in this test report.

3.3.3 Test Procedures

Test Method	
<input checked="" type="checkbox"/>	Refer as ANSI C63.10, clause 6.4 for radiated emissions from below 30 MHz and test distance is 3m.
<input checked="" type="checkbox"/>	At frequencies below 30 MHz, measurements may be performed at a distance closer than that specified in the requirements; however, an attempt should be made to avoid making measurements in the near field. Pending the development of an appropriate measurement procedure for measurements performed below 30 MHz, when performing measurements at a closer distance than specified, the results shall be following below methods.
<input type="checkbox"/>	The results shall be extrapolated to the specified distance by making measurements at a minimum of two distances on at least one radial to determine the proper extrapolation factor.
<input checked="" type="checkbox"/>	The results shall be by using the square of an inverse linear distance extrapolation factor (40 dB/decade).
<input checked="" type="checkbox"/>	For radiated measurement. Loop antenna was rotated about the horizontal and vertical axis and the equipment to be measured and the test antenna shall be oriented to obtain the maximum emitted field strength level.

3.3.4 Test Setup

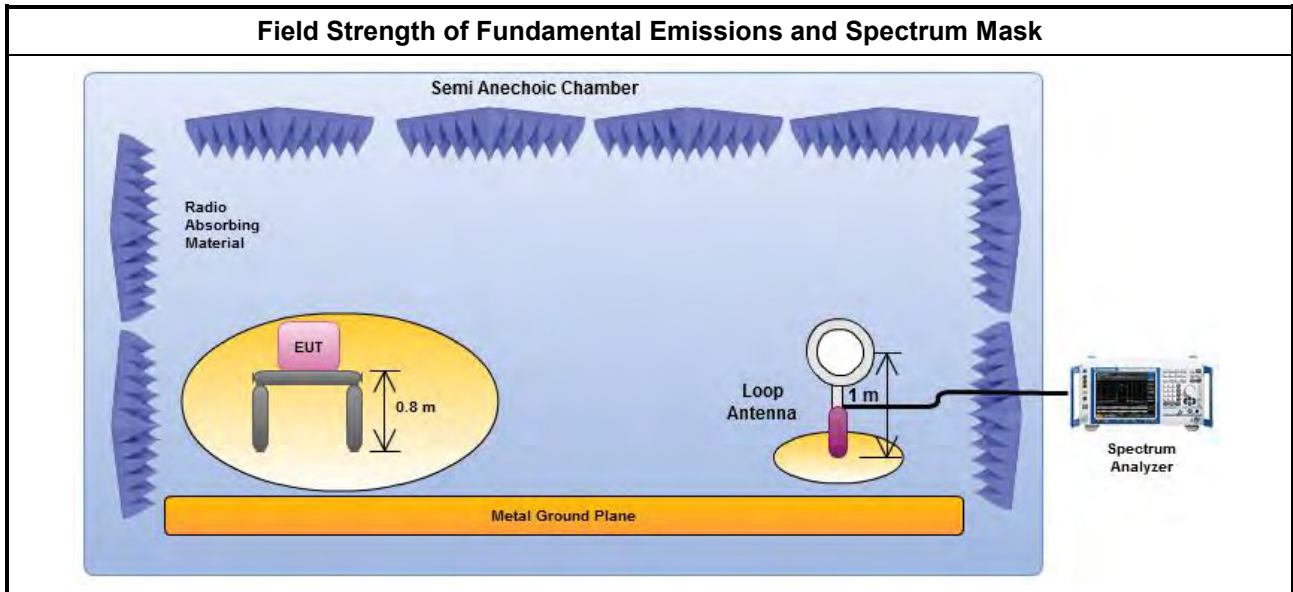

3.3.5 Test Result of Field Strength of Fundamental Emissions and Spectrum Mask

Field Strength of Fundamental Emissions Result					
Modulation Mode	Frequency (MHz)	Fundamental (dBuV/m)@3m	Polarization	Margin (dB)	Limit (dBuV/m)@3m
NFC-Read/Write	13.56	63.79	H	60.21	124.00
Result		Complied			
Note 1: Measurement worst emissions of receive antenna polarization: H(Horizontal).					



Spectrum Mask Plot

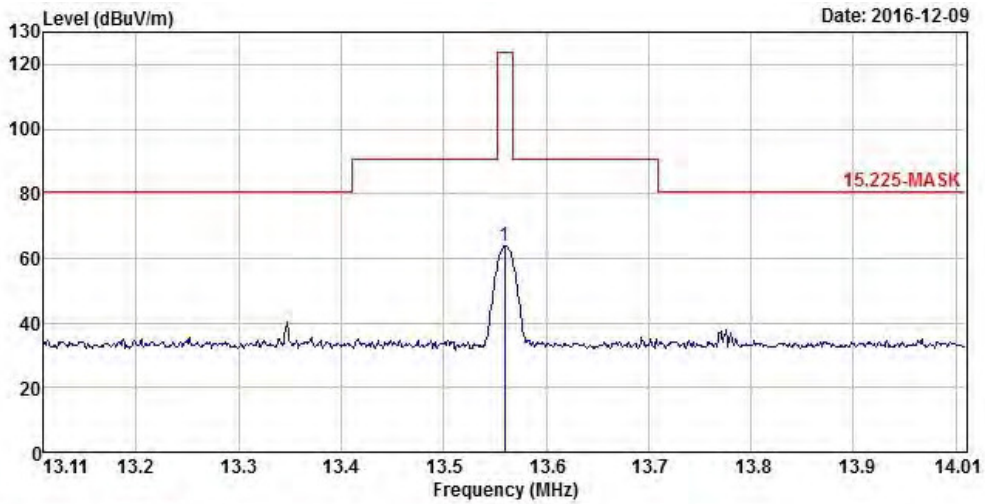

	Freq	Level	Over Limit	Limit Line	ReadAntenna Level	Antenna Factor	Cable Loss	Preamp Factor	Remark
	MHz	dBUV/m	dB	dBUV/m	dBuV	dB/m	dB	dB	
1	13.560	63.79	-60.21	124.00	41.73	21.37	0.69	0.00	Peak

3.4 Transmitter Radiated Unwanted Emissions

3.4.1 Transmitter Radiated Unwanted Emissions Limit

Transmitter Radiated Unwanted Emissions Limit			
Frequency Range (MHz)	Field Strength (uV/m)	Field Strength (dBuV/m)	Measure Distance (m)
0.009~0.490	2400/F(kHz)	48.5 - 13.8	300
0.490~1.705	24000/F(kHz)	33.8 - 23	30
1.705~30.0	30	29	30
30~88	100	40	3
88~216	150	43.5	3
216~960	200	46	3
Above 960	500	54	3

Note 1: Test distance for frequencies at or above 30 MHz, measurements may be performed at a distance other than the limit distance provided they are not performed in the near field and the emissions to be measured can be detected by the measurement equipment. When performing measurements at a distance other than that specified, the results shall be extrapolated to the specified distance using an extrapolation factor of 20 dB/decade (inverse of linear distance for field-strength measurements, inverse of linear distance-squared for power-density measurements).

Note 2: Test distance for frequencies at below 30 MHz, measurements may be performed at a distance closer than the EUT limit distance; however, an attempt should be made to avoid making measurements in the near field. When performing measurements below 30 MHz at a closer distance than the limit distance, the results shall be extrapolated to the specified distance by either making measurements at a minimum of two or more distances on at least one radial to determine the proper extrapolation factor or by using the square of an inverse linear distance extrapolation factor (40 dB/decade). The test report shall specify the extrapolation method used to determine compliance of the EUT.

3.4.2 Measuring Instruments

Refer a test equipment and calibration data table in this test report.



3.4.3 Test Procedures

Test Method	
<input checked="" type="checkbox"/>	Refer as ANSI C63.10, clause 6.5 for radiated emissions from 30 MHz to 1 GHz and test distance is 3m.
<input checked="" type="checkbox"/>	Refer as ANSI C63.10, clause 6.4 for radiated emissions from below 30 MHz and test distance is 3m.
<input checked="" type="checkbox"/>	At frequencies below 30 MHz, measurements may be performed at a distance closer than that specified in the requirements; however, an attempt should be made to avoid making measurements in the near field. Pending the development of an appropriate measurement procedure for measurements performed below 30 MHz, when performing measurements at a closer distance than specified, the results shall be following below methods.
<input type="checkbox"/>	The results shall be extrapolated to the specified distance by making measurements at a minimum of two distances on at least one radial to determine the proper extrapolation factor.
<input checked="" type="checkbox"/>	The results shall be by using the square of an inverse linear distance extrapolation factor (40 dB/decade).
<input checked="" type="checkbox"/>	For radiated measurement. Loop antenna was rotated about the horizontal and vertical axis and the equipment to be measured and the test antenna shall be oriented to obtain the maximum emitted field strength level.
<input checked="" type="checkbox"/>	The any unwanted emissions level shall not exceed the fundamental emission level.
<input checked="" type="checkbox"/>	All amplitude of spurious emissions that are attenuated by more than 20 dB below the permissible value has no need to be reported.

3.4.4 Test Setup

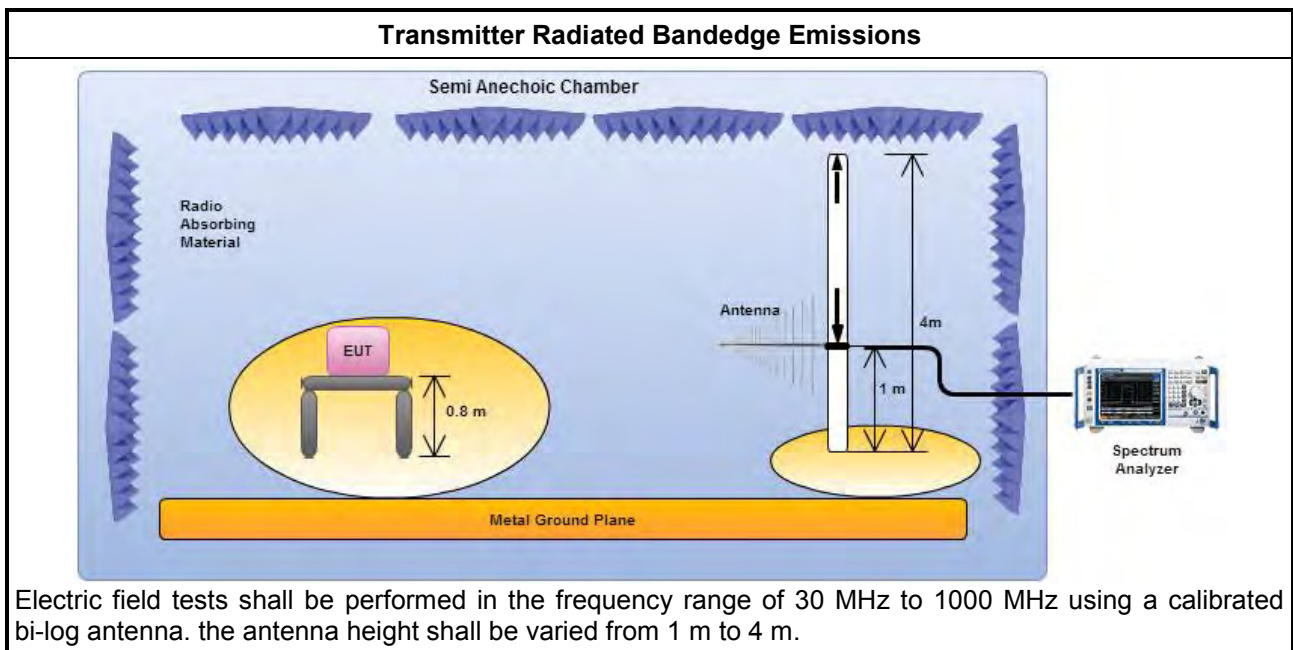
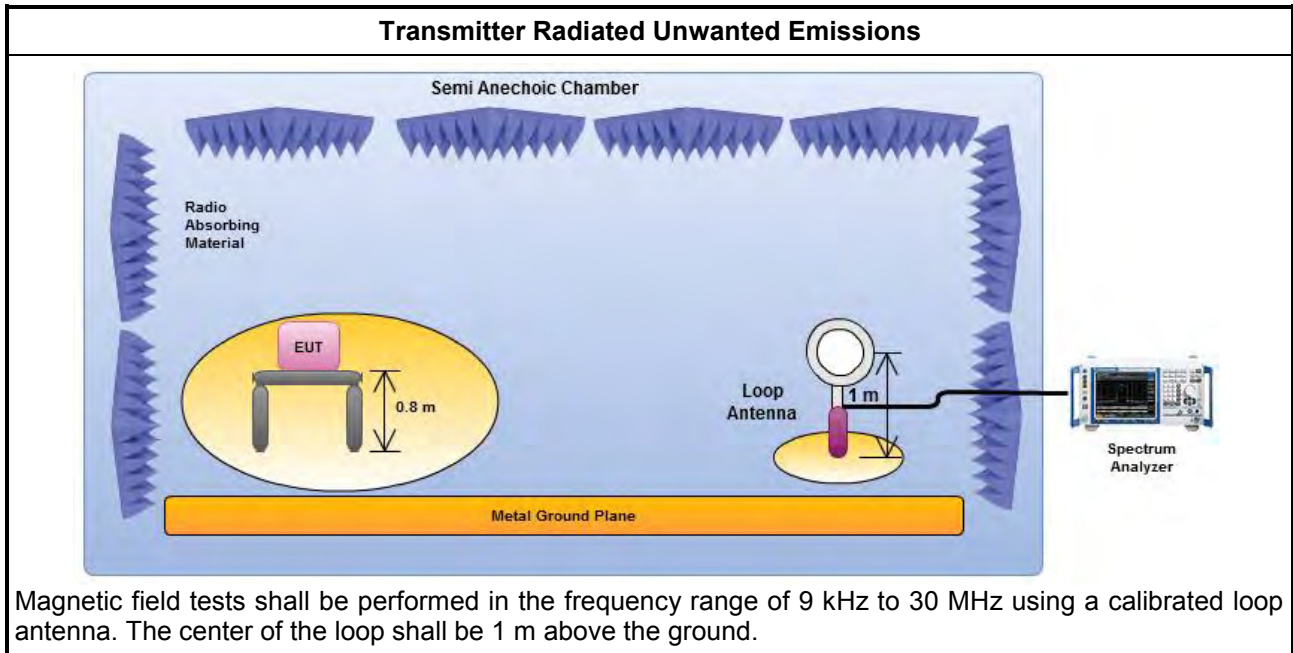

3.4.5 Transmitter Radiated Unwanted Emissions (Below 30MHz)

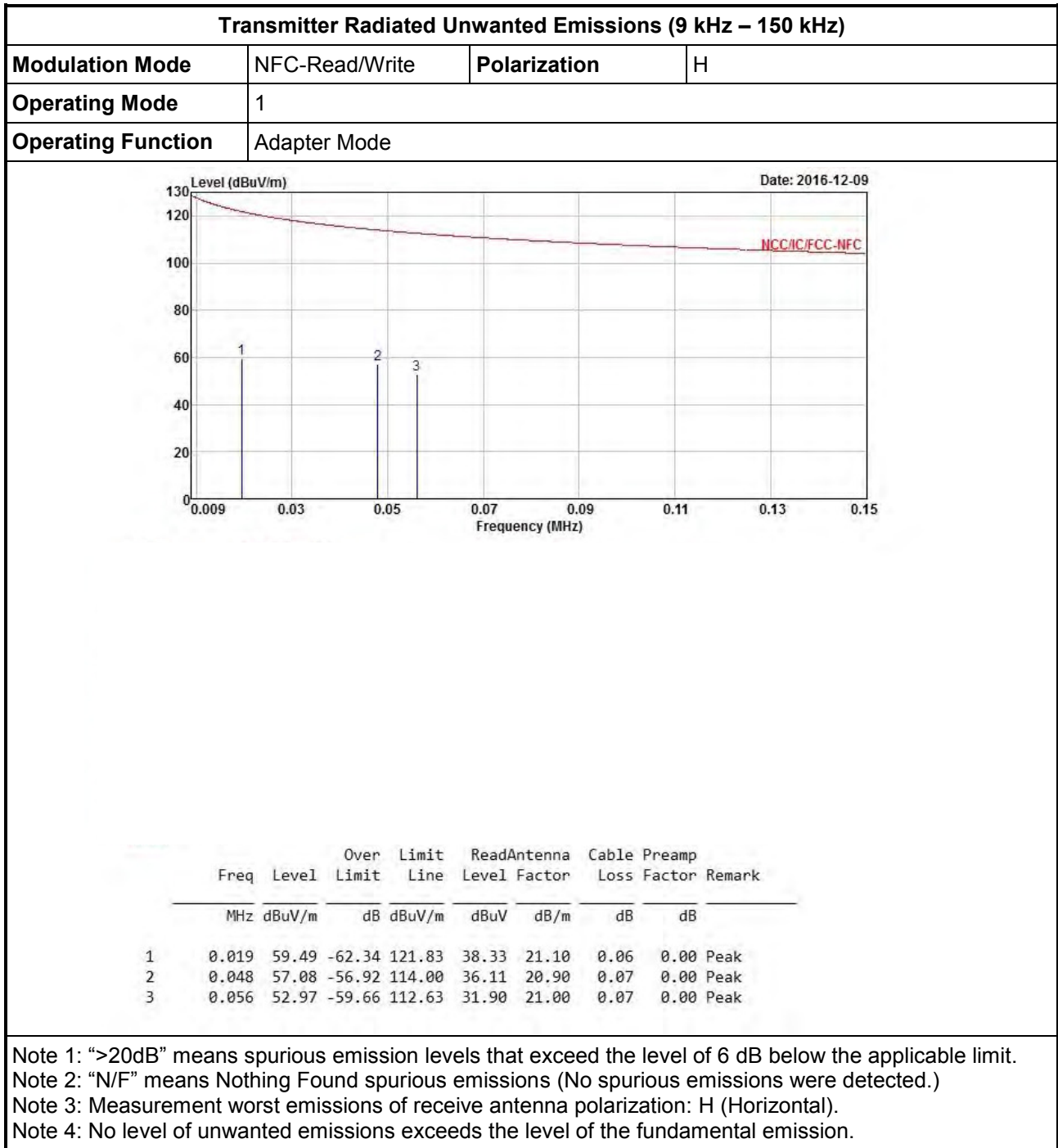

Transmitter Radiated Unwanted Emissions (150 kHz – 30 MHz)			
Modulation Mode	NFC-Read/Write	Polarization	H
Operating Mode	1		
Operating Function	Adapter Mode		

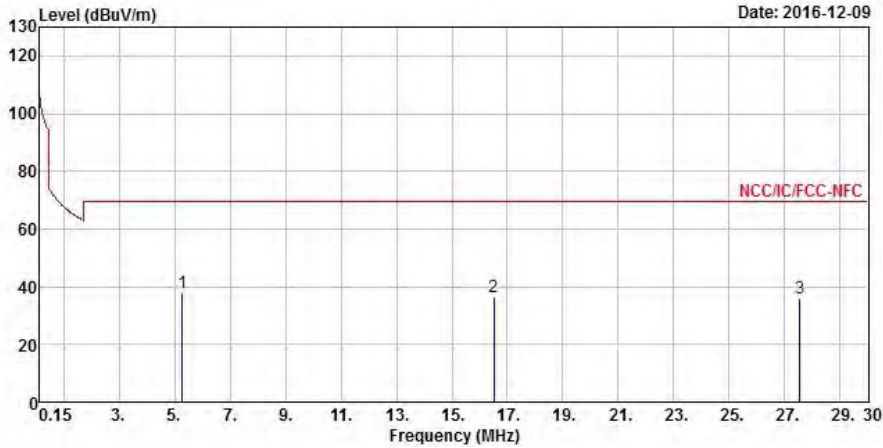

	Freq	Level	Over Limit	Limit Line	ReadAntenna Level	Antenna Factor	Cable Loss	Preamp Factor	Remark
	MHz	dBuV/m	dB	dBuV/m	dBuV	dB/m	dB	dB	
1	5.284	37.82	-31.72	69.54	16.45	20.92	0.45	0.00	Peak
2	16.508	36.31	-33.23	69.54	14.12	21.43	0.76	0.00	Peak
3	27.552	35.95	-33.59	69.54	13.34	21.65	0.96	0.00	Peak

Note 1: ">20dB" means spurious emission levels that exceed the level of 6 dB below the applicable limit.
 Note 2: "N/F" means Nothing Found spurious emissions (No spurious emissions were detected.)
 Note 3: Measurement worst emissions of receive antenna polarization: H (Horizontal).
 Note 4: No level of unwanted emissions exceeds the level of the fundamental emission.

3.4.6 Transmitter Radiated Unwanted Emissions (Above 30MHz)

Transmitter Radiated Spurious Emissions (Above 30MHz)			
Modulation Mode	NFC-Read/Write	Test Freq. (MHz)	13.56
Operating Function	Transmit	Polarization	V

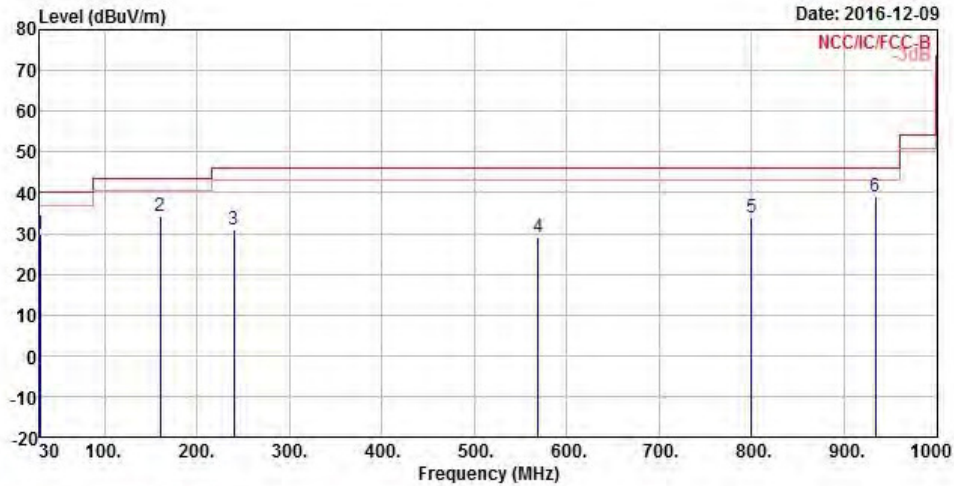

	Freq	Level	Over Limit	Limit Line	ReadAntenna Level	Antenna Factor	Cable Loss	Preamp Factor	Remark
	MHz	dBuV/m	dB	dBuV/m	dBuV	dB/m	dB	dB	
1	30.000	29.93	-10.07	40.00	34.52	22.02	0.94	27.55	QP
2	159.980	34.11	-9.39	43.50	44.05	15.08	2.09	27.11	Peak
3	239.520	30.84	-15.16	46.00	38.81	16.35	2.51	26.83	Peak
4	569.320	29.11	-16.89	46.00	29.22	23.76	4.08	27.95	Peak
5	800.180	33.92	-12.08	46.00	31.88	24.82	5.00	27.78	Peak
6	934.040	39.10	-6.90	46.00	35.55	25.67	5.31	27.43	Peak

Note 1: ">20dB" means spurious emission levels that exceed the level of 6 dB below the applicable limit.
 Note 2: "N/F" means Nothing Found spurious emissions (No spurious emissions were detected.)
 Note 3: Measurement receive antenna polarization: H (Horizontal), V (Vertical).
 Note 4: No level of unwanted emissions exceeds the level of the fundamental emission.



Transmitter Radiated Spurious Emissions (Above 30MHz)

Modulation Mode	NFC-Read/Write	Test Freq. (MHz)	13.56
Operating Function	Transmit	Polarization	H

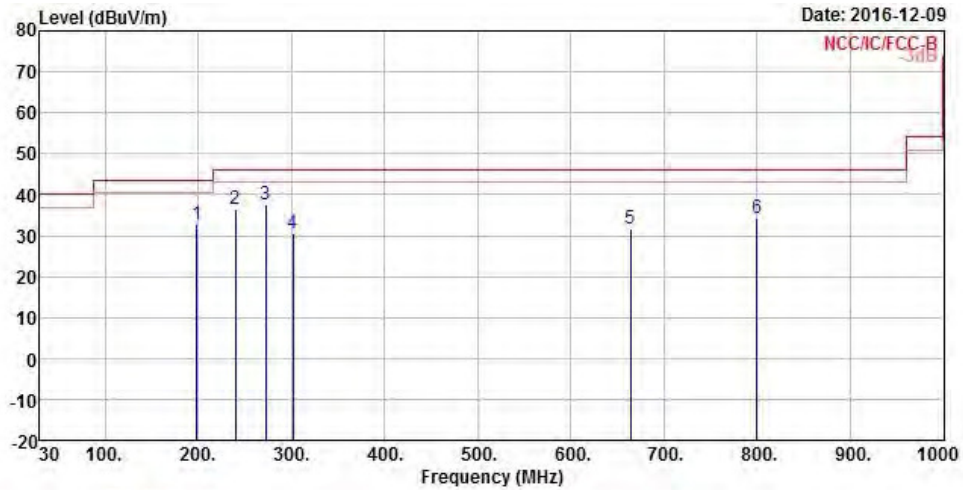

	Freq	Level	Over Limit	Limit Line	ReadAntenna Level	Antenna Factor	Cable Loss	Preamp Factor	Remark
	MHz	dBuV/m	dB	dBuV/m	dBuV	dB/m	dB	dB	
1	198.780	32.63	-10.87	43.50	42.91	14.36	2.29	26.93	Peak
2	239.520	36.38	-9.62	46.00	44.35	16.35	2.51	26.83	Peak
3	272.500	37.49	-8.51	46.00	43.57	17.93	2.75	26.76	Peak
4	301.600	30.50	-15.50	46.00	35.93	18.29	2.98	26.70	Peak
5	664.380	31.70	-14.30	46.00	31.26	24.00	4.40	27.96	Peak
6	800.180	34.39	-11.61	46.00	32.35	24.82	5.00	27.78	Peak

Note 1: ">20dB" means spurious emission levels that exceed the level of 6 dB below the applicable limit.
 Note 2: "N/F" means Nothing Found spurious emissions (No spurious emissions were detected.)
 Note 3: Measurement receive antenna polarization: H (Horizontal), V (Vertical).
 Note 4: No level of unwanted emissions exceeds the level of the fundamental emission.

3.5 Frequency Stability

3.5.1 Frequency Stability Limit

Frequency Stability Limit	
<input checked="" type="checkbox"/>	Carrier frequency stability shall be maintained to $\pm 0.01\%$ (± 100 ppm).

3.5.2 Measuring Instruments

Refer a test equipment and calibration data table in this test report.

3.5.3 Test Procedures

Test Method	
<input checked="" type="checkbox"/>	Refer as ANSI C63.10, clause 6.8 for frequency stability tests
<input checked="" type="checkbox"/>	Frequency stability with respect to ambient temperature
<input checked="" type="checkbox"/>	Frequency stability when varying supply voltage
<input type="checkbox"/>	For conducted measurement.
<input checked="" type="checkbox"/>	For radiated measurement. The equipment to be measured and the test antenna shall be oriented to obtain the maximum emitted power level.

3.5.4 Test Setup

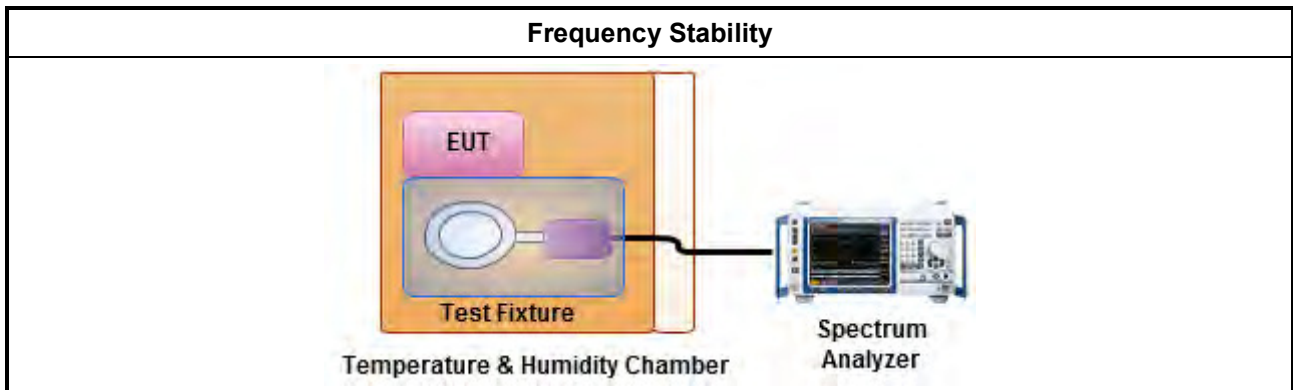



3.5.5 Test Result of Frequency Stability

Frequency Stability Result									
Condition	Ch. Freq. (MHz)	Frequency Stability (ppm)							
		Test Frequency (MHz)				Frequency Stability (ppm)			
		0 min	2 min	5 min	10 min	0 min	2 min	5 min	10 min
T _{20°C} Vmax	13.56	13.56042	13.56048	13.56048	13.56046	30.97	35.40	35.40	33.92
T _{20°C} Vmin	13.56	13.56048	13.56048	13.56042	13.56048	35.40	35.40	30.97	35.40
T _{50°C} Vnom	13.56	13.56036	13.56036	13.56030	13.56030	26.55	26.55	22.12	22.12
T _{40°C} Vnom	13.56	13.56042	13.56042	13.56040	13.56036	30.97	30.97	29.50	26.55
T _{30°C} Vnom	13.56	13.56042	13.56042	13.56042	13.56042	30.97	30.97	30.97	30.97
T _{20°C} Vnom	13.56	13.56048	13.56048	13.56042	13.56048	35.40	35.40	30.97	35.40
T _{10°C} Vnom	13.56	13.56042	13.56042	13.56042	13.56040	30.97	30.97	30.97	29.50
T _{0°C} Vnom	13.56	13.56048	13.56048	13.56042	13.56048	35.40	35.40	30.97	35.40
T _{-10°C} Vnom	13.56	13.56046	13.56045	13.56046	13.56046	33.92	33.48	33.92	33.78
T _{-20°C} Vnom	13.56	13.56048	13.56048	13.56042	13.56048	35.40	35.40	30.97	35.40
Limit (ppm)		100							
Result		Complied							
<p>Note 1: Measure at 85 % [Vmin] and 115 % [Vmax] of the nominal voltage [Vnom]. The nominal voltage refer test report clause 0 for EUT operational condition.</p> <p>Note 2: Measure maximum deviation frequency at operating frequency at startup and two, five, and ten min.</p>									



4 Test Equipment and Calibration Data

Instrument for AC Conduction

Instrument	Manufacturer	Model No.	Serial No.	Characteristics	Calibration Date	Calibration Due Date
EMC Receiver	R&S	ESR-3	102051	9kHz ~ 3.6GHz	19/04/2016	18/04/2017
LISN	SCHWARZBECK MESS-ELEKTRONIK	NSLK 8127	8127-477	9kHz ~ 30MHz	26/01/2016	25/01/2017
LISN (Support Unit)	R&S	ENV216	101295	9kHz ~ 30MHz	NCR	NCR
RF Cable-CON	HUBER+SUHNER	RG213/U	07611832020001	9kHz ~ 30MHz	24/10/2016	23/10/2017
EMI Filter	LINDGREN	LRE-2030	2651	< 450 Hz	NCR	NCR

NCR: No Calibration Require.

Instrument for Conducted Test

Instrument	Manufacturer	Model No.	Serial No.	Characteristics	Calibration Date	Calibration Due Date
Spectrum Analyzer	R&S	FSP 40	100305	9KHz~40GHz	16/02/2016	15/02/2017
Temp. and Humidity Chamber	Giant Force	GTH-225-20-SP-SD	MAA1112-007	-20 ~ 100°C	25/04/2016	24/04/2017
DC Power Source	G.W.	GPC-6030D	C671845	DC 1V ~ 60V	27/07/2016	26/07/2017

Instrument for Radiated Test

Instrument	Manufacturer	Model No.	Serial No.	Characteristics	Calibration Date	Calibration Due Date
3m Semi Anechoic Chamber	SIDT FRANKONIA	SAC-3M	03CH03-HY	30MHz ~ 1GHz 3m	28/11/2016	27/11/2017
Amplifier	HP	8447D	2944A08033	10kHz ~ 1.3GHz	10/05//2016	09/05/2017
Spectrum	R&S	FSV40	101513	9kHz ~ 40GHz	16/02/2016	15/02/2017
Bilog Antenna	SCHAFFNER	CBL 6112B	2723	30MHz ~ 1GHz	01/10/2016	30/09/2017
RF Cable-R03m	Jye Bao	RG142	CB021	9kHz ~ 1GHz	27/10/2016	26/10/2017
Loop Antenna	TESEQ	HLA 6120	31244	9 kHz~30 MHz	02/02/2015	01/02/2017