



SAR EVALUATION REPORT

For

AAEON Technology Inc.

5F, No. 135, Lane 235, Pao Chiao Rd., Hsin-Tien Dist., New Taipei City 23145, Taiwan, R.O.C

FCC ID: OHBRTC1010

IC: 23644-RTC1010

Report Type Original Report	Product Type: Rugged Tablet Computer
Report Producer :	Himiko Chen <i>Himiko Chen</i>
Report Number :	RLK1808003-00B
Report Date :	2018/10/14
Reviewed By:	Jerry Chang <i>Jerry Chang</i>
Prepared By: Bay Area Compliance Laboratories Corp. (Taiwan) 70, Lane 169, Sec. 2, Datong Road, Xizhi Dist., New Taipei City 22183, Taiwan, R.O.C. Tel: +886 (2)2647 6898 Fax: +886 (2) 2647 6895 www.bacl.com.tw	

Note: This test report is prepared for the customer shown above and for the device described herein. It may not be duplicated or used in part without prior written consent from Bay Area Compliance Laboratories Corp. (Taiwan)

Note: This test report is prepared for the customer shown above and for the device described herein. It may not be duplicated or used in part without prior written consent from Bay Area Compliance Laboratories Corp.

Attestation of Test Results			
EUT Information	EUT Description	Rugged Tablet Computer	
	Model Name	RTC-1010	
	Series Model	xRTC-1010x(x - Where x may be any combination of alphanumeric characters or "-" or blank.) for FCC	
	FCC ID	OHBRTC1010	
	IC	23644-RTC1010	
	Serial Number	1808003	
	Test Date	2018-09-17	
MODE		Max. SAR Level(s) Reported(W/kg)	Limit
2.4GHz WLAN	1g Body SAR	0.39	1.6
Applicable Standards	FCC 47 CFR part 2.1093 Radiofrequency radiation exposure evaluation: portable devices		
	IEEE1528:2013 IEEE Recommended Practice for Determining the Peak Spatial-Average Specific Absorption Rate (SAR) in the Human Head from Wireless Communications Devices: Measurement Techniques		
	IEC 62209-2:2010 Human exposure to radio frequency fields from hand-held and body-mounted wireless communication devices-Human models, instrumentation, and procedures-Part 2: Procedure to determine the specific absorption rate (SAR) for wireless communication devices used in close proximity to the human body (frequency range of 30 MHz to 6 GHz)		
	RSS-102 Issue 5 March 2015 Radio Frequency (RF) Exposure Compliance of Radio communication Apparatus (All Frequency Bands).		
	KDB procedures KDB 447498 D01 General RF Exposure Guidance v06 KDB 865664 D01 SAR measurement 100 MHz to 6 GHz v01r04 KDB 865664 D02 RF Exposure Reporting v01r02 KDB 616217 D04 SAR for laptop and tablets v01r02 KDB 248227 D01 802 11 Wi-Fi SAR v02r02		
<p>Note: This wireless device has been shown to be capable of compliance for localized specific absorption rate (SAR) for General Population/Uncontrolled Exposure limits specified in FCC 47 CFR part 2.1093 and has been tested in accordance with the measurement procedures specified in IEEE 1528-2013 and RF exposure KDB procedures.</p> <p>The results and statements contained in this report pertain only to the device(s) evaluated.</p>			

TABLE OF CONTENTS

DOCUMENT REVISION HISTORY	4
EUT DESCRIPTION	5
TECHNICAL SPECIFICATION	5
REFERENCE, STANDARDS, AND GUIDELINES.....	6
SAR LIMITS	7
FACILITIES.....	8
DESCRIPTION OF TEST SYSTEM	9
RECOMMENDED TISSUE DIELECTRIC PARAMETERS FOR HEAD AND BODY	13
EQUIPMENT LIST AND CALIBRATION	14
EQUIPMENTS LIST & CALIBRATION INFORMATION	14
SAR MEASUREMENT SYSTEM VERIFICATION	15
LIQUID VERIFICATION	15
SYSTEM ACCURACY VERIFICATION.....	16
SAR SYSTEM VALIDATION DATA.....	17
EUT TEST STRATEGY AND METHODOLOGY	18
TEST POSITIONS FOR DEVICE OPERATING NEXT TO A PERSON’S EAR.....	18
CHEEK/TOUCH POSITION	19
EAR/TILT POSITION	19
TEST POSITIONS FOR BODY-WORN AND OTHER CONFIGURATIONS.....	20
TEST DISTANCE FOR SAR EVALUATION	20
SAR EVALUATION PROCEDURE.....	21
CONDUCTED OUTPUT POWER MEASUREMENT	22
PROVISION APPLICABLE	22
TEST PROCEDURE	22
RADIO CONFIGURATION	22
MAXIMUM TARGET OUTPUT POWER	23
TEST RESULTS:	24
STANDALONE SAR TEST EXCLUSION CONSIDERATIONS	25
ANTENNA DISTANCE TO EDGE	25
SAR TEST EXCLUSION FOR THE EUT EDGE CONSIDERATIONS RESULT	26
STANDALONE SAR TEST EXCLUSION CONSIDERATIONS(RSS-102):.....	27
SAR TEST EXCLUSION FOR THE EUT EDGE CONSIDERATIONS RESULT	27
SAR MEASUREMENT RESULTS	28
SAR TEST DATA.....	28
SAR SIMULTANEOUS TRANSMISSION DESCRIPTION	31
SAR PLOTS.....	32
APPENDIX A MEASUREMENT UNCERTAINTY	36
APPENDIX B EUT TEST POSITION PHOTOS	38
APPENDIX C CALIBRATION CERTIFICATION.....	39

DOCUMENT REVISION HISTORY

Revision Number	Report Number	Description of Revision	Date of Revision
1.0	RLK1808003-23	Original Report	2018-10-14

EUT DESCRIPTION

This report has been prepared on behalf of *AAEON Technology Inc.* and their product *Semi Rugged Tablet Computer*, Model: *RTC-1010* FCC ID: *OHBRTC1010*, IC: *23644+RTC1010* or the EUT (Equipment under Test) as referred to in the rest of this report.

**All measurement and test data in this report was gathered from production sample serial number: 1808003 (Assigned by BACL, Taiwan). The EUT supplied by the applicant was received on 2018-09-14.*

Technical Specification

Product Type	Rugged Tablet Computer
Exposure Category:	Population / Uncontrolled
Antenna Type(s):	PIFA Antenna for WLAN and Bluetooth
Body-Worn Accessories:	None
Operation Mode :	IEEE 802.11 bgn + BT4.1 + NFC
Frequency Band:	IEEE 802.11 b/g/n HT20 mode: 2412 ~ 2462 MHz BLE mode : 2402 ~ 2480 MHz NFC: 13.56 MHz
Conducted RF Power(Average):	IEEE 802.11b mode: 15.31 dBm (0.034 W) IEEE 802.11g mode: 22.11 dBm (0.163 W) IEEE 802.11n HT20 mode: 22.08 dBm (0.161 W) BLE mode: 1.17 dBm (0.0013W) BT BR(GFSK) Mode: -12.14 dBm (0.000061W) BT EDR($\pi/4$ -DQPSK) Mode: -11.86 dBm(0.000065W) BT EDR(8-DPSK) Mode: -11.48 dBm (0.000071W)
Dimensions (L*W*H):	27.2 cm (H) x 19.0 cm (W) x 2.0 cm (D)
Power Source:	Battery: 1. 7.4V = 1530mAh 2. 14.4V = 2270mAh
Normal Operation:	Body Supported

Note : The overall diagonal dimension of the EUT >200mm, so test procedures in KDB616217 D04 should be applicable.

REFERENCE, STANDARDS, AND GUIDELINES

FCC:

The Report and Order requires routine SAR evaluation prior to equipment authorization of portable transmitter devices, including portable telephones. For consumer products, the applicable limit is 1.6 mW/g as recommended by the ANSI/IEEE standard C95.1-1992 [6] for an uncontrolled environment (Paragraph 65). According to the Supplement C of OET Bulletin 65 "Evaluating Compliance with FCC Guide-lines for Human Exposure to Radio frequency Electromagnetic Fields", released on Jun 29, 2001 by the FCC, the device should be evaluated at maximum output power (radiated from the antenna) under "worst-case" conditions for normal or intended use, incorporating normal antenna operating positions, device peak performance frequencies and positions for maximum RF energy coupling.

This report describes the methodology and results of experiments performed on wireless data terminal. The objective was to determine if there is RF radiation and if radiation is found, what is the extent of radiation with respect to safety limits. SAR (Specific Absorption Rate) is the measure of RF exposure determined by the amount of RF energy absorbed by human body (or its parts) – to determine how the RF energy couples to the body or head which is a primary health concern for body worn devices. The limit below which the exposure to RF is considered safe by regulatory bodies in North America is 1.6 mW/g average over 1 gram of tissue mass.

CE:

The order requires routine SAR evaluation prior to equipment authorization of portable transmitter devices, including portable telephones. For consumer products, the applicable limit is 2 mW/g as recommended by EN62209-1 for an uncontrolled environment. According to the Standard, the device should be evaluated at maximum output power (radiated from the antenna) under "worst-case" conditions for normal or intended use, incorporating normal antenna operating positions, device peak performance frequencies and positions for maximum RF energy coupling.

This report describes the methodology and results of experiments performed on wireless data terminal. The objective was to determine if there is RF radiation and if radiation is found, what is the extent of radiation with respect to safety limits. SAR (Specific Absorption Rate) is the measure of RF exposure determined by the amount of RF energy absorbed by human body (or its parts) – to determine how the RF energy couples to the body or head which is a primary health concern for body worn devices. The limit below which the exposure to RF is considered safe by regulatory bodies in Europe is 2 mW/g average over 10 gram of tissue mass.

The test configurations were laid out on a specially designed test fixture to ensure the reproducibility of measurements. Each configuration was scanned for SAR. Analysis of each scan was carried out to characterize the above effects in the device.

SAR Limits

FCC Limit

EXPOSURE LIMITS	SAR (W/kg)	
	(General Population / Uncontrolled Exposure Environment)	(Occupational / Controlled Exposure Environment)
Spatial Average (averaged over the whole body)	0.08	0.4
Spatial Peak (averaged over any 1 g of tissue)	1.60	8.0
Spatial Peak (hands/wrists/feet/ankles averaged over 10 g)	4.0	20.0

CE Limit

EXPOSURE LIMITS	SAR (W/kg)	
	(General Population / Uncontrolled Exposure Environment)	(Occupational / Controlled Exposure Environment)
Spatial Average (averaged over the whole body)	0.08	0.4
Spatial Peak (averaged over any 10 g of tissue)	2.0	10
Spatial Peak (hands/wrists/feet/ankles averaged over 10 g)	4.0	20.0

Population/Uncontrolled Environments are defined as locations where there is the exposure of individual who have no knowledge or control of their exposure.

Occupational/Controlled Environments are defined as locations where there is exposure that may be incurred by people who are aware of the potential for exposure (i.e. as a result of employment or occupation).

General Population/Uncontrolled environments Spatial Peak limit 1.6W/kg (FCC) & 2 W/kg (CE) applied to the EUT.

FACILITIES

The test site used by Bay Area Compliance Laboratories Corp. (Taiwan) to collect test data is located on

☒ 70, Lane 169, Sec. 2, Datong Road, Xizhi Dist., New Taipei City 22183, Taiwan, R.O.C.

☒ 68-3, Lane 169, Sec. 2, Datong Road, Xizhi Dist., New Taipei City 22183, Taiwan, R.O.C.

Test site at Bay Area Compliance Laboratories Corp. (Taiwan) has been fully described in reports submitted to the Federal Communication Commission (FCC). The details of these reports have been found to be in compliance with the requirements of Section 2.948 of the FCC Rules on April 22, 2015. The facility also complies with the radiated and AC line conducted test site criteria set forth in ANSI C63.4-2014.

The Federal Communications Commission has the reports on file and is listed under FCC Registration No.: 974454. The test site has been approved by the FCC for public use and is listed in the FCC Public Access Link (PAL) database.

Bay Area Compliance Laboratories Corp. (Taiwan) Lab is accredited to ISO 17025 by Taiwan Accreditation Foundation (TAF code: 3180), Please refer Exhibit E “Certificate and Scope of Accreditation of ISO/IEC 17025:2005 TAF Certificate”

DESCRIPTION OF TEST SYSTEM

These measurements were performed with the automated near-field scanning system DASY6 from Schmid & Partner Engineering AG (SPEAG) which is the Fifth generation of the system shown in the figure hereinafter:

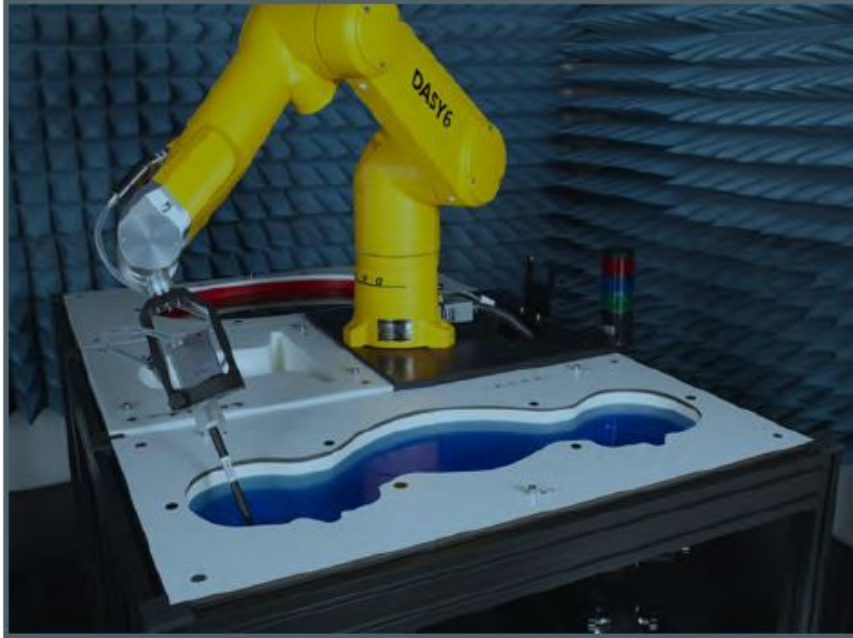

DASY6 System Description

The DASY6 system for performing compliance tests consists of the following items:

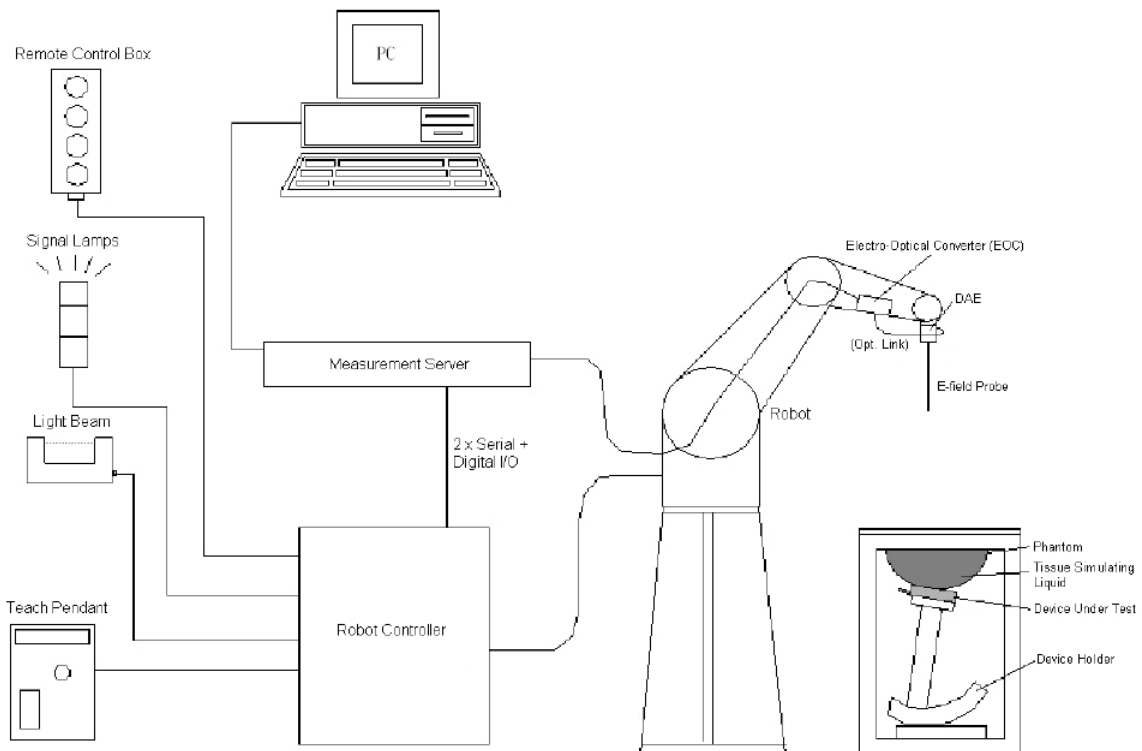

- A standard high precision 6-axis robot (Staubli TX=RX family) with controller, teach pendant and software. An arm extension for accommodating the data acquisition electronics (DAE).
- An isotropic field probe optimized and calibrated for the targeted measurement.
- A data acquisition electronics (DAE) which performs the signal application, signal multiplexing, AD-conversion, offset measurements, mechanical surface detection, collision detection, etc. The unit is battery powered with standard or rechargeable batteries. The signal is optically transmitted to the EOC.
- The Electro-optical converter (EOC) performs the conversion from optical to electrical signals for the digital communication to the DAE. To use optical surface detection, a special version of the EOC is required. The EOC signal is transmitted to the measurement server.
- The function of the measurement server is to perform the time critical tasks such as signal filtering, control of the robot operation and fast movement interrupts.
- The Light Beam used is for probe alignment. This improves the (absolute) accuracy of the probe positioning.
- A computer running Win7 professional operating system and the DASY52 software.
- Remote control and teach pendant as well as additional circuitry for robot safety such as warning lamps, etc.
- The phantom, the device holder and other accessories according to the targeted measurement.

DASY6 Measurement Server

The DASY6 measurement server is based on a PC/104 CPU board with a 400 MHz intel ULV Celeron, 128 MB chip-disk and 128 MB RAM. The necessary circuits for communication with the DAE4 (or DAE3) electronics box, as well as the 16-bit AD converter system for optical detection and digital I/O interface are contained on the DASY6 I/O board, which is directly connected to the PC/104 bus of the CPU board.



The measurement server performs all real-time data evaluations of field measurements and surface detection, controls robot movements, and handles safety operations. The PC operating system cannot interfere with these time-critical processes. All connections are supervised by a watchdog, and disconnection of any of the cables to the measurement server will automatically disarm the robot and disable all program-controlled robot movements. Furthermore, the measurement server is equipped with an expansion port, which is reserved for future applications. Please note that this expansion port does not have a standardized pinout, and therefore only devices provided by SPEAG can be connected. Connection of devices from any other supplier could seriously damage the measurement server.

Data Acquisition Electronics

The data acquisition electronics (DAE4) consist of a highly sensitive electrometer-grade preamplifier with auto-zeroing, a channel and gain-switching multiplexer, a fast 16 bit AD-converter and a command decoder with a control logic unit. Transmission to the measurement server is accomplished through an optical downlink for data and status information, as well as an optical uplink for commands and the clock.

The mechanical probe mounting device includes two different sensor systems for frontal and sideways probe contacts. They are used for mechanical surface detection and probe collision detection.

The input impedance of both the DAE4 as well as of the DAE3 box is 200M Ω ; the inputs are symmetrical and floating. Common mode rejection is above 80 dB.

EX3DV4 E-Field Probes

Frequency	10 MHz to > 6 GHz Linearity: ± 0.2 dB (30 MHz to 6 GHz)
Directivity	± 0.3 dB in TSL (rotation around probe axis) ± 0.5 dB in TSL (rotation normal to probe axis)
Dynamic Range	10 μ W/g to > 100 mW/g Linearity: ± 0.2 dB (noise: typically < 1 μ W/g)
Dimensions	Overall length: 337 mm (Tip: 20 mm) Tip diameter: 2.5 mm (Body: 12 mm) Typical distance from probe tip to dipole centers: 1 mm
Application	High precision dosimetric measurements in any exposure scenario (e.g., very strong gradient fields); the only probe that enables compliance testing for frequencies up to 6 GHz with precision of better 30%.
Compatibility	DASY3, DASY4, DASY52 SAR and higher, EASY4/MRI

SAM Twin Phantom

The SAM Twin Phantom (shown in front of DASY6) is a fiberglass shell phantom with shell thickness 2 mm, except in the ear region where the thickness is increased to 6 mm. The phantom has three measurement areas: 1) Left Head, 2) Right Head, and 3) Flat Section. For larger devices, the use of the ELI-Phantom (shown behind DASY6) is required. For devices such as glasses with a wireless link, the Face Down Phantom is the most suitable (between the SAM Twin and ELI phantoms).

When the phantom is mounted inside allocated slot of the DASY6 platform, phantom reference points can be taught directly in the DASY5 V5.2 software. When the DASY6 platform is used to mount the

phantom, some of the phantom teaching points cannot be reached by the robot in DASY5 V5.2. A special tool called P1a-P2aX-Former is provided to transform two of the three points, P1 and P2, to reachable locations. To use these new teaching points, a revised phantom configuration file is required.

In addition to our standard broadband liquids, the phantom can be used with the following tissue simulating liquids:

Sugar-water-based liquids can be left permanently in the phantom. Always cover the liquid when the system is not in use to prevent changes in liquid parameters due to water evaporation.

DGBE-based liquids should be used with care. As DGBE is a softener for most plastics, the liquid should be taken out of the phantom, and the phantom should be dried when the system is not in use (desirable at least once a week).

- Do not use other organic solvents without previously testing the solvent resistivity of the phantom. Approximately 25 liters of liquid is required to fill the SAM Twin phantom.



Tissue Dielectric Parameters for Head and Body Phantoms

The head tissue dielectric parameters recommended by the IEEE SCC-34/SC-2 in P1528 have been incorporated in the following table. These head parameters are derived from planar layer models simulating the highest expected SAR for the dielectric properties and tissue thickness variations in a human head. Other head and body tissue parameters that have not been specified in P1528 are derived from the tissue dielectric parameters computed from the 4-Cole-Cole equations described in Reference [12] and extrapolated according to the head parameters specified in P1528.

Robots

The DASY6 system uses the high-precision industrial robots TX60L, TX90XL, and RX160L from Staubli SA (France). The TX robot family - the successor of the well-known RX robot family - continues to offer the features important for DASY6 applications:

- High precision (repeatability 0.02mm)
- High reliability (industrial design)
- Low maintenance costs (virtually maintenance free due to direct drive gears; no belt drives)
- Jerk-free straight movements (brushless synchrony motors; no stepper motors)
- Low ELF interference (motor control fields shielded via the closed metallic construction shields)

The robots are controlled by the Staubli CS8c robot controllers. All information regarding the use and maintenance of the robot arm and the robot controller is provided

Area Scans

Area scans are defined prior to the measurement process being executed with a user defined variable spacing between each measurement point (integral) allowing low uncertainty measurements to be conducted. Scans defined for FCC applications utilize a 15mm 2 step integral, with 1.5mm interpolation used to locate the peak SAR area used for zoom scan assessments.

Where the system identifies multiple SAR peaks (which are within 25% of peak value) the system will provide the user with the option of assessing each peak location individually for zoom scan averaging.

Zoom Scan (Cube Scan Averaging)

The averaging zoom scan volume utilized in the DASY4 software is in the shape of a cube and the side dimension of a 1 g or 10 g mass is dependent on the density of the liquid representing the simulated tissue. A density of 1000 kg/m³ is used to represent the head and body tissue density and not the phantom liquid density, in order to be consistent with the definition of the liquid dielectric properties, i.e. the side length of the 1g cube is 10mm, with the side length of the 10g cube is 21.5mm.

When the cube intersects with the surface of the phantom, it is oriented so that 3 vertices touch the surface of the shell or the center of a face is tangent to the surface. The face of the cube closest to the surface is modified in order to conform to the tangent surface.

The zoom scan integer steps can be user defined so as to reduce uncertainty, but normal practice for typical test applications (including FCC) utilize a physical step of 7 x 7 x 7 (5mmx5mmx5mm) providing a volume of 30 mm in the X & Y & Z axis.

Recommended Tissue Dielectric Parameters for Head and Body

Frequency (MHz)	Head Tissue		Body Tissue	
	ϵ_r	σ (S/m)	ϵ_r	σ (S/m)
150	52.3	0.76	61.9	0.80
300	45.3	0.87	58.2	0.92
450	43.5	0.87	56.7	0.94
835	41.5	0.90	55.2	0.97
900	41.5	0.97	55.0	1.05
915	41.5	0.98	55.0	1.06
1450	40.5	1.20	54.0	1.30
1610	40.3	1.29	53.8	1.40
1800-2000	40.0	1.40	53.3	1.52
2450	39.2	1.80	52.7	1.95
3000	38.5	2.40	52.0	2.73
5800	35.3	5.27	48.2	6.00

Tissue Dielectric Parameters for Head and Body Phantoms

The head tissue dielectric parameters recommended by the IEEE SCC-34/SC-2 in P1528 have been incorporated in the following table. These head parameters are derived from planar layer models simulating the highest expected SAR for the dielectric properties and tissue thickness variations in a human head. Other head and body tissue parameters that have not been specified in P1528 are derived from the tissue dielectric parameters computed from the 4-Cole-Cole equations described in Reference [12] and extrapolated according to the head parameters specified in P1528.

EQUIPMENT LIST AND CALIBRATION

Equipments List & Calibration Information

Equipment	Model	S/N	Calibration Date	Calibration Due Date
DASY6 Measurement Server	DASY6	F17/5DQFA1/C/01	NCR	NCR
DASY5 Test Software	DASY5.2	N/A	NCR	NCR
Data Acquisition Electronics	DAE4	527	2018/8/14	2019/8/13
E-Field Probe	EX3DV4	7382	2018/8/10	2018/8/9
Dipole,2450MHz	D2450V2	969	2018/5/30	2021/5/29
Mounting Device	N/A	SD 000 H01 KA	N/A	N/A
Flat Phantom	ELI V8.0	2088	N/A	N/A
Simulated Tissue 2450 MHz Body	TS-2450-B	TS-2450-B	Each Time	/
Network Analyzer	8753D	3410A05361	2018/3/22	2019/3/21
Signal Generator	8648C	3623A02870	2018/5/18	2019/5/17
Power Meter	E4418B	US39402167	2018/5/17	2019/5/16
Power Sensor	E9300A	US39210953	2018/5/17	2019/5/16
Power Amplifier	ZHL-42W+	329401642	2018/1/11	2019/1/10
Directional Coupler	488Z	488Z	N/A	N/A
Attenuator	20dB, 100W	20dB-1	N/A	N/A
Attenuator	3dB, 150W	3dB-1	N/A	N/A

SAR MEASUREMENT SYSTEM VERIFICATION

Liquid Verification

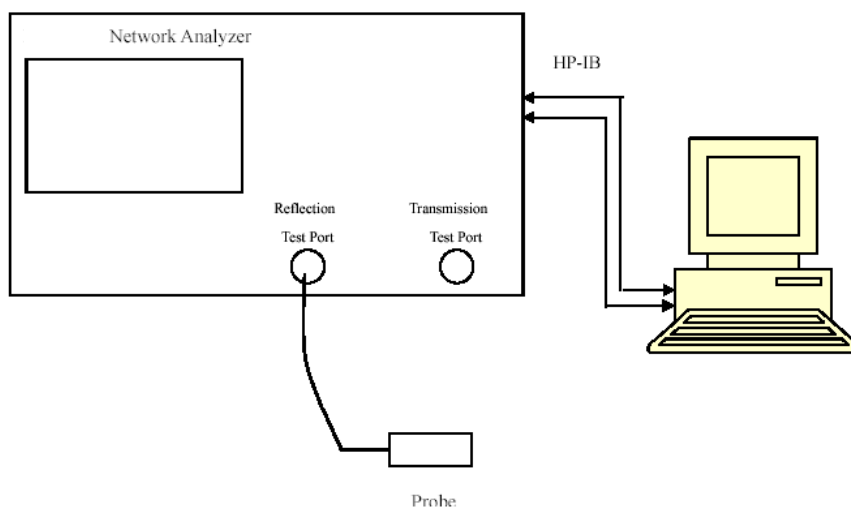

Liquid Verification Setup Block Diagram

Liquid Verification Results

Frequency (MHz)	Liquid Type	Liquid Parameter		Target Value		Delta (%)		Tolerance (%)
		ϵ_r	σ (S/m)	ϵ_r	σ (S/m)	$\Delta\epsilon_r$	$\Delta\sigma$ (S/m)	
2450	Simulated Tissue 2450 MHz Body	53.096	1.975	52.7	1.95	0.75	1.25	± 5
2412	Simulated Tissue 2450 MHz Body	53.238	1.924	52.75	1.91	0.83	0.73	± 5
2437	Simulated Tissue 2450 MHz Body	53.141	1.958	52.72	1.94	0.84	0.93	± 5
2462	Simulated Tissue 2450 MHz Body	53.042	1.991	52.68	1.97	0.65	1.07	± 5

*Liquid Verification above was performed on 2018/9/17.

System Accuracy Verification

Prior to the assessment, the system validation kit was used to test whether the system was operating within its specifications of $\pm 10\%$. The validation results are tabulated below. And also the corresponding SAR plot is attached as well in the SAR plots files.

The spacing distances in the **System Verification Setup Block Diagram** is given by the following:

- a) $s = 15 \text{ mm} \pm 0,2 \text{ mm}$ for $300 \text{ MHz} \leq f \leq 1\,000 \text{ MHz}$;
- b) $s = 10 \text{ mm} \pm 0,2 \text{ mm}$ for $1\,000 \text{ MHz} < f \leq 3\,000 \text{ MHz}$;
- c) $s = 10 \text{ mm} \pm 0,2 \text{ mm}$ for $3\,000 \text{ MHz} < f \leq 6\,000 \text{ MHz}$.

System Verification Setup Block Diagram

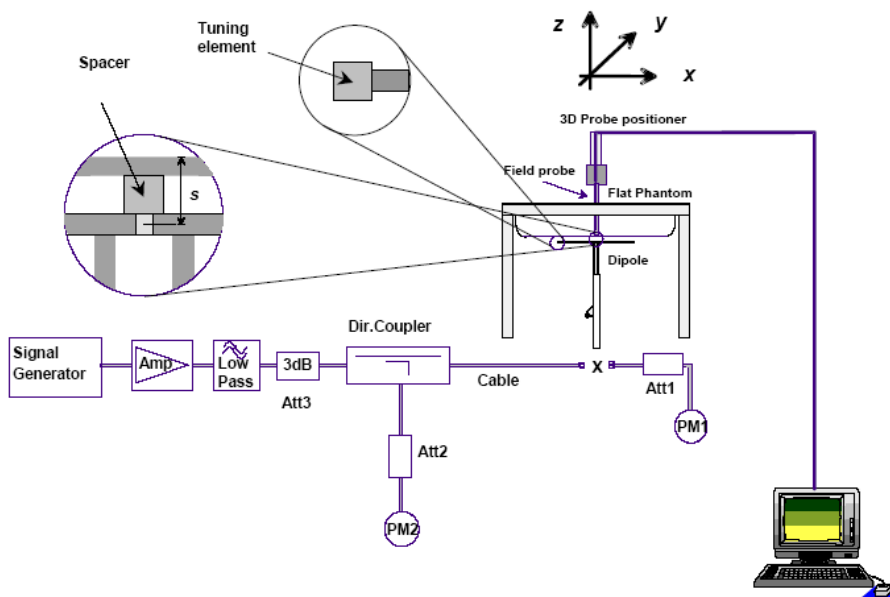

System Accuracy Check Results

Date	Frequency Band	Liquid Type	Input Power (mW)	Measured SAR (W/kg)		Normalized to 1W (W/kg)	Target Value(W/kg)	Delta (%)	Tolerance (%)
2018/9/17	2450 MHz	Body	250	1g	12.6	50.40	54.70	-7.86	± 10

*The SAR values above are normalized to 1 Watt forward power.

SAR SYSTEM VALIDATION DATA

System Check_Body_2450MHz

DUT: D2450V2-969

Communication System: CW; Frequency: 2450 MHz;Duty Cycle: 1:1
 Medium: MSL2450 Medium parameters used : $f = 2450 \text{ MHz}$; $\sigma = 1.975 \text{ S/m}$; $\epsilon_r = 53.096$; $\rho = 1000 \text{ kg/m}^3$

DASY5 Configuration:

- Probe: EX3DV4 - SN7382; ConvF(7.81, 7.81, 7.81); Calibrated: 8/10/2018
- Sensor-Surface: 1.4mm (Mechanical Surface Detection)
- Electronics: DAE4 Sn527; Calibrated: 8/14/2018
- Phantom: EELI V8.0 (20deg probe tilt); Type: QD OVA 004 Ax; Serial: 2088
- Measurement SW: DASY52, Version 52.10 (1);SEMCAD X Version 14.6.11 (7437)

Pin=250mW/Area Scan (61x61x1): Interpolated grid: $dx=1.200 \text{ mm}$, $dy=1.200 \text{ mm}$
 Maximum value of SAR (interpolated) = 20.7 W/kg

Pin=250mW/Zoom Scan (7x7x7)/Cube 0: Measurement grid: $dx=5\text{mm}$, $dy=5\text{mm}$, $dz=5\text{mm}$
 Reference Value = 108.0 V/m; Power Drift = 0.03 dB
 Peak SAR (extrapolated) = 25.3 W/kg
SAR(1 g) = 12.6 W/kg; SAR(10 g) = 5.87 W/kg
 Maximum value of SAR (measured) = 20.8 W/kg

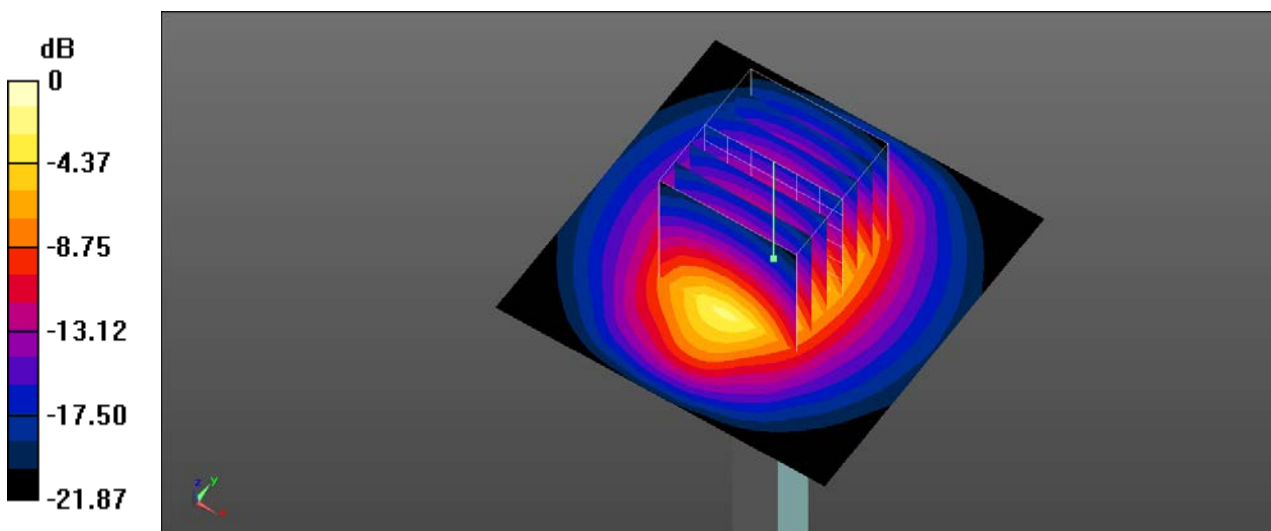

0 dB = 20.8 W/kg = 13.18 dBW/kg

EUT TEST STRATEGY AND METHODOLOGY

Test Positions for Device Operating Next to a Person’s Ear

This category includes most wireless handsets with fixed, retractable or internal antennas located toward the top half of the device, with or without a foldout, sliding or similar keypad cover. The handset should have its earpiece located within the upper ¼ of the device, either along the centerline or off-centered, as perceived by its users. This type of handset should be positioned in a normal operating position with the “test device reference point” located along the “vertical centerline” on the front of the device aligned to the “ear reference point”. The “test device reference point” should be located at the same level as the center of the earpiece region. The “vertical centerline” should bisect the front surface of the handset at its top and bottom edges. A “ear reference point” is located on the outer surface of the head phantom on each ear spacer. It is located 1.5 cm above the center of the ear canal entrance in the “phantom reference plane” defined by the three lines joining the center of each “ear reference point” (left and right) and the tip of the mouth.

A handset should be initially positioned with the earpiece region pressed against the ear spacer of a head phantom. For the SCC-34/SC-2 head phantom, the device should be positioned parallel to the “N-F” line defined along the base of the ear spacer that contains the “ear reference point”. For interim head phantoms, the device should be positioned parallel to the cheek for maximum RF energy coupling. The “test device reference point” is aligned to the “ear reference point” on the head phantom and the “vertical centerline” is aligned to the “phantom reference plane”. This is called the “initial ear position”. While maintaining these three alignments, the body of the handset is gradually adjusted to each of the following positions for evaluating SAR:

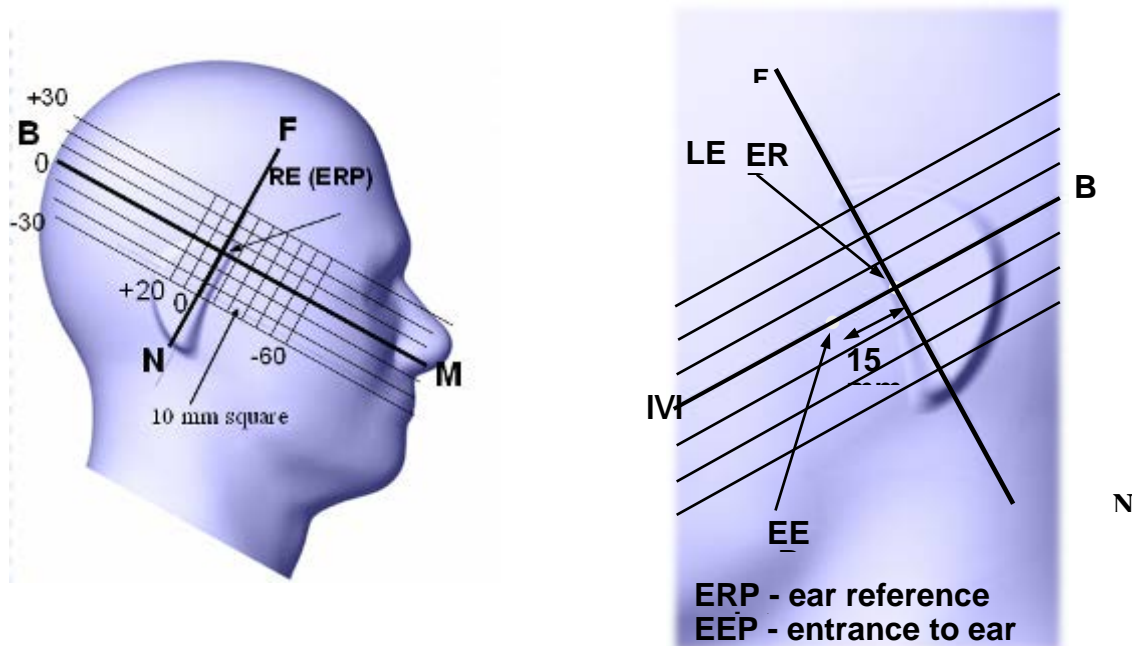

Cheek/Touch Position

The device is brought toward the mouth of the head phantom by pivoting against the “ear reference point” or along the “N-F” line for the SCC-34/SC-2 head phantom.

This test position is established:

When any point on the display, keypad or mouthpiece portions of the handset is in contact with the phantom.

(or) When any portion of a foldout, sliding or similar keypad cover opened to its intended self-adjusting normal use position is in contact with the cheek or mouth of the phantom.

For existing head phantoms – when the handset loses contact with the phantom at the pivoting point, rotation should continue until the device touches the cheek of the phantom or breaks its last contact from the ear spacer.

Cheek /Touch Position

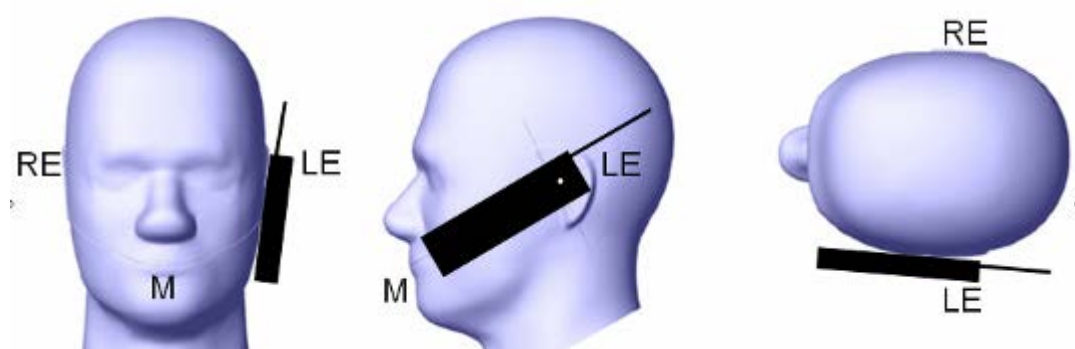

Ear/Tilt Position

With the handset aligned in the “Cheek/Touch Position”:

1) If the earpiece of the handset is not in full contact with the phantom’s ear spacer (in the “Cheek/Touch position”) and the peak SAR location for the “Cheek/Touch” position is located at the ear spacer region or corresponds to the earpiece region of the handset, the device should be returned to the “initial ear position” by rotating it away from the mouth until the earpiece is in full contact with the ear spacer.

2) (otherwise) The handset should be moved (translated) away from the cheek perpendicular to the line passes through both “ear reference points” (note: one of these ear reference points may not physically exist on a split head model) for approximate 2-3 cm. While it is in this position, the device handset is tilted away from the mouth with respect to the “test device reference point” until the inside angle between the vertical centerline on the front surface of the phone and the horizontal line passing through the ear reference point is by 15 80°. After the tilt, it is then moved (translated) back toward the head perpendicular to the line passes through both “ear reference points” until the device touches the phantom or the ear spacer. If the antenna touches the head first, the positioning process should be repeated with a tilt angle less than 15° so that the device and its antenna would touch the phantom simultaneously. This test position may require a device holder or positioner to achieve the translation and tilting with acceptable positioning repeatability.

If a device is also designed to transmit with its keypad cover closed for operating in the head position, such positions should also be considered in the SAR evaluation. The device should be tested on the left and right side of the head phantom in the “Cheek/Touch” and “Ear/Tilt” positions. When applicable, each configuration should be tested with the antenna in its fully extended and fully retracted positions. These test configurations should be tested at the high, middle and low frequency channels of each operating mode; for example, AMPS, CDMA, and TDMA. If the SAR measured at the middle channel for each test configuration (left, right, Cheek/Touch, Tilt/Ear, extended and retracted) is at least 2.0 dB lower than the SAR limit, testing at the high and low channels is optional for such test configuration(s). If the transmission band of the test device is less than 10 MHz, testing at the high and low frequency channels is optional.

Ear /Tilt 15° Position

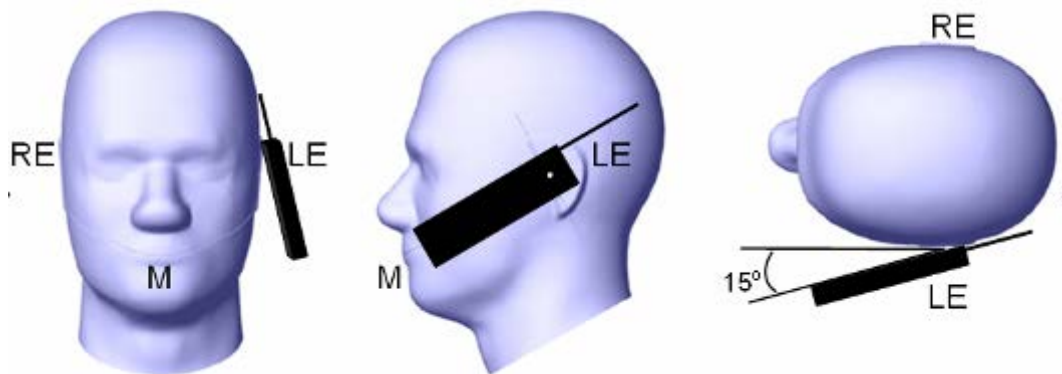

Test positions for body-worn and other configurations

Body-worn operating configurations should be tested with the belt-clips and holsters attached to the device and positioned against a flat phantom in normal use configurations. Devices with a headset output should be tested with a headset connected to the device. When multiple accessories that do not contain metallic components are supplied with the device, the device may be tested with only the accessory that dictates the closest spacing to the body. When multiple accessories that contain metallic components are supplied with the device, the device must be tested with each accessory that contains a unique metallic component. If multiple accessories share an identical metallic component (e.g., the same metallic belt-clip used with different holsters with no other metallic components), only the accessory that dictates the closest spacing to the body must be tested.

Body-worn accessories may not always be supplied or available as options for some devices that are intended to be authorized for body-worn use. A separation distance of 1.5 cm between the back of the device and a flat phantom is recommended for testing body-worn SAR compliance under such circumstances. Other separation distances may be used, but they should not exceed 2.5 cm. In these cases, the device may use body-worn accessories that provide a separation distance greater than that tested for the device provided however that the accessory contains no metallic components.

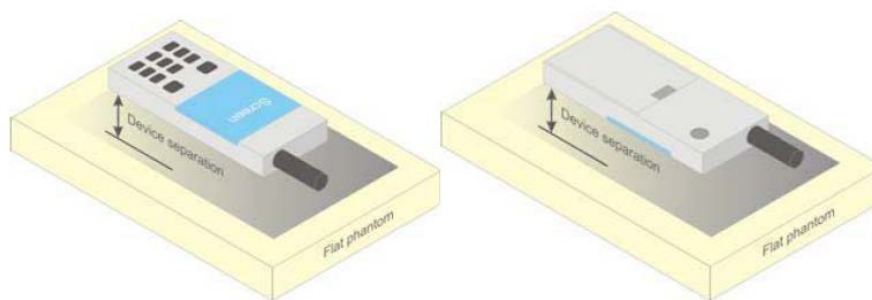

Figure 5 – Test positions for body-worn devices

Test Distance for SAR Evaluation

For this case the EUT(Equipment Under Test) is set 10mm away from the phantom, the test distance is 10mm.

SAR Evaluation Procedure

The evaluation was performed with the following procedure:

Step 1: Measurement of the SAR value at a fixed location above the ear point or central position was used as a reference value for assessing the power drop. The SAR at this point is measured at the start of the test and then again at the end of the testing.

Step 2: The SAR distribution at the exposed side of the head was measured at a distance of 4 mm from the inner surface of the shell. The area covered the entire dimension of the head or radiating structures of the EUT, the horizontal grid spacing was 15 mm x 15 mm, and the SAR distribution was determined by integrated grid of 1.5mm x 1.5mm. Based on these data, the area of the maximum absorption was determined by spline interpolation. The first Area Scan covers the entire dimension of the EUT to ensure that the hotspot was correctly identified.

Step 3: Around this point, a volume of 30 mm x 30 mm x 30 mm was assessed by measuring 7x 7 x 7 points. On the basis of this data set, the spatial peak SAR value was evaluated under the following procedure:

- 1) The data at the surface were extrapolated, since the center of the dipoles is 1.2 mm away from the tip of the probe and the distance between the surface and the lowest measuring point is 1.3 mm. The extrapolation was based on a least square algorithm. A polynomial of the fourth order was calculated through the points in z-axes. This polynomial was then used to evaluate the points between the surface and the probe tip.

- 2) The maximum interpolated value was searched with a straightforward algorithm. Around this maximum the SAR values averaged over the spatial volumes (1 g or 10 g) were computed by the 3D-Spline interpolation algorithm. The 3D-Spline is composed of three one dimensional splines with the "Not a knot"-condition (in x, y and z-directions). The volume was integrated with the trapezoidal-algorithm. One thousand points (10 x 10 x 10) were interpolated to calculate the averages.

All neighboring volumes were evaluated until no neighboring volume with a higher average value was found.

Step 4: Re-measurement of the SAR value at the same location as in Step 1. If the value changed by more than 5%, the evaluation was repeated.

CONDUCTED OUTPUT POWER MEASUREMENT

Provision Applicable

The measured peak output power should be greater and within 5% than EMI measurement.

Test Procedure

The RF output of the transmitter was connected to the input of the EMI Test Receiver through sufficient attenuation.

Radio Configuration

The power measurement was tested by Power meter.

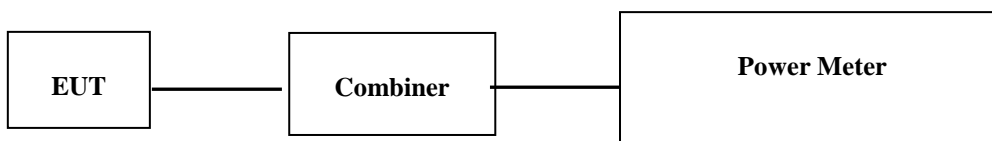

Wi-Fi 2.4G

Maximum Target Output Power

Max Target Power(dBm)			
Mode/Band	Channel		
	Low	Middle	High
WLAN(802.11b)	12.0	12.0	12.5
WLAN(802.11g)	10.5	11.5	12.0
WLAN(802.11n HT20)	10.5	11.0	12.0
Bluetooth(BDR/EDR)	-11	-11	-11
Bluetooth BLE	1.5	1.0	0

Test Results:**WLAN 2.4GHz:**

Mode	Channel frequency	Data Rate	RF Output Power
802.11b	2412	1Mbps	11.38
	2437		11.84
	2462		12.27
802.11g	2412	6Mbps	10.42
	2437		11.22
	2462		11.68
802.11n HT20	2412	MCS0	10.48
	2437		10.98
	2462		11.62

Note:

The output power was tested under data rate 1Mbps for 802.11b, 6Mbps for 802.11g, MCS0 for 802.11n HT20

Bluetooth:

Mode	Channel frequency (MHz)	RF Output Power (dBm)
BDR(GFSK)	2402	-12.38
	2441	-12.43
	2480	-12.75
EDR($\pi/4$ -DQPSK)	2402	-12.04
	2441	-12.76
	2480	-12.48
EDR(8-DPSK)	2402	-11.50
	2441	-12.78
	2480	-13.56
Bluetooth LE	2402	1.08
	2440	1.19
	2480	-1.03

Standalone SAR test exclusion considerations

Antennas Location:

Bottom Face

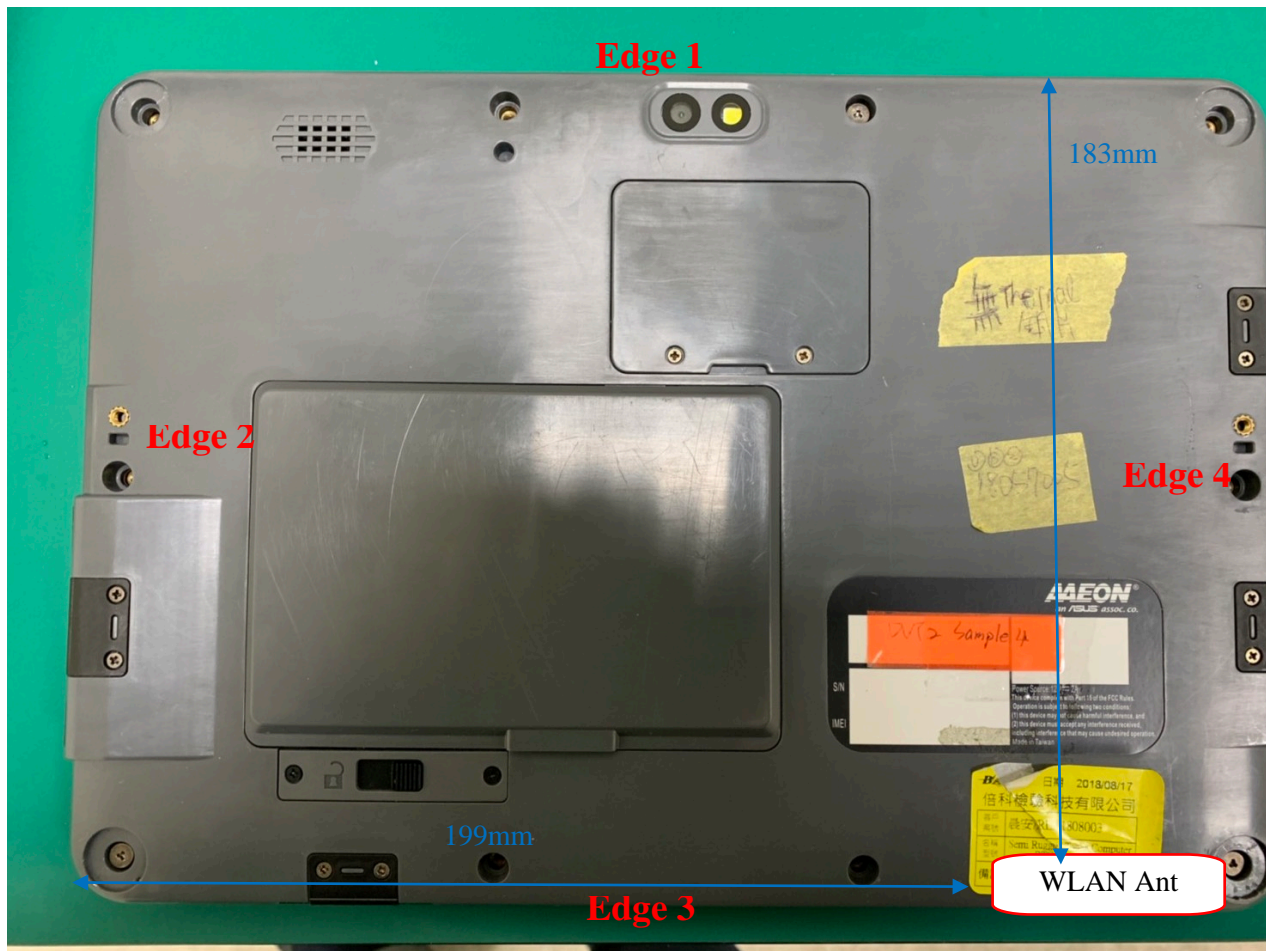

Note: The Protective material on corners was removed during SAR test.

Antenna Distance To Edge

Antenna Distance To Edge(mm)					
Antenna	Bottom Face	Edge 1	Edge 2	Edge 3	Edge 4
WLAN/ Bluetooth/	<5	183	199	<5	26.5

Standalone SAR test exclusion considerations

Mode	Frequency (MHz)	Pavg (dBm)	Pavg (mW)	Min. Test Distance (mm)	Calculated value	Threshold (1-g)	SAR Test Exclusion
WLAN	2462	12.5	18.0	0	5.65	3.0	No
Bluetooth	2480	1.50	1.0	0	0.45	3.0	YES

NOTE:

The 1-g and 10-g SAR test exclusion thresholds for 100 MHz to 6 GHz at test separation distances ≤ 50 mm are determined by:

$$[(\text{max. power of channel, including tune-up tolerance, mW}) / (\text{min. test separation distance, mm})] \cdot [\sqrt{f(\text{GHz})}] \leq 3.0 \text{ for 1-g SAR and } \leq 7.5 \text{ for 10-g extremity SAR, where}$$

1. f(GHz) is the RF channel transmit frequency in GHz.
2. Power and distance are rounded to the nearest mW and mm before calculation.
3. The result is rounded to one decimal place for comparison.
4. When the minimum test separation distance is < 5 mm, a distance of 5 mm is applied to determine SAR test Exclusion.

SAR test exclusion for the EUT edge considerations Result

Mode	Bottom Face	Edge 1	Edge 2	Edge 3	Edge 4
2.4GHz WLAN	Required	Exclusion	Exclusion	Required	Exclusion

Note:

- Required:** The distance to Edge is less than 25mm, testing is required.
- Exclusion*:** SAR test exclusion evaluation has been done above.
- Exclusion:** The distance to Edge is more than 25 mm, testing is not required.

Standalone SAR test exclusion considerations(RSS-102):

Mode	Frequency (MHz)	Pavg (dBm)	Antenna Gain(dBi)	e.i.r.p. (mW)	Test Exclusion Limits (mW)
2.4GHz WLAN	2462	12.5	1.6	26	4
Bluetooth	2480	1.50	1.6	2	4

NOTE:

- 1, When the operating frequency of the device is between two frequencies located in Table 1of **RSS-102 Issue 5 March 2015**, linear interpolation shall be applied for the applicable separation distance.
- 2, When the **Test Exclusion Distance** is farther than **50mm** and less than 200mm, testing for each edge is required.

SAR test exclusion for the EUT edge considerations Result

Exposure Position	Wireless Interface	2.4GHz WLAN
	Maximum power (dBm)	14.1
	Maximum rated power(mW)	26.0
Bottom Face	Separation distance(mm)	5.0
	Exemption Limits (mW)	4.0
	Testing required?	Yes
Edge 1	Separation distance(mm)	183.0
	Exemption Limits (mW)	309.0
	Testing required?	No
Edge 2	Separation distance(mm)	199.0
	Exemption Limits (mW)	309.0
	Testing required?	No
Edge 3	Separation distance(mm)	5.0
	Exemption Limits (mW)	4.0
	Testing required?	Yes
Edge 4	Separation distance(mm)	26.5
	Exemption Limits (mW)	83.0
	Testing required?	No

Mode	Bottom Face	Edge 1	Edge 2	Edge 3	Edge 4
2.4GHz WLAN	Required	Exclusion	Exclusion	Required	Exclusion

Note:

Required:The distance is less than **Test Exclusion Distance**, the SAR test is required.
 Exclusion: The distance is large than **Test Exclusion Distance**, SAR test is not required.

Only when the distance from the antenna to edge is large than **Test Exclusion Distance specified under KDB and RSS-102 Issue 5 March 2015**, SAR test is not required

SAR MEASUREMENT RESULTS

This page summarizes the results of the performed dosimetric evaluation.

SAR Test Data

Environmental Conditions

Temperature:	22.1-22.5 °C
Relative Humidity:	44 %
ATM Pressure:	99.8 kPa
Test Date:	2018/9/17

Testing was performed by Angelo Chang

WLAN 2.4G :

Plot No.	Band	Mode	Test Position	Gap (mm)	Ch.	Freq. (MHz)	Average Power (dBm)	Tune-Up Limit (dBm)	Tune-up Scaling Factor	Power Drift (dB)	Measured 1g SAR (W/kg)	Reported 1g SAR (W/kg)
1	WLAN2.4G	802.11b 1Mbps	Bottom Face	0	11	2462	12.27	12.50	1.054	0.08	0.245	0.258
2	WLAN2.4G	802.11b 1Mbps	Edge3	0	11	2462	12.27	12.50	1.054	0.05	0.369	0.389
3	WLAN2.4G	802.11b 1Mbps	Edge3	0	1	2412	11.38	11.50	1.028	0.09	0.381	0.392
4	WLAN2.4G	802.11b 1Mbps	Edge3	0	6	2437	11.84	12.00	1.038	0.01	0.370	0.384

Note:

1. When the 1-g SAR is ≤ 0.8 W/kg, testing for other channels are optional.
2. When SAR or MPE is not measured at the maximum power level allowed for production units, the results must be scaled to the maximum tune-up tolerance limit according to the power applied to the individual channels tested to determine compliance.
3. KDB 248227 D01-SAR is not required for 2.4 GHz OFDM when the highest reported SAR for DSSS is adjusted by the ratio of OFDM to DSSS specified maximum output power and the adjusted SAR is ≤ 1.2 W/kg.
4. For modes that peak SAR is too low to evaluate, a SAR value 0.01W/kg is considered as their Scaled SAR.
5. According to IEC 62209-2:2010 ,If the correction Δ SAR has a positive sign, the measured SAR results shall not be corrected.
6. The Long range Hopping antenna was removed, when the EUT was tested in top setup position, for sufficiently conservative consideration.

Corrected SAR Evaluation

62209-2 © IEC:2010

– 89 –

Annex F
(normative)**SAR correction for deviations of complex permittivity from targets****F.2 SAR correction formula**

From [13] and [14], a linear relationship was found between the percent change in SAR (denoted ΔSAR) and the percent change in the permittivity and conductivity from the target values in Table 1 (denoted $\Delta \epsilon_r$ and $\Delta \sigma$, respectively). This linear relationship agrees with the results of Kuster and Balzano [48] and Bit-Babik et al. [2]. The relationship is given by:

$$\Delta SAR = c_\epsilon \Delta \epsilon_r + c_\sigma \Delta \sigma \quad (F.1)$$

where

$c_\epsilon = \partial(\Delta SAR)/\partial(\Delta \epsilon)$ is the coefficients representing the sensitivity of SAR to permittivity where SAR is normalized to output power;

$c_\sigma = \partial(\Delta SAR)/\partial(\Delta \sigma)$ is the coefficients representing the sensitivity of SAR to conductivity, where SAR is normalized to output power.

The values of c_ϵ and c_σ have a simple relationship with frequency that can be described using polynomial equations. For the 1 g averaged SAR c_ϵ and c_σ are given by

$$c_\epsilon = -7,854 \times 10^{-4} f^3 + 9,402 \times 10^{-3} f^2 - 2,742 \times 10^{-2} f - 0,2026 \quad (F.2)$$

$$c_\sigma = 9,804 \times 10^{-3} f^3 - 8,661 \times 10^{-2} f^2 + 2,981 \times 10^{-2} f + 0,7829 \quad (F.3)$$

where

f is the frequency in GHz.

For the 10 g averaged SAR, the variables c_ϵ and c_σ are given by:

$$c_\epsilon = 3,456 \times 10^{-3} f^3 - 3,531 \times 10^{-2} f^2 + 7,675 \times 10^{-2} f - 0,1860 \quad (F.4)$$

$$c_\sigma = 4,479 \times 10^{-3} f^3 - 1,586 \times 10^{-2} f^2 - 0,1972 f + 0,7717 \quad (F.5)$$

Corrected SAR Evaluation Table

Frequency (MHz)	Liquid Type	C ε	Δεr	C δ	Δδ	ΔSAR (%)
2412	Body	0.83	-0.225	0.73	0.489	0.17
2437	Body	0.84	-0.225	0.93	0.483	0.26
2462	Body	0.65	-0.225	1.07	0.478	0.36

$$\Delta SAR = c_{\epsilon} \Delta \epsilon_r + c_{\sigma} \Delta \sigma$$

$$c_{\epsilon} = -7,854 \times 10^{-4} f^3 + 9,402 \times 10^{-3} f^2 - 2,742 \times 10^{-2} f - 0,2026$$

$$c_{\sigma} = 9,804 \times 10^{-3} f^3 - 8,661 \times 10^{-2} f^2 + 2,981 \times 10^{-2} f + 0,7829$$

where

f is the frequency in GHz.

$$\text{Corrected SAR} = \text{Measured SAR} * ((100 + (\Delta SAR \times -1)) / 100)$$

SAR SIMULTANEOUS TRANSMISSION DESCRIPTION

Simultaneous Transmission:

Description of Simultaneous Transmit Capabilities		
Transmitter Combination	Simultaneous?	Hotspot?
Bluetooth +WLAN Main	X	X

SAR Plots

Test Laboratory: BACL . SAR Testing Lab

#01_WLAN2.4GHz_802.11b 1Mbps_Bottom Face_0mm_Ch11

Communication System: 802.11b ; Frequency: 2462 MHz;Duty Cycle: 1:1

Medium: MSL2450 Medium parameters used: $f = 2462$ MHz; $\sigma = 1.991$ S/m; $\epsilon_r = 53.042$; $\rho = 1000$ kg/m³

DASY5 Configuration:

- Probe: EX3DV4 - SN7382; ConvF(7.81, 7.81, 7.81); Calibrated: 8/10/2018
- Sensor-Surface: 1.4mm (Mechanical Surface Detection)
- Electronics: DAE4 Sn527; Calibrated: 8/14/2018
- Phantom: ELI-Righr-ELI V8.0 (20deg probe tilt); Type: QD OVA 004 Ax; Serial: 2088
- Measurement SW: DASY52, Version 52.10 (1);SEMCAD X Version 14.6.11 (7437)

Ch11/Area Scan (31x51x1): Interpolated grid: dx=1.200 mm, dy=1.200 mm

Maximum value of SAR (interpolated) = 0.442 W/kg

Ch11/Zoom Scan (7x7x7)/Cube 0: Measurement grid: dx=5mm, dy=5mm, dz=5mm

Reference Value = 14.51 V/m; Power Drift = 0.08 dB

Peak SAR (extrapolated) = 0.538 W/kg

SAR(1 g) = 0.245 W/kg; SAR(10 g) = 0.096 W/kg

Maximum value of SAR (measured) = 0.444 W/kg

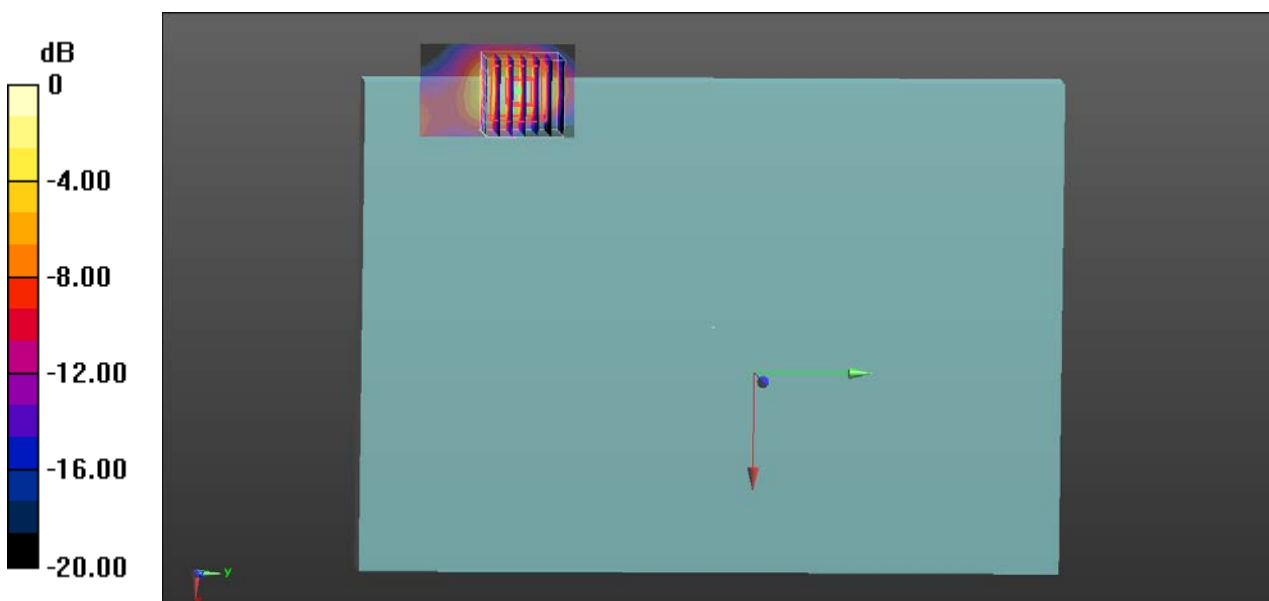

0 dB = 0.444 W/kg = -3.53 dBW/kg

Test Laboratory: BACL . SAR Testing Lab

#02_WLAN2.4GHz_802.11b 1Mbps_Edge 3_0mm_Ch11

Communication System: 802.11b ; Frequency: 2462 MHz;Duty Cycle: 1:1

Medium: MSL2450 Medium parameters used: $f = 2462$ MHz; $\sigma = 1.991$ S/m; $\epsilon_r = 53.042$; $\rho = 1000$ kg/m³

DASY5 Configuration:

- Probe: EX3DV4 - SN7382; ConvF(7.81, 7.81, 7.81); Calibrated: 8/10/2018
- Sensor-Surface: 1.4mm (Mechanical Surface Detection)
- Electronics: DAE4 Sn527; Calibrated: 8/14/2018
- Phantom: ELI-Righr-ELI V8.0 (20deg probe tilt); Type: QD OVA 004 Ax; Serial: 2088
- Measurement SW: DASY52, Version 52.10 (1);SEMCAD X Version 14.6.11 (7437)

Ch11/Area Scan (31x51x1): Interpolated grid: dx=1.200 mm, dy=1.200 mm

Maximum value of SAR (interpolated) = 0.704 W/kg

Ch11/Zoom Scan (7x7x7)/Cube 0: Measurement grid: dx=5mm, dy=5mm, dz=5mm

Reference Value = 17.75 V/m; Power Drift = 0.05 dB

Peak SAR (extrapolated) = 0.809 W/kg

SAR(1 g) = 0.369 W/kg; SAR(10 g) = 0.150 W/kg

Maximum value of SAR (measured) = 0.656 W/kg

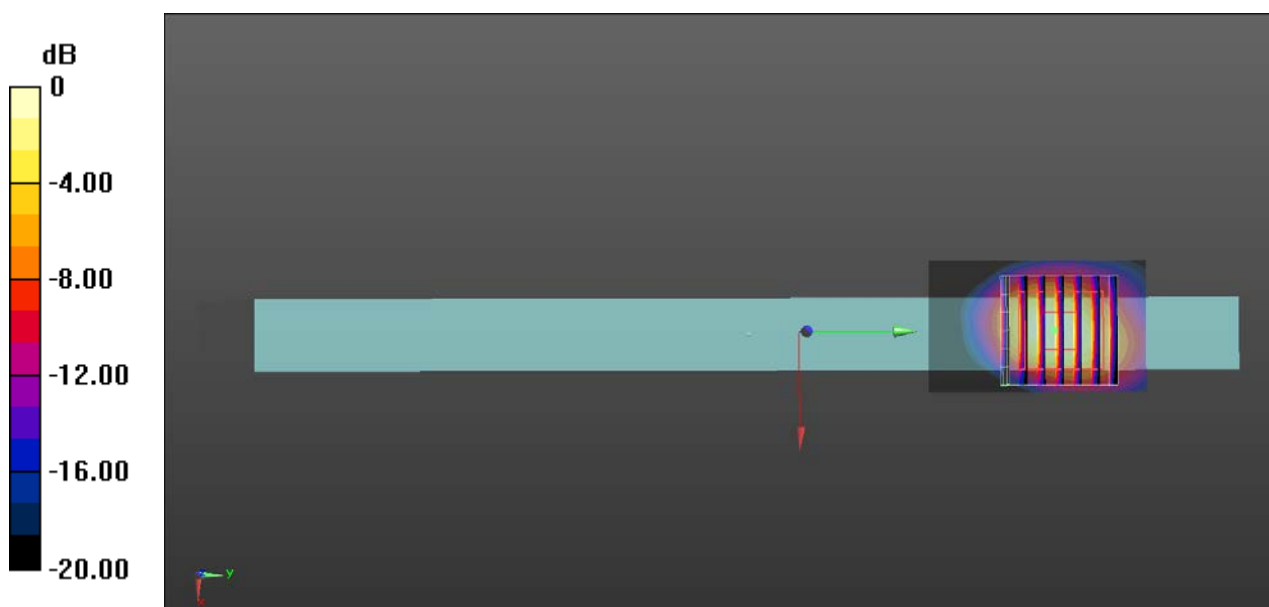

0 dB = 0.656 W/kg = -1.83 dBW/kg

Test Laboratory: BACL . SAR Testing Lab

#03_WLAN2.4GHz_802.11b 1Mbps_Edge 3_0mm_Ch1

Communication System: 802.11b ; Frequency: 2412 MHz;Duty Cycle: 1:1

Medium: MSL2450 Medium parameters used: $f = 2412$ MHz; $\sigma = 1.924$ S/m; $\epsilon_r = 53.238$; $\rho = 1000$ kg/m³

DASY5 Configuration:

- Probe: EX3DV4 - SN7382; ConvF(7.81, 7.81, 7.81); Calibrated: 8/10/2018
- Sensor-Surface: 1.4mm (Mechanical Surface Detection)
- Electronics: DAE4 Sn527; Calibrated: 8/14/2018
- Phantom: ELI-Righr-ELI V8.0 (20deg probe tilt); Type: QD OVA 004 Ax; Serial: 2088
- Measurement SW: DASY52, Version 52.10 (1);SEMCAD X Version 14.6.11 (7437)

Ch1/Area Scan (41x51x1): Interpolated grid: dx=1.200 mm, dy=1.200 mm

Maximum value of SAR (interpolated) = 0.737 W/kg

Ch1/Zoom Scan (7x7x7)/Cube 0: Measurement grid: dx=5mm, dy=5mm, dz=5mm

Reference Value = 15.47 V/m; Power Drift = 0.09 dB

Peak SAR (extrapolated) = 0.840 W/kg

SAR(1 g) = 0.381 W/kg; SAR(10 g) = 0.157 W/kg

Maximum value of SAR (measured) = 0.673 W/kg

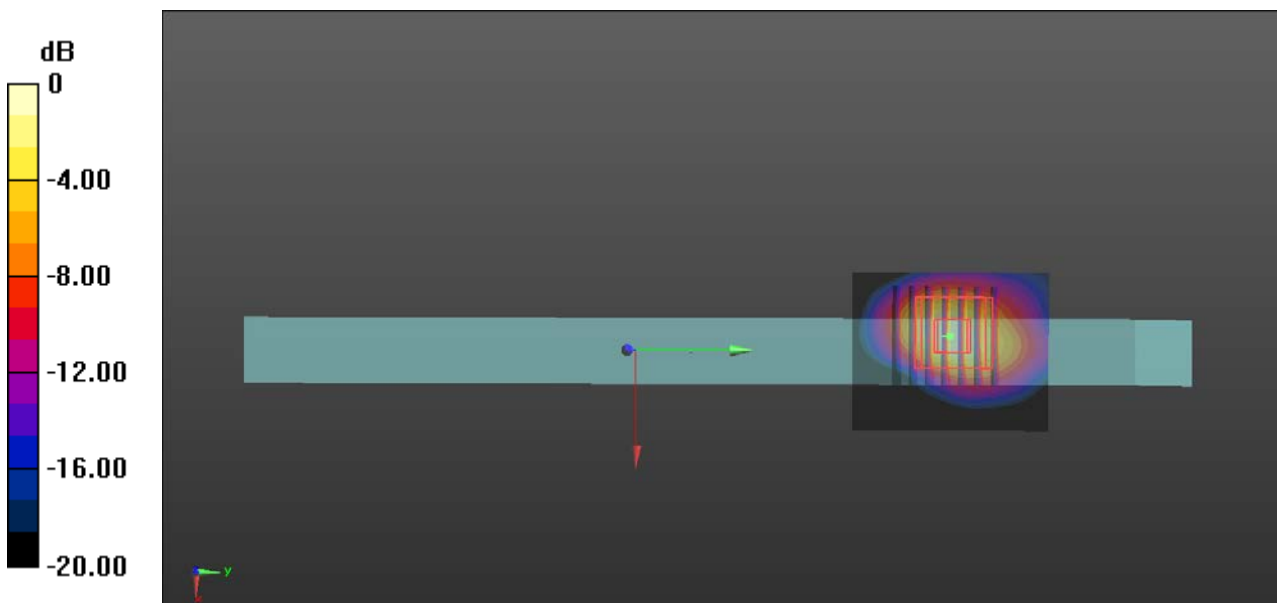

0 dB = 0.673 W/kg = -1.72 dBW/kg

Test Laboratory: BACL . SAR Testing Lab

#04_WLAN2.4GHz_802.11b 1Mbps_Edge 3_0mm_Ch6

Communication System: 802.11b ; Frequency: 2437 MHz;Duty Cycle: 1:1
 Medium: MSL2450 Medium parameters used : $f = 2437$ MHz; $\sigma = 1.958$ S/m; $\epsilon_r = 53.141$; $\rho = 1000$ kg/m³

DASY5 Configuration:

- Probe: EX3DV4 - SN7382; ConvF(7.81, 7.81, 7.81); Calibrated: 8/10/2018
- Sensor-Surface: 1.4mm (Mechanical Surface Detection)
- Electronics: DAE4 Sn527; Calibrated: 8/14/2018
- Phantom: ELI-Righr-ELI V8.0 (20deg probe tilt); Type: QD OVA 004 Ax; Serial: 2088
- Measurement SW: DASY52, Version 52.10 (1);SEMCAD X Version 14.6.11 (7437)

Ch6/Area Scan (41x51x1): Interpolated grid: dx=1.200 mm, dy=1.200 mm
 Maximum value of SAR (interpolated) = 0.709 W/kg

Ch6/Zoom Scan (7x7x7)/Cube 0: Measurement grid: dx=5mm, dy=5mm, dz=5mm
 Reference Value = 11.79 V/m; Power Drift = 0.01 dB
 Peak SAR (extrapolated) = 0.806 W/kg
SAR(1 g) = 0.370 W/kg; SAR(10 g) = 0.152 W/kg
 Maximum value of SAR (measured) = 0.647 W/kg

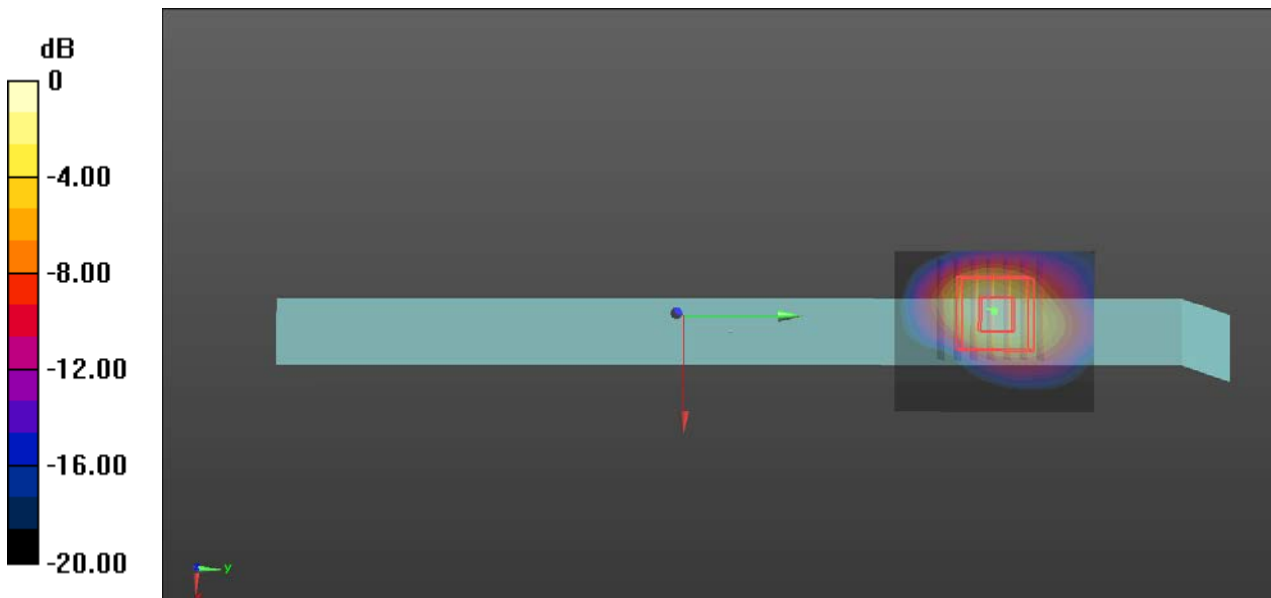

0 dB = 0.647 W/kg = -1.89 dBW/kg

Appendix A Measurement Uncertainty

The uncertainty budget has been determined for the measurement system and is given in the following Table.

Measurement uncertainty evaluation for IEEE1528-2013 SAR test

Source of uncertainty	Tolerance/ uncertainty ± %	Probability distribution	Divisor	ci (1 g)	ci (10 g)	Standard uncertainty ± %, (1 g)	Standard uncertainty ± %, (10 g)
Measurement system							
Probe calibration	6.55	N	1	1	1	6.6	6.6
Axial Isotropy	4.7	R	$\sqrt{3}$	1	1	2.7	2.7
Hemispherical Isotropy	9.6	R	$\sqrt{3}$	0	0	0.0	0.0
Boundary effect	1.0	R	$\sqrt{3}$	1	1	0.6	0.6
Linearity	4.7	R	$\sqrt{3}$	1	1	2.7	2.7
Detection limits	1.0	R	$\sqrt{3}$	1	1	0.6	0.6
Readout electronics	0.3	N	1	1	1	0.3	0.3
Response time	0.0	R	$\sqrt{3}$	1	1	0.0	0.0
Integration time	0.0	R	$\sqrt{3}$	1	1	0.0	0.0
RF ambient conditions – noise	1.0	R	$\sqrt{3}$	1	1	0.6	0.6
RF ambient conditions–reflections	1.0	R	$\sqrt{3}$	1	1	0.6	0.6
Probe positioner mech. Restrictions	0.8	R	$\sqrt{3}$	1	1	0.5	0.5
Probe positioning with respect to phantom shell	6.7	R	$\sqrt{3}$	1	1	3.9	3.9
Post-processing	2.0	R	$\sqrt{3}$	1	1	1.2	1.2
Test sample related							
Test sample positioning	2.8	N	1	1	1	2.8	2.8
Device holder uncertainty	6.3	N	1	1	1	6.3	6.3
Drift of output power	5.0	R	$\sqrt{3}$	1	1	2.9	2.9
Phantom and set-up							
Phantom uncertainty (shape and thickness tolerances)	4.0	R	$\sqrt{3}$	1	1	2.3	2.3
Liquid conductivity target)	5.0	R	$\sqrt{3}$	0.64	0.43	1.8	1.2
Liquid conductivity meas.)	2.5	N	1	0.64	0.43	1.6	1.1
Liquid permittivity target)	5.0	R	$\sqrt{3}$	0.6	0.49	1.7	1.4
Liquid permittivity meas.)	2.5	N	1	0.6	0.49	1.5	1.2
Combined standard uncertainty		RSS				12.2	12.0
Expanded uncertainty 95 % confidence interval)						24.3	23.9

Measurement uncertainty evaluation for IEC62209-2 SAR test

Source of uncertainty	Tolerance/uncertainty ± %	Probability distribution	Divisor	ci (1 g)	ci (10 g)	Standard uncertainty ± %, (1 g)	Standard uncertainty ± %, (10 g)
Measurement system							
Probe calibration	6.55	N	1	1	1	6.6	6.6
Axial Isotropy	4.7	R	√3	1	1	2.7	2.7
Hemispherical Isotropy	9.6	R	√3	0	0	0.0	0.0
Linearity	4.7	R	√3	1	1	2.7	2.7
Modulation Response	0.0	R	√3	1	1	0.0	0.0
Detection limits	1.0	R	√3	1	1	0.6	0.6
Boundary effect	1.0	R	√3	1	1	0.6	0.6
Readout electronics	0.3	N	1	1	1	0.3	0.3
Response time	0.0	R	√3	1	1	0.0	0.0
Integration time	0.0	R	√3	1	1	0.0	0.0
RF ambient conditions – noise	1.0	R	√3	1	1	0.6	0.6
RF ambient conditions–reflections	1.0	R	√3	1	1	0.6	0.6
Probe positioner mech. Restrictions	0.8	R	√3	1	1	0.5	0.5
Probe positioning with respect to phantom shell	6.7	R	√3	1	1	3.9	3.9
Post-processing	2.0	R	√3	1	1	1.2	1.2
Test sample related							
Device holder Uncertainty	6.3	N	1	1	1	6.3	6.3
Test sample positioning	2.8	N	1	1	1	2.8	2.8
Power scaling	4.5	R	√3	1	1	2.6	2.6
Drift of output power	5.0	R	√3	1	1	2.9	2.9
Phantom and set-up							
Phantom uncertainty (shape and thickness tolerances)	4.0	R	√3	1	1	2.3	2.3
Algorithm for correcting SAR for deviations in permittivity and conductivity	1.9	N	1	1	0.84	1.1	0.9
Liquid conductivity (meas.)	2.5	N	1	0.64	0.43	1.6	1.1
Liquid permittivity (meas.)	2.5	N	1	0.6	0.49	1.5	1.2
Temp. unc. - Conductivity	1.7	R	√3	0.78	0.71	0.8	0.7
Temp. unc. - Permittivity	0.3	R	√3	0.23	0.26	0.0	0.0
Combined standard uncertainty		RSS				12.2	12.1
Expanded uncertainty 95 % confidence interval)						24.5	24.2

Appendix B EUT Test Position Photos

Please refer attached filed RLK1808003-23 SAR Report-Appendix B EUT Test Position Photos.

Appendix C Calibration Certification

RLK1808003-23 SAR Report-Appendix C Calibration Certification

******* END OF REPORT *******