

SAR MEASUREMENT REPORT

FCC ID: OHBRTC1010-A11
Applicant: AAEON Technology, Inc.
Product: Intel Dual Band Wireless-AC 9260
Model No.: 9260NGW
Brand Name: AAEON Technology Inc.
FCC Rule Part(s): FCC 47 CFR Part 2.1093
Test Date: 2022-08-03 ~ 2022-08-05

Reviewed By:

Jame Yuan

Approved By:

Robin Wu



The test results relate only to the samples tested.

This equipment has been shown to be capable of compliance with the applicable technical standards as indicated in the measurement report and was tested in accordance with the measurement procedures specified in IEEE1528, KDB 447498 and KDB 865664. Test results reported herein relate only to the item(s) tested.

The test report shall not be reproduced except in full without the written approval of MRT Technology (Suzhou) Co., Ltd.

Revision History

Report No.	Version	Description	Issue Date	Note
2206RSU062-U1	Rev. 01	Initial Report	2022-08-10	Valid

CONTENTS

Description	Page
1. General Information.....	5
1.1. Applicant.....	5
1.2. Manufacturer	5
1.3. Testing Facility.....	5
1.4. Product Information	6
1.5. Radio Specification	7
1.6. Antennas Details	8
2. Summary of Test Result.....	9
2.1. Test Standards	9
2.2. Environment Condition	9
2.3. RF Exposure Limits	9
2.4. Test Result Summary	10
3. Specific Absorption Rate (SAR).....	11
3.1. Introduction.....	11
3.2. Definition	11
4. DASY6 Measurement System	12
4.1. Introduction.....	12
4.2. DASY6 Measurement System Diagram.....	12
4.3. System Components Details.....	13
5. The SAR Measurement Procedure	24
5.1. Measurement Process Diagram.....	24
5.2. Test Position Definition	24
5.3. Test Procedure	28
6. System Verificaiton.....	30
6.1. Tissue Check.....	30
6.2. System Check	33
7. Analysis and Results.....	35
7.1. Antenna Location.....	35
7.2. Conducted Power	36
7.3. SAR Exclusion Analysis.....	40
7.4. SAR Test Results	41
7.5. Estimated SAR Calculation.....	46

8. Simultaneous Transmission Analysis.....	47
9. Test Equipment Used	48
10. Measurement Uncertainty	49
Annex A - System Check Result	51
Annex B - Test Data Plots	54
Annex C - SAR Test Setup Photos.....	65
Annex D - EUT External Photos	66
Annex E - Equipment Calibration Report	67

1. General Information

1.1. Applicant

AAEON Technology, Inc.

5F, No. 135, Lane 235, Pao Chiao Rd., Hsin-Tien Dist., New Taipei City, 231, Taiwan R.O.C.

1.2. Manufacturer

AAEON Technology, Inc.

5F, No. 135, Lane 235, Pao Chiao Rd., Hsin-Tien Dist., New Taipei City, 231, Taiwan R.O.C.

1.3. Testing Facility

<input checked="checked" type="checkbox"/>	Test Site – MRT Suzhou Laboratory
	Laboratory Location (Suzhou – Wuzhong) D8 Building, No.2 Tian'edang Rd., Wuzhong Economic Development Zone, Suzhou, China
	Laboratory Location (Suzhou – SIP) 4b Building, Liando U Valley, No.200 Xingpu Rd., Shengpu Town, Suzhou Industrial Park, China
	Laboratory Accreditations
	A2LA: 3628.01 FCC: CN1166 VCCI: R-20025, G-20034, C-20020, T-20020
	CNAS: L10551 ISED: CN0001
<input type="checkbox"/>	Test Site – MRT Shenzhen Laboratory
	Laboratory Location (Shenzhen) 1G, Building A, Junxiangda Building, Zhongshanyuan Road West, Nanshan District, Shenzhen, China
	Laboratory Accreditations
	A2LA: 3628.02 FCC: CN1284
	CNAS: L10551 ISED: CN0105
<input type="checkbox"/>	Test Site – MRT Taiwan Laboratory
	Laboratory Location (Taiwan) No. 38, Fuxing 2 nd Rd., Guishan Dist., Taoyuan City 333, Taiwan (R.O.C.)
	Laboratory Accreditations
	TAF: L3261-190725 FCC: 291082, TW3261
	ISED: TW3261

1.4. Product Information

Product Name	Intel Dual Band Wireless-AC 9260
Model No.	9260NGW
Test Device Label No.	20220704Sample#08
Antenna Information	Refer to section 1.6
EUT Type	Portable Device
Exposure Category	General Population/Uncontrolled Exposure
Accessories	
Adapter	Model No.: FSP036-DHAN3 AC Input: 100-240V~, 1.2A 50-60Hz DC Output: 12.0V=3.0A 36W MAX
Battery 1#	Model No.: RTC1200 Capacity: 2270mAh Rated Voltage: DC 14.4V
Battery 2#	Model No.: RTC600S Capacity: 1530mAh Rated Voltage: DC 7.4V
Remark: 1. The information of EUT was provided by the manufacturer, and the accuracy of the information shall be the responsibility of the manufacturer. 2. This case is to add Host (Product Name: Rugged Tablet / Model No.: RTC-1010), This C2PC establishes portable category SAR conditions, The Original Granted date: 08/10/2022, FCC ID: OHBRTC1010-A11.	

1.5. Radio Specification

Wi-Fi Specification	
Frequency Range	<u>For 2.4GHz Wi-Fi</u> 802.11b/g/n-HT20: 2412 ~ 2462 MHz 802.11n-HT40: 2422 ~ 2452 MHz <u>For 5GHz Wi-Fi</u> 802.11a/n-HT20: 5180~5240 MHz, 5745~5825 MHz 802.11n-HT40: 5190~5230 MHz, 5755~5795 MHz 802.11ac-VHT80: 5210 MHz, 5775 MHz
Channel Number	<u>For 2.4GHz Wi-Fi</u> 802.11b/g/n-HT20: 11 802.11n-HT40: 7 <u>For 5GHz Wi-Fi</u> 802.11a/n-HT20: 9 802.11n-HT40: 4 802.11ac-VHT80: 2
Type of Modulation	802.11b: DSSS 802.11a/g/n/ac: OFDM
Data Rate	802.11b: 1/2/5.5/11Mbps 802.11a/g: 6/9/12/18/24/36/48/54Mbps 802.11n: up to 300Mbps 802.11ac: up to 866.7 Mbps
Bluetooth Specification	
Frequency Range	2402MHz~ 2480MHz
Channel Number	For Bluetooth: 79 For BT-LE: 40
Channel Spacing	For Bluetooth: 1MHz For BT-LE: 2MHz
Type of Modulation	For Bluetooth: 1Mbps (GFSK), 2Mbps (Pi/4 DQPSK), 3Mbps (8DPSK) For BT-LE: 1Mbps & 2Mbps (GFSK)

1.6. Antennas Details

Operating Condition	AUX ANT	802.11b/g/n for 2.4GHz Wi-Fi (1Tx, 1Rx) 802.11a/n/ac for 5GHz Wi-Fi (1Tx, 1Rx) Bluetooth BR/EDR (1Tx, 1Rx)
	Main ANT	802.11b/g/n for 2.4GHz Wi-Fi (1Tx, 1Rx) 802.11a/n/ac for 5GHz Wi-Fi (1Tx, 1Rx)
	AUX ANT + Main ANT	802.11n for 2.4GHz Wi-Fi (2Tx, 2Rx) 802.11n/ac for 5GHz Wi-Fi (2Tx, 2Rx)
Antenna Type	PIFA Antenna	
Simultaneously Transmitting Scenarios	Wi-Fi transmit simultaneously Bluetooth (AUX ANT) transmit simultaneously with Wi-Fi (Main ANT)	

2. Summary of Test Result

2.1. Test Standards

No.	Identity	Document Title
1	47 CFR Part 2.1093	Radiofrequency radiation exposure evaluation: portable devices
2	IEEE 1528-2013	IEEE Recommended Practice for Determining the Peak Spatial-Average Specific Absorption Rate (SAR) in the Human Head from Wireless Communications Devices: Measurement Techniques
3	IEEE C95.1-2005	IEEE Standard for Safety Levels with Respect to Human Exposure to Radio Frequency Electromagnetic Fields, 3 kHz to 300 GHz
4	KDB 447498 D04 v01	Interim General RF Exposure Guidance
5	KDB 865664 D01 v01r04	SAR Measurement 100 MHz to 6 GHz
6	KDB 865664 D02 v01r02	RF Exposure Reporting
7	KDB 616217 D04 v01r02	SAR for laptop and tablet
8	KDB 248227 D01 v02r02	SAR Guidance for IEEE 802.11 (Wi-Fi) Transmitter

2.2. Environment Condition

Ambient Temperature	20.5~24.0°C
Temperature of Simulant	20.0~23.5°C
Relative Humidity	38 ~55%RH

2.3. RF Exposure Limits

Human Exposure	Basic restrictions for electric, magnetic and electromagnetic fields. (Unit in mW/g or W/kg)
Spatial Peak SAR ¹ (Head and Body)	1.60
Spatial Average SAR ² (Whole Body)	0.08
Spatial Peak SAR ³ (Arms and Legs)	4.00

Notes:

1. The Spatial Peak value of the SAR averaged over any 1gram of tissue (defined as a tissue volume in the shape of a cube) and over the appropriate averaging time.
2. The Spatial Average value of the SAR averaged over the whole body.
3. The Spatial Peak value of the SAR averaged over any 1 gram of tissue (defined as a tissue volume in the shape of a cube) and over appropriate averaging time.

2.4. Test Result Summary

Worst SAR List

Antenna	Highest Reported SAR	Body 1g SAR (W/kg)
AUX	DTS Band Wi-Fi	1.15
	U-NII-1 Band Wi-Fi	1.12
	U-NII-3 Band Wi-Fi	1.16
	Bluetooth	0.43
Main	DTS Band Wi-Fi	1.00
	U-NII-1 Band Wi-Fi	0.78
	U-NII-3 Band Wi-Fi	0.82

Highest Simultaneous SAR

Highest Simultaneous SAR	Body 1g SAR (W/kg)
DTS Band Wi-Fi MIMO	1.11
U-NII-1 Band Wi-Fi MIMO	1.05
U-NII-3 Band Wi-Fi MIMO	1.15
Bluetooth + Wi-Fi	1.43

3. Specific Absorption Rate (SAR)

3.1. Introduction

SAR is related to the rate at which energy is absorbed per unit mass in an object exposed to a radio field. The SAR distribution in a biological body is complicated and is usually carried out by experimental techniques or numerical modeling. The standard recommends limits for two tiers of groups, occupational /controlled and general population/uncontrolled, based on a person's awareness and ability to exercise control over his or her exposure. In general, occupational/controlled exposure limits are higher than the limits for general population/uncontrolled.

3.2. Definition

The SAR in the tissue-equivalent liquid can be determined by the rate of temperature increase or by E-field measurements, according to Formulas (1) or (2):

$$SAR = \frac{\sigma E^2}{\rho} \quad (1)$$

$$SAR = c_h \left. \frac{dT}{dt} \right|_{t=0} \quad (2)$$

where

SAR is the specific absorption rate in W/kg;

E is the rms value of the electric field strength in the tissue medium in V/m;

σ is the electrical conductivity of the tissue medium in S/m;

ρ is the mass density of the tissue medium in kg/m³;

c_h is the specific heat capacity of the tissue medium in J/(kg K);

$\left. \frac{dT}{dt} \right|_{t=0}$ is the initial time derivative of temperature in the tissue medium in K/s.

4. DASY6 Measurement System

4.1. Introduction

DASY6 is the latest generation of the Dosimetric Assessment System optimized for specific absorption rate (SAR) measurements, SAR compliance. DASY6 builds on the power of our industry - leading dosimetric and near-field evaluation system, DASY52. Running on a significantly more robust platform and a more powerful measurement server, DASY6 offers much faster scanning with no sacrifice of measurement precision. All hardware and software are fully compatible with DASY52. The new system seamlessly integrates two software solutions, the novel cDASY V6.6 - optimized for SAR compliance testing to significantly reduce SAR assessment costs - and the widely used DASY V5.2 for generalized near-field evaluations with maximized flexibility.

4.2. DASY6 Measurement System Diagram

The DASY6 system in cDASY6/DASY5 V5.2 SAR Configuration is shown below:

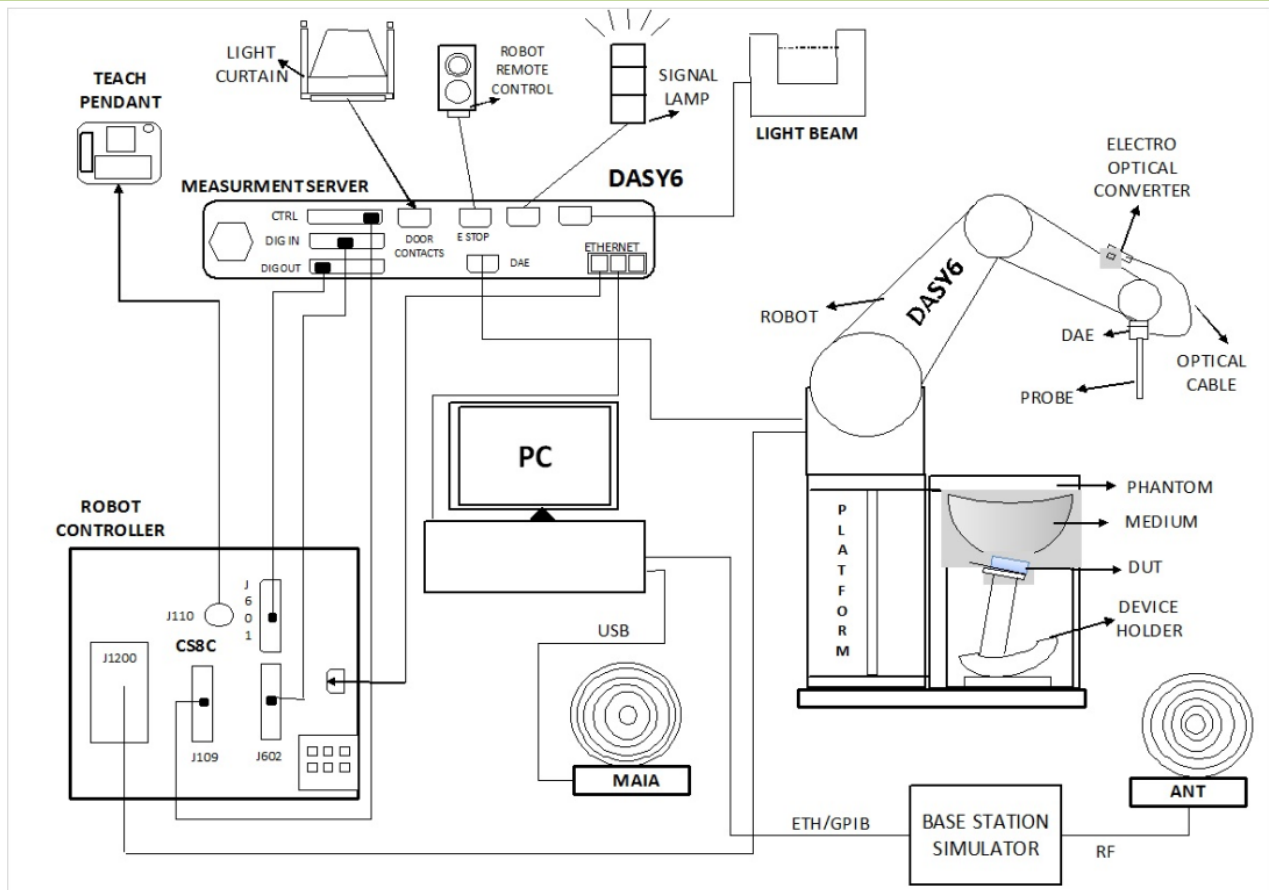

The System consist of the following components:

DASY6 Measurement Server, Data Acquisition Electronics (DAE), Probes, Light-Beam Unit, Phantoms, Media, Device Holder for SAM-Twin Phantom, Laptop Extension Kit to Mounting Device, Robot System Platform & Pedestal, Verification of the Parameters with the Dielectric Assessment Kit (DAK), Modulation and Interference Analyzer (MAIA), Omni-Directional Ultra-Wideband Antenna (ANT), cDASY6 software, DASY5 NEO software and SEMCAD data evaluation software.

4.3. System Components Details

DASY6 Platforms MP6E-TX60L

MP6E-TX60L platform is a compact cost-effective platform based on TX60L. It consists of:

- a stable non-metallic platform for the TX60L robot
- a frame for two standard-size phantoms (1.0 × 0.5 m)
- a frame for one half-size phantom (0.5 × 0.5 m)

It includes two easily moveable trolleys for the phone and tablet/computer positioner and two platforms for positioning dipoles and other antennas.

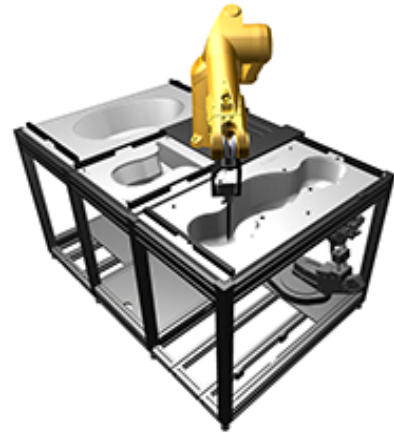

Material The beams consist of a composite of wood and epoxy (permittivity of 3.3 and loss tangent of <0.07)

Size The footprint of the platform is 1590 mm × 1060 mm.

Robots -TX60L

The MRT DASY6 system uses the high-precision industrial robots TX60L from Staubli SA (France). The TX robot family - the successor of the well-known RX robot family - continues to offer the features important for DASY6 applications:

- High precision (repeatability 0.02mm)
- High reliability (industrial design)
- Low maintenance costs (virtually maintenance-free as all gears are direct drive, no belt drives)
- Jerk-free straight movements (brushless synchron motors, no stepper motors)
- Low extremely low frequency (ELF) interference (motor control fields are shielded by the closed metallic construction)



The robots are controlled by the Staubli CS8c robot controllers. All information regarding the use and maintenance of the robot arm and the robot controller is provided on CDs delivered with the robot. Paper manuals are available directly from Staubli upon request.



DASY6 Measurement Server

The DASY6 measurement server is based on a PC/104 CPU board with a 400MHz intel ULV Celeron, 128MB chip-disk and 128MB RAM. The necessary circuits for communication with the DAE4 electronics box, as well as the 16-bit AD converter system for optical detection and digital I/O interface are contained on the DASY6 I/O board, which is directly connected to the PC/104 bus of the CPU board.

The measurement server performs all real-time data evaluations of field measurements and surface detection, controls robot movements, and handles safety operations.



Data Acquisition Electronics (DAE)

The data acquisition electronics (DAE4) consist of a highly sensitive electrometer-grade preamplifier with auto-zeroing, a channel and gain-switching multiplexer, a fast 16-bit AD-converter, and a command decoder with a control logic unit. Transmission to the measurement server is accomplished through an optical downlink for data and status information, as well as an optical uplink for commands and the clock.

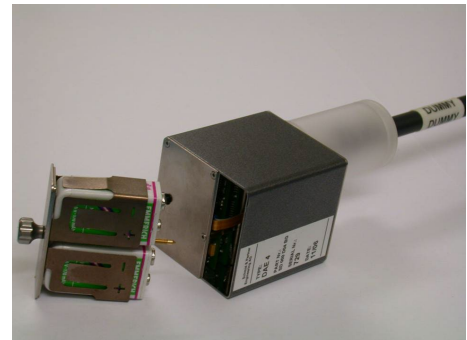

Probes

E-Field Probe(EX3DV4)

The SAR measurement is conducted with the dosimetric probe manufactured by SPEAG. The probe is specially designed and calibrated for use in liquid with high permittivity. The dosimetric probe has special calibration in liquid at different frequency. SPEAG conducts the probe calibration in compliance with international and national standards (e.g. IEEE 1528, EN 62209-1, IEC 62209, etc.) under ISO 17025.

Construction:

Symmetric design with triangular core Built-in shielding against static charges PEEK enclosure material (resistant to organic solvents, e.g., DGBE)

Frequency: 4 MHz ~ 10 GHz

Linearity: ± 0.2 dB (30 MHz ~ 10 GHz)

Directivity:

± 0.1 dB in TSL (rotation around probe axis)

± 0.3 dB in TSL (rotation normal to probe axis)

Dynamic Range: 10 μ W/g to 100 mW/g; Linearity: ± 0.2 dB (noise: typically < 1 μ W/g)

Dimensions:

Overall length: 337 mm (Tip: 20 mm)

Tip diameter: 2.5 mm (Body: 12 mm)

Typical distance from probe tip to dipole centers: 1 mm

Applications:

High precision dosimetric measurements in any exposure scenario (e.g., very strong gradient fields); the only probe that enables compliance testing for frequencies up to 6 GHz with precision of better than 30%.

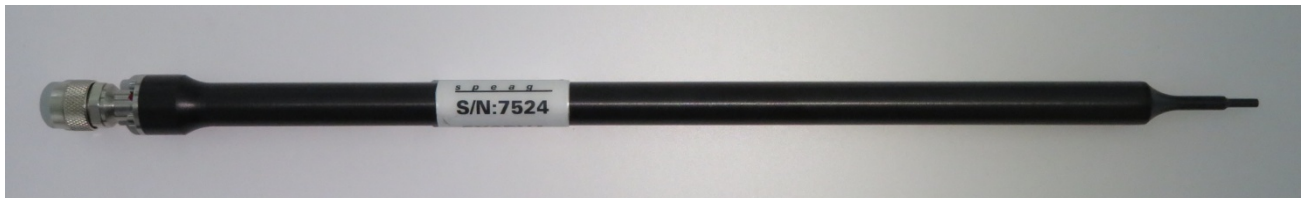

MSTV1 (Mother Scan Teaching V1) Electronics & TP6V2 (Teaching Probe 6V2) Probe

MSTV1 (Mother Scan Teaching V1) electronics together with the TP6V2 (Teaching Probe 6V2) probe is used for mother scan of DASY6 system. This probe uses a 3D Renishaw LP2 sensor which ensures accurate detection of any shape and a measurement repeatability of 8 μ m.



Light-Beam Unit

The light beam switch allows automatic "tooling" of the probe. During the process, the actual position of the probe tip with respect to the robot arm, as well as the probe length and the horizontal probe offset, are measured. The software then corrects all movements within the measurement jobs, such that the robot coordinates are valid for the probe tip.



The repeatability of this process is better than 0.1 mm. If a position has been taught with an aligned probe, the same position will be reached with another aligned probe within 0.1 mm, even if the other probe has different dimensions. During probe rotations, the probe tip will keep its actual position.

Phantoms

SAM-Twin Phantom

The shell corresponds to the specifications of the Specific Anthropomorphic Mannequin (SAM) phantom defined in IEEE 1528 and IEC 62209-1. It enables the dosimetric evaluation of left and right hand phone usage as well as body-mounted usage at the flat phantom region. A cover prevents evaporation of the liquid. Reference markings on the phantom allow the complete setup of all predefined phantom positions and measurement grids by teaching three points with the robot.

SAM-Twin V5.0 and higher has the same shell geometry and is manufactured from the same material as SAM-Twin V4.0, but with the top structure reinforced.

Material	Vinyl ester, fiberglass reinforced (VE-GF)
Liquid Compatibility	The phantom shell is compatible with SPEAG tissue simulating liquids (sugar and oil based). Use of other liquids may render the phantom warranty void (see note or consult SPEAG support).
Shell Thickness	2 ± 0.2 mm (6 ± 0.2 mm at ear point)
Dimensions (incl. Wooden Support)	Length: 1000 mm Width: 500 mm Height: adjustable feet
Filling Volume	approx. 25 liters
Support	DASY6: standard-size platform slot DASY52 stand-alone: SPEAG standard phantom table

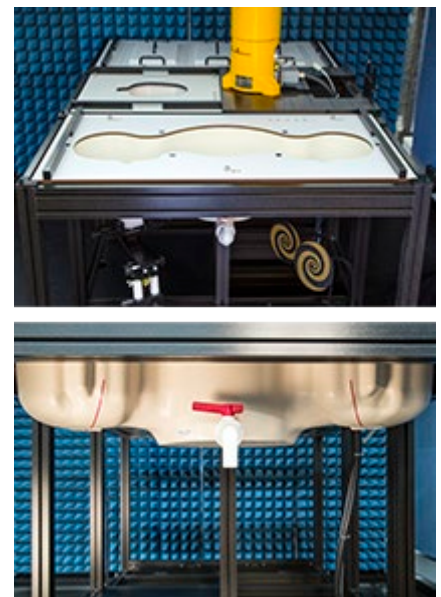

ELI phantom

The ELI phantom is used for compliance testing of handheld and body-mounted wireless devices in the frequency range of 30 MHz to 6 GHz. ELI is fully compatible with the IEC 62209-2 standard and all known tissue simulating liquids. ELI has been optimized regarding its performance and can be integrated into our standard phantom tables. A cover prevents evaporation of the liquid. Reference markings on the phantom allow installation of the complete setup, including all predefined phantom positions and measurement grids, by teaching three points. The phantom is compatible with all SPEAG dosimetric probes and dipoles.

ELI V5.0 and higher has the same shell geometry and is manufactured from the same material as ELI V4.0, but has reinforced top structure. ELI V6.0, released in August 2014, has the same shell geometry as ELI V4.0 but offers increased longterm stability.

Material	Vinyl ester, fiberglass reinforced (VE-GF)
Liquid Compatibility	The phantom shell is compatible with SPEAG tissue simulating liquids (sugar and oil based). Use of other liquids may render the phantom warranty void (see note or consult SPEAG support).
Shell Thickness	2.0 ± 0.2 mm (bottom plate)
Dimensions	Major axis: 600 mm Minor axis: 400 mm
Filling Volume	approx. 30 liters
Support	DASY6: standard-size platform slot DASY52 stand-alone: SPEAG standard phantom table

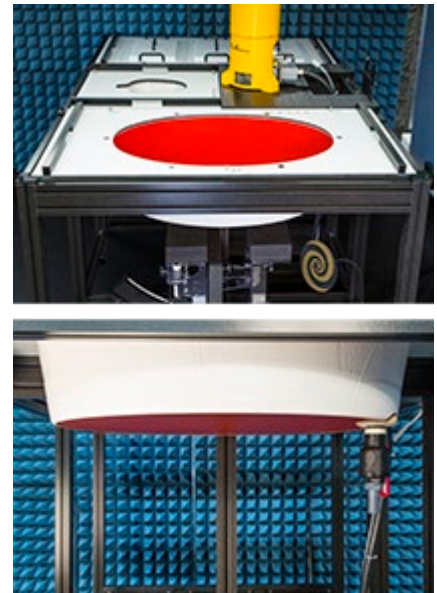

SAM Face Down Phantom

The SAM Face Down Phantom V10 allows assessment of the exposure of the face and in particular the eyes for handheld devices operated in front of the face. e.g., video phones, cameras, organizers, etc. It is manufactured from high precision injection molded polypropylene. The Mounting Device for Transmitters including extensions kit can be used to position the device.

Material	Epoxy based
Liquid Compatibility	The phantom shell is compatible with SPEAG tissue simulating liquids (sugar and oil based). Use of other liquids may render the phantom warranty void (see note or consult SPEAG support).
Shell Thickness	2 ± 0.2 mm (6 mm at ear point)
Head Shape	Standard compatible SAM head.

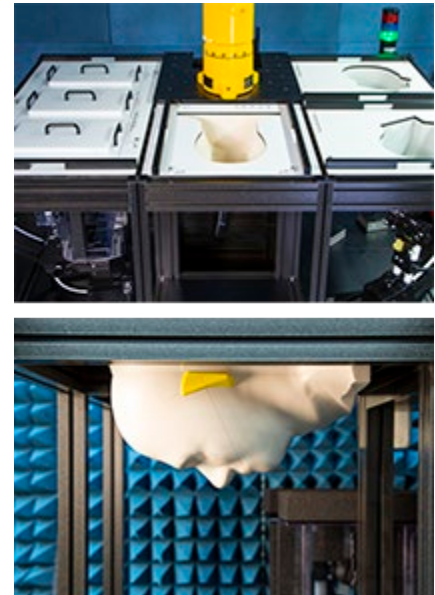

SAM Head Stand Phantom

The SAM Head Stand Phantom V10 allows assessment of the exposure of the top-head or around-the-head wireless accessories, e.g., head-belts, etc. It is manufactured from high precision injection molded polypropylene. The Mounting Device for Transmitters including extensions kit can be used to position the device.

Material	Epoxy based
Liquid Compatibility	The phantom shell is compatible with SPEAG tissue simulating liquids (sugar and oil based). Use of other liquids may render the phantom warranty void (see note or consult SPEAG support).
Shell Thickness	2 ± 0.2 mm (6 mm at ear point)
Head Shape	Standard compatible SAM head.



Wrist Phantom

The Wrist Phantom V10 is shape-compatible with the CTIA approved OTA GFPC-V1 and optimized for SAR evaluation of watches and other wireless hand accessories.

Material	Epoxy based
Liquid Compatibility	The phantom shell is compatible with SPEAG tissue simulating liquids (sugar and oil based). Use of other liquids may render the phantom warranty void (see note or consult SPEAG support).
Shell Thickness	Shell Thickness
Wrist Shape	Design compatible with CTIA forearm.



Device Holder for SAM-Twin Phantom

The SAR in the phantom is approximately inversely proportional to the square of the distance between the source and the liquid surface. For a source at 5mm distance, a positioning uncertainty of $\pm 0.5\text{mm}$ would produce uncertainty in the SAR of $\pm 20\%$. Accurate device positioning is therefore crucial for accurate and repeatable measurements. The positions at which the devices must be measured are defined by the standards.

MD4HHTV5 - Mounting Device for Hand-Held Transmitters

In combination with the Twin SAM V5.0/V5.0c or ELI phantoms, the Mounting Device for Hand-Held Transmitters enables rotation of the mounted transmitter device to specified spherical coordinates. At the heads, the rotation axis is at the ear opening. Transmitter devices can be easily and accurately positioned according to IEC 62209-1, IEEE 1528, FCC, or other specifications. The device holder can be locked for positioning at different phantom sections (left head, right head, flat).

Material: Polyoxymethylene (POM)



MDA4WTV5 - Mounting Device Adaptor for Ultra Wide Transmitters

An upgrade kit to Mounting Device to enable easy mounting of wider devices like big smart-phones, e-books, small tablets, etc. It holds devices with width up to 140 mm.

Material: Polyoxymethylene (POM)



MDA4SPV6 - Mounting Device Adaptor for Smart Phones

The solid low-density MDA4SPV6 adaptor assuring no impact on the DUT radiation performance and is conform with any DUT design and shape.

Material: ROHACELL



MD4LAPV5 - Mounting Device for Laptops and other Body-Worn Transmitters

In combination with the Twin SAM V5.0/V5.0c or ELI phantoms, the Mounting Device (Body-Worn) enables testing of transmitter devices according to IEC 62209-2 specifications. The device holder can be locked for positioning at a flat phantom section.

Material: Polyoxymethylene (POM), PET-G, Foam



MDA4LAP - Mounting Device Adaptor for Laptops

A simple but effective and easy-to-use extension for the Mounting Device; facilitates testing of larger devices (e.g., laptops, cameras, etc.) according to IEC 62209-2; lightweight and fits easily on the upper part of the Mounting Device in place of the phone positioner. The extension is fully compatible with the Twin SAM as well as ELI and other Flat Phantoms.

Material: Polyoxymethylene (POM), PET-G, Foam

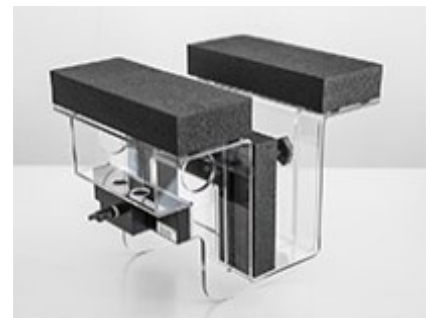

Modulation and Interference Analyzer(MAIA)

MAIA is a hardware interface used to evaluate the modulation and audio interference characteristics of RF signals in the frequency range 698 - 6000 MHz. DASY6 evaluates the time-domain and frequency domain properties of the uplink signal transmitted by the DUT during SAR measurement with MAIA. MAIA uses USB powered active electronics to identify the modulation of the DUT. It can be operated over the air interface using the built-in ultra-broadband planar log spiral antenna (698 - 6000 MHz) or in conducted mode using the coaxial SMA 50 Ohm connector (300 - 6000 MHz).



To prevent damage in conducted mode due to high peak power, an external RF attenuator may be mounted. The LED on the MAIA hardware also indicates whether it is connected.

DAK-3.5 (200MHz – 20GHz)

This precision dielectric measurement system is designed to cover the 200MHz – 20GHz frequency range with a single open-ended coaxial dielectric probe. The system uses advanced algorithms and novel hardware to measure the dielectric properties of liquids, solids, and semi-solids over a broad range of parameters. The measurement method is fast and non-destructive to the material under test.



Evaluation of reference liquids over a broad frequency range for specific absorption rate (SAR) measurements, in accordance with IEC 62209, IEEE 1528, and several federal regulations.

Evaluating Software: DAK software version 2.0

MRT simulating liquid

Product	Test Frequency (MHz)	Main Ingredients
HSL450	400 – 500	Water, Sucrose, NaCl
MSL450	400 – 500	Water, Sucrose, NaCl

Speag Broad-Band simulating liquid

Product	Test Frequency (MHz)	Main Ingredients
HBBL600-10000V6	600 – 10000	Water, Oil
MBBL600-6000V6	600 – 6000	Water, Oil

5. The SAR Measurement Procedure

5.1. Measurement Process Diagram

General Procedure

For IEEE1528-2013 Head SAR

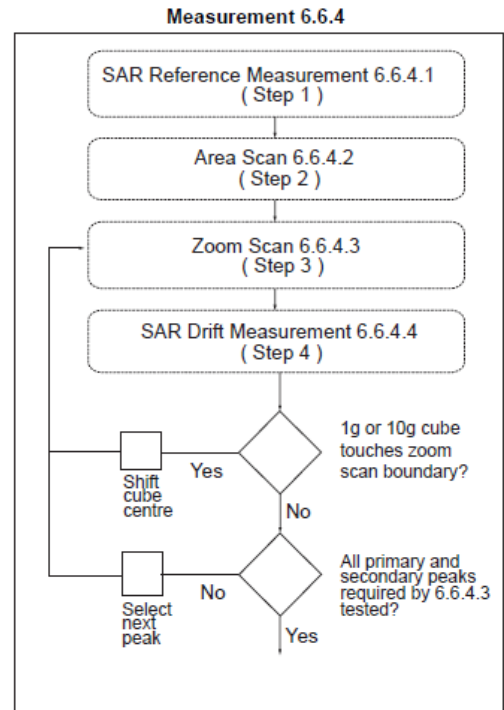
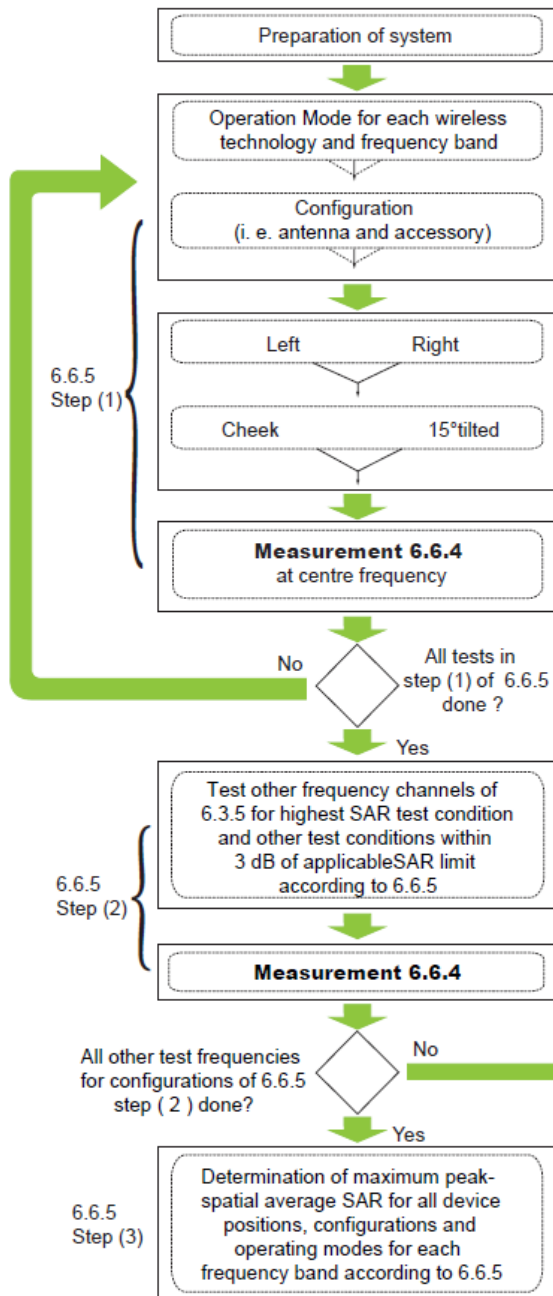

For Body SAR

SAR scan procedures described in section 2.7 of KDB 865664 D01 v01r04 should be applied to body SAR test.

5.2. Test Position Definition

- Head SAR Test Position

Define two imaginary lines on the handset—the vertical centerline and the horizontal line. The vertical centerline passes through two points on the front side of the handset—the midpoint of the width w_t of the handset at the level of the acoustic output [point A in Fixed case and Clamshell case], and the midpoint of the width w_b at the bottom of the handset (point B). The horizontal line is perpendicular to the vertical centerline and passes through the center of the acoustic output [see Fixed case]. The horizontal line is also tangential to the face of the handset at point A. The two lines intersect at point A. Note that for many handsets, point A coincides with the center of the acoustic output; however, the acoustic output may be located elsewhere on the horizontal line. Also note that the vertical centerline is not necessarily parallel to the front face of the handset [see Clamshell case], especially for clamshell handsets, handsets with flip covers, and other irregularly-shaped handsets, the vertical centerline passes through point A but not the tip edge of the phone.

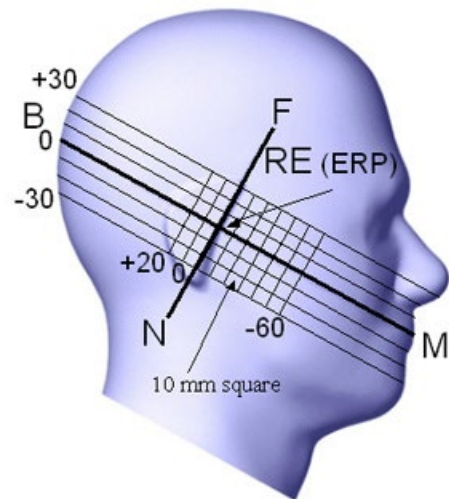
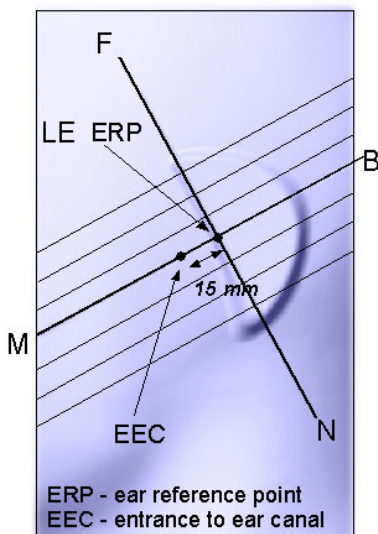
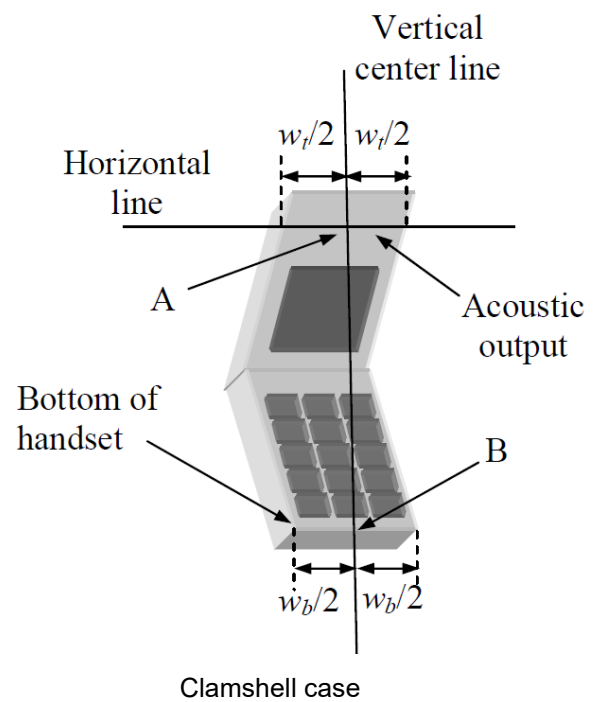
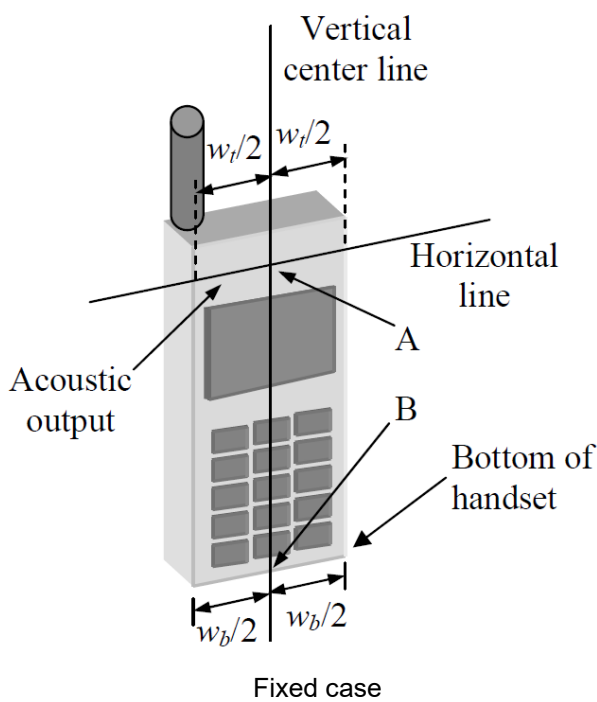

Key

Key

B	Direction of B-M line back endpoint	B	Line B-M back endpoint
F	Direction of N-F line front endpoint	M	Line B-M front endpoint
N	Direction of N-F line neck endpoint	N	Line N-F neck endpoint
M	Mouth reference point	F	Line N-F front endpoint
LE	Left ear reference point (ERP)	RE	Right ear reference point (ERP)

Cheek Position

The cheek position has the following characteristics, based on the geometrical lines described above:

- The N-F line (see above) is in the plane defined by the handset vertical centerline and horizontal line
- Handset touches the pinna
- The handset vertical centerline is aligned with the Reference Plane.

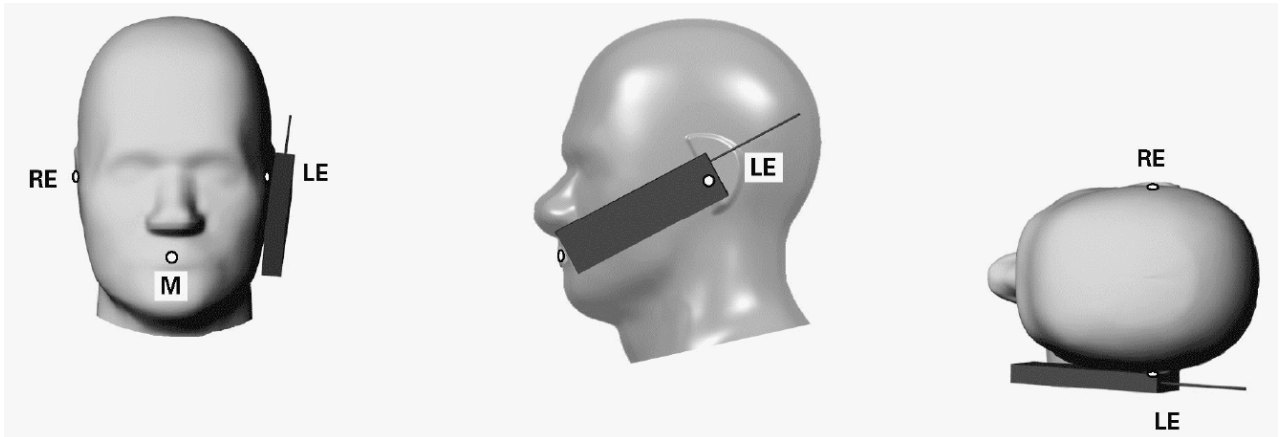

Key

M	Mouth reference point
LE	Left ear reference point
RE	Right ear reference point

Tilt Position

The tilt position is established as follows:

-Repeat the steps to place the device in the cheek position.

-While maintaining the orientation of the handset, move the handset away from the pinna along the line passing through RE and LE far enough to allow a rotation of the handset away from the cheek by 15°.

-Rotate the handset around the horizontal line by 15°.

-While maintaining the orientation of the handset, move the handset towards the phantom on the line passing through RE and LE until any part of the handset touches the ear. The tilt position is obtained when the contact point is on the pinna. If contact occurs at any location other than the pinna, e.g., the antenna at the back of the phantom head, the angle of the handset shall be reduced. In this case, the tilt position is obtained if any point on the handset is in contact with the pinna and a second point on the handset is in contact with the phantom, e.g., the antenna with the back of the head.

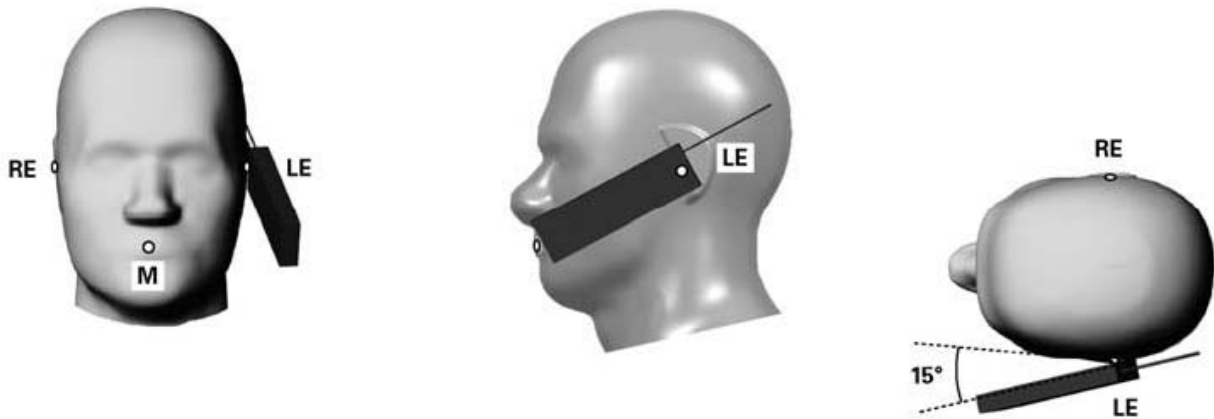

Key

M	Mouth reference point
LE	Left ear reference point
RE	Right ear reference point

■ Body SAR Test Position

For body-worn accessory, hotspot mode and other exposure conditions to human body should be conducted pursuant to the test position requirements of SAR KDBs for certain product.

5.3. Test Procedure

Step 1 Setup a Connection

First, engineer should record the conducted power before the test. Then establish a call in handset at the maximum power level with a base station simulator via air interface, or make the EUT establish transmission by itself in testing band. Place the EUT to certain test position.

Step 2 Power Reference Measurements

To measure the local E-field value at a fixed location which value will be taken as a reference value for calculating a possible power drift.

Step 3 Area Scan

The Area Scan is used as a fast scan in two dimensions to find the area of high field values, before doing a fine measurement around the hot spot. The sophisticated interpolation routines implemented in DASY software can find the maximum locations even in relatively coarse grids. When an Area Scan has measured all reachable points, it computes the field maximal found in the scanned area, within a range of the global maximum. The range (in dB) is specified in the standards for compliance testing. For example, a 2 dB range is required in IEEE Standard 1528 and IEC 62209 standards, whereby 3 dB is a requirement when compliance is assessed in accordance with the ARIB standard (Japan). If only one Zoom Scan follows the Area Scan, then only the absolute maximum will be taken as reference. For cases where multiple maximums are detected, the number of Zoom Scans has to be increased accordingly.

Area Scan Parameters extracted from KDB 865664 D01v01r04

	≤ 3 GHz	> 3 GHz
Maximum distance from closest measurement point (geometric center of probe sensors) to phantom surface	5 mm ± 1 mm	$\frac{1}{2} \cdot \delta \cdot \ln(2)$ mm ± 0.5 mm
Maximum probe angle from probe axis to phantom surface normal at the measurement location	30° ± 1°	20° ± 1°
Maximum area scan spatial resolution: ΔX_{Area} , ΔY_{Area}	≤ 2 GHz: ≤ 15 mm 2 - 3 GHz: ≤ 12 mm	3 - 4 GHz: ≤ 12 mm 4 - 6 GHz: ≤ 10 mm
	When the x or y dimension of the test device, in the measurement plane orientation, is smaller than the above, the measurement resolution must be ≤ the corresponding x or y dimension of the test device with at least one measurement point on the test device.	
Note: δ is the penetration depth of a plane-wave at normal incidence to the tissue medium; see IEEE Std 1528-2013 for details.		

Step 4 Zoom Scan

Zoom Scans are used to assess the peak spatial SAR values within a cubic averaging volume containing 1 g and 10 g of simulated tissue. The Zoom Scan measures points (refer to table below) within a cube whose base faces are centered on the maxima found in a preceding area scan job within the same procedure. When the measurement is done, the Zoom Scan evaluates the averaged SAR for 1 g and 10 g and displays these values next to the job's label.

Zoom Scan Parameters extracted from KDB 865664 D01 v01r04

			≤ 3 GHz	> 3 GHz
Maximum zoom scan spatial resolution: $\Delta x_{\text{Zoom}}, \Delta y_{\text{Zoom}}$			≤ 2 GHz: ≤ 8 mm $2 - 3$ GHz: ≤ 5 mm*	$3 - 4$ GHz: ≤ 5 mm* $4 - 6$ GHz: ≤ 4 mm*
Maximum zoom scan spatial resolution, normal to phantom surface	uniform grid: $\Delta z_{\text{Zoom}}(n)$		≤ 5 mm	$3 - 4$ GHz: ≤ 4 mm $4 - 5$ GHz: ≤ 3 mm $5 - 6$ GHz: ≤ 2 mm
	graded grid	$\Delta z_{\text{Zoom}}(1)$: between 1 st two points closest to phantom surface	≤ 4 mm	$3 - 4$ GHz: ≤ 3 mm $4 - 5$ GHz: ≤ 2.5 mm $5 - 6$ GHz: ≤ 2 mm
		$\Delta z_{\text{Zoom}}(n>1)$: between subsequent points	$\leq 1.5 \cdot \Delta z_{\text{Zoom}}(n-1)$ mm	
Minimum zoom scan volume	x, y, z		≥ 30 mm	$3-4$ GHz: ≥ 28 mm $4-5$ GHz: ≥ 25 mm $5-6$ GHz: ≥ 22 mm
Note: * When zoom scan is required and the reported SAR from the area scan based 1-g SAR estimation procedures of KDB Publication 447498 is ≤ 1.4 W/kg, ≤ 8 mm, ≤ 7 mm and ≤ 5 mm zoom scan resolution may be applied, respectively, for 2 GHz to 3 GHz, 3 GHz to 4 GHz and 4 GHz to 6 GHz.				

Step 5 Power Drift Measurements

Repetition of the E-field measurement at the fixed location mentioned in Step 1 to make sure the two results differ by less than ± 0.2 dB.

Step 6 Test Data

After the test, SAR test data should be exported by SEMCAD.

6. System Verificaiton

6.1. Tissue Check

- Refer to KDB 865664 D01 v01r04, the depth of tissue-equivalent liquid in a phantom must be ≥ 15.0 cm with $\leq \pm 0.5$ cm variation for SAR measurements ≤ 3 GHz and ≥ 10.0 cm with $\leq \pm 0.5$ cm variation for measurements > 3 GHz.

15cm Depth Head Tissue for ELI Phantom

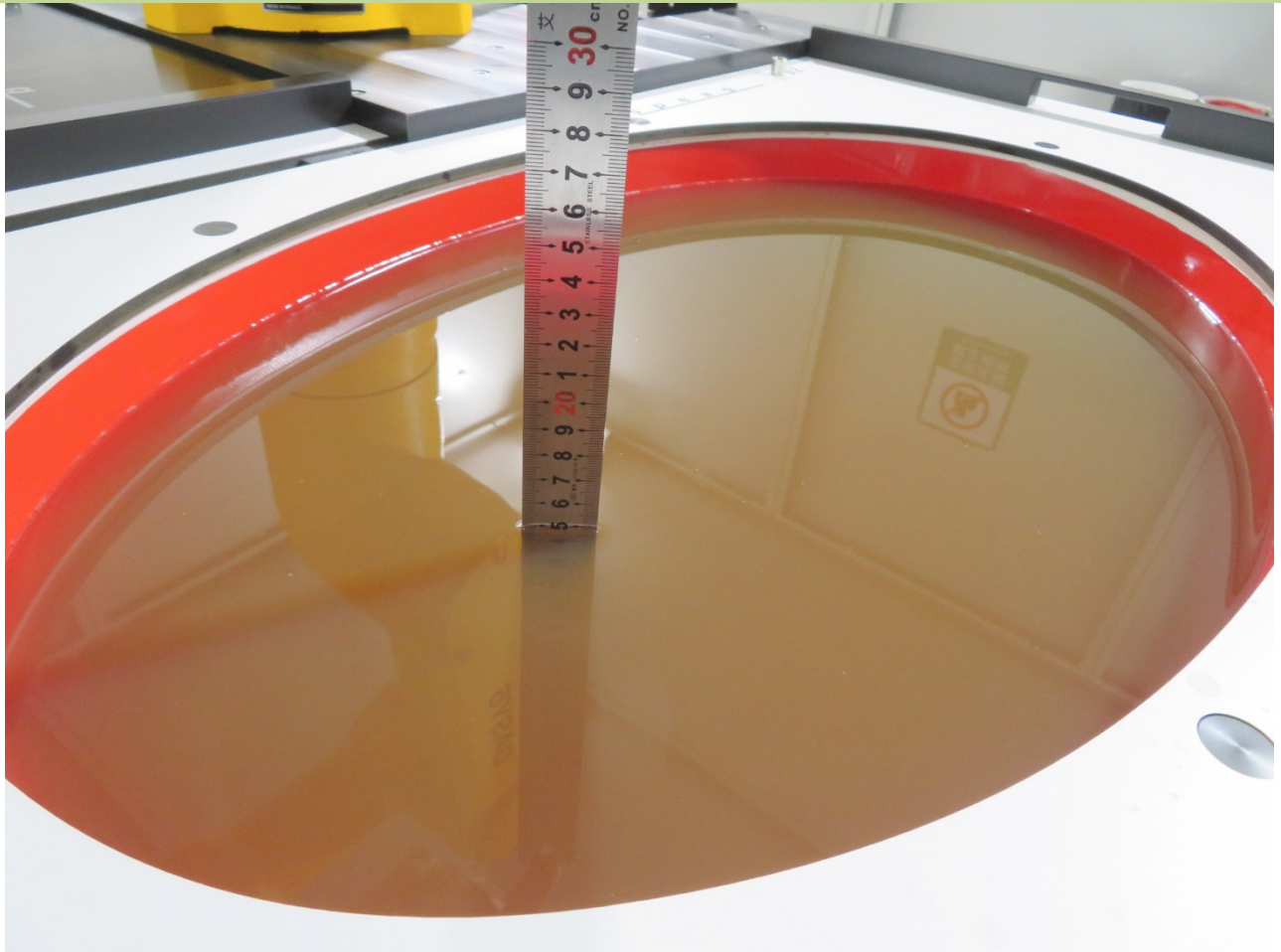

■ Dielectric properties of the head tissue-equivalent liquid

Frequency MHz	Relative Permittivity ϵ_r	Conductivity (σ) S/m
300	45.3	0.87
450	43.5	0.87
750	41.9	0.89
835	41.5	0.90
900	41.5	0.97
<i>1 450</i>	<i>40.5</i>	<i>1.20</i>
<i>1 500</i>	<i>40.4</i>	<i>1.23</i>
<i>1 640</i>	<i>40.2</i>	<i>1.31</i>
<i>1 750</i>	<i>40.1</i>	<i>1.37</i>
1 800	40.0	1.40
1 900	40.0	1.40
2 000	40.0	1.40
<i>2 100</i>	<i>39.8</i>	<i>1.49</i>
<i>2 300</i>	<i>39.5</i>	<i>1.67</i>
2 450	39.2	1.80
<i>2 600</i>	<i>39.0</i>	<i>1.96</i>
3 000	38.5	2.40
<i>3 500</i>	<i>37.9</i>	<i>2.91</i>
<i>4 000</i>	<i>37.4</i>	<i>3.43</i>
<i>4 500</i>	<i>36.8</i>	<i>3.94</i>
<i>5 000</i>	<i>36.2</i>	<i>4.45</i>
<i>5 200</i>	<i>36.0</i>	<i>4.66</i>
<i>5 400</i>	<i>35.8</i>	<i>4.86</i>
<i>5 600</i>	<i>35.5</i>	<i>5.07</i>
<i>5 800</i>	<i>35.3</i>	<i>5.27</i>
<i>6 000</i>	<i>35.1</i>	<i>5.48</i>

Note: For convenience, permittivity and conductivity values at those frequencies which are not part of the original data provided by Drossos et al. [33] or the extension to 5800MHz are provided (i.e. the values shown in italics). These values were linearly interpolated between the values in this table that are immediately above and below these values, except the values at 6000MHz that were linearly extrapolated from the values at 3000MHz and 5800MHz.

■ Tissue Calibration Result

The dielectric parameters of the liquids were verified prior to the SAR evaluation using DASY6 Dielectric Assessment Kit and keysight PNA-L Network Analyzer N5234B.

Tissue parameter for Head								
Freq. (MHz)	Perm.	Cond.	Target Perm.	Target Cond.	Deviation Perm. %	Deviation Cond. %	Tissue Temperature	Test Date
2450	40.83	1.84	39.20	1.80	4.16	2.22	22.5°C	2022.08.03
5250	35.98	4.61	35.93	4.71	0.14	-2.12	22.5°C	2022.08.04
5750	35.07	5.17	35.36	5.22	-0.82	-0.96	22.5°C	2022.08.05

Note: The $\pm 5\%$ deviation of tissue parameter is recommended.

6.2. System Check

■ Purpose

The purpose of the system check is to verify that the system operates within its specifications at the device test frequencies. System check verifies the measurement repeatability of a SAR system before compliance testing and is not a validation of all system specifications. The latter is not required for testing a device but is mandatory before the system is deployed.

■ System Performance Check Setup Diagram

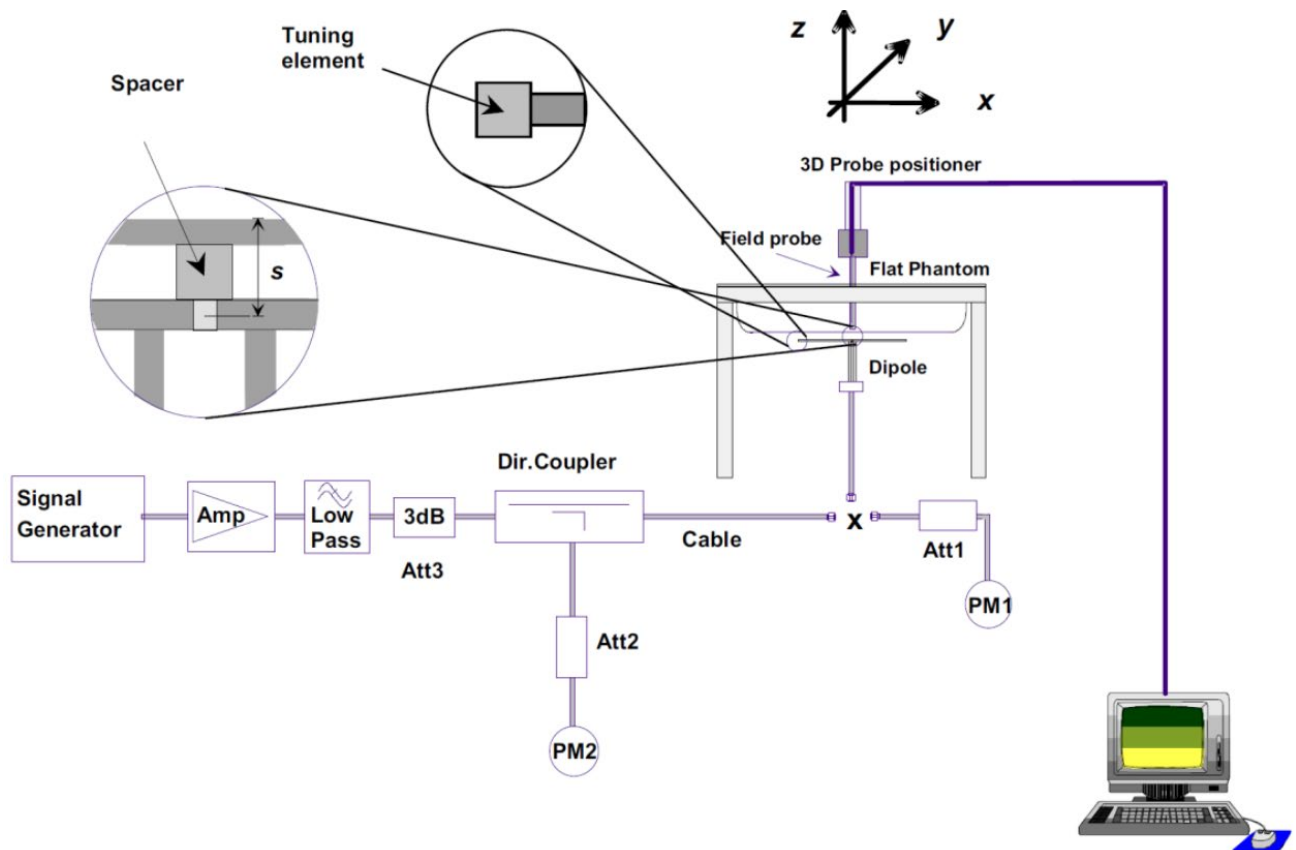

■ System Check Procedure

The system check procedure is a complete 1g and 10g peak spatial-average SAR measurement using a source having a previously determined system check target value. The measured 1g and 10g SAR are normalized to the target input power of the specific source and compared to their respective target values. A description of the different measurement tasks to be performed is given below, together with the information that can be deduced from their results:

- a. The Power Reference Measurement and Power Drift Measurement are located at the beginning and end of the batch process. They measure the field drift at one single point in the liquid over the complete procedure. The indicated drift is mainly the variation of the amplifier output power. If it is too high (above ± 0.1 dB), the system check should be repeated; some amplifiers have very high drift during warm-up. A stable amplifier gives drift results in the DASY6 system below ± 0.02 dB.

b. The second step is optional. For probes with integrated optical surface detection sensor this step must be conducted, otherwise the step can be skipped. The Surface Check tests the optical surface detection system of the DASY6 system by repeatedly detecting the surface with the optical and mechanical surface detector and comparing the results. The output gives the detecting heights of both systems, the difference between the two systems and the standard deviation of the detection repeatability. Air bubbles or refraction in the liquid due to separation of the sugar-water mixture gives poor repeatability (above ± 0.1 mm). In that case it is better to abort the system check and stir the liquid.

c. The Area Scan measures the SAR above the dipole on a plane parallel to the surface. It is used to locate the approximate location of the peak SAR. The proposed scan uses large grid spacing for faster measurement; due to the symmetric field, the peak detection is reliable. If a finer graphic is desired, the grid spacing can be reduced. Grid spacing and orientation have no influence on the SAR result.

d. The Zoom Scan measures the field in a volume around the peak SAR value assessed in the previous Area Scan.

If the system check gives reasonable results, the SAR peak, 1 g and 10 g spatial average SAR values normalized to 1 W dipole input power give reference data for comparisons. The next sections analyze the expected uncertainties of these values, as well as additional checks for further information or troubleshooting.

■ Result of System Performance Check

System checks for Head								
Freq. (MHz)	1g SAR (W/kg)	10g SAR (W/kg)	Target 1g SAR (W/kg)	Target 10g SAR (W/kg)	Deviation 1g SAR (%)	Deviation 10g SAR (%)	Tissue Temp.	Test Date
2450	52.00	24.24	53.40	24.20	-2.62	0.17	22.5°C	2022.08.03
5250	79.90	23.00	76.90	21.80	3.90	5.50	22.5°C	2022.08.04
5750	80.70	23.00	76.90	21.50	4.94	6.98	22.5°C	2022.08.05

Note:

1. The $\pm 10\%$ deviation of system check result is required.
2. System check value listed above has been harmonized to 1W.

7. Analysis and Results

7.1. Antenna Location

Front View (Screen Side)

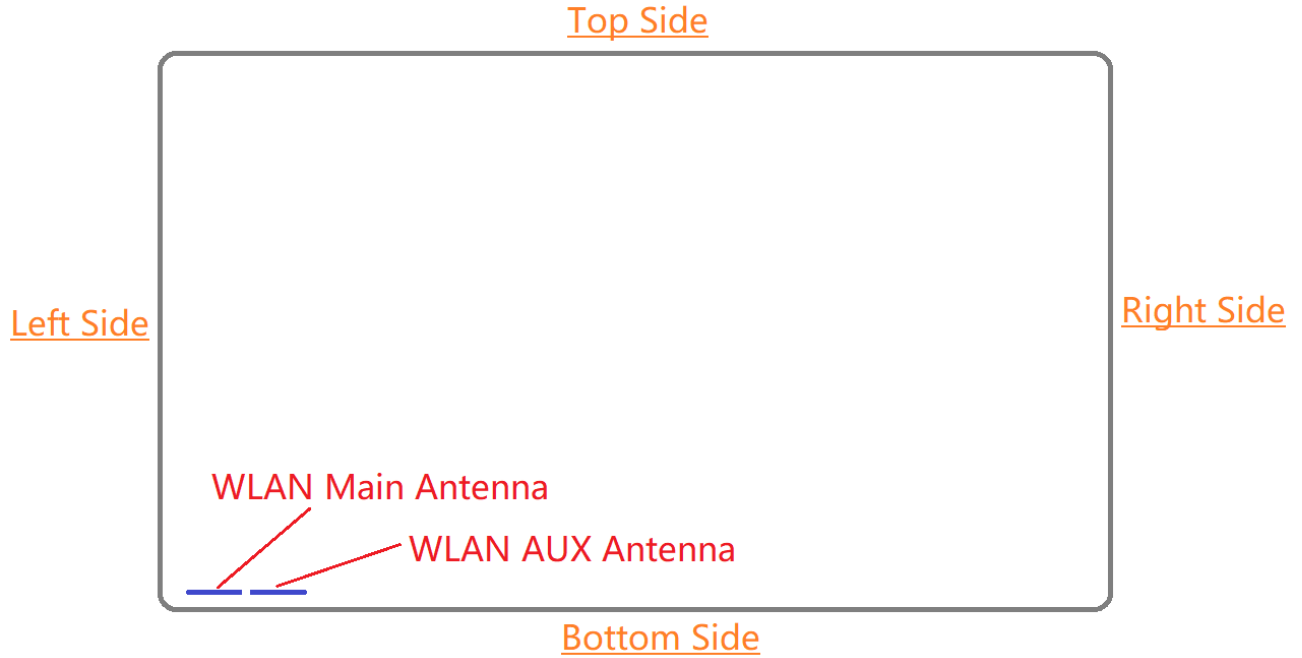

Antenna	Antenna Distance to Screen Side (mm)					
	Front Side	Back Side	Left Side	Right Side	Top Side	Bottom Side
AUX Antenna	< 5	6	56	200	184	6
Main Antenna	< 5	6	25	228	184	6

Note:

1. The overall diagonal dimension of EUT is 320mm.
2. When the minimum test separation distance is < 5 mm, a distance of 5 mm is applied to determine SAR test exclusion.

7.2. Conducted Power

■ DTS Band Wi-Fi - SISO

Mode	CH.	Freq. (MHz)	AUX ANT Average Power (dBm)	AUX ANT Tune-up Power (dBm)	Main ANT Average Power (dBm)	Main ANT Tune-up Power (dBm)	Duty Cycle (%)
b	1	2412	13.87	14.0	13.23	13.4	99.22
	7	2442	13.82	14.0	12.95	13.1	
	11	2462	14.13	14.3	13.33	13.5	
g	1	2412	13.85	14.0	13.19	13.3	99.59
	7	2442	13.79	13.9	12.93	13.1	
	11	2462	14.08	14.2	13.31	13.5	
n-HT20	1	2412	13.83	14.0	13.17	13.3	99.28
	7	2442	13.74	13.9	12.90	13.1	
	11	2462	14.02	14.2	13.25	13.4	
n-HT40	3	2422	13.49	13.6	12.97	13.1	99.28
	7	2442	13.72	13.9	12.88	13.0	
	9	2452	14.00	14.2	13.22	13.4	

■ DTS Band Wi-Fi - MIMO

Mode	CH.	Freq. (MHz)	AUX ANT Average Power (dBm)	Main ANT Average Power (dBm)	Total Average Power (dBm)	Total Tune-up Power (dBm)	Duty Cycle %
n-HT20	1	2412	13.52	12.86	16.21	16.4	99.28
	7	2442	13.48	12.53	16.04	16.2	
	11	2462	13.37	12.47	15.95	16.1	
n-HT40	3	2422	11.37	11.09	14.24	14.4	99.28
	7	2442	13.45	12.46	15.99	16.1	
	9	2452	13.13	12.14	15.67	15.8	

■ U-NII-1 Band Wi-Fi - SISO

Mode	CH.	Freq. (MHz)	AUX ANT Average Power (dBm)	AUX ANT Tune-up Power (dBm)	Main ANT Average Power (dBm)	Main ANT Tune-up Power (dBm)	Duty Cycle %
a	36	5180	10.05	10.2	9.12	9.3	98.09
	40	5200	10.13	10.3	9.21	9.4	
	48	5240	10.29	10.4	9.58	9.7	
n-HT20	36	5180	9.81	10.0	9.08	9.2	98.94
	40	5200	10.10	10.3	9.19	9.3	
	48	5240	9.97	10.1	9.52	9.7	
n-HT40	38	5190	10.16	10.3	9.22	9.4	98.46
	46	5230	10.25	10.4	9.51	9.7	
ac-VHT80	42	5210	9.62	9.8	9.26	9.4	98.84

■ U-NII-1 Band Wi-Fi - MIMO

Mode	CH.	Freq. (MHz)	AUX ANT Average Power (dBm)	Main ANT Average Power (dBm)	Total Average Power (dBm)	Total Tune-up Power (dBm)	Duty Cycle %
n-HT20	36	5180	8.97	8.53	11.77	11.9	98.94
	40	5200	8.98	8.68	11.84	12.0	
	48	5240	9.00	8.74	11.88	12.0	
n-HT40	38	5190	9.02	8.76	11.90	12.1	98.46
	46	5230	9.03	8.82	11.94	12.1	
ac-VHT80	42	5210	9.08	8.86	11.98	12.1	98.84

■ U-NII-3 Band Wi-Fi - SISO

Mode	CH.	Freq. (MHz)	AUX ANT Average Power (dBm)	AUX ANT Tune-up Power (dBm)	Main ANT Average Power (dBm)	Main ANT Tune-up Power (dBm)	Duty Cycle %
a	149	5745	9.80	10.0	9.89	10.0	98.09
	157	5785	9.81	10.0	9.81	10.0	
	165	5825	9.65	9.8	9.85	10.0	
n-HT20	149	5745	9.68	9.8	9.84	10.0	98.94
	157	5785	9.76	9.9	9.70	9.9	
	165	5825	9.62	9.8	9.73	9.9	
n-HT40	151	5755	9.79	9.9	9.87	10.0	98.46
	159	5795	9.78	9.9	9.86	10.0	
ac-VHT80	155	5775	9.73	9.9	9.83	10.0	98.84

■ U-NII-3 Band Wi-Fi - MIMO

Mode	CH.	Freq. (MHz)	AUX ANT Average Power (dBm)	Main ANT Average Power (dBm)	Total Average Power (dBm)	Total Tune-up Power (dBm)	Duty Cycle %
n-HT20	149	5745	8.95	9.04	12.01	12.2	98.94
	157	5785	8.97	9.06	12.03	12.2	
	165	5825	9.03	9.15	12.10	12.3	
n-HT40	151	5755	9.09	9.21	12.16	12.3	98.46
	159	5795	9.10	9.25	12.19	12.3	
ac-VHT80	155	5775	9.14	9.28	12.22	12.4	98.84

■ Bluetooth

Mode	CH.	Freq. (MHz)	AUX ANT Average Power (dBm)	AUX ANT Max. Tune-up Power (dBm)	Duty Cycle %
DH5	0	2402	8.12	8.3	77.07
	39	2441	9.78	9.9	
	78	2480	10.30	10.5	
2DH5	0	2402	8.41	8.6	77.25
	39	2441	8.40	8.6	
	78	2480	8.84	9.0	
3DH5	0	2402	8.15	8.3	77.33
	39	2441	8.39	8.5	
	78	2480	8.83	9.0	
BLE 1M	0	2402	7.82	8.0	85.85
	20	2437	7.83	8.0	
	39	2480	8.25	8.4	
BLE 2M	0	2402	8.31	8.5	57.87
	20	2437	8.46	8.6	
	39	2480	8.74	8.9	

7.3. SAR Exclusion Analysis

Per FCC KDB 447498 D04v01, the SAR exclusion threshold defined by the following equation:

$$P_{th} \text{ (mW)} = \begin{cases} ERP_{20 \text{ cm}}(d/20 \text{ cm})^x & d \leq 20 \text{ cm} \\ ERP_{20 \text{ cm}} & 20 \text{ cm} < d \leq 40 \text{ cm} \end{cases} \quad (\text{B.2})$$

Where

$$x = -\log_{10} \left(\frac{60}{ERP_{20 \text{ cm}} \sqrt{f}} \right)$$

and f is in GHz, d is the separation distance (cm), and $ERP_{20\text{cm}}$ is per Formula (B.1).

$$P_{th} \text{ (mW)} = ERP_{20 \text{ cm}} \text{ (mW)} = \begin{cases} 2040f & 0.3 \text{ GHz} \leq f < 1.5 \text{ GHz} \\ 3060 & 1.5 \text{ GHz} \leq f \leq 6 \text{ GHz} \end{cases} \quad (\text{B.1})$$

Required Configurations of SAR Test							
Antenna	Test Band	Front Side	Back Side	Left Side	Right Side	Top Side	Bottom Side
Main	DTS	N/A	Yes	Yes	Yes *	Yes *	Yes
	U-NII-1	N/A	Yes	Yes	Yes *	Yes *	Yes
	U-NII-2C	N/A	Yes	Yes	Yes *	Yes *	Yes
	Bluetooth	N/A	Yes	Yes	Yes *	Yes *	Yes
AUX	DTS	N/A	Yes	Yes *	Yes *	Yes *	Yes
	U-NII-1	N/A	Yes	Yes *	Yes *	Yes *	Yes
	U-NII-3	N/A	Yes	Yes *	Yes *	Yes *	Yes
MIMO	DTS	N/A	Yes	Yes	Yes *	Yes *	Yes
	U-NII-1	N/A	Yes	Yes	Yes *	Yes *	Yes
	U-NII-3	N/A	Yes	Yes	Yes *	Yes *	Yes

Note: “ * ”, marked configuration SAR test is required, which is to get more conservative SAR values.

7.4. SAR Test Results

General note:

1. When the highest reported SAR for DSSS is adjusted by the ratio of OFDM to DSSS specified maximum output power and the adjusted SAR is ≤ 1.2 W/kg, 802.11g/n OFDM SAR is not required, per KDB248227 D01 v02r02 section 5.2.2 b).
2. For devices that operate in both U-NII bands using the same transmitter and antenna(s), SAR test reduction is determined according to the following, per KDB248227 D01 v02r02 section 5.3.1:
 - a) When the same maximum output power is specified for both bands, begin SAR measurement in U-NII-2A band by applying the OFDM SAR requirements. If the highest reported SAR for a test configuration is ≤ 1.2 W/kg, SAR is not required for U-NII-1 band for that configuration (802.11 mode and exposure condition); otherwise, each band is tested independently for SAR.
 - b) When different maximum output power is specified for the bands, begin SAR measurement in the band with higher specified maximum output power. The highest reported SAR for the tested configuration is adjusted by the ratio of lower to higher specified maximum output power for the two bands. When the adjusted SAR is ≤ 1.2 W/kg, SAR is not required for the band with lower maximum output power in that test configuration; otherwise, each band is tested independently for SAR.
3. When multiple transmission modes (802.11a/g/n/ac) have the same specified maximum output power, largest channel bandwidth, lowest order modulation and lowest data rate, the lowest order 802.11 mode is selected; i.e., 802.11a is chosen over 802.11n then 802.11ac or 802.11g is chosen over 802.11n, per KDB248227 D01 v02r02 section 5.3.2.
4. When the highest reported SAR for the initial test configuration (when applicable, include subsequent highest output channels), according to the initial test position or fixed exposure position requirements, is adjusted by the ratio of the subsequent test configuration to initial test configuration specified maximum output power and the adjusted SAR is ≤ 1.2 W/kg, SAR is not required for that subsequent test configuration, per KDB248227 D01 v02r02 section 5.3.4 b).
5. When SAR measurement is required for a subsequent test configuration, SAR should first be measured for the channel with highest measured output power in the subsequent test configuration; SAR for subsequent highest measured maximum output power channels in the subsequent test configuration is required only when the reported SAR of the preceding higher maximum output power channel(s) in the subsequent test configuration is > 1.2 W/kg or until all required channels are tested. For channels with the same measured maximum output power, SAR should be measured using the channel closest to the center frequency of the larger channel bandwidth channel in the initial test configuration, per KDB248227 D01 v02r02 section 5.3.4 c).
6. When the original highest measured SAR is ≥ 0.8 W/kg, only one repeated measurement is required, if the measured SAR value of the initial repeated measurement is < 1.45 W/kg with $\leq 20\%$ variation, per KDB 865664 D01 v01r04 section 2.8.1.
7. Per KDB 447498 D01 v06 section 4.4.3 a), testing of other required channels within the operating mode of a frequency band is not required when the reported 1-g or 10-g SAR for the mid-band or highest

output power channel is ≤ 0.8 W/kg or 2.0 W/kg, for 1-g or 10-g respectively, when the transmission band is ≤ 100 MHz.

■ AUX Antenna

Band	Mode	CH.	Freq. (MHz)	Test Position	Dist. (mm)	Cond. Power (dBm)	Max. Tune-up Power (dBm)	Scaling Factor	Duty Cycle %	Duty Cycle Factor	Meas. SAR-1g (W/kg)	Reported SAR-1g (W/kg)	SAR Plot #
DTS	b	1	2412	Bottom	0	13.87	14.0	1.03	99.22	1.01	1.10	1.14	
		7	2442	Back	0	13.82	14.0	1.04	99.22	1.01	0.38	0.40	
				Left	0	13.82	14.0	1.04	99.22	1.01	0.02	0.02	
				Right	0	13.82	14.0	1.04	99.22	1.01	0.01	0.01	
				Top	0	13.82	14.0	1.04	99.22	1.01	0.01	0.01	
				Bottom	0	13.82	14.0	1.04	99.22	1.01	1.09	1.15	1
				Bottom *	0	13.82	14.0	1.04	99.22	1.01	1.06	1.11	
11	2462	Bottom	0	14.13	14.3	1.04	99.22	1.01	1.05	1.10			
U-NII-1	a	36	5180	Bottom	0	10.05	10.2	1.04	98.09	1.02	1.06	1.12	
		36	5180	Bottom *	0	10.05	10.2	1.04	98.09	1.02	1.06	1.12	2
		40	5200	Back	0	10.13	10.3	1.04	98.09	1.02	0.40	0.42	
				Left	0	10.13	10.3	1.04	98.09	1.02	0.05	0.05	
				Right	0	10.13	10.3	1.04	98.09	1.02	0.01	0.01	
				Top	0	10.13	10.3	1.04	98.09	1.02	0.01	0.01	
		Bottom	0	10.13	10.3	1.04	98.09	1.02	1.03	1.09			
48	5240	Bottom	0	10.29	10.4	1.03	98.09	1.02	1.06	1.11			
U-NII-3	a	149	5745	Bottom	0	9.80	10.0	1.05	98.09	1.02	1.08	1.15	
		149	5745	Bottom *	0	9.80	10.0	1.05	98.09	1.02	1.09	1.16	3
		157	5785	Back	0	9.81	10.0	1.04	98.09	1.02	0.50	0.53	
				Left	0	9.81	10.0	1.04	98.09	1.02	0.03	0.03	
				Right	0	9.81	10.0	1.04	98.09	1.02	0.01	0.01	
				Top	0	9.81	10.0	1.04	98.09	1.02	0.01	0.01	
		Bottom	0	9.81	10.0	1.04	98.09	1.02	1.01	1.08			
165	5825	Bottom	0	9.65	9.8	1.04	98.09	1.02	1.05	1.11			
Bluetooth	DH5	78	2480	Back	0	10.30	10.5	1.05	77.07	1.30	0.10	0.14	
				Left	0	10.30	10.5	1.05	77.07	1.30	0.01	0.01	
				Right	0	10.30	10.5	1.05	77.07	1.30	0.01	0.01	
				Top	0	10.30	10.5	1.05	77.07	1.30	0.01	0.01	
				Bottom	0	10.30	10.5	1.05	77.07	1.30	0.32	0.43	4

Note: " * ", repeat SAR measurement.

■ Main Antenna

Band	Mode	CH.	Freq. (MHz)	Test Position	Dist. (mm)	Cond. Power (dBm)	Max. Tune-up Power (dBm)	Scaling Factor	Duty Cycle %	Duty Cycle Factor	Meas. SAR-1g (W/kg)	Reported SAR-1g (W/kg)	SAR Plot #
DTS	b	1	2412	Bottom	0	13.23	13.4	1.04	99.22	1.01	0.76	0.80	
		7	2442	Back	0	12.95	13.1	1.04	99.22	1.01	0.40	0.42	
				Left	0	12.95	13.1	1.04	99.22	1.01	0.02	0.02	
				Right	0	12.95	13.1	1.04	99.22	1.01	0.01	0.01	
				Top	0	12.95	13.1	1.04	99.22	1.01	0.01	0.01	
				Bottom	0	12.95	13.1	1.04	99.22	1.01	0.75	0.78	
		11	2462	Bottom	0	13.33	13.5	1.04	99.22	1.01	0.95	1.00	5
		11	2462	Bottom *	0	13.33	13.5	1.04	99.22	1.01	0.93	0.97	
U-NII-1	a	36	5180	Bottom	0	9.12	9.3	1.04	98.09	1.02	0.71	0.75	
		40	5200	Back	0	9.21	9.4	1.04	98.09	1.02	0.40	0.43	
				Left	0	9.21	9.4	1.04	98.09	1.02	0.04	0.04	
				Right	0	9.21	9.4	1.04	98.09	1.02	0.01	0.01	
				Top	0	9.21	9.4	1.04	98.09	1.02	0.01	0.01	
				Bottom	0	9.21	9.4	1.04	98.09	1.02	0.67	0.71	
48	5240	Bottom	0	9.58	9.7	1.03	98.09	1.02	0.74	0.78	6		
U-NII-3	a	149	5745	Bottom	0	9.89	10.0	1.03	98.09	1.02	0.73	0.76	
		157	5785	Back	0	9.81	10.0	1.04	98.09	1.02	0.30	0.32	
				Left	0	9.81	10.0	1.04	98.09	1.02	0.06	0.06	
				Right	0	9.81	10.0	1.04	98.09	1.02	0.01	0.01	
				Top	0	9.81	10.0	1.04	98.09	1.02	0.01	0.01	
				Bottom	0	9.81	10.0	1.04	98.09	1.02	0.77	0.82	7
165	5825	Bottom	0	9.85	10.0	1.04	98.09	1.02	0.73	0.77			

Note: " * ", repeat SAR measurement.

■ MIMO

Band	Mode	CH.	Freq. (MHz)	Test Position	Dist. (mm)	Cond. Power (dBm)	Max. Tune-up Power (dBm)	Scaling Factor	Duty Cycle %	Duty Cycle Factor	Meas. SAR-1g (W/kg)	Reported SAR-1g (W/kg)	SAR Plot #
DTS	n-HT20	1	2412	Bottom	0	16.21	16.4	1.04	99.28	1.01	1.05	1.10	
		7	2442	Back	0	16.04	16.2	1.04	99.28	1.01	0.49	0.51	
				Left	0	16.04	16.2	1.04	99.28	1.01	0.04	0.04	
				Right	0	16.04	16.2	1.04	99.28	1.01	0.01	0.01	
				Top	0	16.04	16.2	1.04	99.28	1.01	0.01	0.01	
				Bottom	0	16.04	16.2	1.04	99.28	1.01	1.05	1.10	
		11	2462	Bottom	0	15.95	16.1	1.03	99.28	1.01	1.07	1.11	8
		11	2462	Bottom *	0	15.95	16.1	1.03	99.28	1.01	1.03	1.07	
U-NII-1	ac-VH T80	42	5210	Back	0	11.98	12.1	1.03	98.84	1.01	0.47	0.49	
				Left	0	11.98	12.1	1.03	98.84	1.01	0.06	0.06	
				Right	0	11.98	12.1	1.03	98.84	1.01	0.01	0.01	
				Top	0	11.98	12.1	1.03	98.84	1.01	0.05	0.05	
				Bottom	0	11.98	12.1	1.03	98.84	1.01	1.01	1.05	9
				Bottom *	0	11.98	12.1	1.03	98.84	1.01	1.00	1.04	
U-NII-3	ac-VH T80	155	5775	Back	0	12.22	12.4	1.04	98.84	1.01	0.51	0.54	
				Left	0	12.22	12.4	1.04	98.84	1.01	0.07	0.07	
				Right	0	12.22	12.4	1.04	98.84	1.01	0.01	0.01	
				Top	0	12.22	12.4	1.04	98.84	1.01	0.04	0.04	
				Bottom	0	12.22	12.4	1.04	98.84	1.01	1.05	1.11	
				Bottom *	0	12.22	12.4	1.04	98.84	1.01	1.09	1.15	10

Note: “ * ”, repeat SAR measurement.

7.5. Estimated SAR Calculation

Per FCC KDB 447498 D01v06 section 4.3.2 b) 1), when an antenna qualifies for the standalone SAR test exclusion of 4.3.1 and also transmits simultaneously with other antennas, the standalone SAR value was estimated according to the following formula to result in substantially conservative SAR values of $\leq 0.4\text{W/kg}$ for test separation distance $\leq 50\text{mm}$ to determine the simultaneous transmission SAR test exclusion criteria:

$$\text{Estimated SAR} = \frac{\sqrt{f(\text{GHz})}}{7.5} * \frac{(\text{Max Power of channel, mW})}{\text{Min. Separation, mm}}, \text{ for 1-g SAR}$$

$$\text{Estimated SAR} = \frac{\sqrt{f(\text{GHz})}}{18.75} * \frac{(\text{Max Power of channel, mW})}{\text{Min. Separation, mm}}, \text{ for 10-g SAR}$$

When the test separation distance is $> 50\text{ mm}$, estimated 1g-SAR 0.4W/kg /10g-SAR 1.0W/kg is used for simultaneous evaluation.

N/A

8. Simultaneous Transmission Analysis

■ Bluetooth + 2.4GHzWi-Fi

Test Position	Standalone SAR(W/kg)		Summed SAR(W/kg)
	AUX Antenna	Main Antenna	
Back	0.14	0.42	0.56
Left	0.01	0.02	0.03
Right	0.01	0.01	0.02
Top	0.01	0.01	0.02
Bottom	0.43	1.00	1.43

■ Bluetooth + 5GHzWi-Fi

Test Position	Standalone SAR(W/kg)		Summed SAR(W/kg)
	AUX Antenna	Main Antenna	
Back	0.14	0.43	0.57
Left	0.01	0.06	0.07
Right	0.01	0.01	0.02
Top	0.01	0.01	0.02
Bottom	0.43	0.82	1.25

The above analysis is sufficient to determine that simultaneous transmission cases will not exceed the SAR limit and therefore no measured volumetric simultaneous SAR summation is required per FCC KDB Publication 447498 D01v06.

9. Test Equipment Used

WZ-SR3					
Instrument	Manufacturer	Type No.	Asset No.	Cali. Interval	Cali. Due Date
Stäubli Robot TX60L	Stäubli	TX60L	MRTSUE06412	only once	only once
Robot Controller	Stäubli	CS8C	MRTSUE06412	only once	only once
ELI Phantom Shell	Speag	V8	MRTSUE06420	N/A	N/A
DAK	Speag	DAK-3.5	MRTSUE06435	N/A	N/A
Dipole Validation Kits	Speag	D2450V2	MRTSUE06430	3 years	2024/05/18
Dipole Validation Kits	Speag	D5GHzV2	MRTSUE06434	3 years	2025/03/27
DAE4	Speag	SD 000 D04 BN	MRTSUE06414	1 year	2023/05/16
E-Field Probe	Speag	EX3DV4	MRTSUE06438	1 year	2023/07/21
Network Analyzer	Keysight	N5234B	MRTSUE06454	1 year	2023/06/04
Directional Coupler	Agilent	778D	MRTSUE06083	1 year	2023/03/17
Directional Coupler	Agilent	87301D OPT 292	MRTSUE06082	1 year	2023/03/07
Signal Generator	Keysight	N5183B	MRTSUE06197	1 year	2023/07/08
Power Sensor	Keysight	U2021XA	MRTSUE06447	1 year	2023/06/04
Thermohygrometer	Testo	622	MRTSUE06361	1 year	2023/05/09

Software	Version	Function
DASY NEO	52.10.4.1527	SAR Test Software

10. Measurement Uncertainty

DASY5 Uncertainty Budget, according to IEEE 1528 (0.3 - 3 GHz range)								
Error Description	Uncert. value	Prob. Dist.	Div.	(ci) 1g	(ci) 10g	Std. Unc. (1g)	Std. Unc. (10g)	(vi) v _{eff}
Measurement System								
Probe Calibration	±6.0 %	N	1	1	1	±6.0 %	±6.0 %	∞
Axial Isotropy	±4.7 %	R	$\sqrt{3}$	0.7	0.7	±1.9 %	±1.9 %	∞
Hemispherical Isotropy	±9.6 %	R	$\sqrt{3}$	0.7	0.7	±3.9 %	±3.9 %	∞
Boundary Effects	±1.0 %	R	$\sqrt{3}$	1	1	±0.6 %	±0.6 %	∞
Linearity	±4.7 %	R	$\sqrt{3}$	1	1	±2.7 %	±2.7 %	∞
System Detection Limits	±1.0 %	R	$\sqrt{3}$	1	1	±0.6 %	±0.6 %	∞
Modulation Response	±2.4 %	R	$\sqrt{3}$	1	1	±1.4 %	±1.4 %	∞
Readout Electronics	±0.3 %	N	1	1	1	±0.3 %	±0.3 %	∞
Response Time	±0.8 %	R	$\sqrt{3}$	1	1	±0.5 %	±0.5 %	∞
Integration Time	±2.6 %	R	$\sqrt{3}$	1	1	±1.5 %	±1.5 %	∞
RF Ambient Noise	±3.0 %	R	$\sqrt{3}$	1	1	±1.7 %	±1.7 %	∞
RF Ambient Reflections	±3.0 %	R	$\sqrt{3}$	1	1	±1.7 %	±1.7 %	∞
Probe Positioner	±0.02 %	R	$\sqrt{3}$	1	1	±0.0 %	±0.0 %	∞
Probe Positioning	±0.4 %	R	$\sqrt{3}$	1	1	±0.2 %	±0.2 %	∞
Max. SAR Eval.	±2.0 %	R	$\sqrt{3}$	1	1	±1.2 %	±1.2 %	∞
Test Sample Related								
Device Positioning	±2.9%	N	1	1	1	±2.9 %	±2.9 %	145
Device Holder	±3.6%	N	1	1	1	±3.6 %	±3.6 %	5
Power Drift	±5.0%	R	$\sqrt{3}$	1	1	±2.9 %	±2.9 %	∞
Power Scaling	±0%	R	$\sqrt{3}$	1	1	±0.0 %	±0.0 %	∞
Phantom and Setup								
Phantom Uncertainty	±6.1%	R	$\sqrt{3}$	1	1	±3.5 %	±3.5 %	∞
SAR correction	±1.9%	N	1	1	0.84	±1.9 %	±1.6 %	∞
Liquid Cond. (mea.) ^{DAK}	±2.5%	N	1	0.78	0.71	±2.0 %	±1.8 %	∞
Liquid Perm. (mea.) ^{DAK}	±2.5%	N	1	0.23	0.26	±0.6 %	±0.7 %	∞
Temp. unc. – Conductivity	±3.4%	R	$\sqrt{3}$	0.78	0.71	±1.5 %	±1.4 %	∞
Temp. unc. – Permittivity	±0.4%	R	$\sqrt{3}$	0.23	0.26	±0.1 %	±0.1 %	∞
Combined Std. Uncertainty						±11.3%	±11.2%	459
Expanded STD Uncertainty						±22.6%	±22.4%	

DASY5 Uncertainty Budget, according to IEEE 1528 (3 - 6 GHz range)								
Error Description	Uncert. value	Prob. Dist.	Div.	(ci) 1g	(ci) 10g	Std. Unc. (10g)	Std. Unc. (10g)	(vi) v _{eff}
Measurement System								
Probe Calibration	±6.55 %	N	1	1	1	±6.55 %	±6.55 %	∞
Axial Isotropy	±4.7 %	R	$\sqrt{3}$	0.7	0.7	±1.9 %	±1.9 %	∞
Hemispherical Isotropy	±9.6 %	R	$\sqrt{3}$	0.7	0.7	±3.9 %	±3.9 %	∞
Boundary Effects	±2.0 %	R	$\sqrt{3}$	1	1	±1.2 %	±1.2 %	∞
Linearity	±4.7 %	R	$\sqrt{3}$	1	1	±2.7 %	±2.7 %	∞
System Detection Limits	±1.0 %	R	$\sqrt{3}$	1	1	±0.6 %	±0.6 %	∞
Modulation Response	±2.4 %	R	$\sqrt{3}$	1	1	±1.4 %	±1.4 %	∞
Readout Electronics	±0.3 %	N	1	1	1	±0.3 %	±0.3 %	∞
Response Time	±0.8 %	R	$\sqrt{3}$	1	1	±0.5 %	±0.5 %	∞
Integration Time	±2.6 %	R	$\sqrt{3}$	1	1	±1.5 %	±1.5 %	∞
RF Ambient Noise	±3.0 %	R	$\sqrt{3}$	1	1	±1.7 %	±1.7 %	∞
RF Ambient Reflections	±3.0 %	R	$\sqrt{3}$	1	1	±1.7 %	±1.7 %	∞
Probe Positioner	±0.04 %	R	$\sqrt{3}$	1	1	±0.0 %	±0.0 %	∞
Probe Positioning	±0.8 %	R	$\sqrt{3}$	1	1	±0.5 %	±0.5 %	∞
Max. SAR Eval.	±4.0 %	R	$\sqrt{3}$	1	1	±2.3 %	±2.3 %	∞
Test Sample Related								
Device Positioning	±2.9%	N	1	1	1	±2.9 %	±2.9 %	145
Device Holder	±3.6%	N	1	1	1	±3.6 %	±3.6 %	5
Power Drift	±5.0%	R	$\sqrt{3}$	1	1	±2.9 %	±2.9 %	∞
Power Scaling	±0%	R	$\sqrt{3}$	1	1	±0.0 %	±0.0 %	∞
Phantom and Setup								
Phantom Uncertainty	±6.6%	R	$\sqrt{3}$	1	1	±3.8 %	±3.8 %	∞
SAR correction	±1.9%	N	1	1	0.84	±1.9 %	±1.6 %	∞
Liquid Cond. (mea.) ^{DAK}	±2.5%	N	1	0.78	0.71	±2.0 %	±1.8 %	∞
Liquid Perm. (mea.) ^{DAK}	±2.5%	N	1	0.23	0.26	±0.6 %	±0.7 %	∞
Temp. unc. – Conductivity	±3.4%	R	$\sqrt{3}$	0.78	0.71	±1.5 %	±1.4 %	∞
Temp. unc. – Permittivity	±0.4%	R	$\sqrt{3}$	0.23	0.26	±0.1 %	±0.1 %	∞
Combined Std. Uncertainty						±11.9%	±11.8%	569
Expanded STD Uncertainty						±23.8%	±23.6%	

Annex A - System Check Result

Test Date: 08/03/2022

SystemPerformanceCheck-SAM2-D2450HSL

DUT: Dipole 2450 MHz D2450V2; Type: D2450V2

Communication System: CW; Frequency: 2450 MHz; Duty Cycle: 1:1

Medium parameters used: $f = 2450$ MHz; $\sigma = 1.84$ S/m; $\epsilon_r = 40.83$; $\rho = 1000$ kg/m³

Phantom section: Flat Section

DASY5 Configuration:

- Probe: EX3DV4 - SN7524; ConvF(7.65, 7.65, 7.65) @ 2450 MHz; Calibrated: 7/22/2022
- Sensor-Surface: 1.4mm (Mechanical Surface Detection)
- Electronics: DAE4 Sn1552; Calibrated: 5/17/2022
- Phantom: SAM2; Type: QD OVA 004 AA; Serial: 2089
- Measurement SW: DASY52, Version 52.10 (4); SEMCAD X Version 14.6.14 (7483)

configuration/d=10mm, Pin=250mW, dist=1.4mm (EX-Probe)/Area Scan (7x9x1): Measurement grid:

dx=12mm, dy=12mm; Maximum value of SAR (measured) = 20.0 W/kg

configuration/d=10mm, Pin=250mW, dist=1.4mm (EX-Probe)/Zoom Scan (7x7x7)/Cube 0: Measurement

grid: dx=5mm, dy=5mm, dz=5mm; Reference Value = 99.88 V/m; Power Drift = 0.01 dB

Peak SAR (extrapolated) = 26.9 W/kg

SAR(1 g) = 13 W/kg; SAR(10 g) = 6.06 W/kg

Smallest distance from peaks to all points 3 dB below = 9 mm

Ratio of SAR at M2 to SAR at M1 = 48.5%

Maximum value of SAR (measured) = 21.7 W/kg

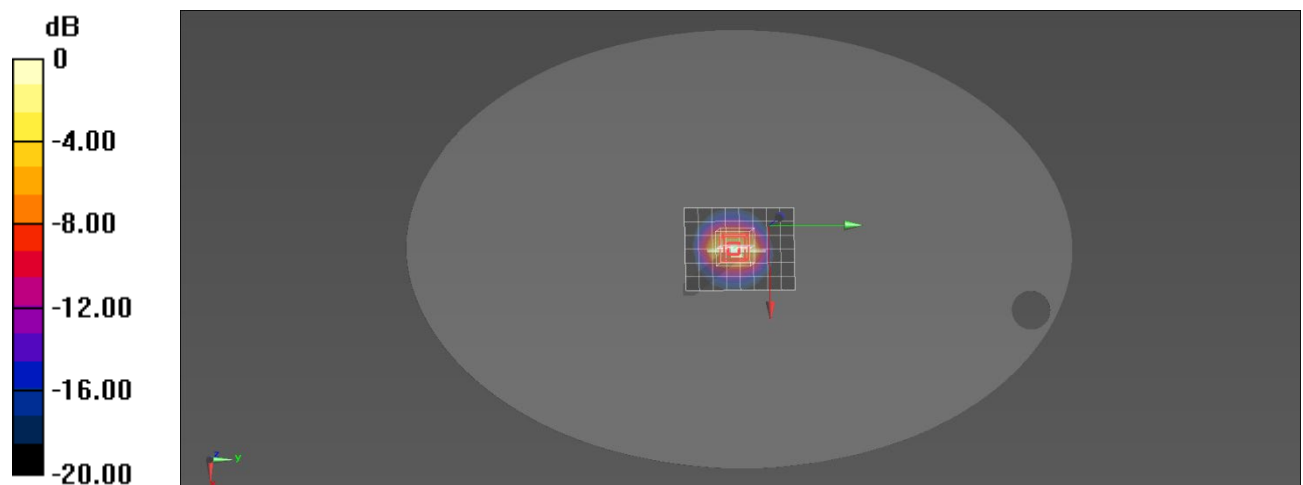

0 dB = 21.7 W/kg = 13.36 dBW/kg

Test Date: 08/04/2022

SystemPerformanceCheck-SAM2-D5250HSL

DUT: Dipole D5GHzV2; Type: D5GHzV2

Communication System: CW; Frequency: 5250 MHz; Duty Cycle: 1:1

Medium parameters used: $f = 5250 \text{ MHz}$; $\sigma = 4.61 \text{ S/m}$; $\epsilon_r = 35.98$; $\rho = 1000 \text{ kg/m}^3$

Phantom section: Flat Section

DASY5 Configuration:

- Probe: EX3DV4 - SN7524; ConvF(5.38, 5.38, 5.38) @ 5250 MHz; Calibrated: 7/22/2022
- Sensor-Surface: 1.4mm (Mechanical Surface Detection)
- Electronics: DAE4 Sn1552; Calibrated: 5/17/2022
- Phantom: SAM2; Type: QD OVA 004 AA; Serial: 2089
- Measurement SW: DASY52, Version 52.10 (4); SEMCAD X Version 14.6.14 (7483)

Configuration/d=10mm, Pin=100mW, dist=1.4mm (EX-Probe)/Area Scan (7x9x1): Measurement grid:

$dx=10\text{mm}$, $dy=10\text{mm}$; Maximum value of SAR (measured) = 16.8 W/kg

Configuration/d=10mm, Pin=100mW, dist=1.4mm (EX-Probe)/Zoom Scan (8x8x8) (7x7x7)/Cube 0:

Measurement grid: $dx=4\text{mm}$, $dy=4\text{mm}$, $dz=1.4\text{mm}$; Reference Value = 51.14 V/m; Power Drift = -0.06 dB

Peak SAR (extrapolated) = 31.5 W/kg

SAR(1 g) = 7.99 W/kg; SAR(10 g) = 2.3 W/kg

Smallest distance from peaks to all points 3 dB below = 7.5 mm

Ratio of SAR at M2 to SAR at M1 = 65.3%

Maximum value of SAR (measured) = 20.1 W/kg

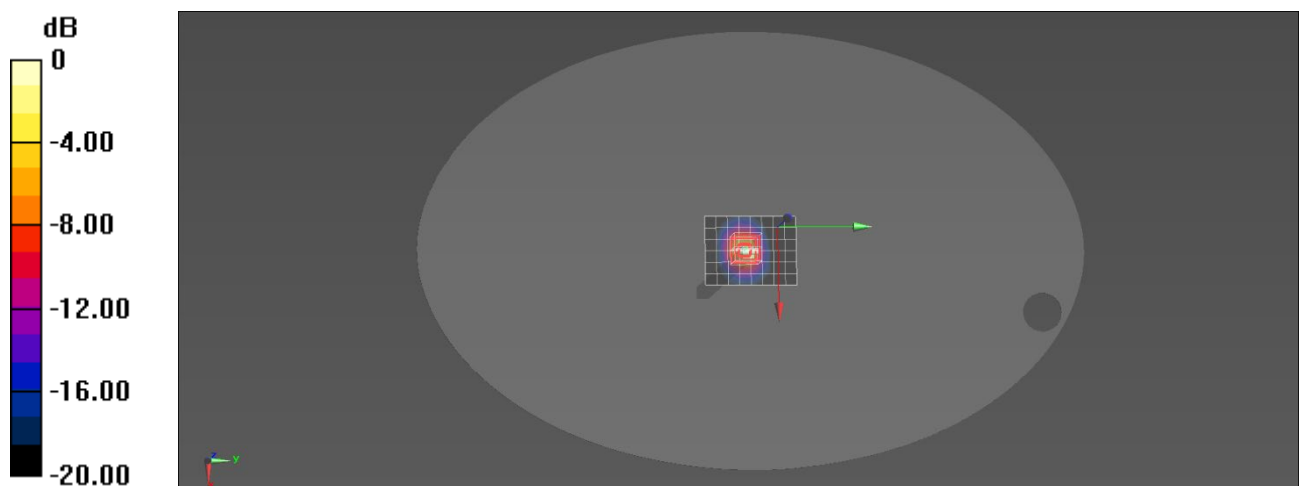

0 dB = 20.1 W/kg = 13.03 dBW/kg

Test Date: 08/05/2022

SystemPerformanceCheck-SAM2-D5750HSL**DUT: Dipole D5GHzV2; Type: D5GHzV2**

Communication System: CW; Frequency: 5750 MHz; Duty Cycle: 1:1

Medium parameters used: $f = 5750$ MHz; $\sigma = 5.17$ S/m; $\epsilon_r = 35.07$; $\rho = 1000$ kg/m³

Phantom section: Flat Section

DASY5 Configuration:

- Probe: EX3DV4 - SN7524; ConvF(4.87, 4.87, 4.87) @ 5750 MHz; Calibrated: 7/22/2022
- Sensor-Surface: 1.4mm (Mechanical Surface Detection)
- Electronics: DAE4 Sn1552; Calibrated: 5/17/2022
- Phantom: SAM2; Type: QD OVA 004 AA; Serial: 2089
- Measurement SW: DASY52, Version 52.10 (4); SEMCAD X Version 14.6.14 (7483)

Configuration/d=10mm, Pin=100 mW, dist=1.4mm (EX-Probe)/Area Scan (7x9x1): Measurement grid:

dx=10mm, dy=10mm; Maximum value of SAR (measured) = 16.7 W/kg

Configuration/d=10mm, Pin=100 mW, dist=1.4mm (EX-Probe)/Zoom Scan (8x8x8) (9x9x7)/Cube 0:

Measurement grid: dx=4mm, dy=4mm, dz=1.4mm; Reference Value = 51.52 V/m; Power Drift = -0.09 dB

Peak SAR (extrapolated) = 35.9 W/kg

SAR(1 g) = 8.07 W/kg; SAR(10 g) = 2.3 W/kg

Smallest distance from peaks to all points 3 dB below = 7.4 mm

Ratio of SAR at M2 to SAR at M1 = 61.7%

Maximum value of SAR (measured) = 21.2 W/kg

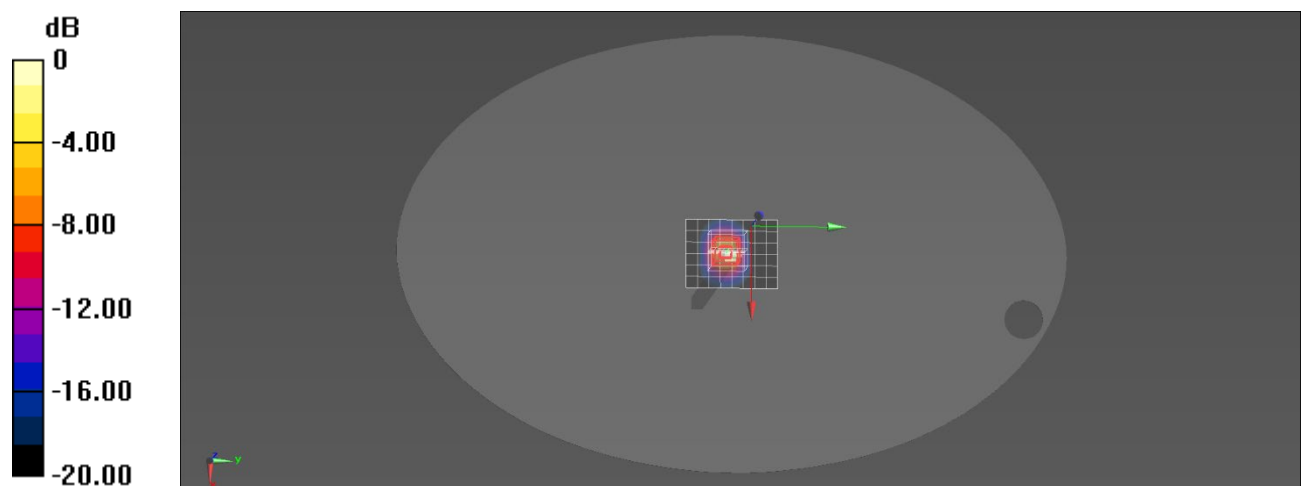

0 dB = 21.2 W/kg = 13.26 dBW/kg

Annex B - Test Data Plots

Plot 1#

Test Date: 08/03/2022

DUT: Rugged Tablet; Type: RTC-1010
Procedure Name: 802.11b 2442MHz Body Bottom

Communication System: 802.11b; Frequency: 2442 MHz; Duty Cycle: 1:1

 Medium parameters used: $f = 2442$ MHz; $\sigma = 1.84$ S/m; $\epsilon_r = 40.85$; $\rho = 1000$ kg/m³; Tissue Temp (celsius)-22.5°C;

Phantom section: Flat Section

DASY5 Configuration:

- Probe: EX3DV4 - SN7524; ConvF(7.65, 7.65, 7.65) @ 2442 MHz; Calibrated: 7/22/2022
- Sensor-Surface: 1.4mm (Mechanical Surface Detection)
- Electronics: DAE4 Sn1552; Calibrated: 5/17/2022
- Phantom: SAM2; Type: QD OVA 004 AA; Serial: 2089
- Measurement SW: DASY52, Version 52.10 (4); SEMCAD X Version 14.6.14 (7483)

Configuration/802.11b 2442MHz Body Bottom/Area Scan (13x7x1): Measurement grid: dx=12mm, dy=12mm; Maximum value of SAR (measured) = 1.73 W/kg

Configuration/802.11b 2442MHz Body Bottom/Zoom Scan (7x7x7)/Cube 0: Measurement grid: dx=5mm, dy=5mm, dz=5mm; Reference Value = 2.824 V/m; Power Drift = 0.11 dB

Peak SAR (extrapolated) = 2.45 W/kg

SAR(1 g) = 1.09 W/kg; SAR(10 g) = 0.410 W/kg

Smallest distance from peaks to all points 3 dB below = 8.1 mm

Ratio of SAR at M2 to SAR at M1 = 47.4%

Maximum value of SAR (measured) = 1.92 W/kg

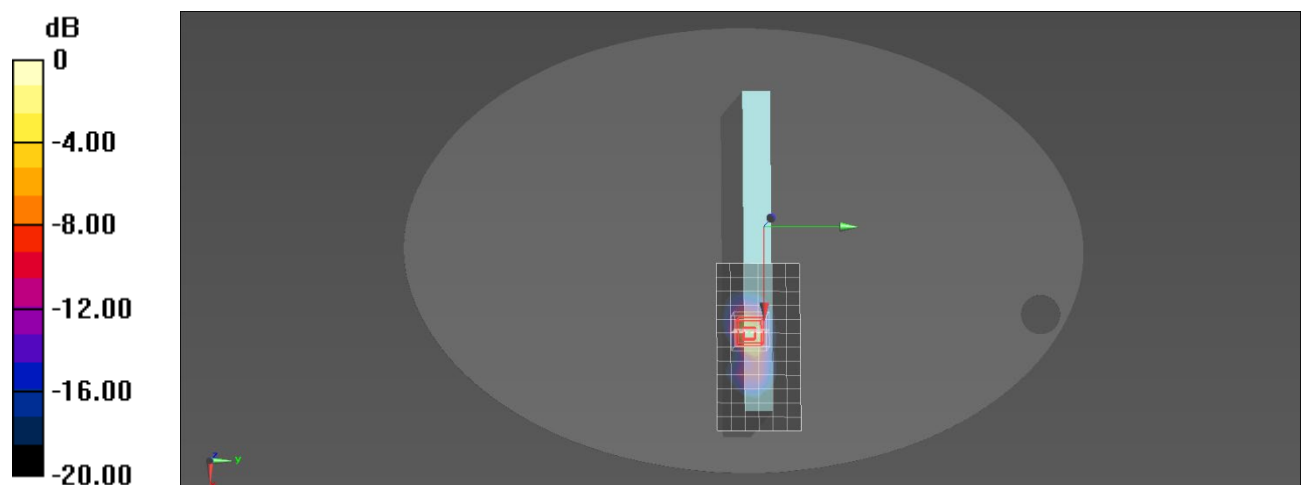

0 dB = 1.92 W/kg = 2.83 dBW/kg

Plot 2#

Test Date: 08/04/2022

DUT: Rugged Tablet; Type: RTC-1010**Procedure Name: 802.11a 5180MHz Body Bottom**

Communication System: 802.11a; Frequency: 5180 MHz; Duty Cycle: 1:1

Medium parameters used: $f = 5180$ MHz; $\sigma = 4.53$ S/m; $\epsilon_r = 36.11$; $\rho = 1000$ kg/m³; Tissue Temp (celsius)-22.5°C;

Phantom section: Flat Section

DASY5 Configuration:

- Probe: EX3DV4 - SN7524; ConvF(5.38, 5.38, 5.38) @ 5180 MHz; Calibrated: 7/22/2022
- Sensor-Surface: 1.4mm (Mechanical Surface Detection)
- Electronics: DAE4 Sn1552; Calibrated: 5/17/2022
- Phantom: SAM2; Type: QD OVA 004 AA; Serial: 2089
- Measurement SW: DASY52, Version 52.10 (4); SEMCAD X Version 14.6.14 (7483)

Configuration/802.11a 5180MHz Body Bottom/Area Scan (16x8x1): Measurement grid: dx=10mm, dy=10mm; Maximum value of SAR (measured) = 2.63 W/kg**Configuration/802.11a 5180MHz Body Bottom/Zoom Scan (7x7x7)/Cube 0:** Measurement grid: dx=4mm, dy=4mm, dz=1.4mm; Reference Value = 12.88 V/m; Power Drift = -0.11 dB

Peak SAR (extrapolated) = 4.23 W/kg

SAR(1 g) = 1.06 W/kg; SAR(10 g) = 0.285 W/kg

Smallest distance from peaks to all points 3 dB below = 6.2 mm

Ratio of SAR at M2 to SAR at M1 = 66.1%

Maximum value of SAR (measured) = 2.73 W/kg

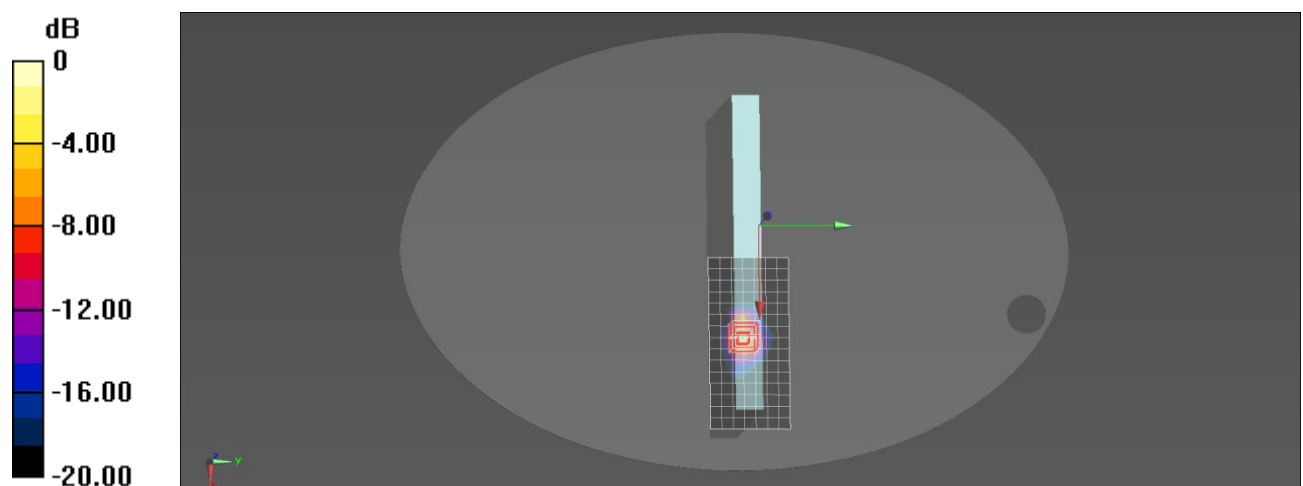

0 dB = 2.73 W/kg = 4.36 dBW/kg

Plot 3#

Test Date: 08/05/2022

DUT: Rugged Tablet; Type: RTC-1010
Procedure Name: 802.11a 5745MHz Body Bottom

Communication System: 802.11a; Frequency: 5745 MHz; Duty Cycle: 1:1

 Medium parameters used: $f = 5745$ MHz; $\sigma = 5.17$ S/m; $\epsilon_r = 35.08$; $\rho = 1000$ kg/m³; Tissue Temp (celsius)-22.5°C;

Phantom section: Flat Section

DASY5 Configuration:

- Probe: EX3DV4 - SN7524; ConvF(4.87, 4.87, 4.87) @ 5745 MHz; Calibrated: 7/22/2022
- Sensor-Surface: 1.4mm (Mechanical Surface Detection)
- Electronics: DAE4 Sn1552; Calibrated: 5/17/2022
- Phantom: SAM2; Type: QD OVA 004 AA; Serial: 2089
- Measurement SW: DASY52, Version 52.10 (4); SEMCAD X Version 14.6.14 (7483)

Configuration/802.11a 5745MHz Body Bottom/Area Scan (16x8x1): Measurement grid: dx=10mm, dy=10mm; Maximum value of SAR (measured) = 2.87 W/kg

Configuration/802.11a 5745MHz Body Bottom/Zoom Scan (9x9x7)/Cube 0: Measurement grid: dx=4mm, dy=4mm, dz=1.4mm; Reference Value = 15.63 V/m; Power Drift = -0.09 dB

Peak SAR (extrapolated) = 5.00 W/kg

SAR(1 g) = 1.09 W/kg; SAR(10 g) = 0.284 W/kg

Smallest distance from peaks to all points 3 dB below = 6.8 mm

Ratio of SAR at M2 to SAR at M1 = 61.3%

Maximum value of SAR (measured) = 2.97 W/kg

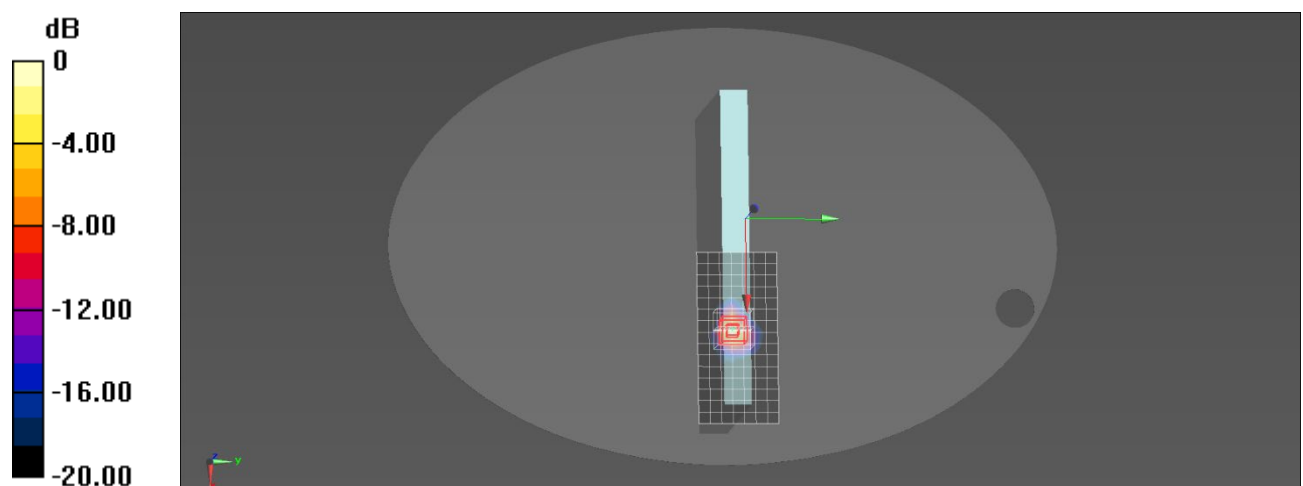

0 dB = 2.97 W/kg = 4.73 dBW/kg

Plot 4#

Test Date: 08/03/2022

DUT: Rugged Tablet; Type: RTC-1010**Procedure Name: Bluetooth_DH5 2480MHz Body Bottom**

Communication System: Bluetooth; Frequency: 2480 MHz; Duty Cycle: 1:1

Medium parameters used: $f = 2480$ MHz; $\sigma = 1.86$ S/m; $\epsilon_r = 40.79$; $\rho = 1000$ kg/m³; Tissue Temp (celsius)-22.5°C;

Phantom section: Flat Section

DASY5 Configuration:

- Probe: EX3DV4 - SN7524; ConvF(7.65, 7.65, 7.65) @ 2480 MHz; Calibrated: 7/22/2022
- Sensor-Surface: 1.4mm (Mechanical Surface Detection)
- Electronics: DAE4 Sn1552; Calibrated: 5/17/2022
- Phantom: SAM2; Type: QD OVA 004 AA; Serial: 2089
- Measurement SW: DASY52, Version 52.10 (4); SEMCAD X Version 14.6.14 (7483)

Configuration/Bluetooth_DH5 2480MHz Body Bottom/Area Scan (13x7x1): Measurement grid: dx=12mm, dy=12mm; Maximum value of SAR (measured) = 0.449 W/kg**Configuration/Bluetooth_DH5 2480MHz Body Bottom/Zoom Scan (7x7x7)/Cube 0:** Measurement grid: dx=5mm, dy=5mm, dz=5mm; Reference Value = 0.9670 V/m; Power Drift = -0.16 dB

Peak SAR (extrapolated) = 0.740 W/kg

SAR(1 g) = 0.317 W/kg; SAR(10 g) = 0.117 W/kg

Smallest distance from peaks to all points 3 dB below = 7.6 mm

Ratio of SAR at M2 to SAR at M1 = 46%

Maximum value of SAR (measured) = 0.576 W/kg

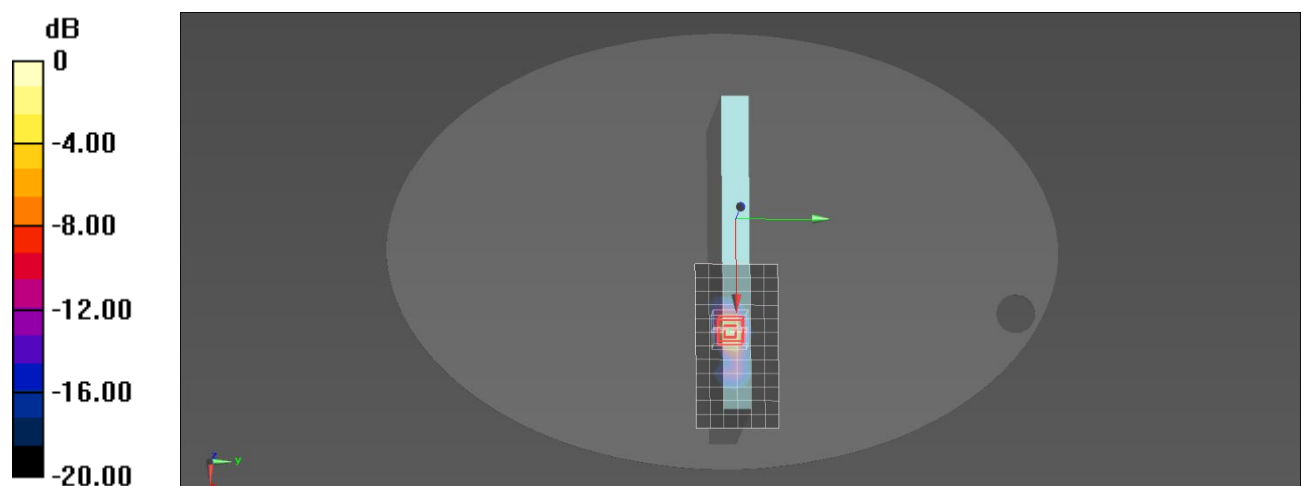

0 dB = 0.576 W/kg = -2.40 dBW/kg

Plot 5#

Test Date: 08/03/2022

DUT: Rugged Tablet; Type: RTC-1010**Procedure Name: 802.11b 2462MHz Body Bottom**

Communication System: 802.11b; Frequency: 2462 MHz; Duty Cycle: 1:1

Medium parameters used: $f = 2462$ MHz; $\sigma = 1.85$ S/m; $\epsilon_r = 40.82$; $\rho = 1000$ kg/m³; Tissue Temp (celsius)-22.5°C;

Phantom section: Flat Section

DASY5 Configuration:

- Probe: EX3DV4 - SN7524; ConvF(7.65, 7.65, 7.65) @ 2462 MHz; Calibrated: 7/22/2022
- Sensor-Surface: 1.4mm (Mechanical Surface Detection)
- Electronics: DAE4 Sn1552; Calibrated: 5/17/2022
- Phantom: SAM2; Type: QD OVA 004 AA; Serial: 2089
- Measurement SW: DASY52, Version 52.10 (4); SEMCAD X Version 14.6.14 (7483)

Configuration/802.11b 2462MHz Body Bottom/Area Scan (13x7x1): Measurement grid: dx=12mm, dy=12mm; Maximum value of SAR (measured) = 1.22 W/kg**Configuration/802.11b 2462MHz Body Bottom/Zoom Scan (7x7x7)/Cube 0:** Measurement grid: dx=5mm, dy=5mm, dz=5mm; Reference Value = 1.236 V/m; Power Drift = -0.16 dB

Peak SAR (extrapolated) = 2.24 W/kg

SAR(1 g) = 0.951 W/kg; SAR(10 g) = 0.345 W/kg

Smallest distance from peaks to all points 3 dB below = 7.2 mm

Ratio of SAR at M2 to SAR at M1 = 45.6%

Maximum value of SAR (measured) = 1.77 W/kg

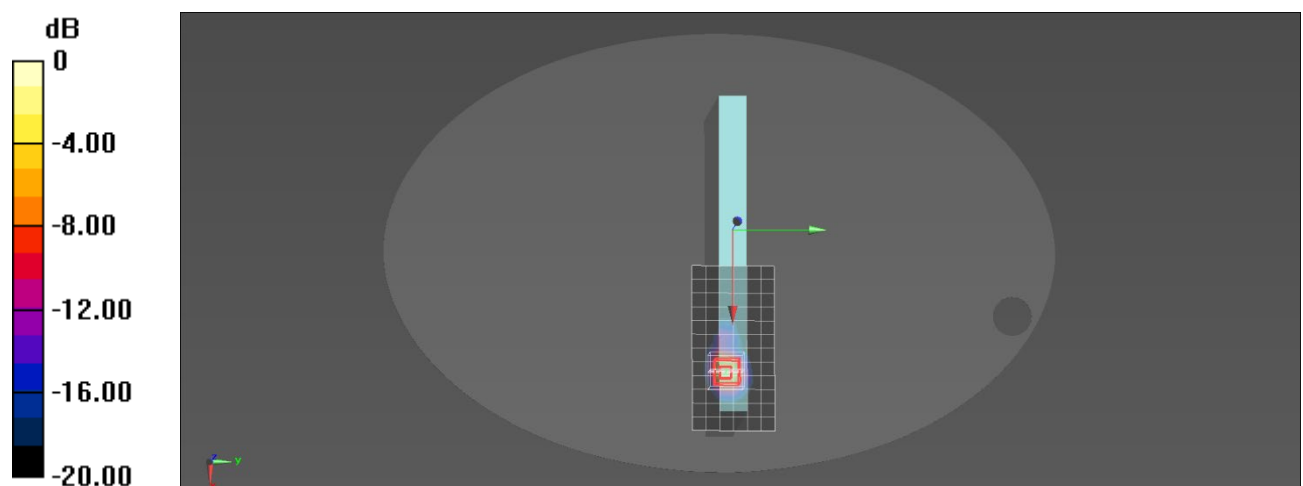

0 dB = 1.77 W/kg = 2.48 dBW/kg

Plot 6#

Test Date: 08/04/2022

DUT: Rugged Tablet; Type: RTC-1010**Procedure Name: 802.11a 5240MHz Body Bottom**

Communication System: 802.11a; Frequency: 5240 MHz; Duty Cycle: 1:1

Medium parameters used: $f = 5240$ MHz; $\sigma = 4.59$ S/m; $\epsilon_r = 35.99$; $\rho = 1000$ kg/m³; Tissue Temp (celsius)-22.5°C;

Phantom section: Flat Section

DASY5 Configuration:

- Probe: EX3DV4 - SN7524; ConvF(5.38, 5.38, 5.38) @ 5240 MHz; Calibrated: 7/22/2022
- Sensor-Surface: 1.4mm (Mechanical Surface Detection)
- Electronics: DAE4 Sn1552; Calibrated: 5/17/2022
- Phantom: SAM2; Type: QD OVA 004 AA; Serial: 2089
- Measurement SW: DASY52, Version 52.10 (4); SEMCAD X Version 14.6.14 (7483)

Configuration/802.11a 5240MHz Body Bottom/Area Scan (16x8x1): Measurement grid: dx=10mm, dy=10mm; Maximum value of SAR (measured) = 1.49 W/kg**Configuration/802.11a 5240MHz Body Bottom/Zoom Scan (7x7x7)/Cube 0:** Measurement grid: dx=4mm, dy=4mm, dz=1.4mm; Reference Value = 14.46 V/m; Power Drift = -0.07 dB

Peak SAR (extrapolated) = 2.85 W/kg

SAR(1 g) = 0.744 W/kg; SAR(10 g) = 0.204 W/kg

Smallest distance from peaks to all points 3 dB below = 7.2 mm

Ratio of SAR at M2 to SAR at M1 = 65.8%

Maximum value of SAR (measured) = 1.85 W/kg

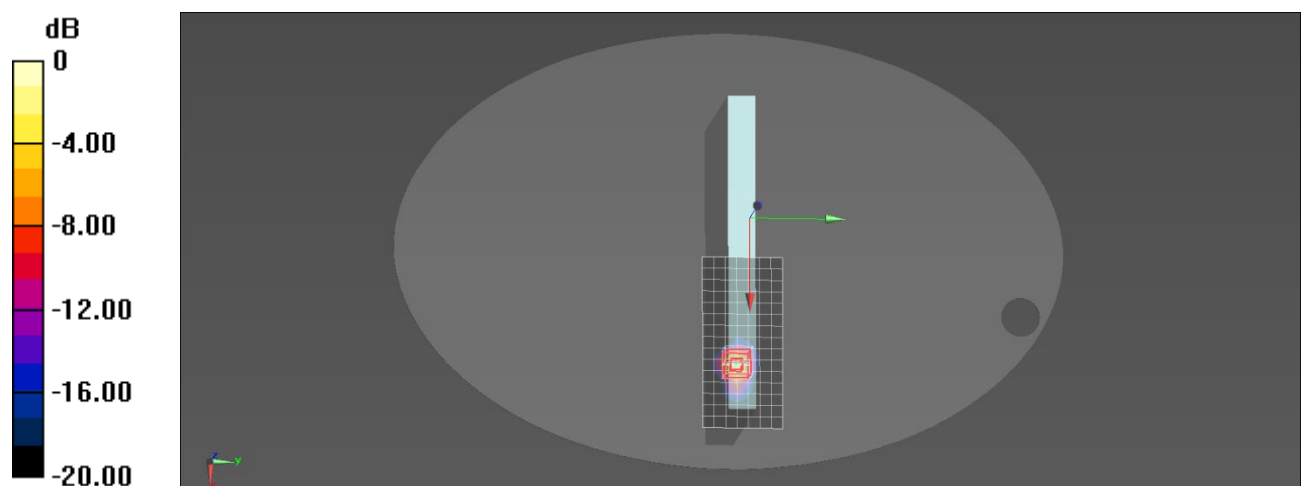

0 dB = 1.85 W/kg = 2.67 dBW/kg

Plot 7#

Test Date: 08/05/2022

DUT: Rugged Tablet; Type: RTC-1010**Procedure Name: 802.11a 5785MHz Body Bottom**

Communication System: 802.11a; Frequency: 5785 MHz; Duty Cycle: 1:1

Medium parameters used: $f = 5785$ MHz; $\sigma = 5.22$ S/m; $\epsilon_r = 35.01$; $\rho = 1000$ kg/m³; Tissue Temp (celsius)-22.5°C;

Phantom section: Flat Section

DASY5 Configuration:

- Probe: EX3DV4 - SN7524; ConvF(4.87, 4.87, 4.87) @ 5785 MHz; Calibrated: 7/22/2022
- Sensor-Surface: 1.4mm (Mechanical Surface Detection)
- Electronics: DAE4 Sn1552; Calibrated: 5/17/2022
- Phantom: SAM2; Type: QD OVA 004 AA; Serial: 2089
- Measurement SW: DASY52, Version 52.10 (4); SEMCAD X Version 14.6.14 (7483)

Configuration/802.11a 5785MHz Body Bottom/Area Scan (16x8x1): Measurement grid: dx=10mm, dy=10mm; Maximum value of SAR (measured) = 1.64 W/kg**Configuration/802.11a 5785MHz Body Bottom/Zoom Scan (8x8x7)/Cube 0:** Measurement grid: dx=4mm, dy=4mm, dz=1.4mm; Reference Value = 15.78 V/m; Power Drift = 0.03 dB

Peak SAR (extrapolated) = 3.57 W/kg

SAR(1 g) = 0.769 W/kg; SAR(10 g) = 0.199 W/kg

Smallest distance from peaks to all points 3 dB below = 6.4 mm

Ratio of SAR at M2 to SAR at M1 = 60.7%

Maximum value of SAR (measured) = 2.10 W/kg

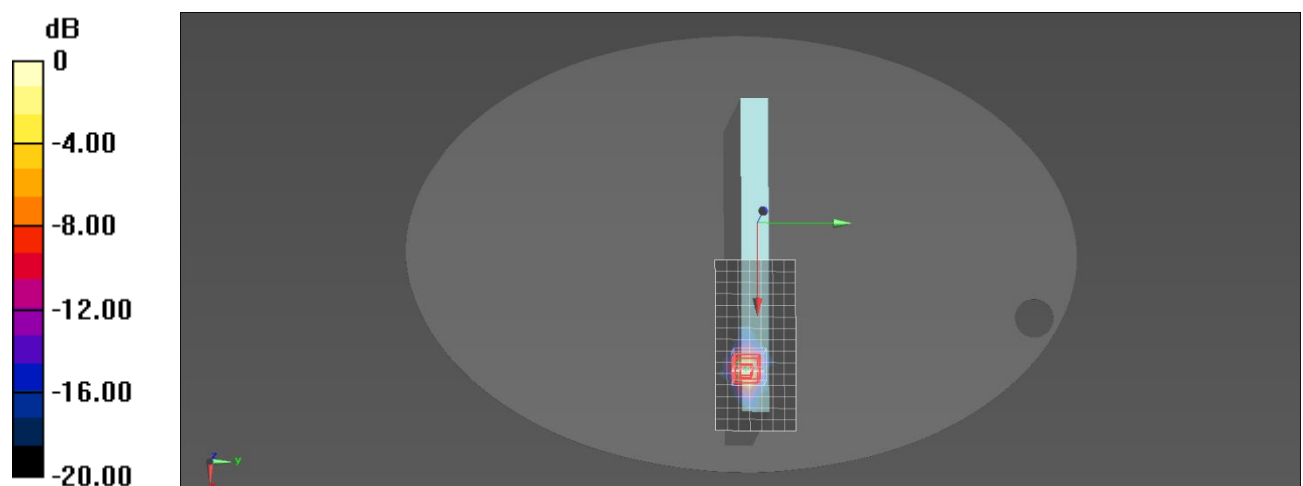

0 dB = 2.10 W/kg = 3.22 dBW/kg

Plot 8#

Test Date: 08/03/2022

DUT: Rugged Tablet; Type: RTC-1010**Procedure Name: 802.11n-HT20 2462MHz Body Bottom**

Communication System: 802.11n; Frequency: 2462 MHz; Duty Cycle: 1:1

Medium parameters used: $f = 2462$ MHz; $\sigma = 1.85$ S/m; $\epsilon_r = 40.82$; $\rho = 1000$ kg/m³; Tissue Temp (celsius)-22.5°C;

Phantom section: Flat Section

DASY5 Configuration:

- Probe: EX3DV4 - SN7524; ConvF(7.65, 7.65, 7.65) @ 2462 MHz; Calibrated: 7/22/2022
- Sensor-Surface: 1.4mm (Mechanical Surface Detection)
- Electronics: DAE4 Sn1552; Calibrated: 5/17/2022
- Phantom: SAM2; Type: QD OVA 004 AA; Serial: 2089
- Measurement SW: DASY52, Version 52.10 (4); SEMCAD X Version 14.6.14 (7483)

Configuration/802.11n-HT20 2462MHz Body Bottom/Area Scan (13x7x1): Measurement grid: dx=12mm, dy=12mm; Maximum value of SAR (measured) = 1.46 W/kg**Configuration/802.11n-HT20 2462MHz Body Bottom/Zoom Scan (7x7x7)/Cube 0:** Measurement grid:

dx=5mm, dy=5mm, dz=5mm; Reference Value = 1.963 V/m; Power Drift = 0.10 dB

Peak SAR (extrapolated) = 2.44 W/kg

SAR(1 g) = 1.07 W/kg; SAR(10 g) = 0.404 W/kg

Smallest distance from peaks to all points 3 dB below = 8 mm

Ratio of SAR at M2 to SAR at M1 = 46.7%

Maximum value of SAR (measured) = 1.90 W/kg

Configuration/802.11n-HT20 2462MHz Body Bottom/Zoom Scan (7x7x7)/Cube 1: Measurement grid:

dx=5mm, dy=5mm, dz=5mm; Reference Value = 1.963 V/m; Power Drift = 0.10 dB

Peak SAR (extrapolated) = 2.31 W/kg

SAR(1 g) = 0.984 W/kg; SAR(10 g) = 0.381 W/kg

Smallest distance from peaks to all points 3 dB below = 7.6 mm

Ratio of SAR at M2 to SAR at M1 = 46.3%

Maximum value of SAR (measured) = 1.79 W/kg

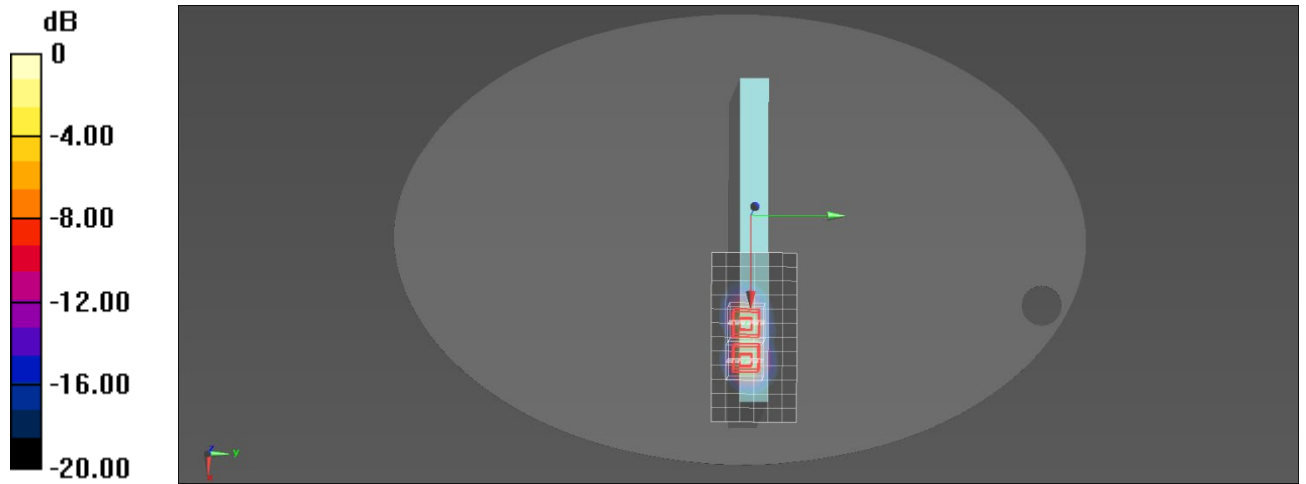

0 dB = 1.79 W/kg = 2.53 dBW/kg

Plot 9#

Test Date: 08/04/2022

DUT: Rugged Tablet; Type: RTC-1010

Procedure Name: 802.11ac-VHT80 5210MHz Body Bottom

Communication System: 802.11ac; Frequency: 5210 MHz; Duty Cycle: 1:1

Medium parameters used: $f = 5210 \text{ MHz}$; $\sigma = 4.56 \text{ S/m}$; $\epsilon_r = 36.05$; $\rho = 1000 \text{ kg/m}^3$; Tissue Temp (celsius)-22.5°C;

Phantom section: Flat Section

DASY5 Configuration:

- Probe: EX3DV4 - SN7524; ConvF(5.38, 5.38, 5.38) @ 5210 MHz; Calibrated: 7/22/2022
- Sensor-Surface: 1.4mm (Mechanical Surface Detection)
- Electronics: DAE4 Sn1552; Calibrated: 5/17/2022
- Phantom: SAM2; Type: QD OVA 004 AA; Serial: 2089
- Measurement SW: DASY52, Version 52.10 (4); SEMCAD X Version 14.6.14 (7483)

Configuration/802.11ac-VHT80 5210MHz Body Bottom/Area Scan (16x8x1): Measurement grid: $dx=10\text{mm}$, $dy=10\text{mm}$; Maximum value of SAR (measured) = 2.65 W/kg

Configuration/802.11ac-VHT80 5210MHz Body Bottom/Zoom Scan (9x9x7)/Cube 0: Measurement grid: $dx=4\text{mm}$, $dy=4\text{mm}$, $dz=1.4\text{mm}$; Reference Value = 15.40 V/m; Power Drift = -0.11 dB

Peak SAR (extrapolated) = 4.08 W/kg

SAR(1 g) = 1.01 W/kg; SAR(10 g) = 0.273 W/kg

Smallest distance from peaks to all points 3 dB below = 6.6 mm

Ratio of SAR at M2 to SAR at M1 = 65.8%

Maximum value of SAR (measured) = 2.46 W/kg

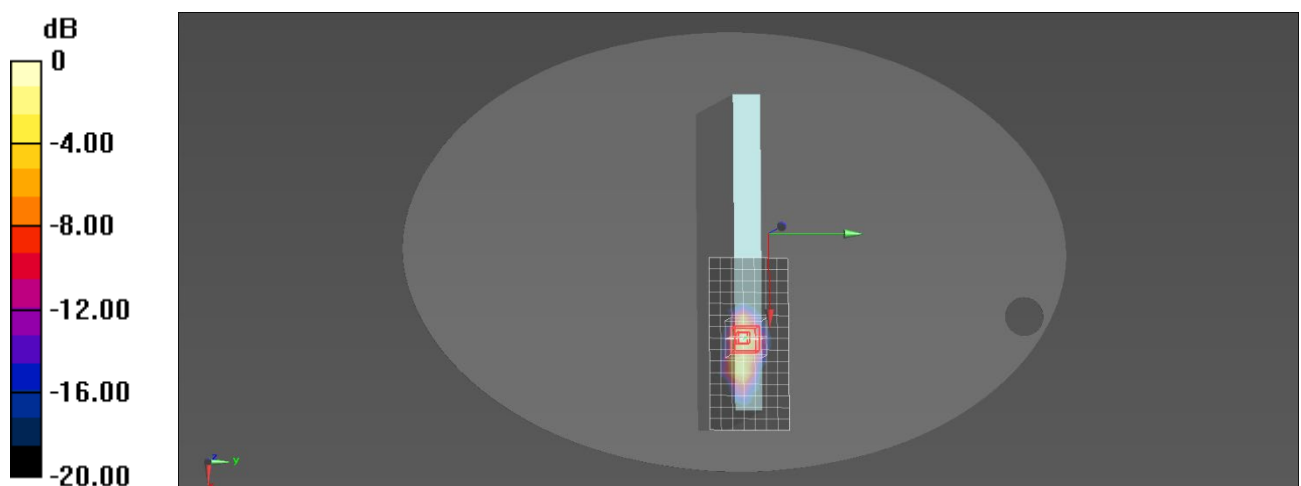

0 dB = 2.46 W/kg = 3.91 dBW/kg

Plot 10#

Test Date: 08/05/2022

DUT: Rugged Tablet; Type: RTC-1010
Procedure Name: 802.11ac-VHT80 5775MHz Body Bottom

Communication System: 802.11ac; Frequency: 5775 MHz; Duty Cycle: 1:1

 Medium parameters used: $f = 5775$ MHz; $\sigma = 5.21$ S/m; $\epsilon_r = 35.03$; $\rho = 1000$ kg/m³; Tissue Temp (celsius)-22.5°C;

Phantom section: Flat Section

DASY5 Configuration:

- Probe: EX3DV4 - SN7524; ConvF(4.87, 4.87, 4.87) @ 5775 MHz; Calibrated: 7/22/2022
- Sensor-Surface: 1.4mm (Mechanical Surface Detection)
- Electronics: DAE4 Sn1552; Calibrated: 5/17/2022
- Phantom: SAM2; Type: QD OVA 004 AA; Serial: 2089
- Measurement SW: DASY52, Version 52.10 (4); SEMCAD X Version 14.6.14 (7483)

Configuration/802.11ac-VHT80 5775MHz Body Bottom/Area Scan (16x8x1): Measurement grid: dx=10mm, dy=10mm; Maximum value of SAR (measured) = 2.74 W/kg

Configuration/802.11ac-VHT80 5775MHz Body Bottom/Zoom Scan (7x7x7)/Cube 0: Measurement grid: dx=4mm, dy=4mm, dz=1.4mm; Reference Value = 15.60 V/m; Power Drift = -0.19 dB

Peak SAR (extrapolated) = 5.02 W/kg

SAR(1 g) = 1.09 W/kg; SAR(10 g) = 0.289 W/kg

Smallest distance from peaks to all points 3 dB below = 6.4 mm

Ratio of SAR at M2 to SAR at M1 = 60.6%

Maximum value of SAR (measured) = 2.88 W/kg

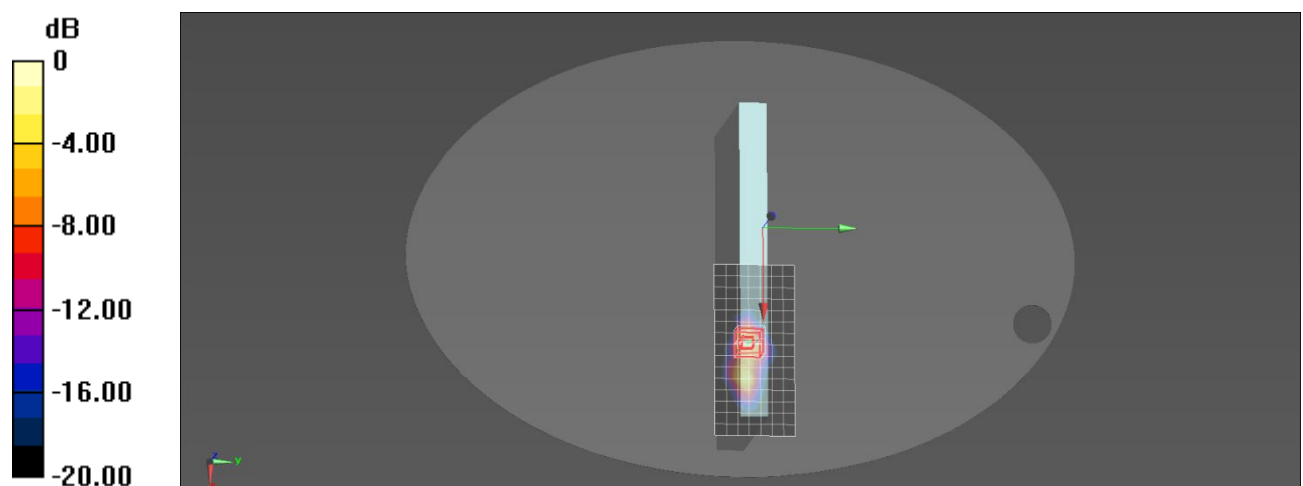

0 dB = 2.88 W/kg = 4.59 dBW/kg

Annex C - SAR Test Setup Photos

Please refer to document "2206RSU062-UT".

Annex D - EUT External Photos

Please refer to document "2206RSU062-UE".

Annex E - Equipment Calibration Report

Please refer to document "Annex E - Equipment Calibration Report.pdf".

The End