

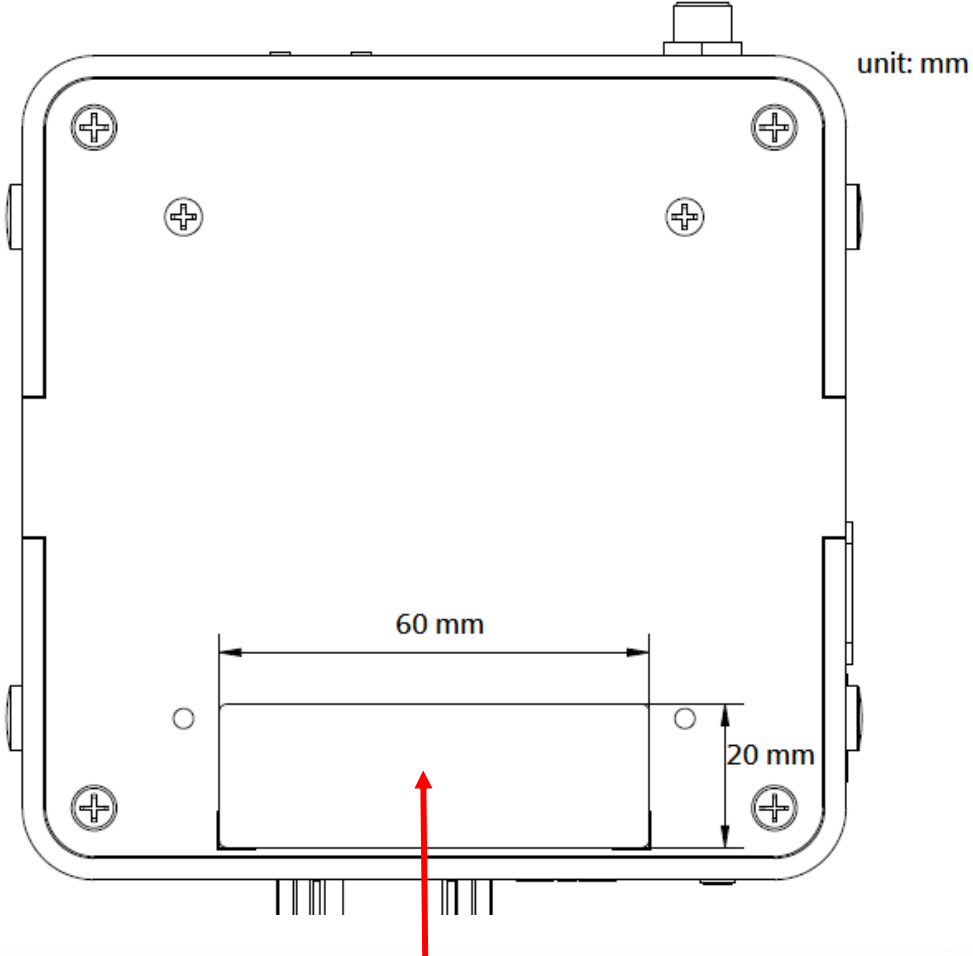





# Label and Label Location



<b>FWS-2275E3-A10-00</b> Desktop.Intel N3350.3xGbE.2GB LPDDR4.16GB eMMC.HDMI.Fanless.Black	  <b>FC CE</b> FCC ID: OHBFWS2275WB CAN ICES-3 (A)/NMB-3(A)
DC input: 9-24V  , 4-1.5A	MAC1:  0007324C9CA6 L/N:TFF1801002 MADE IN TAIWAN AAEON Technology Inc.
 P18C00001	 4 719622 179655