

# INSTALLATION INSTRUCTION FOR CEILING FAN REMOTE CONTROLLER

MODEL NO. AA2020-3RFA/AA2020-3RFB/AA2020-3RFD-RECEIVER  
AA1T4/AA2T4/AA3T4-TRANSMITTER

## IMPORTANT POINTS:

1. Please read this instruction, and save it for further use.
2. Before installation, TURN OFF THE POWER TO YOUR CEILING FAN (at the main switch box or fuse box).
3. Please note that all wiring appliances should be installed by a qualified electrician.
4. This unit is to be used in a 100V-120V~ 50/60Hz supply only. (Rating: RECEIVER: max.100W, Min.15W for fan motor; max.300W, Min.5W for light kits. TRANSMITTER: Transmitting frequency range:433.92MHZ±300kHz. And the lamp load must used the incandescent light)
5. Do not install in damp locations or immerse in water. (For indoor use only.)
6. Do not pull on or cut leads shorter.
7. Do not drop or bump the unit.
8. PLEASE NOTE: The battery will weaken with age and should be replaced before leaking takes place as this will damage the transmitter.
9. The batteries must be removed from the transmitter before it is scrapped and the batteries shall be disposed of safety.
10. The switch shall be mounted at a height greater than 1.7m.
11. The electric shock protection of the RF receiver shall be depended on its installation.
12. The RF Remote controller shall be used within its rating range, otherwise overheating and dangerous phenomenon may occur.
13. The RF ceiling fan remote controller is made by XIN HUI A.A. ELECTRONICS LTD.
14. CAUTION: To reduce the risk of fire or injury, do not use this product in conjunction with any variable(rheostat) wall control.
15. Warning: Changes or modifications to this unit not expressly approved by the party responsible for compliance could void the user's authority to operate the equipment.
16. This device complies with Part 15 of the FCC Rules. Operation is subject to the following two conditions: (1) this device may not cause harmful interference, and (2) this device must accept any interference received, including interference that may cause undesired operation.
17. NOTE: This equipment has been tested and found to comply with the limits for a Class B digital device, pursuant to Part 15 of the FCC Rules. These limits are designed to provide reasonable protection against harmful interference in a residential installation. This equipment generates uses and can radiate radio frequency energy and, if not installed and used in accordance with the instructions, may cause harmful interference to radio communications.  
However, there is no guarantee that interference will not occur in a particular installation. If this equipment does cause harmful interference to radio or television reception, which can be determined by turning the equipment off and on, the user is encouraged to try to correct the interference by one or more of the following measures:
  - Reorient or relocate the receiving antenna.
  - Increase the separation between the equipment and receiver.
  - Connect the equipment into an outlet on a circuit different from that to which the receiver is connected.
  - Consult the dealer or an experienced radio/TV technician for help.

## OPERATION INSTRUCTIONS:

1. Two methods are provided to control fan operation: (a) control by pull chain switch (b) control by remote controller
- 2.(a) Use pull chain switch to control the fan operation: Before using pull chain switch, set Fan Speed to "HIGH" position on the remote controller.
- 3.(b)Use remote controller to control the fan operation:
  - 3.1 Before using remote controller, pull chain switch, set Fan Speed to "HIGH" position
  - 3.2 Your remote controller is ready for use after battery installation.
4. Once the remote controller is missing or damaged and pull chain switch can not perform its function, do as the following:
  - (a) Turn off the master supply at the circuit breaker or fuse box.
  - (b) Remove the receiver and connect the wires according to the fan installation instruction. Then, the pull chain switch can be used.

## FUNCTIONS OF TRANSMITTER:

When you would like to operate ceiling fan by remote controller, you should long press the key, FAN OFF, 3s to code in 10s after the receiver is powered on. The fan has three speed: high, mid, low. In different choose, the lamp has three function: dimmable, non-dimmable with ON/OFF, non-dimmable with timing.

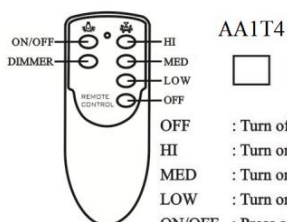

- OFF : Turn off ceiling fan.
- HI : Turn on ceiling fan at high speed.
- MED : Turn on ceiling fan at medium speed.
- LOW : Turn on ceiling fan at low speed.
- ON/OFF : Press and release immediately to turn on or off the light.
- DIMMER : Press and hold to dim or brighten lights to the desired level and release.  
(Only for the tungsten bulb.)

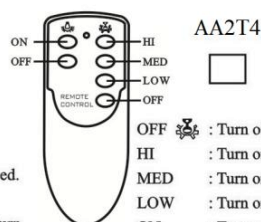

- OFF : Turn off ceiling fan.
- HI : Turn on ceiling fan at high speed.
- MED : Turn on ceiling fan at medium speed.
- LOW : Turn on ceiling fan at low speed.
- ON : Turn on the light.
- OFF : Turn off the light.

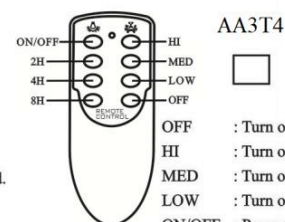

- OFF : Turn off ceiling fan.
- HI : Turn on ceiling fan at high speed.
- MED : Turn on ceiling fan at medium speed.
- LOW : Turn on ceiling fan at low speed.
- ON/OFF : Press and release immediately to turn on or off the light.
- 2H : Light and ceiling fan will turn off in two hours.
- 4H : Light and ceiling fan will turn off in four hours.
- 8H : Light and ceiling fan will turn off in eight hours.



# INSTALLATION INSTRUCTIONS:

**CAUTION: INCORRECT WIRE CONNECTION WOULD DAMAGE THIS RECEIVER.**

1. Ceiling fan must be set at HIGH speed by pulling the "Pull Switch" after installation.
2. For fans that are not drop rod styles (i.e. Flush Mount Styles) the appropriate conversion kit should be used. The fan should be installed and hanging from the ceiling.
3. Make the wiring connection as shown in Fig. 1.1 and 1.2. Its position depends on RF receiving condition. (Fig. 2)

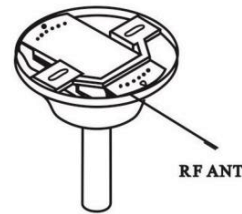
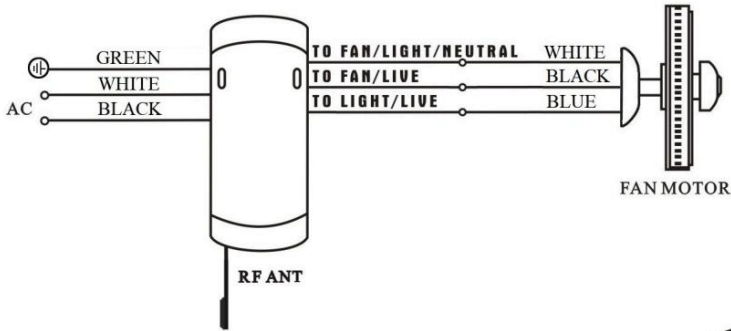

Fig. 1.1



Fig. 2

4. This device contains licence-exempt transmitter(s)/receiver(s) that comply with Innovation, Science and Economic Development Canada's licence-exempt RSS(s). Operation is subject to the following two conditions:
  - (1) This device may not cause interference.
  - (2) This device must accept any interference, including interference that may cause undesired operation of the device.

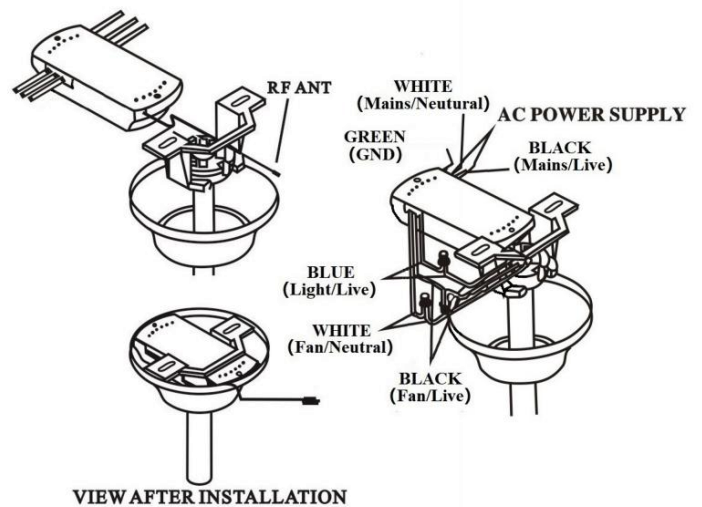

Fig. 1.2

L'émetteur/récepteur exempt de licence contenu dans le présent appareil est conforme aux CNR d'Innovation, Sciences et Développement économique Canada applicables aux appareils radio exempts de licence. L'exploitation est autorisée aux deux conditions suivantes :

- 1) L'appareil ne doit pas produire de brouillage;
- 2) L'appareil doit accepter tout brouillage radioélectrique subi, même si le brouillage est susceptible d'en compromettre le fonctionnement.

5. Once the connection has been made, the receiver inserts into the drop rod hanging bracket. The canopy comes up to cover the receiver and bracket. (Fig. 1.2)
6. To change the batteries is to open the battery housing cover by sliding out the cover downward to the arrow shown direction while pressing down the cover with thumb. (Fig. 3) Holder for transmitter: if desired, install onto the wall with screws. (Fig. 4)

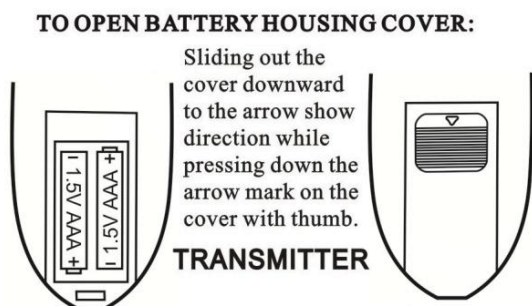

Fig. 3

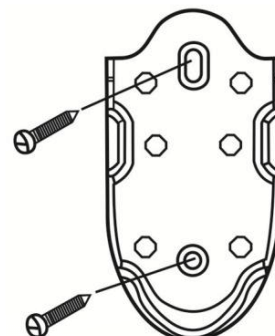

Fig. 4

- The parts:
1. Screw
  2. Enter the wall to expand the colloidal particles
  3. the transmitter cassette

Manufacturer: XIN HUI A.A. ELECTRONICS LTD.

Address: Building No.110, No.1, North of Sanhe Avenue, Xinhui District, Jiangmen, Guangdong, China



# INSTALLATION INSTRUCTION FOR CEILING FAN REMOTE CONTROLLER

MODEL NO. AA2020-3RFA-R/AA2020-3RFB-R-RECEIVER  
AA4T4/AA5T4-TRANSMITTER

## IMPORTANT POINTS:

1. Please read this instruction, and save it for further use.
2. Before installation, TURN OFF THE POWER TO YOUR CEILING FAN (at the main switch box or fuse box).
3. Please note that all wiring appliances should be installed by a qualified electrician.
4. This unit is to be used in a 100V-120V~ 50/60Hz supply only. (Rating: RECEIVER: max.100W, Min.15W for fan motor; max.300W, Min.5W for light kits. TRANSMITTER: Transmitting frequency range:433.92MHZ±300kHz. And the lamp load must used the incandescent light)
5. Do not install in damp locations or immerse in water. (For indoor use only.)
6. Do not pull on or cut leads shorter.
7. Do not drop or bump the unit.
8. PLEASE NOTE: The battery will weaken with age and should be replaced before leaking takes place as this will damage the transmitter.
9. The batteries must be removed from the transmitter before it is scrapped and the batteries shall be disposed of safety.
10. The switch shall be mounted at a height greater than 1.7m.
11. The electric shock protection of the RF receiver shall be depended on its installation.
12. The RF Remote controller shall be used within its rating range, otherwise overheating and dangerous phenomenon may occur.
13. The RF ceiling fan remote controller is made by XIN HUI A.A. ELECTRONICS LTD.
14. CAUTION: To reduce the risk of fire or injury, do not use this product in conjunction with any variable(rheostat) wall control.
15. Warning: Changes or modifications to this unit not expressly approved by the party responsible for compliance could void the user's authority to operate the equipment.
16. This device complies with Part 15 of the FCC Rules. Operation is subject to the following two conditions: (1) this device may not cause harmful interference, and (2) this device must accept any interference received, including interference that may cause undesired operation.
17. NOTE: This equipment has been tested and found to comply with the limits for a Class B digital device, pursuant to Part 15 of the FCC Rules. These limits are designed to provide reasonable protection against harmful interference in a residential installation. This equipment generates uses and can radiate radio frequency energy and, if not installed and used in accordance with the instructions, may cause harmful interference to radio communications.  
However, there is no guarantee that interference will not occur in a particular installation. If this equipment does cause harmful interference to radio or television reception, which can be determined by turning the equipment off and on, the user is encouraged to try to correct the interference by one or more of the following measures:
  - Reorient or relocate the receiving antenna.
  - Increase the separation between the equipment and receiver.
  - Connect the equipment into an outlet on a circuit different from that to which the receiver is connected.
  - Consult the dealer or an experienced radio/TV technician for help.

## OPERATION INSTRUCTIONS:

1. Two methods are provided to control fan operation: (a) control by pull chain switch (b) control by remote controller
- 2.(a) Use pull chain switch to control the fan operation: Before using pull chain switch, set Fan Speed to "HIGH" position on the remote controller.
- 3.(b)Use remote controller to control the fan operation:
  - 3.1 Before using remote controller, pull chain switch, set Fan Speed to "HIGH" position
  - 3.2 Your remote controller is ready for use after battery installation.
4. Once the remote controller is missing or damaged and pull chain switch can not perform its function, do as the following:
  - (a) Turn off the master supply at the circuit breaker or fuse box.
  - (b) Remove the receiver and connect the wires according to the fan installation instruction. Then, the pull chain switch can be used.

## FUNCTIONS OF TRANSMITTER:

When you would like to operate ceiling fan by remote controller, you should long press the key, FAN OFF, 3s to code in 10s after the receiver is powered on. The fan has three speed: high, mid, low. In different choose, the lamp has three function: dimmable, non-dimmable with ON/OFF, non-dimmable with timing.

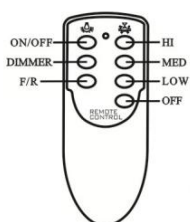

AA4T4

- OFF : Turn off ceiling fan.
- HI : Turn on ceiling fan at high speed.
- MED : Turn on ceiling fan at medium speed.
- LOW : Turn on ceiling fan at low speed.
- ON/OFF : Press and release immediately to turn on or off the light.
- DIMMER : Press and hold to dim or brighten lights to the desired level and release.  
(Only for the tungsten bulb.)
- F/R : Change the speed direction of ceiling fan

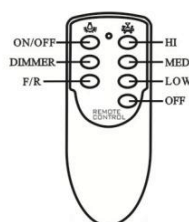

AA5T4

- OFF : Turn off ceiling fan.
- HI : Turn on ceiling fan at high speed.
- MED : Turn on ceiling fan at medium speed.
- LOW : Turn on ceiling fan at low speed.
- ON : Turn on the light.
- OFF : Turn off the light.
- F/R : Change the speed direction of ceiling fan



# INSTALLATION INSTRUCTIONS:

**CAUTION: INCORRECT WIRE CONNECTION WOULD DAMAGE THIS RECEIVER.**

1. Ceiling fan must be set at HIGH speed by pulling the "Pull Switch" after installation.
2. For fans that are not drop rod styles (i.e. Flush Mount Styles) the appropriate conversion kit should be used. The fan should be installed and hanging from the ceiling.
3. Make the wiring connection as shown in Fig. 1.1 and 1.2. Its position depends on RF receiving condition. (Fig. 2)

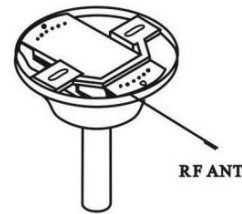
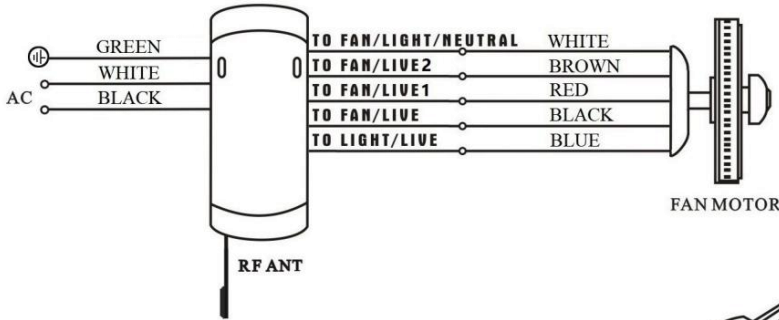

Fig. 1.1



Fig. 2

4. This device contains licence-exempt transmitter(s)/receiver(s) that comply with Innovation, Science and Economic Development Canada's licence-exempt RSS(s). Operation is subject to the following two conditions:
  - (1) This device may not cause interference.
  - (2) This device must accept any interference, including interference that may cause undesired operation of the device.

L'émetteur/récepteur exempt de licence contenu dans le présent appareil est conforme aux CNR d'Innovation, Sciences et Développement économique Canada applicables aux appareils radio exempts de licence. L'exploitation est autorisée aux deux conditions suivantes :

- 1) L'appareil ne doit pas produire de brouillage;
- 2) L'appareil doit accepter tout brouillage radioélectrique subi, même si le brouillage est susceptible d'en compromettre le fonctionnement.

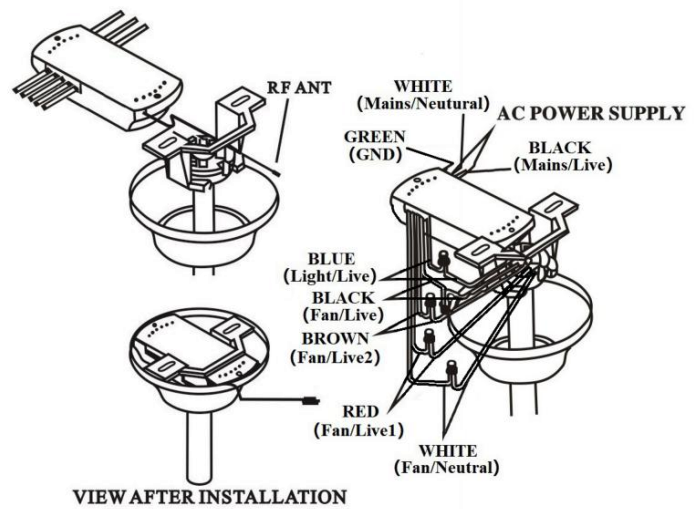

Fig. 1.2

5. Once the connection has been made, the receiver inserts into the drop rod hanging bracket. The canopy comes up to cover the receiver and bracket. (Fig. 1.2)
6. To change the batteries is to open the battery housing cover by sliding out the cover downward to the arrow shown direction while pressing down the cover with thumb. (Fig. 3) Holder for transmitter: if desired, install onto the wall with screws. (Fig. 4)

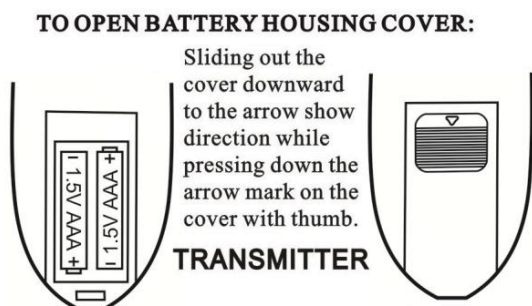

Fig. 3

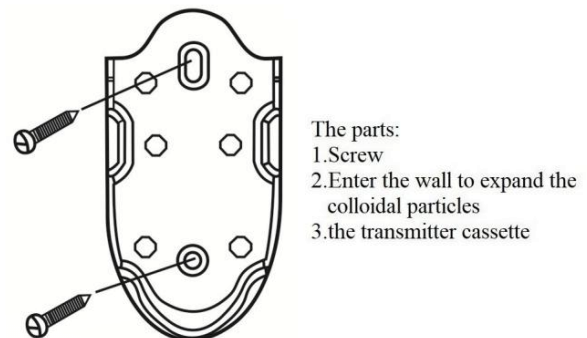

Fig. 4

Manufacturer: XIN HUI A.A. ELECTRONICS LTD.

Address: Building No.110, No.1, North of Sanhe Avenue, Xinhui District, Jiangmen, Guangdong, China



# INSTALLATION INSTRUCTION FOR CEILING FAN REMOTE CONTROLLER

MODEL NO. AA2020-3RFA/AA2020-3RFB/AA2020-3RFD-RECEIVER  
DD1T4/DD2T4/DD3T4-TRANSMITTER

## IMPORTANT POINTS:

1. Please read this instruction, and save it for further use.
  2. Before installation, TURN OFF THE POWER TO YOUR CEILING FAN (at the main switch box or fuse box).
  3. Please note that all wiring appliances should be installed by a qualified electrician.
  4. This unit is to be used in a 100V-120V~ 50/60Hz supply only. (Rating: RECEIVER: max.100W, Min.15W for fan motor; max.300W, Min.5W for light kits. TRANSMITTER: Transmitting frequency range:433.92MHZ±300kHz. And the lamp load must used the incandescent light)
  5. Do not install in damp locations or immerse in water. (For indoor use only.)
  6. Do not pull on or cut leads shorter.
  7. Do not drop or bump the unit.
  8. PLEASE NOTE: The battery will weaken with age and should be replaced before leaking takes place as this will damage the transmitter.
  9. The batteries must be removed from the transmitter before it is scrapped and the batteries shall be disposed of safety.
  10. The switch shall be mounted at a height greater than 1.7m.
  11. The electric shock protection of the RF receiver shall be depended on its installation.
  12. The RF Remote controller shall be used within its rating range, otherwise overheating and dangerous phenomenon may occur.
  13. The RF ceiling fan remote controller is made by XIN HUI A.A. ELECTRONICS LTD.
  14. CAUTION: To reduce the risk of fire or injury, do not use this product in conjunction with any variable(rheostat) wall control.
  15. Warning: Changes or modifications to this unit not expressly approved by the party responsible for compliance could void the user's authority to operate the equipment.
  16. This device complies with Part 15 of the FCC Rules. Operation is subject to the following two conditions: (1) this device may not cause harmful interference, and (2) this device must accept any interference received, including interference that may cause undesired operation.
  17. NOTE: This equipment has been tested and found to comply with the limits for a Class B digital device, pursuant to Part 15 of the FCC Rules. These limits are designed to provide reasonable protection against harmful interference in a residential installation. This equipment generates uses and can radiate radio frequency energy and, if not installed and used in accordance with the instructions, may cause harmful interference to radio communications.
- However, there is no guarantee that interference will not occur in a particular installation. If this equipment does cause harmful interference to radio or television reception, which can be determined by turning the equipment off and on, the user is encouraged to try to correct the interference by one or more of the following measures:
- Reorient or relocate the receiving antenna.
  - Increase the separation between the equipment and receiver.
  - Connect the equipment into an outlet on a circuit different from that to which the receiver is connected.
  - Consult the dealer or an experienced radio/TV technician for help.

## OPERATION INSTRUCTIONS:

1. Two methods are provided to control fan operation: (a) control by pull chain switch (b) control by remote controller
- 2.(a) Use pull chain switch to control the fan operation: Before using pull chain switch, set Fan Speed to "HIGH" position on the remote controller.
- 3.(b)Use remote controller to control the fan operation:
  - 3.1 Before using remote controller, pull chain switch, set Fan Speed to "HIGH" position
  - 3.2 Your remote controller is ready for use after battery installation.
4. Once the remote controller is missing or damaged and pull chain switch can not perform its function, do as the following:
  - (a) Turn off the master supply at the circuit breaker or fuse box.
  - (b) Remove the receiver and connect the wires according to the fan installation instruction. Then, the pull chain switch can be used.

## FUNCTIONS OF TRANSMITTER:

When you would like to operate ceiling fan by remote controller, you should long press the key, FAN OFF, 3s to code in 10s after the receiver is powered on. The fan has three speed: high, mid, low. In different choose, the lamp has three function: dimmable, non-dimmable with ON/OFF, non-dimmable with timing.

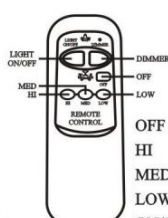
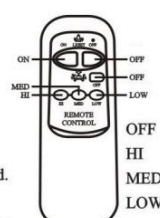
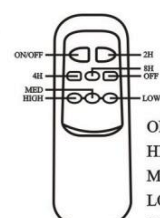
 <p style="text-align: center;"><b>DD1T4</b></p> <p>OFF : Turn off ceiling fan.          HI : Turn on ceiling fan at high speed.          MED : Turn on ceiling fan at medium speed.          LOW : Turn on ceiling fan at low speed.          ON/OFF : Press and release immediately to turn on or off the light.          DIMMER : Press and hold to dim or brighten lights to the desired level and release.          (Only for the tungsten bulb.)</p>	 <p style="text-align: center;"><b>DD2T4</b></p> <p>OFF : Turn off ceiling fan.          HI : Turn on ceiling fan at high speed.          MED : Turn on ceiling fan at medium speed.          LOW : Turn on ceiling fan at low speed.          ON : Turn on the light.          OFF : Turn off the light.</p>	 <p style="text-align: center;"><b>DD3T4</b></p> <p>OFF : Turn off ceiling fan.          HI : Turn on ceiling fan at high speed.          MED : Turn on ceiling fan at medium speed.          LOW : Turn on ceiling fan at low speed.          ON/OFF : Press and release immediately to turn on or off the light.          2H : Light and ceiling fan will turn off in two hours.          4H : Light and ceiling fan will turn off in four hours.          8H : Light and ceiling fan will turn off in eight hours.</p>
---	--	--



# INSTALLATION INSTRUCTIONS:

**CAUTION: INCORRECT WIRE CONNECTION WOULD DAMAGE THIS RECEIVER.**

1. Ceiling fan must be set at HIGH speed by pulling the "Pull Switch" after installation.
2. For fans that are not drop rod styles (i.e. Flush Mount Styles) the appropriate conversion kit should be used. The fan should be installed and hanging from the ceiling.
3. Make the wiring connection as shown in Fig. 1.1 and 1.2. Its position depends on RF receiving condition. (Fig. 2)

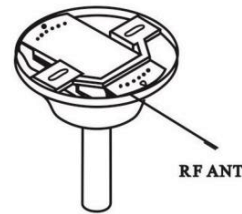
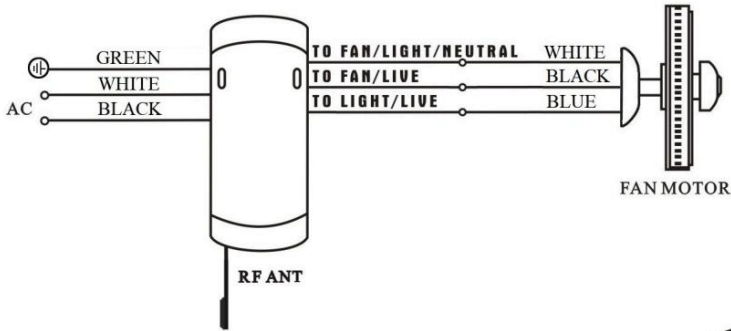
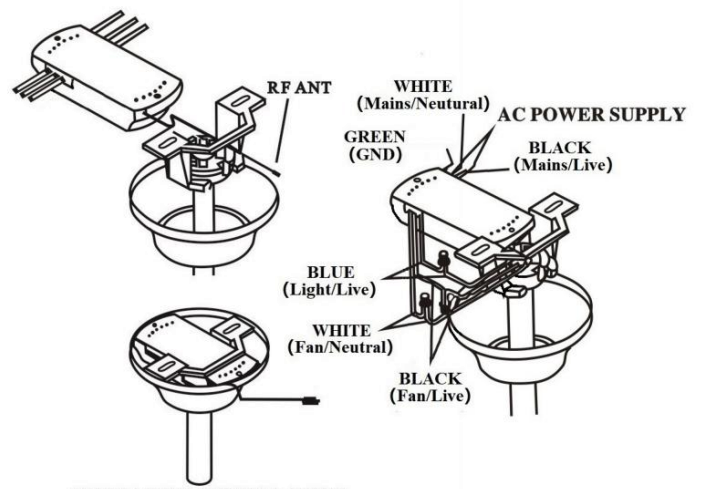

Fig. 1.1



Fig. 2

4. This device contains licence-exempt transmitter(s)/receiver(s) that comply with Innovation, Science and Economic Development Canada's licence-exempt RSS(s). Operation is subject to the following two conditions:
  - (1) This device may not cause interference.
  - (2) This device must accept any interference, including interference that may cause undesired operation of the device.



VIEW AFTER INSTALLATION

Fig. 1.2

L'émetteur/récepteur exempt de licence contenu dans le présent appareil est conforme aux CNR d'Innovation, Sciences et Développement économique Canada applicables aux appareils radio exempts de licence. L'exploitation est autorisée aux deux conditions suivantes :

- 1) L'appareil ne doit pas produire de brouillage;
- 2) L'appareil doit accepter tout brouillage radioélectrique subi, même si le brouillage est susceptible d'en compromettre le fonctionnement.

5. Once the connection has been made, the receiver inserts into the drop rod hanging bracket. The canopy comes up to cover the receiver and bracket. (Fig. 1.2)
6. To change the batteries is to open the battery housing cover by sliding out the cover downward to the arrow shown direction while pressing down the cover with thumb. (Fig. 3) Holder for transmitter: if desired, install onto the wall with screws. (Fig. 4)

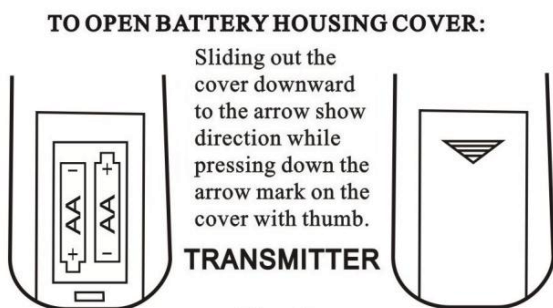

Fig. 3

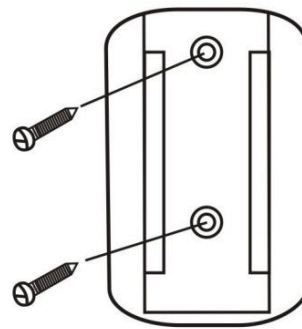

Fig. 4

- The parts:
1. Screw
  2. Enter the wall to expand the colloidal particles
  3. the transmitter cassette



# INSTALLATION INSTRUCTION FOR CEILING FAN REMOTE CONTROLLER

MODEL NO. AA2020-3RFA-R/AA2020-3RFB-R-RECEIVER  
DD4T4/DD5T4-TRANSMITTER

## IMPORTANT POINTS:

1. Please read this instruction, and save it for further use.
2. Before installation, TURN OFF THE POWER TO YOUR CEILING FAN (at the main switch box or fuse box).
3. Please note that all wiring appliances should be installed by a qualified electrician.
4. This unit is to be used in a 100V-120V~ 50/60Hz supply only. (Rating: RECEIVER: max.100W, Min.15W for fan motor; max.300W, Min.5W for light kits. TRANSMITTER: Transmitting frequency range:433.92MHZ±300kHz. And the lamp load must used the incandescent light)
5. Do not install in damp locations or immerse in water. (For indoor use only.)
6. Do not pull on or cut leads shorter.
7. Do not drop or bump the unit.
8. PLEASE NOTE: The battery will weaken with age and should be replaced before leaking takes place as this will damage the transmitter.
9. The batteries must be removed from the transmitter before it is scrapped and the batteries shall be disposed of safety.
10. The switch shall be mounted at a height greater than 1.7m.
11. The electric shock protection of the RF receiver shall be depended on its installation.
12. The RF Remote controller shall be used within its rating range, otherwise overheating and dangerous phenomenon may occur.
13. The RF ceiling fan remote controller is made by XIN HUI A.A. ELECTRONICS LTD.
14. CAUTION: To reduce the risk of fire or injury, do not use this product in conjunction with any variable(rheostat) wall control.
15. Warning: Changes or modifications to this unit not expressly approved by the party responsible for compliance could void the user's authority to operate the equipment.
16. This device complies with Part 15 of the FCC Rules. Operation is subject to the following two conditions: (1) this device may not cause harmful interference, and (2) this device must accept any interference received, including interference that may cause undesired operation.
17. NOTE: This equipment has been tested and found to comply with the limits for a Class B digital device, pursuant to Part 15 of the FCC Rules. These limits are designed to provide reasonable protection against harmful interference in a residential installation. This equipment generates uses and can radiate radio frequency energy and, if not installed and used in accordance with the instructions, may cause harmful interference to radio communications.  
However, there is no guarantee that interference will not occur in a particular installation. If this equipment does cause harmful interference to radio or television reception, which can be determined by turning the equipment off and on, the user is encouraged to try to correct the interference by one or more of the following measures:
  - Reorient or relocate the receiving antenna.
  - Increase the separation between the equipment and receiver.
  - Connect the equipment into an outlet on a circuit different from that to which the receiver is connected.
  - Consult the dealer or an experienced radio/TV technician for help.

## OPERATION INSTRUCTIONS:

1. Two methods are provided to control fan operation: (a) control by pull chain switch (b) control by remote controller
- 2.(a) Use pull chain switch to control the fan operation: Before using pull chain switch, set Fan Speed to "HIGH" position on the remote controller.
- 3.(b)Use remote controller to control the fan operation:
  - 3.1 Before using remote controller, pull chain switch, set Fan Speed to "HIGH" position
  - 3.2 Your remote controller is ready for use after battery installation.
4. Once the remote controller is missing or damaged and pull chain switch can not perform its function, do as the following:
  - (a) Turn off the master supply at the circuit breaker or fuse box.
  - (b) Remove the receiver and connect the wires according to the fan installation instruction. Then, the pull chain switch can be used.

## FUNCTIONS OF TRANSMITTER:

When you would like to operate ceiling fan by remote controller, you should long press the key, FAN OFF, 3s to code in 10s after the receiver is powered on. The fan has three speed: high, mid, low. In different choose, the lamp has three function: dimmable, non-dimmable with ON/OFF, non-dimmable with timing.

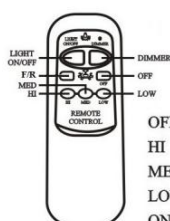

DD4T4

- OFF : Turn off ceiling fan.
- HI : Turn on ceiling fan at high speed.
- MED : Turn on ceiling fan at medium speed.
- LOW : Turn on ceiling fan at low speed.
- ON/OFF : Press and release immediately to turn on or off the light.
- DIMMER : Press and hold to dim or brighten lights to the desired level and release.  
(Only for the tungsten bulb.)
- F/R : Change the speed direction of ceiling fan

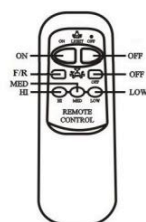

DD5T4

- OFF : Turn off ceiling fan.
- HI : Turn on ceiling fan at high speed.
- MED : Turn on ceiling fan at medium speed.
- LOW : Turn on ceiling fan at low speed.
- ON : Turn on the light.
- OFF : Turn off the light.
- F/R : Change the speed direction of ceiling fan



# INSTALLATION INSTRUCTIONS:

**CAUTION: INCORRECT WIRE CONNECTION WOULD DAMAGE THIS RECEIVER.**

1. Ceiling fan must be set at HIGH speed by pulling the “Pull Switch” after installation.
2. For fans that are not drop rod styles (i.e. Flush Mount Styles) the appropriate conversion kit should be used. The fan should be installed and hanging from the ceiling.
3. Make the wiring connection as shown in Fig. 1.1 and 1.2. Its position depends on RF receiving condition. (Fig. 2)

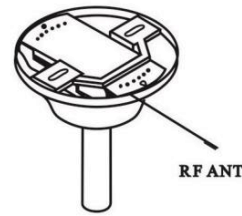
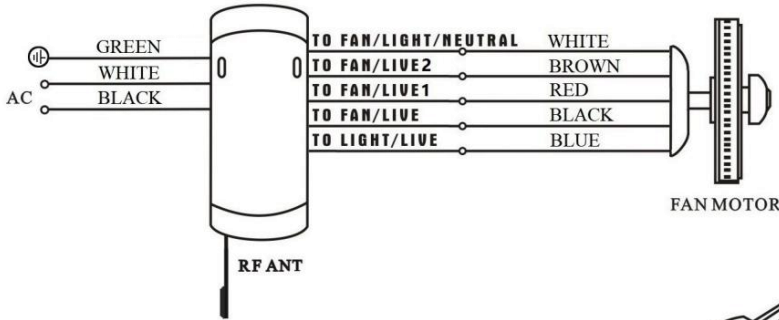

Fig. 1.1



Fig. 2

4. This device contains licence-exempt transmitter(s)/receiver(s) that comply with Innovation, Science and Economic Development Canada’s licence-exempt RSS(s). Operation is subject to the following two conditions:
  - (1) This device may not cause interference.
  - (2) This device must accept any interference, including interference that may cause undesired operation of the device.

L’émetteur/récepteur exempt de licence contenu dans le présent appareil est conforme aux CNR d’Innovation, Sciences et Développement économique Canada applicables aux appareils radio exempts de licence. L’exploitation est autorisée aux deux conditions suivantes :

- 1) L’appareil ne doit pas produire de brouillage;
- 2) L’appareil doit accepter tout brouillage radioélectrique subi, même si le brouillage est susceptible d’en compromettre le fonctionnement.

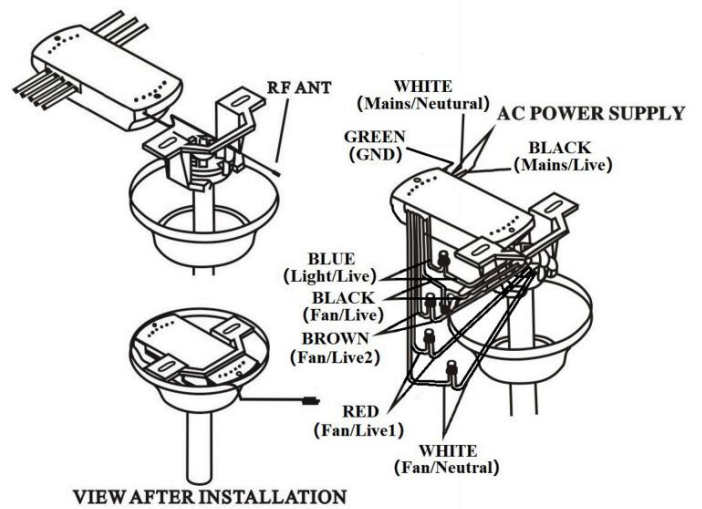

Fig. 1.2

5. Once the connection has been made, the receiver inserts into the drop rod hanging bracket. The canopy comes up to cover the receiver and bracket. (Fig. 1.2)
6. To change the batteries is to open the battery housing cover by sliding out the cover downward to the arrow shown direction while pressing down the cover with thumb. (Fig. 3) Holder for transmitter: if desired, install onto the wall with screws. (Fig. 4)

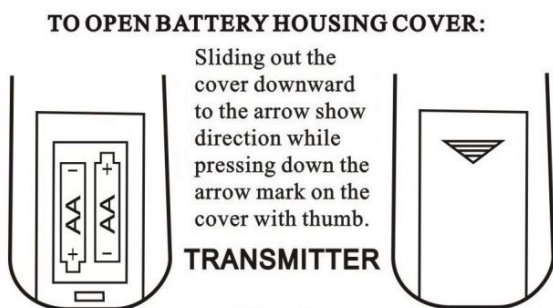

Fig. 3

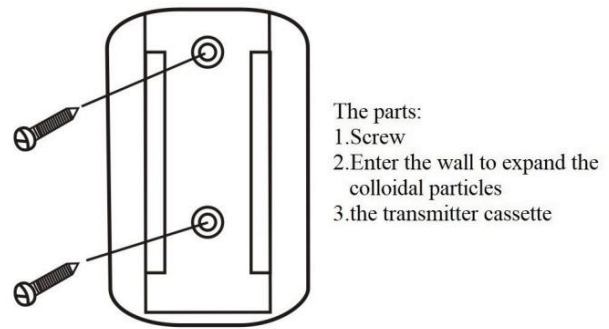

Fig. 4