

M-600

Professional 4 Channel Wireless System



Safety Instructions



CAUTION: To reduce the risk of electric shock, do not remove cover (or back). No user-serviceable parts inside. Only refer servicing to qualified service personnel.

Explanation of Graphical Symbols



The lightning flash & arrowhead symbol, within an equilateral triangle, is intended to alert you to the presence of danger.



The exclamation point within an equilateral triangle is intended to alert you to the presence of important operating and servicing instructions.

WARNING

To reduce the risk of fire or electric shock, do not expose this unit to rain or moisture.

- 1. Read Instructions** - All the safety and operating instructions should be read before the appliance is operated.
- 2. Retain Instructions** - The safety and operating instructions should be retained for future reference.
- 3. Heed Warnings** - All warnings on the appliance and in the operating instructions should be adhered to.
- 4. Follow Instructions** - All operating and use instructions should be followed.
- 5. Attachments** - Do not use attachments not recommended by the product manufacturer as they may cause hazards.
- 6. Water and Moisture** - Do not use this unit near water. For example, near a bathtub or in a wet basement and the like.
- 7. Carts and Stands** - The appliance should be used only with a cart or stand that is recommended by the manufacturer.
- 7 A.** An appliance and cart combination should be moved with care. Quick stops, excessive force, and uneven surfaces may cause an overturn.
- 8. Ventilation** - The appliance should be situated so its

location does not interfere with its proper ventilation. For example, the appliance should not be situated on a bed, sofa, rug, or similar surface that may block the ventilation slots.

- 9. Heat** - The appliance should be situated away from heat sources such as radiators, heat registers, stoves, or other appliances (including amplifiers) that produce heat.
- 10. Power Sources** - The appliance should be connected to a power supply only of the type described in the operating instructions or as marked on the appliance.
- 11. Grounding or Polarization** - Precautions should be taken so that the grounding or polarization means of an appliance is not defeated.
- 12. Power-Cord Protection** - Power-supply cords should be routed so that they are not likely to be walked on or pinched by items placed upon or against them, paying particular attention to cords at plugs, convenience receptacles, and the point where they exit from the appliance.
- 13. Cleaning** - Unplug this unit from the wall outlet before cleaning. Do not use liquid cleaners or aerosol cleaners. Use a damp cloth for cleaning.
- 14. Power lines** - An outdoor antenna should be located away from power lines.
- 15. Nonuse Periods** - The power cord of the appliance should be unplugged from the outlet when left unused for a long period of time.
- 16. Object and Liquid Entry** - Care should be taken so that objects do not fall and liquids are not spilled into the enclosure through openings.
- 17. Damage Requiring Service** - The appliance should be serviced by qualified service personnel when:
 - A. The power supply cord or plug has been damaged; or
 - B. Objects have fallen into the appliance; or
 - C. The appliance has been exposed to rain; or
 - D. The appliance does not appear to operate normally or exhibits a marked change in performance; or
 - E. The appliance has been dropped, or the enclosure damaged.
- 18. Servicing** - The user should not attempt to service the appliance beyond that described in the operating instructions. All other servicing should be referred to qualified service personnel.

NOTE:

To CATV system installer's (U.S.A.): This reminder is provided to call the CATV system installer's attention to Article 820-40 of the NEC that provides guidelines for proper grounding and, in particular, specifies that the cable ground shall be connected as close to the point of cable entry as practical.



Welcome....

And thank you for purchasing the M-600 from VocoPro, your ultimate choice in Karaoke entertainment! With years of experience in the music entertainment business, VocoPro is a leading manufacturer of Karaoke equipment, and has been providing patrons of bars, churches, schools, clubs and individual consumers the opportunity to sound like a star with full-scale club models, in-home systems and mobile units. All our products offer solid performance and sound reliability, and to further strengthen our commitment to customer satisfaction, we have customer service and technical support professionals ready to assist you with your needs. We have provided some contact information for you below.

FOR YOUR RECORDS

Please record the model number and serial number below, for easy reference, in case of loss or theft. These numbers are located on the rear panel of the unit. Space is also provided for other relevant information

Model Number _____

Serial Number _____

Date of Purchase _____

Place of Purchase _____

Listening For A Lifetime

Selecting fine audio equipment such as the unit you've just purchased is only the start of your musical enjoyment. Now it's time to consider how you can maximize the fun and excitement your equipment offers. the Electronic Industries Association's Consumer Electronics Group want you to get the most out of your equipment by playing it at a safe level. One that lets the sound come through loud and clear without annoying blaring or distortion and, most importantly, without affecting your sensitive hearing.

Sound can be deceiving. Over time your hearing "comfort level" adapts to a higher volume of sound. So what sounds "normal" can actually be loud and harmful to your hearing. Guard against this by setting your equipment at a safe level BEFORE your hearing adapts.

To establish a safe level:

- Start your volume control at a low setting.
- Slowly increase the sound until you can hear it comfortably and clearly, and without distortion.

Once you have established a comfortable sound level:

- Set the dial and leave it there.
- Pay attention to the different levels in various recordings.

Taking a minute to do this now will help to prevent hearing damage or loss in the future. After all, we want you listening for a lifetime.

Used wisely, your new sound equipment will provide a lifetime of fun and enjoyment. Since hearing damage from loud noise is often undetectable until it is too late, this manufacturer and the Electronic Industries Association's Consumer Electronics Group recommend you avoid prolonged exposure to excessive noise. This list of sound levels is included for your protection.

Some common decibel ranges:

<i>Level</i>	<i>Example</i>
30	Quiet library, Soft whispers
40	Living room, Refrigerator, Bedroom away from traffic
50	Light traffic, Normal Conversation
60	Air Conditioner at 20 ft., Sewing machine
70	Vacuum cleaner, Hair dryer, Noisy Restaurant
80	Average city traffic, Garbage disposals, Alarm clock at 2 ft.

The following noises can be dangerous under constant exposure:

<i>Level</i>	<i>Example</i>
90	Subway, Motorcycle, Truck traffic, Lawn Mower
100	Garbage truck, Chainsaw, Pneumatics drill
120	Rock band concert in front of speakers
140	Gunshot blast, Jet plane
180	Rocket launching pad

-Information courtesy of the Deafness Research Foundation

M-600

Professional 4 Channel Wireless System

Table of Contents

Cautions and Warnings	2
Welcome	3
Listening for a Lifetime	4
Features	5
Microphone Basics	6
Microphone Placement and Tone Quality	6
VHF-4808 & Stage Monitor/P.A. Loudspeakers	6
Receiver Descriptions and Controls	7
Microphone Descriptions and Controls	8
Getting Connected	9
Maintenance Procedures	10
Operations	11
Tips for Achieving Optimum Performance	12-13
Troubleshooting	14
Specifications	15

Features

- Dual Antenna Receiver Design
- Squelch Circuitry Eliminates Background and RF Noise Bursts
- VHF Band (174.2 MHz - 215.8 MHz) Quartz Lock for Drift-free Operation
- Audio-Mute Circuitry Provides Noiseless On/Off Switching
- Individual Front Panel Volume Controls
- Outputs: 1/4" Unbalanced (2), XLR-TRS Balanced (1)
- Excellent Operating Range to 150 Ft.
- Low-Battery Indicators
- Individual Front Panel RF Indicator LED's

INCLUDES:

- RF Receiver (1)
- Handheld Microphones (3)
- Headset Transmitter (1)
- Headset Microphone (1)
- 9V Battery (1)
- AA 1.5V Batteries (6)
- RF Antennas (2)
- Mounting Brackets (2)
- Bracket Screws (6)
- 1/4" to 1/4" Cables (2)
- AC Power Cable (1)
- Metal Carrying Case (1)

Microphone Basics

Microphone Position

The M-600 is ideal for close-up and stage vocals, and can be held in the hand or mounted on a mic stand. The most common applications and placement techniques are listed below. Keep in mind that microphone technique is largely a matter of personal taste—there is no one “correct” microphone position.

Proximity Effect

When the sound source is less than 1/4” from the microphone, the microphone boosts bass frequencies (by 6 to 10 dB at 100 Hz), creating a warmer and richer bass sound than when farther away. This effect, known as the proximity effect, happens only in unidirectional dynamic microphones like the M-600.

Feedback

Feedback occurs when the amplified sound from any loudspeaker reenters the sound system through any open microphone and is amplified again and again and again. Most commonly, feedback is caused by the following conditions: placing loudspeakers too close to the microphones, having too many open active microphones, boosting tone controls indiscriminately (mainly treble) and performing in areas with high ratios of room surfaces that have hard and reflective surfaces such as glass, marble and wood.

What to do if feedback occurs before the sound system is loud enough?

- Request the talker to speak louder into the microphone.
- Reduce the distance from the talker to the microphone. Each time this distance is halved, the sound system output will increase by 6dB.
- Reduce the number of open microphones.
- Move the loudspeaker farther away from the microphone.
- Move the loudspeaker closer to the listener.
- Use an equalizer/feedback reducer to cut the frequency bands in which the feedback occurs.

Microphone Placement & Tone Quality

Lead & Backup Vocals

Lips should be less than 3” from or even touching the windscreen on an axis to the microphone. Doing this creates a robust sound, emphasizes bass and provides maximum isolation from other sources.

Speech

When giving a speech or simply speaking, place the microphone 4” to 10” away from the mouth, just above nose height for a natural sound with reduced bass. You can also place the microphone 8” to 16” away from the mouth, slightly off to one side, for a more “distant” sound with highly reduced bass and a minimal need for “de-essing”.

If you will be using the M-600 with stage monitors and/or a P.A. system, try the following:

- Place the stage monitor directly behind the microphones.
- Locate the P.A. loudspeakers so that they point away from the rear of the microphone. (With the speakers located in these positions, the possibility of feedback is greatly reduced).
- Always check the stage setup before a performance to ensure optimum placement of microphone and monitors.

IMPORTANT: Every wireless microphone installation is a unique situation, and can present a variety of problems. Whenever possible, avoid performing a live performance without first conducting a “walkthrough” test of the system in the performing area. If major changes (additional wireless systems or intercoms, relocation of scenery, etc.) have been made since the last walkthrough, check the wireless system again, as close to performance time as possible.

Receiver Description and Controls

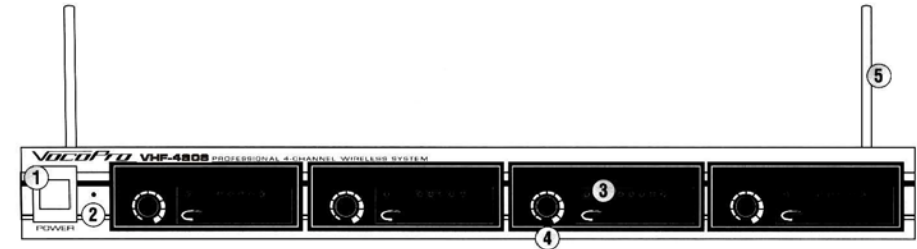

1. **POWER** button: Turns the M-600 ON/OFF.
2. **POWER (LED)**: Glows BLUE when the receiver is powered ON.
3. **RF (LED)**: Lights RED when RF signals are received from the microphone channels.
4. **VOLUME** controls: Adjusts the individual VOLUME of the receiver's 4 microphone channels.
5. **TELESCOPING ANTENNAS**: Provides RF SIGNAL reception.
6. **AUDIO OUT 1 & 2**: Two 1/4" unbalanced and 1 XLR OUTPUT jacks for connection to amplifiers or mixers. For separated HEADSET output, connect both 1/4" jacks to your mixer.
7. **POWER** input: MAINS POWER jack for connection to a compatible AC outlet.
8. **SQUELCH** controls: Manual controls for controlling each microphones signal strength for best performance. Turn clockwise to increase SQUELCH application. Turn counter-clockwise to decrease SQUELCH application.



Microphone Description and Controls

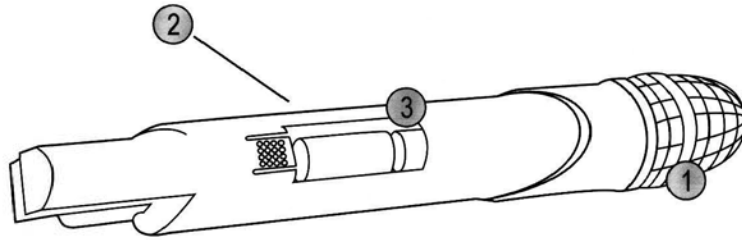

- GRILL:** Protects the microphone cartridge and helps reduce "breathy" and wind noise pick-up.
- POWER switch (Not Shown):** Used to turn the microphone ON/OFF or put it in STANDBY mode.
- BATTERY COMPARTMENT LID:** Removable lid hides and protects the microphone battery.

Mounting

To install the M-600 to a 19" rack case, complete the steps below.

- Attach mounting brackets to the M-600 via the supplied mounting screws.
- Align the M-600 with desired space in rack and slide in slowly, rear panel first **NOTE:** Depending on your rack case design, it may be necessary to allow for sufficient space for the antennas.
- While aligned, use rack case screws to stabilize the M-600 in its space (See diagram right).

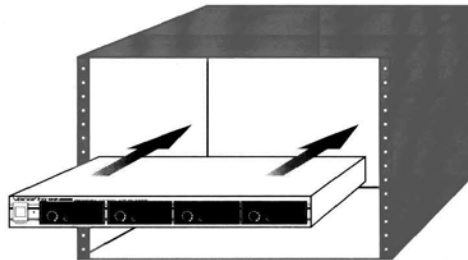

Getting Connected

System Connection

- Connect the AC POWER ADAPTER to the M-600 receiver's POWER INPUT connector; then plug the ADAPTER into a compatible AC electrical outlet.

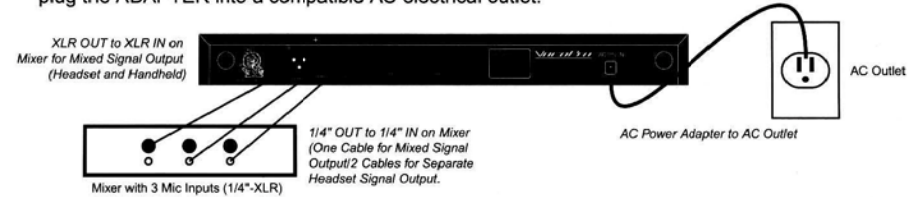

- Connect the M-600 receiver to a sound system, mixer or amplifier's microphone input(s) with either one 1/4" output jack for a mixed channel output (3 handheld), or both 1/4" output jacks for separate outputs (3 handheld/1 headset).

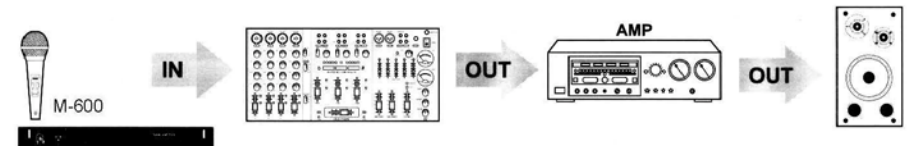

Separated or Mixed Output

Deciding on separate or mixed output is a matter of necessity. If there is going to be no dry announcements to make, or no KJ/DJ mic requirements, you would only need to go mixed, as the headset mic requires a second mic jack to separate itself from the mix.

	PROS	CONS
Mixed Channel Output be channel	Uses only 1 mic input on an external Mixer/Amplifier	External mic adjustments cannot be applied to just one mic
Separate Channel Output	External mic adjustments can be applied on one or both mic channels	Uses 2 mic inputs on an external Mixer/Amplifier

Antenna Connection

- Insert the ANTENNA's BNC connector into the BNC jack and twist counter-clockwise till it locks into place.



Headset Connection

- Connect the 1/8" mini-plug from the headset to the 1/8" mini-jack on the headset receiver.

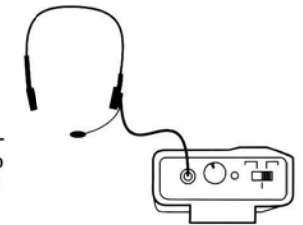

Maintenance Procedures

Headset Receiver Battery Installation

1. Remove the BATTERY COMPARTMENT LID on the headset receiver by gently pushing down in an outward manner.
2. Insert 1 fresh 9V alkaline battery.
3. Replace the BATTERY COMPARTMENT LID by pushing gently on the lid till it "clicks" into place.

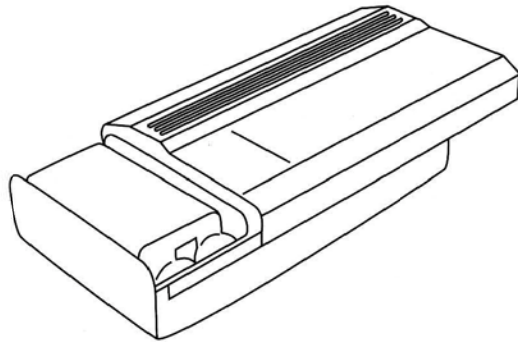

Handheld Microphone Battery Installation

1. Slide the microphone's BATTERY COMPARTMENT LID located at the bottom of the microphone.
2. Insert 2 fresh 1.5 volt alkaline BATTERIES, being sure to observe proper battery polarity (+/-).
3. Close the BATTERY COMPARTMENT LID.

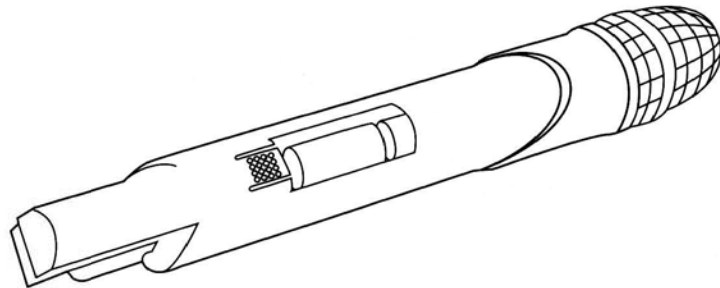

Operations

1. Press the POWER button on the M-600 receiver's front panel. The power LED on the receiver will glow BLUE.
2. Adjust the receiver's VOLUME controls to approximately 50%.
3. Switch the microphone's POWER BUTTONS to the ON positions.
4. Talk or sing into the microphones. During normal operation the RF signal LED's will light GREEN when a microphone is being used.
5. Adjust the receiver's VOLUME controls until the output levels are balanced with each other and other possible source output i.e. CD+G tracks. In most cases, the VOLUME controls should be set to +/-75%.
6. If noise is present in the microphone output, squelch adjustments should be made at this time. (See below for more information on squelch circuitry).

Individual Manual Squelch Controls

Squelch circuits analyze RF signal strength. When a wireless system is used in a noisy RF environments, conventional circuits may "open" unexpectedly, sending loud bursts of noise through the receiver when the transmitter's signal is weak or turned off. The M-600 uses a noise squelch circuit that analyzes signal quality with the signal strength. When the transmitter signal is strong, the system's noise level is low and the receiver sends audio through. When the transmitter signal is weak or absent, the system's noise level is high and the squelch circuit will mute the receiver. This virtually eliminates the possibility of annoying bursts of noise coming through your receiver.

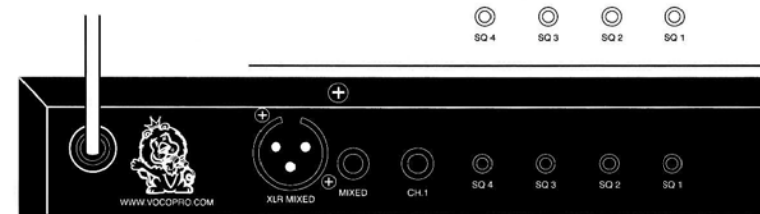

Receiver Volume Adjustment

The VOLUME controls on the front panel of the M-600 receiver can be adjusted to set the wireless system output levels as you desire. After making any musical balancing adjustments, adjust the receiver volume control until the output reaches the desired level. Rotate the volume control clockwise to increase output. Rotate it counterclockwise to decrease output.

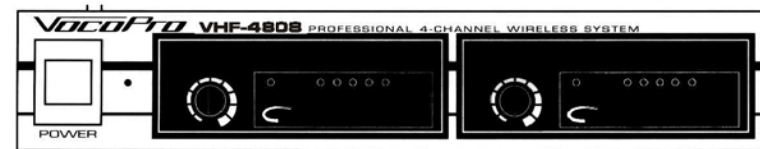

Tips for Achieving Optimal Performance

Recognizing Interference

The ways of recognizing the type of interference present are observing the RF LED indications and carefully listening to the audio output. A set of headphones can be a useful tool in isolating and analyzing interference problems. With headphones it is easier to listen to one wireless channel at a time, even when the system is in use.

Below are some interference descriptions. Most likely there is one that matches the symptoms that you are experiencing.

- If there is interference when the microphones are off, and noise/distortion is present from the receiver output when the microphones are on, try turning off all other wireless microphones. If the interference problem is still present, there might be a direct radio interference problem. Direct interference is a serious problem that must be corrected in order for the wireless system to be fully usable.
- Interference in the form of low level-audio tones, whines, whining sounds whose pitch changes rapidly, or audible voices or music (distorted or not) is likely to be caused by intermodulation, non-wireless interference or direct interference.
- If there is interference when the receiver is turned on, in the form of buzzy or raspy whines with a distinct cadence or rhythm that differs from time to time, digital interference might be the problem. Common sources include computers, digital delays, effects processors, lighting controllers, and other digital equipment using microprocessors and digital signal processors (DSPs).
- If there is no interference when the receiver is turned off and irregular popping, cracking or buzzing noises on the audio with the receiver on, there may be electrical interference problems. This kind of interference is usually caused by electric motors, neon lights, lighting equipment, appliances and other types of electrical equipment. Electrical interference will generally affect all wireless systems at a location, not just one system.
- Certain types of buzzing sounds are actually due to interference from TV stations. If the buzzing sound changes substantially at more or less random intervals and does not seem to be caused by electrical equipment, the problem may be TV interference.
- Interference that takes the form of bursts of static or short bursts of noise is likely to be caused by lightning, intermittent arcing or defective electrical machinery. This type of random interference is pretty rare but can be among the most difficult to resolve.

If none of the descriptions match your particular problem, or the information is unclear, see the "Types of Interference section" below. Your authorized dealer may also be able to offer assistance and might be familiar with any unusual local conditions that could be affecting the problem. If your dealer is not able to assist, owners of VocoPro equipment can obtain telephone support at 800-678-5348 9A-5P M-F Pacific Time.

Avoiding Basic Problems

Sometimes interference problems have very basic causes. To avoid wasting time on an easily correctable problem, check the following items before proceeding:

- Make certain that no radio transmitters are allowed to come closer than approximately 10 to 15 feet of the wireless receiver antennas. This can overload the receiver and increase the chances of interference.
- Make certain not to allow receiver antennas to touch each other when arranging them. Be sure that the antennas from one receiver do not touch, or come too close to, those of another receiver. Try to provide at least 10 inches of separation between the antennas of any two receivers.
- Make sure that all microphones have charged batteries. The low output voltage of weak batteries can cause some microphones to generate harmful interference. If there is any doubt, install fresh batteries in all microphones.
- Make sure that the wireless frequencies are not on a local TV channel.
- Check the wireless frequencies in use to make sure that no two systems are on the same frequency.
- Check to make sure that no two wireless frequencies are too close together. In general, 1 MHz is the recommended minimum spacing between systems.
- If a considerable number of systems will be used, operating conditions will be difficult or interference is likely, if possible avoid these situations.
- Before using a system in a new location or another city, double-check for new problems. Small changes in conditions can cause interference where none was present before.
- Turn off unnecessary electronic equipment, especially computers and digital devices. These are a relatively common cause of wireless interference.
- If use of computers or digital devices is necessary, keep them at least 18 inches (45 cm) away from the microphones and receiver antennas.

Tips for Achieving Optimal Performance

Frequency Conflicts

There are two primary ways that other VHF wireless systems and TV channels cause interference. The first is a direct frequency conflict. If two VHF wireless systems are on the same frequency, usually neither system will be usable unless the other is turned off. This problem is more common than might be expected, especially when all the equipment is the same type. This is because most systems have only a limited number of standard frequencies. It should be remembered that the other systems could be some distance away - in another house of worship down the street, in another nearby studio, or at another club in the vicinity.

TV transmitters can also be a powerful source of direct interference if the wireless frequency falls within the assigned channel of a local TV station. This problem sometimes occurs because wireless frequencies are listed in MHz and it is not always obvious within which TV channel a particular frequency falls. For reference, below is TV frequency information.

TV Channel Frequency Data

VHF TV Channels

Channel	Number	Frequency Range (MHz)	Picture Carrier Frequency (MHz)	Color Subcarrier Frequency (MHz)	Sound Subcarrier Frequency (MHz)
7	174 - 180	175.250	178.8295	179.750	
8	180 - 186	181.250	184.8295	185.750	
9	186 - 192	187.250	190.8295	191.750	
10	192 - 198	193.250	196.8295	197.750	
11	198 - 204	199.250	202.8295	203.750	
12	204 - 210	205.250	208.8295	209.750	
13	210 - 216	211.250	214.8295	215.750	

NOTE: The low VHF TV channels (2 through 6) are not used for wireless microphones and do not need to be considered

Troubleshooting

<p>No sound output, RF LED not glowing</p>	<ul style="list-style-type: none"> -Make sure the microphone and receiver power switches and receiver are set to the ON position. -Check microphone batteries to ensure that they are providing sufficient power. Replace battery if necessary. -Check receiver's AC power connection. Make sure antennas are firmly connected and extended to an optimal position. -If necessary, reduce the distance between the microphones and receiver. -Turn up the receiver's VOLUME level controls. -Check for proper connection between receiver and external amplifier/mixer. -Talk into the microphone and observe the receiver's RF signal LED's. If they glow, the problem is elsewhere in the sound system.
<p>Received signal is noisy or contains extraneous sounds with the microphone(s) ON</p>	<ul style="list-style-type: none"> -Check microphone(s) batteries and replace if charge is low. -Remove local sources of RF interference, such as lighting equipment. -Signal may be too weak. If so, reposition antennas. (If possible, move them closer to the transmitter). -Adjust the squelch application to the microphone channels in use.
<p>Noise coming from the receiver with the microphones turned OFF</p>	<ul style="list-style-type: none"> -Remove local sources of RF interference, such as lighting equipment. -Reposition the receiver or antennas.
<p>Momentary loss of sound as microphone(s) are moved throughout the operating range.</p>	<ul style="list-style-type: none"> -Reposition the receiver and perform a "walkthrough" and observe the signal strengths. If audio dropouts persist, mark these "dead spots" in the operating area and avoid them during the performance.

Specifications

TECHNICAL DATA

RF Carrier Frequency Range: 174.2 – 215.8 MHz

Total Harmonic Distortion: < 0.7% (+15 kHz deviation, 1 kHz modulation)

Frequency Response: 50 Hz-15, ± 2dB

Audio Output Level: ± 15 kHz deviation, 1 kHz tone, (1/4" connector into 3k load): -8.8 dBV (Hi-Z)

Temperature Range: -10-50° C

Sensitivity Range: Approximately 300-ft (100m) under typical conditions

Power Supply: Receiver: AC 120V/50 Hz, Mics: 2 x 1.5V alkaline batteries

Power Consumption: 18-24W

Current Drain: Transmitter: 35mA average (40mA max), Receiver: 180mA average (200mA max)

Operating Temperature Range: -4 to 122 degrees Fahrenheit. Battery dimensions may limit this range.

warning statement.

§ 15.21 Information to user.

Any Changes or modifications not expressly approved by the party responsible for compliance could void the user's authority to operate the equipment.

§ 15.105 Information to the user.

NOTE: This equipment has been tested and found to comply with the limits for a Class B digital device, pursuant to Part 15 of the FCC Rules. These limits are designed to provide reasonable protection against harmful interference in a residential installation. This equipment generates, uses and can radiate radio frequency energy and, if not installed and used in accordance with the instructions, may cause harmful interference to radio communications. However, there is no guarantee that interference will not occur in a particular installation. If this equipment does cause harmful interference to radio or television reception, which can be determined by turning the equipment off and on, the user is encouraged to try to correct the interference by one or more of the following measures:

- Reorient or relocate the receiving antenna.
- Increase the separation between the equipment and receiver.
- Connect the equipment into an outlet on a circuit different from that to which the receiver is connected.
- Consult the dealer or an experienced radio/TV technician for help.