

**TEST REPORT OF A 2.4 GHz RLAN  
ACCESS POINT TRANSCEIVER,  
BRAND NOWIRESNEEDED,  
TYPE 11 Mbps WIRELESS LAN ACCESS POINT,  
IN CONFORMITY WITH  
FCC PART 15 AND ANSI C63.4-1992**

FCC report layout endorsed by the FCC by Public  
Notice of March 11, 1992.

Accredited by	:	STERLAB accreditation number L029 D.A.R., TTI-P-G.127/96-00
Competent body	:	Article 10-2 EMC Directive
Notified body	:	Article 10-5 EMC Directive Low Voltage Directive Number 0122 TTE Directive
Designated laboratory	:	TTE Directive
Notified test service	:	Automotive Directive
FCC listed	:	31040/SIT
VCCI listed	:	R 592 and C 507
Certification body	:	Electrical Products Safety Regulation Hong Kong

Nederlands Meetinstituut

P.O. Box 15  
9822 ZG Niekerk (NL)  
Smidshornerweg 18  
9822 TL Niekerk (NL)

Telephone: +31 594 505005  
Telefax: +31 594 504804  
E-mail: NMI@NMI.nl

NMI B.V. (Chamber of Commerce Haaglanden No. 27228701)

Offices: Delft, Bergum, Dordrecht, Niekerk, Utrecht,  
Tinton Falls NJ (USA), Kawasaki (Japan), Hortolândia SP (Brazil)

Subsidiary companies:

NMI Certin B.V. (27233418)

NMI Van Swinden Laboratorium B.V. (27228703)

NMI International B.V. (27239176)

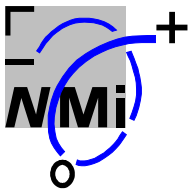

MEASUREMENT/TECHNICAL REPORT

NoWiresNeeded B.V.

Modelnumber : 11 Mbps WLAN ACCESS POINT

FCC ID: OGD10410208

April 28, 2000

Form with fields: This report concerns (check one): Original grant, Class II change; Equipment type: Direct Sequence Spread Spectrum Transceiver; Deferred grant requested per 47 CFR 0.457(d)(1)(ii)? Yes, no; Transition Rules Request per 15.37 yes, no; Report prepared by: Name, Company name, Address, Telephone number, Telefax number, Mailing address, City/Place/Postal cd., Country.

The data taken for this test and report herein was done in accordance with FCC Part 15 and measurement Procedures of ANSI C63.4-1992 and were relevant the procedures as specified in the sheets from the FCC attached to this test report.

Date: April 28, 2000

Signature:

P.A.J.M. Robben BSc EE
Department EMC and Telecommunication

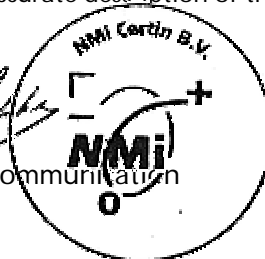
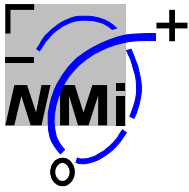

Table of Contents	Page
<b>1 General information.</b>	<b>5</b>
1.1 Product description.	5
1.2 Related Submittal(s)/Grant(s).	5
1.3 Tested System Details.	6
1.4 Test Methodology.	6
1.5 Test Facility.	6
1.6 List of measurement equipment.	6
1.7 Bandwidth and antenna factors.	8
<b>2 Product labelling.</b>	<b>9</b>
2.1 FCC ID Label.	9
2.2 Location of the FCC ID Label on the EUT.	9
<b>3 System test configuration.</b>	<b>10</b>
3.1 Justification.	10
3.2 EUT exercise software.	10
3.3 Special accessories.	10
3.4 Equipment modifications.	11
3.5 Configuration of the tested system.	11
<b>4 Block diagram(s) of the tested model.</b>	<b>11</b>
<b>5 Conducted emission data.</b>	<b>12</b>
<b>6 Radiated emission data</b>	<b>14</b>
6.1 Radiated emissions below 1 GHz.	14
6.2 Radiated emissions above 1 GHz.	16
<b>7 -6 dB Bandwidth measurements.</b>	<b>17</b>
7.1 Channel 1.	17
7.2 Channel 6.	18
7.3 Channel 11.	19
<b>8 Peak power</b>	<b>20</b>
<b>9 Conducted emissions at the antenna output.</b>	<b>21</b>
9.1 Channel 6.	21



<b>10</b>	<b>Restricted bands of operation</b> .....	<b>28</b>
<b>11</b>	<b>Peak power density</b> .....	<b>30</b>
11.1	Channel 1 .....	30
11.2	Channel 6 .....	31
11.3	Channel 11 .....	32
<b>12</b>	<b>Processing gain</b> .....	<b>33</b>
12.1	Processing gain at 11.0 Mbps.....	33
12.2	Block diagram CW Jamming test setup.....	33
12.3	Processing Gain at 11Mbps test results tables.....	34
12.4	Processing gain at 2.0 Mbps.....	39
12.5	Processing Gain at 2.0 Mbps testresults tables .....	40

## 1 General information.

### 1.1 Product description.

The No Wires Needed Poldhu™ MAC ASSP (U3) forms the heart of the IEEE802.11B protocol engine. Equipped with an embedded ARM9 processor, Poldhu™ is powerful enough to support all the mandatory and optional IEEE802.11 features as well as extending the functionality with additional No Wires Needed Added Value features. Poldhu™ is by far the most advanced IEEE802.11 MAC controller of the moment.

The memory system of the MAC is comprised of a 16Mbit PC-100 SDRAM memory (U231) and a 16Mbit Flash memory (U220).

The Phy section is comprised of 4 parts:

- HFA3861 Baseband Processor with Rake Receiver (U5)
- HFA3783 AGC Quadrature Modem and Synthesizer (U9)
- HFA3683 2.4GHz RF/IF Converter and Synthesizer (U11)
- HFA3983 PA with Detector (U12)

The baseband processor uses CCK modulation and a Rake architecture to reduce the effects of multipath distortion. This reduces the error rates in typical office environments to improve overall data throughput. An optional fast acquisition mode further improves throughput.

The IF is a linear design with AGC. This permits the use of equalizers in the BBP. An IF overload detector and a selectable low gain LNA mode work with the BBP to extend dynamic range without sacrificing sensitivity. IF frequency is 374MHz. Filtering at IF is done by FL1, a 374MHz SAW filter.

The RFIC's are produced in advanced SiGe technology to realize improvements in integration, performance, and power consumption. Integral PLL's in both the RF and IF parts eliminate the need for an external synthesizer. The HFA3683's internal LNA noise figure is improved so that an external LNA IC is no longer needed. The chip set is designed so that the parts can be interfaced with few external components.

The RF LO frequency is generated by VCO U14. Frequency range of the LO is 2038MHz for channel 1 to 2088MHz for channel 11 (FCC) or 2098MHz for channel 13(ETSI).

The PA incorporates an integral power detector that is monitored by the BBP to control the IF gain to maintain constant output levels.

A dual spatial integrated antenna system is used to select the most optimal signal. The antennas are sleeve dipoles and are directly connected to the PCB.

### 1.2 Related Submittal(s)/Grant(s).

Not applicable.

### 1.3 Tested System Details.

The FCC ID's for all equipment, plus descriptions of all cables used in the tested system (included inserted cards, which have Grants) are:

Brand / Model	Serial #	FCC ID	Description	Cable Descriptions
<b>EUT:</b> NoWiresNeeded 11Mbps WLAN Access Point	n.a.	OGD10410208	2.4 GHz RLAN Access point	-UTP cable to 3Com LAN PC card -5VDC power cord to power supply
Sunpower MA 15-050	993311	n.a.	5VDC/1A adapter	-prim. AC power cord to mains -sec. DC power cord to access point
MS InPort Mouse	n.a.	C3K7PN9937	Serial PC mouse	-serial cable to serial PC port
3COM Etherlink III	6KJ2BB2A88	DF63C589D	LAN PC Card	-UTP cable to Access point
IBM Thinkpad type 2644	#553782N	n.a.	Laptop PC	-power cord to adapter -serial cable to PC mouse -printer cable to HP printer
HP Deskjet 500	#3228S37407	B94C2106X	Printer	-printer cable to Notebook PC -power cord to power supply

### 1.4 Test Methodology.

The test methodology used has been based on the requirements of FCC Part 15, (10-1-97 edition), relevant clauses 15.205, 15.207, 15.209 and 15.247,. The used measuring methods are based on the ANSI C63.4-1992 document.

Radiated tests above 30 MHz were performed at a distance of 3 meter. Below 30 MHz the measurement was carried out on a distance of 10 meter. The eventual found results will be calculated to values for the required measuring distance of 30/300 meter.

Fieldstrength measurements on frequencies above 1 GHz were measured with appropriate pre-amplifiers, antennas and a spectrum analyzer. On found frequencies the actual level at the input of the pre-amplifier was generated with aid of a signal generator. The output level of the signal generator was increased with the antenna-factor to obtain the fieldstrength.

### 1.5 Test Facility

The FCC has per Public Notice declared that the measurement facilities located at the NMI Certin B.V. Testsite Niekerk, Smidshornerweg 18, The Netherlands, has been reviewed and found to be in compliance with the requirements of section 2.948 (previously section 15.38) of the FCC rules per August 2, 1994.

The description of the measuring facilities have been filed with reference 31040/SIT, 1300B3 at the FCC's Offices.

### 1.6 List of measurement equipment.

NMI number	Description	Brand	Type
12471	Biconical antenna 20MHz-200MHz	EATON	94455-1
12473	Log-per antenna 200-1000MHz	EATON	96005
12475	Loop antenna	EMCO	6502/2
12476	Antenna mast	EMCO	TR3
12477	Antenna mast 1-4 mtr	Poelstra	--
12478	Control unit / portable turn table	NMI	DFO
12483	Guidehorn	EMCO	3115

12484	Guidehorn	EMCO	3115
12486	Spectrum analyzer	Anritsu	MS2601A
12488	Guidehorn 18-26.5 GHz	EMCO	RA42-K-F-4B-C
12491	Measuring receiver 0.01Mhz-30MHz	R&S	ESH3
12492	Measuring receiver 20MHz-1300MHz	R&S	ESVP-
12493	EZM Spectrum Monitor	R&S	EZM
12494	Measuring receiver 20MHz-1000 MHz	R&S	ESV-
12497	Spectrum analyzer	HP	8592A
12498	Rejectfilter	K&L	3TNF-100/200-N
12499	Rejectfilter	K&L	3TNF-50/100-N
12500	Rejectfilter	K&L	3TNF-250/500-N
12501	Rejectfilter	K&L	3TNF-25/50-N
12507	Artificial mains network 3-phase	R&S	ESH2-Z5
12516	Signalgenerator 100kHz-1000MHz	R&S	SMX
12519	RF amplifier	ENI	603L
12524	Signalgenerator	R&S	SMHU
12525	POCSAG generator	NMi	SMF-3
12527	Signalgenerator 100kHz-1000 MHz	R&S	SMG
12528	ERMES generator	NMi	--
12533	Signalgenerator	MARCONI	2032
12538	Attenuator 100W/20dB	Bird electronic	8340-200
12545	Directional coupler	HP	HP778D
12546	Measuring cable to plateau	--	RG 213
12548	Meas.cable 2 metre, color:green	Radiall	R287571005
12549	Oscilloscope 20 MHz	KENWOOD	CS-8010
12553	Communication Analyzer	R&S	CMTA 84
12558	Communication Analyzer	R&S	CMTA 54
12559	Digital storage oscilloscope	Le Croy	9310M
12560	DC Power Supply 20A/60V	DELTA	SM6020
12561	DC Power Supply 20A/70V	DELTA	SM7020D
12567	Plotter	HP	7440A
12605	calibrated dipole 28MHz-1GHz	Emco	3121c
12607	Calibrated attenuator set	HP	HP11581a
12608	HF milliwattmeter	HP	HP435a
12609	Power sensor 10MHz-18GHz	HP	HP8481A
12620	Spectrum analyzer	Advantest	R4131B
12635	Measurement platform	WOLFF	--
12636	Plastic measurement room	Polyforce	--
12640	Temperature chamber	Heraeus	VEM03/500
13078	Wideband Pre-Amplifier (1GHz-5GHz)	Miteq	AMF3D0100503010
13313	Impuls limiter	R&S	ESH3Z2.357...
13452	Digital multi meter	HP	34401A
13664	Spectrum analyzer	HP	HP8593E
13886	Open Area Test Site	Comtest	--
14051	Anechoic room	Comtest	--
14277	Antennamast 4m	Heinrich Deisel	HD100
14278	Controller OATS	Heinrich Deisel	MA240
14340	Biconilog antenna 20MHz - 1100MHz	EMCO	3143
14351	Biconilog	EMCO	9143
14450	2.4 GHz bandrejectfilter	BSc	xn-1783
14987	Stripline cell	Marconi	TC5010
15232	Tektronics storage scope	Tektronics	--
15453	Magnetic loop	Chase	--
15633	Biconilog Testantenna	Chase	CBL 6111B
15667	Measuring receiver 9kHz - 2750MHz	R&S	ESCS30
99012	ITU-R recomm. 559-2 noise generator	NMi	--
99040	Attenuator 25W/20dB	Bird electronic	8340-200
99041	Attenuator 25W/10dB	BIRD	8340-100
99042	Attenuator 10W/3dB	Bird electronic	8304-030-N
99043	Attenuator 25W/20dB	Bird electronic	8340-200
99044	Attenuator 10W/3dB	Bird electronic	8304-030-N
99045	DC Power Supply 3A/30V	DELTA	E030/3

99046	Fluke Multimeter	John Fluke	12
99050	Wideband Pre-Amplifier (5GHz-10GHz)	Miteq	AMF3D0501004010
99055	Non-conducting support	NMi	--
99056	Isolating transformer 1:1	NMi	--
99061	Non-conducting support 150cm	NMi	--
99068	Detector N-F/BNC-F	Radiall	R451576000
99069	Cable 5m RG214	NMi	--
99070	Cable 15m RG214	NMi	--
99071	Cable 10m RG214	NMi	--
99076	Bandpassfilter 4-10GHz	Reactel	7AS-7G-6G-511
99077	Regulating trafo	RFT	LTS006
99079	RF Combiner	R&S	DVU 4
99108	Turntable OATS	Heinrich Deisel	HD050
99111	magnetic loop power supply	Chase	--
99112	Tripod	Chase	--
99115	Voltage probe	Schwarzbeck	TK9416

## 1.7 Bandwidth and antenna factors.

The utilized measuring equipment is stated in § 1.6. The bandwidth of the receiver switches automatically to the right bandwidth in accordance with CISPR 16. This is implemented in the receiver. Also the antenna factors are included in the test receiver. The receiver automatically calculates the appropriate correction factor for the utilized antenna and also the appropriate correction factor for the cable loss. The total correction is automatically added to the measured value.



## 2 Product labelling.

### 2.1 FCC ID Label

The following label shall be attached to the device under test.

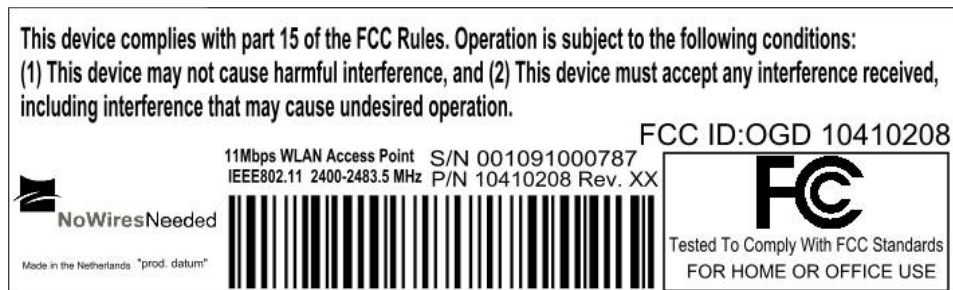

Figure 2.1. FCC ID label

The dimensions of the label, the location of the label and the type of font can be found in the FCC regulation book CFR 47, parts 0 to 19, revised as per October 1, 1993.

### 2.2 Location of the FCC ID Label on the EUT

The FCC ID Label will be placed on the rear side of the 11 Mbps WLAN Access point

See attached documentation-sheet for more detailed information.

### 3 System test configuration.

#### 3.1 Justification.

The system was configured for testing in a typical fashion (as a customer would normally use it).

The justification of cables and equipment has been carried out as prescribed in the ANSI C63.4-1992 document.

The measurements were performed on the lowest operating frequency (channel 1: 2412 MHz), the operating frequency in the middle of the specified frequency band (channel 6: 2437 MHz) and the highest operating frequency (channel 11: 2462 MHz).

#### Operating frequencies and rated output power levels

channel	Operating frequencies (MHz)	Rated output power (dBm)	test performed
1	2412	+18	yes
2	2417	+18	no
3	2422	+18	no
4	2427	+18	no
5	2432	+18	no
6	2437	+18	yes
7	2442	+18	no
8	2447	+18	no
9	2452	+18	no
10	2457	+18	no
11	2462	+18	yes

Table 3.1: Operating frequencies and rated output power levels

#### 3.2 EUT exercise software.

The EUT was enabled to continuously transmit, which was verified by a receiving unit during testing. The carrier was also checked to verify that the information was being transmitted.

#### 3.3 Special accessories.

No special accessories are used to achieve FCC compliance.

### 3.4 Equipment modifications.

No modifications have been made to the equipment to achieve compliance.

Applicant Signature	: n.a.	Date	: n.a.
Printed name	: n.a.	Position	: n.a.

### 3.5 Configuration of the tested system.

Blockdiagrams of the tested system are included in Annex attached to this report.

## 4 Block diagram(s) of the tested model.

Information is annexed in the technical documentation supplied by the applicant.

## 5 Conducted emission data.

The initial step in collecting conducted data is a scan of the measurement range. Significant signals are then marked and these signals are then measured using a quasi-peak detector.

Line 1

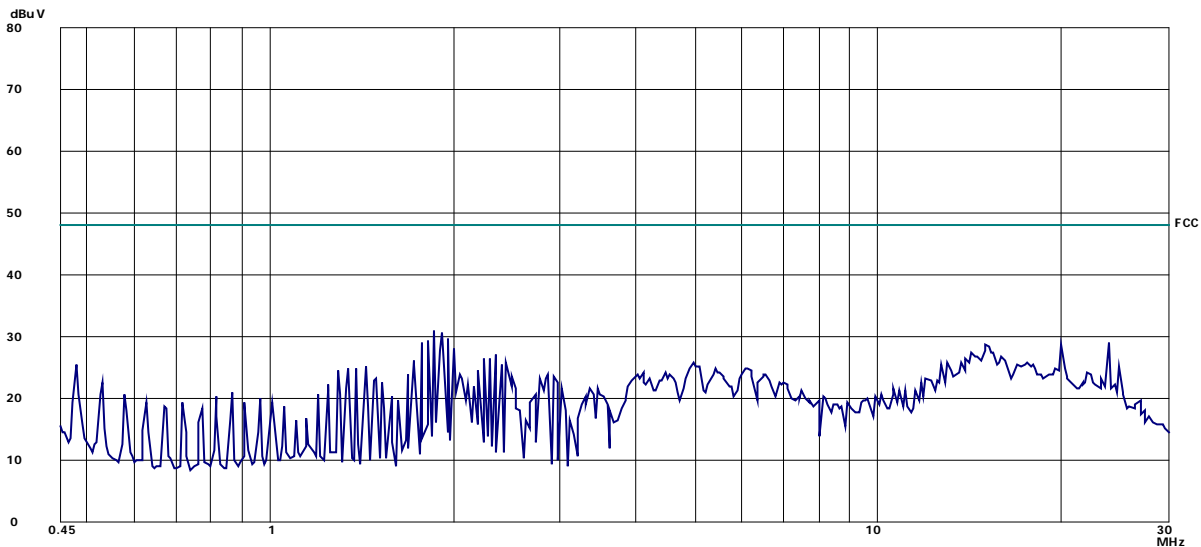

Plot 5.1: Conducted emissions on channel 6.

The following table lists worst case conducted emission data in accordance with FCC 15.207. The conducted test was performed with the EUT exercise program loaded. Photographs of the test setups are included in annex attached to this report.

Frequency (MHz)	Measurements results QP (dB $\mu$ V)	FCC Margin (dB $\mu$ V)	Limits (dB $\mu$ V)
1.33	25.8	22.2	48.0
1.81	31.9	16.1	48.0
5.01	26.3	21.7	48.0
15.10	28.6	19.4	48.0
20.02	29.1	18.9	48.0
24.00	30.5	17.5	48.0
other frequencies	<<	> 20.0	48.0

Table 5.1 : Conducted emissions on channel 6.

<< means that the measured value is more .then 20 dB below limit // QP means Quasi-Peak

The conducted emission measurement has been carried out with an AC supply voltage of 120 V.

Testpersonnel:

Signature :   
 Printed name : O.H. Hoekstra

Date: April 13, 2000

Neutral L2

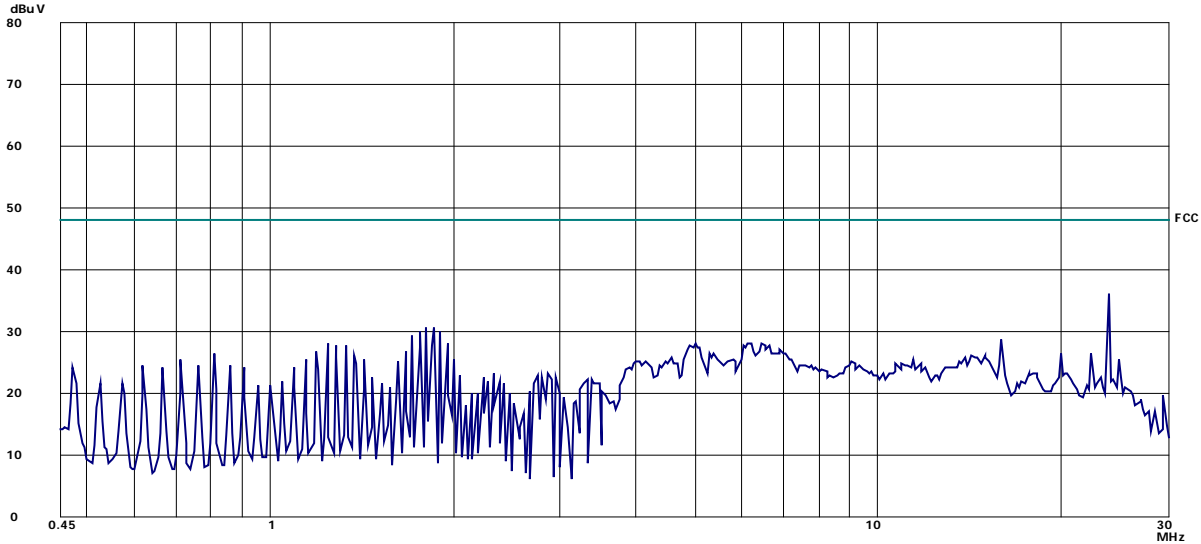

Plot 5.2: Conducted emissions on channel 6.

The following table lists worst case conducted emission data in accordance with FCC 15.207. The conducted test was performed with the EUT exercise program loaded. Photographs of the test setups are included in annex attached to this report

Frequency (MHz)	Measurements results QP (dBµV)	FCC Margin (dBµV)	Limits (dBµV)
1.33	27.7	20.3	48.0
1.81	30.8	17.2	48.0
5.00	28.1	19.9	48.0
6.10	28.1	19.9	48.0
6.53	27.8	20.2	48.0
16.0	28.8	19.2	48.0
24.0	36.1	11.9	48.0
other frequencies	<<	> 20.0	48.0

Table 5.2 : Conducted emissions on channel 6.

<< means that the measured value is more than 20 dB below limit // QP means Quasi-Peak

The conducted emission measurement has been carried out with an AC supply voltage of 120 V.

Test engineer:

Signature : 

Date: April 13, 2000

Printed name : O.H. Hoekstra

## 6 Radiated emission data

The following data lists the significant emission frequencies (worst case), measured levels in accordance with FCC 15.209. Photographs of the testsetups are included in annexes attached to this report.

### 6.1 Radiated emissions below 1 GHz

Vertical polarization			
Frequency	Measured Value QP (3m)	FCC limit	FCC margin
MHz	dBuV/m	dBuV/m	dB
56.0	25.0	40.0	15.0
112.0	33.4	43.5	10.1
132.0	36.8	43.5	6.7
140.0	35.1	43.5	8.4
168.0	35.1	43.5	8.4
196.0	30.6	43.5	12.9
224.0	39.5	46.0	6.5
250.0	39.5	46.0	6.5
280.0	33.0	46.0	13.0
336.0	42.4	46.0	3.6
364.0	38.8	46.0	7.2
392.0	33.3	46.0	12.7
700.0	45.3	46.0	0.7
756.0	40.0	46.0	6.0
812.0	43.2	46.0	2.8

Table 6.1: Radiated emissions on channel 6 (Vertical)

#### Notes:

All measured levels in quasi-peak mode, polarization refers to measuring antenna.  
 All radiated harmonic emissions were found to be > 25dB below limits.

The radiated emission measurement has been carried out with an AC supply voltage of 120 V.

Test engineer:

Signature : 

Date: April 13, 2000

Printed name : O.H. Hoekstra

Horizontal polarization			
Frequency	Measured Value QP (3m)	FCC limit	FCC margin
MHz	dBuV/m	dBuV/m	dB
56.0	18.8	40.0	21.2
112.0	27.9	43.5	15.6
132.0	33.1	43.5	10.4
140.0	34.9	43.5	8.6
168.0	38.9	43.5	4.6
196.0	37.6	43.5	5.9
224.0	37.5	46.0	8.5
250.0	40.3	46.0	5.7
280.0	38.1	46.0	7.9
336.0	39.2	46.0	6.8
364.0	44.7	46.0	1.3
392.0	40.3	46.0	5.7
700.0	40.1	46.0	5.9
756.0	42.6	46.0	3.4
812.0	36.6	46.0	9.4

Table 6.2: Radiated emissions on channel 6 (Horizontal)

Notes:

All measured levels in quasi-peak mode, polarization refers to measuring antenna.  
 All radiated harmonic emissions were found to be > 25dB below limits.

The radiated emission measurement has been carried out with an AC supply voltage of 120 V.

Test engineer:

Signature : 

Date: April 13, 2000

Printed name : O.H. Hoekstra

## 6.2 Radiated emissions above 1 GHz

Vertical polarization		
Frequency	Measured Value Peak (3m)	FCC limit
MHz	dBµV/m	dBµV/m
4874.0	< 24.0	54.0
7311.0	< 26.5	54.0

Table 6.3: Peak radiated emissions above 1GHz on channel 6 (Vertical)

Horizontal polarization		
Frequency	Measured Value Peak (3m)	FCC limit
MHz	dBµV/m	dBµV/m
4874.0	< 24.0	54.0
7311.0	< 26.5	54.0

Table 6.4: Peak radiated emissions above 1GHz on channel 6 (Horizontal)

Notes:

Polarization refers to measuring antenna.

Measured signal is narrow band continuous wave with peak value equal to average value.

The radiated emission measurement has been carried out with an AC supply voltage of 120 V.

Test engineer:

Signature :   
 Printed name : O.H. Hoekstra

Date: April 13, 2000



## 7 -6 dB Bandwidth measurements.

The minimum 6 dB bandwidth measurement was performed in accordance with FCC 15.247 (a)

### 7.1 Channel 1

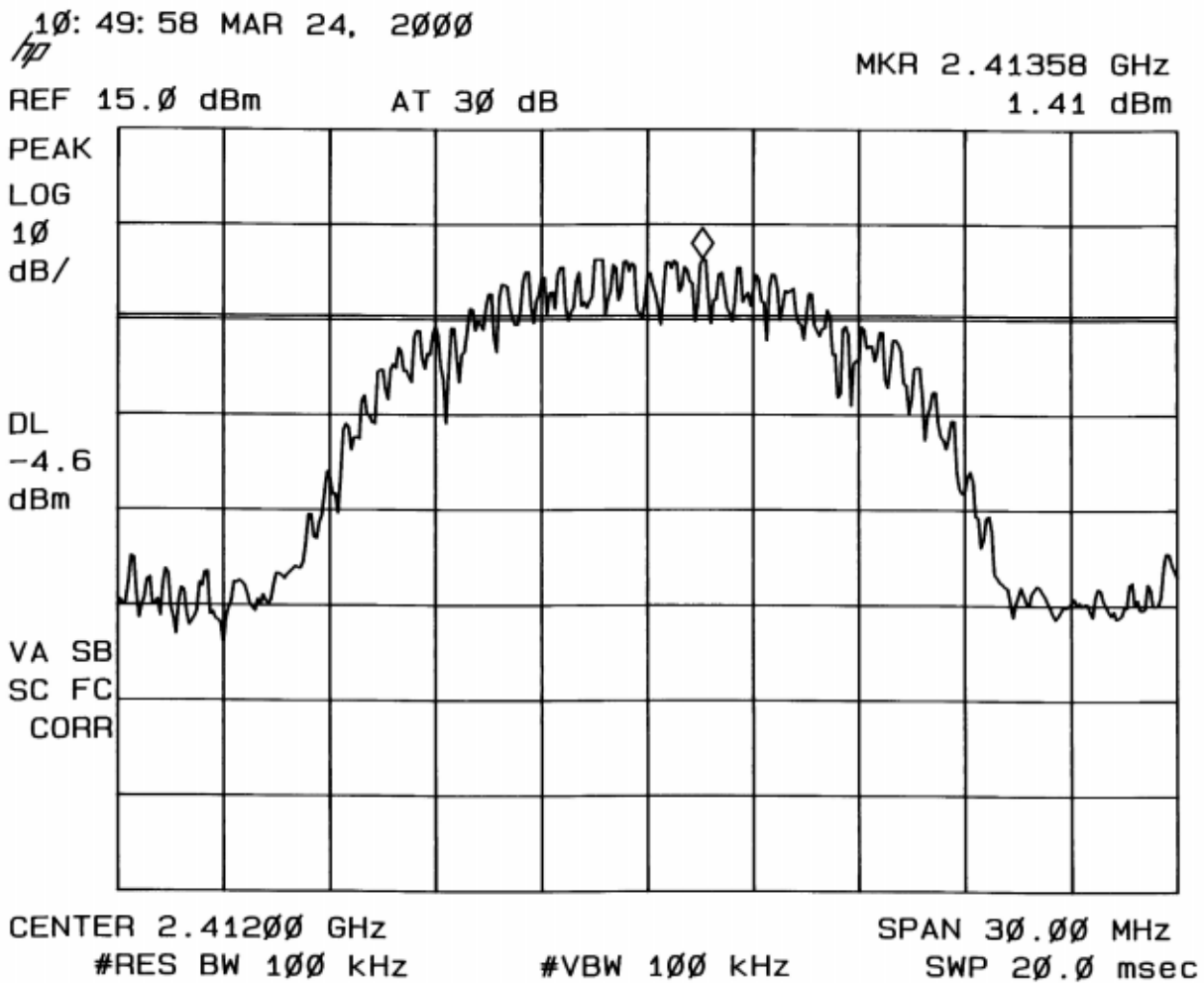

Plot 7.1: -6 dB bandwidth plot of channel 1

Modulation = 11.0 Mbps

The minimum -6 dB modulated bandwidth on channel 1 : 10.2 MHz.

Test engineer:

Signature : 

Date: March 24, 2000

Printed name : O.H. Hoekstra

## 7.2 Channel 6

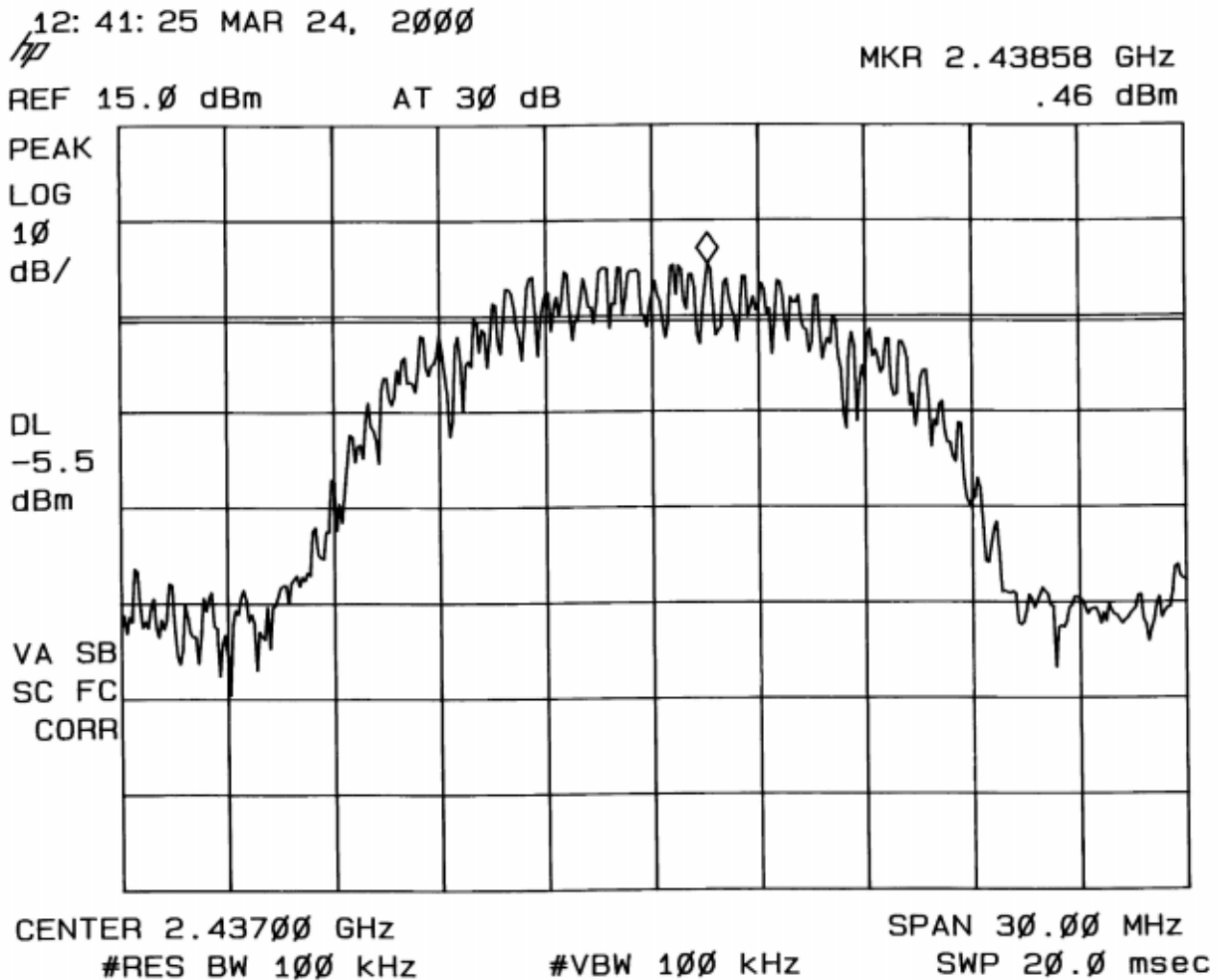

Plot 7.2: -6 dB bandwidth plot of channel 6

Modulation = 11.0 Mbps

The minimum -6 dB modulated bandwidth on channel 6 : 10.2 MHz.

Test engineer:

Signature : 

Date: March 24, 2000

Printed name : O.H. Hoekstra

### 7.3 Channel 11

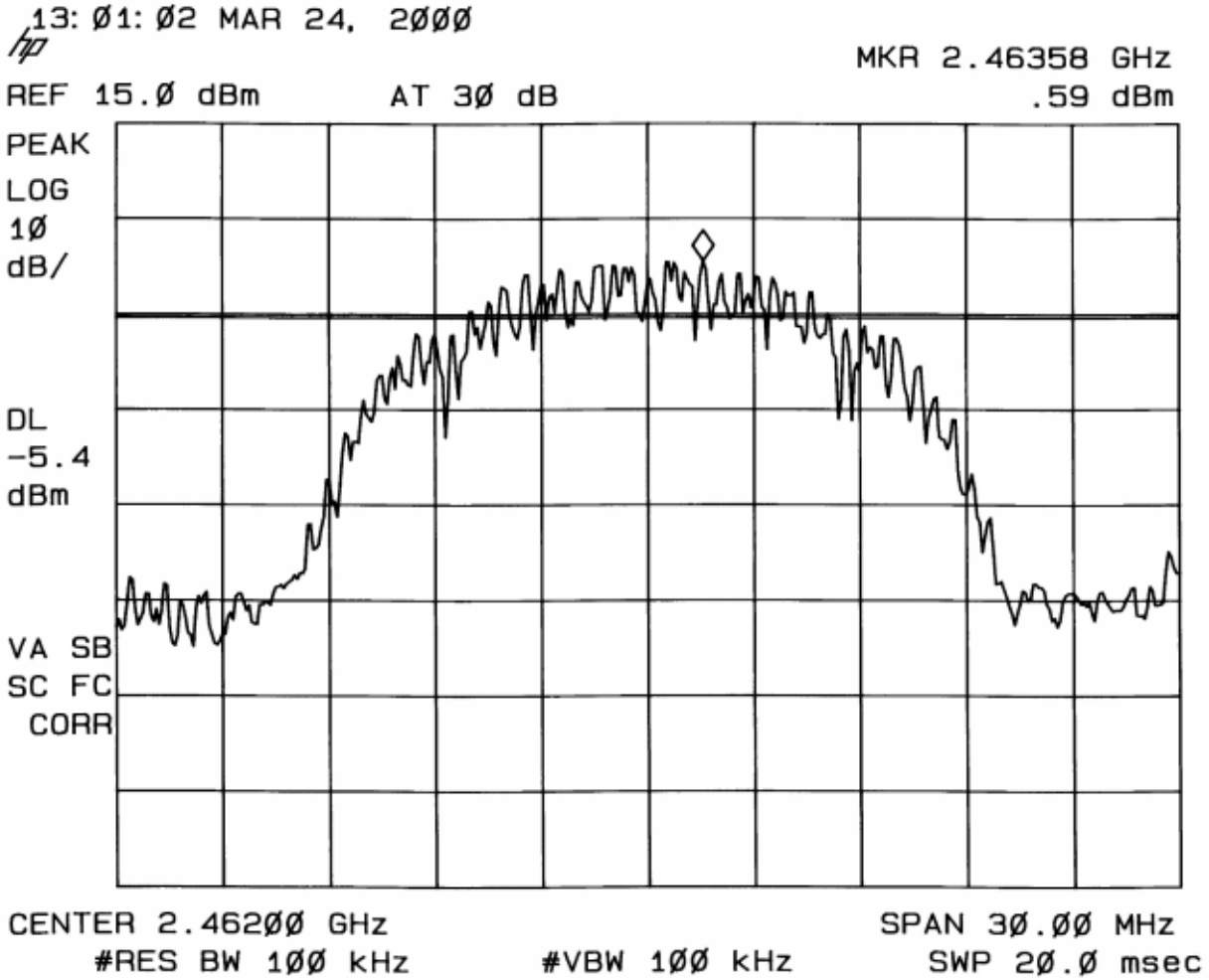

Plot 7.3: -6 dB bandwidth plot of channel 11

Modulation = 11.0 Mbps

The minimum -6 dB modulated bandwidth is on channel 11 : 10.2 MHz.

Test engineer:

Signature : 

Date: March 24, 2000

Printed name : O.H. Hoekstra

## 8 Peak power

The peak power measurement was performed in accordance with FCC 15.247 (b). The plot is made with the highest bandwidth being worst case. The maximum value is then marked and the peak value of this signal is measured using a wideband diode detector.

Channel	Peak Power (dBm)
1	15.4
6	15.1
11	15.0

**Table 8.1: Peak Power**

Test engineer:

Signature : 

Date: March 23, 2000

Printed name : O.H. Hoekstra

## 9 Conducted emissions at the antenna output

Antenna spurious emission per FCC 15.247(c) was measured from the EUT antenna port using a 50 Ohm spectrum analyzer with the resolution/video bandwidth set at 100 kHz. The worst case values are plot below.

### 9.1 Channel 6

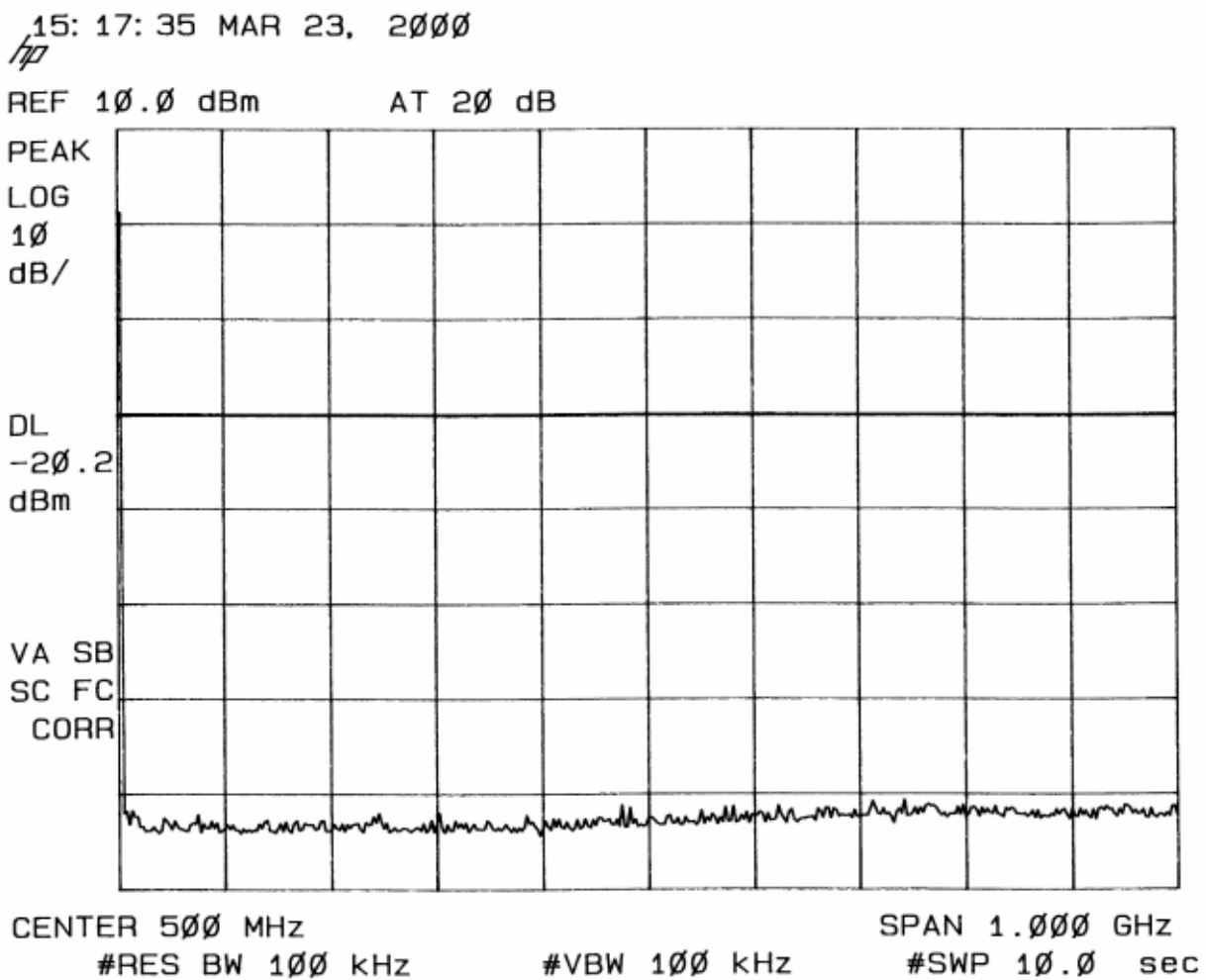

Plot 9.1: Conducted emissions 0 MHz – 1000 MHz

Test engineer:

Signature :



Date: March 23, 2000

Printed name :

O.H. Hoekstra

15: 21: 07 MAR 23, 2000

REF 10.0 dBm AT 20 dB

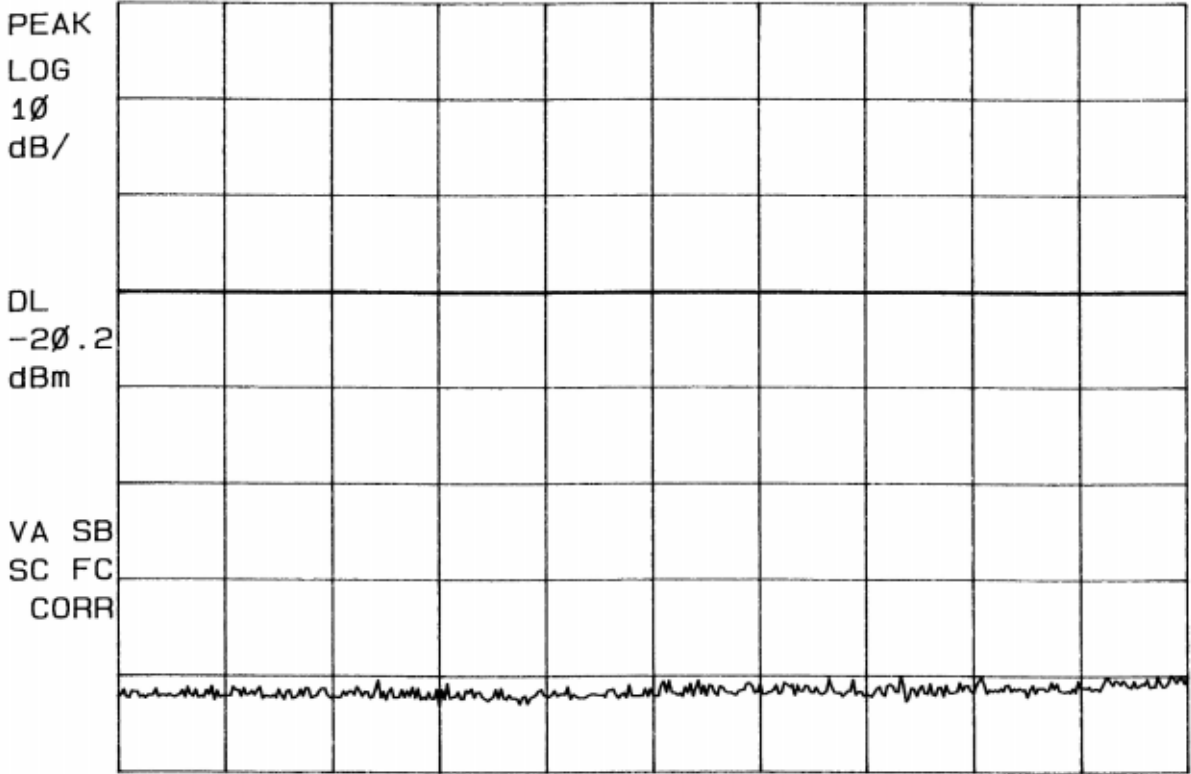

CENTER 1.500 GHz SPAN 1.000 GHz  
 #RES BW 100 kHz #VBW 100 kHz #SWP 10.0 sec

Plot 9.2: Conducted emissions 1.0 GHz – 2.0 GHz

Test engineer:

Signature : 

Date: March 23, 2000

Printed name : O.H. Hoekstra

15: 29: 49 MAR 23, 2000

REF 10.0 dBm AT 20 dB

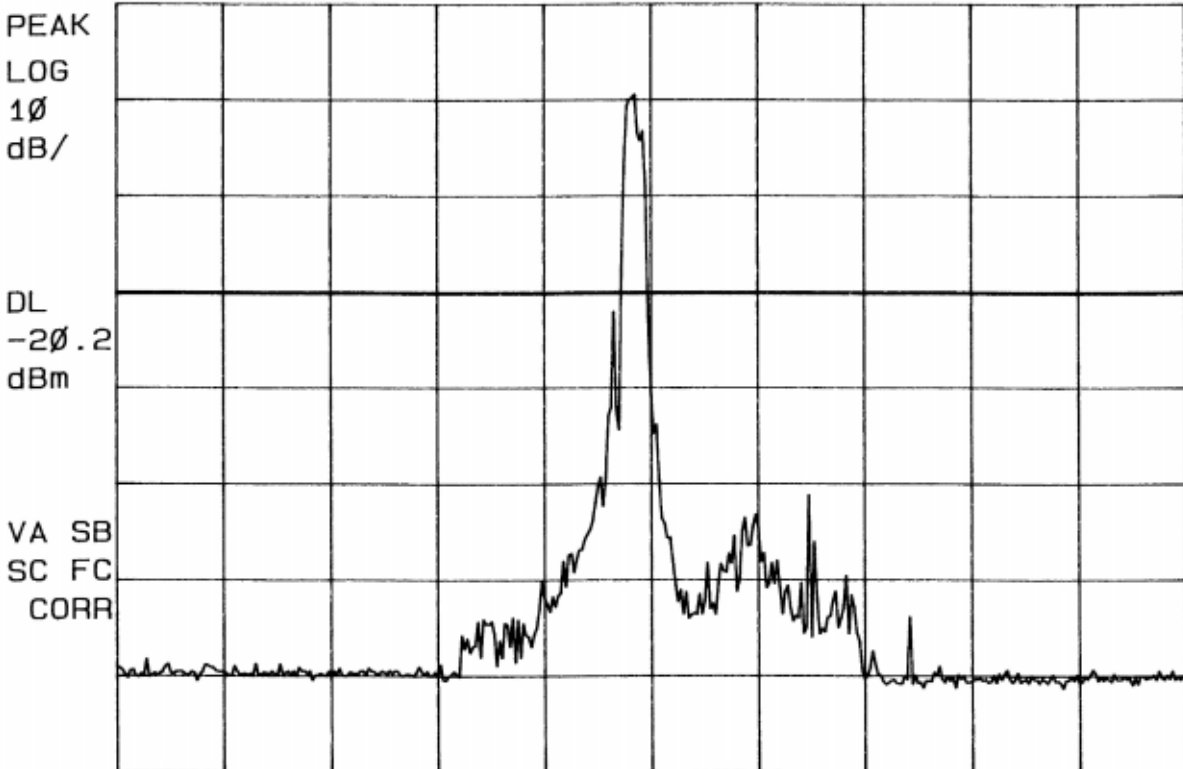

Plot 9.3: Conducted emissions 2.0 GHz - 2.9 GHz

Test engineer:

Signature : 

Date: March 23, 2000

Printed name : O.H. Hoekstra

15: 34: 01 MAR 23, 2000

*hp*

REF 10.0 dBm

AT 20 dB

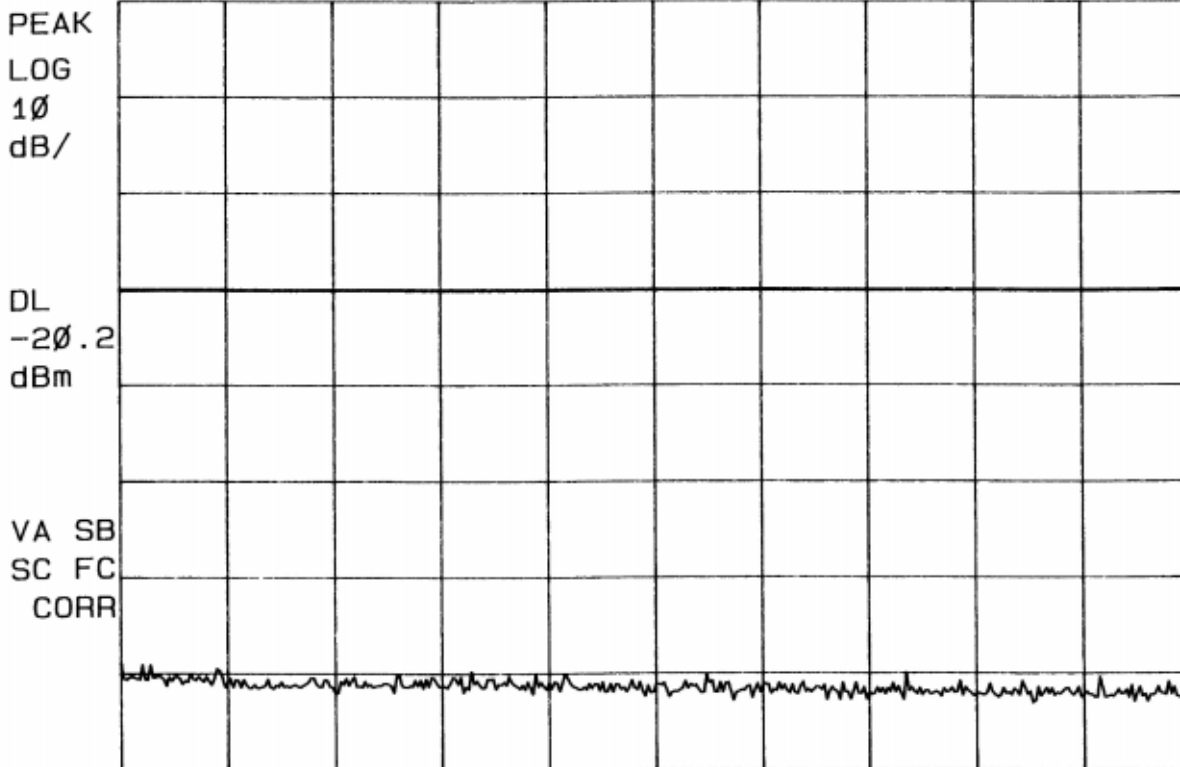

CENTER 3.450 GHz

#RES BW 100 kHz

#VBW 100 kHz

SPAN 1.100 GHz

SWP 330 msec

Plot 9.4: Conducted emissions 2.9 GHz – 4.0 GHz

Test engineer:

Signature :

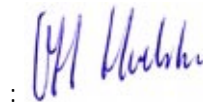

Date: March 23, 2000

Printed name :

O.H. Hoekstra



15: 40: 00 MAR 23, 2000

REF 10.0 dBm AT 20 dB

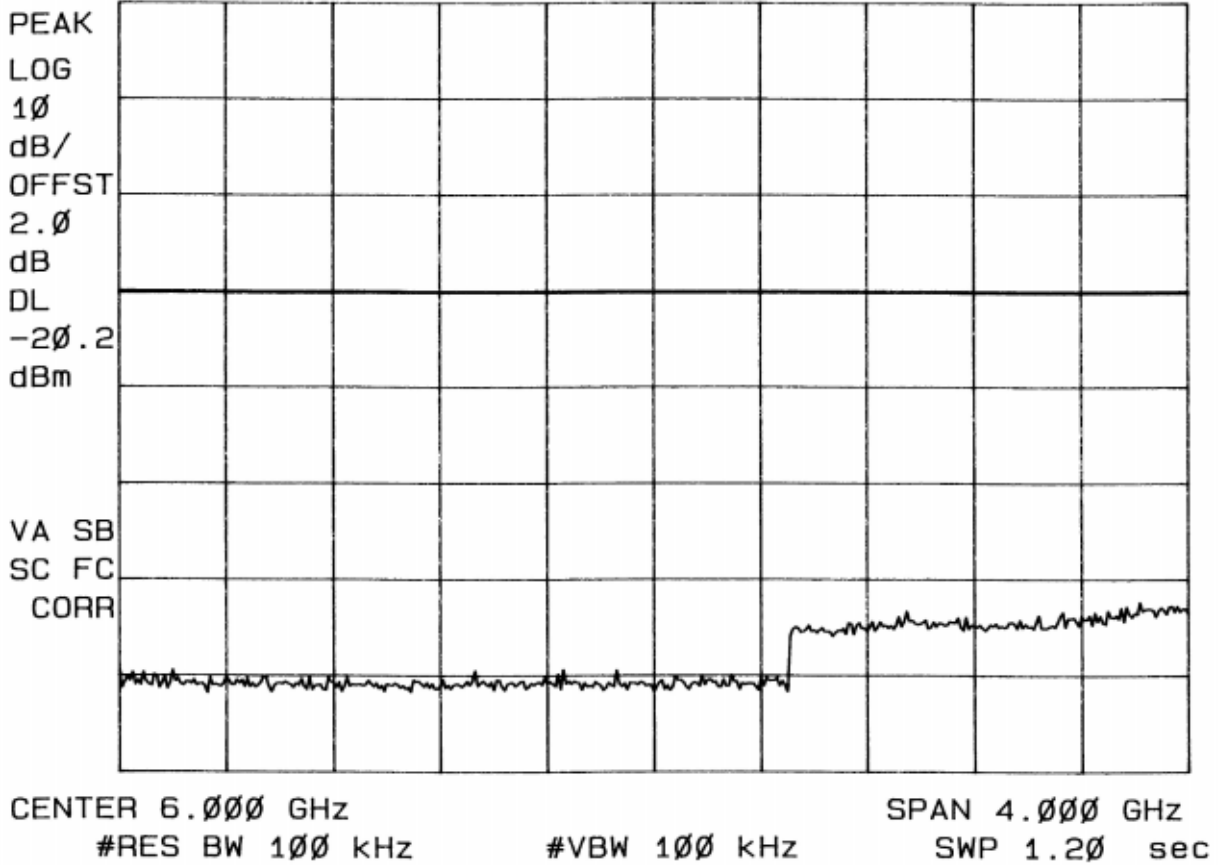

Plot 9.5: Conducted emissions 4.0 GHz – 8.0 GHz

Test engineer:

Signature :



Date: March 23, 2000

Printed name :

O.H. Hoekstra

15: 45: 41 MAR 23, 2000

REF 10.0 dBm AT 20 dB

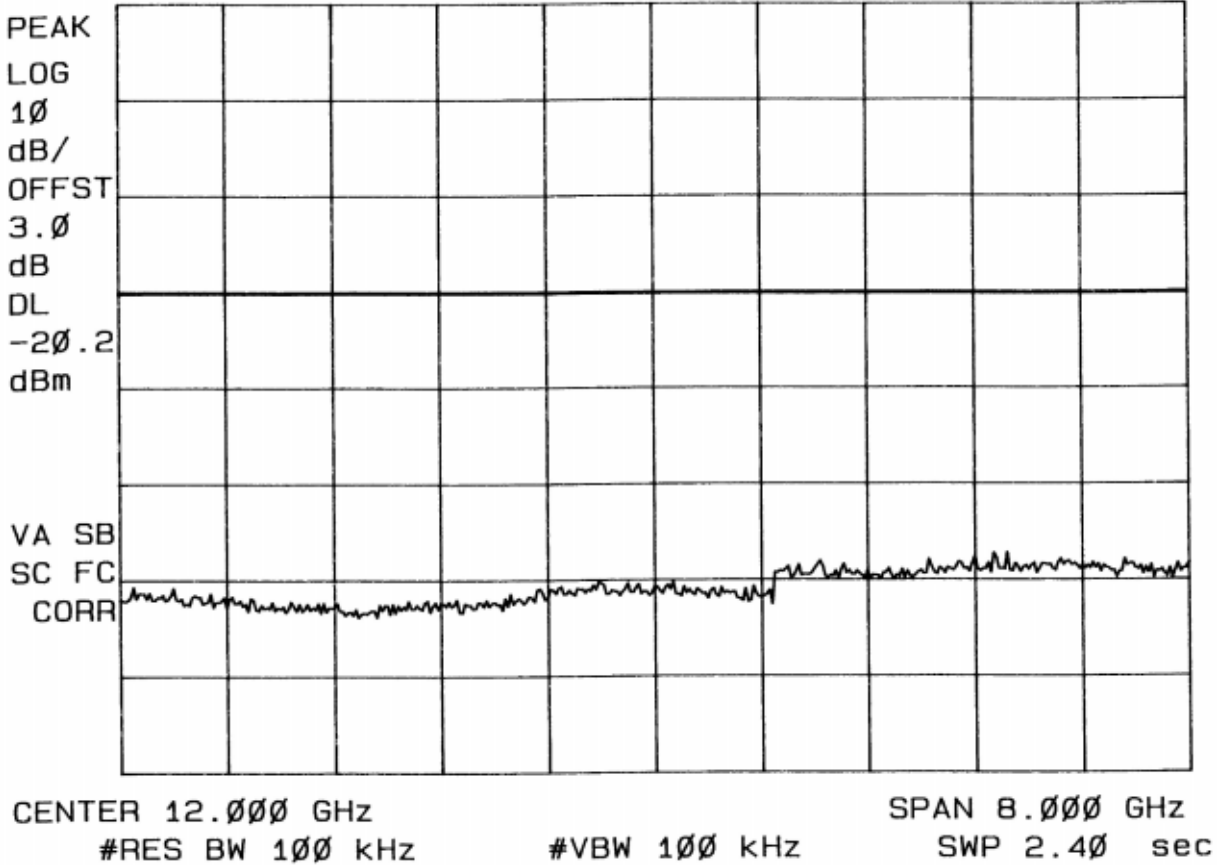

Plot 9.6: Conducted emissions 8.0 – 16.0 GHz

Test engineer:

Signature : 

Date: March 23, 2000

Printed name : O.H. Hoekstra

15: 51: 26 MAR 23, 2000

REF 10.0 dBm AT 20 dB

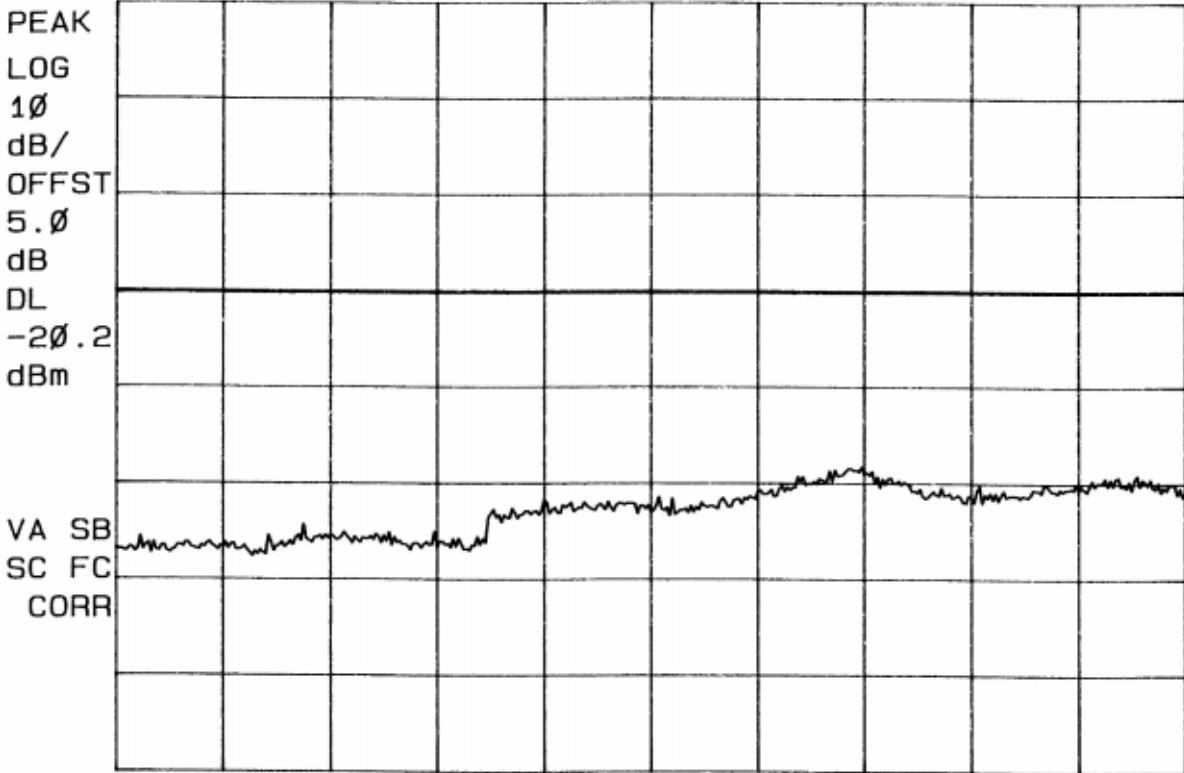

CENTER 21.00 GHz SPAN 10.00 GHz  
 #RES BW 100 kHz #VBW 100 kHz SWP 3.00 sec

Plot 9.7: Conducted emissions 16.0 – 26.0 GHz

Test engineer:

Signature : 

Date: March 23, 2000

Printed name : O.H. Hoekstra

## 10 Restricted bands of operation.

The following plots shows the maximum emissions at the band edges. The measurement was performed in accordance with FCC 15.247 (a)

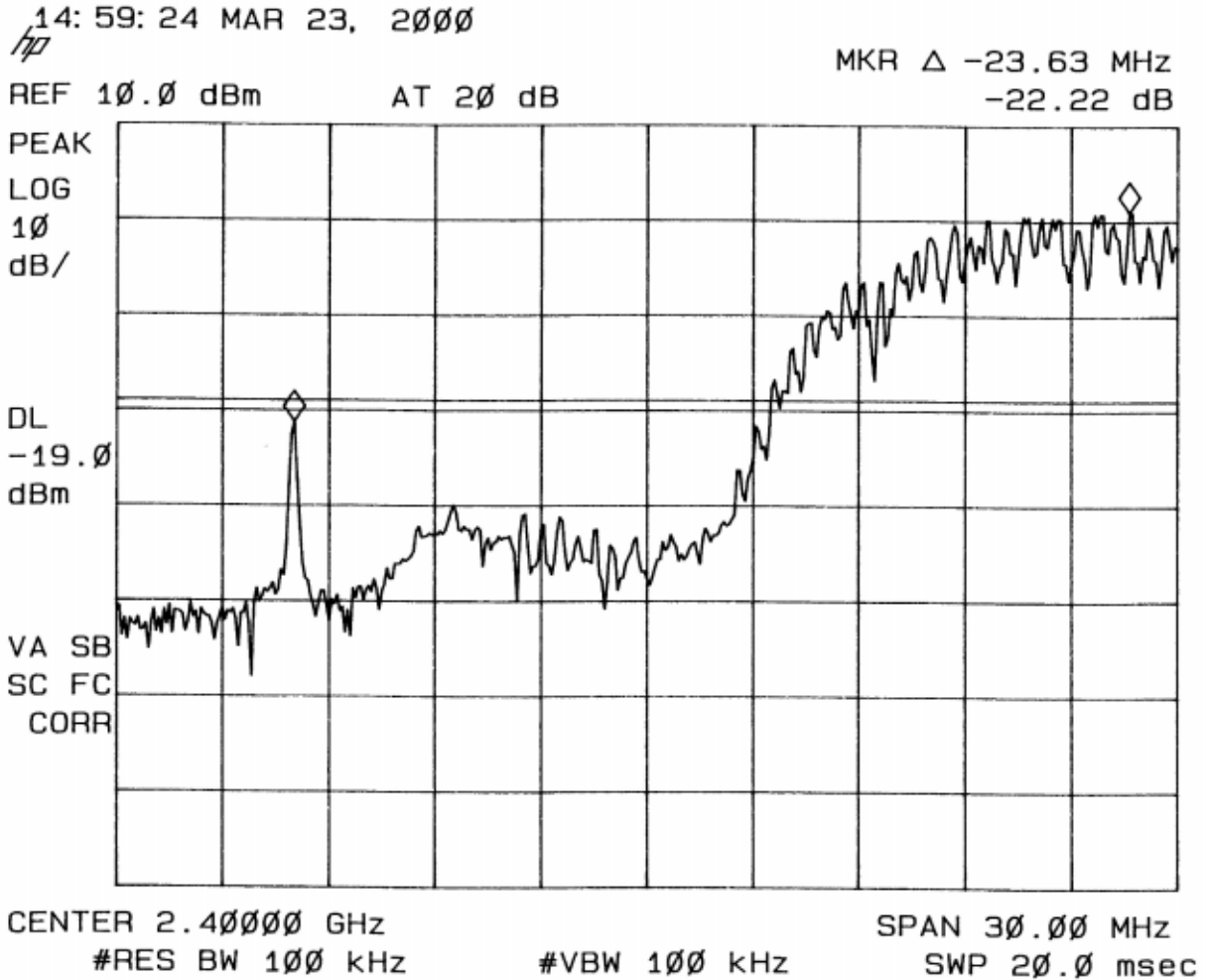

Plot 10.1: Conducted emissions at 2.400 GHz centre frequency

Test engineer:

Signature : 

Date: March 23, 2000

Printed name : O.H. Hoekstra

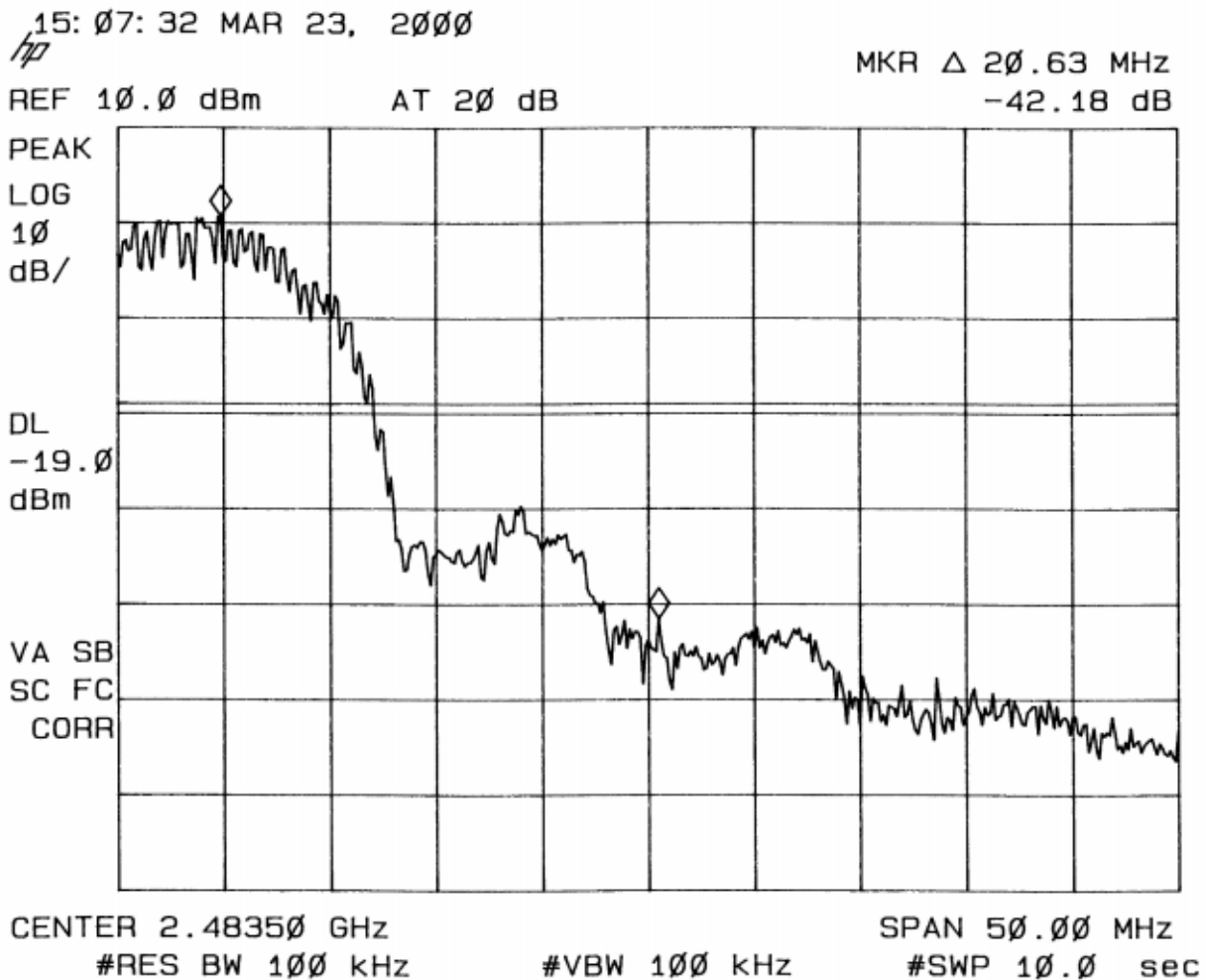

Plot 10.2: Conducted emissions at 2.4835 GHz centre frequency

Test engineer:

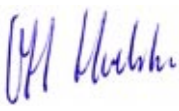
Signature : 

Date: March 23, 2000

Printed name : O.H. Hoekstra

## 11 Peak power density

The peak power measurement was performed in accordance with FCC 15.247 (d)

### 11.1 Channel 1

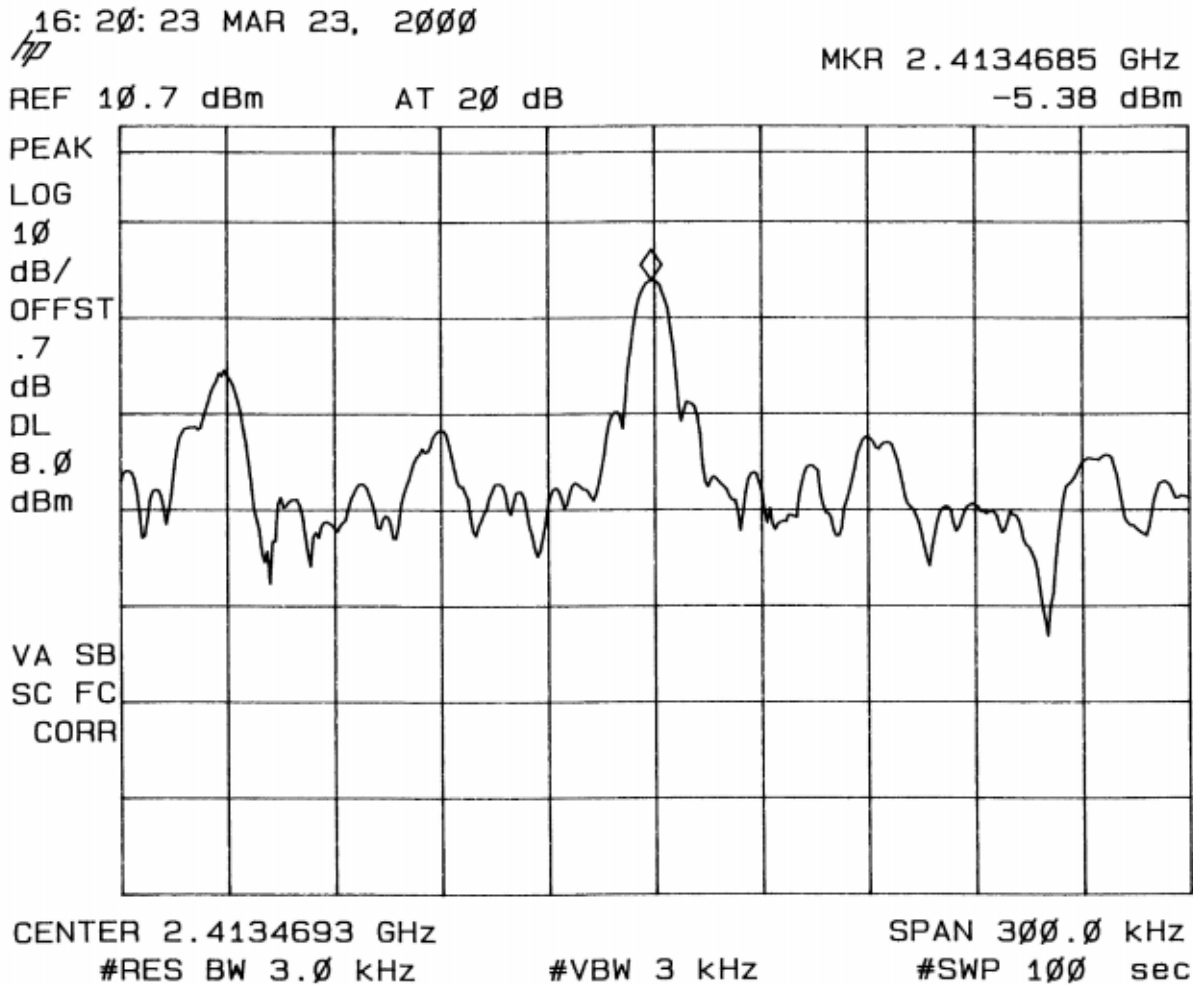

Plot 11.1: Peak Power Spectral Density plot of channel 1

Modulation = 11.0 Mbps

The peak power spectral density on channel 1 : -5.38 dBm.

Test engineer:

Signature : 

Date: March 23, 2000

Printed name : O.H. Hoekstra

### 11.2 Channel 6

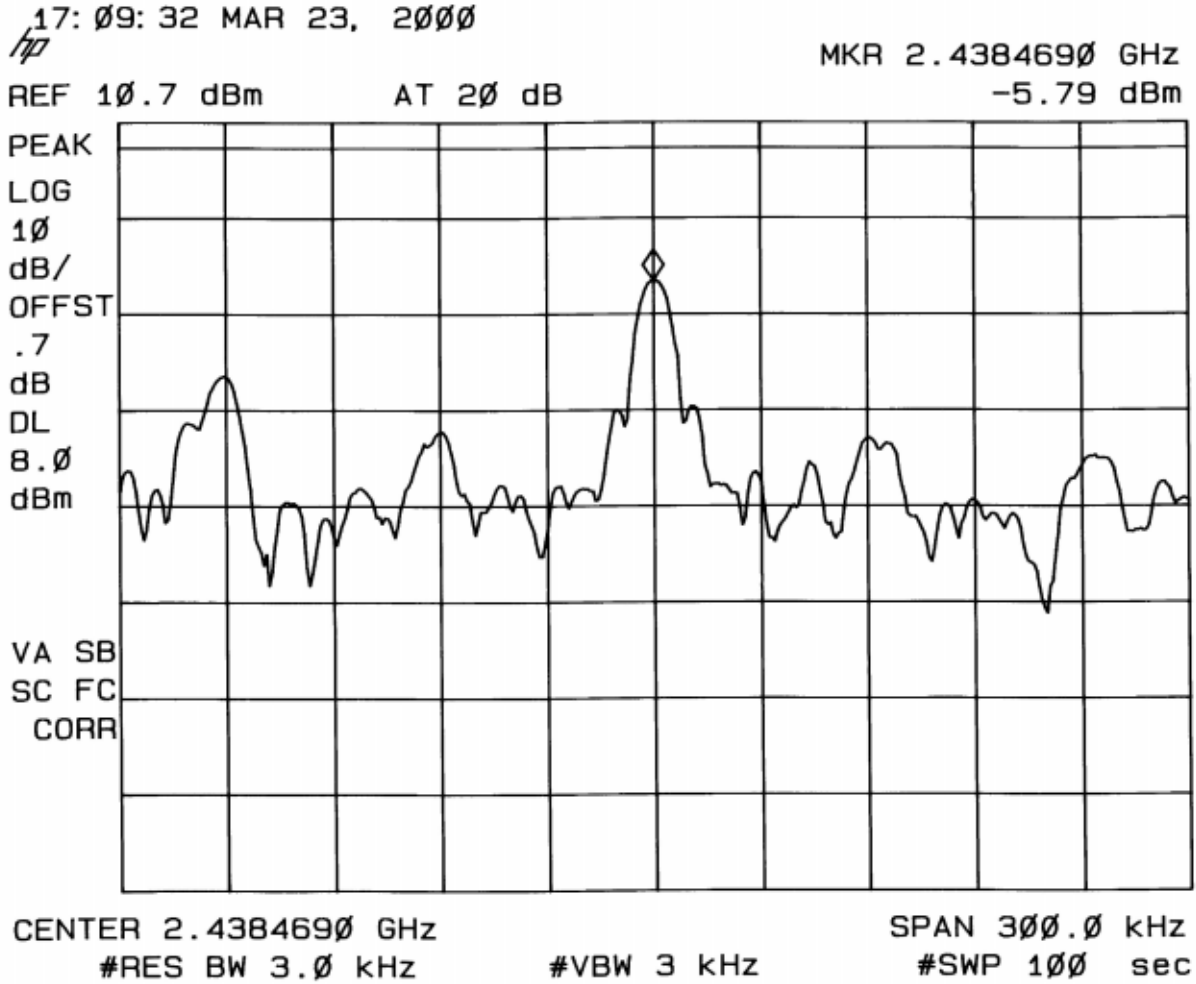

Plot 11.2: Peak Power Spectral Density plot of channel 6

Modulation = 11.0 Mbps

The peak power spectral density on channel 6 : -5.79 dBm.

Test engineer:

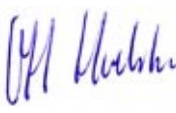
Signature : 

Date: March 23, 2000

Printed name : O.H. Hoekstra

### 11.3 Channel 11

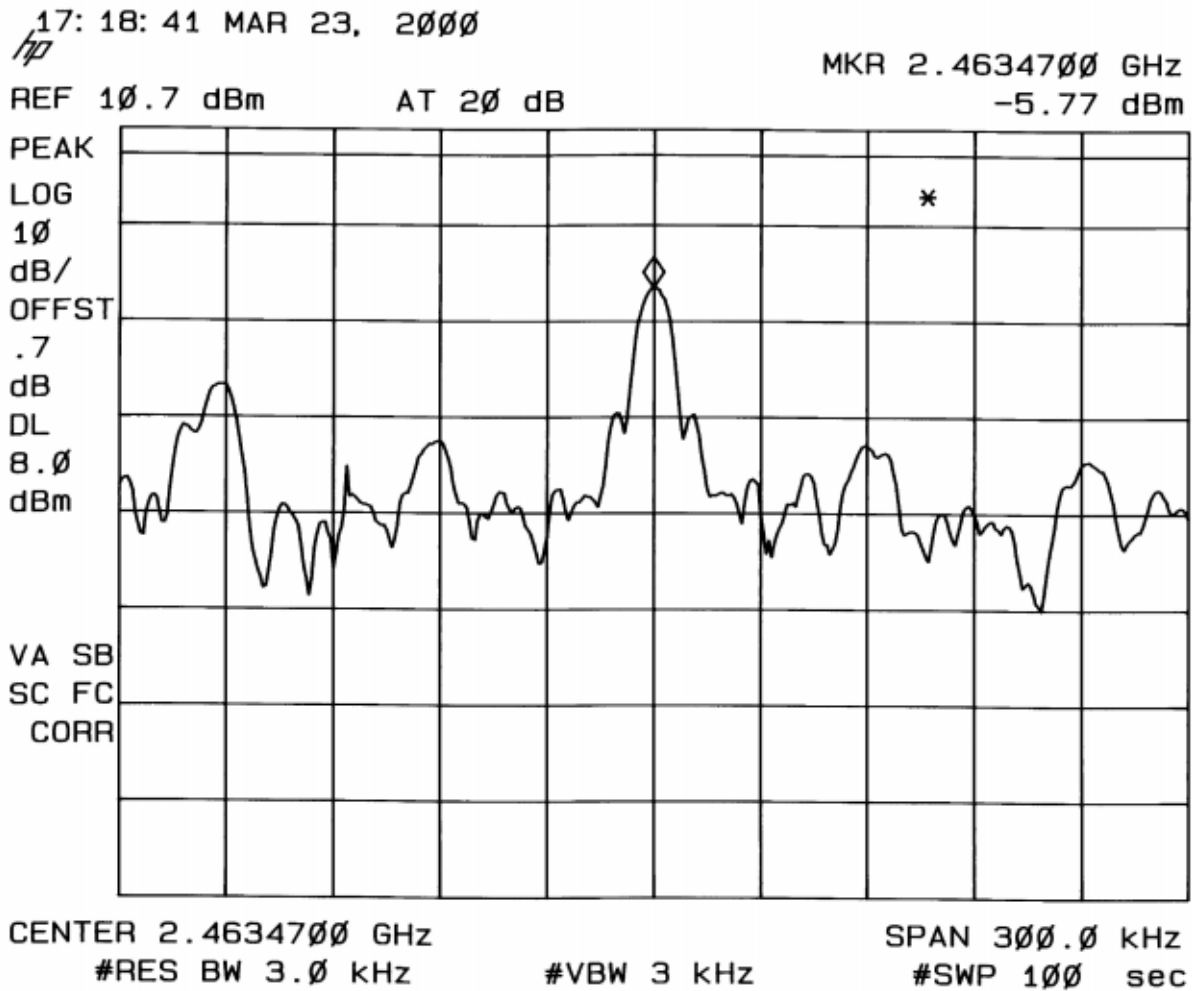

Plot 11.3: Peak Power Spectral Density plot of channel 11

Modulation = 11.0 Mbps

The peak power spectral density on channel 11 : -5.77 dBm.

Test engineer:

Signature : 

Date: March 23, 2000

Printed name : O.H. Hoekstra



## 12 Processing gain

### 12.1 Processing gain at 11.0 Mbps

The processing gain is measured using the CW jamming margin method. A signal generator is stepped in 50 kHz increments across the pass band of the system. At each point the generator level required to produce a Bit Error Rate equivalent to  $BER=1.0 \times 10E-5$  is recorded as the Jammer level (J).

The output power of the transmitter is measured at the same point and recorded as Signal (S).

The Jammer to Signal ratio (J/S) is then calculated with 20% of the worst datapoints discarded.

The lowest remaining J/S ratio is used to calculate the processing gain using formula:

$$G_p = (S/N)_0 + M_j + L_{sys}$$

with:

$(S/N)_0 = E_s/N_0 = E_b/N_0 + \text{correction factor for 8 bits/symbol} = 8 + 10\log(8) = 8 \text{ dB} + 9 \text{ dB} = 17 \text{ dB}$  for 11.0 Mb/s (worst case theoretical value obtained from manufacturer's specification of spreading processor Intersil semiconductor model HFA3861A)

$L_{sys} = 2.0 \text{ dB}$

Measured lowest remaining J/S =  $M_j = -6.8 \text{ dB}$

**$G_p = 17 \text{ dB} + (-6.8 \text{ dB}) + 2.0 \text{ dB} = 12.2 \text{ dB}$  (for 11.0 Mbps modulation)**

Test engineer:

Signature : 

Date: March 23, 2000

Printed name : O.H. Hoekstra

### 12.2 Block diagram CW Jamming test setup

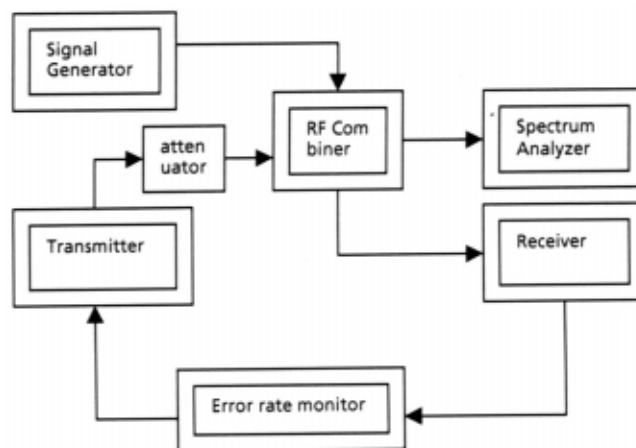

figure 12.1: block diagram of test setup

### 12.3 Processing Gain at 11Mps test results tables

pass band =  $f_0 \pm 5\text{MHz}$  ( 5000 kHz = 100 x 50 kHz)

channel: 07 = 2442.0 MHz 1 of 5 (11Mbps WLAN PC card to 11Mbps WLAN Access Point)

Step	Freq.(MHz)	J(dBm)	S(dBm)	J/S(dB)
100.0	2447.00	-58.2	-57.0	-1.2
99.0	2446.95	-57.9	-57.0	-0.9
98.0	2446.90	-58.7	-57.0	-1.7
97.0	2446.85	-58.3	-57.0	-1.3
96.0	2446.80	-59.7	-57.0	-2.7
95.0	2446.75	-60.0	-57.0	-3.0
94.0	2446.70	-59.3	-57.0	-2.3
93.0	2446.65	-59.5	-57.0	-2.5
92.0	2446.60	-59.3	-57.0	-2.3
91.0	2446.55	-59.2	-57.0	-2.2
90.0	2446.50	-59.0	-57.0	-2.0
89.0	2446.45	-58.5	-57.0	-1.5
88.0	2446.40	-58.0	-57.0	-1.0
87.0	2446.35	-57.8	-57.0	-0.8
86.0	2446.30	-58.2	-57.0	-1.2
85.0	2446.25	-58.5	-57.0	-1.5
84.0	2446.20	-58.9	-57.0	-1.9
83.0	2446.15	-59.4	-57.0	-2.4
82.0	2446.10	-61.0	-57.0	-4.0
81.0	2446.05	-60.2	-57.0	-3.2
80.0	2446.00	-60.6	-57.0	-3.6
79.0	2445.95	-60.9	-57.0	-3.9
78.0	2445.90	-61.0	-57.0	-4.0
77.0	2445.85	-61.4	-57.0	-4.4
76.0	2445.80	-61.7	-57.0	-4.7
75.0	2445.75	-61.5	-57.0	-4.5
74.0	2445.70	-61.7	-57.0	-4.7
73.0	2445.65	-61.9	-57.0	-4.9
72.0	2445.60	-62.2	-57.0	-5.2
71.0	2445.55	-62.5	-57.0	-5.5
70.0	2445.50	-63.7	-57.0	-6.7
69.0	2445.45	-64.0	-57.0	-7.0
68.0	2445.40	-62.5	-57.0	-5.5
67.0	2445.35	-62.7	-57.0	-5.7
66.0	2445.30	-63.6	-57.0	-6.6
65.0	2445.25	-63.4	-57.0	-6.4
64.0	2445.20	-63.4	-57.0	-6.4
63.0	2445.15	-63.3	-57.0	-6.3
62.0	2445.10	-63.1	-57.0	-6.1
61.0	2445.05	-62.8	-57.0	-5.8
60.0	2445.00	-63.5	-57.0	-6.5

Table 12.1 : Processing gain testresults for 11.0 Mbps

channel: 07 = 2442.0 MHz      2 of 5 (11Mbps WLAN PC card to 11Mbps WLAN Access Point)

Step	Freq.(MHz)	J(dBm)	S(dBm)	J/S(dB)
59.0	2444.95	-63.5	-57.0	-6.5
58.0	2444.90	-63.0	-57.0	-6.0
57.0	2444.85	-63.0	-57.0	-6.0
56.0	2444.80	-63.6	-57.0	-6.6
55.0	2444.75	-62.6	-57.0	-5.6
54.0	2444.70	-61.7	-57.0	-4.7
53.0	2444.65	-61.7	-57.0	-4.7
52.0	2444.60	-61.3	-57.0	-4.3
51.0	2444.55	-61.4	-57.0	-4.4
50.0	2444.50	-61.9	-57.0	-4.9
49.0	2444.45	-61.8	-57.0	-4.8
48.0	2444.40	-62.5	-57.0	-5.5
47.0	2444.35	-62.8	-57.0	-5.8
46.0	2444.30	-63.0	-57.0	-6.0
45.0	2444.25	-62.8	-57.0	-5.8
44.0	2444.20	-62.7	-57.0	-5.7
43.0	2444.15	-62.6	-57.0	-5.6
42.0	2444.10	-62.6	-57.0	-5.6
41.0	2444.05	-62.2	-57.0	-5.2
40.0	2444.00	-61.7	-57.0	-4.7
39.0	2443.95	-61.8	-57.0	-4.8
38.0	2443.90	-61.5	-57.0	-4.5
37.0	2443.85	-60.7	-57.0	-3.7
36.0	2443.80	-61.5	-57.0	-4.5
35.0	2443.75	-60.9	-57.0	-3.9
34.0	2443.70	-61.2	-57.0	-4.2
33.0	2443.65	-61.5	-57.0	-4.5
32.0	2443.60	-61.9	-57.0	-4.9
31.0	2443.55	-61.8	-57.0	-4.8
30.0	2443.50	-62.4	-57.0	-5.4
29.0	2443.45	-62.9	-57.0	-5.9
28.0	2443.40	-62.7	-57.0	-5.7
27.0	2443.35	-63.5	-57.0	-6.5
26.0	2443.30	-62.7	-57.0	-5.7
25.0	2443.25	-62.8	-57.0	-5.8
24.0	2443.20	-63.0	-57.0	-6.0
23.0	2443.15	-62.5	-57.0	-5.5
22.0	2443.10	-62.8	-57.0	-5.8
21.0	2443.05	-62.6	-57.0	-5.6
20.0	2443.00	-61.8	-57.0	-4.8

Table 12.2 : Processing gain testresults for 11.0 Mbps

channel: 07 = 2442.0 MHz 3 of 5 (11Mbps WLAN PC card to 11Mbps WLAN Access Point)

Step	Freq.(MHz)	J(dBm)	S(dBm)	J/S(dB)
19.0	2442.95	-62.9	-57.0	-5.9
18.0	2442.90	-62.8	-57.0	-5.8
17.0	2442.85	-63.4	-57.0	-6.4
16.0	2442.80	-64.7	-57.0	-7.7
15.0	2442.75	-65.5	-57.0	-8.5
14.0	2442.70	-66.1	-57.0	-9.1
13.0	2442.65	-63.6	-57.0	-6.6
12.0	2442.60	-64.3	-57.0	-7.3
11.0	2442.55	-64.6	-57.0	-7.6
10.0	2442.50	-63.8	-57.0	-6.8
9.0	2442.45	-63.8	-57.0	-6.8
8.0	2442.40	-62.9	-57.0	-5.9
7.0	2442.35	-62.1	-57.0	-5.1
6.0	2442.30	-62.1	-57.0	-5.1
5.0	2442.25	-62.0	-57.0	-5.0
4.0	2442.20	-62.0	-57.0	-5.0
3.0	2442.15	-62.1	-57.0	-5.1
2.0	2442.10	-62.8	-57.0	-5.8
1.0	2442.05	-64.3	-57.0	-7.3
0.0	2442.00	-64.5	-57.0	-7.5
-1.0	2441.95	-63.9	-57.0	-6.9
-2.0	2441.90	-64.2	-57.0	-7.2
-3.0	2441.85	-63.0	-57.0	-6.0
-4.0	2441.80	-63.1	-57.0	-6.1
-5.0	2441.75	-62.5	-57.0	-5.5
-6.0	2441.70	-62.6	-57.0	-5.6
-7.0	2441.65	-62.7	-57.0	-5.7
-8.0	2441.60	-62.6	-57.0	-5.6
-9.0	2441.55	-63.2	-57.0	-6.2
-10.0	2441.50	-63.5	-57.0	-6.5
-11.0	2441.45	-64.0	-57.0	-7.0
-12.0	2441.40	-63.9	-57.0	-6.9
-13.0	2441.35	-64.5	-57.0	-7.5
-14.0	2441.30	-63.6	-57.0	-6.6
-15.0	2441.25	-65.5	-57.0	-8.5
-16.0	2441.20	-66.5	-57.0	-9.5
-17.0	2441.15	-64.8	-57.0	-7.8
-18.0	2441.10	-64.3	-57.0	-7.3
-19.0	2441.05	-63.9	-57.0	-6.9
-20.0	2441.00	-63.8	-57.0	-6.8

Table 12.3 : Processing gain testresults for 11.0 Mbps

channel: 07 = 2442.0 MHz 4 of 5 (11Mbps WLAN PC card to 11Mbps WLAN Access Point)

Step	Freq.(MHz)	J(dBm)	S(dBm)	J/S(dB)
-21.0	2440.95	-63.6	-57.0	-6.6
-22.0	2440.90	-63.6	-57.0	-6.6
-23.0	2440.85	-63.9	-57.0	-6.9
-24.0	2440.80	-62.8	-57.0	-5.8
-25.0	2440.75	-63.3	-57.0	-6.3
-26.0	2440.70	-63.6	-57.0	-6.6
-27.0	2440.65	-64.2	-57.0	-7.2
-28.0	2440.60	-63.4	-57.0	-6.4
-29.0	2440.55	-64.0	-57.0	-7.0
-30.0	2440.50	-64.4	-57.0	-7.4
-31.0	2440.45	-64.9	-57.0	-7.9
-32.0	2440.40	-64.9	-57.0	-7.9
-33.0	2440.35	-65.0	-57.0	-8.0
-34.0	2440.30	-65.2	-57.0	-8.2
-35.0	2440.25	-64.7	-57.0	-7.7
-36.0	2440.20	-64.4	-57.0	-7.4
-37.0	2440.15	-64.1	-57.0	-7.1
-38.0	2440.10	-63.6	-57.0	-6.6
-39.0	2440.05	-63.3	-57.0	-6.3
-40.0	2440.00	-62.9	-57.0	-5.9
-41.0	2439.95	-62.5	-57.0	-5.5
-42.0	2439.90	-61.9	-57.0	-4.9
-43.0	2439.85	-61.0	-57.0	-4.0
-44.0	2439.80	-61.3	-57.0	-4.3
-45.0	2439.75	-61.0	-57.0	-4.0
-46.0	2439.70	-61.3	-57.0	-4.3
-47.0	2439.65	-61.9	-57.0	-4.9
-48.0	2439.60	-62.2	-57.0	-5.2
-49.0	2439.55	-63.2	-57.0	-6.2
-50.0	2439.50	-62.0	-57.0	-5.0
-51.0	2439.45	-62.6	-57.0	-5.6
-52.0	2439.40	-61.7	-57.0	-4.7
-53.0	2439.35	-62.4	-57.0	-5.4
-54.0	2439.30	-63.0	-57.0	-6.0
-55.0	2439.25	-62.6	-57.0	-5.6
-56.0	2439.20	-62.6	-57.0	-5.6
-57.0	2439.15	-63.3	-57.0	-6.3
-58.0	2439.10	-62.8	-57.0	-5.8
-59.0	2439.05	-62.6	-57.0	-5.6
-60.0	2439.00	-62.5	-57.0	-5.5

Table 12.4 : Processing gain testresults for 11.0 Mbps

channel: 07 = 2442.0 MHz 5 of 5 (11Mbps WLAN PC card to 11Mbps WLAN Access Point)

Step	Freq.(MHz)	J(dBm)	S(dBm)	J/S(dB)
-61.0	2438.95	-62.8	-57.0	-5.8
-62.0	2438.90	-63.2	-57.0	-6.2
-63.0	2438.85	-63.5	-57.0	-6.5
-64.0	2438.80	-64.2	-57.0	-7.2
-65.0	2438.75	-64.9	-57.0	-7.9
-66.0	2438.70	-64.6	-57.0	-7.6
-67.0	2438.65	-64.7	-57.0	-7.7
-68.0	2438.60	-65.2	-57.0	-8.2
-69.0	2438.55	-63.9	-57.0	-6.9
-70.0	2438.50	-65.5	-57.0	-8.5
-71.0	2438.45	-65.5	-57.0	-8.5
-72.0	2438.40	-63.8	-57.0	-6.8
-73.0	2438.35	-63.3	-57.0	-6.3
-74.0	2438.30	-61.7	-57.0	-4.7
-75.0	2438.25	-61.8	-57.0	-4.8
-76.0	2438.20	-60.8	-57.0	-3.8
-77.0	2438.15	-61.7	-57.0	-4.7
-78.0	2438.10	-62.2	-57.0	-5.2
-79.0	2438.05	-62.2	-57.0	-5.2
-80.0	2438.00	-62.2	-57.0	-5.2
-81.0	2437.95	-62.8	-57.0	-5.8
-82.0	2437.90	-62.6	-57.0	-5.6
-83.0	2437.85	-62.3	-57.0	-5.3
-84.0	2437.80	-62.0	-57.0	-5.0
-85.0	2437.75	-61.4	-57.0	-4.4
-86.0	2437.70	-61.6	-57.0	-4.6
-87.0	2437.65	-61.2	-57.0	-4.2
-88.0	2437.60	-61.1	-57.0	-4.1
-89.0	2437.55	-60.8	-57.0	-3.8
-90.0	2437.50	-60.6	-57.0	-3.6
-91.0	2437.45	-61.5	-57.0	-4.5
-92.0	2437.40	-60.7	-57.0	-3.7
-93.0	2437.35	-61.0	-57.0	-4.0
-94.0	2437.30	-60.4	-57.0	-3.4
-95.0	2437.25	-60.4	-57.0	-3.4
-96.0	2437.20	-60.8	-57.0	-3.8
-97.0	2437.15	-61.6	-57.0	-4.6
-98.0	2437.10	-60.2	-57.0	-3.2
-99.0	2437.05	-60.1	-57.0	-3.1
-100.0	2437.00	-59.4	-57.0	-2.4

Table 12.5 : Processing gain testresults for 11.0 Mbps

## 12.4 Processing gain at 2.0 Mbps

The processing gain is measured using the CW jamming margin method. A signal generator is stepped in 50 kHz increments across the passband of the system. At each point the generator level required to produce a Bit Error Rate equivalent to  $BER=10E-5$  is recorded as the Jammer level (J). The output power of the transmitter is measured at the same point and recorded as Signal (S).

The Jammer to Signal ratio (J/S) is then calculated with 20% of the worst datapoints discarded. The lowest remaining J/S ratio is used to calculate the processing gain using formula:

$$G_p = (S/N)_0 + M_j + L_{sys}$$

with:

$(S/N)_0 = E_s/N_0 = E_b/N_0 + \text{correction factor for 8 bits/symbol} = 10.3 + 10\log(8) = 10.3 \text{ dB} + 9 \text{ dB} = 19.3 \text{ dB}$   
for 2.0 Mb/s (worst case theoretical value obtained from manufacturer's specification of spreading processor Intersil semiconductor model HFA3861A)

$L_{sys} = 2.0 \text{ dB}$

Measured lowest remaining J/S =  $M_j = -1.2 \text{ dB}$

$$G_p = 19.3 \text{ dB} + (-1.2) \text{ dB} + 2.0 \text{ dB} = 20.1 \text{ dB (for 2.0 Mbps modulation)}$$

Test engineer:

Signature : 

Date: March 23, 2000

Printed name : O.H. Hoekstra

## 12.5 Processing Gain at 2.0 Mbps testresults tables

pass band =  $f_0 \pm 5\text{MHz}$  ( 5000 kHz = 100 x 50 kHz)

channel: 07 = 2442.0 MHz 1 of 5 (11Mbps WLAN PC card to 11Mbps WLAN Access Point)

Step	Freq.(MHz)	J(dBm)	S(dBm)	J/S(dB)
100	2447.00	-55.8	-57.0	1.2
99	2446.95	-56.5	-57.0	0.5
98	2446.90	-56.4	-57.0	0.6
97	2446.85	-56.6	-57.0	0.4
96	2446.80	-56.8	-57.0	0.2
95	2446.75	-57.6	-57.0	-0.6
94	2446.70	-58.1	-57.0	-1.1
93	2446.65	-57.3	-57.0	-0.3
92	2446.60	-56.8	-57.0	0.2
91	2446.55	-56.1	-57.0	0.9
90	2446.50	-56.7	-57.0	0.3
89	2446.45	-57.4	-57.0	-0.4
88	2446.40	-55.9	-57.0	1.1
87	2446.35	-54.2	-57.0	2.8
86	2446.30	-54.9	-57.0	2.1
85	2446.25	-55.4	-57.0	1.6
84	2446.20	-55.5	-57.0	1.5
83	2446.15	-55.6	-57.0	1.4
82	2446.10	-55.8	-57.0	1.2
81	2446.05	-56.3	-57.0	0.7
80	2446.00	-57.3	-57.0	-0.3
79	2445.95	-58.5	-57.0	-1.5
78	2445.90	-58.0	-57.0	-1.0
77	2445.85	-57.9	-57.0	-0.9
76	2445.80	-57.9	-57.0	-0.9
75	2445.75	-57.7	-57.0	-0.7
74	2445.70	-58.2	-57.0	-1.2
73	2445.65	-57.9	-57.0	-0.9
72	2445.60	-56.3	-57.0	0.7
71	2445.55	-56.1	-57.0	0.9
70	2445.50	-57.9	-57.0	-0.9
69	2445.45	-58.1	-57.0	-1.1
68	2445.40	-54.7	-57.0	2.3
67	2445.35	-55.5	-57.0	1.5
66	2445.30	-56.6	-57.0	0.4
65	2445.25	-56.0	-57.0	1.0
64	2445.20	-56.8	-57.0	0.2
63	2445.15	-57.1	-57.0	-0.1
62	2445.10	-57.3	-57.0	-0.3
61	2445.05	-57.5	-57.0	-0.5
60	2445.00	-58.9	-57.0	-1.9

Table 12.6 : Processing gain testresults for 2.0 Mbps



channel: 07 = 2442.0 MHz      2 of 5 (11Mbps WLAN PC card to 11Mbps WLAN Access Point)

Step	Freq.(MHz)	J(dBm)	S(dBm)	J/S(dB)
59	2444.95	-58.5	-57.0	-1.5
58	2444.90	-58.3	-57.0	-1.3
57	2444.85	-57.9	-57.0	-0.9
56	2444.80	-58.2	-57.0	-1.2
55	2444.75	-58.2	-57.0	-1.2
54	2444.70	-58.1	-57.0	-1.1
53	2444.65	-57.4	-57.0	-0.4
52	2444.60	-56.1	-57.0	0.9
51	2444.55	-56.7	-57.0	0.3
50	2444.50	-58.5	-57.0	-1.5
49	2444.45	-58.7	-57.0	-1.7
48	2444.40	-58.7	-57.0	-1.7
47	2444.35	-57.5	-57.0	-0.5
46	2444.30	-58.8	-57.0	-1.8
45	2444.25	-57.8	-57.0	-0.8
44	2444.20	-57.9	-57.0	-0.9
43	2444.15	-58.0	-57.0	-1.0
42	2444.10	-58.0	-57.0	-1.0
41	2444.05	-57.2	-57.0	-0.2
40	2444.00	-57.6	-57.0	-0.6
39	2443.95	-57.6	-57.0	-0.6
38	2443.90	-57.3	-57.0	-0.3
37	2443.85	-57.5	-57.0	-0.5
36	2443.80	-57.4	-57.0	-0.4
35	2443.75	-57.5	-57.0	-0.5
34	2443.70	-58.0	-57.0	-1.0
33	2443.65	-57.4	-57.0	-0.4
32	2443.60	-57.2	-57.0	-0.2
31	2443.55	-57.5	-57.0	-0.5
30	2443.50	-57.4	-57.0	-0.4
29	2443.45	-58.8	-57.0	-1.8
28	2443.40	-58.4	-57.0	-1.4
27	2443.35	-58.4	-57.0	-1.4
26	2443.30	-58.9	-57.0	-1.9
25	2443.25	-57.5	-57.0	-0.5
24	2443.20	-57.1	-57.0	-0.1
23	2443.15	-57.9	-57.0	-0.9
22	2443.10	-57.7	-57.0	-0.7
21	2443.05	-57.4	-57.0	-0.4
20	2443.00	-57.5	-57.0	-0.5

Table 12.7 : Processing gain testresults for 2.0 Mbps

channel: 07 = 2442.0 MHz      3 of 5 (11Mbps WLAN PC card to 11Mbps WLAN Access Point)

Step	Freq.(MHz)	J(dBm)	S(dBm)	J/S(dB)
19	2442.95	-57.2	-57.0	-0.2
18	2442.90	-57.9	-57.0	-0.9
17	2442.85	-58.7	-57.0	-1.7
16	2442.80	-58.6	-57.0	-1.6
15	2442.75	-59.0	-57.0	-2.0
14	2442.70	-59.4	-57.0	-2.4
13	2442.65	-58.6	-57.0	-1.6
12	2442.60	-58.3	-57.0	-1.3
11	2442.55	-58.1	-57.0	-1.1
10	2442.50	-56.8	-57.0	0.2
9	2442.45	-56.9	-57.0	0.1
8	2442.40	-56.3	-57.0	0.7
7	2442.35	-57.0	-57.0	0.0
6	2442.30	-56.8	-57.0	0.2
5	2442.25	-55.0	-57.0	2.0
4	2442.20	-53.0	-57.0	4.0
3	2442.15	-55.3	-57.0	1.7
2	2442.10	-53.7	-57.0	3.3
1	2442.05	-53.1	-57.0	3.9
0	2442.00	-52.7	-57.0	4.3
-1	2441.95	-52.1	-57.0	4.9
-2	2441.90	-51.9	-57.0	5.1
-3	2441.85	-52.0	-57.0	5.0
-4	2441.80	-53.0	-57.0	4.0
-5	2441.75	-53.1	-57.0	3.9
-6	2441.70	-54.7	-57.0	2.3
-7	2441.65	-55.0	-57.0	2.0
-8	2441.60	-55.3	-57.0	1.7
-9	2441.55	-56.1	-57.0	0.9
-10	2441.50	-55.8	-57.0	1.2
-11	2441.45	-56.1	-57.0	0.9
-12	2441.40	-57.0	-57.0	0.0
-13	2441.35	-58.7	-57.0	-1.7
-14	2441.30	-59.9	-57.0	-2.9
-15	2441.25	-58.1	-57.0	-1.1
-16	2441.20	-59.0	-57.0	-2.0
-17	2441.15	-59.6	-57.0	-2.6
-18	2441.10	-59.6	-57.0	-2.6
-19	2441.05	-57.9	-57.0	-0.9
-20	2441.00	-57.9	-57.0	-0.9

Table 12.8 : Processing gain testresults for 2.0 Mbps

channel: 07 = 2442.0 MHz 4 of 5 (11Mbps WLAN PC card to 11Mbps WLAN Access Point)

Step	Freq.(MHz)	J(dBm)	S(dBm)	J/S(dB)
-21	2440.95	-58.0	-57.0	-1.0
-22	2440.90	-57.9	-57.0	-0.9
-23	2440.85	-56.7	-57.0	0.3
-24	2440.80	-56.9	-57.0	0.1
-25	2440.75	-57.4	-57.0	-0.4
-26	2440.70	-56.9	-57.0	0.1
-27	2440.65	-56.6	-57.0	0.4
-28	2440.60	-56.4	-57.0	0.6
-29	2440.55	-57.2	-57.0	-0.2
-30	2440.50	-55.7	-57.0	1.3
-31	2440.45	-57.0	-57.0	0.0
-32	2440.40	-57.6	-57.0	-0.6
-33	2440.35	-58.7	-57.0	-1.7
-34	2440.30	-60.0	-57.0	-3.0
-35	2440.25	-58.1	-57.0	-1.1
-36	2440.20	-58.1	-57.0	-1.1
-37	2440.15	-58.4	-57.0	-1.4
-38	2440.10	-58.6	-57.0	-1.6
-39	2440.05	-57.7	-57.0	-0.7
-40	2440.00	-58.2	-57.0	-1.2
-41	2439.95	-57.6	-57.0	-0.6
-42	2439.90	-57.0	-57.0	0.0
-43	2439.85	-57.1	-57.0	-0.1
-44	2439.80	-57.2	-57.0	-0.2
-45	2439.75	-57.7	-57.0	-0.7
-46	2439.70	-57.6	-57.0	-0.6
-47	2439.65	-56.9	-57.0	0.1
-48	2439.60	-56.4	-57.0	0.6
-49	2439.55	-57.3	-57.0	-0.3
-50	2439.50	-60.2	-57.0	-3.2
-51	2439.45	-60.3	-57.0	-3.3
-52	2439.40	-58.3	-57.0	-1.3
-53	2439.35	-57.3	-57.0	-0.3
-54	2439.30	-58.5	-57.0	-1.5
-55	2439.25	-57.5	-57.0	-0.5
-56	2439.20	-57.2	-57.0	-0.2
-57	2439.15	-57.2	-57.0	-0.2
-58	2439.10	-57.3	-57.0	-0.3
-59	2439.05	-57.4	-57.0	-0.4
-60	2439.00	-57.9	-57.0	-0.9

Table 12.9 : Processing gain testresults for 2.0 Mbps

channel: 07 = 2442.0 MHz 5 of 5 (11Mbps WLAN PC card to 11Mbps WLAN Access Point)

Step	Freq.(MHz)	J(dBm)	S(dBm)	J/S(dB)
-61	2438.95	-57.9	-57.0	-0.9
-62	2438.90	-57.6	-57.0	-0.6
-63	2438.85	-57.2	-57.0	-0.2
-64	2438.80	-57.5	-57.0	-0.5
-65	2438.75	-57.7	-57.0	-0.7
-66	2438.70	-58.3	-57.0	-1.3
-67	2438.65	-58.1	-57.0	-1.1
-68	2438.60	-56.7	-57.0	0.3
-69	2438.55	-56.4	-57.0	0.6
-70	2438.50	-58.1	-57.0	-1.1
-71	2438.45	-59.2	-57.0	-2.2
-72	2438.40	-58.3	-57.0	-1.3
-73	2438.35	-56.9	-57.0	0.1
-74	2438.30	-56.8	-57.0	0.2
-75	2438.25	-57.9	-57.0	-0.9
-76	2438.20	-57.8	-57.0	-0.8
-77	2438.15	-58.3	-57.0	-1.3
-78	2438.10	-58.9	-57.0	-1.9
-79	2438.05	-57.1	-57.0	-0.1
-80	2438.00	-58.1	-57.0	-1.1
-81	2437.95	-58.8	-57.0	-1.8
-82	2437.90	-57.5	-57.0	-0.5
-83	2437.85	-57.3	-57.0	-0.3
-84	2437.80	-56.7	-57.0	0.3
-85	2437.75	-57.1	-57.0	-0.1
-86	2437.70	-56.7	-57.0	0.3
-87	2437.65	-57.1	-57.0	-0.1
-88	2437.60	-55.3	-57.0	1.7
-89	2437.55	-54.6	-57.0	2.4
-90	2437.50	-56.2	-57.0	0.8
-91	2437.45	-57.3	-57.0	-0.3
-92	2437.40	-56.8	-57.0	0.2
-93	2437.35	-55.6	-57.0	1.4
-94	2437.30	-56.8	-57.0	0.2
-95	2437.25	-58.2	-57.0	-1.2
-96	2437.20	-58.5	-57.0	-1.5
-97	2437.15	-58.3	-57.0	-1.3
-98	2437.10	-58.0	-57.0	-1.0
-99	2437.05	-57.7	-57.0	-0.7
-100	2437.00	-57.9	-57.0	-0.9

Table 12.10 : Processing gain testresults for 2.0 Mbps