



# TEST REPORT

**Test Report No.:** UL-RPT-RP-14419317-216-FCC

**Applicant** : Grundfos Holding A/S  
**Model No.** : 92710890  
**FCC ID** : OG3-UP001  
**Technology** : Bluetooth – Low Energy  
**Test Standard(s)** : FCC Parts 15.207, 15.209(a) & 15.247

For details of applied tests refer to test result summary

1. This test report shall not be reproduced in full or partial, without the written approval of UL International Germany GmbH.
2. The results in this report apply only to the sample tested.
3. The test results in this report are traceable to the national or international standards.
4. Test Report Version 1.0
5. Result of the tested sample: **PASS**

Prepared by: Sercan Usta  
Title: Project Engineer  
Date: 17 November 2022

Approved by: Rachid, Acharkaoui  
Title: Operations Manager  
Date: 17 November 2022



Deutsche  
Akkreditierungsstelle  
D-PL-19381-02-00

This laboratory is accredited by DAkkS.  
The tests reported herein have been performed in  
accordance with its' terms of accreditation.

This page has been left intentionally blank.

## **Table of Contents**

<b>1. Customer Information.....</b>	<b>4</b>
1.1. Applicant Information	4
1.2. Manufacturer Information	4
<b>2. Summary of Testing.....</b>	<b>5</b>
2.1. General Information	5
Applied FCC Rule Part(s)	5
Location	5
Date Information	5
2.2. Summary of Test Results	6
2.3. Methods and Procedures	6
2.4. Deviations from the Test Specification	6
<b>3. Equipment Under Test (EUT) .....</b>	<b>7</b>
3.1. Identification of Equipment Under Test (EUT)	7
3.2. Description of EUT	7
3.3. Modifications Incorporated in the EUT	7
3.4. Additional Information Related to Testing	8
3.5. Support Equipment	8
A. Support Equipment (In-house)	8
B. Support Equipment (Manufacturer supplied)	8
<b>4. Operation and Monitoring of the EUT during Testing .....</b>	<b>9</b>
4.1. Operating Modes	9
4.2. Configuration and Peripherals	10
<b>5. Measurements, Examinations and Derived Results .....</b>	<b>11</b>
5.1. General Comments	11
5.2. Test Results	12
5.2.1. Transmitter AC Conducted Spurious Emissions	12
5.2.2. Transmitter 6 dB Bandwidth	18
5.2.3. Transmitter Maximum Peak Output Power	20
5.2.4. Transmitter Radiated Emissions	23
Transmitter Radiated Emissions (continued)	26
Transmitter Radiated Emissions (continued)	28
5.2.5. Transmitter Band Edge Radiated Emissions	34
<b>6. Measurement Uncertainty .....</b>	<b>38</b>
<b>7. Used equipment .....</b>	<b>39</b>
<b>8. Report Revision History .....</b>	<b>40</b>

## **1. Customer Information**

### **1.1. Applicant Information**

<b>Company Name:</b>	Grundfos Holding A/S
<b>Company Address:</b>	Poul Due Jensens Vej 7, DK-8850 Bjerringbro, Denmark
<b>Contact Person:</b>	Kristian Baasch Thomsen
<b>Contact E-Mail Address:</b>	productcompliance@grundfos.com
<b>Contact Phone No.:</b>	+4587501400

### **1.2. Manufacturer Information**

<b>Company Name:</b>	Grundfos Holding A/S
<b>Company Address:</b>	Poul Due Jensens Vej 7, DK-8850 Bjerringbro, Denmark
<b>Contact Person:</b>	Thomas Young Olesen
<b>Contact E-Mail Address:</b>	productcompliance@grundfos.com
<b>Contact Phone No.:</b>	+4587501400

## **2. Summary of Testing**

### **2.1. General Information**

#### **Applied FCC Rule Part(s)**

<b>Specification Reference:</b>	47CFR15.247
<b>Specification Title:</b>	Code of Federal Regulations Volume 47 (Telecommunications): Part 15 Subpart C (Intentional Radiators) - Section 15.247
<b>Specification Reference:</b>	47CFR15.207 and 47CFR15.209
<b>Specification Title:</b>	Code of Federal Regulations Volume 47 (Telecommunications): Part 15 Subpart C (Intentional Radiators) - Sections 15.207 and 15.209

#### **Location**

<b>Location of Testing:</b>	UL International Germany GmbH Hedelfinger Strasse. 61, 70327 Stuttgart, GERMANY
<b>Registration Number:</b>	399704

#### **Date Information**

<b>Order Date:</b>	14 July 2022
<b>EUT Arrived:</b>	01 September 2022
<b>Test Dates:</b>	05 September 2022 to 12 October 2022
<b>EUT Returned:</b>	-/-

**2.2. Summary of Test Results**

DIGITAL TRANSMISSION SYSTEMS (DTS): 2400-2483.5 MHz					
FCC Part 15 Clause	Compliance Test Description	Test Result			
		C	N.C.	N.P.	N.A.
15.207	Transmitter AC Power Line Conducted Emissions	<input checked="" type="checkbox"/>	<input type="checkbox"/>	<input type="checkbox"/>	<input type="checkbox"/>
15.35(c)	Transmitter Duty Cycle	<input type="checkbox"/>	<input type="checkbox"/>	<input checked="" type="checkbox"/>	<input type="checkbox"/>
15.247(a)(2)	Transmitter Minimum 6 dB Bandwidth	<input checked="" type="checkbox"/>	<input type="checkbox"/>	<input type="checkbox"/>	<input type="checkbox"/>
15.247(b)(3)	Transmitter Maximum Peak Output Power	<input checked="" type="checkbox"/>	<input type="checkbox"/>	<input type="checkbox"/>	<input type="checkbox"/>
15.247(e)	Transmitter Power Spectral Density <sup>(1)</sup>	<input type="checkbox"/>	<input type="checkbox"/>	<input checked="" type="checkbox"/>	<input type="checkbox"/>
15.247(d) & 15.209(a)	Transmitter Conducted Emissions <sup>(2)</sup>	<input type="checkbox"/>	<input type="checkbox"/>	<input checked="" type="checkbox"/>	<input type="checkbox"/>
15.247(d) & 15.209(a)	Transmitter Radiated Emissions	<input checked="" type="checkbox"/>	<input type="checkbox"/>	<input type="checkbox"/>	<input type="checkbox"/>
15.247(d) & 15.209(a)	Transmitter Band Edge Radiated Emissions	<input checked="" type="checkbox"/>	<input type="checkbox"/>	<input type="checkbox"/>	<input type="checkbox"/>

**C: COMPLIED | N.C.: NOT COMPLIED | N.P.: NOT PERFORMED | N.A.: NOT APPLICABLE**

**Note(s):**

1. In accordance with ANSI C63.10-2013 Section 11.10.1, PSD is not required if the maximum conducted output power is less than the PSD limit of 8 dBm / 3 kHz. The PSD level is therefore deemed to be equal to the measured total output power.
2. The Spurious emission measurements were performed Radiated and therefore conducted emissions were not required.

**2.3. Methods and Procedures**

<b>Reference:</b>	ANSI C63.10-2013
<b>Title:</b>	American National Standard of Procedures for Compliance Testing of Unlicensed Wireless Devices
<b>Reference:</b>	FCC KDB 558074 D01 DTS Meas Guidance v05r02 April 2, 2019
<b>Title:</b>	Guidance for compliance measurements on Digital Transmission System, Frequency Hopping Spread Spectrum System, and Hybrid System Devices Operating Under Section 15.247 of the FCC rules
<b>Reference:</b>	FCC KDB 174176 D01 Line Conducted FAQ v01r01 June 3, 2015
<b>Title:</b>	AC Power-Line Conducted Emissions Frequently Asked Questions

**2.4. Deviations from the Test Specification**

For the measurements contained within this test report, there were no deviations from, additions to, or exclusions from the test specification identified above.

### **3. Equipment Under Test (EUT)**

#### **3.1. Identification of Equipment Under Test (EUT)**

<b>Brand Name:</b>	Grundfos
<b>Model Name or Number:</b>	92710890
<b>Test Sample Serial Number:</b>	No 3 (Radiated Test Sample)
<b>Hardware Version Number:</b>	R08
<b>Firmware Version Number:</b>	92811431V05.00.10.00001
<b>FCC ID:</b>	OG3-UP001

<b>Brand Name:</b>	Grundfos
<b>Model Name or Number:</b>	92710890
<b>Test Sample Serial Number:</b>	No 1 (Conducted Test Sample)
<b>Hardware Version Number:</b>	R08
<b>Firmware Version Number:</b>	92811431V05.00.10.00001
<b>FCC ID:</b>	OG3-UP001

#### **3.2. Description of EUT**

The equipment under test was Radio module PCBA for Grundfos pumps providing smart device connectivity, with Model Name. 92710890; supporting Bluetooth Low Energy operations in 2400-2483.5MHz ISM band.

#### **3.3. Modifications Incorporated in the EUT**

No modifications were applied to the EUT during testing.

**3.4. Additional Information Related to Testing**

<b>Technology Tested:</b>	Bluetooth – Low Energy		
<b>FCC Equipment Classification:</b>	Digital Transmission System (DTS)		
<b>Type of Unit:</b>	Transceiver		
<b>Operating Frequency Range:</b>	2402 MHz to 2480 MHz		
<b>Channel Spacing:</b>	2 MHz		
<b>Tested Data Rate(s) &amp; Modulation(s):</b>	1 Mbps	GFSK	
<b>Maximum Conducted Output Power:</b>	3.27 dBm		
<b>Declared Antenna Gain:</b>	Max -0.41 dBi		
<b>Antenna Type:</b>	IFA		
<b>Antenna Details:</b>	PIFA Coplanar Inverted F Antenna, Grundfos		
<b>Transmit Channels Tested:</b>	<b>Channel ID</b>	<b>RF Channel</b>	<b>Frequency (MHz)</b>
	Bottom	37	2402
	Middle	17	2440
	Top	39	2480
<b>Power Supply Requirement(s):</b>	5V DC with USB-UART cable via Laptop		
<b>Highest internally generated clock and/ or oscillator frequency:</b>	2480 MHz BLE upper TX frequency		

**3.5. Support Equipment**

The following support equipment was used to exercise the EUT during testing:

**A. Support Equipment (In-house)**

Item	Description	Brand Name	Model Name or Number	Serial Number
1	DC Power Supply	Aim TTi	CPX400S	507111

**B. Support Equipment (Manufacturer supplied)**

Item	Description	Brand Name	Model Name or Number	Serial Number
1	Laptop PC with Test Software: BleServiceTool	HP	Probook 645 G2	5CG608372G
2	AC/DC charger	HP	740015-003	-/-
3	USB-UART Cable	-/-	-/-	-/-



## **4. Operation and Monitoring of the EUT during Testing**

### **4.1. Operating Modes**

The EUT was tested in the following operating mode(s):

- BT-LE Test Mode: Continuously transmitting modulated carrier with combination of
- Data Rate: 1 Mbps
  - Packet Type: PRBS9
  - Power Settings: Max
  - Channel: Bottom / Middle / Top

## **4.2. Configuration and Peripherals**

The EUT was tested in the following configuration(s):

- The applicant or manufacturer supplied test setup instructions “BLE tool approval measurement TX.pdf” issued on 30.09.2022 was used to configure the EUT.
- In accordance with FCC rule section(s) 15.212(a)(1)(v), the EUT being a modular transmitter was tested in a stand-alone configuration.
  - The EUT was not placed inside another device during testing for compliance requirements.
  - The EUT was mounted on a stand-alone PCB with voltage supply & RF control settings connections made directly to the module via a USB to UART cable.

### **EUT Power Supply:**

- The EUT was powered with 5 V DC through an USB-UART Cable via laptop.

### **Test Mode Activation:**

- The EUT can be connected with the Test laptop via USB-UART cable supplied by the customer. The cable was also connected during the measurement. The laptop was placed away from the measurement field.
- The test modes were activated using the test software / Radio Tool “BleServiceTool”. This test software / Radio Tool was installed on the customer test laptop to enable continuous transmission and to select the required test channels.

### **AC Conducted Emissions Measurements:**

- The EUT radiated sample was used for AC conducted emissions measurement.
- For AC conducted line emissions measurement the EUT was powered with an USB-UART Cable via Laptop. The laptop with its charger was in turn connected with the LISN. The measurements were carried out with 120 VAC / 60 Hz & 240 VAC / 60 Hz.
- The Toyo EMI Software EP5/CE Ver 4.0.1. was used for these measurements.

### **Conducted Measurements:**

- All conducted measurements were carried out by using the EUT RF sample with SMA cable soldered on to the PCB. The SMA RF cable's attenuation (maximum 0.5 dB@2.4GHz) was added to as a reference level offset to each of the conducted plots.

### **Radiated Measurements:**

- The EUT radiated sample was used for radiated spurious emission and band edge measurements.
- Before starting the measurement, the EUT was evaluated for the worst-case position w.r.t to maximum radiated power measured in standing, laying and 45° tilting positions. The EUT in laying position was found out to be the worst-case. Therefore, this report includes relevant results.
- Radiated measurements below 30 MHz were performed with the EUT positioned on the turn table and rotating 360 degrees while the loop antenna height was set at 100 cm.
- Radiated measurements above 30 MHz were performed with the EUT positioned on the turn table and rotating 360 degrees while the antenna height varies from 1 to 4 m over the measurement frequency range.
- R&S® EMC32 V11.30.00 Software was used for the Radiated spurious emission measurements.

### **Duty Cycle Correction Details:**

- As the continuous transmission of the EUT ( $D \geq 98\%$ ) can be achieved and EUT was transmitting continuously with 100% duty cycle (+/- 2% tolerance). No Duty Cycle Correction Factors were added to all average measurements.

## **5. Measurements, Examinations and Derived Results**

### **5.1. General Comments**

Measurement uncertainties are evaluated in accordance with current best practice. Our reported expanded uncertainties are based on standard uncertainties, which are multiplied by an appropriate coverage factor to provide a statistical confidence level of approximately 95%. Please refer to Section 6 *Measurement Uncertainty* for details.

In accordance with DAkkS requirements all the measurement equipment is on a calibration schedule. All equipment was within the calibration period on the date of testing.

**5.2. Test Results**

**5.2.1. Transmitter AC Conducted Spurious Emissions**

**Test Summary:**

<b>Test Engineer:</b>	Muhammad Faiq Khan	<b>Test Date:</b>	14 October 2022
<b>Test Sample Serial Number:</b>	No 3 (Radiated Test Sample)		
<b>Test Site Identification</b>	SR 7/8		

<b>FCC Reference:</b>	Part 15.207
<b>Test Method Used:</b>	ANSI C63.10 Section 6.2 / FCC KDB 174176 and notes below

**Environmental Conditions:**

<b>Temperature (°C):</b>	23.4
<b>Relative Humidity (%):</b>	41.8

**Settings of the Instrument**

<b>Detector</b>	Quasi Peak/ Average Peak
-----------------	--------------------------

**Note(s):**

1. In accordance with FCC KDB 174176 Q4, tests were also performed with a 240 VAC 60 Hz single phase supply as this was within the voltage range marked on the 100-240 VAC~50/60 Hz power supply.
2. For the AC conducted line emissions measurement the EUT was powered with an USB-UART Cable via Laptop. The laptop with its charger was in turn connected with the LISN. The measurements were carried out with 120 VAC / 60 Hz & 240 VAC / 60 Hz.
3. The EUT was configured with the following worst-case mode:
  - BT-LE | 1 Mbps | PRBS9 | PWR Max | Mid Channel
4. Pre-scans were performed, and markers placed on the highest live and neutral measured levels. Final measurements were performed on the marker frequencies and the results entered into the tables below.
5. The final measured value, for the given emission, in the table below incorporates the cable loss.
6. Measurements were performed in shielded room (SR7/ 8 Asset Number 1603671). The EUT was placed at a height of 80 cm above the reference ground plane and in a distance of 40 cm from the vertical ground plane at the edge of the table.
7. Measurement software used: Toyo EMI Software; CE measurement software EP5/CE Ver 4.0.1.

**Test Setup:**

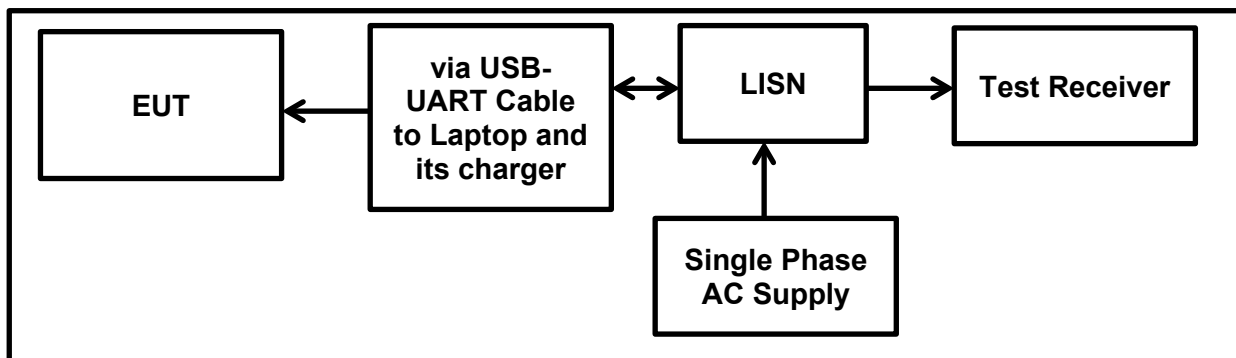

**Transmitter AC Conducted Spurious Emissions (continued)****Results: BT-LE / 1 Mbps / PRBS9 / PWR Max / Mid Channel****Results: Live / Quasi Peak / 120 VAC 60 Hz**

Frequency (MHz)	Line	Level (dB $\mu$ V)	Limit (dB $\mu$ V)	Margin (dB)	Result
0.15433	Live	50.50	65.80	15.30	Complied
0.16985	Live	55.90	65.00	9.10	Complied
0.18375	Live	48.00	64.30	16.30	Complied
0.24694	Live	40.40	61.90	21.50	Complied
0.26184	Live	41.20	61.40	20.20	Complied
9.05593	Live	34.10	60.00	25.90	Complied
14.1223	Live	28.10	60.00	31.90	Complied

**Results: Live / Average / 120 VAC 60 Hz**

Frequency (MHz)	Line	Level (dB $\mu$ V)	Limit (dB $\mu$ V)	Margin (dB)	Result
0.15433	Live	25.50	55.80	30.30	Complied
0.16985	Live	41.20	55.00	13.80	Complied
0.18375	Live	24.60	54.30	29.70	Complied
0.24694	Live	17.00	51.90	34.90	Complied
0.26184	Live	17.40	51.40	34.00	Complied
9.05593	Live	27.10	50.00	22.90	Complied
14.1223	Live	22.20	50.00	27.80	Complied

**Results: Neutral / Quasi Peak / 120 VAC 60 Hz**

Frequency (MHz)	Line	Level (dB $\mu$ V)	Limit (dB $\mu$ V)	Margin (dB)	Result
0.15468	Neutral	44.60	65.70	21.10	Complied
0.18378	Neutral	55.60	64.30	8.70	Complied
0.19283	Neutral	49.10	63.90	14.80	Complied
0.23199	Neutral	47.50	62.40	14.90	Complied
0.24713	Neutral	42.20	61.90	19.70	Complied
0.30511	Neutral	38.00	60.10	22.10	Complied
4.4462	Neutral	33.00	56.00	23.00	Complied
8.84707	Neutral	26.10	60.00	33.90	Complied
13.2233	Neutral	30.50	60.00	29.50	Complied

**Transmitter AC Conducted Spurious Emissions (continued)**

**Results: BT-LE / 1 Mbps / PRBS9 / PWR Max / Mid Channel**

**Results: Neutral / Average / 120 VAC 60 Hz**

Frequency (MHz)	Line	Level (dB $\mu$ V)	Limit (dB $\mu$ V)	Margin (dB)	Result
0.15468	Neutral	19.40	55.70	36.30	Complied
0.18378	Neutral	40.10	54.30	14.20	Complied
0.19283	Neutral	28.20	53.90	25.70	Complied
0.23199	Neutral	32.40	52.40	20.00	Complied
0.24713	Neutral	26.80	51.90	25.10	Complied
0.30511	Neutral	18.80	50.10	31.30	Complied
4.4462	Neutral	16.30	46.00	29.70	Complied
8.84707	Neutral	28.80	50.00	21.20	Complied
13.2233	Neutral	27.10	50.00	22.90	Complied

**Result: Pass**

**Plot: Live and Neutral Line / 120 VAC 60 Hz**

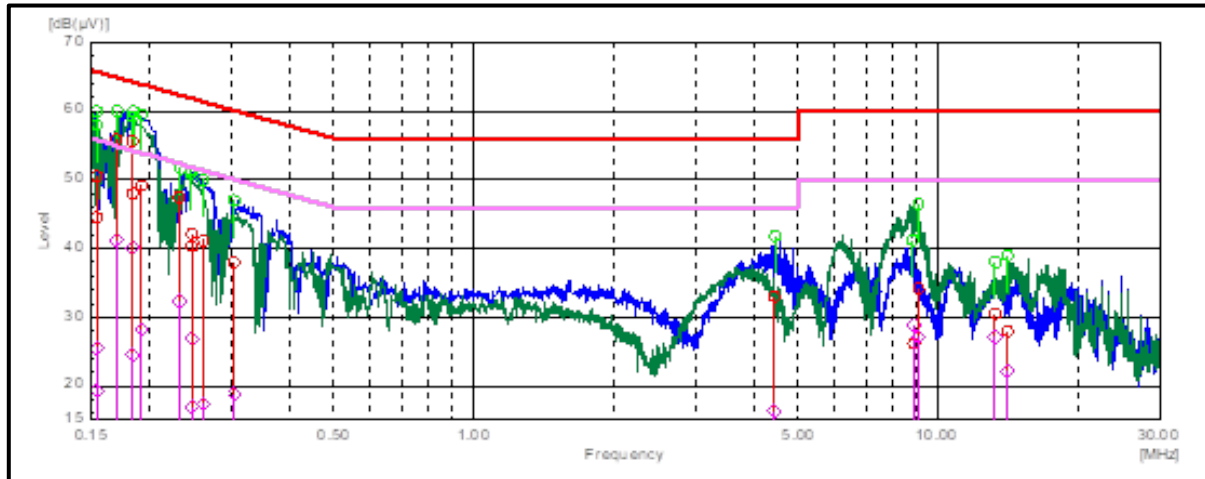

*Note: These plots are pre-scans and for indication purposes only. For final measurements, see accompanying tables.*

**Transmitter AC Conducted Spurious Emissions (continued)****Results: BT-LE / 1 Mbps / PRBS9 / PWR Max / Mid Channel****Results: Live / Quasi Peak / 240 VAC 60 Hz**

Frequency (MHz)	Line	Level (dB $\mu$ V)	Limit (dB $\mu$ V)	Margin (dB)	Result
0.15292	Live	49.50	65.80	16.30	Complied
0.21321	Live	42.20	63.10	20.90	Complied
0.23059	Live	43.60	62.40	18.80	Complied
0.27698	Live	38.10	60.90	22.80	Complied
0.30406	Live	33.10	60.10	27.00	Complied
0.99820	Live	16.70	56.00	39.30	Complied
2.92186	Live	22.30	56.00	33.70	Complied
3.19978	Live	24.40	56.00	31.60	Complied
5.37485	Live	26.40	60.00	33.60	Complied
11.31269	Live	25.90	60.00	34.10	Complied
11.66142	Live	21.50	60.00	38.50	Complied
21.77698	Live	26.30	60.00	33.70	Complied
24.40371	Live	27.00	60.00	33.00	Complied

**Results: Live / Average / 240 VAC 60 Hz**

Frequency (MHz)	Line	Level (dB $\mu$ V)	Limit (dB $\mu$ V)	Margin (dB)	Result
0.15292	Live	29.10	55.80	26.70	Complied
0.21321	Live	25.70	53.10	27.40	Complied
0.23059	Live	26.50	52.40	25.90	Complied
0.27698	Live	21.90	50.90	29.00	Complied
0.30406	Live	17.90	50.10	32.20	Complied
0.99820	Live	12.20	46.00	33.80	Complied
2.92186	Live	16.40	46.00	29.60	Complied
3.19978	Live	18.70	46.00	27.30	Complied
5.37485	Live	17.50	50.00	32.50	Complied
11.31269	Live	22.60	50.00	27.40	Complied
11.66142	Live	14.80	50.00	35.20	Complied
21.77698	Live	20.20	50.00	29.80	Complied
24.40371	Live	21.00	50.00	29.00	Complied

**Transmitter AC Conducted Spurious Emissions (continued)****Results: BT-LE / 1 Mbps / PRBS9 / PWR Max / Mid Channel****Results: Neutral / Quasi Peak / 240 VAC 60 Hz**

Frequency (MHz)	Line	Level (dB $\mu$ V)	Limit (dB $\mu$ V)	Margin (dB)	Result
0.15238	Neutral	50.90	65.90	15.00	Complied
0.17579	Neutral	49.10	64.70	15.60	Complied
0.2214	Neutral	45.50	62.80	17.30	Complied
0.25137	Neutral	38.70	61.70	23.00	Complied
0.32653	Neutral	34.00	59.50	25.50	Complied
0.34837	Neutral	32.80	59.00	26.20	Complied
0.41888	Neutral	26.30	57.50	31.20	Complied
0.53267	Neutral	28.70	56.00	27.30	Complied
2.24555	Neutral	19.40	56.00	36.60	Complied
3.50066	Neutral	25.50	56.00	30.50	Complied
5.2876	Neutral	27.50	60.00	32.50	Complied
11.16958	Neutral	27.10	60.00	32.90	Complied
23.77329	Neutral	22.70	60.00	37.30	Complied

**Results: Neutral / Average / 240 VAC 60 Hz**

Frequency (MHz)	Line	Level (dB $\mu$ V)	Limit (dB $\mu$ V)	Margin (dB)	Result
0.15238	Neutral	35.30	55.90	20.60	Complied
0.17579	Neutral	23.70	54.70	31.00	Complied
0.2214	Neutral	31.20	52.80	21.60	Complied
0.25137	Neutral	29.20	51.70	22.50	Complied
0.32653	Neutral	21.20	49.50	28.30	Complied
0.34837	Neutral	22.30	49.00	26.70	Complied
0.41888	Neutral	19.30	47.50	28.20	Complied
0.53267	Neutral	22.60	46.00	23.40	Complied
2.24555	Neutral	14.60	46.00	31.40	Complied
3.50066	Neutral	20.70	46.00	25.30	Complied
5.2876	Neutral	20.60	50.00	29.40	Complied
11.16958	Neutral	20.70	50.00	29.30	Complied
23.77329	Neutral	15.80	50.00	34.20	Complied

**Result: Pass**



**Transmitter AC Conducted Spurious Emissions (continued)**

**Results: BT-LE / 1 Mbps / PRBS9 / PWR Max / Mid Channel**

**Plot: Live and Neutral Line / 240 VAC 60 Hz**

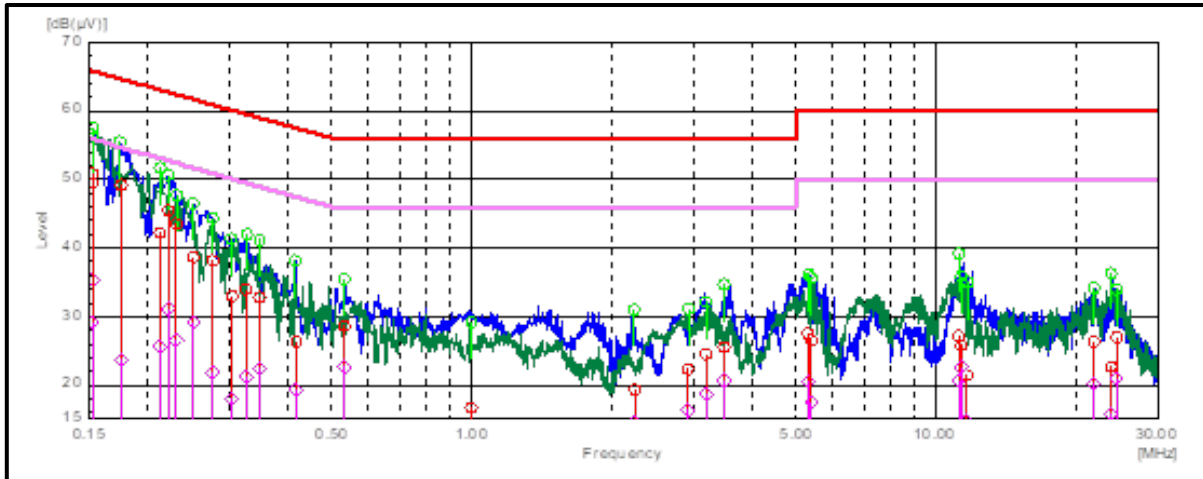

*Note: These plots are pre-scans and for indication purposes only. For final measurements, see accompanying tables.*

**5.2.2. Transmitter 6 dB Bandwidth**

**Test Summary:**

<b>Test Engineer:</b>	Muhammad Faiq Khan	<b>Test Date:</b>	12 October 2022
<b>Test Sample Serial Number:</b>	No 1 (Conducted Test Sample)		
<b>Test Site Identification</b>	SR 9		

<b>FCC Reference:</b>	Part 15.247(a)(2)
<b>Test Method Used:</b>	FCC KDB 558074 Section 8.2 referencing ANSI C63.10:2013 Section 11.8.1 Option 1

**Environmental Conditions:**

<b>Temperature (°C):</b>	21.4
<b>Relative Humidity (%):</b>	45.7

**Notes:**

1. The measurements were performed using the above configurations on the bottom, middle and top channels in accordance FCC KDB 558074 Section 8.2 referencing ANSI C63.10 Section 11.8 (11.8.1 Option 1 measurement procedure).
2. The spectrum analyser resolution bandwidth was set to 100 kHz and video bandwidth 300 kHz. A peak detector was used, sweep time was set to auto and the trace mode was Max Hold. The DTS bandwidth was measured at 6 dB down from the peak of the signal.
3. The RF SMA cable was soldered on the EUT which was connected to the spectrum analyser using suitable attenuation and RF cable. The measured values take into consideration the external attenuation correction factors.
  - o The soldered SMA RF Cable from the PCB with maximum attenuation of 0.5 dB at the tested frequencies.
  - o The SMA RF cable from the EUT to Analyzer with maximum attenuation of 0.5 dB at the tested frequencies including the 10 dB attenuator at the input of Spectrum Analyzer

Therefore, total a reference level offset 11.0 dB was added to each of the at the tested frequencies conducted plots.

**Test Setup:**

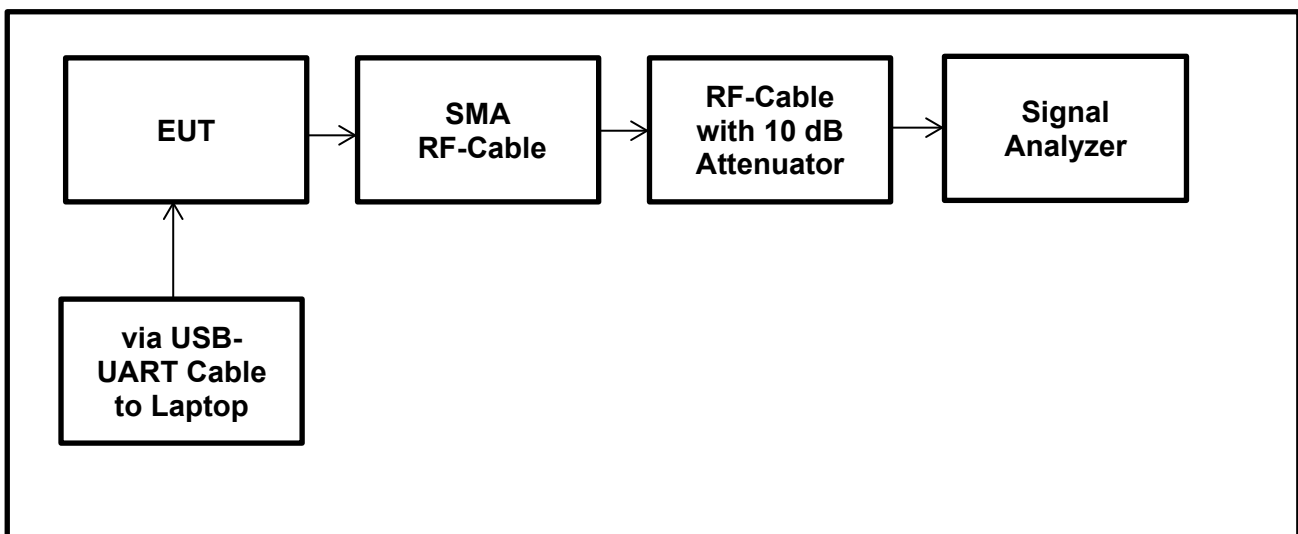

**Transmitter Minimum 6 dB Bandwidth (continued)**

**Results: BT-LE / 1 Mbps / PRBS9 / PWR Max**

Channel	6 dB Bandwidth (kHz)	Limit (kHz)	Margin (kHz)	Result
Bottom	694.509	≥ 500	194.509	Complied
Middle	698.572	≥ 500	198.572	Complied
Top	691.073	≥ 500	191.073	Complied

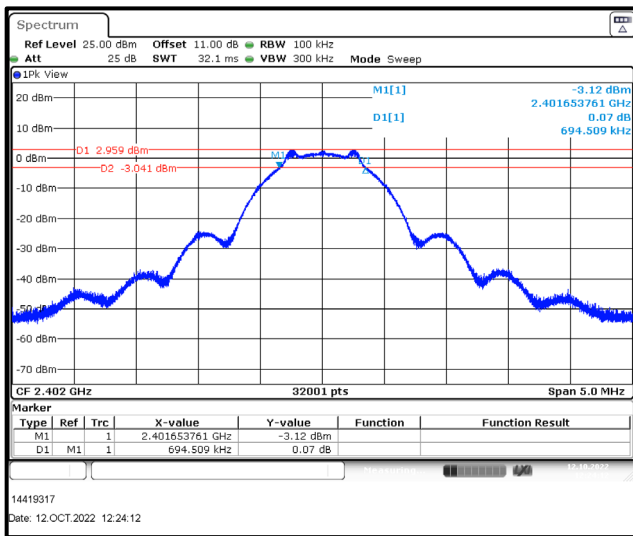

Bottom Channel

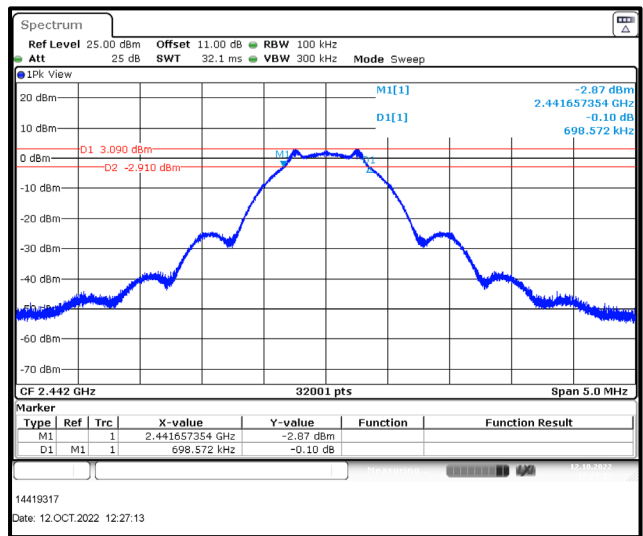

Middle Channel

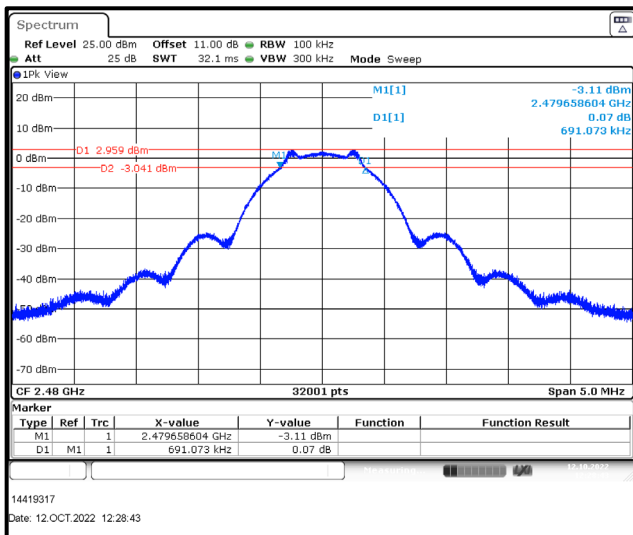

Top Channel

Result: **Pass**



**5.2.3. Transmitter Maximum Peak Output Power**

**Test Summary:**

<b>Test Engineer:</b>	Muhammad Faiq Khan	<b>Test Date:</b>	12 October 2022
<b>Test Sample Serial Number:</b>	No 1 (Conducted Test Sample)		
<b>Test Site Identification</b>	SR 9		

<b>FCC Reference:</b>	Part 15.247(b)(3)
<b>Test Method Used:</b>	FCC KDB 558074 Section 8.3.1.1 referencing ANSI C63.10 Section 11.9.1.1

**Environmental Conditions:**

<b>Temperature (°C):</b>	22.9
<b>Relative Humidity (%):</b>	46.3

**Notes:**

1. Conducted power tests were performed using a spectrum analyser in accordance with FCC KDB 558074 Section 8.3.1.1 with the RBW ≥ DTS bandwidth referencing ANSI C63.10 Section 11.9.1.1.
2. The signal analyser resolution bandwidth was set to 3 MHz and video bandwidth of 10 MHz. A peak detector was used, sweep time was set to auto and trace mode was Max Hold. The span was set to 10 MHz. A marker was placed at the peak of the signal and the results recorded in the table below.
3. The RF SMA cable was soldered on the EUT which was connected to the spectrum analyser using suitable attenuation and RF cable. The measured values take into consideration the external attenuation correction factors.
  - The soldered SMA RF Cable from the PCB with maximum attenuation of 0.5 dB at the tested frequencies.
  - The SMA RF cable from the EUT to Analyzer with maximum attenuation of 0.5 dB at the tested frequencies including the 10 dB attenuator at the input of Spectrum Analyzer

Therefore, total a reference level offset 11.0 dB was added to each of the at the tested frequencies conducted plots.
4. The declared antenna gain was added to conducted power to obtain the relevant EIRP values.

**Test Setup:**

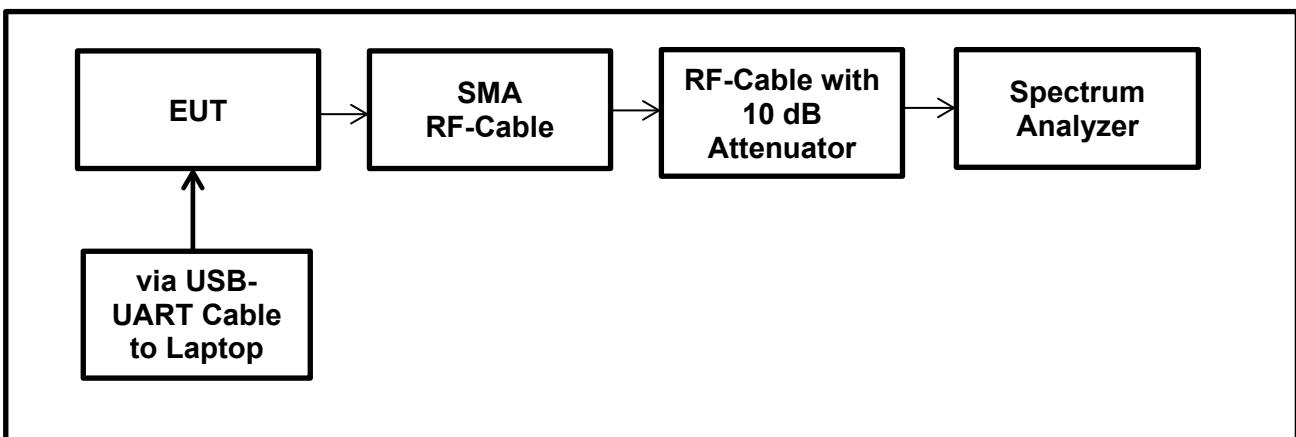

**Transmitter Maximum Peak Output Power (continued)****Results: BT-LE / 1 Mbps / PRBS9 / PWR Max**

Channel	Conducted Peak Power (dBm)	Conducted Peak Power Limit (dBm)	Margin (dB)	Result
Bottom	3.20	30.00	26.80	Complied
Middle	3.27	30.00	26.73	Complied
Top	3.12	30.00	26.88	Complied

**Results EIRP: BT-LE / 1 Mbps / PRBS9 / PWR Max**

Channel	Conducted Peak Power (dBm)	Declared Stitched Antenna Gain (dBi)	EIRP (dBm)	De Facto EIRP Limit (dBm)	Margin (dB)	Result
Bottom	3.20	-0,41	2.79	36.00	33.21	Complied
Middle	3.27	-0,41	2.86	36.00	33.14	Complied
Top	3.12	-0,41	2.71	36.00	33.19	Complied

**Result: Pass**

**Transmitter Maximum Peak Output Power (continued)**

**Plots: BT-LE / 1 Mbps / PRBS9 / PWR Max**

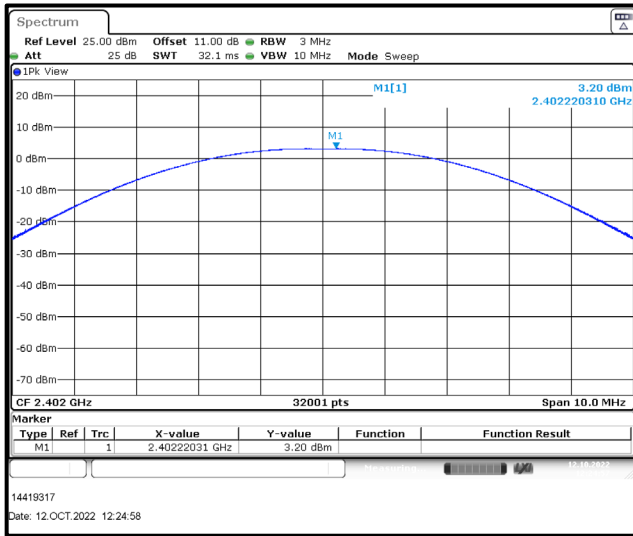

**Bottom Channel**

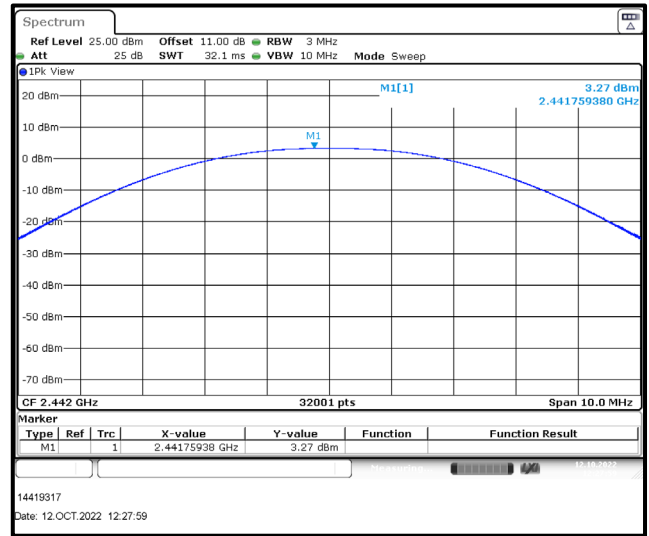

**Middle Channel**

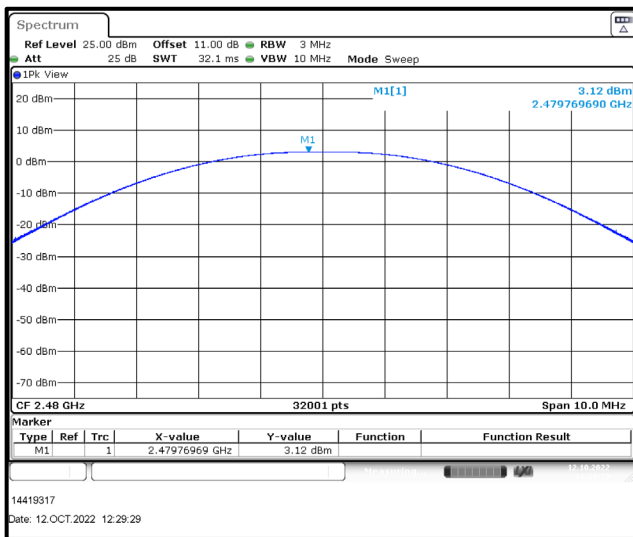

**Top Channel**

**5.2.4. Transmitter Radiated Emissions****Test Summary:**

<b>Test Engineer:</b>	Muhammad Faiq Khan	<b>Test Date:</b>	26 September 2022
<b>Test Sample Serial Number:</b>	No 3 (Radiated Test Sample)		
<b>Test Site Identification</b>	SR 1/2		

<b>FCC Reference:</b>	Parts 15.247(d) & 15.209(a)
<b>Test Method Used:</b>	FCC KDB 558074 Sections 8.5 & 8.6 referencing ANSI C63.10 Sections 11.11 and 11.12 ANSI C63.10:2013 Sections 6.3 and 6.4
<b>Frequency Range</b>	9 kHz to 30 MHz

**Environmental Conditions:**

<b>Temperature (°C):</b>	20.7
<b>Relative Humidity (%):</b>	46.5

**Notes:**

- In accordance with FCC KDB 414788 D01 Radiated Test Site & ANSI C63.10 clause 5.2 an alternative test site that can demonstrate equivalence to an open area test site may be used. Therefore, the measurement was performed in a Semi Anechoic Chamber. (The OATS / SAC comparison data is available upon request).
- The limits are specified at a test distances of 30 and 300 metres. However, as specified in FCC Section 15.31 (f)(2) & ANSI C63.10 clause 6.4.3, measurements may be performed at a closer distance and the measured level extrapolated to the specified measurement distance using the method described in clauses 6.4.4, specifically sub-clause 6.4.4.1 which specifies that the measured level shall be extrapolated to the specified distance by conservatively presuming that the field strength decays at 40 dB/decade. Therefore, measurements were performed at measurement distance of 3m.
- Therefore, the limit values are extrapolated to a measurement distance of 3 m.
  - 9 kHz- 490 kHz: limits extrapolated from 300 m to 3 m by adding 80 dB at 40 dB /decade.
  - 490 kHz-1705 kHz: limits extrapolated from 30 m to 3 m by adding 40 dB at 40 dB /decade.
- Measurements below 30 MHz were performed in a semi-anechoic chamber SR1/ 2 (Asset Number 1603665) at a distance of 3 m. The EUT was placed at a height of 80 cm above the reference ground plane in the centre of the chamber turntable. The measurement loop antenna height was 100 cm.
- The measurement was performed only on Mid channel since it was found out to be the worst-case w.r.t. maximum conducted output power.
- The final measured value, for the given emission, in the table below incorporates the calibrated antenna factor and cable loss.
- All other emissions shown on the pre-scan plots were investigated and found to be below system noise floor.
- Pre-scans were performed, and markers placed on the highest measured levels. The test receiver was set to:
  - Frequency range: 9 kHz-150 kHz: RBW: 1 kHz /VBW: 3 kHz
  - Frequency range: 150 kHz – 30 MHz: RBW: 10 kHz /VBW: 30 kHz
  - Detector: Max-Peak detector
  - Trace Mode: Max Hold

**Transmitter Radiated Emissions (continued)**

**Test Setup:**

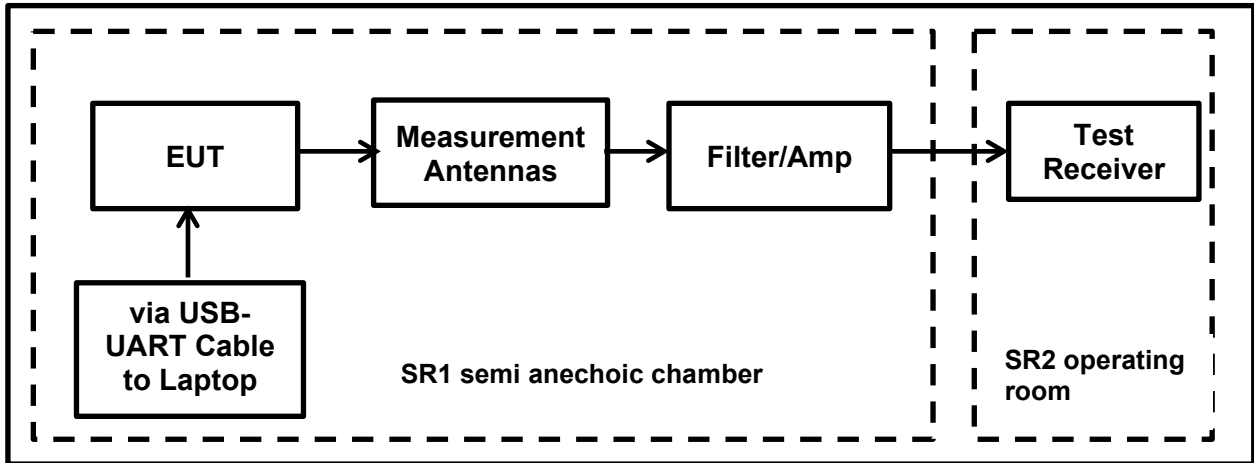



**Transmitter Radiated Emissions (continued)**

**Results: BT-LE / 1 Mbps / PRBS9 / PWR Max / Mid Channel**

Frequency (MHz)	Loop Antenna Orientation	MaxPeak Level (dB $\mu$ V/m)	Limit (dB $\mu$ V/m)	Margin (dB)	Result
0.104246	0° to EUT	34.58	105.96	71.38	Complied
0.159923	0° to EUT	45.70	102.45	56.75	Complied
0.507210	0° to EUT	48.42	73.48	25.06	Complied
1.013258	0° to EUT	41.98	67.28	25.30	Complied
1.522613	0° to EUT	39.92	63.88	23.96	Complied

**Plot: 9 kHz – 30 MHz: BT-LE / 1 Mbps / PRBS9 / PWR Max / Mid Channel**

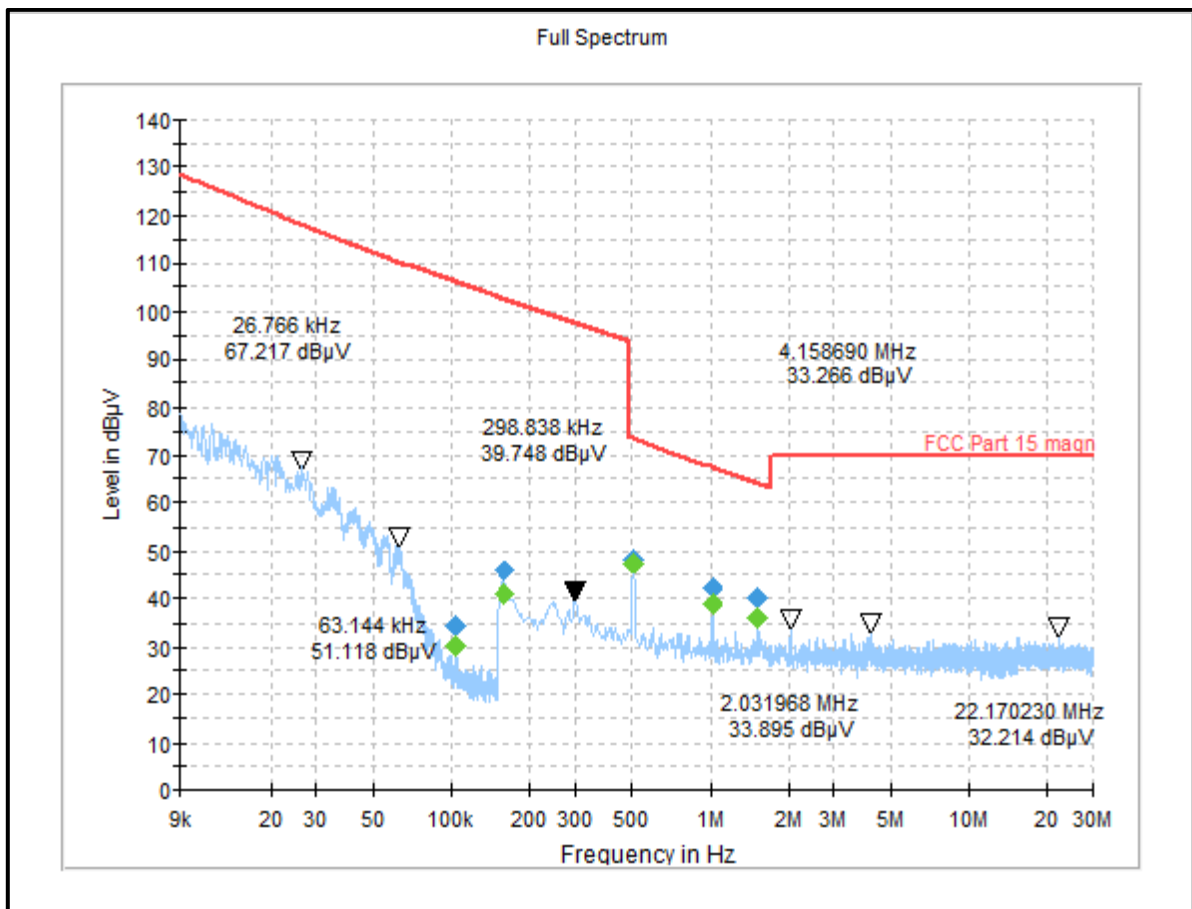

**Result: Pass**

**Transmitter Radiated Emissions (continued)**

**Test Summary:**

<b>Test Engineer:</b>	Muhammad Faiq Khan	<b>Test Date:</b>	26 September 2022
<b>Test Sample Serial Number:</b>	No 3 (Radiated Test Sample)		
<b>Test Site Identification</b>	SR 1/2		

<b>FCC Reference:</b>	Parts 15.247(d) & 15.209(a)
<b>Test Method Used:</b>	FCC KDB 558074 Sections 8.5 & 8.6 referencing ANSI C63.10 Sections 11.11 and 11.12 ANSI C63.10:2013 Sections 6.3 and 6.5
<b>Frequency Range</b>	30 MHz to 1000 MHz

**Environmental Conditions:**

<b>Temperature (°C):</b>	20.7
<b>Relative Humidity (%):</b>	46.5

**Note(s):**

1. Measurements below 1 GHz were performed in a semi-anechoic chamber (Asset Number K0001) at a distance of 3 metres. The EUT was placed at a height of 80 cm above the reference ground plane in the centre of the chamber turntable. Maximum emission levels were determined by height searching the measurement antenna over the range 1 metre to 4 metres.
2. Pre-scans were performed, and markers placed on the highest measured levels. The test receiver resolution bandwidth was set to 100 kHz and video bandwidth 300 kHz. A peak detector was used, sweep time was set to auto and trace mode was Max Hold.
3. The measurement was performed only on Mid channel since it was found out to be the worst-case w.r.t. maximum conducted output power.
4. The final measured value, for the given emission, in the table below incorporates the calibrated antenna factor and cable loss.
5. All other emissions shown on the pre-scan plots were investigated and found out to be below system noise floor.

**Test Setup:**

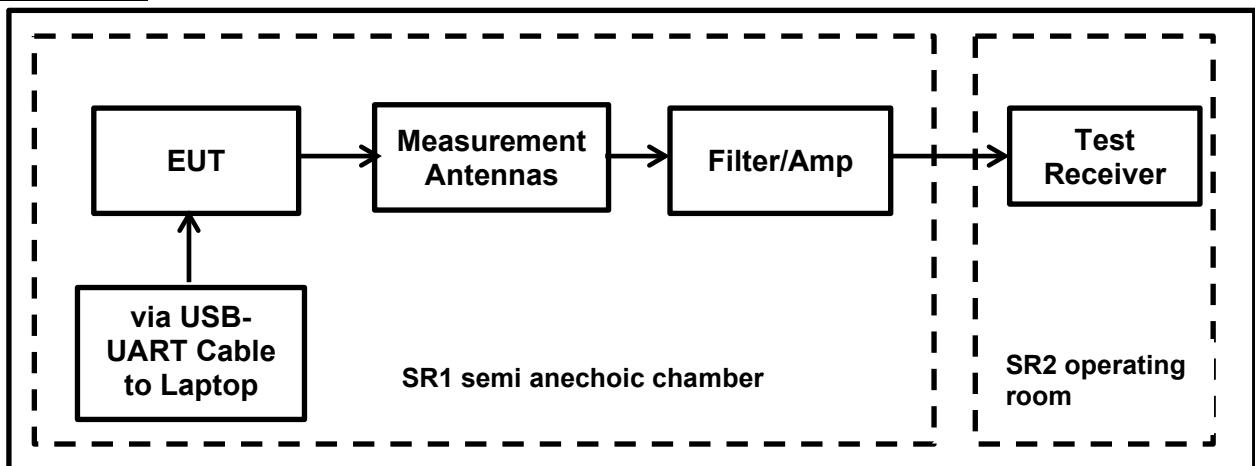

**Transmitter Radiated Emissions (continued)**

**Results: BT-LE / 1 Mbps / PRBS9 / PWR Max / Mid Channel**

Frequency (MHz)	Antenna Polarization	MaxPeak Level (dB $\mu$ V/m)	Limit (dB $\mu$ V/m)	Margin (dB)	Result
30.135000	Vertical	23.96	40.00	16.04	Complied
57.045000	Vertical	35.12	40.00	4.88	Complied
81.210000	Vertical	30.36	40.00	9.64	Complied
144.390000	Vertical	30.03	43.50	13.47	Complied
521.458333	Horizontal	26.60	46.00	19.40	Complied
557.708333	Horizontal	27.61	46.00	18.39	Complied
814.916667	Horizontal	32.62	46.00	13.38	Complied

**Plot: 30 MHz – 1 GHz: BT-LE / 1 Mbps / PRBS9 / PWR Max / Mid Channel**

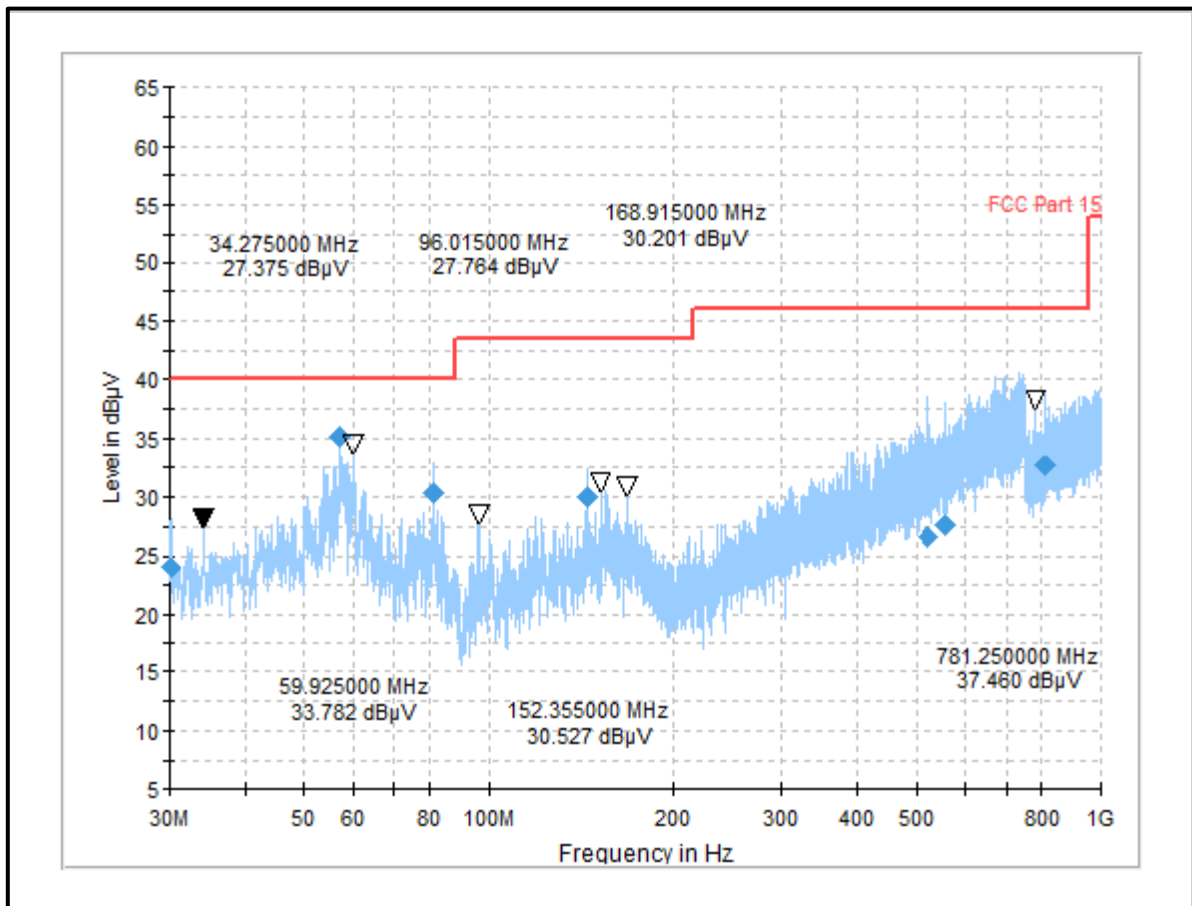

**Result: Pass**

**Transmitter Radiated Emissions (continued)****Test Summary:**

<b>Test Engineer:</b>	Muhammad Faiq Khan	<b>Test Date:</b>	05 September to 26 September 2022
<b>Test Sample Serial Number:</b>	No 3 (Radiated Test Sample)		
<b>Test Site Identification</b>	SR 1/2		

<b>FCC Reference:</b>	Parts 15.247(d), 15.209(a) & 15.205(a)
<b>Test Method Used:</b>	FCC KDB 558074 Sections 8.5 & 8.6 referencing ANSI C63.10 Sections 11.11 and 11.12 ANSI C63.10:2013 Sections 6.3 and 6
<b>Frequency Range</b>	1 GHz to 26.5 GHz

**Environmental Conditions:**

<b>Temperature (°C):</b>	20.7 to 22.9
<b>Relative Humidity (%):</b>	46.5 to 54.7

**Note(s):**

- Pre-scans above 1 GHz were performed in a semi-anechoic chamber SR1/ 2 (Asset Number 1603665) with RF absorbers on the floor at a distance of 3 m. The EUT was placed at a height of 1.5 m above the test chamber floor in the centre of the chamber turntable. All measurement antennas were placed at a fixed height of 1.5 m above the test chamber floor, in line with the EUT. Final measurements above 1 GHz were performed in a semi-anechoic chamber SR1/ 2 (Asset Number 1603665) with absorber on the floor at a distance of 3 m. The EUT was placed at a height of 1.5 m above the reference ground plane in the centre of the chamber turntable. Maximum emission levels were determined by height searching the measurement antenna over the range 1 m to 4 m.
- The emissions shown at frequencies approximately 2.4 GHz to 2.4835 GHz on the 1 GHz to 18 GHz plots are the EUT fundamental for the tested channel.
- Pre-scans were performed, and marker placed on the highest measured level of the plot. The test receiver RBW was set to 1 MHz and VBW 3 MHz. The sweep time was set to auto.
- The final measured value, for the given emission, in the table below incorporates the calibrated antenna factor and cable loss.
- All other emissions shown on the pre-scan plots were investigated and found to be below system noise floor.
- In accordance with ANSI C63.10-2013 Section 5.3.3 & 6.5.3 measurements above 18 GHz were performed at closer distance (1 m); because at specified measurement distance (3m) for compliance the instrumentation noise floor was typically close to the radiated emission limit.
- For frequency range between 18 GHz and 26.5 GHz, on the pre-scan plots were investigated and found to be below system noise floor.

**Transmitter Radiated Emissions (continued)**

**Test Setup:**

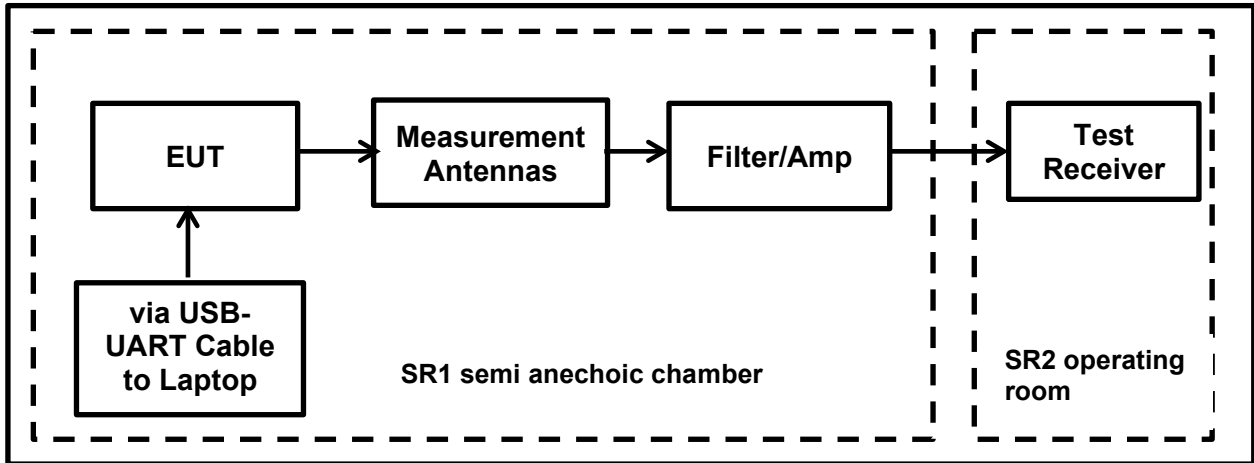

**Transmitter Radiated Emissions (continued)**

**Results: BT-LE / 1 Mbps / PRBS9 / PWR Max / Bottom Channel**

**Restricted Band Emission:**

Frequency (MHz)	Antenna Orientation	Average Level (dB $\mu$ V/m)	Average Limit (dB $\mu$ V/m)	Margin (dB)	Result
4804.04	Vertical	46.08	54.00	7.92	Complied

Note: The frequencies are represented with the blue point in the plot below.

**Plot: 1 GHz – 18 GHz: BT-LE / 1 Mbps / PRBS9 / PWR Max / Bottom Channel**

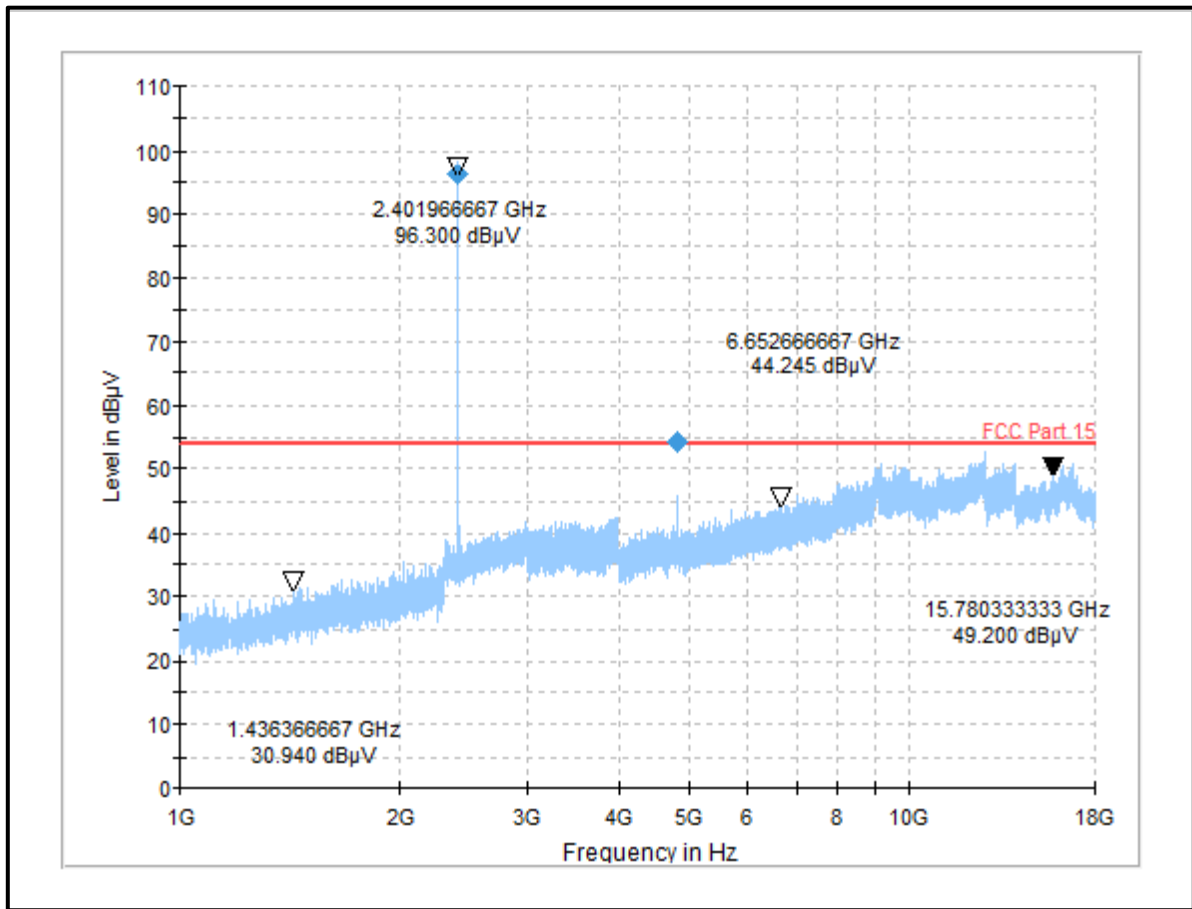

**Result: Pass**

**Transmitter Radiated Emissions (continued)**

**Results: BT-LE / 1 Mbps / PRBS9 / PWR Max / Middle Channel**

**Restricted Band Emission:**

Frequency (MHz)	Antenna Orientation	Average Level (dBμV/m)	Average Limit (dBμV/m)	Margin (dB)	Result
4884.14	Vertical	44.08	54.00	9.92	Complied

Note: The frequencies are represented with the blue point in the plot below.

**Plot: 1 GHz – 18 GHz: BT-LE / 1 Mbps / PRBS9 / PWR Max / Middle Channel**

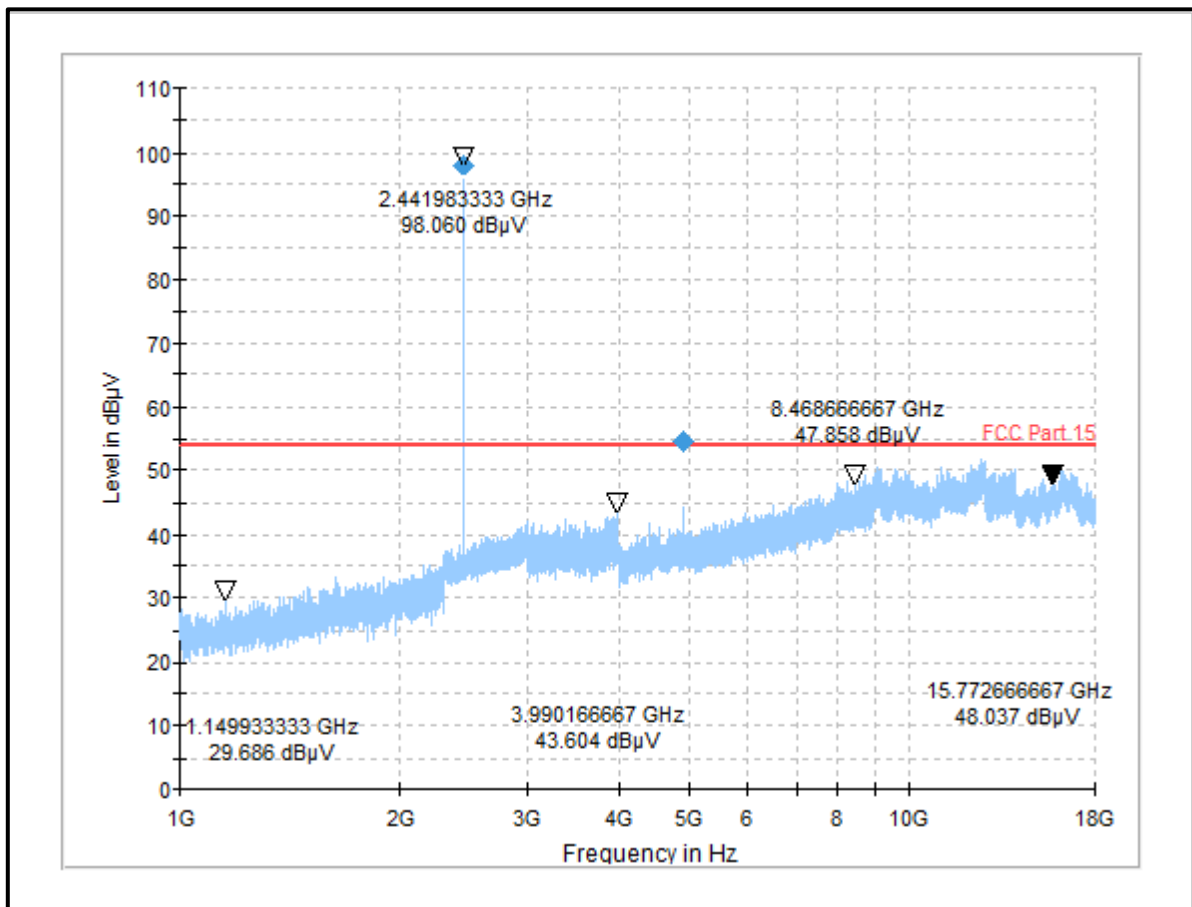

**Result: Pass**

**Transmitter Radiated Emissions (continued)**

**Results: BT-LE / 1 Mbps / PRBS9 / PWR Max / Top Channel**

Frequency (MHz)	Antenna Orientation	MaxPeak Level (dBµV/m)	Average Limit (dBµV/m)	Margin (dB)	Result
No critical spurious emissions were detected					

Plot: 1 GHz – 18 GHz: BT-LE / 1 Mbps / PRBS9 / PWR Max / Top Channel

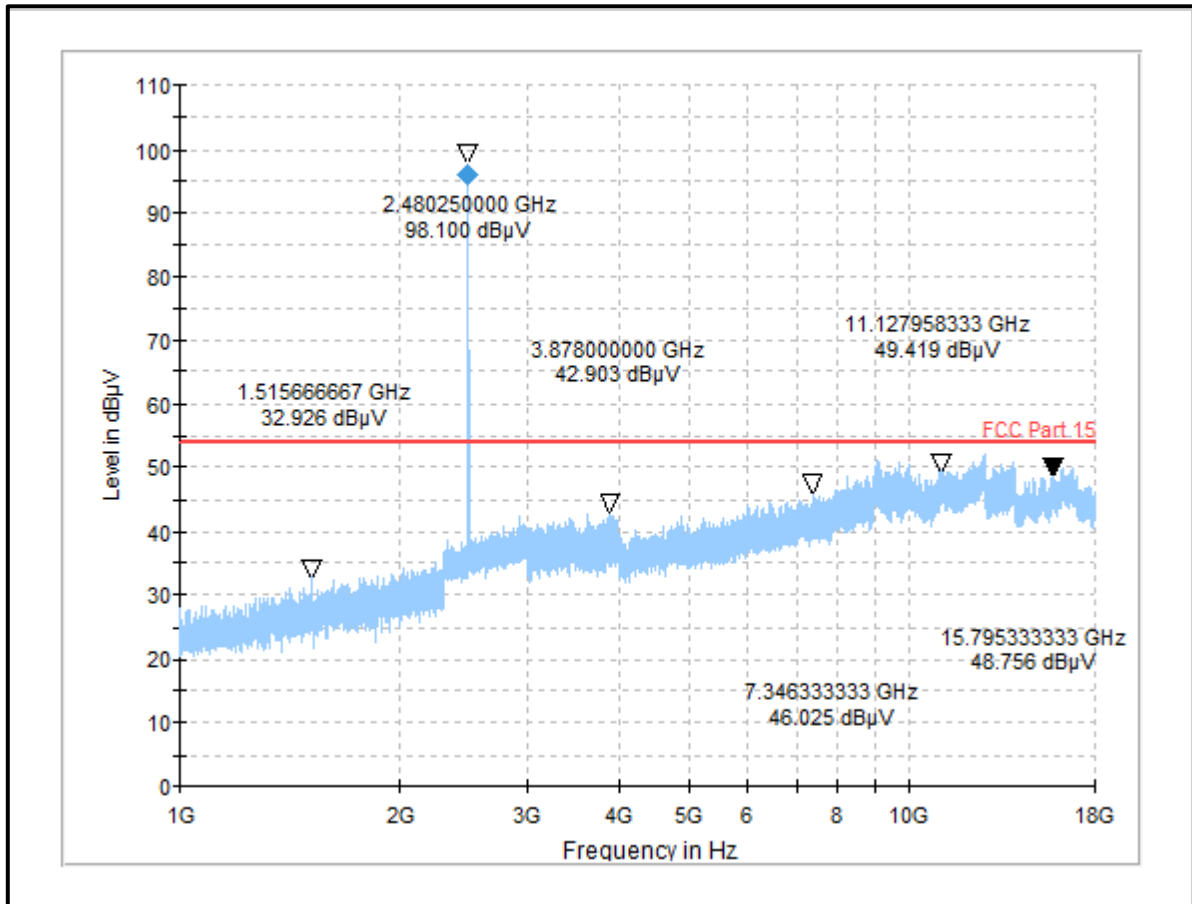

**Result: Pass**



**Transmitter Radiated Emissions (continued)**  
**Results: BT-LE / 1 Mbps / PRBS9 / PWR Max / Mid Channel**

Frequency (MHz)	Antenna Polarization	Peak Level (dB $\mu$ V/m)	Average Limit (dB $\mu$ V/m)	Margin (dB)	Result
No critical spurious emissions were detected					

Plot: 18 GHz – 26 GHz: BT-LE / 1 Mbps / PRBS9 / PWR Max / Mid Channel

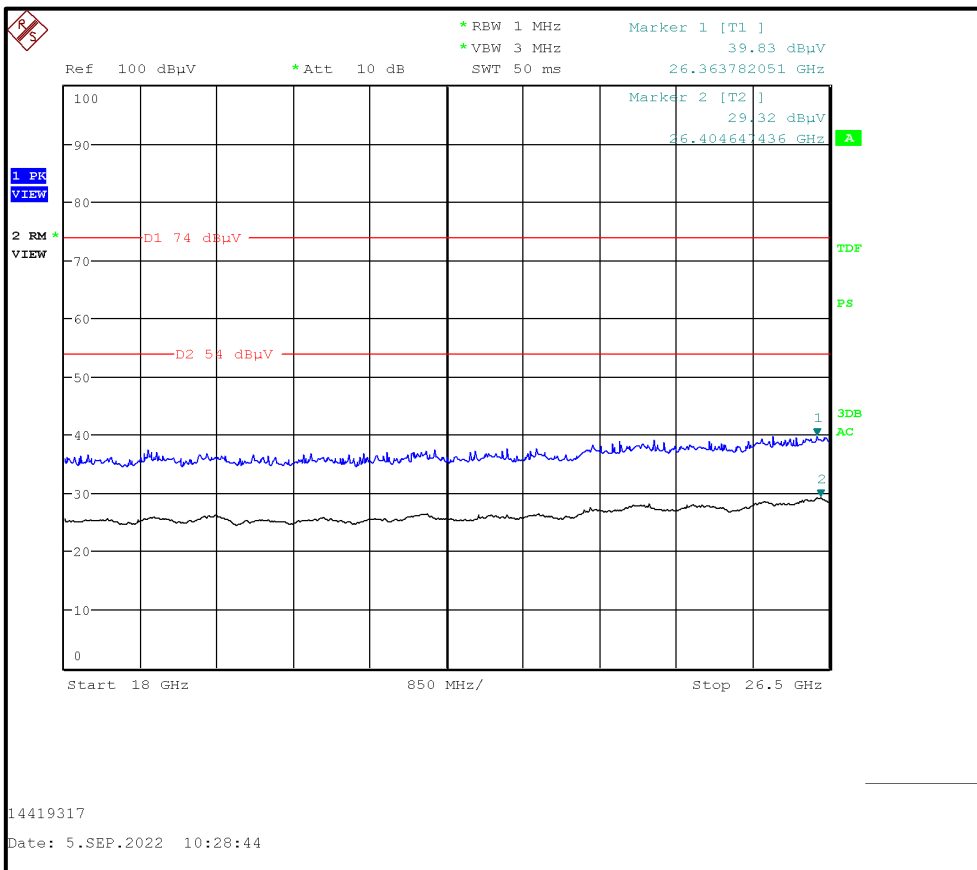

**Result: Pass**

**5.2.5. Transmitter Band Edge Radiated Emissions****Test Summary:**

<b>Test Engineer:</b>	Muhammad Faiq Khan	<b>Test Date:</b>	26 September 2022
<b>Test Sample Serial Number:</b>	No 3 (Radiated Test Sample)		
<b>Test Site Identification</b>	SR 1/2		

<b>FCC Reference:</b>	Parts 15.247(d) & 15.209(a)
<b>Test Method Used:</b>	DTS emissions in non-restricted frequency bands: FCC KDB 558074 Section 8.5 referencing ANSI C63.10:2013 Sections 11.11
	DTS emissions in restricted frequency bands: FCC KDB 558074 Section 8.6 referencing ANSI C63.10:2013 Sections 11.12
	ANSI C63.10:2013 Sections 6.10.4, 6.10.5, 11.13

**Environmental Conditions:**

<b>Temperature (°C):</b>	20.7
<b>Relative Humidity (%):</b>	46.5

**Note(s):**

- The measurements were in a semi-anechoic chamber SR1/ 2 (Asset Number 1603665) with RF absorbers on the floor at a distance of 3 m. The EUT was placed at a height of 1.5 m above the test chamber floor in the centre of the chamber turntable. Maximum emission levels were determined by height searching the measurement antenna over the range 1 m to 4 m
- As the lower band edge falls within a non-restricted band, measurements were performed in accordance with FCC KDB 558074 Section 8.5 referencing ANSI C63.10 Section 11.11. As the maximum peak conducted output power was previously measured, in accordance with ANSI C63.10 Section 11.11.1(a) lower band edge measurement was performed with a peak detector and the -20 dBc limit applied.
- As the lower band edge falls within a non-restricted band, only peak measurements are required. The test receiver resolution bandwidth was set to 100 kHz and video bandwidth 300 kHz. A peak detector was used, sweep time was set to auto and trace mode was Max Hold. The test receiver was left to sweep for a sufficient length of time in order to maximise the carrier level and out-of-band emissions. A marker and corresponding reference level line were placed on the peak of the carrier. Marker frequencies and levels were recorded.
- The restricted band peak measurements were performed in accordance with ANSI C63.10 Section 11.12.2.4.
- As the upper band edge falls within a restricted band both peak and average measurements were recorded by placing a marker at the edge of the band. For peak measurements the test receiver resolution bandwidth was set to 1 MHz and the video bandwidth 3 MHz A peak detector was used, sweep time was set to auto and trace mode was Max Hold. For average measurements the test receiver resolution bandwidth was set to 1 MHz and the video bandwidth 3 MHz and RMS detector in linear power averaging mode was used. The test receiver was left to sweep for 300 sweeps in order to maximise the carrier level and out-of-band emissions. A marker was placed on the band edge spot frequencies and a second marker placed on the highest emission level in the adjacent restricted band of operation (where a higher-level emission was present). Marker frequencies and levels were recorded.

**Transmitter Band Edge Radiated Emissions (continued)****Note(s):**

6. There is a restricted band 10 MHz below the lower band edge. The test receiver was set up as follows: the RBW set to 1 MHz, the VBW set to 3 MHz, with the sweep time set to auto couple. Peak and average measurements were performed with their respective detectors. Markers were placed on the highest point on each trace.
7. As the EUT continuous transmission of the EUT ( $D \geq 98\%$ ) can be achieved and EUT was transmitting continuously with a constant Duty Cycle of 100 % (duty cycle variations are less than  $\pm 2\%$ ). Therefore, a Duty Cycle Correction Factor isn't applicable to the measured average values of the emissions.
8. The final measured value, for the given emission, in the table below incorporates the calibrated antenna factor and cable loss.

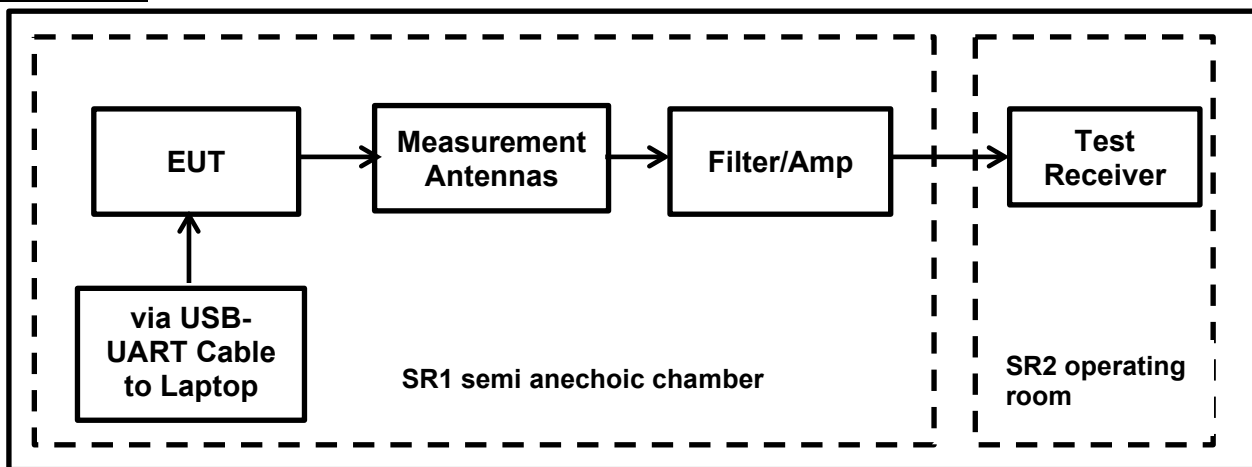
**Test Setup:**

**Transmitter Band Edge Radiated Emissions (continued)****Results: BT-LE / 1 Mbps / PRBS9 / PWR Max****Results: Lower Band Edge / Peak**

Frequency (MHz)	Peak Level (dB $\mu$ V/m)	-20 dBc Limit (dB $\mu$ V/m)	Margin (dB)	Result
2398.25	43.24	77.91	34.67	Complied
2400.00	50.65	77.91	27.26	Complied

**Results: 2310 to 2390 MHz Restricted Band / Peak**

Frequency (MHz)	Peak Level (dB $\mu$ V/m)	Peak Limit (dB $\mu$ V/m)	Margin (dB)	Result
2389.64	47.79	74.00	26.21	Complied

**Results: 2310 to 2390 MHz Restricted Band / Average**

Frequency (MHz)	Average Level (dB $\mu$ V/m)	Average Limit (dB $\mu$ V/m)	Margin (dB)	Result
2388.28	36.15	54.00	17.85	Complied

**Results: Upper Band Edge / Peak**

Frequency (MHz)	Peak Level (dB $\mu$ V/m)	Peak Limit (dB $\mu$ V/m)	Margin (dB)	Result
2483.50	50.58	74.00	23.42	Complied
2483.58	50.41	74.00	23.59	Complied

**Results: Upper Band Edge / Average**

Frequency (MHz)	Average Level (dB $\mu$ V/m)	Average Limit (dB $\mu$ V/m)	Margin (dB)	Result
2483.5	39.03	54.00	14.97	Complied
2483.66	39.22	54.00	14.78	Complied

**Result: Pass**

**Transmitter Band Edge Radiated Emissions (continued)**

**Results: BT-LE / 1 Mbps / PRBS9 / PWR Max**

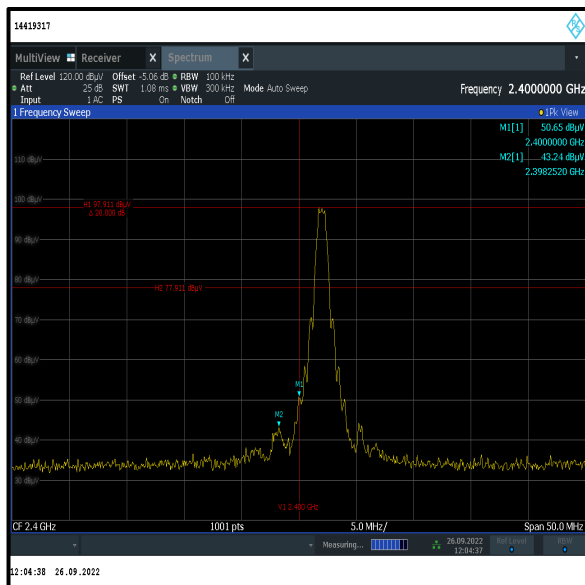

Lower Band Edge Peak Measurement

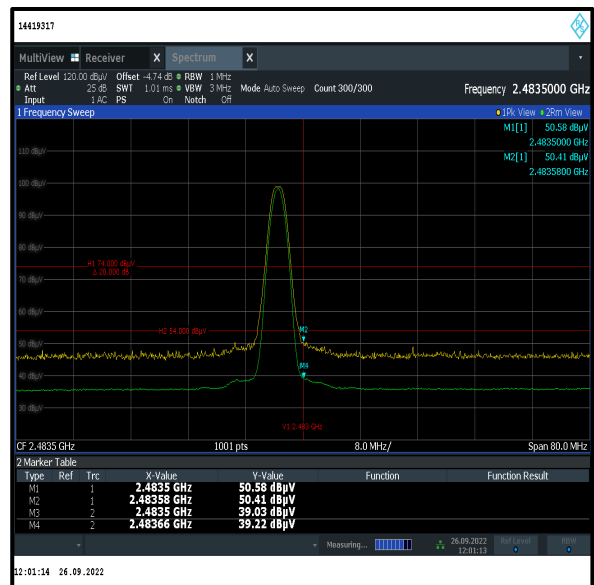

Upper Band Edge Peak & Average Measurement



2310 MHz to 2390 MHz Restricted Band

Result: **Pass**



## **6. Measurement Uncertainty**

The expression of uncertainty of a measurement result allows realistic comparison of results with reference values and limits given in specifications and standards.

The uncertainty of the result may need to be taken into account when interpreting the measurement results.

The reported expanded uncertainties below are based on a standard uncertainty multiplied by an appropriate coverage factor such that a confidence level of approximately 95% is maintained. For the purposes of this document “approximately” is interpreted as meaning “effectively” or “for most practical purposes”.

<b>Measurement Type</b>	<b>Confidence Level (%)</b>	<b>Calculated Uncertainty</b>
AC conducted emission	95%	±2.49 dB
Minimum 6 dB Bandwidth	95%	±0.87 %
Conducted Maximum Peak Output Power	95%	±0.59 dB
Radiated Spurious Emissions	95%	±3.10 dB
Band Edge Radiated Emissions	95%	±3.10 dB

The methods used to calculate the above uncertainties are in line with those recommended within the various measurement specifications. Where measurement specifications do not include guidelines for the evaluation of measurement uncertainty the published guidance of the appropriate accreditation body is followed.

## 7. Used equipment

### Test site: SR 1/2

ID	Manufacturer	Type	Model	Serial	Calibration Date	Cal. Cycle (months)
1	Rohde & Schwarz	Antenna, Loop	HFH2-Z2	831247/012	10/07/2020	36
377	BONN Elektronik	Amplifier, Low Noise Pre	BLMA 0118-1A	025294B	13/07/2022	12
460	Deisel	Turntable	DT 4250 S	n/a	n/a	n/a
452	Schwarzbeck	Antenna, Trilog Broadband	VULB 9168	9168-240	02/09/2020	36
496	Rohde & Schwarz	Antenna, log. - periodical	HL050	100297	05/08/2020	36
587	Maturo	antenna mast, tilting	TAM 4.0-E	011/7180311	n/a	n/a
588	Maturo	Controller	NCD	029/7180311	n/a	n/a
669	Rohde & Schwarz	EMI Test Receiver	ESW 44	103087	03/02/2022	12
608	Rohde & Schwarz	Switch Matrix	OSP 120	101227	lab verification	n/a
628	Maturo	Antenna mast	CAM 4.0-P	224/19590716	n/a	n/a
629	Maturo	Kippeinrichtung	KE 2.5-R-M	MAT002	n/a	n/a
-/	Testo	Thermo-Hygrometer	608-H1	01	lab verification	n/a
1603665	Siemens Matsushita Components	semi-anechoic chamber SR1/ 2	-/	B83117-A1421-T161	n/a	n/a

### Test site: SR 9

ID	Manufacturer	Type	Model	Serial	Calibration Date	Cal. Cycle (months)
445	Huber & Suhner	RF Attenuator (10 dB)	6810.17.AC	--	lab verification	12
637	Rohde & Schwarz	Spectrum Analyzer	FSV40	101587	15/07/2022	12
-/	Huber+Suhner	RF Cable -OSP120-DUT1	ST18/SMAm/SMAm/72	605505	lab verification	n/a
-/	Testo	Thermo-Hygrometer	608-H1	07	lab verification	n/a
1603668	Siemens Matsushita Components	shielded room	--	B83117-B1422-T161	n/a	n/a

### Test site: SR 7/8

ID	Manufacturer	Type	Model	Serial	Calibration Date	Cal. Cycle (months)
23	Rohde & Schwarz	Artificial Mains	ESH3-Z5	831767/013	11/07/2022	12
28	Rohde & Schwarz	Passive Probe	ESH2-Z3	none	12/07/2022	36
349	Rohde & Schwarz	Receiver, EMI Test	ESIB7	836697/009	12/07/2022	12
351	Rohde & Schwarz	network, Artificial Mains	ESH3-Z5	862770/018	11/07/2022	12
564	Teseq	Impedance stabilization network (ISN)	ISN T800	26076	12/07/2021	24
616	Rohde & Schwarz	ISN	ENY81-CA6	101656	07/07/2020	36
-/	Testo	Thermo-Hygrometer	608-H1	08	lab verification	n/a
327	SPS	AC/DC power distribution system	PAS 5000	A2464 00/10200	lab verification	n/a

## 8. Report Revision History

Version Number	Revision Details		
	Page No(s)	Clause	Details
1.0	40	-	Initial Version

--- END OF REPORT ---