



# FCC DOC TEST REPORT

## Declaration of Conformity

according to

**47 CFR, Part 2, Part 15, CISPR PUB. 22**

**and Canada ICES-003**

Applicant : OvisLink Corp.  
Address : 5F, No. 6, Lane 130, Min-Chuan Rd., Hsin-Tien City,  
Taipei County 231, Taiwan  
Equipment : Wireless 11n USB Dongle  
Model No. : WN-200USB  
Trade Name : Air Live

Laboratory accreditation



Testing Laboratory  
1332

- The test result refers exclusively to the test presented test model / sample.
- Without written approval of **CerpPASS Technology Corp.** the test report shall not be reproduced except in full.



Contents

**CERTIFICATE OF COMPLIANCE ..... 3**

**1. Test Configuration of Equipment under Test..... 4**

    1.1. Feature of Equipment under Test ..... 4

    1.2. Test Manner ..... 4

    1.3. Description of Test System ..... 4

    1.4. Connection Diagram of Test System ..... 5

    1.5. General Information of Test ..... 6

    1.6. Measurement Uncertainty ..... 6

    1.7. History of this test report..... 7

**2. Test of Conducted Emission ..... 8**

    2.1. Test Limit..... 8

    2.2. Test Procedures..... 8

    2.3. Typical test Setup ..... 9

    2.4. Measurement equipment..... 9

    2.5. Test Result and Data ..... 10

    2.6. Test Photographs..... 12

**3. Test of Radiated Emission ..... 13**

    3.1. Test Limit..... 13

    3.2. Test Procedures..... 13

    3.3. Typical test Setup ..... 14

    3.4. Measurement equipment..... 14

    3.5. Test Result and Data ..... 15

    3.6. Test Photographs..... 21

**Appendix A. Photographs of EUT.....A1 ~ A3**



# CERTIFICATE OF COMPLIANCE

## Declaration of Conformity

according to

**47 CFR, Part 2, Part 15, CISPR PUB. 22**

**and Canada ICES-003**

Applicant : OvisLink Corp.  
Address : 5F, No. 6, Lane 130, Min-Chuan Rd., Hsin-Tien City,  
Taipei County 231, Taiwan  
Equipment : Wireless 11n USB Dongle  
Model No. : WN-200USB

### I HEREBY CERTIFY THAT :

The measurements shown in this test report were made in accordance with the procedures given in **ANSI C63.4 – 2003** and the energy emitted by this equipment was **passed CISPR PUB. 22, FCC Part 15 and Canada ICES-003** in both radiated and conducted emission class B limits.

Testing was carried out on Dec. 09, 2008 at **CerpPASS Technology Corp.**

Signature

  
Anson Chou  
EMC/RF B.U. Vice General Manager



## 1. Test Configuration of Equipment under Test

### 1.1. Feature of Equipment under Test

- 2.4GHz ISM (Industrial, Science, and Medical) band operation
- Integrated easy-to-use Belkin Wireless Networking Utility
- USB 2.0 interface, for operation in virtually any computer with a USB 2.0 bus-power port
- WPA, WPA2, 64-bit WEP (Wired Equipment Privacy), or 128-bit encryption
- Wireless access to networked resources
- Data rate of up to 150Mbps\* (draft 802.11n), 54Mbps (802.11g), or 11Mbps (802.11b)
- Easy installation and use
- LED power and network link/activity indicator
- Operating Temperature: 32 – 140 degrees F (0 – 60 degrees C)
- Storage Temperature: -4 – 176 degrees F (-20 – 80 degrees C)
- Humidity: Max. 90% (non-condensing)

\* Connection rates of up to 150Mbps

### 1.2. Test Manner

- a. During testing, the interface cables and equipment positions were varied according to ANSI C63.4.
- b. The complete test system included remote workstation, PC, Monitor, Mouse, Keyboard, Modem, Printer and EUT for EMI test. The remote workstation included Notebook.
- c. An executive program, "Ping.exe" under WIN XP, which transmits and receives data to the remote workstation through Wireless.

### 1.3. Description of Test System

Device	Manufacturer	Model No.	Description
PC	IBM	IGV	Power Cable, Unshielding 1.8 m
Monitor	SlimAGE	510A	Data Cable, VGA Shielding 1.35 m Power Cable, Adapter Unshielding 1.8 m
Keyboard	IBM	KB-0225	Data Cable, PS2 Shielding 1.35 m
Mouse	IBM	MO28VO	Data Cable, USB Shielding 1.85 m
Modem	ACEXX	DM-1414	Data Cable, RS232 Unshielding 1.35 m Power Cable, Adapter Unshielding 1.8 m
Printer	HP	Desk Jet 400	Data Cable, PRINT Unshielding 1.6 m Power Cable, Adapter Unshielding 1.8 m
Notebook (Remote Workstation)	TOSHIBA	PSA50T-05M00C	Power Cable, Adapter Unshielding 1.8 m



### 1.4. Connection Diagram of Test System

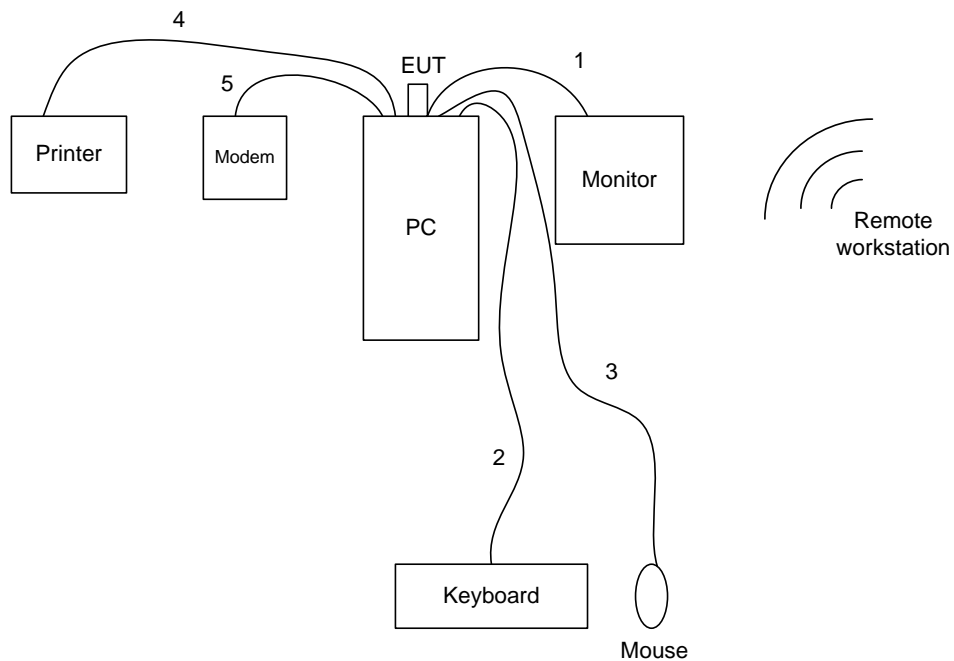

1. The VGA cable is connected from PC to the Monitor.
  2. The PS2 cable is connected from PC to the Keyboard.
  3. The USB cable is connected from PC to the Mouse.
  4. The Print cable is connected from PC to the Printer.
  5. The RS232 cable is connected from PC to the Modem.
- \* The EUT keeps to transmit and receive data via Notebook by Wireless.



### 1.5. General Information of Test

Test Site :	Cerpass Technology Corp. 2F-11, No. 3, Yuan Qu St., (Nankang Software Park), Taipei, Taiwan 115, R.O.C.
Test Site Location (OATS1-SD):	No. 7-2, Moshihkeng, Fongtian Village, Shihding Township, Taipei County, Taiwan, R.O.C.
FCC Registration Number :	TW1049, 982971, 488071, 4934D-1
IC Registration Number :	4934C-1
VCCI Registration Number :	T-543 for Telecommunication Test C-3328 for Conducted emission test R-3013 for Radiated emission test
Test Voltage:	AC 120V / 60Hz
Test in Compliance with:	ANSI C63.4-2003 FCC Part 15 Subpart B Canada ICES-003
Frequency Range Investigated :	Conducted Emission Test: from 150kHz to 30 MHz Radiated Emission Test: from 30 MHz to 2,000 MHz
Test Distance :	The test distance of radiated emission below 1GHz from antenna to EUT is 10 M. The test distance of radiated emission above 1GHz from antenna to EUT is 3 M.

### 1.6. Measurement Uncertainty

Measurement Item	Measurement Frequency	Polarization	Uncertainty
Conducted Emission	9 kHz ~ 30 MHz	LINE/NEUTRAL	2.71 dB
Radiated Emission	30 MHz ~ 1GHz	Vertical	3.89 dB
		Horizontal	3.59 dB



1.7. History of this test report

ORIGINAL.

Additional attachment as following record:

Attachment No.	Issue Date	Description



## 2. Test of Conducted Emission

### 2.1. Test Limit

Conducted Emissions were measured from 150 kHz to 30 MHz with a bandwidth of 9 KHz on the 120 VAC power and return leads of the EUT according to the methods defined in ANSI C63.4-2003 Section 3.1. The EUT was placed on a nonmetallic stand in a shielded room 0.8 meters above the ground plane as shown in section 2.2. The interface cables and equipment positioning were varied within limits of reasonable applications to determine the position produced maximum conducted emissions.

Frequency (MHz)	Quasi Peak (dB $\mu$ V)	Average (dB $\mu$ V)
0.15 – 0.5	66-56*	56-46*
0.5 – 5.0	56	46
5.0 – 30.0	60	50

### 2.2. Test Procedures

- a. The EUT was placed 0.4 meter from the conducting wall of the shielding room was kept at least 80 centimeters from any other grounded conducting surface.
- b. Connect EUT to the power mains through a line impedance stabilization network (LISN).
- c. All the support units are connecting to the other LISN.
- d. The LISN provides 50 ohm coupling impedance for the measuring instrument.
- e. The FCC states that a 50 ohm, 50 micro-Henry LISN should be used.
- f. Both sides of AC line were checked for maximum conducted interference.
- g. The frequency range from 150 kHz to 30 MHz was searched.
- h. Set the test-receiver system to Peak Detect Function and Specified Bandwidth with Maximum Hold Mode.



### 2.3. Typical test Setup

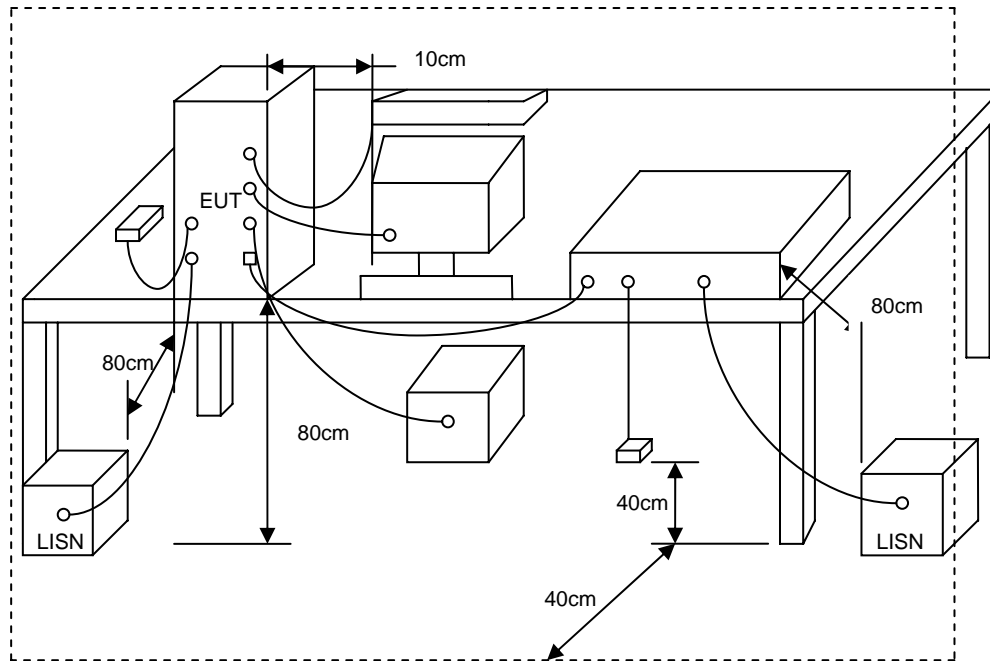

### 2.4. Measurement equipment

Instrument	Manufacturer	Model No.	Serial No.	Calibration Date	Valid Date
EMI Receiver	R&S	ESCI	100443	2008/09/27	2009/09/26
LISN	MESS TEC	NNB-2/16Z	02/10191	2008/05/14	2009/05/13
LISN	ROLF HEINE	NNB-2/16Z	03/10058	2008/04/19	2009/04/18



### 2.5. Test Result and Data

Power	: AC 120V	Pol/Phase	: LINE
Test Mode	: Link Wireless	Temperature	: 22 °C
Memo	:	Humidity	: 52 %

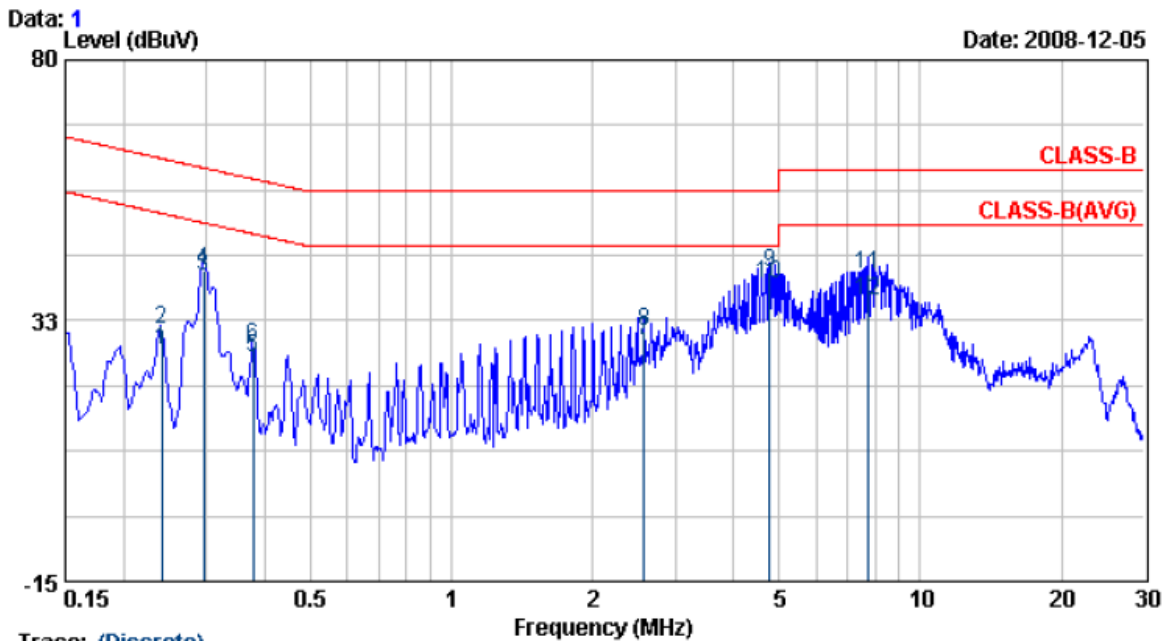

Trace: (Discrete)

Item	Freq MHz	Read Value dBuV	Factor dB	Result dBuV	Limit dBuV	Margin dBuV	Remark
1	0.24	27.05	0.12	27.17	52.05	-24.88	AVERAGE
2	0.24	30.66	0.12	30.78	62.05	-31.27	QP
3	0.30	40.54	0.12	40.66	50.37	-9.71	AVERAGE
4	0.30	41.49	0.12	41.61	60.37	-18.76	QP
5	0.38	25.80	0.12	25.92	48.33	-22.42	AVERAGE
6	0.38	27.64	0.12	27.77	58.33	-30.57	QP
7	2.58	28.74	0.26	29.00	46.00	-17.00	AVERAGE
8	2.58	30.28	0.26	30.54	56.00	-25.46	QP
9	4.77	40.83	0.33	41.15	56.00	-14.85	QP
10	4.77	39.01	0.33	39.34	46.00	-6.66	AVERAGE
11	7.73	40.54	0.35	40.89	60.00	-19.11	QP
12	7.73	35.64	0.35	35.99	50.00	-14.01	AVERAGE

Remarks: 1. Result = Read Value + Factor  
 2. Factor = LISN(ISN) Factor + Cable Loss



Power	: AC 120V	Pol/Phase	: NEUTRAL
Test Mode	: Link Wireless	Temperature	: 22 °C
Memo	:	Humidity	: 52 %

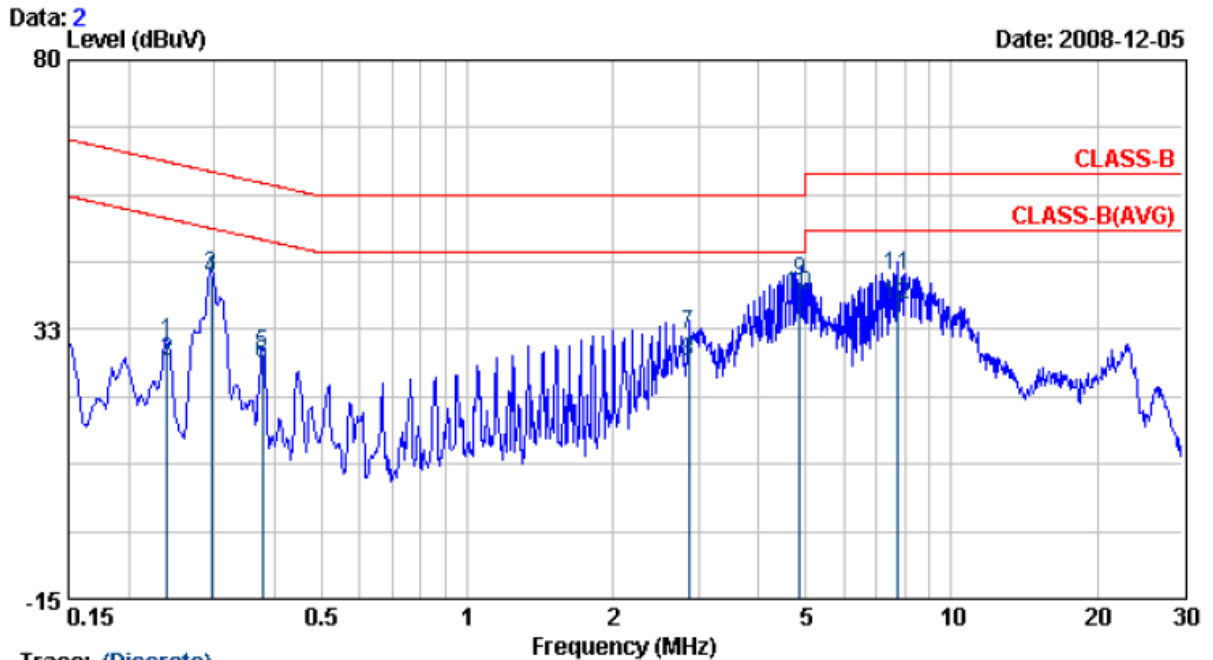

Trace: (Discrete)

Item	Freq MHz	Read Value dBuV	Factor dB	Result dBuV	Limit dBuV	Margin dBuV	Remark
1	0.24	30.27	0.14	30.40	62.09	-31.68	QP
2	0.24	26.69	0.14	26.83	52.09	-25.26	AVERAGE
3	0.30	41.79	0.14	41.94	60.35	-18.41	QP
4	0.30	41.06	0.14	41.20	50.35	-9.15	AVERAGE
5	0.38	27.88	0.15	28.03	58.33	-30.29	QP
6	0.38	26.17	0.15	26.32	48.33	-22.00	AVERAGE
7	2.86	31.22	0.27	31.48	56.00	-24.52	QP
8	2.86	26.61	0.27	26.88	46.00	-19.12	AVERAGE
9	4.87	40.65	0.32	40.97	56.00	-15.03	QP
10	4.87	38.20	0.32	38.52	46.00	-7.48	AVERAGE
11	7.73	41.57	0.37	41.94	60.00	-18.06	QP
12	7.73	36.27	0.37	36.65	50.00	-13.35	AVERAGE

Remarks: 1. Result = Read Value + Factor  
 2. Factor = LISN(ISN) Factor + Cable Loss

Test engineer: Tom



## 2.6. Test Photographs

Front View



Rear View





### 3. Test of Radiated Emission

#### 3.1. Test Limit

Radiated emissions from 30 MHz to 2,000 MHz were measured with a bandwidth of 120 kHz according to the methods defines in ANSI C63.4-2003. The EUT was placed on a nonmetallic stand in the open-field site, 0.8 meter above the ground plane, as shown in section 3.2. The interface cables and equipment positions were varied within limits of reasonable applications to determine the positions producing maximum radiated emissions. For unintentional device, according to § 15.109(a), except for Class A digital devices, the field strength of radiated emissions from unintentional radiators at a distance of 3 meters shall not exceed the following values:

Frequency (MHz)	Distance Meters	Radiated ( $\mu$ V / M)	Radiated (dB $\mu$ V/ M)
30-88	3	100	40.0
88-216	3	150	43.5
216-960	3	200	46.0
Above 960	3	500	54.0

For unintentional device, according to CISPR PUB.22, for Class B digital devices, the general requirement of field strength of radiated emissions from intentional radiators at a distance of 10 meters shall not exceed the below table.

Frequency (MHz)	Distance Meters	Radiated (dB $\mu$ V/ M)
30-230	10	30
230-1000	10	37

#### 3.2. Test Procedures

- The EUT was placed on a Rota table top 0.8 meter above ground.
- The EUT was set 10 meters from the interference receiving antenna which was mounted on the top of a variable height antenna tower.
- The table was rotated 360 degrees to determine the position of the highest radiation.
- The antenna is a half wave dipole and its height is varied between one meter and four meters above ground to find the maximum value of the field strength both horizontal polarization and vertical polarization of the antenna are set to make the measurement.
- For each suspected emission the EUT was arranged to its worst case and then tune the antenna tower (from 1 M to 4 M) and turn table (from 0 degree to 360 degrees) to find the maximum reading.
- Set the test-receiver system to Peak Detect Function and specified bandwidth with Maximum Hold Mode.
- If the emission level of the EUT in peak mode was 6 dB lower than the limit specified, then testing will be stopped and peak values of EUT will be reported, otherwise, the emissions which do not have 6 dB margin will be repeated one by one using the quasi-peak method and reported.



### 3.3. Typical test Setup

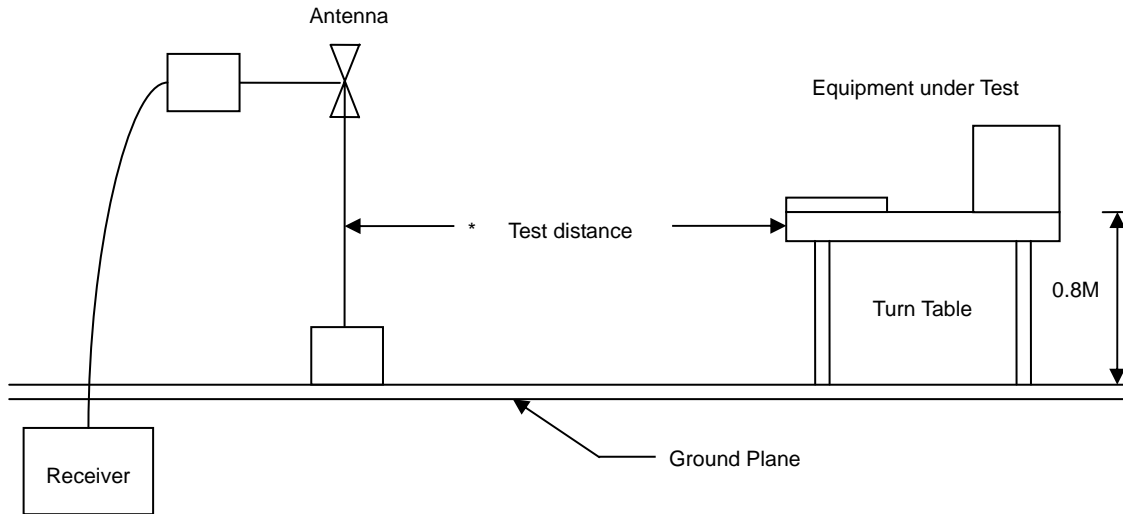

### 3.4. Measurement equipment

Instrument	Manufacturer	Model No.	Serial No.	Calibration Date	Valid Date
Bilog Antenna	CBL6112B	Schaffner	2840	2008/05/15	2009/05/14
Signal Generator	8648B	HP	3629U00612	2008/10/08	2009/10/07
Amplifier	8447D	Agilent	2944A10593	2008/05/26	2009/05/25
EMI Receiver	8546A	HP	3807A00454	2008/08/07	2009/08/06
RF Filter Section	85460A	HP	3704A00386	2008/08/07	2009/08/06
AC Power Converter	AFC-11005	APC	F103120008	N/A	N/A



### 3.5. Test Result and Data

Power	: AC 120V	Pol/Phase	: VERTICAL
Test Mode	: Link Wireless	Temperature	: 22 °C
Memo	:	Humidity	: 70 %

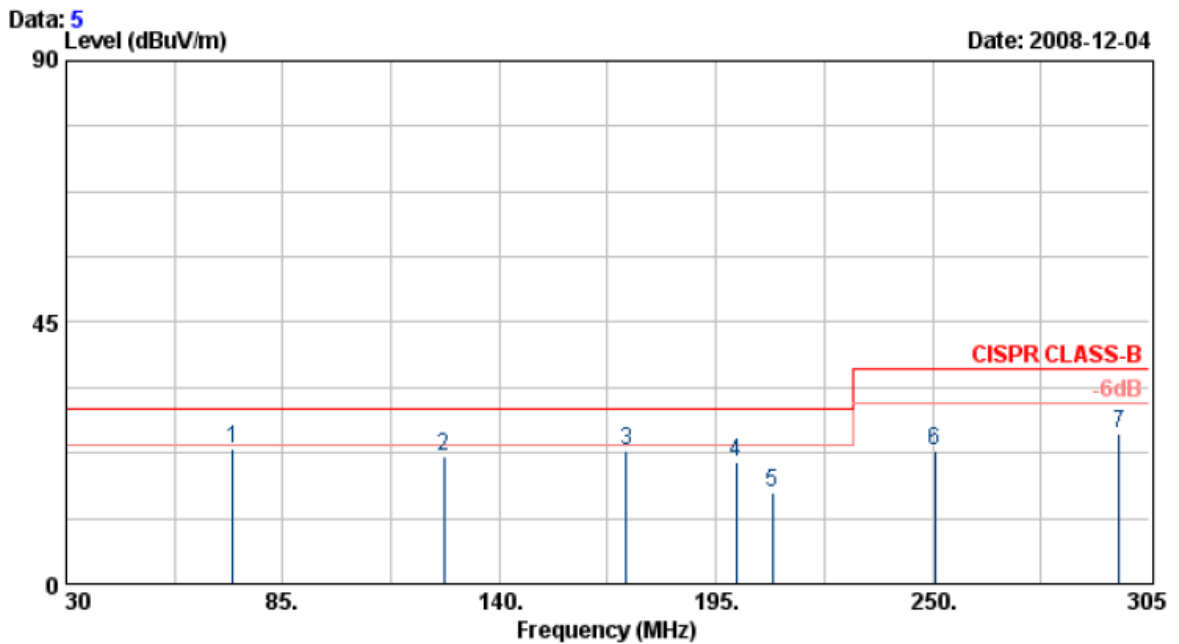

Item	Freq MHz	Read Value dBuV/m	Factor dB	Result dBuV/m	Limit dBuV/m	Margin dB	Remark	Ant Pos cm	Tab Pos Deg
1	72.35	40.35	-16.98	23.37	30.00	-6.63	Peak	300	360
2	125.98	37.40	-15.57	21.84	30.00	-8.16	Peak	300	360
3	172.18	37.35	-14.43	22.92	30.00	-7.08	Peak	300	360
4	200.23	37.43	-16.33	21.10	30.00	-8.90	Peak	300	360
5	209.30	31.55	-15.89	15.66	30.00	-14.34	Peak	300	360
6	250.55	36.69	-13.85	22.84	37.00	-14.16	Peak	300	360
7	297.30	37.75	-12.04	25.71	37.00	-11.29	Peak	300	360

Remarks: 1. Result = Read Value + Factor  
 2. Factor = Antenna factor + Cable loss - Amplifier factor



Power	: AC 120V	Pol/Phase	: VERTICAL
Test Mode	: Link Wireless	Temperature	: 22 °C
Memo	:	Humidity	: 70 %

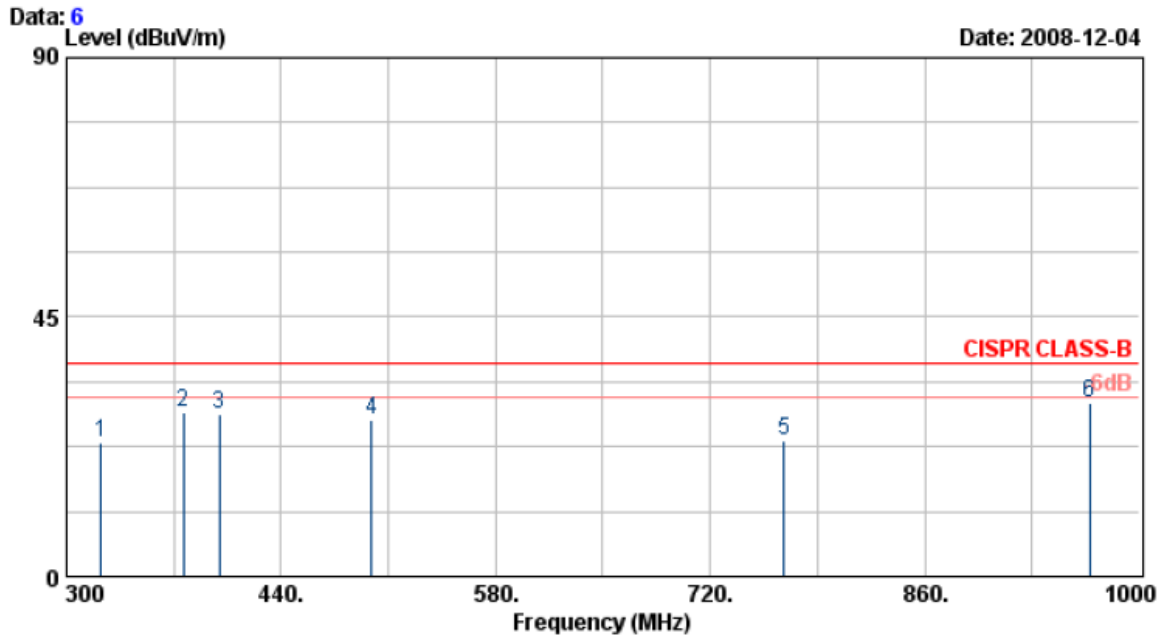

Item	Freq	Read Value	Factor	Result	Limit	Margin	Remark	Ant Pos	Tab Pos
	MHz	dBuV/m	dB	dBuV/m	dBuV/m	dB		cm	Deg
1	322.40	34.54	-11.22	23.32	37.00	-13.68	Peak	100	0
2	376.30	38.29	-9.87	28.42	37.00	-8.58	Peak	100	0
3	399.40	37.66	-9.58	28.08	37.00	-8.92	Peak	100	0
4	498.80	35.10	-7.98	27.12	37.00	-9.88	Peak	100	0
5	768.30	25.05	-1.44	23.61	37.00	-13.39	Peak	100	0
6	967.80	28.09	2.16	30.25	37.00	-6.75	Peak	100	0

Remarks: 1. Result = Read Value + Factor  
2. Factor = Antenna factor + Cable loss - Amplifier factor





Power	: AC 120V	Pol/Phase	: HORIZONTAL
Test Mode	: Link Wireless	Temperature	: 22 °C
Memo	:	Humidity	: 70 %

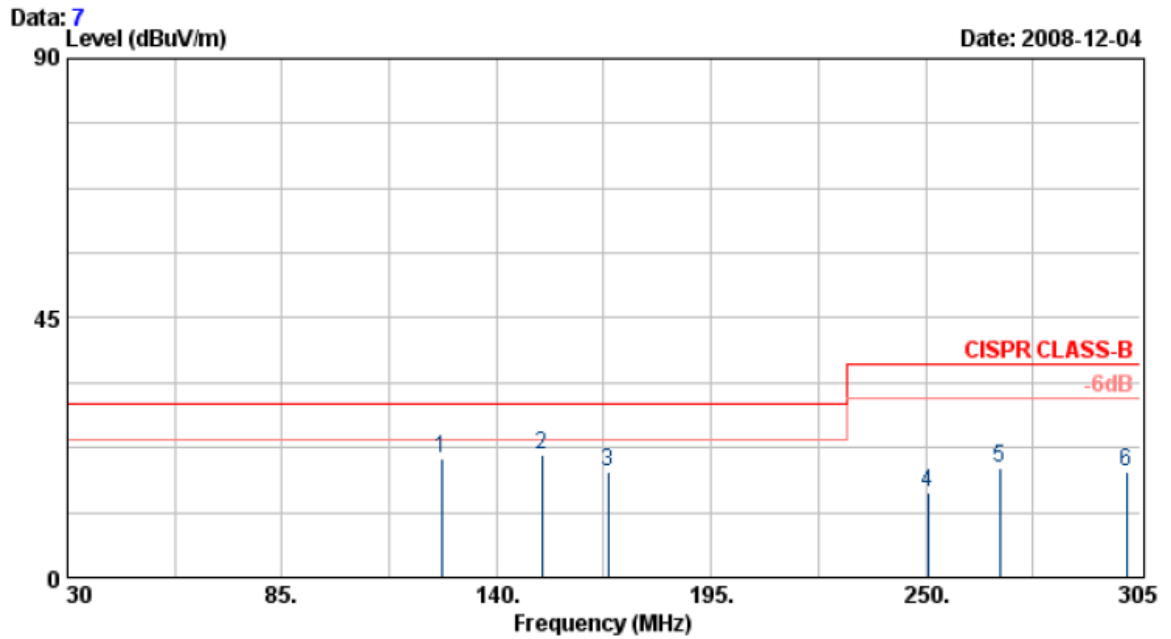

Item	Freq MHz	Read Value dBuV/m	Factor dB	Result dBuV/m	Limit dBuV/m	Margin dB	Remark	Ant Pos cm	Tab Pos Deg
1	125.98	36.12	-15.57	20.56	30.00	-9.44	Peak	400	0
2	151.55	34.90	-13.51	21.38	30.00	-8.62	Peak	400	0
3	168.60	32.44	-14.11	18.33	30.00	-11.67	Peak	400	0
4	250.55	28.60	-13.85	14.75	37.00	-22.25	Peak	400	0
5	268.98	32.15	-13.11	19.03	37.00	-17.97	Peak	400	0
6	301.43	30.30	-11.91	18.39	37.00	-18.61	Peak	400	0

Remarks: 1. Result = Read Value + Factor  
2. Factor = Antenna factor + Cable loss - Amplifier factor



Power	: AC 120V	Pol/Phase	: HORIZONTAL
Test Mode	: Link Wireless	Temperature	: 22 °C
Memo	:	Humidity	: 70 %

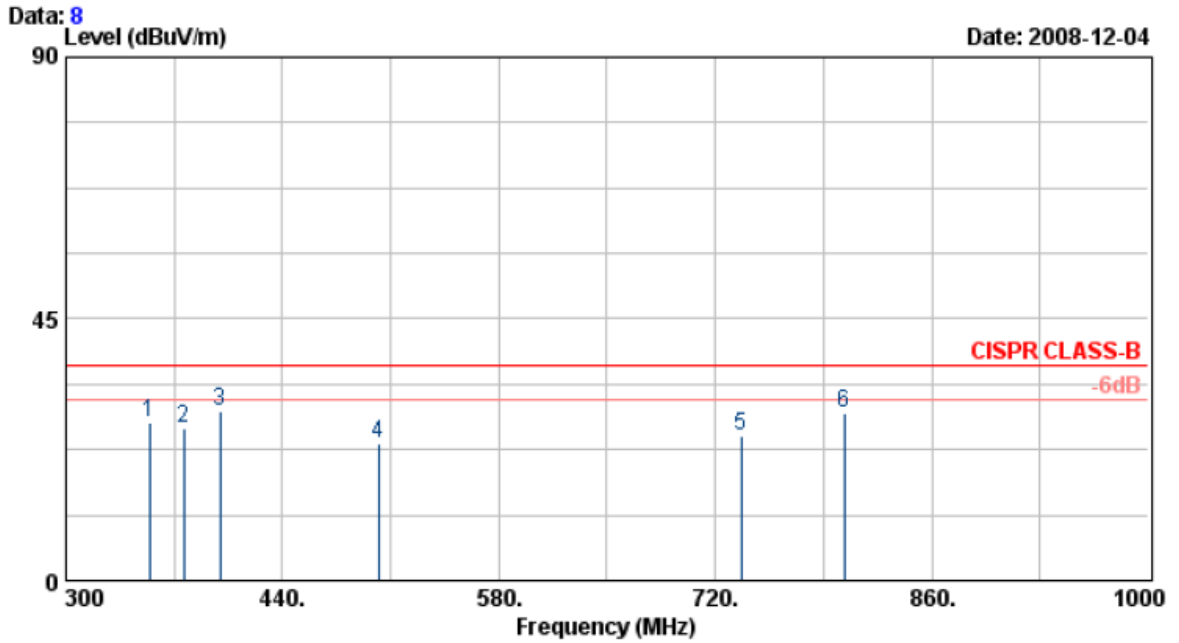

Item	Freq MHz	Read Value dBuV/m	Factor dB	Result dBuV/m	Limit dBuV/m	Margin dB	Remark	Ant Pos cm	Tab Pos Deg
1	353.90	37.76	-10.48	27.28	37.00	-9.72	Peak	100	0
2	376.30	35.96	-9.87	26.09	37.00	-10.91	Peak	100	0
3	399.40	38.68	-9.58	29.10	37.00	-7.90	Peak	100	0
4	502.30	31.63	-7.91	23.72	37.00	-13.28	Peak	100	0
5	736.80	27.02	-2.12	24.90	37.00	-12.10	Peak	100	0
6	803.30	29.62	-0.90	28.72	37.00	-8.28	Peak	100	0

Remarks: 1. Result = Read Value + Factor  
2. Factor = Antenna factor + Cable loss - Amplifier factor



Power	: AC 120V	Pol/Phase	: VERTICAL
Test Mode	: Link Wireless	Temperature	: 22 °C
Memo	:	Humidity	: 70 %

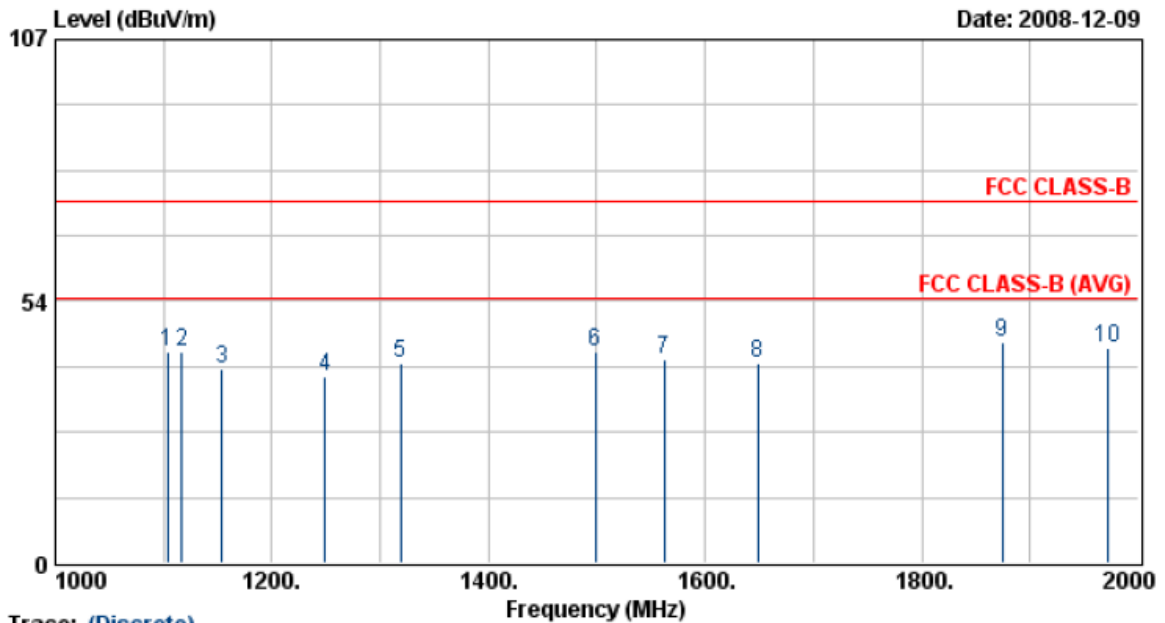

Trace: (Discrete)

Item	Freq	Read Value	Factor	Result	Limit	Margin	Remark	Ant Pos	Tab Pos
	MHz	dBuV/m	dB	dBuV/m	dBuV/m	dB		cm	Deg
1	1104.00	52.87	-9.82	43.05	74.00	-30.95	Peak	100	0
2	1117.00	52.97	-9.74	43.23	74.00	-30.77	Peak	100	0
3	1154.00	49.07	-9.54	39.53	74.00	-34.47	Peak	100	0
4	1249.00	47.27	-9.01	38.26	74.00	-35.74	Peak	100	0
5	1319.00	49.47	-8.61	40.85	74.00	-33.15	Peak	100	0
6	1499.00	50.97	-7.61	43.36	74.00	-30.64	Peak	100	0
7	1562.00	48.87	-7.27	41.60	74.00	-32.40	Peak	100	0
8	1649.00	47.57	-6.80	40.77	74.00	-33.23	Peak	100	0
9	1874.00	50.75	-5.58	45.17	74.00	-28.83	Peak	100	0
10	1972.00	48.86	-5.05	43.81	74.00	-30.19	Peak	100	0

Remarks: 1. Result = Read Value + Factor  
 2. Factor = Antenna factor + Cable loss - Amplifier factor



Power	: AC 120V	Pol/Phase	: HORIZONTAL
Test Mode	: Link Wireless	Temperature	: 22 °C
Memo	:	Humidity	: 70 %

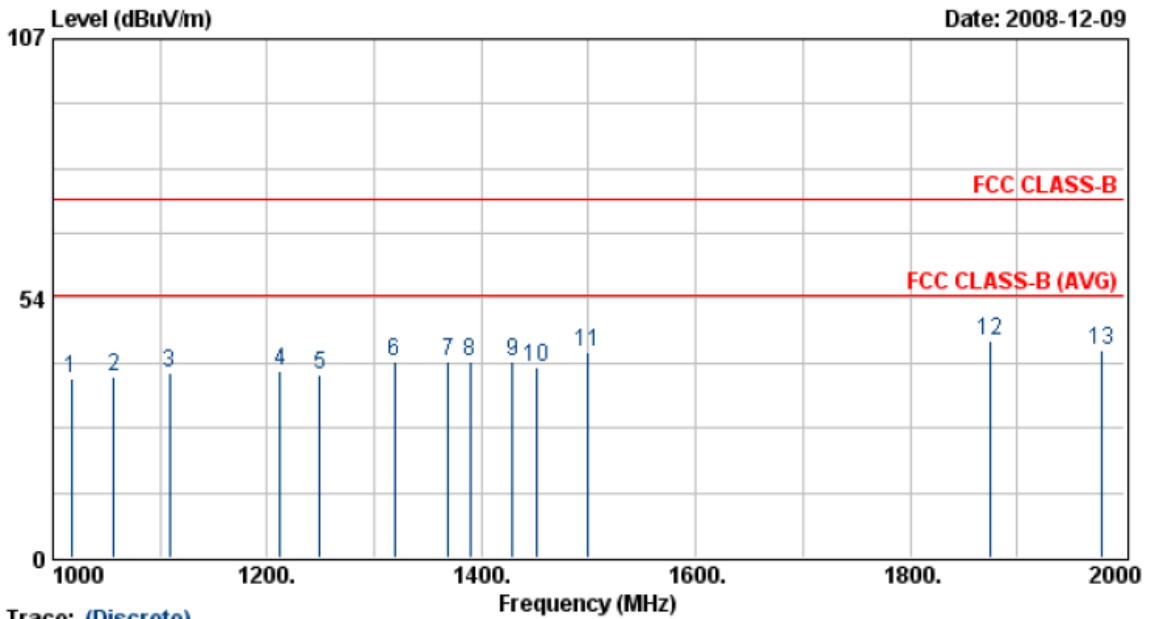

Trace: (Discrete)

Item	Freq MHz	Read Value dBuV/m	Factor dB	Result dBuV/m	Limit dBuV/m	Margin dB	Remark	Ant Pos cm	Tab Pos Deg
1	1017.00	47.29	-10.30	36.98	74.00	-37.02	Peak	100	360
2	1057.00	47.50	-10.08	37.42	74.00	-36.58	Peak	100	360
3	1109.00	47.87	-9.79	38.08	74.00	-35.92	Peak	100	360
4	1212.00	47.81	-9.21	38.59	74.00	-35.41	Peak	100	360
5	1249.00	46.61	-9.01	37.60	74.00	-36.40	Peak	100	360
6	1319.00	48.90	-8.61	40.28	74.00	-33.72	Peak	100	360
7	1369.00	48.63	-8.33	40.29	74.00	-33.71	Peak	100	360
8	1389.00	48.81	-8.22	40.59	74.00	-33.41	Peak	100	360
9	1429.00	48.47	-8.00	40.47	74.00	-33.53	Peak	100	360
10	1452.00	47.20	-7.87	39.33	74.00	-34.67	Peak	100	360
11	1499.00	50.09	-7.61	42.48	74.00	-31.52	Peak	100	360
12	1874.00	50.27	-5.58	44.69	74.00	-29.31	Peak	100	360
13	1979.00	47.92	-5.01	42.90	74.00	-31.10	Peak	100	360

Remarks: 1. Result = Read Value + Factor  
 2. Factor = Antenna factor + Cable loss - Amplifier factor

Test engineer: Ray



### 3.6. Test Photographs

Front View



Rear View





Appendix A. Photographs of EUT



