

# RF TEST REPORT



Report No.: 15021175-FCC-R2  
Supersede Report No.: N/A

Applicant	Ringway Tech(Jiangsu) Co.,Ltd.	
Product Name	Symphony Grand	
Model No.	CSR8670	
Serial No.	N/A	
Test Standard	FCC Part 15.247: 2015, ANSI C63.10: 2013	
Test Date	November 23 to November 24, 2015	
Issue Date	December 01,2015	
Test Result	<input checked="" type="checkbox"/> Pass <input type="checkbox"/> Fail	
Equipment complied with the specification	<input checked="" type="checkbox"/>	
Equipment did not comply with the specification	<input type="checkbox"/>	
<i>Amos Xia</i>	<i>Herve Idoko</i>	
Amos Xia Test Engineer	Herve Idoko Checked By	
This test report may be reproduced in full only Test result presented in this test report is applicable to the tested sample only		

Issued by:  
 SIEMIC (Nanjing-China) Laboratories  
 2-1 Longcang Avenue Yuhua Economic and  
 Technology Development Park, Nanjing, China  
 Tel:+86(25)86730128/86730129 Fax:+86(25)86730127 Email: China@siemic.com.cn

## Laboratories Introduction

SIEMIC, headquartered in the heart of Silicon Valley, with superior facilities in US and Asia, is one of the leading independent testing and certification facilities providing customers with one-stop shop services for Compliance Testing and Global Certifications.



In addition to testing and certification, SIEMIC provides initial design reviews and compliance management throughout a project. Our extensive experience with China, Asia Pacific, North America, European, and International compliance requirements, assures the fastest, most cost effective way to attain regulatory compliance for the global markets.

### Accreditations for Conformity Assessment

Country/Region	Scope
USA	EMC, RF/Wireless, SAR, Telecom
Canada	EMC, RF/Wireless, SAR, Telecom
Taiwan	EMC, RF, Telecom, SAR, Safety
Hong Kong	RF/Wireless, SAR, Telecom
Australia	EMC, RF, Telecom, SAR, Safety
Korea	EMI, EMS, RF, SAR, Telecom, Safety
Japan	EMI, RF/Wireless, SAR, Telecom
Singapore	EMC, RF, SAR, Telecom
Europe	EMC, RF, SAR, Telecom, Safety

Test Report No.	15021175-FCC-R2
Page	3 of 31

This page has been left blank intentionally.

## CONTENTS

1. REPORT REVISION HISTORY.....	5
2. CUSTOMER INFORMATION .....	5
3. TEST SITE INFORMATION.....	5
4. EQUIPMENT UNDER TEST (EUT) INFORMATION .....	6
5. TEST SUMMARY .....	7
6. MEASUREMENTS, EXAMINATION AND DERIVED RESULTS .....	8
6.1 ANTENNA REQUIREMENT .....	8
6.2 DTS (6 DB) CHANNEL BANDWIDTH .....	9
6.3 MAXIMUM OUTPUT POWER .....	11
6.4 POWER SPECTRAL DENSITY .....	13
6.5 BAND-EDGE & UNWANTED EMISSIONS INTO NON-RESTRICTED FREQUENCY BANDS .....	15
6.6 AC POWER LINE CONDUCTED EMISSIONS.....	17
6.7 RADIATED SPURIOUS EMISSIONS.....	20
ANNEX A. TEST INSTRUMENT .....	24
ANNEX B. EUT AND TEST SETUP PHOTOGRAPHS .....	25
ANNEX C. TEST SETUP AND SUPPORTING EQUIPMENT.....	27
ANNEX D. USER MANUAL / BLOCK DIAGRAM / SCHEMATICS / PARTLIST.....	30
ANNEX E. DECLARATION OF SIMILARITY .....	31

Test Report No.	15021175-FCC-R2
Page	5 of 31

## 1. Report Revision History

Report No.	Report Version	Description	Issue Date
15021175-FCC-R2	NONE	Original	December 01,2015

## 2. Customer information

Applicant Name	Ringway Tech(Jiangsu) Co.,Ltd.
Applicant Add	No. 101 West Hanjiang Road, Changzhou,Jiangsu, China
Manufacturer	Ringway Tech(Jiangsu) Co.,Ltd.
Manufacturer Add	No. 101 West Hanjiang Road, Changzhou,Jiangsu, China

## 3. Test site information

Lab performing tests	SIEMIC (Nanjing-China) Laboratories
Lab Address	2-1 Longcang Avenue Yuhua Economic and Technology Development Park, Nanjing, China
FCC Test Site No.	986914
IC Test Site No.	4842B-1
Test Software	Labview of SIEMIC version 1.0

#### 4. Equipment under Test (EUT) Information

Description of EUT:	Symphony Grand
Main Model:	CSR8670
Serial Model:	N/A
Date EUT received:	November 12, 2015
Test Date(s):	November 23 to November 24, 2015
Equipment Category :	DTS
Antenna Gain:	Bluetooth/BLE: 1.54 dBi
Type of Modulation:	Bluetooth: GFSK, $\pi/4$ DQPSK, 8DPSK BLE: GFSK
RF Operating Frequency (ies):	Bluetooth& BLE: 2402-2480 MHz
Max. Output Power:	3.001dBm
Number of Channels:	Bluetooth: 79CH BLE: 40CH
Input Power:	DC 5V
Port:	N/A
Trade Name :	N/A
FCC ID:	OCDSYMPHONY

## 5. Test Summary

The product was tested in accordance with the following specifications.  
All testing has been performed according to below product classification:

FCC Rules	Description of Test	Result
§15.203	Antenna Requirement	Compliance
§15.247 (a)(2)	DTS (6 dB) CHANNEL BANDWIDTH	Compliance
§15.247(b)(3)	Conducted Maximum Output Power	Compliance
§15.247(e)	Power Spectral Density	Compliance
§15.247(d)	Band-Edge & Unwanted Emissions into Non-Restricted Frequency Bands	Compliance
§15.207 (a),	AC Power Line Conducted Emissions	Compliance
§15.205, §15.209, §15.247(d)	Radiated Spurious Emissions & Unwanted Emissions into Restricted Frequency Bands	Compliance

### Measurement Uncertainty

Emissions		
Test Item	Description	Uncertainty
Band Edge and Radiated Spurious Emissions	Confidence level of approximately 95% (in the case where distributions are normal), with a coverage factor of 2 (for EUTs < 0.5m X 0.5m X 0.5m)	3.952dB
-	-	-

## 6. Measurements, Examination And Derived Results

### 6.1 Antenna Requirement

#### Applicable Standard

According to § 15.203, an intentional radiator shall be designed to ensure that no antenna other than that furnished by the responsible party shall be used with the device. The use of a permanently attached antenna or of an antenna that uses a unique coupling to the intentional radiator shall be considered sufficient to comply with the provisions of this section. The manufacturer may design the unit so that a broken antenna can be replaced by the user, but the user of a standard antenna jack or electrical connector is prohibited. The structure and application of the EUT were analyzed to determine compliance with section §15.203 of the rules. §15.203 state that the subject device must meet the following criteria:

- a. Antenna must be permanently attached to the unit.
- b. Antenna must use a unique type of connector to attach to the EUT.

Unit must be professionally installed, and installer shall be responsible for verifying that the correct antenna is employed with the unit. And according to FCC 47 CFR section 15.247 (b), if the transmitting antennas of directional gain greater than 6dBi are used, the power shall be reduced by the amount in dB that the directional gain of the antenna exceeds 6 dBi.

#### Antenna Connector Construction

The EUT has 1 antennas:

A permanently attached PCB antenna for Bluetooth/BLE, the gain is 1.54dBi for Bluetooth/BLE.

**The antenna meets up with the ANTENNA REQUIREMENT.**

Result: Compliant.



## 6.2 DTS (6 dB) Channel Bandwidth

Temperature	23°C
Relative Humidity	51%
Atmospheric Pressure	1018mbar
Test date :	November 23, 2015
Tested By :	Amos Xia

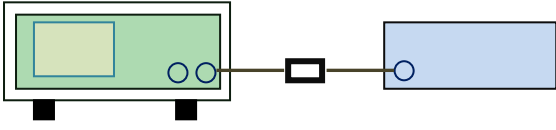
Spec	Item	Requirement	Applicable
§ 15.247(a)(2) RSS Gen(4.6.1)	a)	6dB BW≥500kHz;	<input checked="" type="checkbox"/>
	b)	99% BW: For FCC reference only; required by IC.	N/A
Test Setup	 <p style="text-align: center;">Spectrum Analyzer                      EUT</p>		
Test Procedure	<p>558074 D01 DTS MEAS Guidance v03r02, 8.1 DTS bandwidth <u>6dB Emission bandwidth measurement procedure</u></p> <ul style="list-style-type: none"> <li>- Set RBW = 100 kHz.</li> <li>- Set the video bandwidth (VBW) ≥ 3 × RBW.</li> <li>- Detector = Peak.</li> <li>- Trace mode = max hold.</li> <li>- Sweep = auto couple.</li> <li>- Allow the trace to stabilize.</li> </ul> <p>Measure the maximum width of the emission that is constrained by the frequencies associated with the two outermost amplitude points (upper and lower frequencies) that are attenuated by 6 dB relative to the maximum level measured in the fundamental emission.</p>		
Remark			
Result	<input checked="" type="checkbox"/> Pass <input type="checkbox"/> Fail		

Test Data     Yes                       N/A

Test Plot     Yes (See below)                       N/A

### 6dB Bandwidth measurement result Test Data

CH	Freq (MHz)	6dB Bandwidth (kHz)
Low	2402	695.7
Mid	2440	695.5
High	2480	696.6

### Test Plots

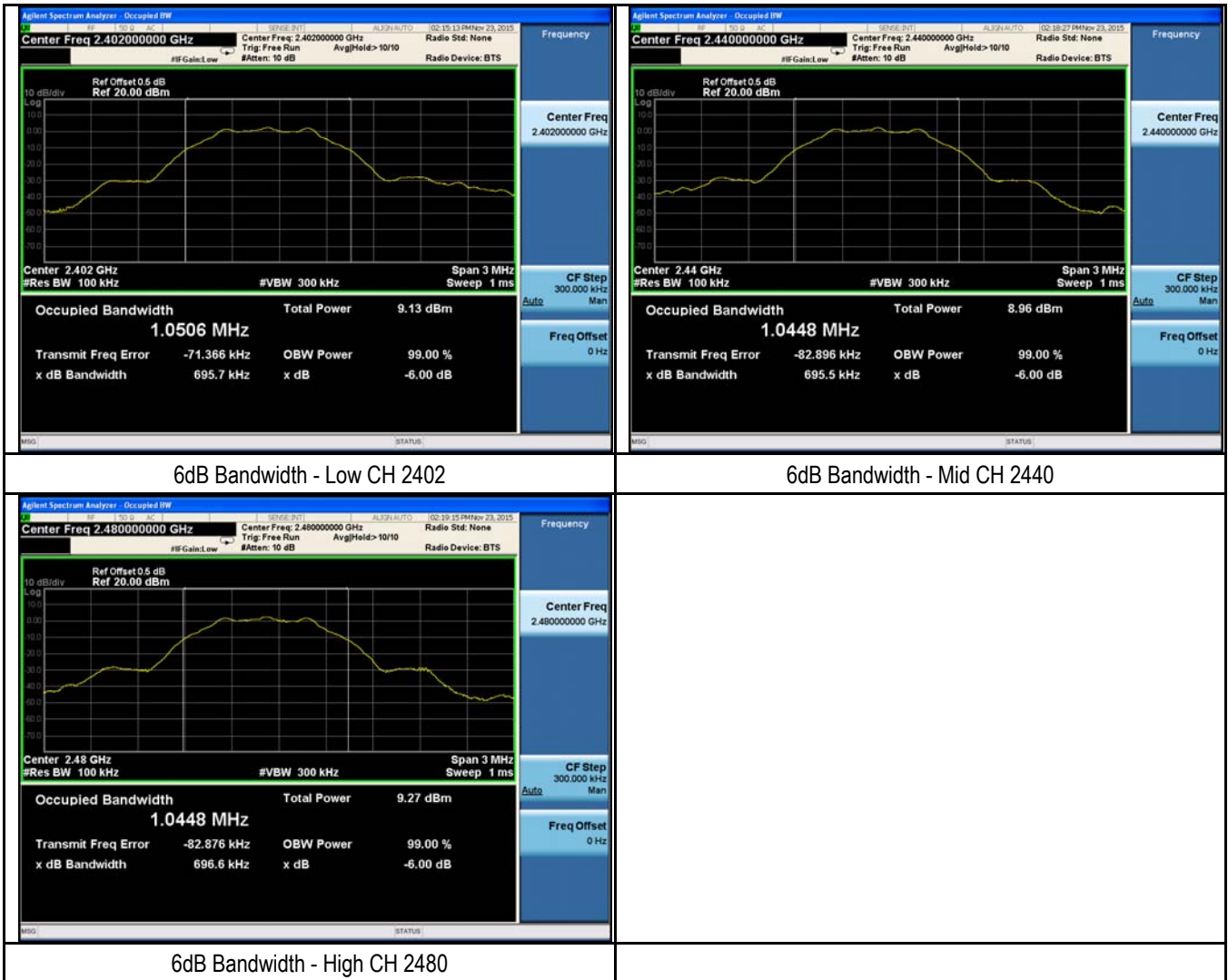

6dB Bandwidth - Low CH 2402

6dB Bandwidth - Mid CH 2440

6dB Bandwidth - High CH 2480

### 6.3 Maximum Output Power

Temperature	23°C
Relative Humidity	51%
Atmospheric Pressure	1018mbar
Test date :	November 23, 2015
Tested By :	Amos Xia

Requirement(s):

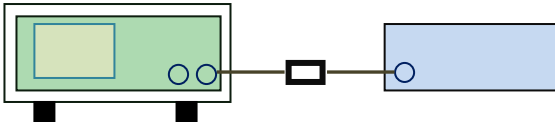
Spec	Item	Requirement	Applicable
§15.247(b) (2),RSS210 (A8.4)	a)	FHSS in 2400-2483.5MHz with $\geq 75$ channels: $\leq 1$ Watt	<input type="checkbox"/>
	b)	FHSS in 5725-5850MHz: $\leq 1$ Watt	<input type="checkbox"/>
	c)	For all other FHSS in the 2400-2483.5MHz band: $\leq 0.125$ Watt.	<input type="checkbox"/>
	d)	FHSS in 902-928MHz with $\geq 50$ channels: $\leq 1$ Watt	<input type="checkbox"/>
	e)	FHSS in 902-928MHz with $\geq 25$ & $< 50$ channels: $\leq 0.25$ Watt	<input type="checkbox"/>
	f)	DSSS in 902-928MHz, 2400-2483.5MHz, 5725-5850MHz: $\leq 1$ Watt	<input checked="" type="checkbox"/>
Test Setup	 <p style="text-align: center;"><b>Spectrum Analyzer</b>                      <b>EUT</b></p>		
Test Procedure	558074 D01 DTS MEAS Guidance v03r02, 9.1.2 Integrated band power method Maximum output power measurement procedure a) Set the RBW $\geq$ DTS bandwidth. b) Set VBW $\geq 3 \times$ RBW. c) Set span $\geq 3 \times$ RBW d) Sweep time = auto couple. e) Detector = peak. f) Trace mode = max hold. g) Allow trace to fully stabilize. h) Use peak marker function to determine the peak amplitude level.		
Remark			
Result	<input checked="" type="checkbox"/> Pass <input type="checkbox"/> Fail		

Test Data     Yes                       N/A  
 Test Plot     Yes (See below)                       N/A

Output Power measurement result

Test Data

Type	CH	Freq (MHz)	Conducted Power (dBm)	Limit (dBm)	Result
Output power	Low	2402	2.639	30	Pass
	Mid	2440	2.718	30	Pass
	High	2480	3.001	30	Pass

Test Plots

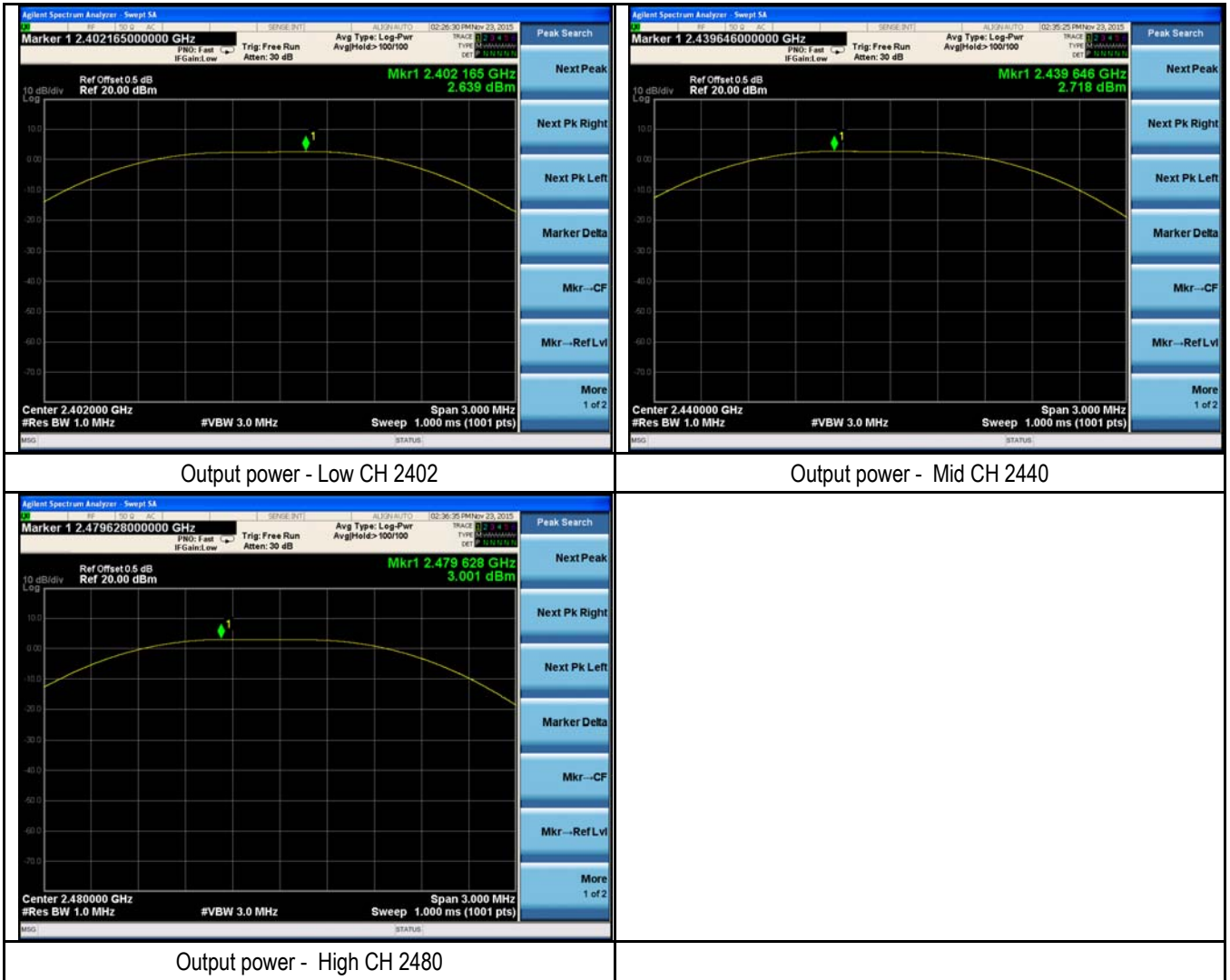

## 6.4 Power Spectral Density

Temperature	23°C
Relative Humidity	51%
Atmospheric Pressure	1018mbar
Test date :	November 23, 2015
Tested By :	Amos Xia

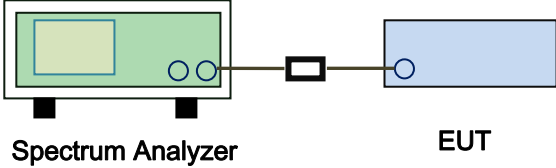
Spec	Item	Requirement	Applicable
§15.247(e)	a)	The power spectral density conducted from the intentional radiator to the antenna shall not be greater than 8 dBm in any 3 kHz band during any time interval of continuous transmission.	<input checked="" type="checkbox"/>
Test Setup	 <p style="text-align: center;">Spectrum Analyzer                      EUT</p>		
Test Procedure	558074 D01 DTS MEAS Guidance v03r02, 10.2 power spectral density method power spectral density measurement procedure <ul style="list-style-type: none"> <li>- a) Set analyzer center frequency to DTS channel center frequency.</li> <li>- b) Set the span to 1.5 times the DTS bandwidth.</li> <li>- c) Set the RBW to: <math>3 \text{ kHz} \leq \text{RBW} \leq 100 \text{ kHz}</math>.</li> <li>- d) Set the VBW <math>\geq 3 \times \text{RBW}</math>.</li> <li>- e) Detector = peak.</li> <li>- f) Sweep time = auto couple.</li> <li>- g) Trace mode = max hold.</li> <li>- h) Allow trace to fully stabilize.</li> <li>- i) Use the peak marker function to determine the maximum amplitude level within the RBW.</li> <li>- j) If measured value exceeds limit, reduce RBW (no less than 3 kHz) and repeat.</li> </ul>		
Remark			
Result	<input checked="" type="checkbox"/> Pass <input type="checkbox"/> Fail		

Test Data     Yes                       N/A  
 Test Plot     Yes (See below)                       N/A

### Power Spectral Density measurement result

#### Test Data

Type	CH	Freq (MHz)	PSD (dBm)	Limit (dBm)	Result
PSD	Low	2402	-4.916	8	Pass
	Mid	2440	-5.439	8	Pass
	High	2480	-4.588	8	Pass

Test Plots

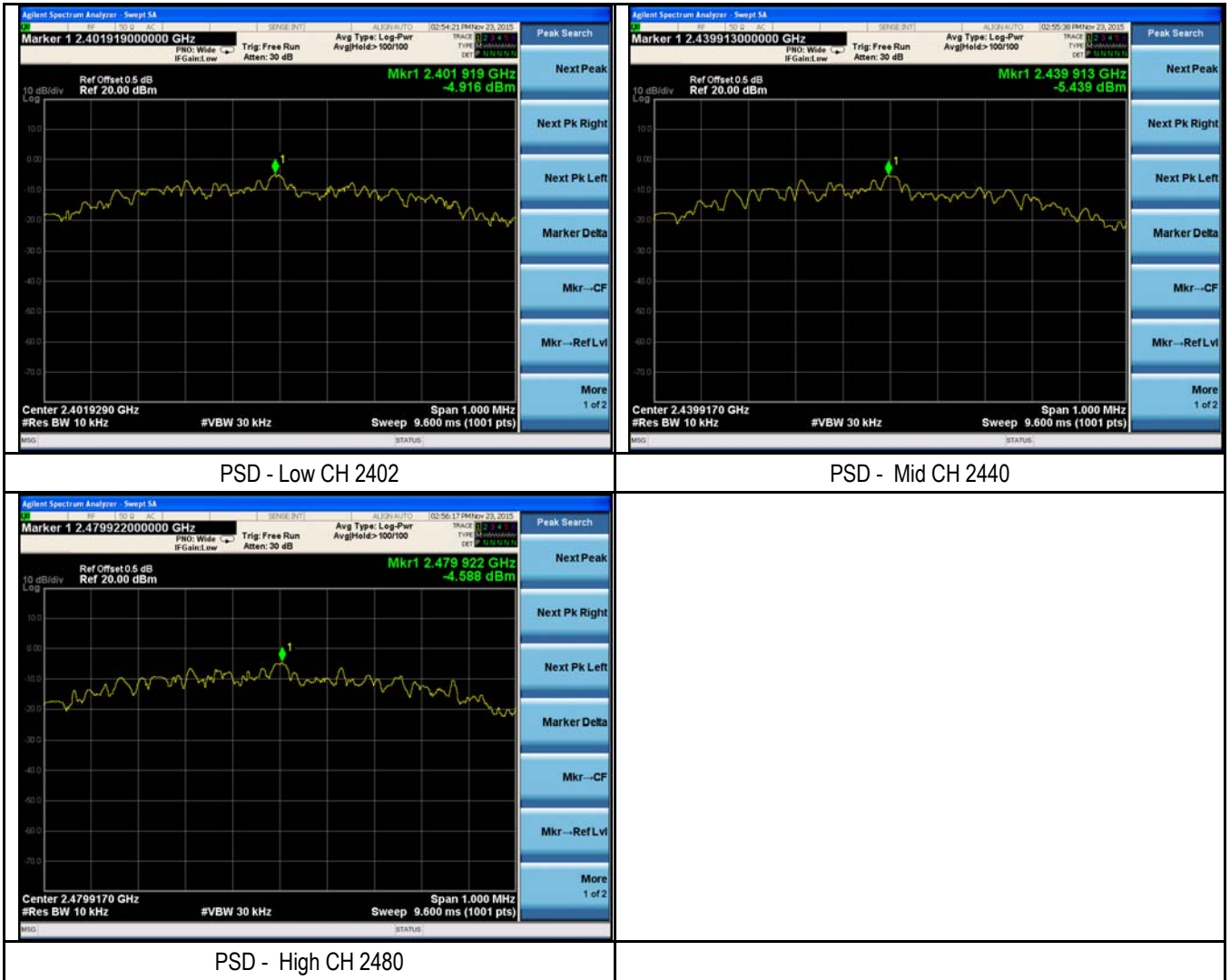

## 6.5 Band-Edge & Unwanted Emissions into Non-Restricted Frequency Bands

Temperature	24°C
Relative Humidity	57%
Atmospheric Pressure	1015mbar
Test date :	November 23, 2015
Tested By :	Amos Xia

### Requirement(s):

Spec	Item	Requirement	Applicable
§15.247(d)	a)	In any 100 kHz bandwidth outside the frequency band in which the spread spectrum or digitally modulated intentional radiator is operating, the radio frequency power that is produced by the intentional radiator shall be at least 20 dB below that in the 100 kHz bandwidth within the band that contains the highest level of the desired power, based on either an RF conducted or a radiated measurement, provided the transmitter demonstrates compliance with the peak conducted power limits.	<input checked="" type="checkbox"/>

Test Setup	
------------	--

Test Procedure	<p>Radiated Method Only</p> <ul style="list-style-type: none"> <li>- 1. Check the calibration of the measuring instrument using either an internal calibrator or a known signal from an external generator.</li> <li>- 2. Position the EUT without connection to measurement instrument. Put it on the Rotated table and turn on the EUT and make it operate in transmitting mode. Then set it to Low Channel and High Channel within its operating range, and make sure the instrument is operated in its linear range.</li> <li>- 3. First, set both RBW and VBW of spectrum analyzer to 100 kHz with a convenient frequency span including 100kHz bandwidth from band edge, check the emission of EUT, if pass then set Spectrum Analyzer as below: <ul style="list-style-type: none"> <li>a. The resolution bandwidth and video bandwidth of test receiver/spectrum analyzer is 120 kHz for Quasi Peak detection at frequency below 1GHz.</li> <li>b. The resolution bandwidth of test receiver/spectrum analyzer is 1MHz and video bandwidth is 3MHz with Peak detection for Peak measurement at frequency above 1GHz.</li> <li>c. The resolution bandwidth of test receiver/spectrum analyzer is 1MHz and the video bandwidth is 10Hz with Peak detection for Average Measurement as below at frequency above 1GHz.</li> </ul> </li> <li>- 4. Measure the highest amplitude appearing on spectral display and set it as a reference level. Plot the graph with marking the highest point and edge frequency.</li> <li>- 5. Repeat above procedures until all measured frequencies were complete.</li> </ul>
----------------	---

Remark	
Result	<input checked="" type="checkbox"/> Pass <input type="checkbox"/> Fail

Test Data  Yes  N/A

Test Plot  Yes (See below)  N/A

**Test Plots**  
**Band Edge measurement result**

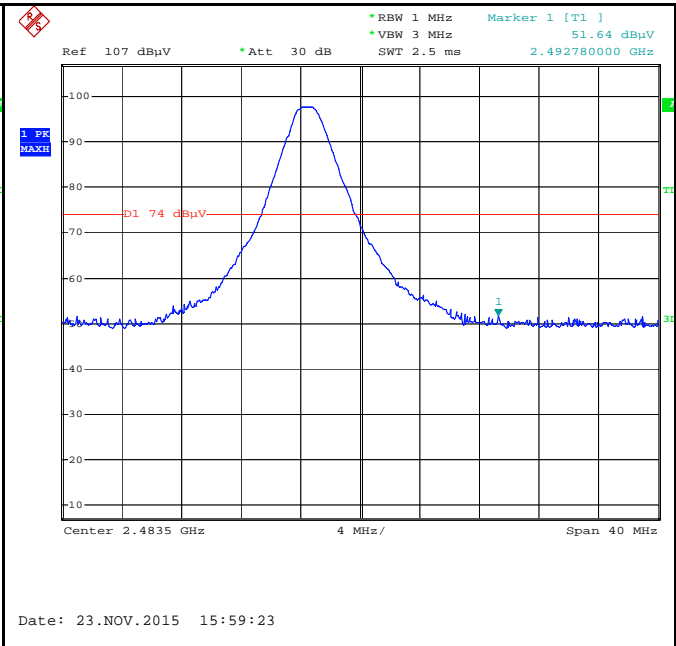
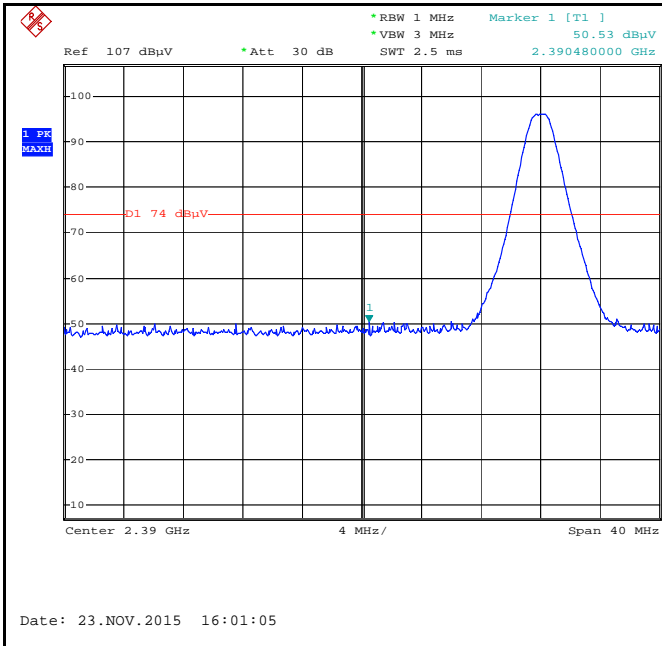

Band Edge, Left Side (Peak)

Band Edge, Right Side (Peak)

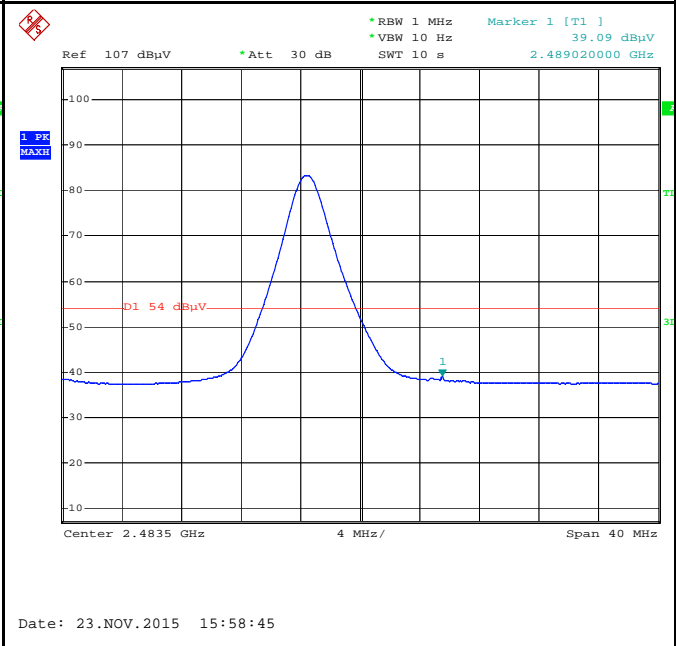
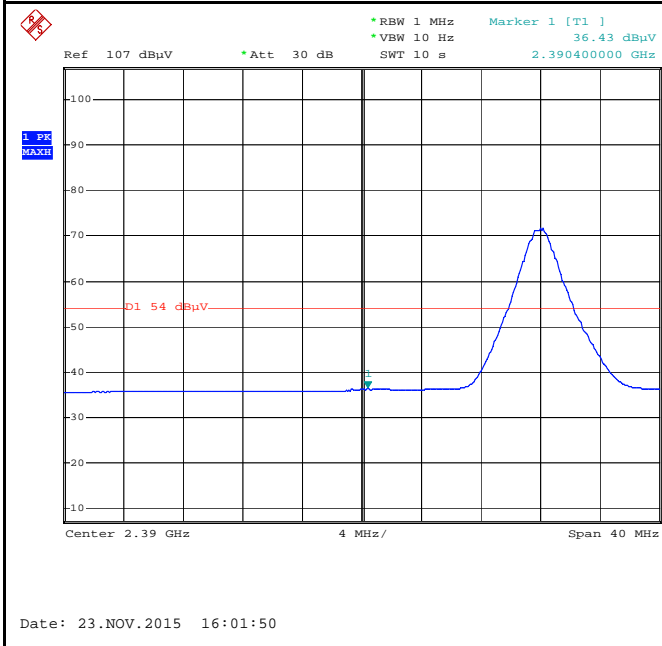

Band Edge, Left Side-AV

Band Edge, Right Side-AV



## 6.6 AC Power Line Conducted Emissions

Temperature	22°C
Relative Humidity	59%
Atmospheric Pressure	1017mbar
Test date :	December 04,2015
Tested By :	Amos Xia

### Requirement(s):

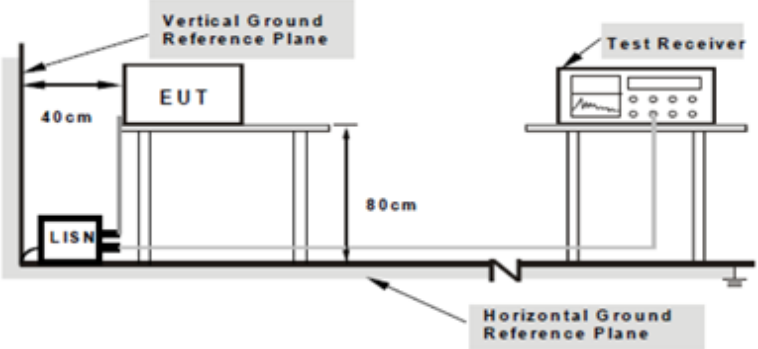
Spec	Item	Requirement	Applicable														
47CFR§15.207, RSS210 (A8.1)	a)	For Low-power radio-frequency devices that is designed to be connected to the public utility (AC) power line, the radio frequency voltage that is conducted back onto the AC power line on any frequency or frequencies, within the band 150 kHz to 30 MHz, shall not exceed the limits in the following table, as measured using a 50 [mu] H/50 ohms line impedance stabilization network (LISN). The lower limit applies at the boundary between the frequencies ranges.	<input checked="" type="checkbox"/>														
		<table border="1"> <thead> <tr> <th rowspan="2">Frequency ranges (MHz)</th> <th colspan="2">Limit (dBµV)</th> </tr> <tr> <th>QP</th> <th>Average</th> </tr> </thead> <tbody> <tr> <td>0.15 ~ 0.5</td> <td>66 – 56</td> <td>56 – 46</td> </tr> <tr> <td>0.5 ~ 5</td> <td>56</td> <td>46</td> </tr> <tr> <td>5 ~ 30</td> <td>60</td> <td>50</td> </tr> </tbody> </table>		Frequency ranges (MHz)	Limit (dBµV)		QP	Average	0.15 ~ 0.5	66 – 56	56 – 46	0.5 ~ 5	56	46	5 ~ 30	60	50
		Frequency ranges (MHz)			Limit (dBµV)												
				QP	Average												
0.15 ~ 0.5	66 – 56	56 – 46															
0.5 ~ 5	56	46															
5 ~ 30	60	50															
Test Setup	 <p style="text-align: center;">Note: 1.Support units were connected to second LISN. 2.Both of LISNs (AMN) are 80cm from EUT and at least 80cm from other units and other metal planes support units.</p>																
Procedure	<ol style="list-style-type: none"> <li>The EUT and supporting equipment were set up in accordance with the requirements of the standard on top of a 1.5m x 1m x 0.8m high, non-metallic table.</li> <li>The power supply for the EUT was fed through a 50 [mu] H/50 EUT LISN, connected to filtered mains.</li> <li>The RF OUT of the EUT LISN was connected to the EMI test receiver via a low-loss coaxial cable.</li> <li>All other supporting equipment were powered separately from another main supply.</li> <li>The EUT was switched on and allowed to warm up to its normal operating condition.</li> <li>A scan was made on the NEUTRAL line (for AC mains) or Earth line (for DC power) over the required frequency range using an EMI test receiver.</li> <li>High peaks, relative to the limit line, The EMI test receiver was then tuned to the selected frequencies and the necessary measurements made with a receiver bandwidth setting of 10 kHz.</li> <li>Step 7 was then repeated for the LIVE line (for AC mains) or DC line (for DC power).</li> </ol>																
Remark	Note : The Laptop input power ( 120V/60Hz、240V/60Hz ) have been tested , but only worst ( 120V/60Hz ) case is the reported.																
Result	<input checked="" type="checkbox"/> Pass <input type="checkbox"/> Fail																

Test Data     Yes       N/A  
 Test Plot     Yes (See below)       N/A

**Test Mode:** Transmitting BLE Mode

**Peak Detector**     **Quasi Peak Limit**      
**Average Detector**     **Average Limit**    

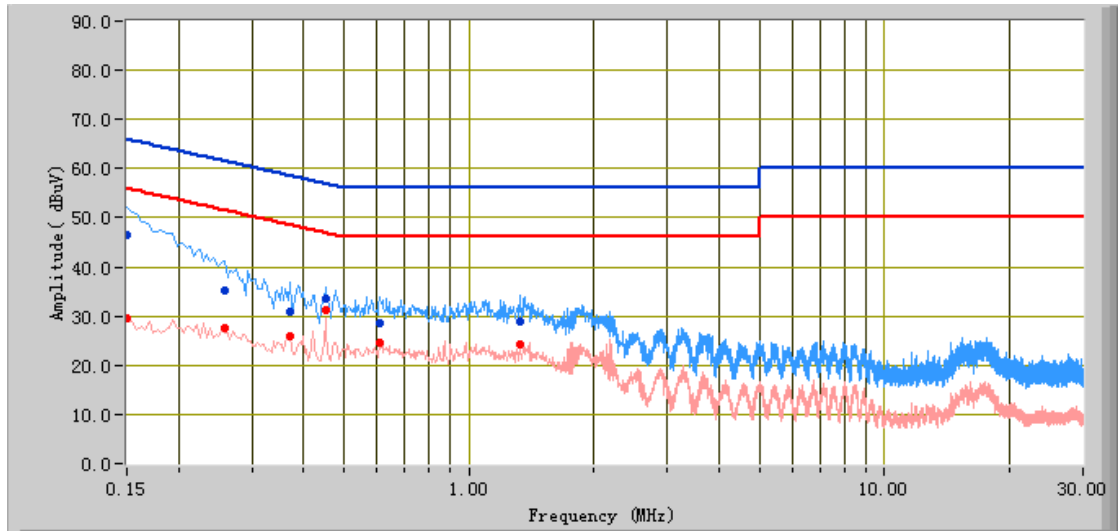

**Test Data**

**Phase Line Plot at 120Vac, 60Hz**

Frequency (MHz)	Quasi Peak (dBuV)	Limit (dBuV)	Margin (dB)	Average (dBuV)	Limit (dBuV)	Margin (dB)	Factors (dB)
0.15	46.36	66.00	-19.64	29.59	56.00	-26.41	12.22
0.26	35.28	61.50	-26.21	27.64	51.50	-23.85	11.44
0.45	33.47	56.87	-23.40	31.09	46.87	-15.79	11.16
0.37	30.84	58.50	-27.66	26.06	48.50	-22.44	11.28
1.33	29.05	56.00	-26.95	24.28	46.00	-21.72	10.75
0.61	28.69	56.00	-27.31	24.47	46.00	-21.53	11.00

**Test Mode:** Transmitting BLE Mode

**Peak Detector**     **Quasi Peak Limit**      
**Average Detector**     **Average Limit**    

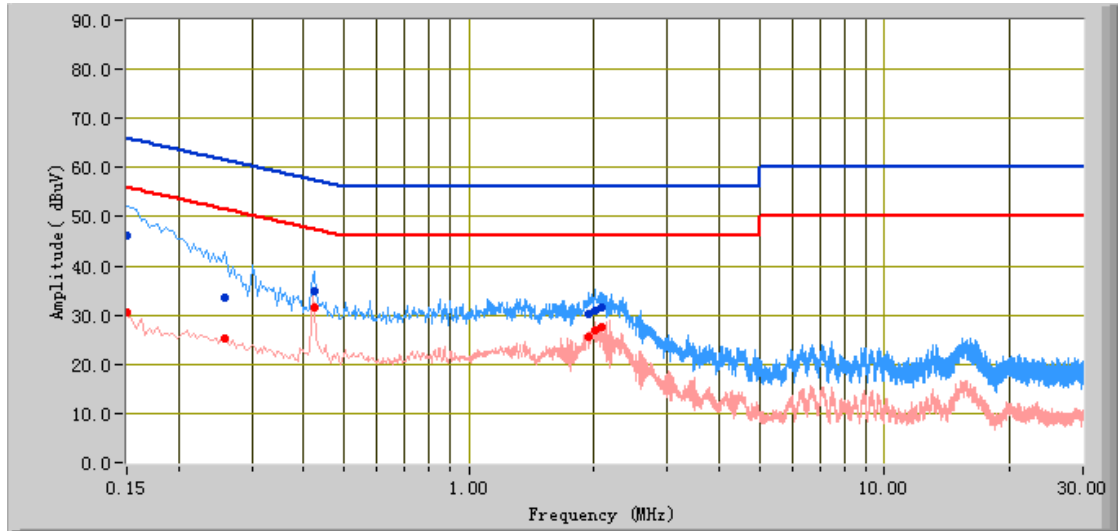

**Test Data**

**Phase Neutral Plot at 120Vac, 60Hz**

Frequency (MHz)	Quasi Peak (dBuV)	Limit (dBuV)	Margin (dB)	Average (dBuV)	Limit (dBuV)	Margin (dB)	Factors (dB)
0.15	46.10	66.00	-19.90	30.39	56.00	-25.61	12.21
0.43	34.71	57.33	-22.62	31.59	47.33	-15.74	11.18
0.26	33.63	61.50	-27.87	25.11	51.50	-26.38	11.44
2.01	30.84	56.00	-25.16	26.84	46.00	-19.16	10.92
1.93	30.28	56.00	-25.72	25.67	46.00	-20.33	10.90
2.09	31.44	56.00	-24.56	27.63	46.00	-18.37	10.92

## 6.7 Radiated Spurious Emissions

Temperature	22°C
Relative Humidity	59%
Atmospheric Pressure	1017mbar
Test date :	December 03, 2015
Tested By :	Amos Xia

### Requirement(s):

Spec	Item	Requirement	Applicable										
47CFR§15.24 7(d), RSS210 (A8.5)	a)	<p>Except higher limit as specified elsewhere in other section, the emissions from the low-power radio-frequency devices shall not exceed the field strength levels specified in the following table and the level of any unwanted emissions shall not exceed the level of the fundamental emission. The tighter limit applies at the band edges</p> <table border="1"> <thead> <tr> <th>Frequency range (MHz)</th> <th>Field Strength (µV/m)</th> </tr> </thead> <tbody> <tr> <td>30 – 88</td> <td>100</td> </tr> <tr> <td>88 – 216</td> <td>150</td> </tr> <tr> <td>216 960</td> <td>200</td> </tr> <tr> <td>Above 960</td> <td>500</td> </tr> </tbody> </table>	Frequency range (MHz)	Field Strength (µV/m)	30 – 88	100	88 – 216	150	216 960	200	Above 960	500	<input checked="" type="checkbox"/>
	Frequency range (MHz)	Field Strength (µV/m)											
	30 – 88	100											
88 – 216	150												
216 960	200												
Above 960	500												
b)	<p>For non-restricted band, In any 100 kHz bandwidth outside the frequency band in which the spread spectrum or digitally modulated intentional radiator is operating, the radio frequency power that is produced by the intentional radiator shall be at least 20 dB or 30dB below that in the 100 kHz bandwidth within the band that contains the highest level of the desired power, determined by the measurement method on output power to be used. Attenuation below the general limits specified in § 15.209(a) is not required</p> <p><input checked="" type="checkbox"/> 20 dB down      <input type="checkbox"/> 30 dB down</p>	<input checked="" type="checkbox"/>											
c)	<p>or restricted band, emission must also comply with the radiated emission limits specified in 15.209</p>	<input checked="" type="checkbox"/>											

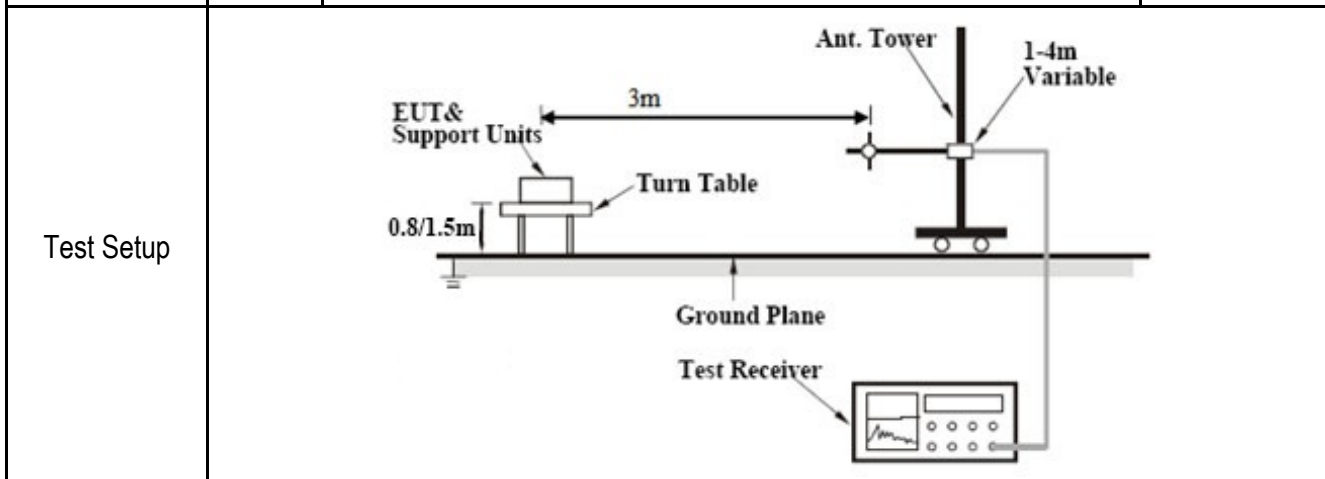

Procedure	<ol style="list-style-type: none"> <li>The EUT was switched on and allowed to warm up to its normal operating condition.</li> <li>The test was carried out at the selected frequency points obtained from the EUT characterization. Maximization of the emissions, was carried out by rotating the EUT, changing the antenna polarization, and adjusting the antenna height in the following manner: <ol style="list-style-type: none"> <li>Vertical or horizontal polarization (whichever gave the higher emission level over a full rotation of the EUT) was chosen.</li> <li>The EUT was then rotated to the direction that gave the maximum emission.</li> <li>Finally, the antenna height was adjusted to the height that gave the maximum emission.</li> </ol> </li> <li>The resolution bandwidth and video bandwidth of test receiver/spectrum analyzer is 120 kHz for Quasi Peak detection at frequency below 1GHz.</li> </ol>
-----------	--

Test Report No.	15021175-FCC-R2
Page	21 of 31



	<p>4. The resolution bandwidth of test receiver/spectrum analyzer is 1MHz and video bandwidth is 3MHz with Peak detection for Peak measurement at frequency above 1GHz. The resolution bandwidth of test receiver/spectrum analyzer is 1MHz and the video bandwidth is 10Hz with Peak detection for Average Measurement as below at frequency above 1GHz.</p> <p>5. Steps 2 and 3 were repeated for the next frequency point, until all selected frequency points were measured.</p>
Remark	Note : The Laptop input power ( 120V/60Hz、 240V/60Hz ) have been tested , but only worst ( 120V/60Hz ) case is the reported.
Result	<input checked="" type="checkbox"/> Pass <input type="checkbox"/> Fail

Test Data  Yes  N/A

Test Plot  Yes (See below)  N/A

Test Mode:	Transmitting BLE Mode
------------	-----------------------

**Below 1GHz**

Peak Detector   
 Quasi Peak Limit 

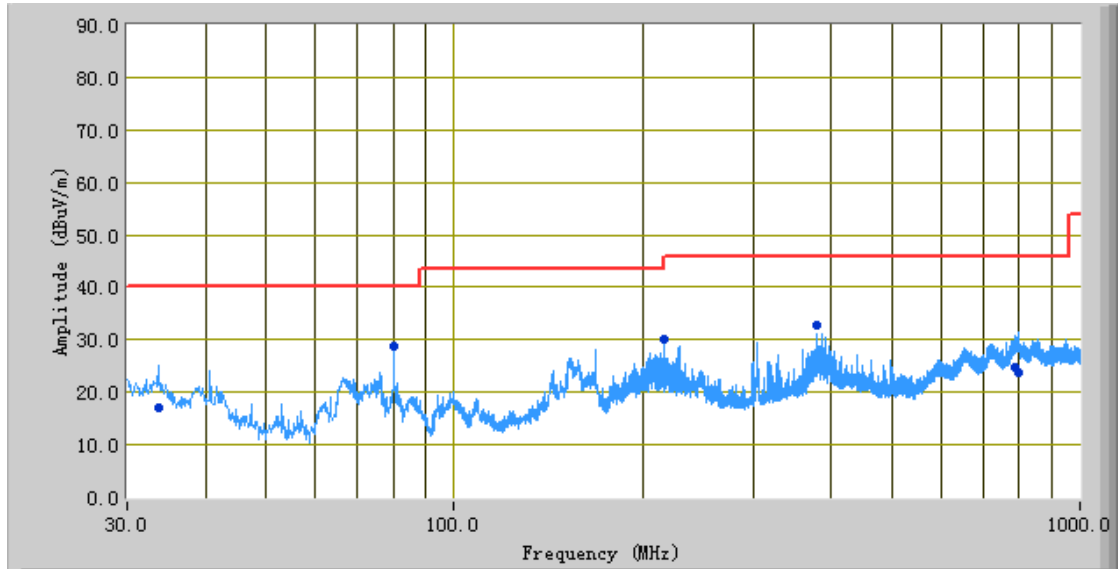

**Test Data**

**Horizontal/Vertical Polarity Plot @3m**

Frequency (MHz)	Quasi Peak (dBuV/m)	Azimuth	Polarity(H/V)	Height (cm)	Factors (dB)	Limit (dBuV/m)	Margin (dB)
79.99	28.74	187.00	H	378.00	-37.07	40.00	-11.26
216.00	30.20	0.00	H	165.00	-31.18	43.50	-13.30
796.34	23.89	149.00	V	224.00	-17.57	46.00	-22.11
33.58	17.06	98.00	V	150.00	-26.04	40.00	-22.94
379.97	32.66	268.00	H	116.00	-28.31	46.00	-13.34
785.53	24.66	159.00	H	193.00	-17.89	46.00	-21.34

<b>Test Mode:</b>	<b>Transmitting BLE Mode</b>
-------------------	------------------------------

**Low Channel (2402 MHz)**

Frequency (MHz)	S.A. Reading (dBμV)	Detector (PK/AV)	Polarity (H/V)	Ant. Factor (dB/m)	Cable Loss (dB)	Pre-Amp. Gain (dB)	Cord. Amp. (dBμV/m)	Limit (dBμV/m)	Margin (dB)
4804	34.43	AV	V	33.83	6.86	31.72	43.4	54	-10.6
4804	33.94	AV	H	33.83	6.86	31.72	42.91	54	-11.09
4804	45.65	PK	V	33.83	6.86	31.72	54.62	74	-19.38
4804	44.66	PK	H	33.83	6.86	31.72	53.63	74	-20.37

**Middle Channel (2440 MHz)**

Frequency (MHz)	S.A. Reading (dBμV)	Detector (PK/AV)	Polarity (H/V)	Ant. Factor (dB/m)	Cable Loss (dB)	Pre-Amp. Gain (dB)	Cord. Amp. (dBμV/m)	Limit (dBμV/m)	Margin (dB)
4880	34.73	AV	V	33.86	6.82	31.82	43.59	54	-10.41
4880	33.97	AV	H	33.86	6.82	31.82	42.83	54	-11.17
4880	46.46	PK	V	33.86	6.82	31.82	55.32	74	-18.68
4880	45.76	PK	H	33.86	6.82	31.82	54.62	74	-19.38

**High Channel (2480 MHz)**

Frequency (MHz)	S.A. Reading (dBμV)	Detector (PK/AV)	Polarity (H/V)	Ant. Factor (dB/m)	Cable Loss (dB)	Pre-Amp. Gain (dB)	Cord. Amp. (dBμV/m)	Limit (dBμV/m)	Margin (dB)
4960	34.75	AV	V	33.9	6.76	31.92	43.49	54	-10.51
4960	34.08	AV	H	33.9	6.76	31.92	42.82	54	-11.18
4960	46.46	PK	V	33.9	6.76	31.92	55.2	74	-18.8
4960	45.73	PK	H	33.9	6.76	31.92	54.47	74	-19.53

## Annex A. TEST INSTRUMENT

Instrument	Model	Serial #	Cal Date	Cal Due	In use
<b>AC Line Conducted Emissions</b>					
EMI test receiver	ESCS30	8471241027	09/18/2015	09/17/2016	<input checked="" type="checkbox"/>
Line Impedance Stabilization Network	LI-125A	191106	09/26/2015	09/25/2016	<input checked="" type="checkbox"/>
Line Impedance Stabilization Network	LI-125A	191107	09/26/2015	09/25/2016	<input checked="" type="checkbox"/>
LISN	ISN T800	34373	09/26/2015	09/25/2016	<input checked="" type="checkbox"/>
Double Ridge Horn Antenna (1 ~18GHz)	AH-118	71283	09/25/2015	09/24/2016	<input checked="" type="checkbox"/>
Transient Limiter	LIT-153	531118	09/02/2015	09/01/2016	<input checked="" type="checkbox"/>
<b>RF conducted test</b>					
Agilent ESA-E SERIES SPECTRUM ANALYZER	E4407B	MY45108319	09/18/2015	09/17/2016	<input checked="" type="checkbox"/>
Power Splitter	1#	1#	09/02/2015	09/01/2016	<input checked="" type="checkbox"/>
DC Power Supply	E3640A	MY40004013	09/18/2015	09/17/2016	<input checked="" type="checkbox"/>
<b>Radiated Emissions</b>					
EMI test receiver	ESL6	100262	09/18/2015	09/17/2016	<input checked="" type="checkbox"/>
Positioning Controller	UC3000	MF780208282	11/15/2015	11/14/2016	<input checked="" type="checkbox"/>
OPT 010 AMPLIFIER (0.1-1300MHz)	8447E	2727A02430	09/02/2015	09/01/2016	<input checked="" type="checkbox"/>
Microwave Preamplifier (1 ~ 26.5GHz)	8449B	3008A02402	03/25/2015	03/24/2016	<input checked="" type="checkbox"/>
Bilog Antenna (30MHz~6GHz)	JB6	A110712	09/22/2015	09/21/2016	<input checked="" type="checkbox"/>
Double Ridge Horn Antenna (1 ~18GHz)	AH-118	71283	09/25/2015	09/24/2016	<input checked="" type="checkbox"/>
Universal Radio Communication Tester	CMU200	121393	09/26/2015	09/25/2016	<input checked="" type="checkbox"/>



## Annex B. EUT And Test Setup Photographs

### Annex B.i. Photograph: EUT External/Internal Photo

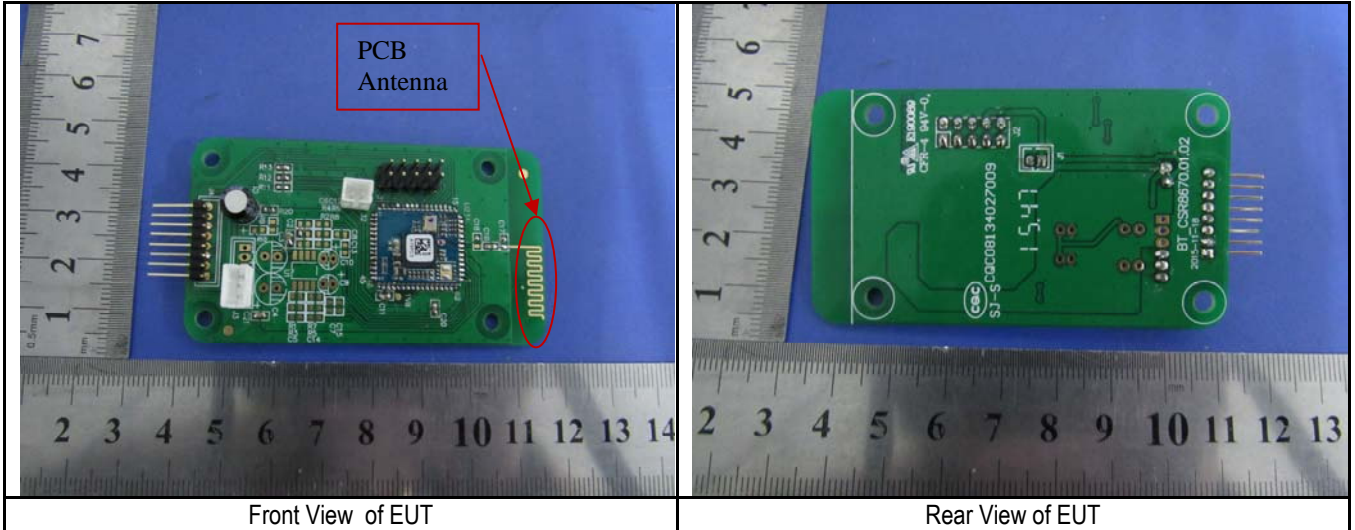

**Annex B.iii. Photograph: Test Setup Photo**



Conducted Emissions Test Setup Front View



Conducted Emissions Test Setup Side View

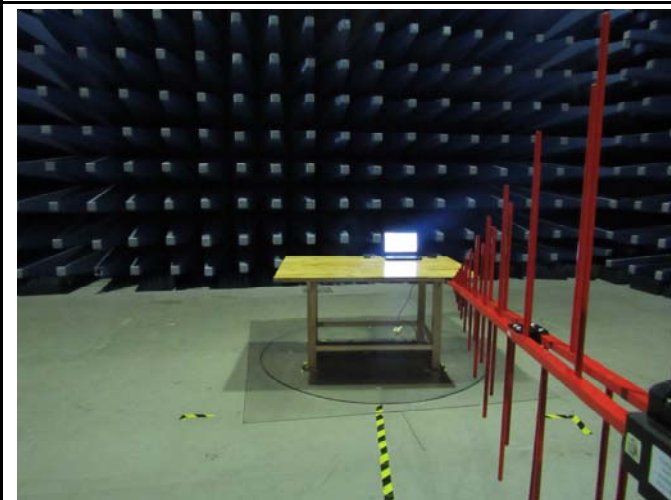

Radiated Spurious Emissions Test Setup Below 1GHz



Radiated Spurious Emissions Test Setup Above 1GHz

## Annex C. TEST SETUP AND SUPPORTING EQUIPMENT

### Annex C.ii. TEST SET UP BLOCK

#### Block Configuration Diagram for Conducted Emissions

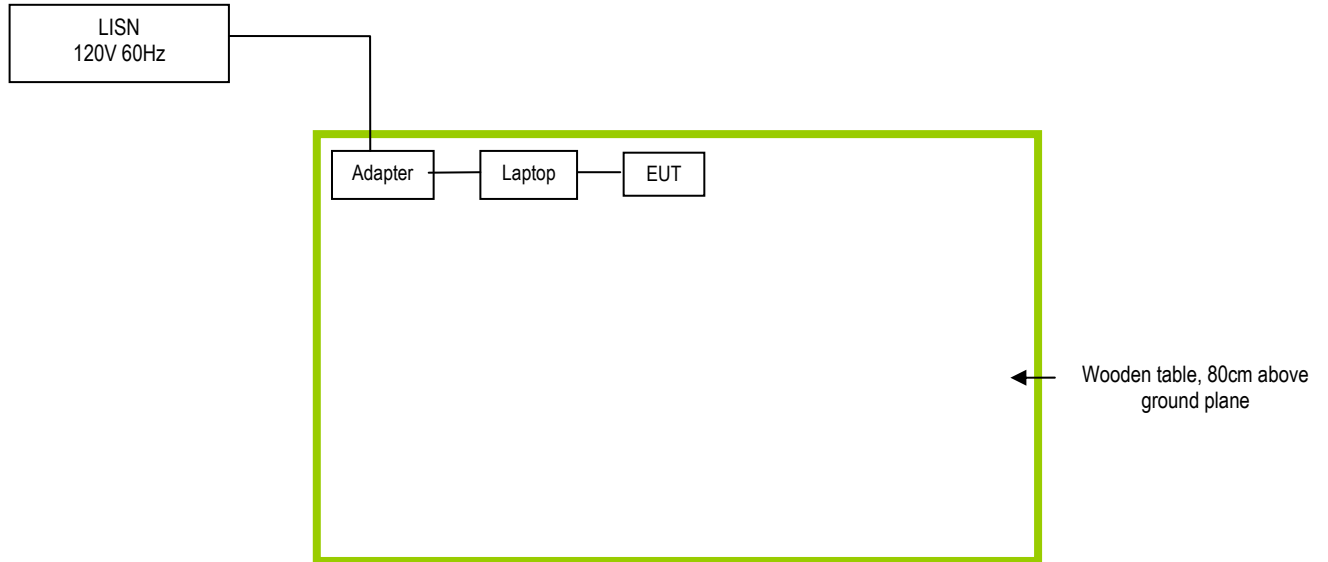

### Block Configuration Diagram for Radiated Emission

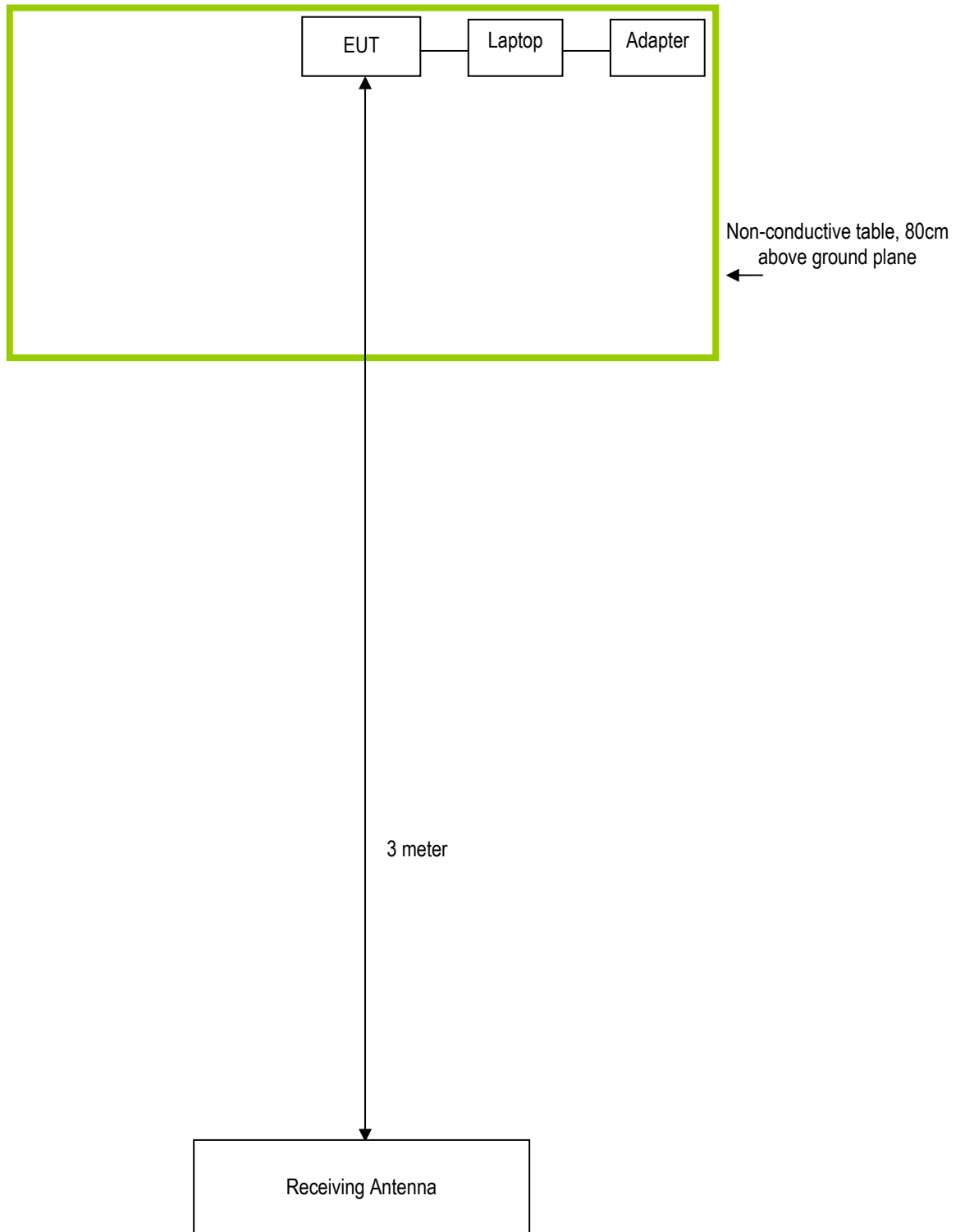

Test Report No.	15021175-FCC-R2
Page	29 of 31

**Annex C. ii. SUPPORTING EQUIPMENT DESCRIPTION**

The following is a description of supporting equipment and details of cables used with the EUT.

Manufacturer	Equipment Description	Model	Calibration Date	Calibration Due Date
Dell Inc	Laptop	DCSM	N/A	N/A

Test Report No.	15021175-FCC-R2
Page	30 of 31

**Annex D. User Manual / Block Diagram / Schematics / Partlist**

Please see attachment

Test Report No.	15021175-FCC-R2
Page	31 of 31

**Annex E. DECLARATION OF SIMILARITY**

N/A