

# Ringway Tech(Jiangsu) Co.,Ltd.

## DIGITAL PIANO

Main Model: MP8820

Serial Model: N/A

May 29, 2013



Report No.: 13020055-FCC-E1

(This report supersedes NONE)



Modifications made to the product : None

This Test Report is Issued Under the Authority of:

		
Alan Lv Compliance Engineer	Alex Liu Technical Manager	

This test report may be reproduced in full only.  
Test result presented in this test report is applicable to the representative sample only.

# EMC Test Report

To: FCC Part 15 Subpart B Class B: 2012, ANSI C63.4: 2009

SIEMIC, INC.  
Accessing global markets



## Laboratory Introduction

SIEMIC, headquartered in the heart of Silicon Valley, with superior facilities in US and Asia, is one of the leading independent testing and certification facilities providing customers with one-stop shop services for Compliance Testing and Global Certifications.



In addition to [testing](#) and [certification](#), SIEMIC provides initial design reviews and [compliance management](#) through out a project. Our extensive experience with [China](#), [Asia Pacific](#), [North America](#), [European](#), and [international](#) compliance requirements, assures the fastest, most cost effective way to attain regulatory compliance for the [global markets](#).

### Accreditations for Conformity Assessment

Country/Region	Accreditation Body	Scope
USA	FCC, A2LA	EMC , RF/Wireless , Telecom
Canada	IC, A2LA, NIST	EMC, RF/Wireless , Telecom
Taiwan	BSMI , NCC , NIST	EMC, RF, Telecom , Safety
Hong Kong	OFTA , NIST	RF/Wireless ,Telecom
Australia	NATA, NIST	EMC, RF, Telecom , Safety
Korea	KCC/RRA, NIST	EMI, EMS, RF , Telecom, Safety
Japan	VCCI, JATE, TELEC, RFT	EMI, RF/Wireless, Telecom
Mexico	NOM, COFETEL, Caniety	Safety, EMC , RF/Wireless, Telecom
Europe	A2LA, NIST	EMC, RF, Telecom , Safety

### Accreditations for Product Certifications

Country/Region	Accreditation Body	Scope
USA	FCC TCB, NIST	EMC , RF , Telecom
Canada	IC FCB , NIST	EMC , RF , Telecom
Singapore	iDA, NIST	EMC , RF , Telecom
EU	NB	EMC & R&TTE Directive
Japan	MIC, (RCB 208)	RF , Telecom
Hong Kong	OFTA (US002)	RF , Telecom



**SIEMIC, INC.**

Accessing global markets

Title: EMC Test Report for DIGITAL PIANO  
Main Model: MP8820  
Serial Model: N/A  
To: FCC Part 15 Subpart B Class B: 2012, ANSI C63.4: 2009

Report No: 13020055-FCC-E1  
Issue Date: May 29, 2013  
Page: 3 of 31  
[www.siemic.com](http://www.siemic.com)

---

This page has been left blank intentionally.

# CONTENTS

<b>1</b>	<b>EXECUTIVE SUMMARY &amp; EUT INFORMATION .....</b>	<b>5</b>
<b>2</b>	<b>TECHNICAL DETAILS .....</b>	<b>6</b>
<b>3</b>	<b>MODIFICATION.....</b>	<b>7</b>
<b>4</b>	<b>TEST SUMMARY.....</b>	<b>8</b>
<b>5</b>	<b>MEASUREMENTS, EXAMINATION AND DERIVED RESULTS .....</b>	<b>9</b>
	<b>ANNEX A. TEST INSTRUMENT &amp; METHOD .....</b>	<b>14</b>
	<b>ANNEX B. EUT AND TEST SETUP PHOTOGRAPHS .....</b>	<b>18</b>
	<b>ANNEX C. TEST SETUP AND SUPPORTING EQUIPMENT.....</b>	<b>26</b>
	<b>ANNEX D. USER MANUAL / BLOCK DIAGRAM / SCHEMATICS / PART LIST .....</b>	<b>30</b>
	<b>ANNEX E. DECLARATION OF SIMILARITY .....</b>	<b>31</b>

# **1 EXECUTIVE SUMMARY & EUT INFORMATION**

The purpose of this test programme was to demonstrate compliance of the Ringway Tech(Jiangsu) Co.,Ltd., DIGITAL PIANO and model: MP8820 against the current Stipulated Standards. The DIGITAL PIANO has demonstrated compliance with the FCC Part 15 Subpart B Class B: 2012, ANSI C63.4: 2009.

## **EUT Information**

**EUT Description** : **DIGITAL PIANO**

**Main Model** : **MP8820**

**Serial Model** : **N/A**

**Input Power** : **Adapter**  
**Model: OH-1028A1202500U-UL**  
**Input: 100-240V 50/60Hz 800mA Max**  
**Output: 12V 2.5A**

**Classification Per Stipulated Test Standard** : **Class B Emission Product Per**  
**FCC Part 15 Subpart B Class B: 2012**

## 2 TECHNICAL DETAILS

<b>Purpose</b>	<b>Compliance testing of DIGITAL PIANO with stipulated standard</b>
<b>Applicant / Client</b>	<b>Ringway Tech(Jiangsu) Co.,Ltd. No. 101 West Hanjiang Road, Changzhou, Jiangsu, China</b>
<b>Manufacturer</b>	<b>Ringway Tech(Jiangsu) Co.,Ltd. No. 101 West Hanjiang Road, Changzhou, Jiangsu, China</b>
<b>Laboratory performing the tests</b>	<b>SIEMIC Nanjing (China) Laboratories NO.2-1, Longcang Dadao, Yuhua Economic Development Zone, Nanjing, China Tel:+86(25)86730128/86730129 Fax:+86(25)86730127 Email:info@siemic.com</b>
<b>Test report reference number</b>	<b>13020055-FCC-E1</b>
<b>Date EUT received</b>	<b>January 18, 2013</b>
<b>Standard applied</b>	<b>FCC Part 15 Subpart B Class B: 2012, ANSI C63.4: 2009</b>
<b>Dates of test</b>	<b>May 09, 2013 to May 28, 2013</b>
<b>No of Units</b>	<b>#1</b>
<b>Equipment Category</b>	<b>Class B Emission Product</b>
<b>Trade Name</b>	<b>N/A</b>
<b>Highest Operated Frequency (ies)</b>	<b>N/A</b>
<b>Port/Connectors</b>	<b>Power Port</b>
<b>FCC ID</b>	<b>OCDMP8820</b>



**SIEMIC, Inc.**

Accessing global markets

Title: EMC Test Report for DIGITAL PIANO  
Main Model: MP8820  
Serial Model: N/A  
To: FCC Part 15 Subpart B Class B: 2012, ANSI C63.4: 2009

Report No: 13020055-FCC-E1  
Issue Date: May 29, 2013  
Page: 7 of 31  
[www.siemic.com](http://www.siemic.com)

## **3 MODIFICATION**

**NONE**

## **4 TEST SUMMARY**

The product was tested in accordance with the following specifications.  
 All testing has been performed according to below product classification:

### **Class B Emission Product**

#### **Test Results Summary**

Emissions			
Test Standard	Description	Product Class	Pass / Fail
FCC Part 15 Subpart B Class B: 2012, ANSI C63.4: 2009	Conducted Emissions	See Above	Pass
FCC Part 15 Subpart B Class B: 2012, ANSI C63.4: 2009	Radiated Emissions	See Above	Pass

All measurement uncertainty is not taken into consideration for all presented test result.



# 5 MEASUREMENTS, EXAMINATION AND DERIVED RESULTS

## 5.1 Conducted Emissions Test Result

*Note:*

1. All possible modes of operation were investigated. Only the 6 worst case emissions measured, using the correct CISPR and Average detectors, are reported. All other emissions were relatively insignificant.
2. A "-ve" margin indicates a PASS as it refers to the margin present below the limit line at the particular frequency.
3. Conducted Emissions Measurement Uncertainty  
All test measurements carried out are traceable to national standards. The uncertainty of the measurement at a confidence level of approximately 95% (in the case where distributions are normal), with a coverage factor of 2, in the range 9kHz – 30MHz (Average & Quasi-peak) is  $\pm 3.86\text{dB}$ .
4. Environmental Conditions  
Temperature 16°C  
Relative Humidity 50%  
Atmospheric Pressure 1009 mbar
5. Test date : May 09, 2013  
Tested By : Alan Lv

**Test Result: Pass**

<b>Test Mode:</b>	<b>Normal Working</b>
-------------------	-----------------------

**Peak Detector**     **Quasi Peak Limit**      
**Average Detector**     **Average Limit**    

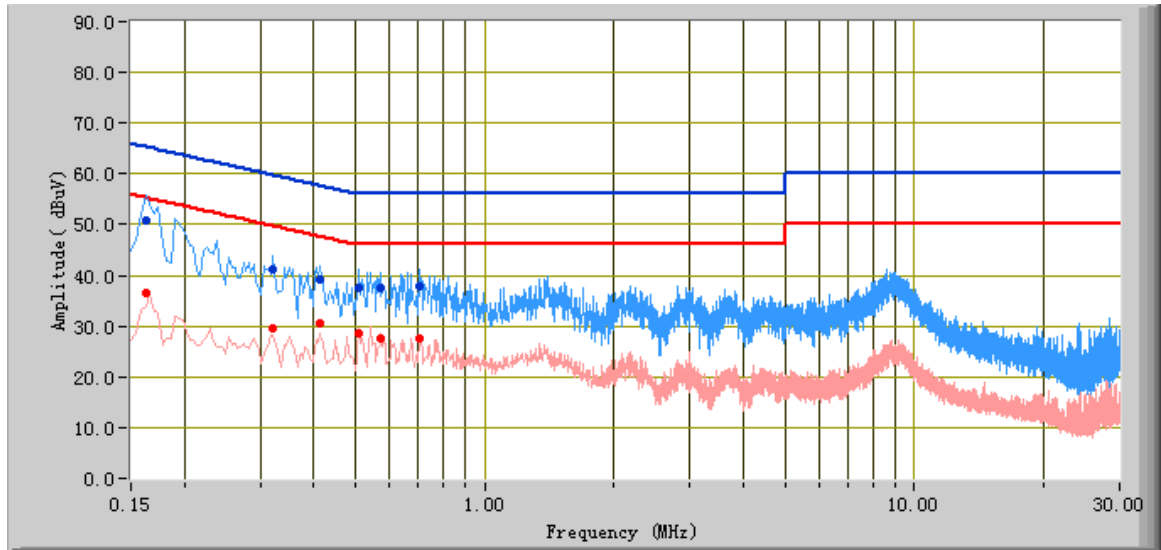

**Test Data**

**Phase Line Plot at 120V AC, 60Hz**

Frequency (MHz)	Quasi Peak (dBµV)	Limit (dBµV)	Margin (dB)	Average (dBµV)	Limit (dBµV)	Margin (dB)
0.16	50.97	65.36	-14.40	36.52	55.36	-18.84
0.51	37.50	56.00	-18.50	28.51	46.00	-17.49
0.70	37.88	56.00	-18.12	27.47	46.00	-18.53
0.57	37.49	56.00	-18.51	27.68	46.00	-18.32
0.32	41.15	59.66	-18.50	29.60	49.66	-20.05
0.41	39.31	57.57	-18.26	30.48	47.57	-17.09

<b>Test Mode:</b>	<b>Normal Working</b>
-------------------	-----------------------

**Peak Detector**     **Quasi Peak Limit**      
**Average Detector**     **Average Limit**    

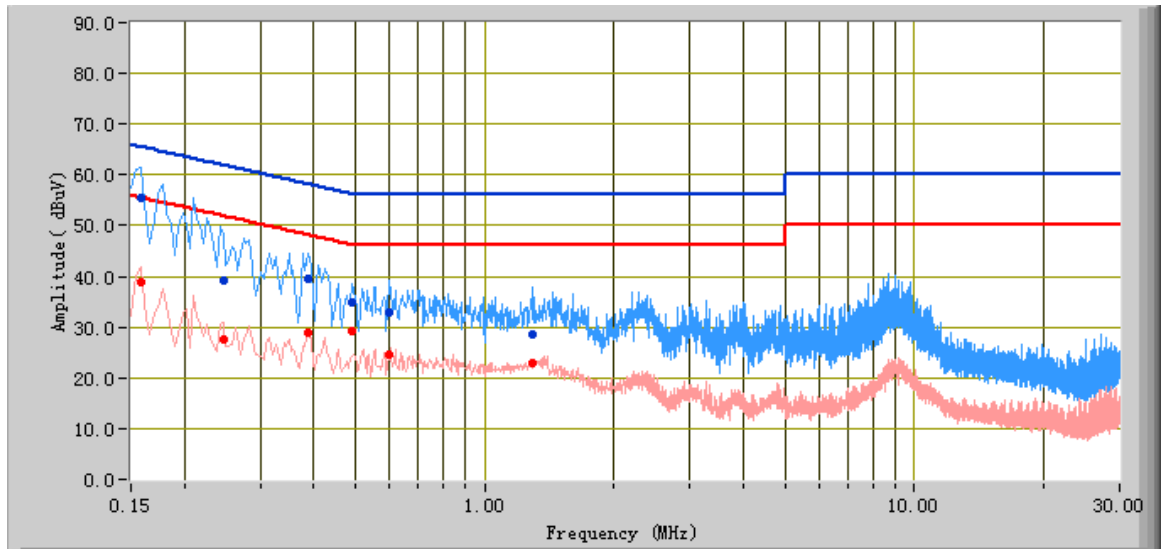

**Test Data**



**Phase Neutral Plot at 120V AC, 60Hz**

Frequency (MHz)	Quasi Peak (dBµV)	Limit (dBµV)	Margin (dB)	Average (dBµV)	Limit (dBµV)	Margin (dB)
0.16	55.46	65.57	-10.10	39.00	55.57	-16.56
0.25	39.11	61.89	-22.78	27.72	51.89	-24.17
0.39	39.63	58.15	-18.52	28.81	48.15	-19.34
0.60	32.80	56.00	-23.20	24.72	46.00	-21.28
0.49	34.85	56.17	-21.32	29.28	46.17	-16.88
1.29	28.54	56.00	-27.46	22.88	46.00	-23.12



<b>Test Mode:</b>	<b>Normal Working</b>
-------------------	-----------------------

**Below 1GHz**

Peak Detector   
 Quasi Peak Limit 

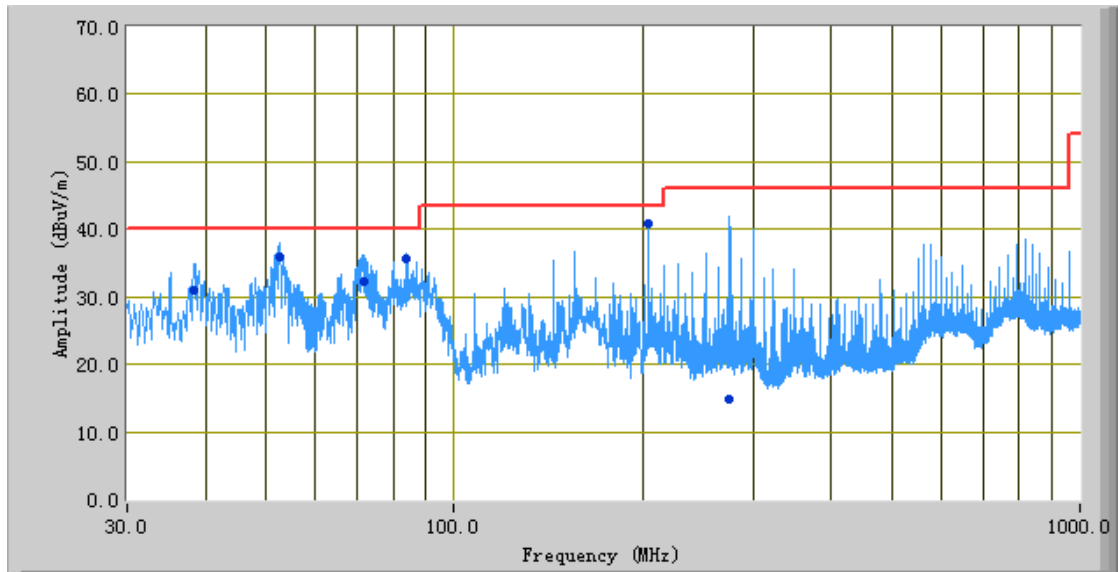

**Test Data**

**Vertical and Horizontal Polarity Plot at 3m**

Frequency (MHz)	Quasi Peak (dBµV/m)	Azimuth	Polarity(H/V)	Height (cm)	Factors (dB)	Limit (dBµV/m)	Margin (dB)
52.55	35.83	88.00	V	113.00	-34.42	40.00	-4.17
204.01	40.86	144.00	H	164.00	-33.27	43.50	-2.64
84.02	35.75	66.00	V	109.00	-37.96	40.00	-4.25
72.00	32.34	355.00	H	363.00	-37.85	40.00	-7.66
275.40	14.90	282.00	V	246.00	-30.71	46.00	-31.10
38.43	31.06	82.00	V	103.00	-26.73	40.00	-8.94

*Note: The highest frequency of the internal sources of the EUT is less than 108MHz, so the measurement shall only be made up to 1GHz.*

**Annex A. TEST INSTRUMENT & METHOD**

**Annex A.i. TEST INSTRUMENTATION & GENERAL PROCEDURES**

Instrument	Model	Serial #	Calibration Date	Calibration Due Date
<b>AC Line Conducted Emissions</b>				
R&S EMI Test Receiver	ESPI3	101216	10/27/2012	10/26/2013
V-LISN	ESH3-Z5	838979/005	10/27/2012	10/26/2013
Com-Power Transient Limiter	LIT-153	531021	11/03/2012	11/02/2013
SIEMIC Labview Conducted Emissions software V1.0	N/A	N/A	N/A	N/A
<b>Radiated Emissions</b>				
R&S EMI Receiver	ESPI3	101216	10/27/2012	10/26/2013
Antenna (30MHz~6GHz)	JB6	A121411	03/27/2013	03/26/2014
Hp Agilent Pre-Amplifier	8447F	1937A01160	11/03/2012	11/02/2013
Chamber	3m	N/A	04/13/2013	04/12/2014
SIEMIC Labview Radiated Emissions software V1.0	N/A	N/A	N/A	N/A

**Annex A.ii. CONDUCTED EMISSIONS TEST DESCRIPTION**

**Test Set-up**

1. The EUT and supporting equipment were set up in accordance with the requirements of the standard on top of a 1.5m x 1m x 0.8m high, non-metallic table, as shown in Annex B.
2. The power supply for the EUT was fed through a 50Ω/50μH EUT LISN, connected to filtered mains.
3. The RF OUT of the EUT LISN was connected to the EMI test receiver via a low-loss coaxial cable.
4. All other supporting equipments were powered separately from another main supply.

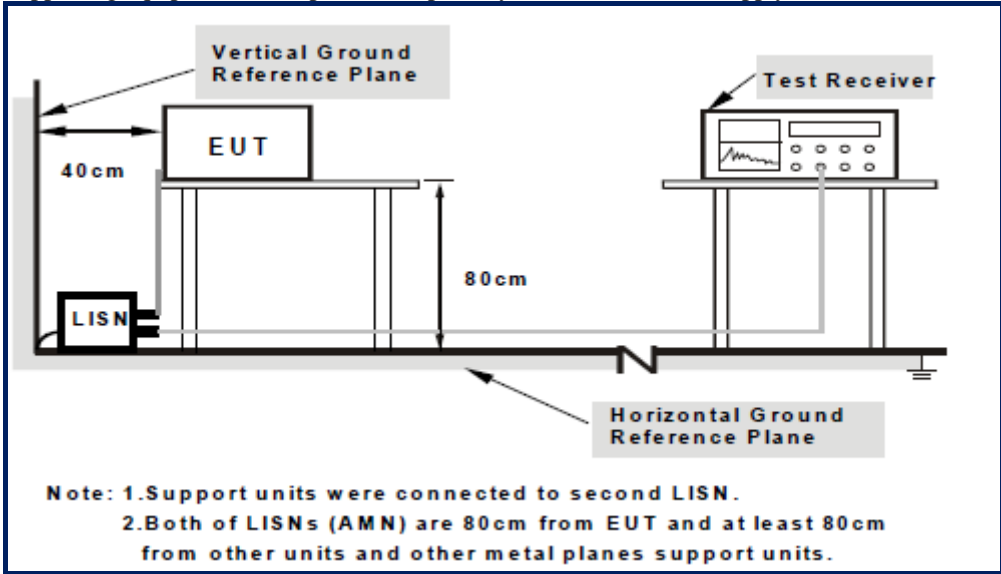

For the actual test configuration, please refer to the related item – Photographs of the Test Configuration1

**Test Method**

1. The EUT was switched on and allowed to warm up to its normal operating condition.
2. A scan was made on the NEUTRAL line (for AC mains) or Earth line (for DC power) over the required frequency range using an EMI test receiver.
3. High peaks, relative to the limit line, were then selected.
4. The EMI test receiver was then tuned to the selected frequencies and the necessary measurements made with a receiver bandwidth setting of 10kHz. For FCC tests, only Quasi-peak measurements were made; while for CISPR/EN tests, both Quasi-peak and Average measurements were made.
5. Steps 2 to 4 were then repeated for the LIVE line (for AC mains) or DC line (for DC power).

**Sample Calculation Example**

At 20MHz	limit = 250μV = 47.96dBμV
Transducer factor of LISN, pulse limiter & cable loss at 20MHz = 11.20dB	
Q-P reading obtained directly from EMI Receiver = 40.00dBμV (Calibrated for system losses)	
Therefore, Q-P margin = 40.00-47.96 = -7.96	i.e. <b>7.96 dB below limit</b>

**Annex A.iii. RADIATED EMISSIONS TEST DESCRIPTION**

**EUT Characterisation**

EUT characterisation, over the frequency range from 30MHz to 10<sup>th</sup> Harmonic, was done in order to minimise radiated emissions testing time while still maintaining high confidence in the test results.

The EUT was placed in the chamber, at a height of about 0.8 m on a turntable. Its radiated emissions frequency profile was observed, using a spectrum analyzer /receiver with the appropriate broadband antenna placed 3m away from the EUT. Radiated emissions from the EUT were maximised by rotating the turntable manually, changing the antenna polarisation and manipulating the EUT cables while observing the frequency profile on the spectrum analyzer / receiver. Frequency points at which maximum emissions occurred; clock frequencies and operating frequencies were then noted for the formal radiated emissions test at the Open Area Test Site (OATS) or 3m EMC chamber.

**Test Set-up**

1. The EUT and supporting equipment were set up in accordance with the requirements of the standard on top of a 1.5mX1.0mX0.8m high, non-metallic table.
2. The filtered power supply for the EUT and supporting equipment were tapped from the appropriate power sockets located on the turntable.
3. The relevant broadband antenna was set at the required test distance away from the EUT and supporting equipment boundary.

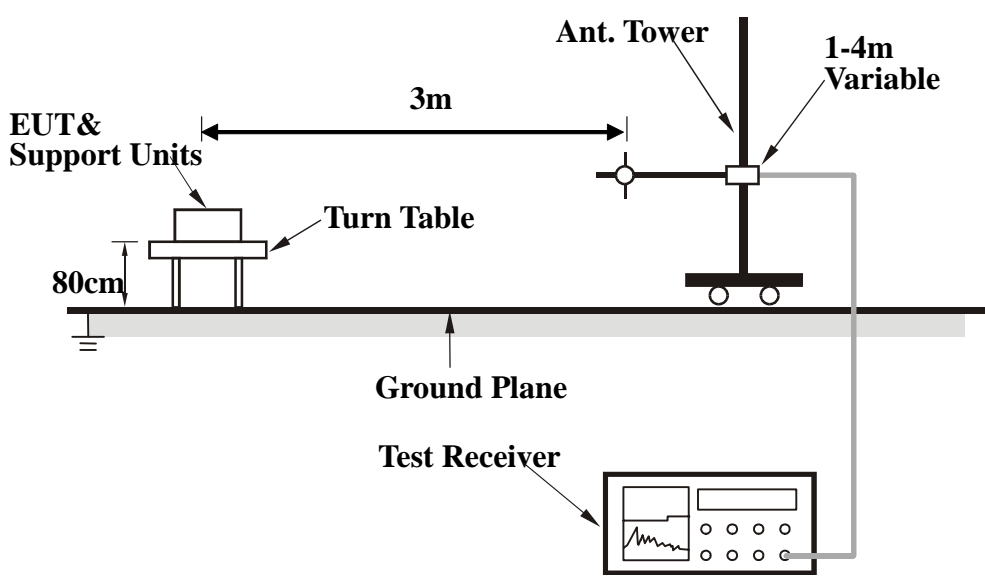

For the actual test configuration, please refer to the related item – Photographs of the Test Configuration2



**Test Method**

The following procedure was performed to determine the maximum emission axis of EUT:

1. With the receiving antenna is H polarization, rotate the EUT in turns with three orthogonal axes to determine the axis of maximum emission.
2. With the receiving antenna is V polarization, rotate the EUT in turns with three orthogonal axes to determine the axis of maximum emission.
3. Compare the results derived from above two steps. So, the axis of maximum emission from EUT was determined and the configuration was used to perform the final measurement.

**Final Radiated Emission Measurement**

1. Setup the configuration according to figure 1. Turn on EUT and make sure that it is in normal function.
2. For emission frequencies measured below 1GHz, a pre-scan is performed in a shielded chamber to determine the accurate frequencies of higher emissions will be checked on an open test site. As the same purpose, for emission frequencies measured above 1GHz, a pre-scan also be performed with a 1 meter measuring distance before final test.
3. For emission frequencies measured below and above 1GHz, set the spectrum analyzer on a 100kHz and 1MHz resolution bandwidth respectively for each frequency measured in step 2.
4. The search antenna is to be raised and lowered over a range from 1 to 4 meters in horizontally polarized orientation. Position the highness when the highest value is indicated on spectrum analyzer, then change the orientation of EUT on test table over a range from 0° to 360° with a speed as slow as possible, and keep the azimuth that highest emission is indicated on the spectrum analyzer. Vary the antenna position again and record the highest value as a final reading.
5. Repeat step 4 until all frequencies need to be measured was complete.
6. Repeat step 5 with search antenna in vertical polarized orientations.

During the radiated emission test, the Spectrum Analyzer was set with the following configurations:

Frequency Band (MHz)	Function	Resolution bandwidth	Video Bandwidth
30 to 1000	Peak	100kHz	100kHz
Above 1000	Peak	1MHz	1MHz
	Average	1MHz	10Hz

**Sample Calculation Example**

The field strength is calculated by adding the Antenna Factor and Cable Factor, and subtracting the Amplifier Gain (if any) from the measured reading. For the limit is employed average value, therefore the peak value can be transferred to average value by subtracting the duty factor. The basic equation with a sample calculation is as follows:

$$\text{Peak} = \text{Reading} + \text{Corrected Factor}$$

where

$$\text{Corr. Factor} = \text{Antenna Factor} + \text{Cable Factor} - \text{Amplifier Gain (if any)}$$

And the average value is

$$\text{Average} = \text{Peak Value} + \text{Duty Factor or}$$

$$\text{Set RBW} = 1\text{MHz, VBW} = 10\text{Hz.}$$

Note:

If the measured frequencies are fall in the restricted frequency band, the limit employed must be quasi peak value when frequencies are below or equal to 1GHz. And the measuring instrument is set to quasi peak detector function.

**Annex B. EUT AND TEST SETUP PHOTOGRAPHS**

**Annex B.i. Photograph 1: EUT External Photo**



EUT-Top View



EUT-Rear View



**SIEMIC, INC.**

Accessing global markets

Title: EMC Test Report for DIGITAL PIANO  
Main Model: MP8820  
Serial Model: N/A  
To: FCC Part 15 Subpart B Class B: 2012, ANSI C63.4: 2009

Report No: 13020055-FCC-E1  
Issue Date: May 29, 2013  
Page: 19 of 31  
www.siemic.com



EUT-Front View



EUT-Left View



EUT-Right View



Adapter View

**Annex B.ii. Photograph 2: EUT Internal Photo**



EUT-Uncovered View

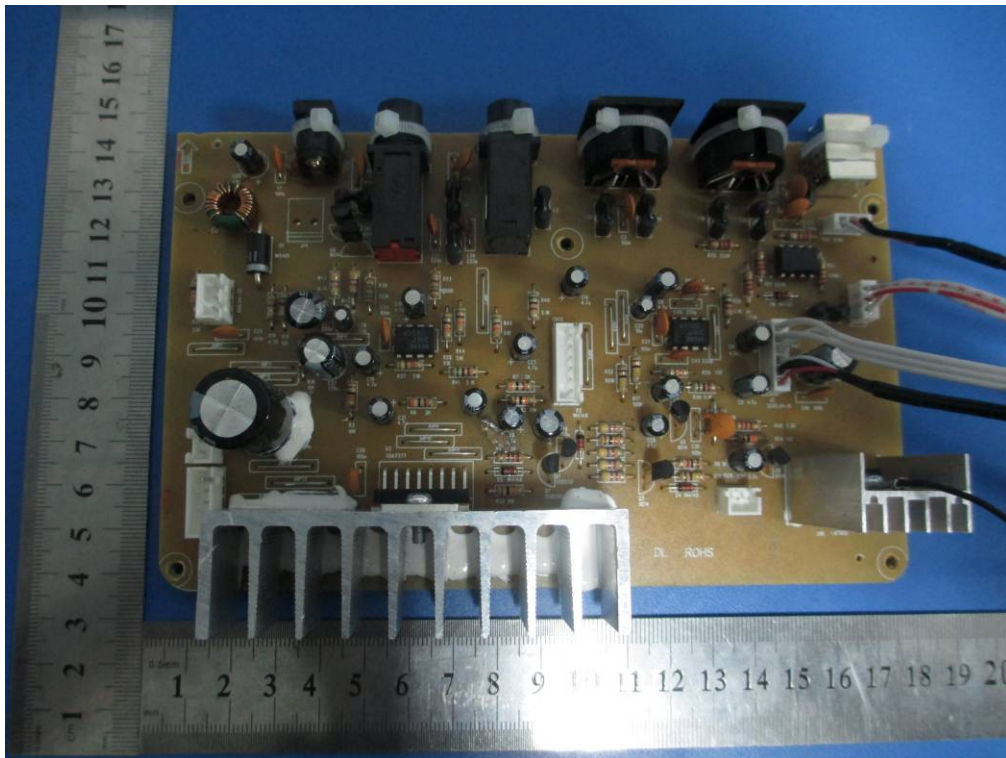

EUT-Front View of Main PCB 1

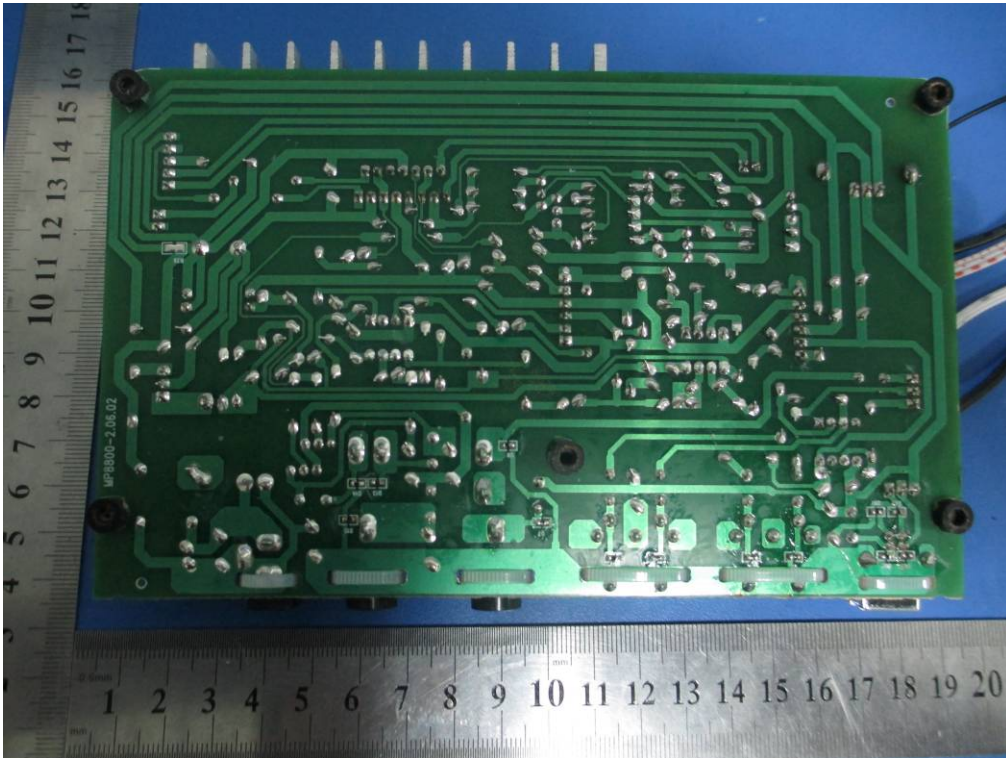

EUT-Rear View of Main PCB 1

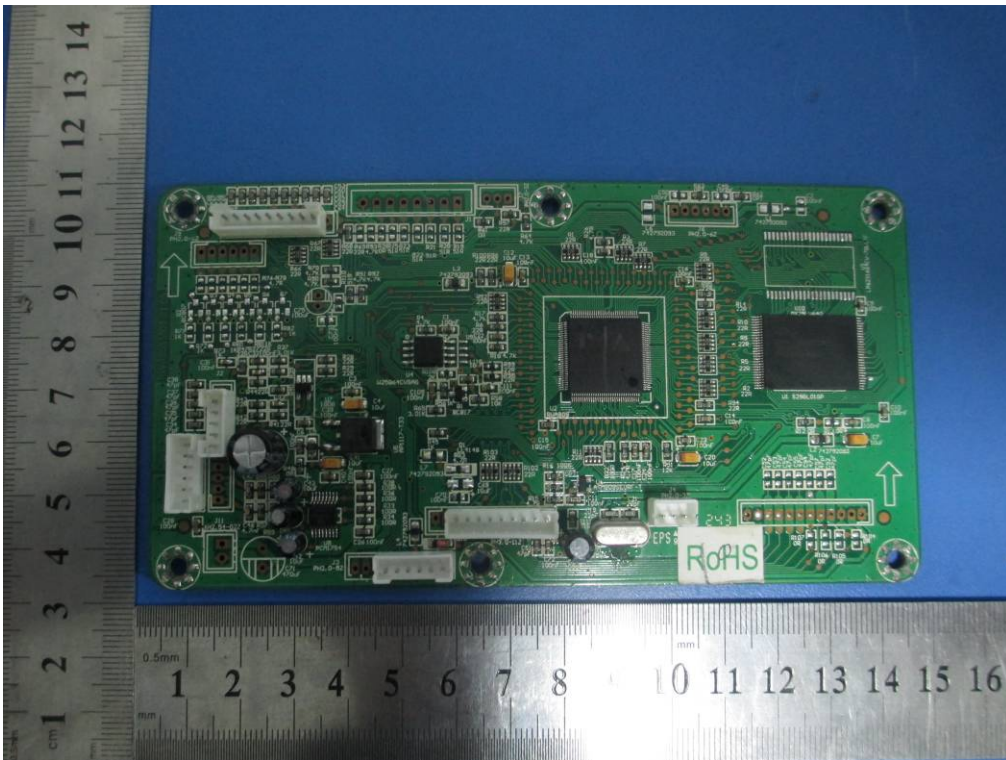

EUT-Front View of Main PCB 2

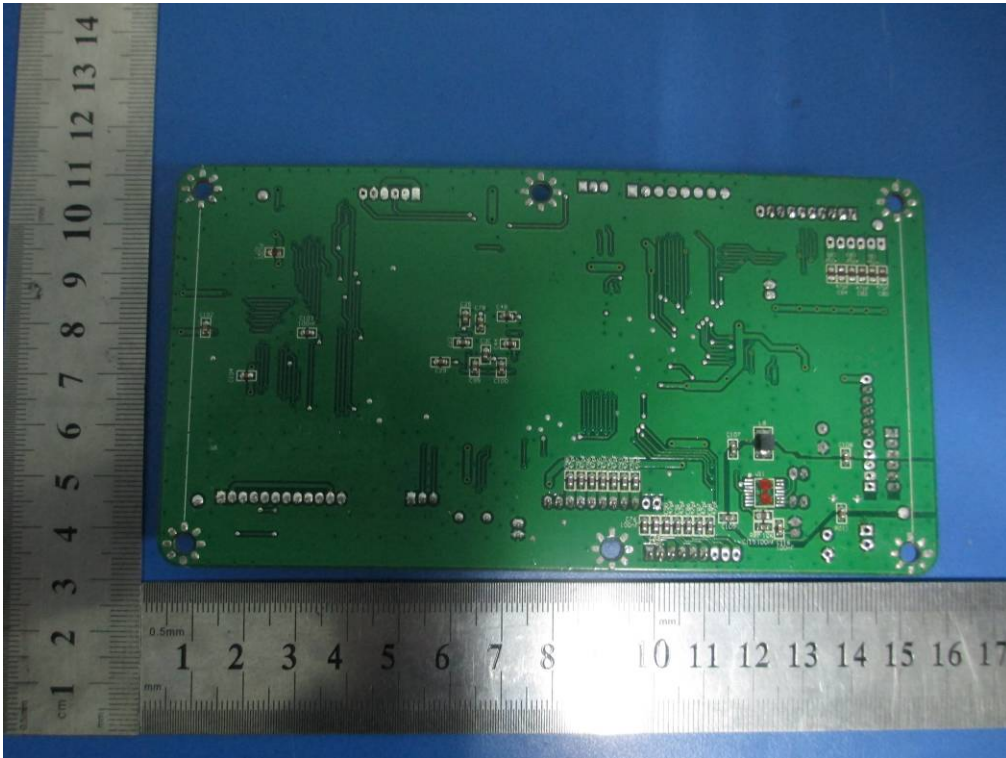

EUT-Rear View of Main PCB 2

**Annex B.iii. Photograph 3: Test Setup Photo**



Conducted Emissions Setup Front View



Conducted Emissions Setup Side View



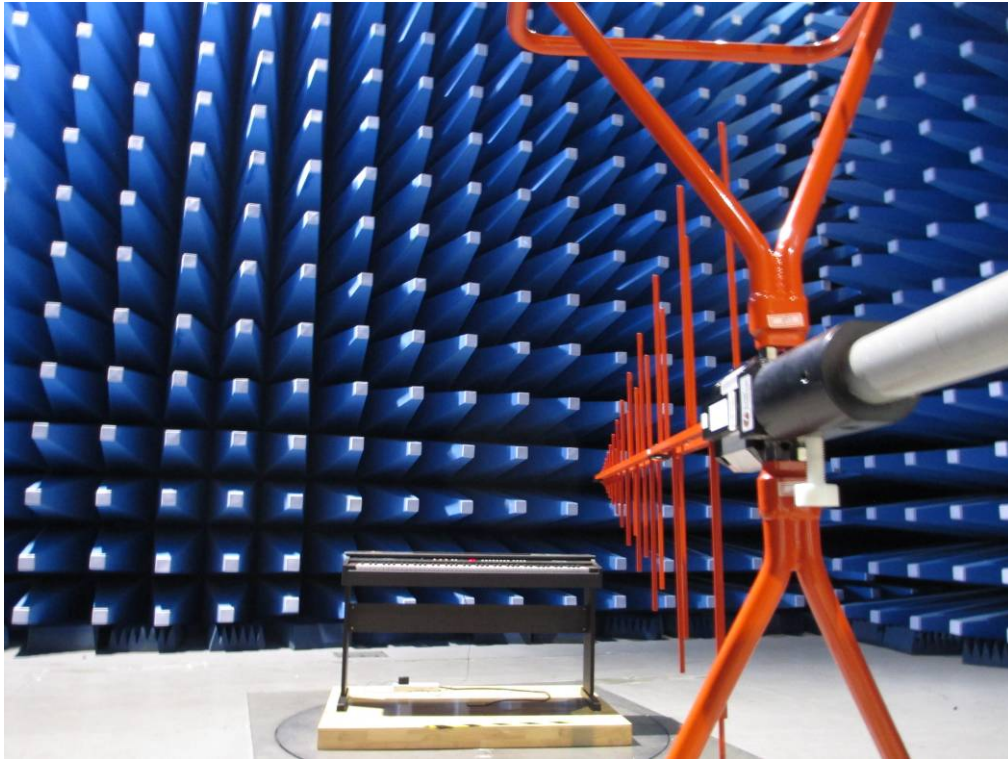

Radiated Emissions Setup Front View

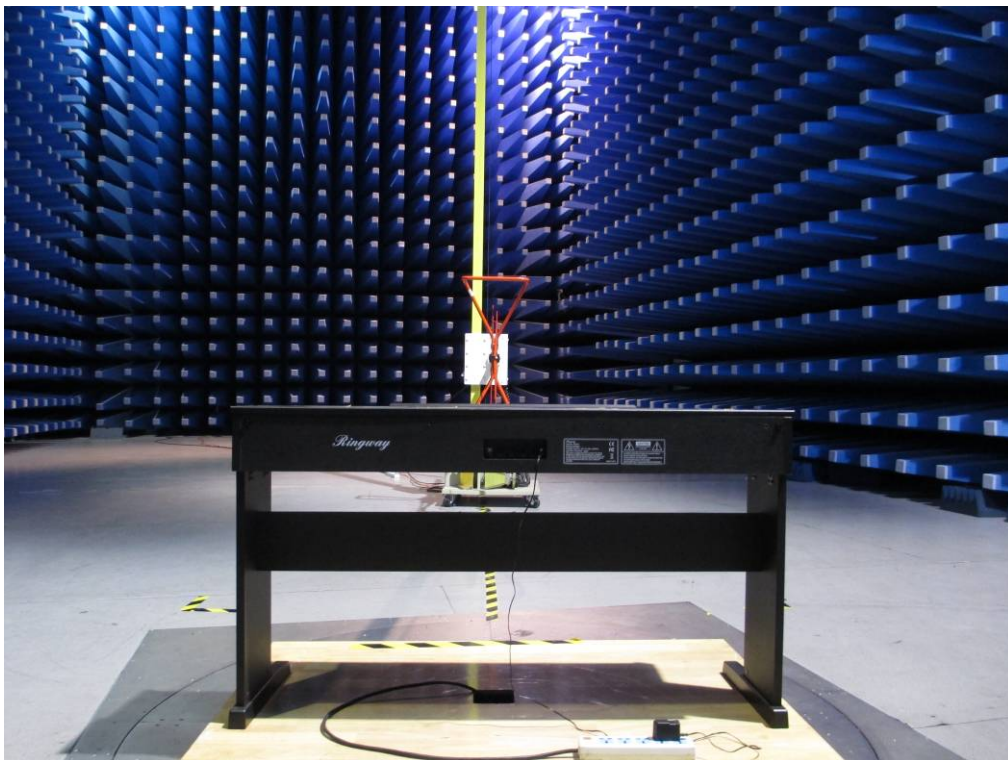

Radiated Emissions Setup Rear View

**Annex C. TEST SETUP AND SUPPORTING EQUIPMENT**

**EUT TEST CONDITIONS**

**Annex C. i. SUPPORTING EQUIPMENT DESCRIPTION**

The following is a description of supporting equipment and details of cables used with the EUT.

Equipment Description (Including Brand Name)	Model & Serial Number	Cable Description (List Length, Type & Purpose)
N/A	N/A	N/A

**Block Configuration Diagram for Conducted Emissions**

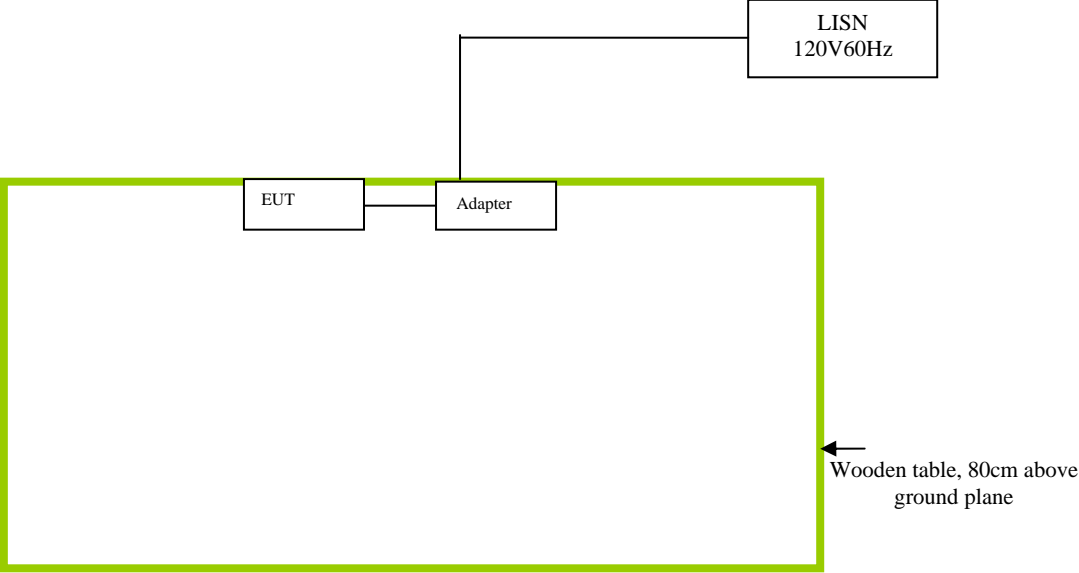

**Block Configuration Diagram for Radiated Emissions**

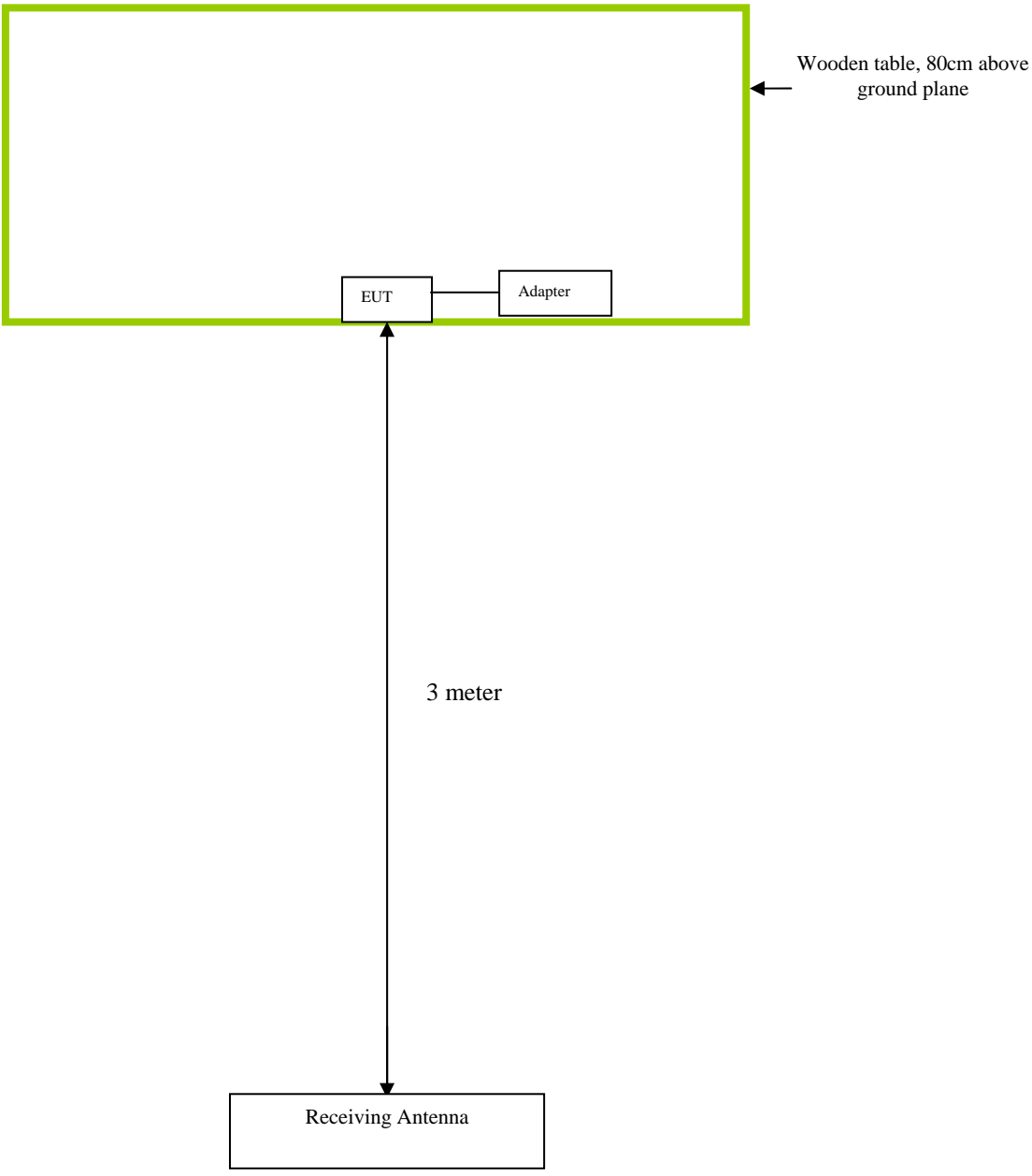



**SIEMIC, INC.**

Accessing global markets

Title: EMC Test Report for DIGITAL PIANO  
Main Model: MP8820  
Serial Model: N/A  
To: FCC Part 15 Subpart B Class B: 2012, ANSI C63.4: 2009

Report No: 13020055-FCC-E1  
Issue Date: May 29, 2013  
Page: 29 of 31  
www.siemic.com

### **Annex C.ii. EUT OPERATING CONDITIONS**

The following is the description of how the EUT is exercised during testing.

<b>Test</b>	<b>Description Of Operation</b>
Emissions Testing	Normal Working



**SIEMIC, INC.**

Accessing global markets

Title: EMC Test Report for DIGITAL PIANO  
Main Model: MP8820  
Serial Model: N/A  
To: FCC Part 15 Subpart B Class B: 2012, ANSI C63.4: 2009

Report No: 13020055-FCC-E1  
Issue Date: May 29, 2013  
Page: 30 of 31  
www.siemic.com

## **Annex D. USER MANUAL / BLOCK DIAGRAM / SCHEMATICS / PART LIST**

**Please see attachment**



**SIEMIC, INC.**

Accessing global markets

Title: EMC Test Report for DIGITAL PIANO  
Main Model: MP8820  
Serial Model: N/A  
To: FCC Part 15 Subpart B Class B: 2012, ANSI C63.4: 2009

Report No: 13020055-FCC-E1  
Issue Date: May 29, 2013  
Page: 31 of 31  
[www.siemic.com](http://www.siemic.com)

## **Annex E. DECLARATION OF SIMILARITY**

**N/A**