

## TEST REPORT

Test report no.: 1-4811/17-01-02-C



### Testing laboratory

**CTC advanced GmbH**

Untertuerkheimer Strasse 6 – 10  
66117 Saarbruecken / Germany  
Phone: + 49 681 5 98 - 0  
Fax: + 49 681 5 98 - 9075  
Internet: <http://www.ctcadvanced.com>  
e-mail: [mail@ctcadvanced.com](mailto:mail@ctcadvanced.com)

**Accredited Testing Laboratory:**

The testing laboratory (area of testing) is accredited according to DIN EN ISO/IEC 17025 (2005) by the Deutsche Akkreditierungsstelle GmbH (DAkkS) The accreditation is valid for the scope of testing procedures as stated in the accreditation certificate with the registration number: D-PL-12076-01-03

### Applicant

**ADC Automotive Distance Control Systems GmbH**

Peter-Dornier-Str. 10  
88131 Lindau/Bodensee / GERMANY  
Phone: 08382 9699 - 0  
Fax: +49 8382 9699-22435  
Contact: Frank Gruson  
e-mail: [frank.gruson@continental-corporation.com](mailto:frank.gruson@continental-corporation.com)  
Phone: +49 8382 9699-435

### Manufacturer

**Conti Temic microelectronic GmbH**

Ringlerstrasse 17  
85057 Ingolstadt / GERMANY

### Test standard/s

47 CFR Part 15	Title 47 of the Code of Federal Regulations; Chapter I; Part 15 - Radio frequency devices
RSS - 310 Issue 4	Licence-Exempt Radio Apparatus: Category II Equipment

For further applied test standards please refer to section 3 of this test report.

### Test Item

**Kind of test item:** SRD for RTTT (for blind spot detection)  
**Model name:** SRR3-B  
**FCC ID:** OAYSRR3B

**Frequency:** 24.00 – 24.25 GHz  
**Antenna:** Integrated planar patch antenna  
**Power supply:** 8.5 V to 16.0 V DC  
**Temperature range:** -40°C to +85°C



This test report is electronically signed and valid without handwritten signature. For verification of the electronic signatures, the public keys can be requested at the testing laboratory.

### Test report authorized:

Meheza Walla  
Lab Manager  
Radio Communications & EMC

### Test performed:

Karsten Gerdaldy  
Lab Manager  
Radio Communications & EMC

## 1 Table of contents

1	Table of contents .....	2
2	General information .....	3
2.1	Notes and disclaimer .....	3
2.2	Application details .....	3
2.3	Test laboratories sub-contracted .....	3
3	Test standard/s and references .....	4
4	Test environment .....	4
5	Test item .....	5
5.1	General description .....	5
5.2	Additional information .....	5
6	Description of the test setup .....	6
6.1	Shielded semi anechoic chamber .....	7
6.2	Shielded fully anechoic chamber .....	8
6.3	Radiated measurements > 18 GHz .....	10
6.4	Radiated measurements > 50 GHz .....	10
7	Sequence of testing .....	12
7.1	Sequence of testing radiated spurious 9 kHz to 30 MHz .....	12
7.2	Sequence of testing radiated spurious 30 MHz to 1 GHz .....	13
7.3	Sequence of testing radiated spurious 1 GHz to 18 GHz .....	14
7.4	Sequence of testing radiated spurious above 18 GHz .....	15
7.5	Sequence of testing radiated spurious above 50 GHz with external mixers .....	16
8	Summary of measurement results .....	17
9	Detailed measurement results .....	18
9.1	Field strength of emissions (wanted signal) .....	18
9.2	Occupied bandwidth .....	23
9.3	Field strength of emissions (radiated spurious) .....	25
10	Glossary .....	40
11	Document history .....	41
12	Accreditation Certificate .....	41

## 2 General information

### 2.1 Notes and disclaimer

The test results of this test report relate exclusively to the test item specified in this test report. CTC advanced GmbH does not assume responsibility for any conclusions and generalizations drawn from the test results with regard to other specimens or samples of the type of the equipment represented by the test item.

The test report may only be reproduced or published in full. Reproduction or publication of extracts from the report requires the prior written approval of CTC advanced GmbH.

The testing service provided by CTC advanced GmbH has been rendered under the current "General Terms and Conditions for CTC advanced GmbH".

CTC advanced GmbH will not be liable for any loss or damage resulting from false, inaccurate, inappropriate or incomplete product information provided by the customer.

Under no circumstances does the CTC advanced GmbH test report include any endorsement or warranty regarding the functionality, quality or performance of any other product or service provided.

Under no circumstances does the CTC advanced GmbH test report include or imply any product or service warranties from CTC advanced GmbH, including, without limitation, any implied warranties of merchantability, fitness for purpose, or non-infringement, all of which are expressly disclaimed by CTC advanced GmbH.

All rights and remedies regarding vendor's products and services for which CTC advanced GmbH has prepared this test report shall be provided by the party offering such products or services and not by CTC advanced GmbH. In no case this test report can be considered as a Letter of Approval.

This test report is electronically signed and valid without handwritten signature. For verification of the electronic signatures, the public keys can be requested at the testing laboratory.

**This test report replaces the test report with the number 1-4811/17-01-02-B and dated 2018-09-19**

### 2.2 Application details

Date of receipt of order:	2017-07-26
Date of receipt of test item:	2017-12-01
Start of test:	2017-12-04
End of test:	2017-12-09
Person(s) present during the test:	Mr. Raimund Münch

### 2.3 Test laboratories sub-contracted

None

### 3 Test standard/s and references

Test standard	Date	Description
47 CFR Part 15		Title 47 of the Code of Federal Regulations; Chapter I; Part 15 - Radio frequency devices
RSS - 310 Issue 4	July 2015	Licence-Exempt Radio Apparatus: Category II Equipment

Reference	Date	Description
ANSI C63.4-2014	2014	American national standard for methods of measurement of radio-noise emissions from low-voltage electrical and electronic equipment in the range of 9 kHz to 40 GHz
ANSI C63.10-2013	2013	American national standard of procedures for compliance testing of unlicensed wireless devices

### 4 Test environment

Temperature	:	T <sub>nom</sub>	+22 °C during room temperature tests
		T <sub>max</sub>	-/- °C during high temperature tests
		T <sub>min</sub>	-/- °C during low temperature tests
Relative humidity content	:		45 %
Barometric pressure	:		1021 hpa
Power supply	:	V <sub>nom</sub>	13.5 V DC
		V <sub>max</sub>	16.0 V
		V <sub>min</sub>	8.5 V

## 5 Test item

### 5.1 General description

Kind of test item	:	SRD for RTTT (for blind spot detection)
Type identification	:	SRR3-B
S/N serial number	:	FCC-Stop-Mode $f_{imh}$ : 00217B240002F Normal Operation: 00217B2400032
HW hardware status	:	A2C7602240300
SW software status	:	APP SW: 2.3.0 EVS SW: 2.14.7
Frequency band	:	24.00 – 24.25 GHz
Type of modulation	:	FMCW
Number of channels	:	1
Antenna	:	Integrated planar patch antenna
Power supply	:	8.5 V to 16.0 V DC
Temperature range	:	-40°C to +85°C

### 5.2 Additional information

The customer provided following test samples for the measurements:

- Special test mode (EVS) with frequency sweep stopped at  $f_{low}$ ,  $f_{mid}$ ,  $f_{high}$  as per CFR 47 Part 15.31(c)
- Normal operation mode (APP) with FMCW active.

The content of the following annexes is defined in the QA. It may be that not all of the listed annexes are necessary for this report, thus some values in between may be missing.

Test setup- and EUT-photos are included in test report:

- 1-4811/17-01-02\_AnnexA
- 1-4811/17-01-02\_AnnexB
- 1-4811/17-01-02\_AnnexC

## 6 Description of the test setup

Typically, the calibrations of the test apparatus are commissioned to and performed by an accredited calibration laboratory. The calibration intervals are determined in accordance with the DIN EN ISO/IEC 17025. In addition to the external calibrations, the laboratory executes comparison measurements with other calibrated test systems or effective verifications. Weekly chamber inspections and range calibrations are performed. Where possible, RF generating and signaling equipment as well as measuring receivers and analyzers are connected to an external high-precision 10 MHz reference (GPS-based or rubidium frequency standard).

In order to simplify the identification of the equipment used at some special tests, some items of test equipment and ancillaries can be provided with an identifier or number in the equipment list below (Lab/Item).

### **Agenda:** Kind of Calibration

k	calibration / calibrated		EK	limited calibration
ne	not required (k, ev, izw, zw not required)		zw	cyclical maintenance (external cyclical maintenance)
ev	periodic self verification		izw	internal cyclical maintenance
Ve	long-term stability recognized		g	blocked for accredited testing
vkl!	Attention: extended calibration interval			
NK!	Attention: not calibrated		*)	next calibration ordered / currently in progress

## 6.1 Shielded semi anechoic chamber

The radiated measurements are performed in vertical and horizontal plane in the frequency range from 30 MHz to 1 GHz in semi-anechoic chambers. The EUT is positioned on a non-conductive support with a height of 0.80 m above a conductive ground plane that covers the whole chamber. The receiving antennas are conform to specifications ANSI C63. These antennas can be moved over the height range between 1.0 m and 4.0 m in order to search for maximum field strength emitted from EUT. The measurement distances between EUT and receiving antennas are indicated in the test setups for the various frequency ranges. For each measurement, the EUT is rotated in all three axes until the maximum field strength is received. The wanted and unwanted emissions are received by spectrum analyzers where the detector modes and resolution bandwidths over various frequency ranges are set according to requirement ANSI C63.

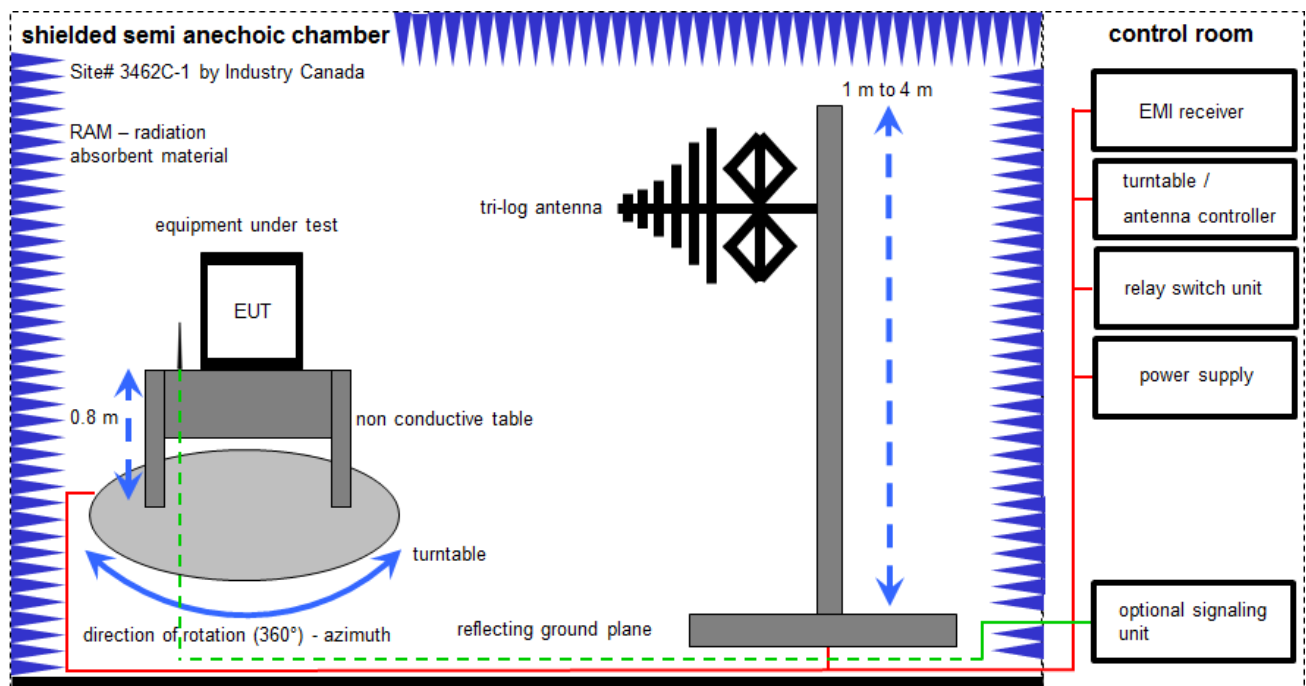

Measurement distance: tri-log antenna 10 meter

$$FS = UR + CL + AF$$

(FS-field strength; UR-voltage at the receiver; CL-loss of the cable; AF-antenna factor)

Example calculation:

$$FS [dB\mu V/m] = 12.35 [dB\mu V/m] + 1.90 [dB] + 16.80 [dB/m] = 31.05 [dB\mu V/m] (35.69 \mu V/m)$$

**Equipment table:**

No.	Equipment	Type	Manufacturer	Serial No.	INV. No.	Kind of Calibration	Last Calibration	Next Calibration
1	Switch-Unit	3488A	HP	2719A14505	300000368	ev	-/-	-/-
2	DC power supply, 60Vdc, 50A, 1200 W	6032A	HP	2920A04466	300000580	ne	-/-	-/-
3	Meßkabine 1	HF-Absorberhalle	MWB AG 300023		300000551	ne	-/-	-/-
4	EMI Test Receiver	ESCI 3	R&S	100083	300003312	k	01.02.2017	31.01.2018
5	Analyzer-Reference-System (Harmonics and Flicker)	ARS 16/1	SPS	A3509 07/0 0205	300003314	vKII	02.02.2016	01.02.2018
6	Antenna Tower	Model 2175	ETS-Lindgren	64762	300003745	izw	-/-	-/-
7	Positioning Controller	Model 2090	ETS-Lindgren	64672	300003746	izw	-/-	-/-
8	Turntable Interface-Box	Model 105637	ETS-Lindgren	44583	300003747	izw	-/-	-/-
9	TRILOG Broadband Test-Antenna 30 MHz - 3 GHz	VULB9163	Schwarzbeck	295	300003787	k	25.04.2016	25.04.2018
10	Spectrum-Analyzer	FSU26	R&S	200809	300003874	k	31.01.2017	30.01.2018
11	Double Ridge Broadband Horn Antenna 1-10 GHz	BBHA9120 B	Schwarzbeck	188	300003896	k	20.05.2015	20.05.2018

## 6.2 Shielded fully anechoic chamber

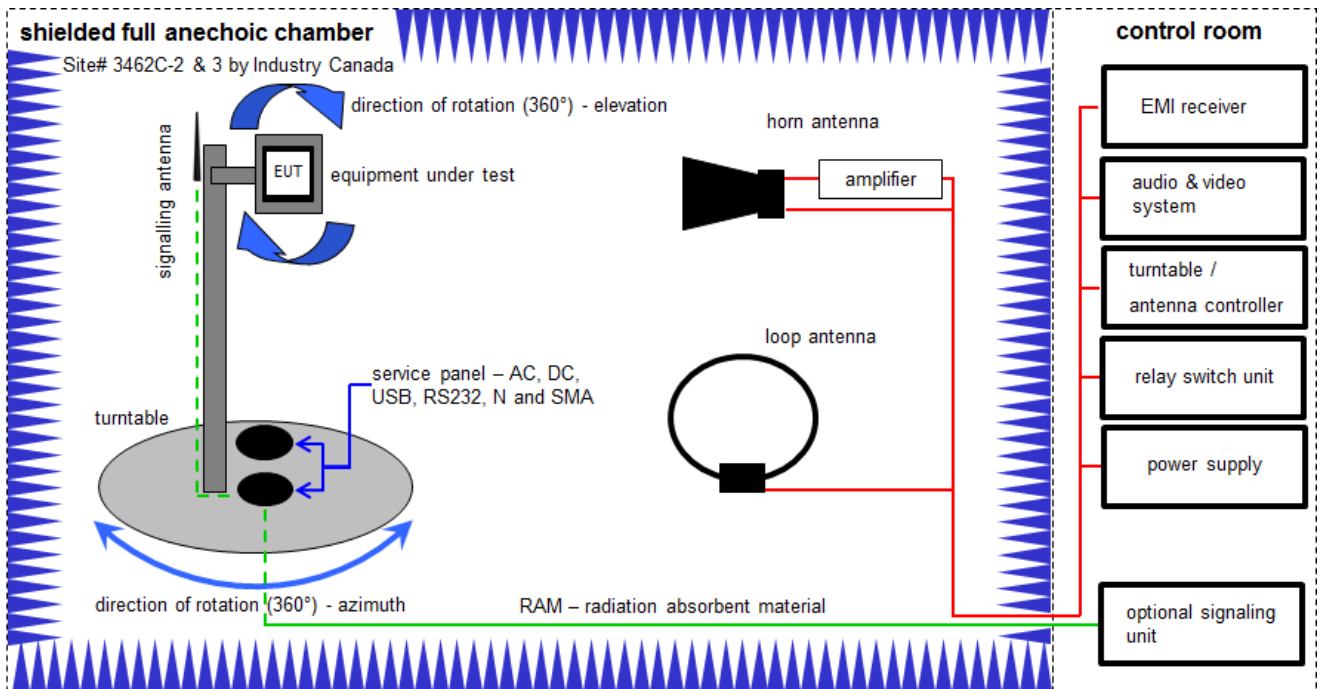

Measurement distance: horn antenna 3 meter; loop antenna 3 meter / 1 meter

FS = UR + CA + AF

(FS-field strength; UR-voltage at the receiver; CA-loss of the signal path; AF-antenna factor)

Example calculation:

FS [dBµV/m] = 40.0 [dBµV/m] + (-35.8) [dB] + 32.9 [dB/m] = 37.1 [dBµV/m] (71.61 µV/m)

### Equipment table:

No.	Equipment	Type	Manufacturer	Serial No.	INV. No.	Kind of Calibration	Last Calibration	Next Calibration
1	DC power supply, 60Vdc, 50A, 1200 W	6032A	HP	2818A03450	300001040	vKI!	20.01.2015	19.01.2018
2	Active Loop Antenna 9 kHz to 30 MHz	6502	EMCO	2210	300001015	k	07.07.2017	06.07.2019
3	Anechoic chamber	FAC 3/5m	MWB / TDK	87400/02	300000996	ev	-/-	-/-
4	Double-Ridged Waveguide Horn Antenna 1-18.0GHz	3115	EMCO	9107-3697	300001605	vKI!	14.02.2017	13.02.2019
5	Switch / Control Unit	3488A	HP	*	300000199	ne	-/-	-/-
6	Variable isolating transformer	MPL IEC625 Bus Variable isolating transformer	Erfi	91350	300001155	ne	-/-	-/-
7	Active Loop Antenna 9 kHz to 30 MHz	6502	EMCO/2	8905-2342	300000256	k	24.06.2015	24.06.2018
8	Band Reject filter	WRCG1850/1910-1835/1925-40/8SS	Wainwright	7	300003350	ev	-/-	-/-
9	Band Reject filter	WRCG2400/2483-2375/2505-50/10SS	Wainwright	11	300003351	ev	-/-	-/-
10	Highpass Filter	WHKX2.9/18G-12SS	Wainwright	1	300003492	ev	-/-	-/-
11	EMI Test Receiver 20Hz-26,5GHz	ESU26	R&S	100037	300003555	k	31.01.2017	30.01.2018
12	Highpass Filter	WHK1.1/15G-10SS	Wainwright	3	300003255	ev	-/-	-/-
13	Highpass Filter	WHKX7.0/18G-8SS	Wainwright	19	300003790	ne	-/-	-/-
14	MXG Microwave Analog Signal Generator	N5183A	Agilent Technologies	MY47420220	300003813	k	27.01.2017	26.01.2020
15	TRILOG Broadband Test-Antenna 30 MHz - 3 GHz	VULB9163	Schwarzbeck	371	300003854	vKI!	29.10.2014	29.10.2018
16	High Pass Filter	VHF-3500+	Mini Circuits	-/-	400000193	ne	-/-	-/-
17	Broadband Amplifier 0.5-18 GHz	CBLU5184540	CERNEX	22049	300004481	ev	-/-	-/-



18	Broadband Amplifier 5-13 GHz	CBLU5135235	CERNEX	22010	300004491	ev	-/-	-/-
19	4U RF Switch Platform	L4491A	Agilent Technologies	MY50000037	300004509	ne	-/-	-/-
20	NEXIO EMV-Software	BAT EMC V3.16.0.49	EMCO		300004682	ne	-/-	-/-
21	PC	ExOne	F+W		300004703	ne	-/-	-/-
22	Highpass Filter (Chebyshev)	WHKX10-4432.5-4925-18000-40SS	Wainwright	1	300005028	ev	-/-	-/-
23	Lowpass Filter (Chebyshev)	WLK12-5975-6333.5-18000-40SS	Wainwright	1	400001213	ev	-/-	-/-
24	RF-Amplifier	AMF-6F06001800-30-10P-R	NARDA-MITEQ Inc	2011572	300005241	ev	-/-	-/-
25	TRILOG Broadband Test-Antenna	VULB9163	Schwarzbeck Mess Elektronik	01029	300005379	k	07.04.2017	06.04.2020

### 6.3 Radiated measurements > 18 GHz

#### Radiated measurements > 18 GHz

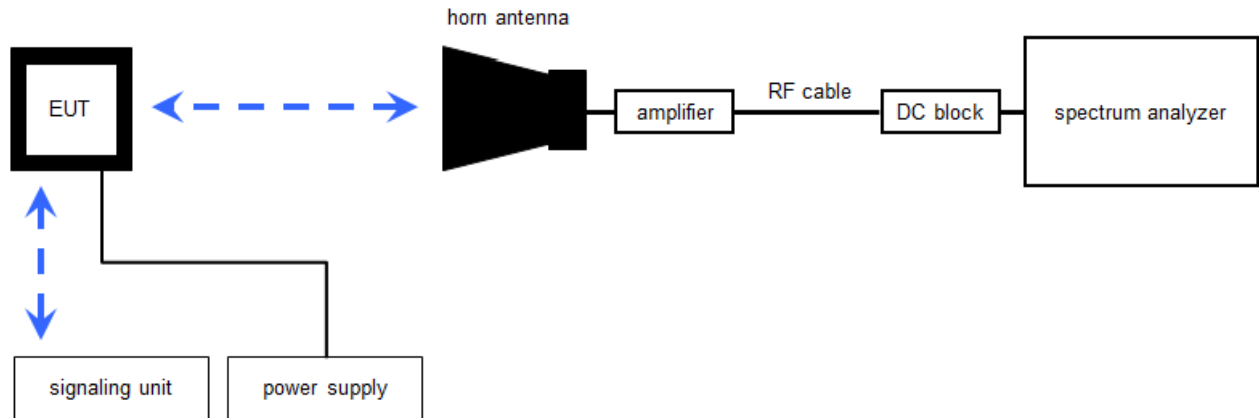

### 6.4 Radiated measurements > 50 GHz

#### Radiated measurements RF laboratory

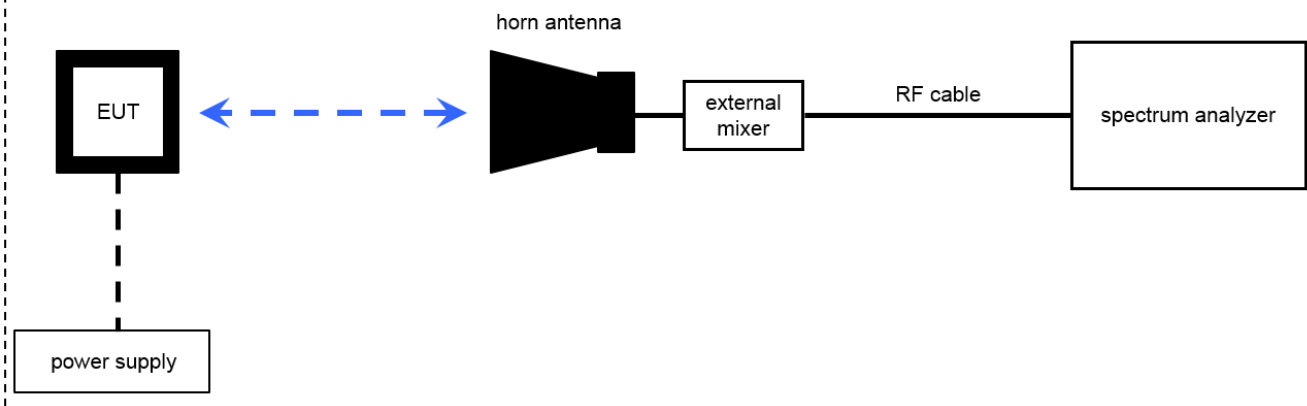

Measurement distance is shown in table with each test.

$$FS = UR + CA + AF$$

(FS-field strength; UR-voltage at the receiver; CA-loss signal path & distance correction; AF-antenna factor)

Example calculation:

$$FS [dB\mu V/m] = 40.0 [dB\mu V/m] + (-60.1) [dB] + 36.74 [dB/m] = 16.64 [dB\mu V/m] (6.79 \mu V/m)$$

**Note:** conversion loss of mixer is already included in analyzer value.

Due to the directional nature and test distance used for measurements above 18 GHz, all measurements were found to be line of sight such that use of absorber material on the ground plane was found to not be necessary.

**Equipment table:**

No.	Lab / Item	Equipment	Type	Manufacturer	Serial No.	INV. No.	Kind of Calibration	Last Calibration	Next Calibration
1	n. a.	Broadband LNA 18-50 GHz	CBL18503070PN	CERNEX	25240	300004948	ev	-/-	-/-
2	n. a.	Harmonic Mixer 2-Port, 50-75 GHz	FS-Z75	R&S	100099	300003949	k	30.06.2017	29.06.2018
3	n. a.	Harmonic Mixer 3-Port, 75-110 GHz	FS-Z110	R&S	101411	300004959	k	03.07.2017	02.07.2018
4	A039	Netzgerät	LA30/1BA-1	Zentro	2027	300000194	ev	-/-	-/-
5	n. a.	Spectrum Analyzer 20 Hz - 50 GHz	FSU50	R&S	200012	300003443	k	28.10.2016	27.10.2018
6	A027	Std. Gain Horn Antenna 18.0-26.5 GHz	638	Narda		300000486	k	10.09.2015	10.09.2018
7	A031	Std. Gain Horn Antenna 26.5-40.0 GHz	V637	Narda	82-16	300000510	k	14.08.2015	14.08.2018
8	A039	Std. Gain Horn Antenna 33.0-50.1 GHz	2324-20	Flann	57	400000683	ne	-/-	-/-
9	A023	Std. Gain Horn Antenna 39.3-59.7 GHz	2424-20	Flann	75	300001979	ne	-/-	-/-
10	A025	Std. Gain Horn Antenna 49.9-75.8 GHz	2524-20	Flann	*	300001983	ne	-/-	-/-
11	A028	Std. Gain Horn Antenna 73.8-112 GHz	2724-20	Flann	*	300001991	ne	-/-	-/-

## 7 Sequence of testing

### 7.1 Sequence of testing radiated spurious 9 kHz to 30 MHz

#### Setup

- The equipment is set up to simulate normal operation mode as described in the user manual or defined by the manufacturer.
- If the EUT is a tabletop system, it is placed on a table with 0.8 m height.
- If the EUT is a floor standing device, it is placed directly on the turn table.
- Auxiliary equipment and cables are positioned to simulate normal operation conditions as described in ANSI C 63.10.
- The AC power port of the EUT (if available) is connected to a power outlet below the turntable.
- Measurement distance is 3 m (see ANSI C 63.10) – see test details.
- EUT is set into operation.

#### Premeasurement\*

- The turntable rotates from 0° to 315° using 45° steps.
- The antenna height is 1 m.
- At each turntable position the analyzer sweeps with positive-peak detector to find the maximum of all emissions.

#### Final measurement

- Identified emissions during the pre-measurement are maximized by the software by rotating the turntable from 0° to 360°.
- Loop antenna is rotated about its vertical axis for maximum response at each azimuth about the EUT. (For certain applications, the loop antenna plane may also need to be positioned horizontally at the specified distance from the EUT)
- The final measurement is done in the position (turntable and elevation) causing the highest emissions with quasi-peak (as described in ANSI C 63.10).
- Final levels, frequency, measuring time, bandwidth, turntable position, correction factor, margin to the limit and limit will be recorded. A plot with the graph of the premeasurement and the limit is stored.

\*)Note: The sequence will be repeated three times with different EUT orientations.

## 7.2 Sequence of testing radiated spurious 30 MHz to 1 GHz

### Setup

- The equipment is set up to simulate normal operation mode as described in the user manual or defined by the manufacturer.
- If the EUT is a tabletop system, a table with 0.8 m height is used, which is placed on the ground plane.
- If the EUT is a floor standing device, it is placed on the ground plane with insulation between both.
- Auxiliary equipment and cables are positioned to simulate normal operation conditions as described in ANSI C 63.10.
- The AC power port of the EUT (if available) is connected to a power outlet below the turntable.
- Measurement distance is 10 m or 3 m (see ANSI C 63.10) – see test details.
- EUT is set into operation.

### Premeasurement

- The turntable rotates from 0° to 315° using 45° steps.
- The antenna is polarized vertical and horizontal.
- The antenna height changes from 1 m to 3 m.
- At each turntable position, antenna polarization and height the analyzer sweeps three times in peak to find the maximum of all emissions.

### Final measurement

- The final measurement is performed for at least six highest peaks according to the requirements of the ANSI C63.4.
- Based on antenna and turntable positions at which the peak values are measured the software maximize the peaks by changing turntable position  $\pm 45^\circ$  and antenna height between 1 and 4 m.
- The final measurement is done with quasi-peak detector (as described in ANSI C 63.10).
- Final levels, frequency, measuring time, bandwidth, antenna height, antenna polarization, turntable angle, correction factor, margin to the limit and limit are recorded. A plot with the graph of the premeasurement with marked maximum final results and the limit is stored.

### 7.3 Sequence of testing radiated spurious 1 GHz to 18 GHz

#### Setup

- The equipment is set up to simulate normal operation mode as described in the user manual or defined by the manufacturer.
- If the EUT is a tabletop system, a 2-axis positioner with 1.5 m height is used.
- If the EUT is a floor standing device, it is placed directly on the turn table.
- Auxiliary equipment and cables are positioned to simulate normal operation conditions as described in ANSI C 63.10.
- The AC power port of the EUT (if available) is connected to a power outlet below the turntable.
- Measurement distance is 3 m (see ANSI C 63.10) – see test details.
- EUT is set into operation.

#### Premeasurement

- The turntable rotates from 0° to 315° using 45° steps.
- The antenna is polarized vertical and horizontal.
- The antenna height is 1.5 m.
- At each turntable position and antenna polarization the analyzer sweeps with positive peak detector to find the maximum of all emissions.

#### Final measurement

- The final measurement is performed for at least six highest peaks according to the requirements of the ANSI C63.4.
- Based on antenna and turntable positions at which the peak values are measured the software maximizes the peaks by rotating the turntable from 0° to 360°. This measurement is repeated for different EUT-table positions (0° to 150° in 30°-steps) and for both antenna polarizations.
- The final measurement is done in the position (turntable, EUT-table and antenna polarization) causing the highest emissions with Peak and RMS detector (as described in ANSI C 63.10).
- Final levels, frequency, measuring time, bandwidth, turntable position, EUT-table position, antenna polarization, correction factor, margin to the limit and limit are recorded. A plot with the graph of the premeasurement with marked maximum final results and the limit is stored.

## 7.4 Sequence of testing radiated spurious above 18 GHz

### Setup

- The equipment is set up to simulate normal operation mode as described in the user manual or defined by the manufacturer.
- Auxiliary equipment and cables are positioned to simulate normal operation conditions as described in ANSI C 63.10.
- The AC power port of the EUT (if available) is connected to a power outlet.
- The measurement distance is as appropriate (e.g. 0.5 m).
- The EUT is set into operation.

### Premeasurement

- The test antenna is handheld and moved carefully over the EUT to cover the EUT's whole sphere and different polarizations of the antenna.

### Final measurement

- The final measurement is performed at the position and antenna orientation causing the highest emissions with Peak and RMS detector (as described in ANSI C 63.10).
- Final levels, frequency, measuring time, bandwidth, correction factor, margin to the limit and limit are recorded. A plot with the graph of the premeasurement and the limit is stored.

## 7.5 Sequence of testing radiated spurious above 50 GHz with external mixers

### Setup

- The equipment is set up to simulate normal operation mode as described in the user manual or defined by the manufacturer.
- Auxiliary equipment and cables are positioned to simulate normal operation conditions as described in ANSI C 63.10.
- The AC power port of the EUT (if available) is connected to a power outlet.
- The measurement distance is as appropriate for far field (e.g. 0.25 m).
- The EUT is set into operation.

### Premeasurement

- The test antenna with external mixer is handheld and moved carefully over the EUT to cover the EUT's whole sphere and different polarizations of the antenna.
- Caution is taken to reduce the possible overloading of the external mixer.

### Final measurement

- The final measurement is performed at the position and antenna orientation causing the highest emissions with Peak and RMS detector (as described in ANSI C 63.10).
- As external mixers may generate false images care is taken to ensure that any emission measured by the spectrum analyzer does indeed originate in the EUT. Signal identification feature of spectrum analyzer is used to eliminate false mixer images (i.e., it is not the fundamental emission or a harmonic falling precisely at the measured frequency).
- Final levels, frequency, measuring time, bandwidth, correction factor, margin to the limit and limit are recorded. A plot with the graph of the premeasurement and the limit is stored.

**Note:** see also FCC's Millimeter Wave Test Procedures



## 8 Summary of measurement results

<input checked="" type="checkbox"/>	<b>No deviations from the technical specifications were ascertained</b>
<input type="checkbox"/>	There were deviations from the technical specifications ascertained
<input type="checkbox"/>	This test report is only a partial test report. The content and verdict of the performed test cases are listed below.

TC Identifier	Description	Verdict	Date	Remark
RF-Testing	FCC 47 CFR Part 15 / IC RSS-310	Passed	2019-05-29	-/-

Test specification clause	Test case	Temperature conditions	Power supply	C	NC	NA	NP	Results (max.)
§15.249(a) / RSS-310, 3.10	Field strength of emissions (wanted signal)	Nominal	Nominal	<input checked="" type="checkbox"/>	<input type="checkbox"/>	<input type="checkbox"/>	<input type="checkbox"/>	PK: 111.5 dBµV/m AVG: 84.1 dBµV/m @ 3 m
§2.1049	Occupied bandwidth	Nominal	Nominal	<input checked="" type="checkbox"/>	<input type="checkbox"/>	<input type="checkbox"/>	<input type="checkbox"/>	99%: 176.4 MHz 26 dB: 185.1 MHz
§15.209(a) / §15.249 (c)(d)(e) RSS-Gen	Field strength of emissions (spurious / band edge / harmonics)	Nominal	Nominal	<input checked="" type="checkbox"/>	<input type="checkbox"/>	<input type="checkbox"/>	<input type="checkbox"/>	complies

**Note:** C = Compliant; NC = Not compliant; NA = Not applicable; NP = Not performed

## 9 Detailed measurement results

### 9.1 Field strength of emissions (wanted signal)

#### Description:

Measurement of the maximum radiated field strength of the wanted signal.

#### Measurement:

Measurement parameter	
Detector:	Pos-Peak / AVG
Sweep time:	100 s
Resolution bandwidth:	1 MHz
Video bandwidth:	3 MHz
Filter type:	6 dB filter
Span:	300 MHz
Trace-Mode:	Max Hold

#### Limits:

FCC		IC
CFR Part 15.249(a)		RSS-310, 3.10
Field strength of emissions		
The field strength of emissions from intentional radiators operated within these frequency bands shall comply with the following:		
Frequency	Field Strength	Measurement distance
24.0 GHz – 24.25 GHz	108 dB $\mu$ V/m (Average) 128 dB $\mu$ V/m (PEAK)	3 m

§15.249 (e) As shown in § 15.35(b), for frequencies above 1000 MHz, the field strength limits in paragraphs (a) and (b) of this section are based on average limits. However, the peak field strength of any emission shall not exceed the maximum permitted average limits specified above by more than 20 dB under any condition of modulation.

§15.31 (c) Except as otherwise indicated in §15.256, for swept frequency equipment, measurements shall be made with the frequency sweep stopped at those frequencies chosen for the measurements to be reported.

**Measurement results:**

Test condition	Maximum field strength (Peak) (dBµV/m @3m)	Maximum field strength (Average) (dBµV/m @3m)	Maximum field strength (Average, calculated) (dBµV/m @3m)
normal operation mode	111.5	84.1	106.0
test mode - f <sub>low</sub>	111.3	-/-	105.8
test mode - f <sub>mid</sub>	110.2	-/-	104.7
test mode - f <sub>high</sub>	110.3	-/-	104.8
Measurement uncertainty	± 3 dB		

**Note:**

Above test was performed on a test distance of 1 m. The correction factor consisting of antenna factor, cable loss and distance correction factor of  $20 \cdot \log(1\text{m}/3\text{m})$  is already considered in the corresponding plots. In addition to above described correction +0.8 dB correction factor is added to the measured values based on test site substitution with a calibrated 24 GHz precision CW signal source provided by the applicant. This additional correction is already included as an offset in the plots, too.

Calculation for final amplitude offset:

antenna factor + cable loss + distance correction factor + additional substitution correction factor  
 $40.9 \text{ dB} + 4.9 \text{ dB} + 20 \cdot \log(1\text{m}/3\text{m}) + 0.8 \text{ dB} = \underline{\underline{37.1 \text{ dB}}}$

There is one supported mode: 21.1 ms ON, 40.1 ms cycle time. Last column shows calculated AVG values for FCC test mode f<sub>low</sub> / f<sub>mid</sub> / f<sub>high</sub> based on measured peak values and duty cycle correction of  $20 \cdot \log(\text{duty cycle}) = 20 \cdot \log(21.3 \text{ ms} / 40.1 \text{ ms}) = -5.5 \text{ dB}$  as per customer request. According to ANSI C63.10-2013, this is the duty cycle implemented for the test SW with frequency stop mode.

**Plot No. 1: Field strength, peak measurement, normal operation mode**

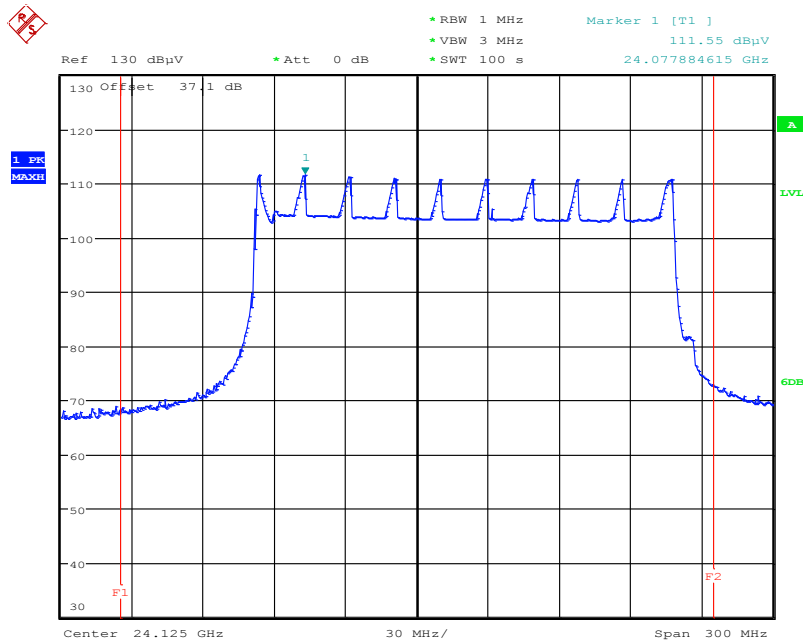

Date: 7.DEC.2017 16:42:24

**Plot No. 2: Field strength, average measurement, normal operation mode**

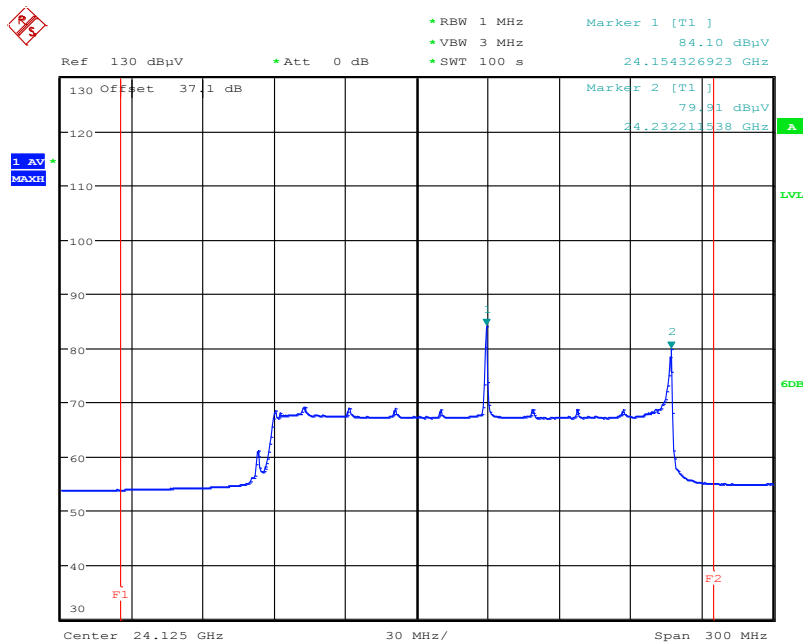

Date: 7.DEC.2017 16:45:15

**Plot No. 3: Field strength, peak measurement, test mode, low frequency**

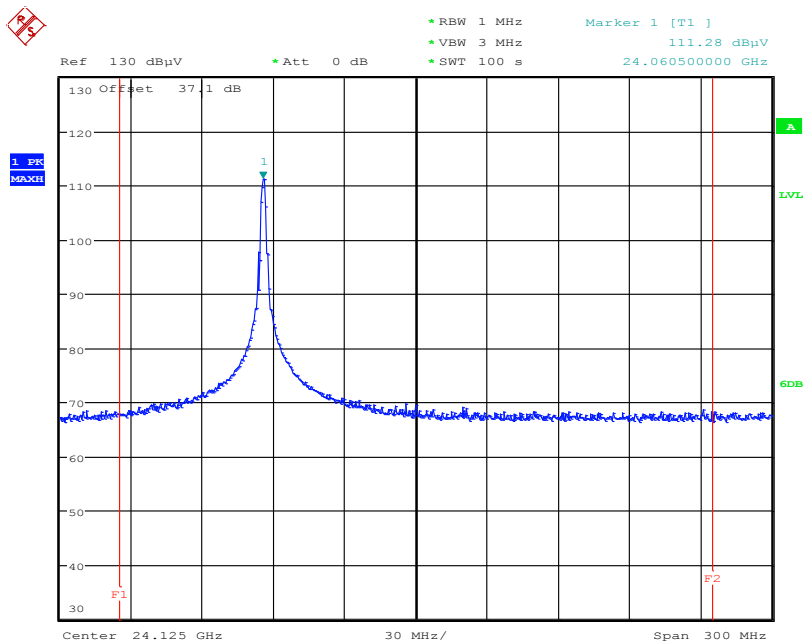

Date: 7.DEC.2017 10:21:30

**Plot No. 4: Field strength, peak measurement, test mode, mid frequency**

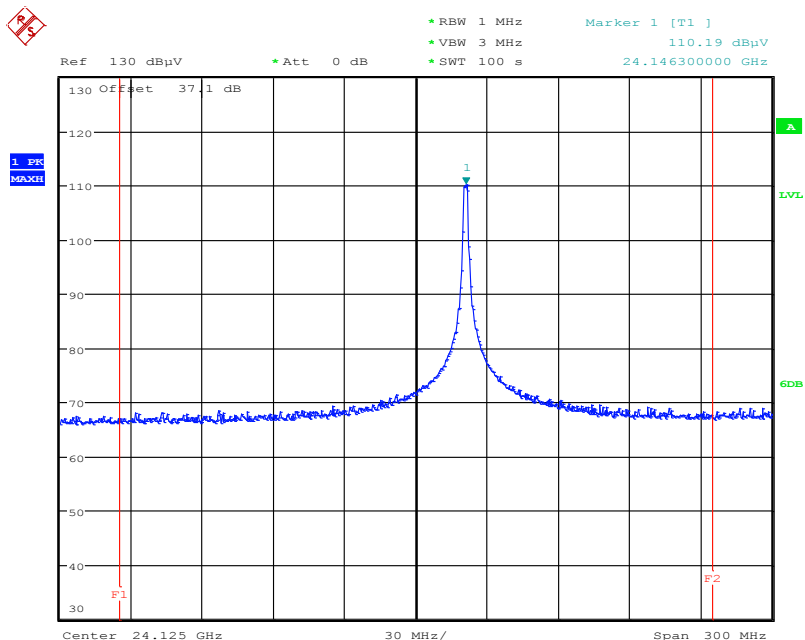

Date: 7.DEC.2017 10:02:36

**Plot No. 5: Field strength, peak measurement, test mode, high frequency**

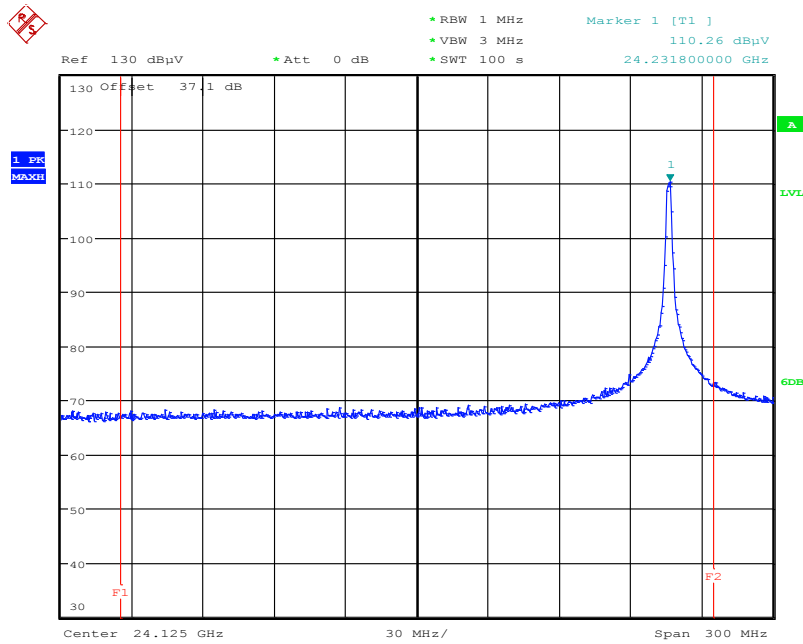

Date: 7.DEC.2017 10:40:32

**Plot No. 6: Duty cycle, test mode**

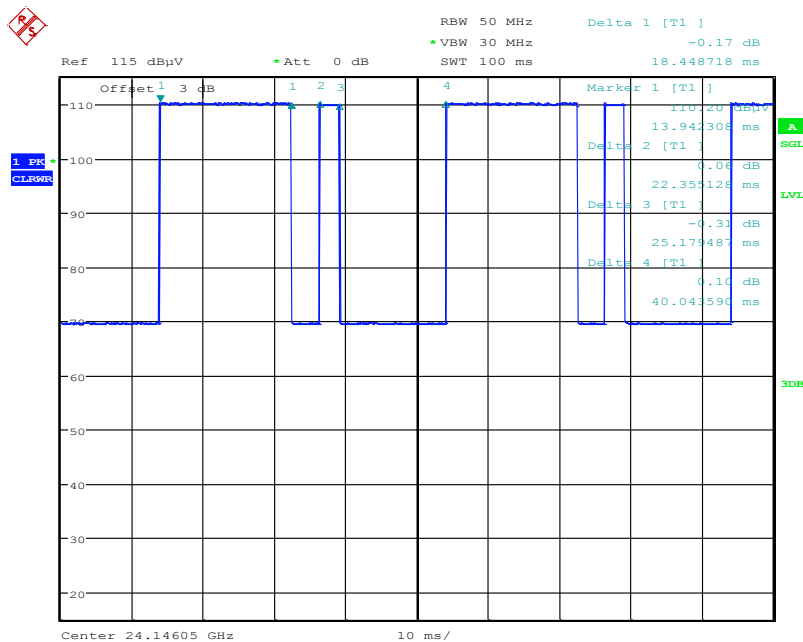

Date: 7.DEC.2017 11:13:20

## 9.2 Occupied bandwidth

### Description:

Measurement of the 99% bandwidth and 26 dB bandwidth of the wanted signal.

### Measurement:

Measurement parameter	
Detector:	Pos-Peak
Sweep time:	100 s
Resolution bandwidth:	1 MHz
Video bandwidth:	3 MHz
Filter type:	3 dB filter
Span:	300 MHz
Trace-Mode:	Max Hold

### Limits:

250 MHz	f(lowest) > 24.0 GHz	f(highest) < 24.25GHz
---------	----------------------	-----------------------

### Measurement results:

Test condition	Occupied bandwidth (MHz)
99% Occupied bandwidth	176.4
26 dB Occupied bandwidth	185.1
Measurement uncertainty	± span/1000

**Plot No. 7: 99% occupied bandwidth, peak measurement, normal operation mode**

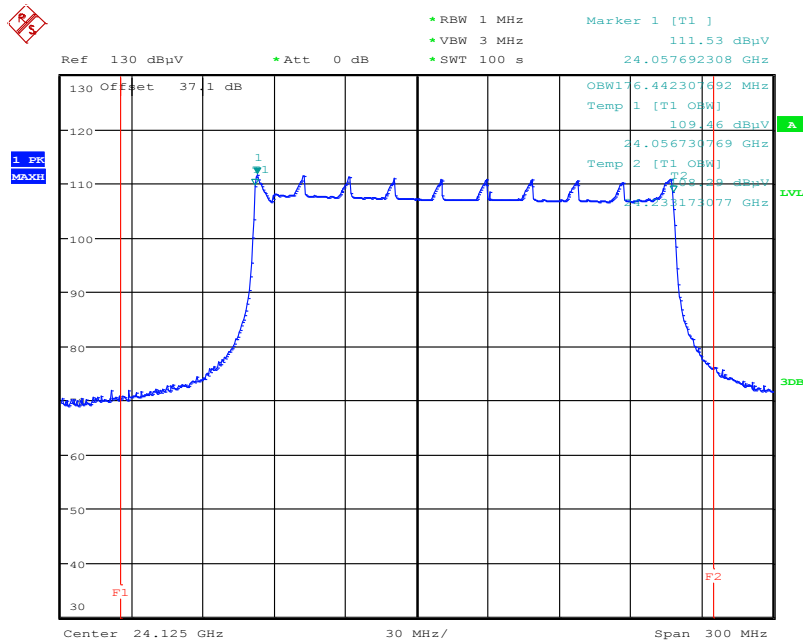

Date: 7.DEC.2017 16:56:05

**Plot No. 8: 26 dB occupied bandwidth, peak measurement, normal operation mode**

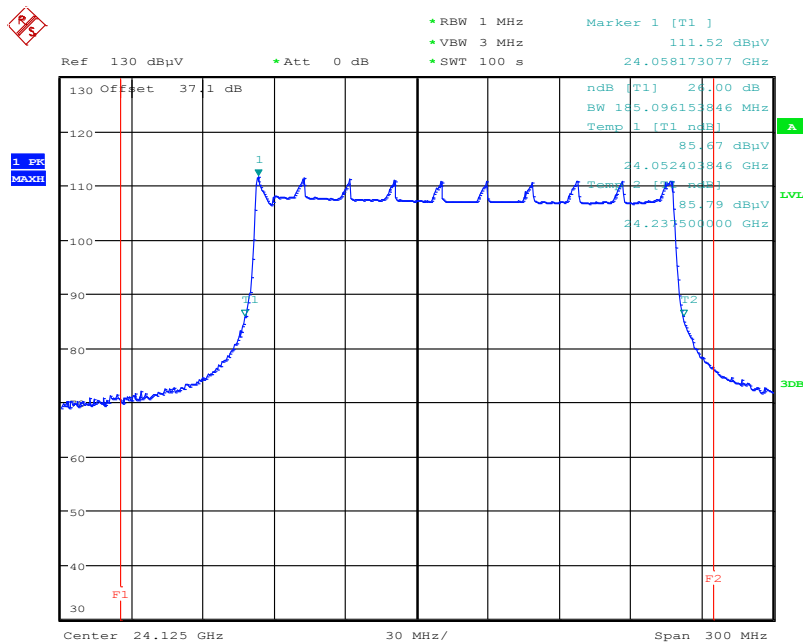

Date: 7.DEC.2017 16:51:33



### 9.3 Field strength of emissions (radiated spurious)

#### Description:

Measurement of the radiated spurious emissions in transmit mode.

#### Measurement:

Measurement parameter	
Detector:	Quasi Peak / AVG / Peak
Sweep time:	Auto
Resolution bandwidth:	F < 1 GHz: 100 kHz F > 1 GHz: 1 MHz
Video bandwidth:	=3 x RBW
Filter type:	6 dB filter
Frequency range:	30 MHz to 100 GHz
Trace-Mode:	Max Hold

#### Limits:

FCC	IC	
CFR Part 15.209(a) / CFR Part 15.249(d)	RSS - GEN	
Emissions radiated outside of the specified frequency bands, except for harmonics, shall be attenuated by at least 50 dB below the level of the fundamental or to the general radiated emission limits in § 15.209, whichever is the lesser attenuation.		
Frequency (MHz)	Field Strength (µV/m)	Measurement distance (m)
0.009 – 0.490	2400/F(kHz)	300
0.490 – 1.705	24000/F(kHz)	30
1.705 – 30.0	30	30
30 – 88	100	3
88 – 216	150	3
216 – 960	200	3
Above 960	500	3

§15.249 (a) Harmonic emissions shall not exceed 2.5 mV/m measured at 3 m.

§15.249 (e) As shown in § 15.35(b), for frequencies above 1000 MHz, the field strength limits in paragraphs (a) and (b) of this section are based on average limits. However, the peak field strength of any emission shall not exceed the maximum permitted average limits specified above by more than 20 dB under any condition of modulation.

§15.31 (c) Except as otherwise indicated in §15.256, for swept frequency equipment, measurements shall be made with the frequency sweep stopped at those frequencies chosen for the measurements to be reported.

**Measurement results:**

TX Spurious Emissions Radiated [dBµV/m]							
Low Frequency							
Frequency [GHz]	Detector	Bandwidth [MHz]	Correction [dB]	Distance [m]	Level [dBµV/m]	Limit [dBµV/m]	Margin [dB]
0.797	QP	0.1	22.7	10	20.0	36	16.0
24.00	PK	1.0	37.1	1.0	59.9	74	14.1
24.00	AVG	1.0	37.1	1.0	35.6	54	18.4
24.25	PK	1.0	37.1	1.0	69.2	74	4.8
24.25	AVG	1.0	37.1	1.0	43.0	54	11.0
48.12	PK	1.0	1.6	0.5	67.5	88	20.5
48.12	AVG	1.0	1.6	0.5	57.2	68	10.8
96.24	PK	1.0	19.7	0.1	55.4	88	32.6
96.24	AVG	1.0	19.7	0.1	43.2	68	24.8
<b>24.00</b>	<b>PK</b>	<b>1.0</b>	<b>37.1</b>	<b>1.0</b>	<b>59.1</b>	<b>74</b>	<b>14.9</b>
<b>24.00</b>	<b>AVG</b>	<b>1.0</b>	<b>37.1</b>	<b>1.0</b>	<b>33.4</b>	<b>54</b>	<b>20.6</b>

TX Spurious Emissions Radiated [dBµV/m]							
Mid Frequency							
Frequency [GHz]	Detector	Bandwidth [MHz]	Correction [dB]	Distance [m]	Level [dBµV/m]	Limit [dBµV/m]	Margin [dB]
0.702	QP	0.1	21.6	10	19.0	36	17.0
24.00	PK	1.0	37.1	1.0	59.9	74	14.1
24.00	AVG	1.0	37.1	1.0	35.6	54	18.4
24.25	PK	1.0	37.1	1.0	69.2	74	4.8
24.25	AVG	1.0	37.1	1.0	43.0	54	11.0
48.29	PK	1.0	1.6	0.5	67.1	88	20.9
48.29	AVG	1.0	1.6	0.5	56.8	68	11.2
96.58	PK	1.0	19.7	0.1	57.2	88	30.8
96.58	AVG	1.0	19.7	0.1	43.3	68	24.7

TX Spurious Emissions Radiated [dB $\mu$ V/m]							
High Frequency							
Frequency [GHz]	Detector	Bandwidth [MHz]	Correction [dB]	Distance [m]	Level [dB $\mu$ V/m]	Limit [dB $\mu$ V/m]	Margin [dB]
0.544	QP	0.1	21.2	10	22.1	36	13.9
24.00	PK	1.0	37.1	1.0	59.9	74	14.1
24.00	AVG	1.0	37.1	1.0	35.6	54	18.4
24.25	PK	1.0	37.1	1.0	69.2	74	4.8
24.25	AVG	1.0	37.1	1.0	43.0	54	11.0
48.46	PK	1.0	1.6	0.5	66.3	88	21.7
48.46	AVG	1.0	1.6	0.5	55.9	68	12.1
96.92	PK	1.0	19.7	0.1	58.1	88	29.9
96.92	AVG	1.0	19.7	0.1	49.0	68	19.0
<b>24.25</b>	<b>PK</b>	<b>1.0</b>	<b>37.1</b>	<b>1.0</b>	<b>68.7</b>	<b>74</b>	<b>5.3</b>
<b>24.25</b>	<b>AVG</b>	<b>1.0</b>	<b>37.1</b>	<b>1.0</b>	<b>37.7</b>	<b>54</b>	<b>16.3</b>

Note: QP = Quasi-Peak, PK = Peak, AVG = Linear Average

Measurements above 18 GHz were performed on a short measurement distance ( $\leq 1$ m) to improve the minimum sensitivity of the test system. A correction factor of  $20 \cdot \log(d/3m)$  is already considered in the plots.

Lines in bold letters show band edge compliance for normal operation mode.

**Plot No. 9: 9 kHz to 30 MHz, magnetic / loop antenna, low / mid / high frequency**

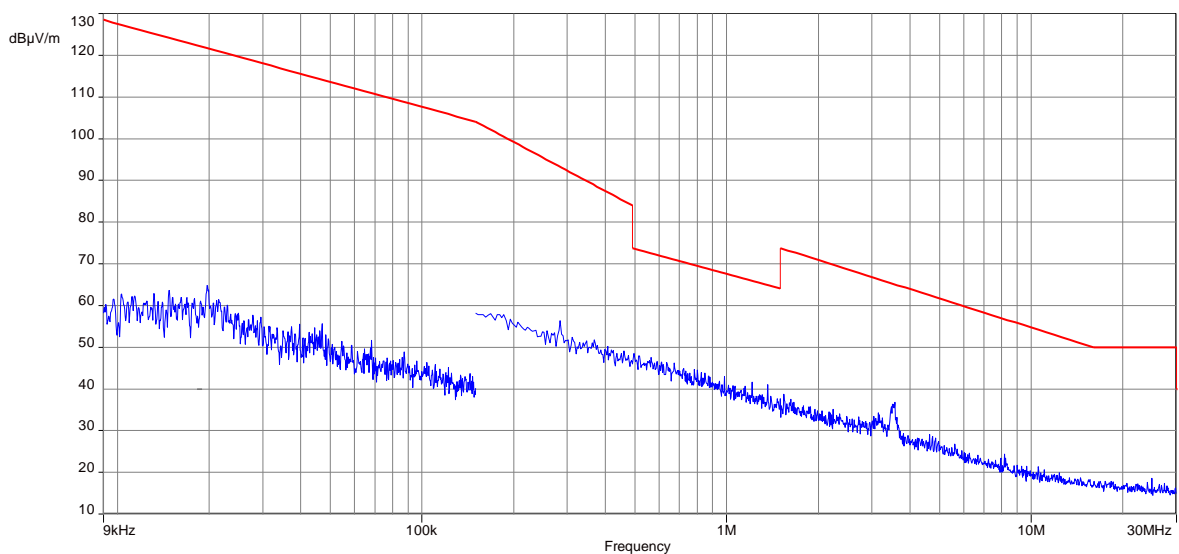
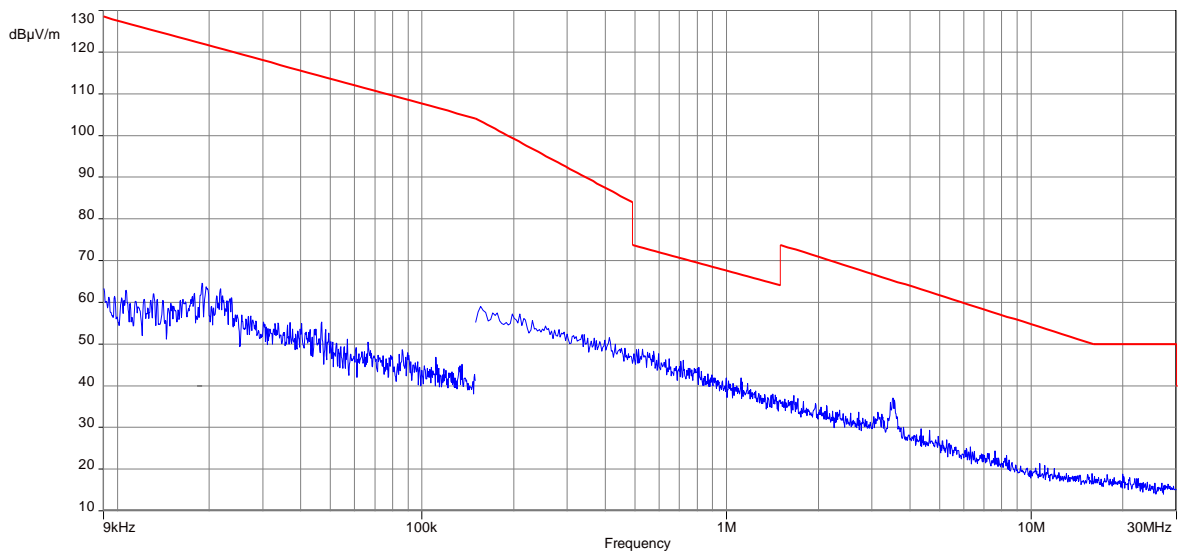
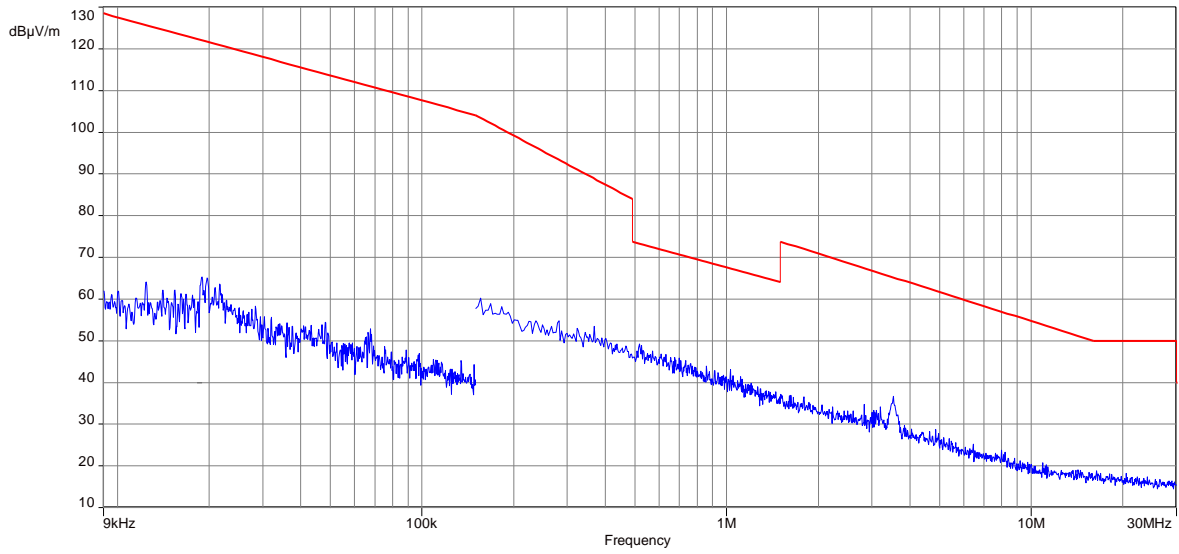

**Plot No. 10: 30 MHz to 1 GHz, horizontal / vertical polarization, low frequency**

EUT: SRR3-B  
 Serial number: 00217B240002F  
 Test description: FCC part 15 class B @ 10 m  
 Operating condition: tx lowest  
 Operator name: Wolsdorfer  
 Comment: DC 13.5V

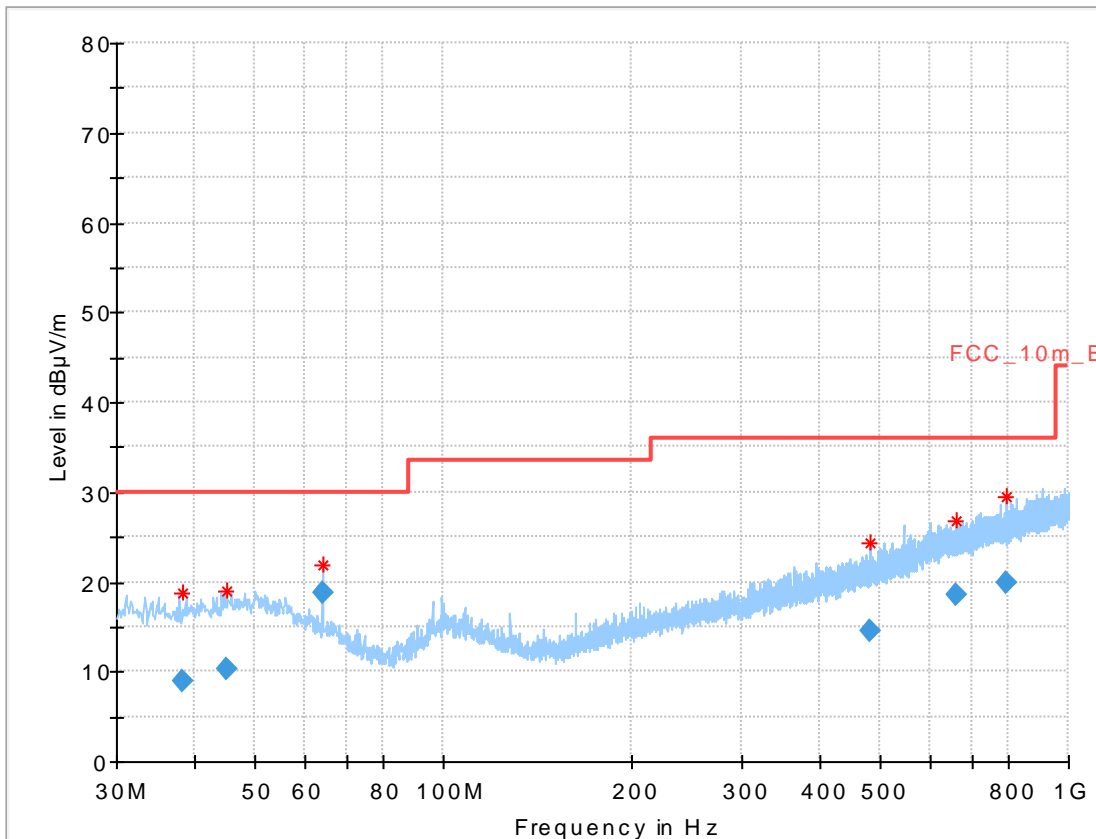

**Final Result**

Frequency (MHz)	QuasiPeak (dBµV/m)	Limit (dBµV/m)	Margin (dB)	Meas. Time (ms)	Bandwidth (kHz)	Height (cm)	Pol	Azimuth (deg)	Corr. (dB)
38.179	8.93	30.0	21.07	1000	120	98.0	V	286.0	13.0
45.187	10.37	30.0	19.63	1000	120	101.0	H	328.0	13.6
64.013	18.83	30.0	11.17	1000	120	170.0	V	87.0	11.0
480.507	14.43	36.0	21.57	1000	120	170.0	H	0.0	18.3
661.635	18.45	36.0	17.55	1000	120	170.0	V	66.0	21.2
797.259	19.97	36.0	16.03	1000	120	170.0	V	308.0	22.7

**Plot No. 11: 30 MHz to 1 GHz, horizontal / vertical polarization, mid frequency**

EUT: SRR3-B  
 Serial number: 00217B240002F  
 Test description: FCC part 15 class B @ 10 m  
 Operating condition: tx center  
 Operator name: Wolsdorfer  
 Comment: DC 13.5V

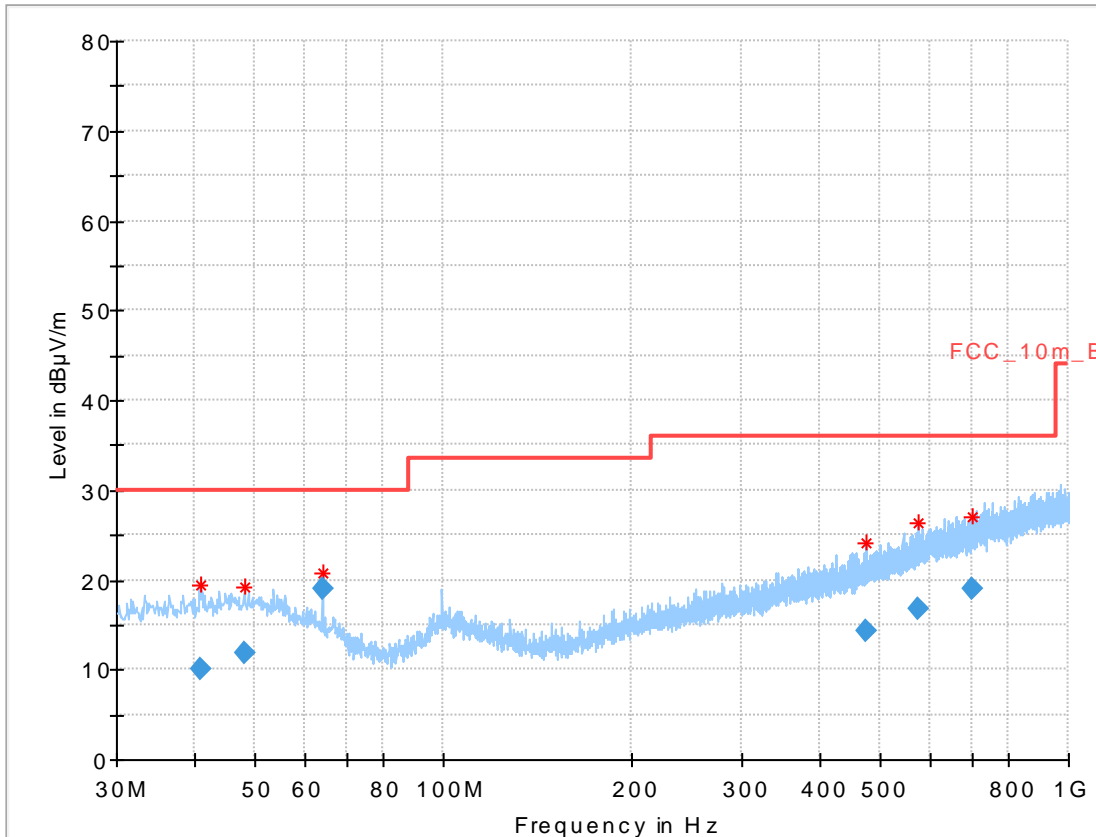

**Final Result**

Frequency (MHz)	QuasiPeak (dBµV/m)	Limit (dBµV/m)	Margin (dB)	Meas. Time (ms)	Bandwidth (kHz)	Height (cm)	Pol	Azimuth (deg)	Corr. (dB)
40.982	10.04	30.0	19.96	1000	120	101.0	H	333.0	13.3
48.003	11.94	30.0	18.06	1000	120	101.0	V	118.0	13.7
64.015	18.92	30.0	11.08	1000	120	170.0	V	36.0	11.0
475.317	14.34	36.0	21.66	1000	120	170.0	H	227.0	18.2
575.457	16.79	36.0	19.21	1000	120	170.0	V	29.0	20.1
702.593	19.00	36.0	17.00	1000	120	101.0	H	-9.0	21.6

**Plot No. 12: 30 MHz to 1 GHz, horizontal / vertical polarization, high frequency**

EUT: SRR3-B  
 Serial number: 00217B240002F  
 Test description: FCC part 15 class B @ 10 m  
 Operating condition: tx uppest  
 Operator name: Wolsdorfer  
 Comment: DC 13.5V

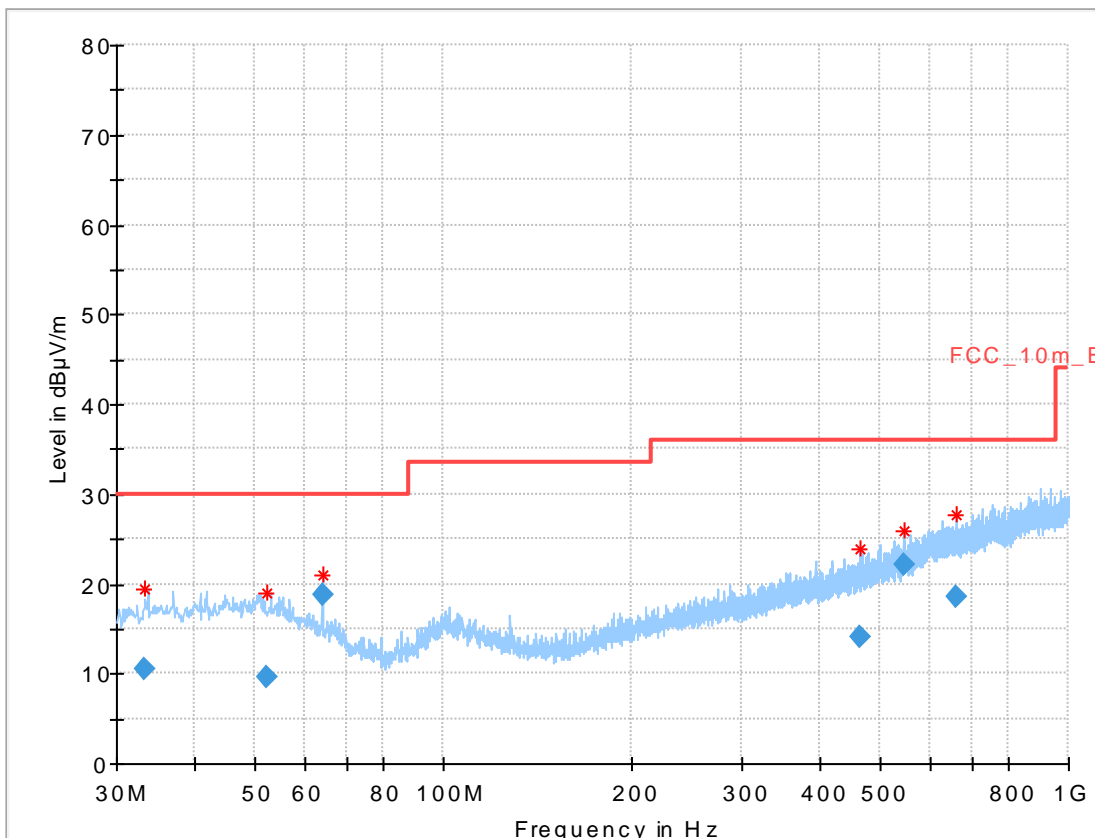

**Final Result**

Frequency (MHz)	QuasiPeak (dBµV/m)	Limit (dBµV/m)	Margin (dB)	Meas. Time (ms)	Bandwidth (kHz)	Height (cm)	Pol	Azimuth (deg)	Corr. (dB)
33.346	10.43	30.0	19.57	1000	120	170.0	V	329.0	12.4
52.317	9.68	30.0	20.32	1000	120	101.0	V	164.0	13.4
64.001	18.84	30.0	11.16	1000	120	170.0	V	13.0	11.0
463.926	14.07	36.0	21.93	1000	120	170.0	H	-8.0	18.0
544.016	22.14	36.0	13.86	1000	120	170.0	V	103.0	19.3
659.844	18.50	36.0	17.50	1000	120	101.0	H	5.0	21.2

**Plot No. 13: 1.0 GHz to 18.0 GHz, horizontal / vertical polarization, low / mid / high frequency**

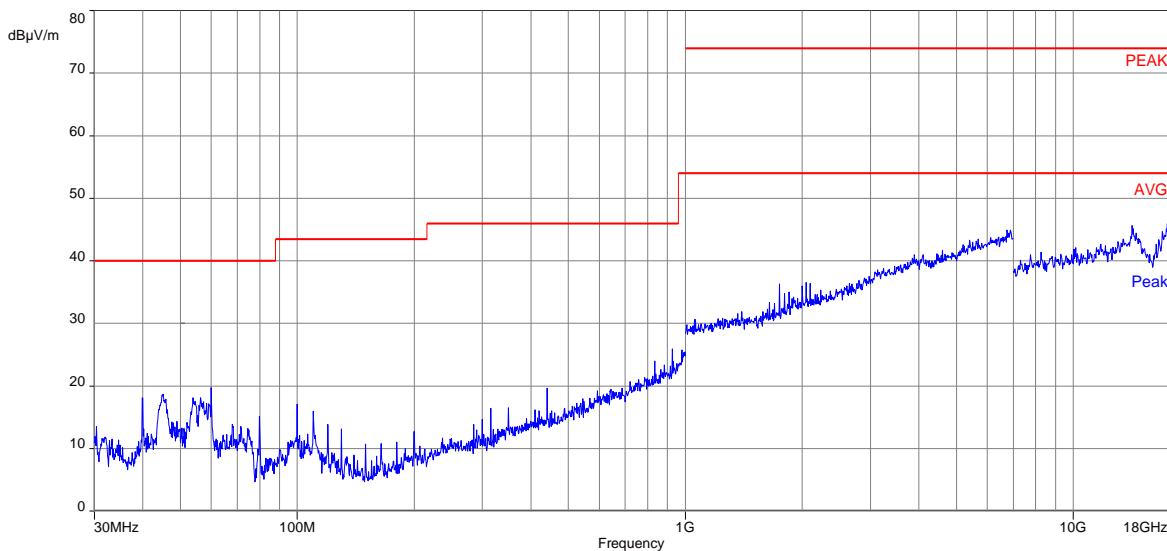
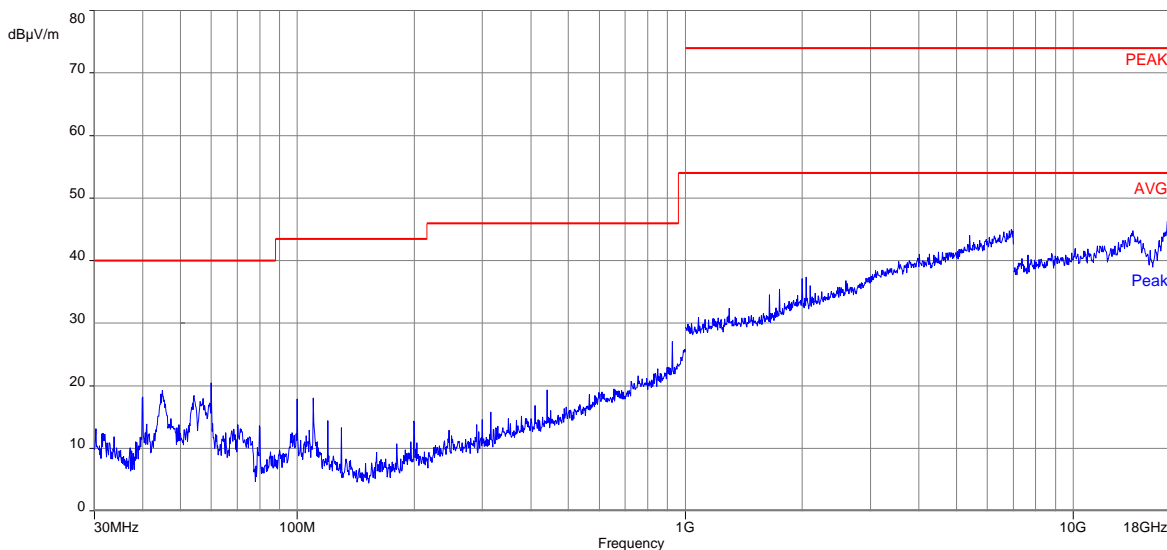
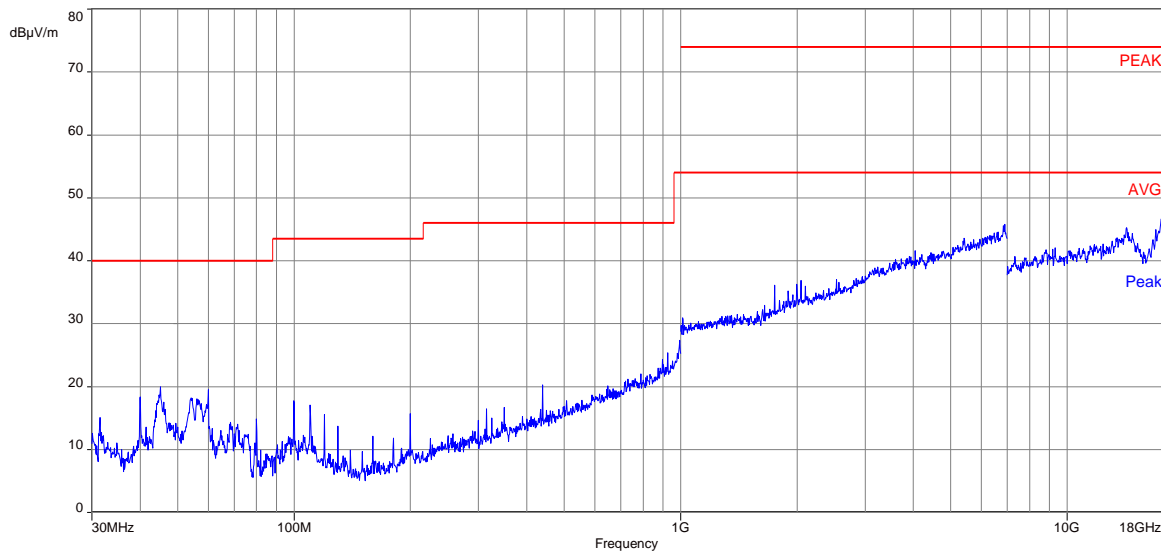



**Plot No. 14: 18.0 GHz to 24.0 GHz, horizontal / vertical polarization, low / mid / high frequency**

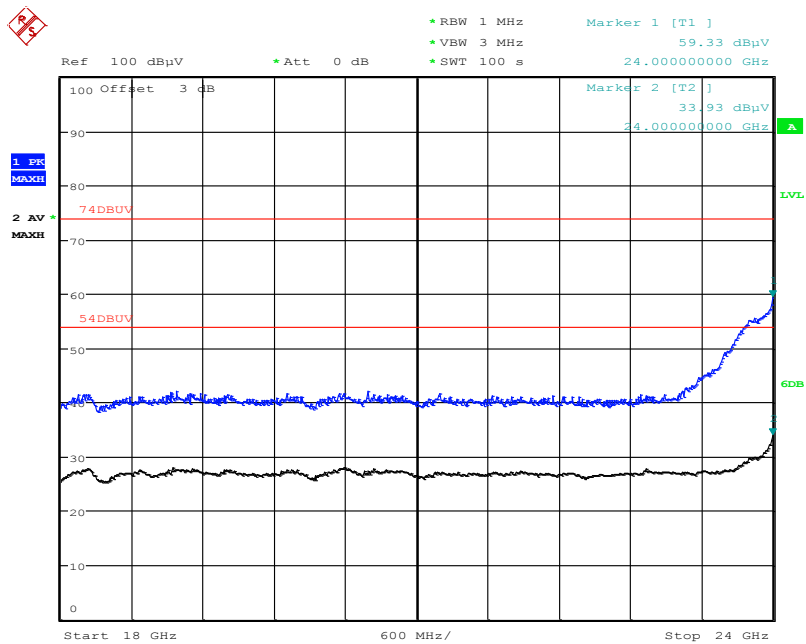

Date: 7.DEC.2017 11:44:58

**Plot No. 15: Band Edge 24.0 GHz, horizontal / vertical polarization, low / mid / high frequency**

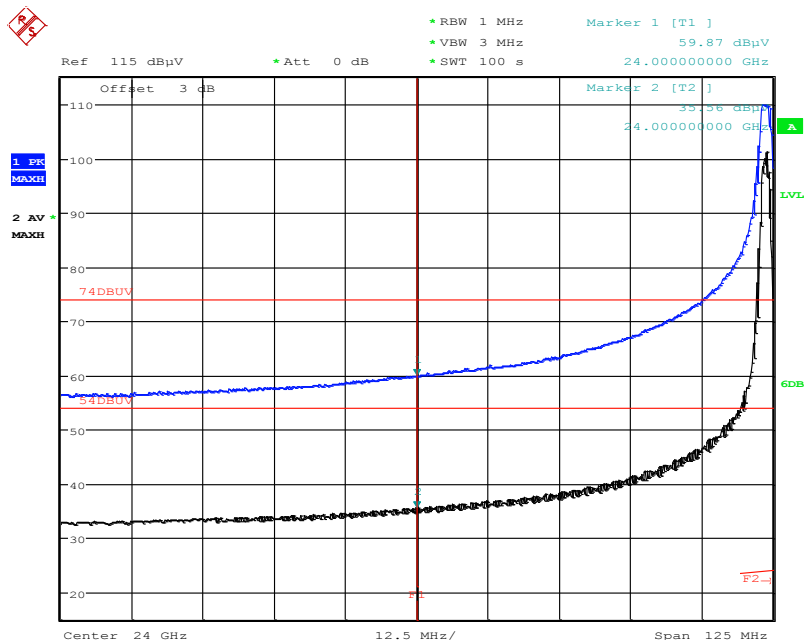

Date: 7.DEC.2017 11:03:48

**Plot No. 16: Band Edge 24.0 GHz, horizontal / vertical polarization, normal operation mode**

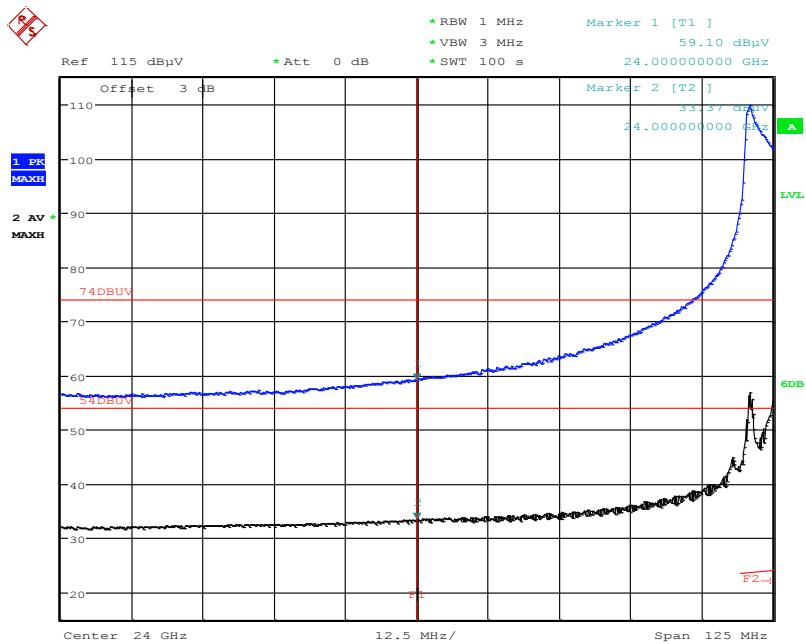

Date: 7.DEC.2017 17:19:58

**Plot No. 17: Band Edge 24.25 GHz, horizontal / vertical polarization, low / mid / high frequency**

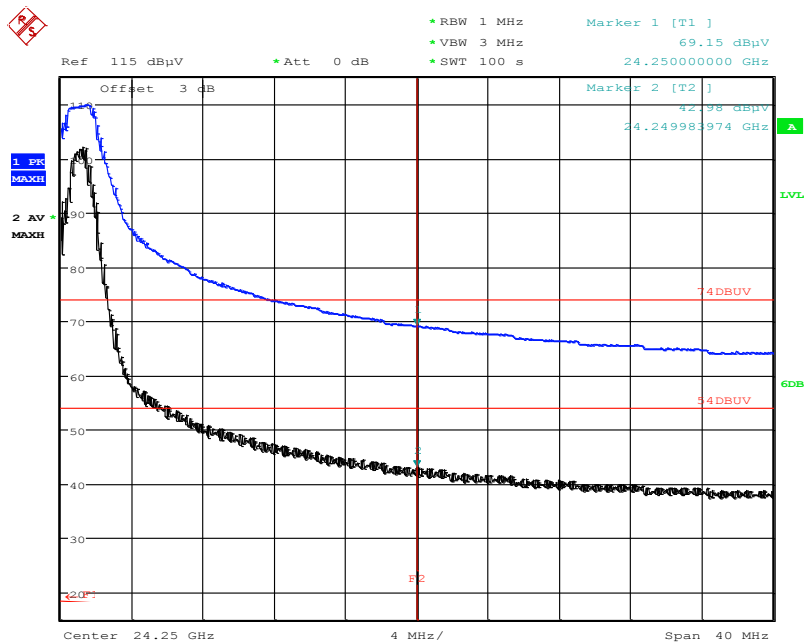

Date: 7.DEC.2017 11:00:29

**Plot No. 18: Band Edge 24.25 GHz, horizontal / vertical polarization, normal operation mode**

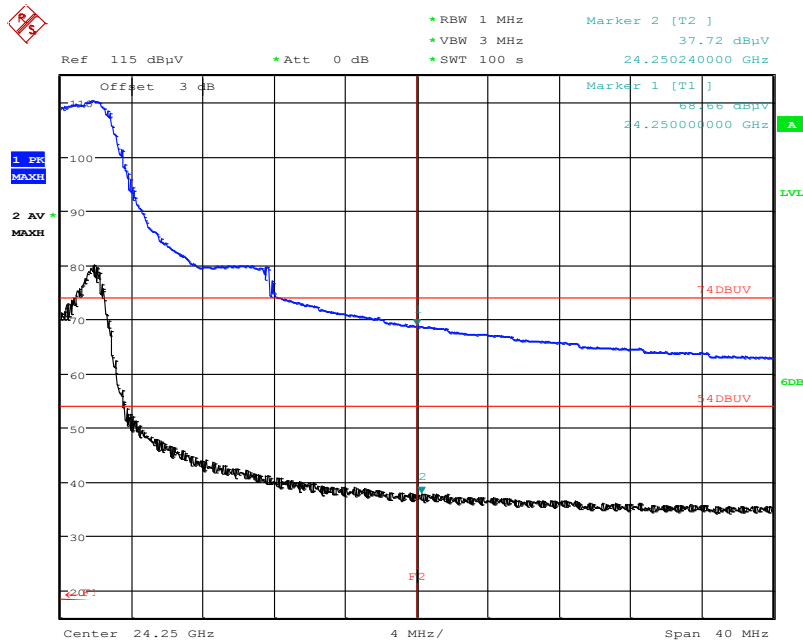

Date: 7.DEC.2017 17:23:01

**Plot No. 19: 24.25 GHz to 26.0 GHz, horizontal / vertical polarization, low / mid / high frequency**

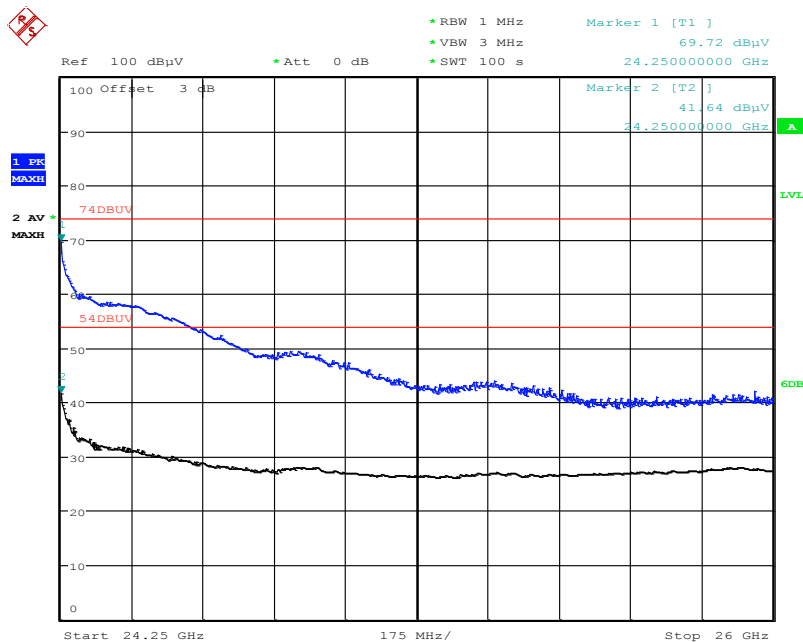

Date: 7.DEC.2017 11:51:19

**Plot No. 20: 26.0 GHz to 40.0 GHz, horizontal / vertical polarization, low / mid / high frequency**

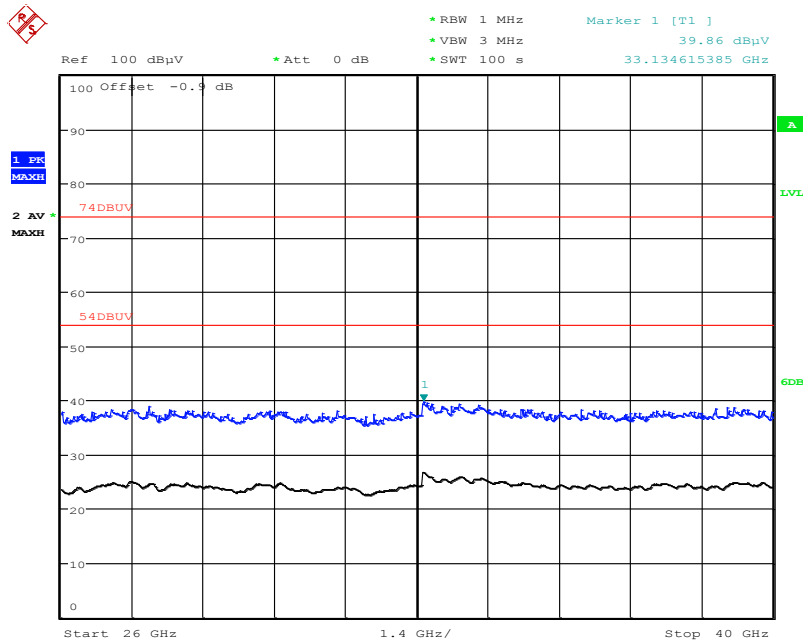

Date: 7.DEC.2017 12:22:50

**Plot No. 21: 40.0 GHz to 50.0 GHz, horizontal / vertical polarization, low / mid / high frequency**

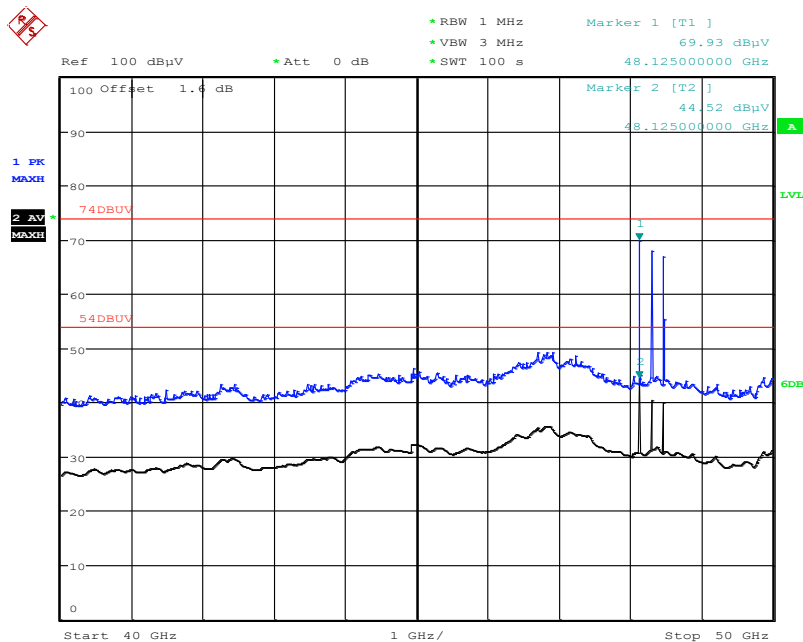

Date: 7.DEC.2017 13:40:14

**Plot No. 22: 48.1 to 48.5 GHz, horizontal / vertical polarization, low / mid / high frequency, PEAK**

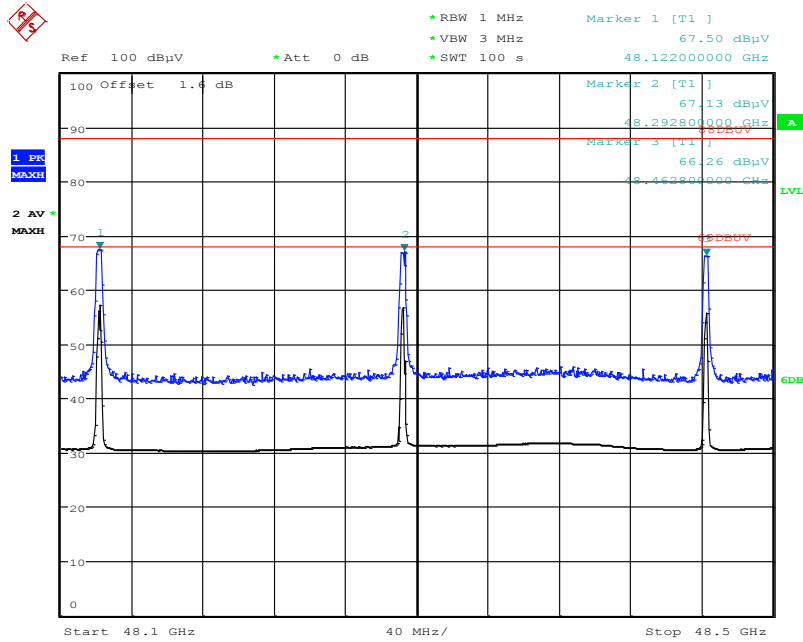

Date: 7.DEC.2017 14:37:29

**Plot No. 23: 48.1 to 48.5 GHz, horizontal / vertical polarization, low / mid / high frequency, AVG**

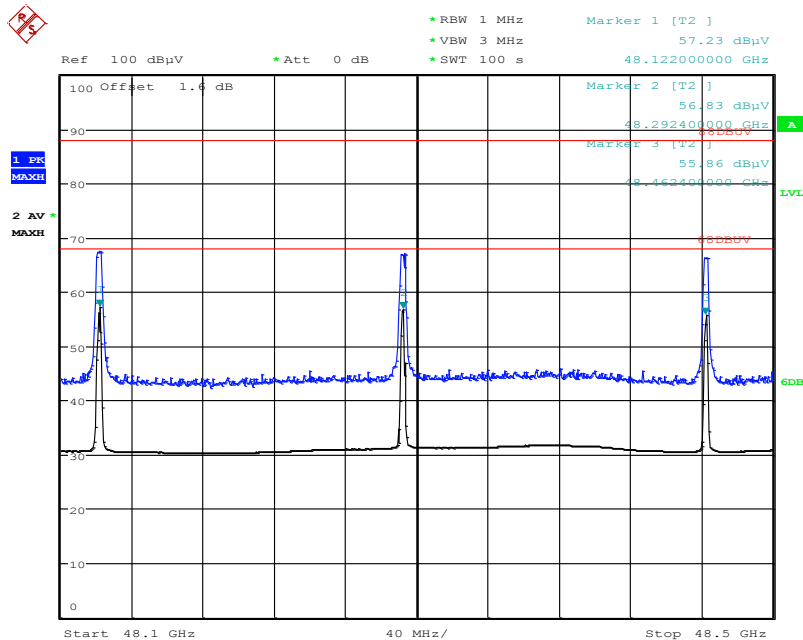

Date: 7.DEC.2017 14:35:29

**Plot No. 24: 50.0 GHz to 75.0 GHz, horizontal / vertical polarization, low / mid / high frequency**

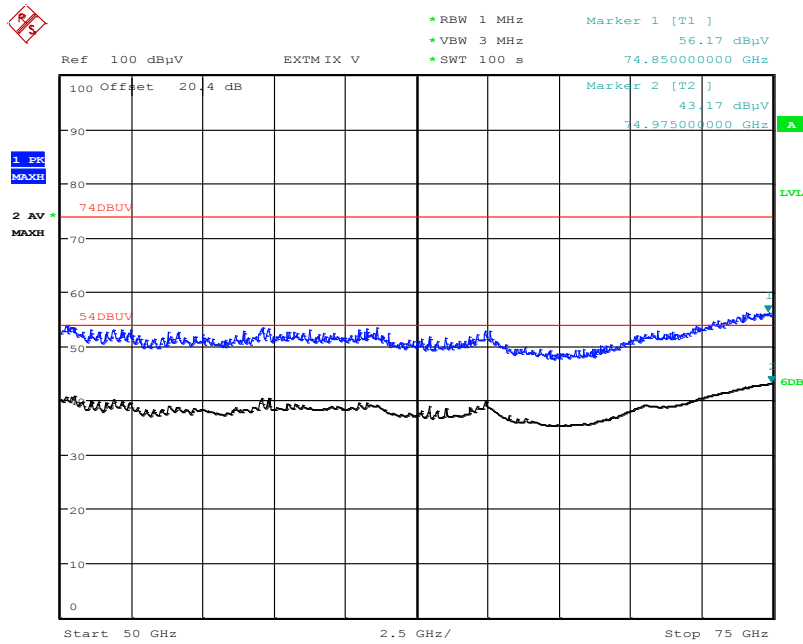

Date: 9.DEC.2017 11:19:01

**Plot No. 25: 75.0 GHz to 110 GHz, horizontal / vertical polarization, low / mid / high frequency**

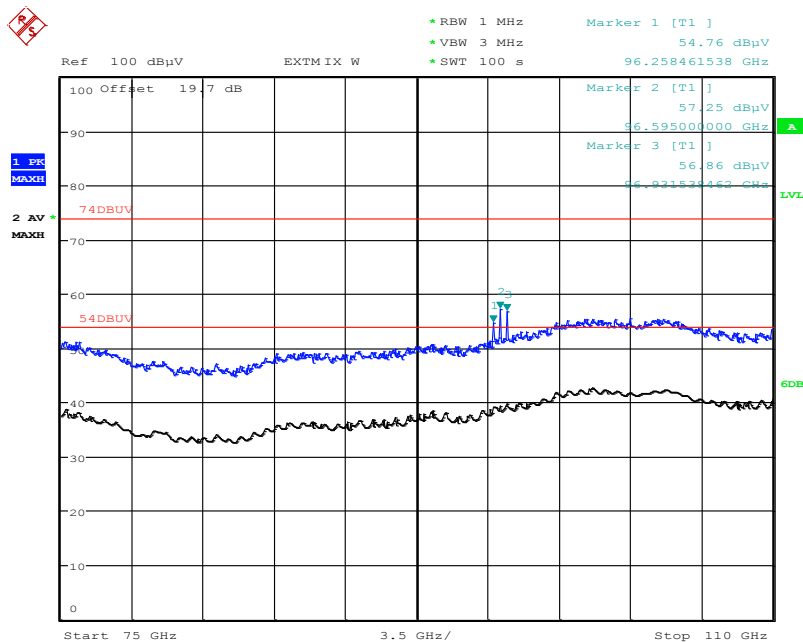

Date: 7.DEC.2017 15:57:18

**Plot No. 26: 96.6 GHz to 97.4 GHz, horizontal / vertical polarization, low / mid / high frequency, PEAK**

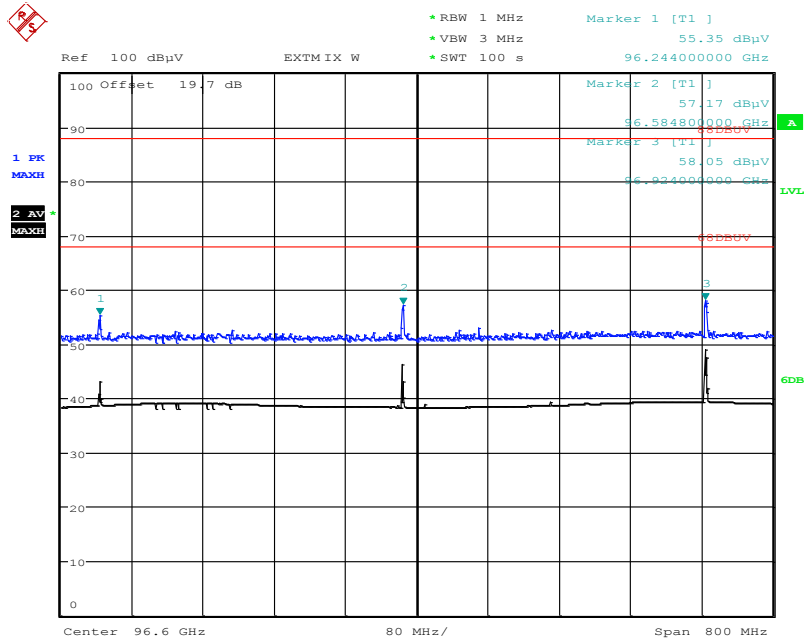

Date: 7.DEC.2017 16:15:26

**Plot No. 27: 96.6 GHz to 97.4 GHz, horizontal / vertical polarization, low / mid / high frequency, AVG**

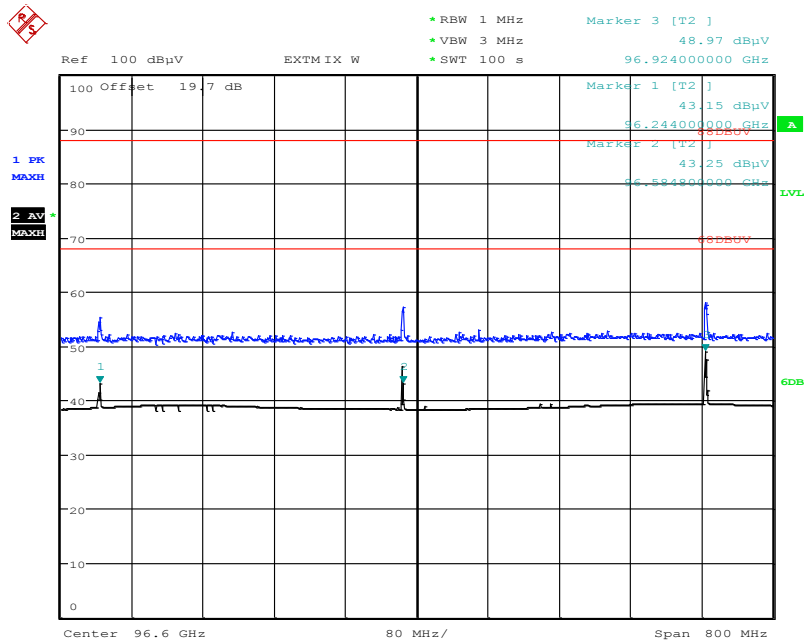

Date: 7.DEC.2017 16:17:39

## 10 Glossary

<b>EUT</b>	Equipment under test
<b>DUT</b>	Device under test
<b>UUT</b>	Unit under test
<b>GUE</b>	GNSS User Equipment
<b>ETSI</b>	European Telecommunications Standards Institute
<b>EN</b>	European Standard
<b>FCC</b>	Federal Communications Commission
<b>FCC ID</b>	Company Identifier at FCC
<b>IC</b>	Industry Canada
<b>PMN</b>	Product marketing name
<b>HMN</b>	Host marketing name
<b>HVIN</b>	Hardware version identification number
<b>FVIN</b>	Firmware version identification number
<b>EMC</b>	Electromagnetic Compatibility
<b>HW</b>	Hardware
<b>SW</b>	Software
<b>Inv. No.</b>	Inventory number
<b>S/N or SN</b>	Serial number
<b>C</b>	Compliant
<b>NC</b>	Not compliant
<b>NA</b>	Not applicable
<b>NP</b>	Not performed
<b>PP</b>	Positive peak
<b>QP</b>	Quasi peak
<b>AVG</b>	Average
<b>OC</b>	Operating channel
<b>OCW</b>	Operating channel bandwidth
<b>OBW</b>	Occupied bandwidth
<b>OOB</b>	Out of band
<b>DFS</b>	Dynamic frequency selection
<b>CAC</b>	Channel availability check
<b>OP</b>	Occupancy period
<b>NOP</b>	Non occupancy period
<b>DC</b>	Duty cycle
<b>PER</b>	Packet error rate
<b>CW</b>	Clean wave
<b>MC</b>	Modulated carrier
<b>WLAN</b>	Wireless local area network
<b>RLAN</b>	Radio local area network
<b>DSSS</b>	Dynamic sequence spread spectrum
<b>OFDM</b>	Orthogonal frequency division multiplexing
<b>FHSS</b>	Frequency hopping spread spectrum
<b>GNSS</b>	Global Navigation Satellite System
<b>C/N<sub>0</sub></b>	Carrier to noise-density ratio, expressed in dB-Hz



## 11 Document history

Version	Applied changes	Date of release
-/-	Initial release – DRAFT	2017-12-09
	Editorial changes based on applicant's remarks	2017-12-14
-A	Editorial changes based on applicant's remarks	2018-02-07
-B	Page 19, calculated AVG value for normal operation mode added as per customer request	2018-09-19
-C	editorial changes based on applicant's remarks, e.g. description for amplitude offset	2019-05-29

## 12 Accreditation Certificate

first page	last page
 <p>Deutsche Akkreditierungsstelle GmbH</p> <p>Entrusted according to Section 8 subsection 1 AkkStelleG in connection with Section 1 subsection 1 AkkStelleGBV Signatory to the Multilateral Agreements of EA, ILAC and IAF for Mutual Recognition</p> <p><b>Accreditation</b> </p> <p>The Deutsche Akkreditierungsstelle GmbH attests that the testing laboratory <b>CTC advanced GmbH</b> Untertürkheimer Straße 6-10, 66117 Saarbrücken</p> <p>is competent under the terms of DIN EN ISO/IEC 17025:2005 to carry out tests in the following fields: <b>Telecommunication</b></p> <p>The accreditation certificate shall only apply in connection with the notice of accreditation of 02.06.2017 with the accreditation number D-PL-12076-01 and is valid until 21.04.2021. It comprises the cover sheet, the reverse side of the cover sheet and the following annex with a total of 43 pages.</p> <p>Registration number of the certificate: D-PL-12076-01-03</p> <p>Frankfurt, 02.06.2017  Digital: (FN) Head of Division See notes overleaf.</p>	<p>Deutsche Akkreditierungsstelle GmbH</p> <p>Office Berlin Spittelmarkt 10 10117 Berlin</p> <p>Office Frankfurt am Main Europa-Allee 52 60327 Frankfurt am Main</p> <p>Office Braunschweig Bundesallee 100 38116 Braunschweig</p> <p>The publication of extracts of the accreditation certificate is subject to the prior written approval by Deutsche Akkreditierungsstelle GmbH (DAkKS). Exempted is the unchanged form of separate disseminations of the cover sheet by the conformity assessment body mentioned overleaf.</p> <p>No impression shall be made that the accreditation also extends to fields beyond the scope of accreditation attested by DAkKS.</p> <p>The accreditation was granted pursuant to the Act on the Accreditation Body (AkkStelleG) of 31 July 2009 (Federal Law Gazette I p. 2625) and the Regulation (EC) No 765/2008 of the European Parliament and of the Council of 9 July 2008 setting out the requirements for accreditation and market surveillance relating to the marketing of products (Official Journal of the European Union L 218 of 9 July 2008, p. 30). DAkKS is a signatory to the Multilateral Agreements for Mutual Recognition of the European co-operation for Accreditation (EA), International Accreditation Forum (IAF) and International Laboratory Accreditation Cooperation (ILAC). The signatories to these agreements recognise each other's accreditations.</p> <p>The up-to-date state of membership can be retrieved from the following websites: EA: <a href="http://www.european-accreditation.org">www.european-accreditation.org</a> ILAC: <a href="http://www.ilac.org">www.ilac.org</a> IAF: <a href="http://www.iaf.nu">www.iaf.nu</a></p>

**Note: The current certificate annex is published on the website (link see below) of the Accreditation Body DAkKS or may be received by CTC advanced GmbH on request**

<http://www.dakks.de/as/ast/d/D-PL-12076-01-03.pdf>