

Thank you for your selection of the 905 module for your telemetry needs. We trust it will give you many years of valuable service.

ATTENTION!

Incorrect termination of supply wires may cause internal damage and will void warranty.

To ensure your 905 enjoys a long life,
double check ALL your connections with
the user's manual
before turning the power on.

FCC Notice:

This user's manual is for the ELPRO 905 series radio telemetry module. This device complies with Part 15.247 of the FCC Rules.

Operation is subject to the following two conditions:

- 1) This device may not cause harmful interference and
- 2) This device must accept any interference received, including interference that may cause undesired operation.

This device must be operated as supplied by ELPRO Technologies Pty Ltd. Any changes or modifications made to the device without the written consent of ELPRO Technologies Pty. Ltd. May void the user's authority to operate the device.

End user products that have this device embedded must be supplied with non-standard antenna connectors, and antennas available from vendors specified by ELPRO Technologies. Please contact ELPRO Technologies for end user antenna and connector recommendations.

Notices:

Safety:

Exposure to RF energy is an important safety consideration. The FCC has adopted a safety standard for human exposure to radio frequency electromagnetic energy emitted by FCC regulated equipment as a result of its actions in General Docket 79-144 on March 13, 1996.

CAUTION:

To comply with FCC RF Exposure requirements in section 1.1310 of the FCC Rules, antennas used with this device must be installed to provide a separation distance of at least 20 cm from all persons to satisfy RF exposure compliance.

DO NOT:

- operate the transmitter when someone is within 20 cm of the antenna
- operate the transmitter unless all RF connectors are secure and any open connectors are properly terminated.
- operate the equipment near electrical blasting caps or in an explosive atmosphere

All equipment must be properly grounded for safe operations. All equipment should be serviced only by a qualified technician.

How to Use This Manual

To receive the maximum benefit from your 905 product, please read the **Introduction**, **Installation** and **Operation** chapters of this manual thoroughly before putting the 905 to work.

Chapter Four **Configuration** explains how to configure the modules using the Configuration Software available. For configuration using the on-board switches, refer to the separate 905 **Switch Configuration Manual**.

Chapter Five **Specifications** details the features of the product and lists the standards to which the product is approved.

Chapter Six **Troubleshooting** will help if your system has problems and Chapter Seven specifies the **Warranty and Service** conditions.

The foldout sheet 905 *Installation Guide* is an installation drawing appropriate for most applications.

Warning !

1. For 905U modules, a radio licence is not required in most countries, provided the module is installed using the aerial and equipment configuration described in the 905 *Installation Guide*. Check with your local 905 distributor for further information on regulations.
2. For 905U modules, operation is authorised by the radio frequency regulatory authority in your country on a non-protection basis. Although all care is taken in the design of these units, there is no responsibility taken for sources of external interference. The 905 intelligent communications protocol aims to correct communication errors due to interference and to retransmit the required output conditions regularly. However some delay in the operation of outputs may occur during periods of interference. Systems should be designed to be tolerant of these delays.
3. To avoid the risk of electrocution, the aerial, aerial cable, serial cables and all terminals of the 905 module should be electrically protected. To provide maximum surge and lightning protection, the module should be connected to a suitable earth and the aerial, aerial cable, serial cables and the module should be installed as recommended in the Installation Guide.
4. To avoid accidents during maintenance or adjustment of remotely controlled equipment, all equipment should be first disconnected from the 905 module during these adjustments. Equipment should carry clear markings to indicate remote or automatic operation. E.g. "This equipment is remotely controlled and may start without warning. Isolate at the switchboard before attempting adjustments."
5. The 905 module is not suitable for use in explosive environments without additional protection.

CONTENTS

CHAPTER ONE INTRODUCTION	7
1.1 GENERAL	7
CHAPTER TWO INSTALLATION	10
2.1 GENERAL	10
10101010POWER SUPPLY	10
2.2.1 AC Supply.....	11
2.2.2 DC Supply	11
2.2.3 Solar Supply	12
2.2.4 Multiple Modules.....	12
2.2.5 24V Regulated Supply	13
2.3 INPUT / OUTPUT	13
2.3.1 Digital Inputs (Error! Bookmark not defined.-1 and Error! Bookmark not defined.-2).....	13
2.3.2 Digital Outputs (Error! Bookmark not defined.-1).....	14
2.3.3 Digital Outputs (Error! Bookmark not defined.-2 and Error! Bookmark not defined.-3).....	16
2.3.4 Analogue Inputs (Error! Bookmark not defined.-1 and Error! Bookmark not defined.-2).....	16
2.3.5 Analogue Outputs (Error! Bookmark not defined.-1 and Error! Bookmark not defined.-3).....	17
2.3.6 Pulse Input (Error! Bookmark not defined.-1).....	17
2.3.7 Pulse Inputs (Error! Bookmark not defined.-2).....	17
2.3.8 Pulse Output (Error! Bookmark not defined.-1).....	18
2.3.9 Pulse Output (Error! Bookmark not defined.-3).....	18
2.3.10 RS232 Serial Port.....	18
2.3.11 RS485 Serial Port.....	19
CHAPTER THREE	OPERATION
22	
3.1 POWER-UP AND NORMAL OPERATION.....	22
3.1.1 Communications.....	22
3.1.2 Change of state conditions.....	24
3.1.3 Analogue Set-points.....	26
3.1.4 Start-up Poll	27
3.1.5 Communications Failure (CF).....	27
3.1.6 Resetting Outputs.....	27
3.2 SYSTEM DESIGN TIPS.....	27
3.2.1 System Dynamics.....	27
3.2.2 Radio Channel Capacity.....	28
3.2.3 Radio Path Reliability.....	28
3.2.4 Design for Failures	29
CHAPTER FOUR	CONFIGURATION
30	
4.1 INTRODUCTION	30
4.2 EASY CONFIGURATION USING DEFAULT SETTINGS	31
4.3 ERROR! BOOKMARK NOT DEFINED. CONFIGURATION SOFTWARE	33
4.3.1 Hardware Requirements.....	33
4.3.2 Installation.....	34
4.3.3 Software Operation	34
4.3.4 Changing User Options.....	38
4.3.5 Programming / Downloading Configuration.....	40
CHAPTER FIVE SPECIFICATIONS	42
CHAPTER SIX	TROUBLESHOOTING

45

6.1 DIAGNOSTICS CHART45

6.2 SELF TEST FUNCTIONS45

 6.2.1 *Input to Output Reflection (105-1 only)*..... 45

 6.2.2 *Radio Testing using Tone Reversals* 46

 6.2.3 *Diagnostics menu*..... 46

CHAPTER SEVEN..... WARRANTY & SERVICE

52

APPENDIX A SYSTEM EXAMPLE..... 53

Chapter One

INTRODUCTION

1.1

General

The 905 range of telemetry modules has been designed to provide standard “off-the-shelf” telemetry functions, for an economical price. *Telemetry* is the transmission of signals over a long distance via a medium such as radio or twisted-pair wire. Although the 905 is intended to be simple in its application, it also provides many sophisticated features. This manual should be read carefully to ensure that the modules are configured and installed to give reliable performance.

The unit can monitor and control the following types of signals:

Digital on/off signals

Example outputs - motor run, siren on

Example inputs - motor fault, tank overflow, intruder alarm

Analogue continuously variable signals (0-20mA)

Example outputs - tank level indication, required motor speed

Example inputs - measured tank level, actual motor speed

Pulse frequency signals

Examples - electricity metering, fluid flow

Internal Status signals

Examples - analogue battery voltage, power status, solar panel status and low battery status.

The unit will monitor the input signals and transmit the signal information by radio or RS485 twisted pair to another 905 module. At the remote unit, the signals will be reproduced as digital, analogue or pulse output signals. The 905 also provides analogue set points, so that a digital output may be configured to turn on and off depending on the value of an analogue input. The pulse I/O transmits an accumulated value and the pulses are reliably recreated at the remote unit regardless of ‘missed’ transmissions. The actual pulse rate is also calculated and is available as a remote analogue output.

This manual covers the 905U and 105S modules. We have provided a summary on all products available in the 905 telemetry range, below.

- **905U-1, 905U-2 and 905U-3** modules have UHF radio **and** serial communications. The modules differ only in their input/output (I/O) design, and are compatible, i.e. they can be used to communicate signals to each other in the same network.
- **105S-1, 105S-2 and 105S-3** modules have **only** serial communications. All other specifications are as per the 905U-1, 2 & 3 modules. The 105S modules are compatible with 905U modules.
- **105M-1, 105M-2 and 105M-3** modules are for interfacing to MAP27 trunked radio systems.

These modules can transmit I/O messages hundreds of kilometres via the trunked radio system. 105M-1, 2 and 3 modules differ only in their input/output (I/O) design, and can interface to 105U and 105S modules. For more information, refer to the **105M User Manual**.

- The 905U-C module provides an interface between host devices such as PLC's or SCADA computers, and a radio telemetry system comprising 905U and 105S radio telemetry modules. The 905U-C allows 905U/105S modules to act as remote wireless I/O for the host devices. For more information, refer to the **905U-C User Manual**.

Product naming convention:

1 0 5 a - x

where a is:

U = UHF radio + RS232/RS485 serial S = RS232/RS485 serial only

M = MAP27 trunked radio interface

and x is:

1 = Input / Output module

2 = Input module (includes one output)

3 = Output module

C= Interface module

	905U-1	105S-1	905U-2	105S-2	905U-3	105S-3
Radio	✓		✓		✓	
Serial	✓	✓	✓	✓	✓	✓
Digital Inputs (DI)		4		4		
Digital Outputs (DO)		4 (relay)		1 (FET)		8 (FET)
Analogue Inputs (AI)		2 (4-20mA)		6 (0-20mA)		
Analogue Outputs (AO)		2 (4-20mA)				8 (0-20mA)
Pulse Inputs (PI)		1 (100Hz)		4 (1x1KHz, 3x100Hz)		
Pulse Outputs (PO)		1 (100Hz)				4 (100 Hz)
Comments		PI is DI 1. PO is separate to DO.		PI's are the same as DI's.		PO's are the same as DO's (DO 1-4).

The module includes power supply, microprocessor controller, input/output circuits, RS485/232 serial port, and a UHF radio transceiver - no external electronics are required. The 905U version has both radio and serial port communications. The 105S version does not have a radio and has only serial communications. The 905U radio frequency has been selected to meet the requirements

of unlicensed operation for remote monitoring and control of equipment. That is, a radio licence is not required for the 905 modules in many countries. See Chapter Five **Specifications** for details.

Input signals connected to a 905 module are transmitted to another 905 module and appear as output signals. These input signals may also be configured to appear as “inverted” signals on the output. A transmission occurs whenever a "change-of-state" occurs on an input signal. A "change-of-state" of a digital or digital internal input is a change from "off" to "on" or vice-versa. A "change-of-state" for an analogue input, internal analogue input or pulse input rate is a change in value of the signal of 3% (configurable from 0.8 to 50 %).

In addition to change-of-state messages, update messages are automatically transmitted on a regular basis. The time period may be configured by the user for each input. This update ensures the integrity of the system.

Pulse inputs are accumulated as a pulse count and the accumulated pulse count is transmitted regularly according to the configured update time.

The 905 modules transmit the input/output data as a data frame using radio or serial RS485 as the communications medium. The data frame includes the "address" of the transmitting 905 module and the receiving 905 module, so that each transmitted message is acted on only by the correct receiving unit. Each transmitted message also includes error checking to ensure that no corruption of the data frame has occurred due to noise or interference. The 905 module with the correct receiving "address" will acknowledge the message with a return transmission. If the original module does not receive a correct acknowledgement to a transmission, it will retry up to five times before setting the communications fail status of that path. In critical paths, this status can be reflected on an output on the module for alert purposes. The module will continue to try to establish communications and retry, if required, each time an update or change-of-state occurs.

A 905 telemetry system may be a complex network or a simple pair of modules. An easy-to-use configuration procedure allows the user to specify any output destination for each input.

The maximum number of modules in one system is 95 modules communicating by radio. Each of these modules may have up to 31 other modules connected by RS485 twisted pair. Modules may communicate by radio only, by RS485 only or by both RS485 and radio. Any input signal at any module may be configured to appear at any output on any module in the entire system.

Modules can be used as repeaters to re-transmit messages on to the destination module. Repeaters can repeat messages on the radio channel, or from the radio channel to the serial channel (and serial to radio). Up to five repeater addresses may be configured for each input-to-output link.

The units may be configured using switches under the plastic cover on the front of the unit or by using a PC connected to the RS232 port. The default configuration is defined in Section 4.2 **Easy Configuration Using Default Settings**, and software configuration is defined in Section 4.2 **905 Configuration Software**. Several **standard** configurations are also available. These are described in the separate 905 **Switch Configuration Manual**, available from your 905 distributor.

Chapter Two

INSTALLATION

2.1

General

The 905 module is housed in a rugged aluminium case, suitable for DIN-rail mounting. Terminals are suitable for cables up to 2.5 sqmm in size.

Normal 110/220/240V mains supply should not be connected to any input terminal of the 905 module. Refer to Section 2.3 **Power Supply**.

Before installing a new system, it is preferable to bench test the complete system. Configuration problems are easier to recognise when the system units are adjacent. Following installation, the most common problem is poor communications on the radio channel or the serial channel. For radio modules, problems are caused by incorrectly installed aerials, or radio interference on the same channel, or the radio path being inadequate. If the radio path is a problem (i.e. path too long, or obstructions in the way), then higher performance aerials or a higher mounting point for the aerial may fix the problem. Alternately, use an intermediate 905 module as a repeater.

For serial modules, poorly installed serial cable, or interference on the serial cable is a common problem.

The foldout sheet 905 Installation Guide provides an installation drawing appropriate to most applications. Further information is detailed below.

Each 905 module should be effectively earthed via a "GND" terminal on the 905 module - this is to ensure that the surge protection circuits inside the 905 module are effective.

2.2

Power Supply

The 905 power supply is a switch-mode design which will accept either AC or DC supply. The 905 module may also be powered from a solar panel without an external solar regulator.

The 905 module accepts supply voltages in the following ranges :

12 - 24 volts AC RMS or 15 - 30 volts DC at the "supply" terminals, or
10.8 -15 volts DC at the "battery" terminals.

2.2.1 AC Supply

The AC supply is connected to the "SUP1" and "SUP2" terminals as shown below.

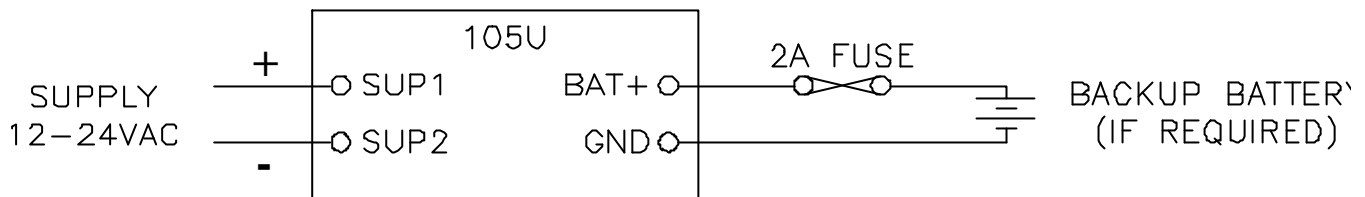

The AC supply should be "floating" relative to earth. A 220-240/16 VAC mains "plug-pack" is available for mains applications.

2.2.2 DC Supply

For DC supplies, the positive lead is connected to "SUP1" and the negative to "GND". The positive side of the supply **must not be connected to earth**. The DC supply may be a floating supply or negatively grounded.

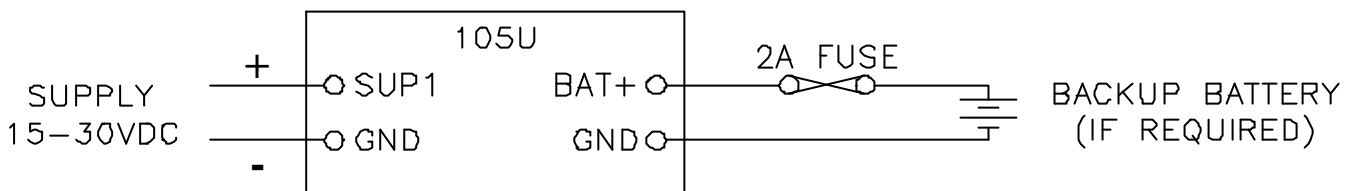

The 905 module may also be powered from an external 11 - 15 VDC battery supply without the need for a "normal" supply connected to "SUP1". This external battery supply is connected to "BAT+" and "GND" terminals. The positive lead of the external supply should be protected by a 2A fuse.

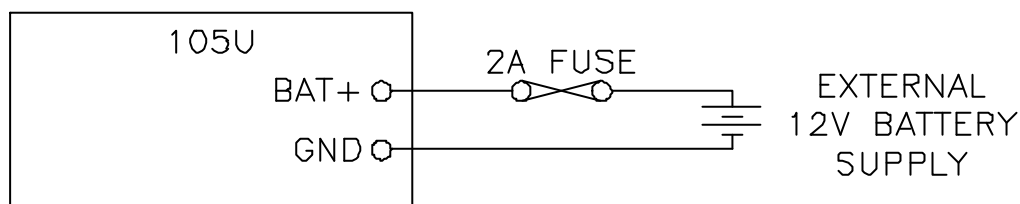

Upon failure of the normal supply, the 905 module may continue to operate for several hours from a backup battery. The 905 module includes battery charging circuits for charging up to a 12 AHr sealed lead acid battery. The battery is connected to the "BAT+" (positive) and "GND" (negative) terminals. The positive lead from the battery should be protected with a 2A fuse, installed as near to the battery terminal as possible. On return of main supply, the unit will switch back to mains operation, and recharge the battery. To provide adequate current to recharge the backup battery, an AC supply of 15V minimum or a DC supply of 17V minimum must be used. Typically, a 6 AHr battery will supply the 905 for 1 - 3 days, depending on I/O loads.

2.2.3 Solar Supply

The 905 power supply also includes a 12 V solar regulator for connecting 12V solar panels of up to 30W, and solar batteries of up to 100Ahr. The unit may not be powered from a solar panel without a battery. An 18W solar panel is sufficient for most solar applications. The size of the solar battery required depends on the I/O used. Batteries are sized for a number of sunless days with 50% battery capacity remaining as follows:

$$\text{No. of sunless days} = \frac{\text{Battery capacity (Ahr)} \times 0.5}{\text{Module load (A)} \times 1.2 \times 24}$$

The Module load depends on the I/O connected and can be calculated as follows:

$$\text{Module Load(A)} = 0.07 + (0.01 \times \text{No. of DI's}) + (0.025 \times \text{No. of DO's}) \\ + (2 \times \text{Analogue loop load}).$$

The analogue loop load is the total signal current for the AI's and AO's which are powered from the internal 24V supply. Externally powered loops are not included in this.

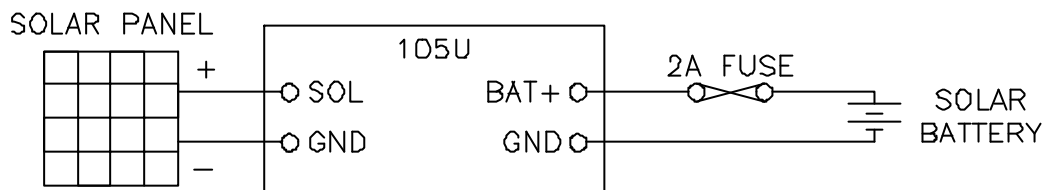

The solar panel is connected to the "SOL" (positive) and "GND" (negative) terminals and the battery connected to the "BAT+" (positive) and "GND" (negative) terminals. Solar panels must be installed and connected as per the panel manufacturer's instructions. The positive lead of the battery should be protected by a 2A fuse installed as near as possible to the battery terminal.

Where a solar panel larger than 30W is required, an external solar regulator should be used.

2.2.4 Multiple Modules

Where more than one module is installed at the one location, a shared power supply and battery may be used, provided the total load does not exceed the power supply.

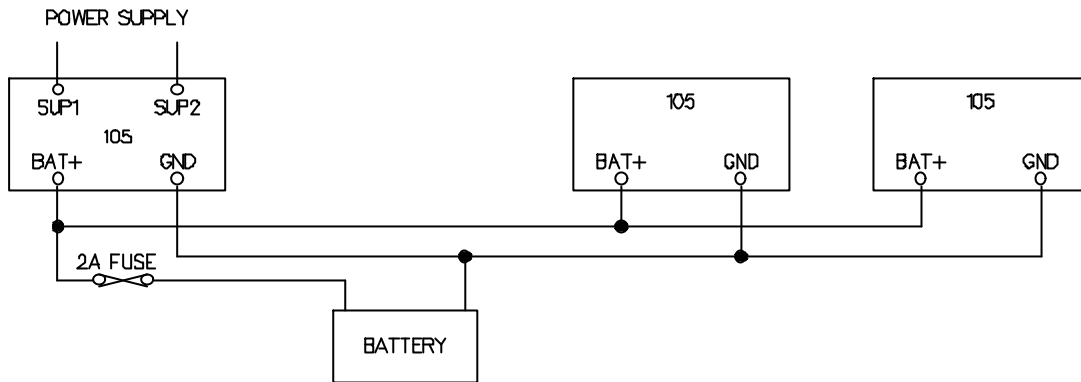

The internal power supply of the 905 module can supply a maximum 12V load of 700mA. In order to achieve this, the input power supply must be above 15VAC or 17VDC. Using these figures, it can be determined whether there is enough supply for more than one module - allow 100mA for recharging a battery.

For example, assume there is a 905U-01 module and a 105S-01 module at the same location. The total I/O at the location is 3 analogue inputs, 6 digital inputs and 4 digital outputs. The total load will be :-

TYPE OF LOAD	LOAD mA
905U-01 quiescent	70
105S-01 quiescent	45
6 DI @ 10 mA	60
3 AI @ 20mA x 2	120
4 DO @ 25mA	100
Battery charging	100
TOTAL	495

So both modules could be powered from one power supply and one battery, provided the external supply voltage is more than 15VAC or 17VDC.

2.2.5 24V Regulated Supply

Each 905 module provides a 24V DC regulated supply for analogue loop power. The supply is rated at 150mA, and should only be used for analogue loops.

2.4

Input / Output

2.4.1 Digital Inputs (905-1 and 905-2)

The 905-1 and 905-2 modules each provide four digital inputs with 5000 volt opto-isolation, suitable for voltage free contacts (such as mechanical switches) or NPN transistor devices (such as electronic proximity switches). Contact wetting current of approximately 5mA is provided to maintain reliable operation of driving relays.

Each digital input is connected between the appropriate "DI" terminal and common "COM". Each digital input circuit includes a LED indicator which is lit when the digital input is active, that is, when the input circuit is closed. Provided the resistance of the switching device is less than 200 ohms, the device will be able to activate the digital input.

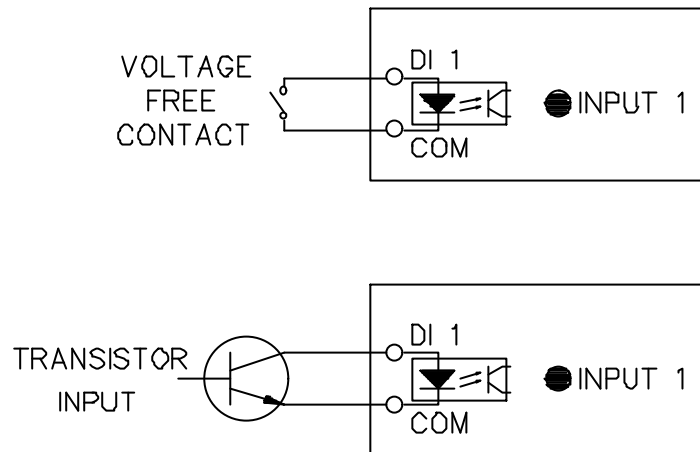

For pulse inputs, refer to Section 2.4.6.

2.4.2 Digital Outputs (905-1)

The 905-1 module provides four normally open voltage-free relay contacts, rated at AC3 250V/2A, 120V/5A ; AC1 - 250V/5A ; DC - 30V/2A, 20V/5A. These outputs may be used to directly control low-powered equipment, or to power larger relays for higher powered equipment. When driving inductive loads such as AC relays, good installation should include capacitors (e.g. 10nf 250V) across the external circuit to prevent arcing across the relay contacts. For DC inductive loads, flyback diodes should be used to drive DC relays.

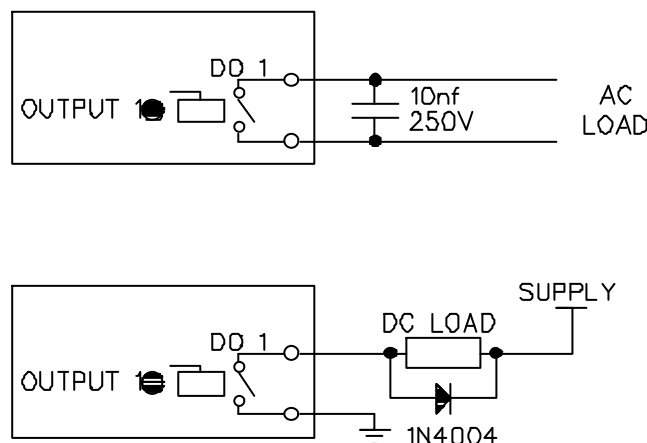

Digital outputs may be configured to individually turn off if no command message is received to that output for a certain period. This feature provides an intelligent watch dog for each output, so that a communications failure at a transmitting site causes the output to revert to a known state. See section 4.4 **Changing User Options** for further details.

The output circuit is connected to the appropriate pair of "DO" terminals. Each digital output circuit includes a LED indicator which is lit when the digital output is active.

2.4.3 Digital Outputs (905-2 and 905-3)

The digital outputs on the 905-2 and 905-3 modules are transistor switched DC signals, FET output to common rated at 30VDC 500 mA. The 905-2 provides one digital output and the 905-3 provides eight digital outputs. The first four DO's on the 905-3 module are also the pulse outputs - that is, the first four DO's can be either digital outputs or pulse outputs. The function of each of these outputs may be configured individually. For a description of pulse outputs, refer to Section 2.4.7.

Digital outputs may be configured to individually turn off if no command message is received to that output for a certain period. This feature provides an intelligent watch dog for each output, so that a communications failure at a transmitting site causes the output to revert to a known state. See Chapter 4 **Configuration** for further details.

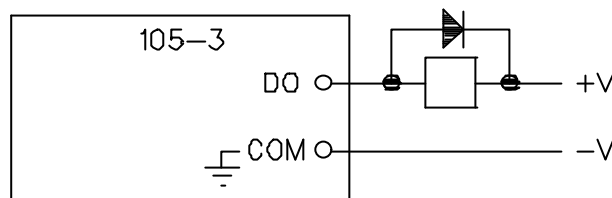

The output circuit is connected to the appropriate pair of "DO" terminals. Each digital output circuit includes a LED indicator which is lit when the digital output is active.

2.4.4 Analogue Inputs (905-1 and 905-2)

The 905-1 module provides two 4 - 20 mA DC analogue inputs for connecting to instrument transducers such as level, moisture, pressure transducers, etc. The 905-2 module provides six 0 - 20 mA DC analogue inputs. Note that the inputs on the 905-2 module will measure down to 0mA, so they can also be used for zero based signals such as 0 - 10 mA.

Each analogue input has a positive and negative terminal, and may be placed at any point in the current loop, as long as neither input rises above the 24 volt supply level. Each input has a loop resistance of less than 250 ohms and zener diode protection is provided against over-voltage and reverse voltage, however additional protection may be required in high voltage or noisy environments.

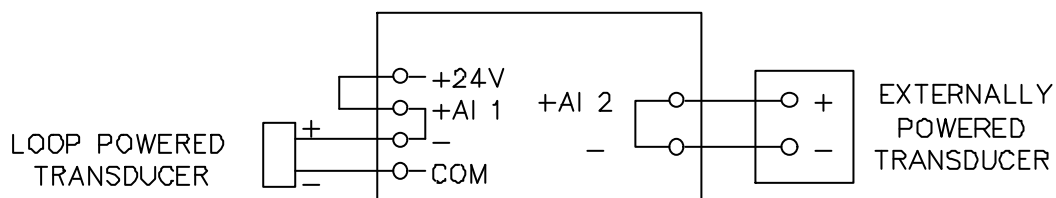

A 24VDC supply is available on the 905 module for powering the analogue transducer loops. In this case, the analogue loop should be connected between a "AI 1-" terminal and "COM" (for the first analogue input) or "AI 2-" (for the second analogue input), and so on for other inputs. The positive terminal ("AI 1+" or "AI 2+", etc) should be connected to "+24V".

Externally powered loops may be connected by connecting the input between "AI 1+" and "AI 1-" for analogue input 1 or "AI 2+" and "AI 2-" for analogue input 2, and so on for other inputs. Analogue Input 1 "AI 1+" may also be configured to control a high/low analogue set-point. See Chapter 4 **Configuration** for further details.

Common mode voltage may be -0.5V to 27V. Shielded cable is recommended for analogue I/O loops to minimise induced noise and Radio Frequency Interference (RFI). The shield of the cable should be connected to earth at one of the cable only. The use of shielded wiring inside an enclosure containing a 905 module is also recommended.

2.4.5 Analogue Outputs (905-1 and 905-3)

The 905-1 module provides two 4 - 20 mA DC analogue outputs for connecting to instrument indicators for the display of remote analogue measurements. The 905-3 module provides eight 0 - 20 mA DC analogue outputs. Each analogue output is a "sink" to common.

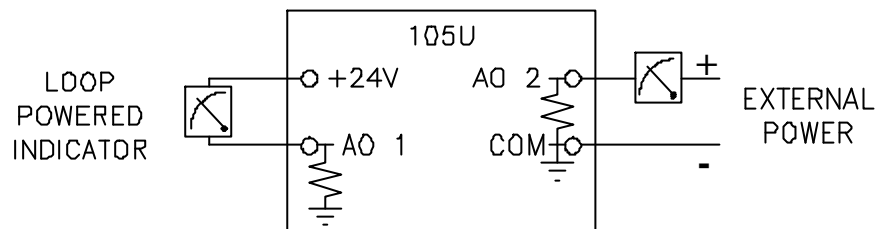

A 24VDC supply is available on the 905 module for powering the analogue output loop (max external loop resistance 1000 ohms). In this case, the analogue loop is connected between a "+24V" terminal and "AO 1" (for the first analogue output) or "AO 2" (for the second analogue output), and so on for the other output signals.

Externally powered loops to 27 VDC may be connected by connecting the output between the "AO" terminal (positive) and the "COM" terminal (negative). Zener protection of analogue outputs provides protection against short periods of over-voltage but longer periods **may result in module damage**. Note that the 905 common is connected internally to ground and no other point in the analogue loop should be grounded.

Analogue outputs may also be configured to individually turn off (0 mA) if no command message is received to that output for a certain period. . See Chapter 4 **Configuration** for further details.

2.4.6 Pulse Input (905-1)

For the 905-1 module, digital input 1 may be configured as a pulse input (max rate 100 Hz, min. off time 5 ms). In this mode, both the pulse **rate** and the pulse **count** are available for mapping to a remote output. The pulse rate may appear at any analogue output on the remote unit, while the pulse count can appear at a Pulse Output on another 905-1 or Digital Output on a 905-3 unit. The pulse input should be connected in the same way as a digital input.

2.4.7 Pulse Inputs (905-2)

For the 905-2 module, the four digital inputs (DI 1-4) may be configured as pulse inputs. The first digital/pulse input DI 1 has a maximum rate of 1000 Hz (min. off time 0.5 ms), while DI 2-4 have a maximum rate of 100 Hz (min. off time 5 ms). When using DI 1 at high pulse rates (more than 100 Hz), a divide by 10 function may be configured to reduce the pulse count at the output, as Pulse Outputs have a maximum rate of 100 Hz.

For each pulse input, both the pulse **rate** and the pulse **count** are available for mapping to a remote output. The pulse rate may appear at any analogue output on the remote unit, while the pulse count can appear at a Pulse Output. The default update time for pulse counts is 1 minute. This can be changed by changing the update time configuration - refer Chapter 4 **Configuration** for further details. The pulse count is a 16 bit value - "roll over" of the count when it exceeds the maximum value is automatically handled by the 905 modules.

Pulse inputs should be wired in the same way as digital inputs (see Section 2.4.1).

2.4.8 Pulse Output (905-1)

A single FET output to common rated at 30VDC, 500 mA is provide for the pulse output "PO". This output accurately recreates the pulses counted at a pulse input at a 905-1 or 905-2 module.

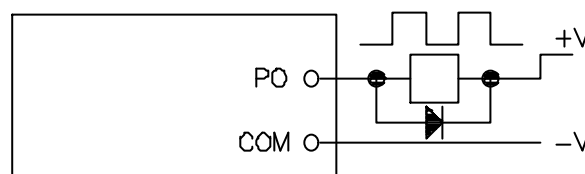

Although the count is accurately re-created, the rate of output pulses may not accurately reflect the input rate. The actual input pulse rate may be configured to appear at an analogue output if required. Note that the pulse rate and accumulated value will remain accurate even if a period of communications failure has occurred. The maximum output rate is 100 Hz. If a high speed pulse input is used (more than 100 Hz) on PI1 of a 905-2 module, the pulse input count should not be transmitted to a PO on the 905-1 or DO on the 905-3 without configuring the divide-by-10 function (on the 905-2 module)

2.4.9 Pulse Output (905-3)

The first four digital outputs on the 905-3 module may also be used as pulse outputs. The outputs are FET output to common rated at 30VDC, 500 mA. The outputs will provide a pulse signal of up to 100 Hz. The outputs accurately recreate the pulses counted at pulse inputs at a 905-1 or 905-2 module.

Although the count is accurately re-created, the rate of output pulses may not accurately reflect the input rate. The actual input pulse rate may be configured to appear at an analogue output if required. Note that the pulse rate and accumulated value will remain accurate even if a period of communications failure has occurred.

2.4.10 RS232 Serial Port

The serial port is a 9 pin DB9 female and provides for connection to a terminal or to a PC for configuration, field testing and for factory testing. This port is internally shared with the RS485 - ensure that the RS485 is disconnected before attempting to use the RS232 port. Communication is via standard RS-232 signals. The 905 is configured as DCE equipment with the pin-out detailed below. The serial port communicates at a baud rate of 9600 baud, 8 bits, no parity, one stop bit.

Pin	Name	Dirn	Function
1	DCD	Out	Data carrier detect - not used
2	RD	Out	Transmit Data - Serial Data Input (High = 0, Low = 1)
3	TD	In	Receive Data - Serial Data Output (High = 0, Low = 1)
4	DTR	In	Data Terminal Ready - not used
5	SG	-	Signal Ground
6	DSR	Out	Data Set Ready - not used
7	RTS	In	Request to Send - not used
8	CTS	Out	Clear to send - not used
9	RI	-	Ring indicator - not used.

An example cable drawing for connection to a laptop is detailed below:

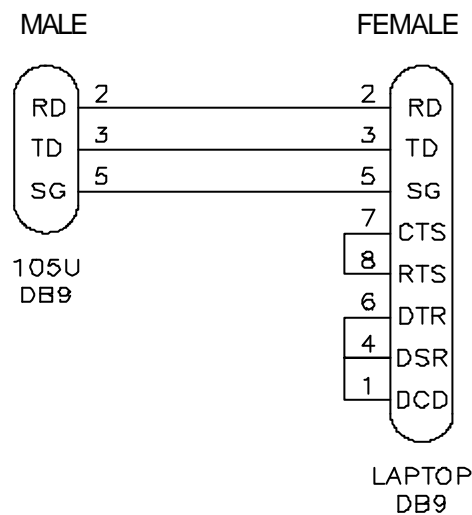

2.4.11 RS485 Serial Port

The RS485 port provides for communication between multiple 905 units using a multi-drop cable. Up to 32 units may be connected in each multi-drop network. Each multi-drop network may have one unit providing radio communications with other units in the system. The RS485 feature allows local hubs of control to operate without occupying radio bandwidth required for communication between remotely sited units.

The RS485 Communications format is 9600 baud, 8 data bits, one stop bit, no parity. Note that the RS485 port is shared internally with the RS232 port - disconnect the RS232 cable after configuration is complete.

RS485 is a balanced, differential standard but it is recommended that shielded, twisted pair cable be used to interconnect modules to reduce potential Radio Frequency Interference (RFI). An RS485 network should be wired as indicated in the diagram below and terminated at each end of the network with a 120 ohm resistor.

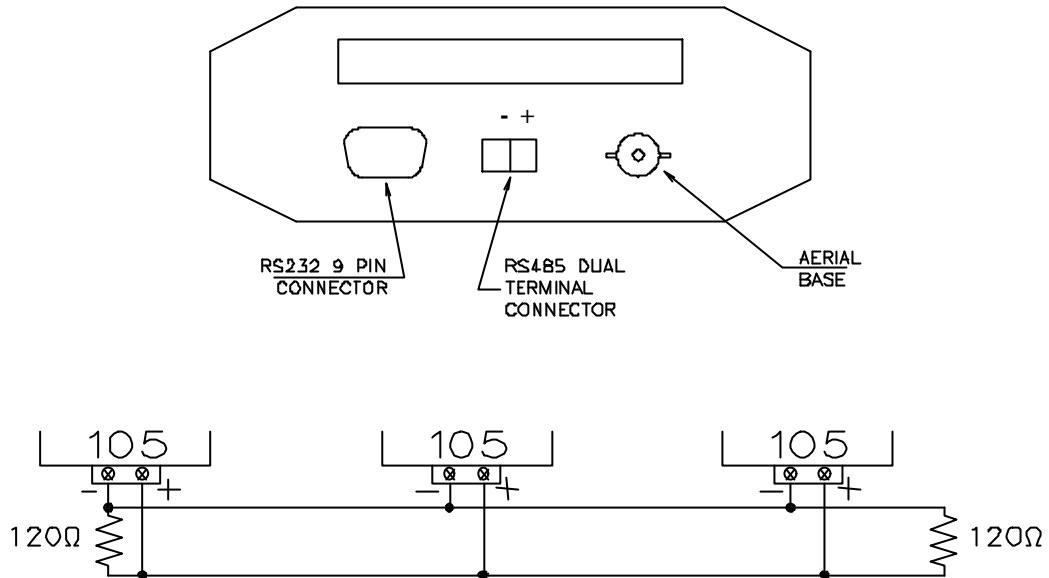

Chapter Three

OPERATION

3.1 Power-up and Normal Operation

When power is initially connected to the 905 module, the module will perform internal diagnostics to check its functions. The following table details the status of the indicating LED's on the front panel under **normal** operating conditions.

LED Indicator	Condition	Meaning
OK	On	Normal Operation
RX	Occasional flash	Radio Receiving, or Activity on serial ports
RX	Flashes continuously	Configuration Mode
RX	On	Button press when entering Configuration Mode
TX (only on 905U units)	Occasional flash	Radio Transmitting
PWR	On	Supply voltage available from Solar Panel or SUP1/SUP2
OK	Flashes every 5 seconds	+24V Supply overloaded

Additional LED's provide indication of the status of digital inputs and outputs. LED's display the status of each digital input (lit for active), and LED's display the status of each digital output (lit for active). Other conditions indicating a fault are described in Chapter Six **Troubleshooting**.

The 905 module monitors the power supply and provides status of supply failure and battery low voltage for "mapping" to one of the module's own outputs or transmitting to a remote output. When the 905 module is powered from a normal supply (i.e. via either of the "SUP" terminals), the *PWR* LED indicator is lit. When the 905 modules is powered from a solar panel and battery, the *PWR* LED indicator is lit only when the charge current is available (i.e. when the solar panel is receiving light). In the event of excessively low battery voltage (10.8V), the *OK* LED will go off, the unit will automatically set all outputs off, and disable the +24V analogue loop supply. the *OK* LED will turn on again after the battery voltage exceeds 11.3V. This enables installations to be configured so that the battery current drain is minimised in the event of extended mains failure, reducing the possibility of deep discharge of batteries.

3.1.1 Communications

If transmissions are not successful, then the 905 module will re-try up to four times at random intervals to transmit the message. If communications is still not successful, the "Comms Fail" internal status will be set. In the default configuration, this will have no consequence and the 905 module will

continue to attempt to transmit to the remote module every ten minutes. For critical applications, this status can be configured to be reflected to an output on the module for alert purposes. The outputs on the module may also be configured to reset after a specified timeout (digital outputs reset to “off”, analogue outputs reset to 0 mA) allowing the system to turn off in a controlled manner e.g. a pump will never be left running because of a system failure.

Example of Successful Communications

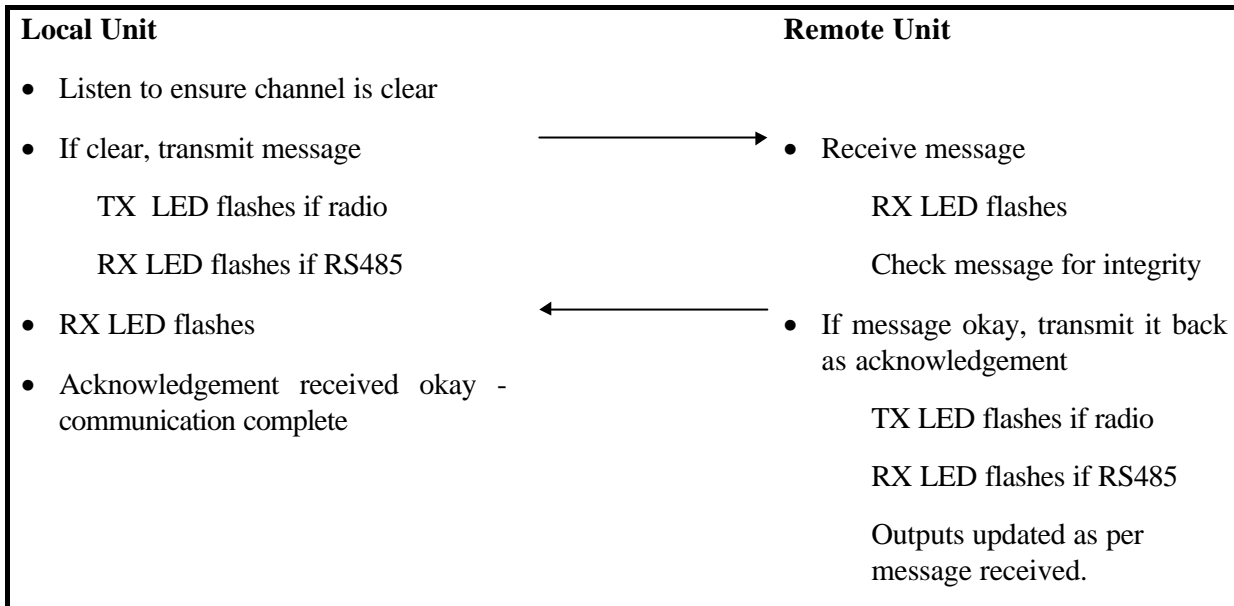

Example of unsuccessful communications

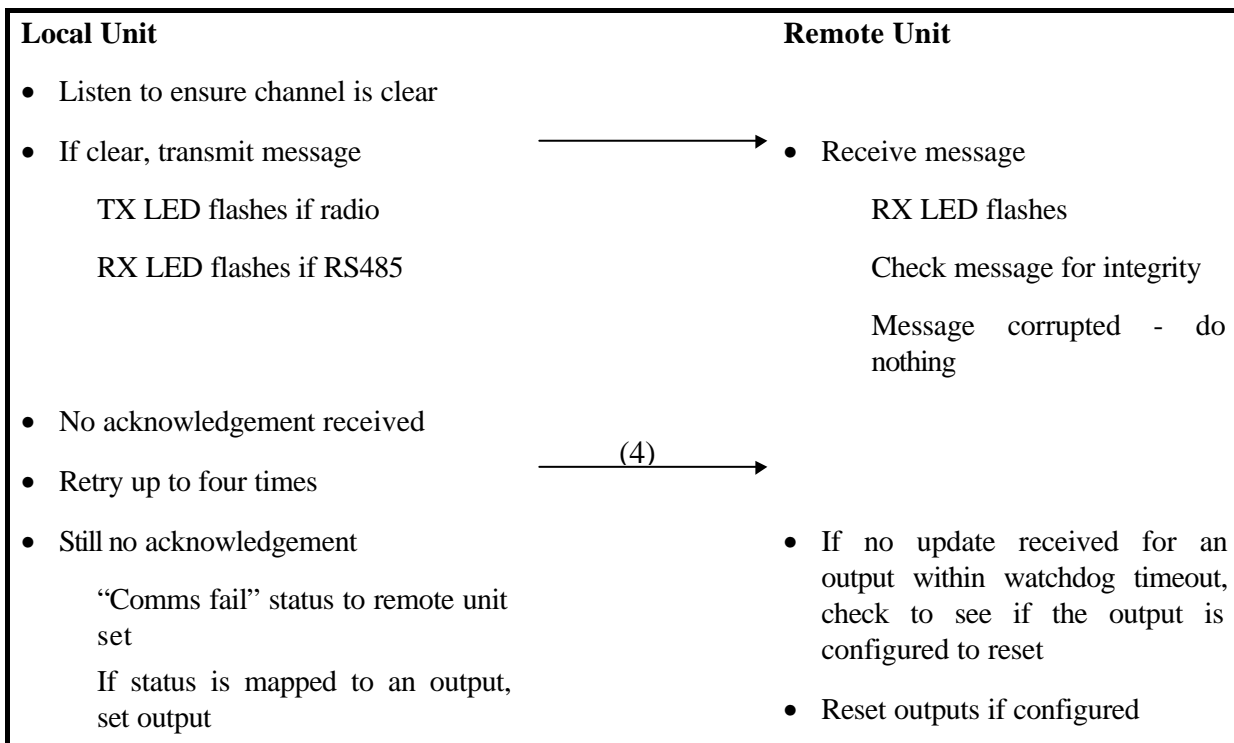

Repeaters can be used in a system to increase range. Each 905U unit can be configured to act as a repeater. When configuring an input to be mapped to an output, the communications path to the output unit, including the repeater addresses is specified. The 905U acts as a *digital repeater*, that is, the signal is decoded and then retransmitted “as new”.

Example Repeater Communications

Unit A DI 1 mapped to Unit D DO1 via Units B & C

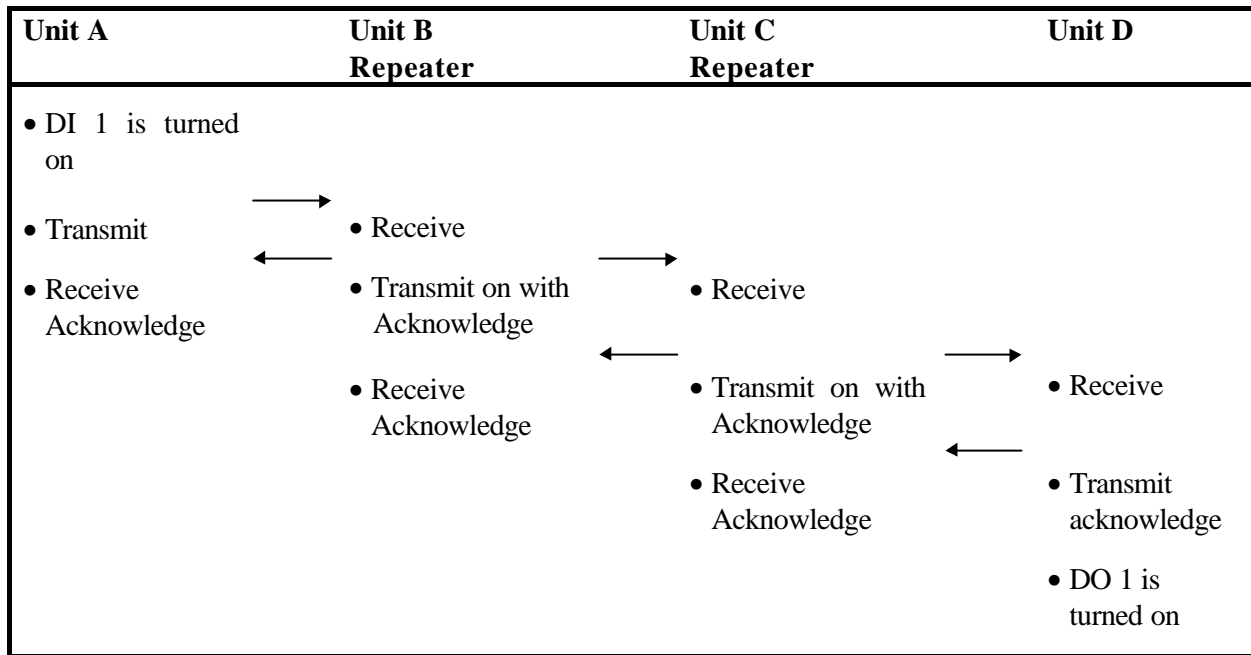

3.1.2 Change of state conditions

The 905 module transmits a data message whenever it detects a "change-of-state" on one of its input signals. A "change-of-state" of a digital or digital internal input is a change from "off" to "on" or vice-versa provided the change is sustained for 0.5 second (i.e. 0.5 second debounce).

In addition to "change-of-state" transmissions, each module will transmit the status of each input to its corresponding output every ten minutes (configurable). These **updates** mean that the outputs are set to the current input values regularly, even where no “change-of-state” has occurred. These update transmissions increase the accuracy of the output and give extra system reliability.

Analogue Change-of-state

A "change-of-state" for an analogue input, battery voltage or pulse input rate is a change in value of the signal of 3% (configurable) since the last transmission. Note that the sensitivity of 3% refers to 3% of the analogue range, not 3% of the instantaneous analogue value. That is, if an analogue input changes from 64% (14.24 mA) to 67% (14.72 mA), a "change-of-state" will be detected. This “change-of-state” sensitivity is configurable between 0.8% and 50%.

Analogue inputs are digitally filtered to prevent multiple transmissions on continually varying or "noisy" signals. The input is filtered with a 1 second time constant and a 1 second debounce. The analogue outputs are filtered with a 1 second time constant. An example explaining the interaction of these figures is shown below. In general, the following may be used as a rule of thumb for

calculating the appropriate sensitivity required for a given application:

Instantaneous change of 2 x sensitivity on input → 3 second output response

Instantaneous change of 10 x sensitivity on input → 5 second output response

The analogue inputs have 15 bit resolution and 0.016mA accuracy.

An **example** of an **analogue** input and how the output follows it is shown below:

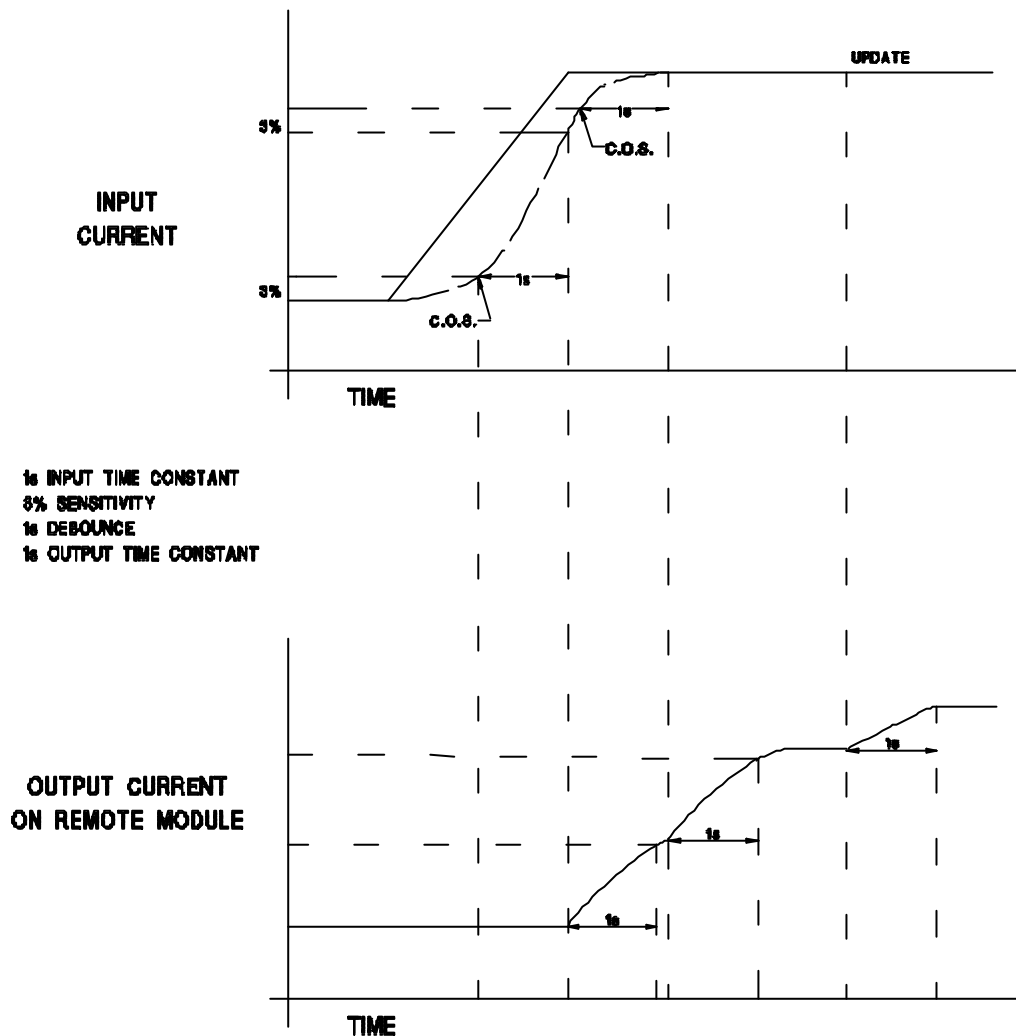

Pulse input change of state

Pulse input counts do not use “change-of-state” transmissions. Instead, accumulated pulse input counts are transmitted at set intervals. The default period is 1 minute and is configurable. Note that the pulse outputs are re-created from the *accumulated* pulse count. If a transmission is missed, the pulse output will still be re-created when the next accumulated value is transmitted. This ensures that no pulses are lost due to communications failures.

The following diagram shows how pulse inputs are re-created as pulse outputs. For pulse outputs, the 905 module keeps two counters in memory - the pulse input count received from the remote 905 module, and the count of output pulses. When the 905 receives an update of the input pulse count, it will output pulses until the output pulse count is the same as the input pulse count. The

output pulse will be output evenly over the pulse output update time which is configured in the module. For example, assume that 905 module receives a pulse input update message from the remote 905 module, and the difference between the pulse input count and the pulse output count is 12 pulses. The 905 will then output the 12 pulses evenly over the next minute (if the pulse output update time is 1 minute).

The default values for the pulse input update time and pulse output update time is 1 minute. In this case, the output pulses are effectively 1 minute behind the input pulses. These update times may be changed by the user. The pulse output update time should not be set to be more than the pulse input update time. Note that the maximum pulse rate for both inputs and outputs is 100Hz.

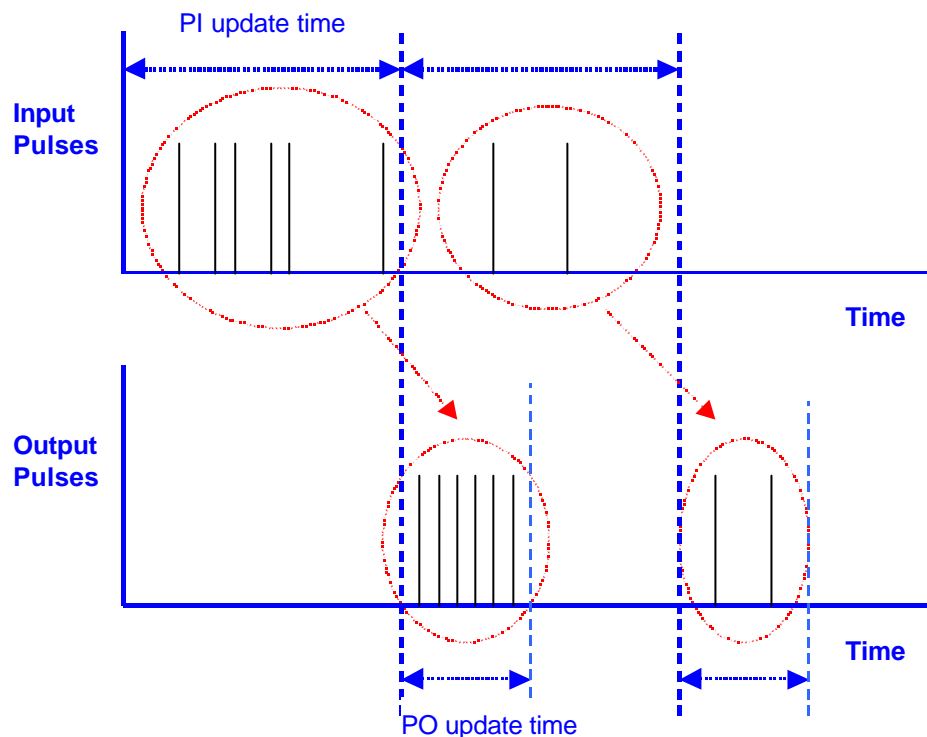

As well as accumulating the pulse input, the 905 module will also calculate the rate of pulses. Pulse rates are treated as an “internal” analogue input and are configured with analogue sensitivities for change-of-state transmissions. The maximum pulse rate corresponding to 20mA output may be configured by the user.

3.1.3 Analogue Set-points

On 905-1 modules, the “AI 1” input may be used to trigger the analogue set-point status. High set point and low set point levels are configurable. This set-point status turns ON when the analogue input moves below the low level, and turns OFF when it moves above the high level. The high level must always be greater than, or equal to, the low level set point. This set-point status may be mapped (inverted, if required) to any output in the network. The set-point status is effectively an internal digital input.

On 905-2 modules, each analogue input has set-point values for controlling digital outputs. The

set-point operation works as for the 905-1 module.

3.1.4 Start-up Poll

After a 905 module has completed its initial diagnostics following power up, it will transmit update messages to remote modules based on the values of the module's inputs. The module's outputs will remain in the reset/off/zero condition until it receives update or "change-of-state" messages from the remote modules.

The 905 module can transmit a special "start-up poll" message to another module. The remote module will then immediately send update messages to this module such that its outputs can be set to the correct value. Start-up polls will only occur if they are configured. It is necessary to configure a start-up poll to each remote module which controls the module's outputs. For further information, refer to Chapter 4 **Configuration**.

3.1.5 Communications Failure (CF)

The internal communications failure (CF) status is set if a module does not receive an acknowledgement message after five attempts at transmitting a message. The CF status may be configured to set a local digital output for an external alarm.

Although the CF status can set an output, it will not reset the output. That is, once communications is re-established (and the CF status is reset), the output will stay "on". The Reset Output feature (see below) is used to reset the output.

The output will reset only when no communications failures occur within the configured "Reset Output Time" for the output that CF status is mapped to. Note that if the reset output time is not enabled, the CF status will remain set forever, once an unsuccessful transmission occurs. See Chapter 4 **Configuration** for further details.

3.1.6 Resetting Outputs

Each digital and analogue output may be individually configured to reset if that output has not received a change-of-state or an update message within a certain time period. Generally this time is set to twice the update period, so at least one update can be missed before an output is reset.

In most cases it is desirable to reset outputs which are controlling equipment if there is a system failure, however alarm or indication outputs are not reset so the last valid indication remains shown. See Chapter 4 **Configuration** for further details.

3.2 **System Design Tips**

The following tips will help to ensure that your system operates reliably.

3.2.1 System Dynamics

It is important to be aware of the dynamics of the 905 system. Digital inputs have a minimum "debounce" delay of 0.5 sec - that is, a change message will not be sent for 0.5 sec after a change

has occurred. Analogue inputs and outputs have time delays of 1 to 2 seconds.

Messages transmitted via serial link are received in less than 20 mSec, however a message sent by radio takes approx 100 mSec.

These delays are not significant in most applications, however if your application requires faster responses, then the above delays need to be considered.

3.2.2 Radio Channel Capacity

Messages sent on a cable link are much faster than on a radio channel, and the capacity of the radio channel must be considered when designing a system. This becomes more important as the I/O size of a system increases.

The 905 modules are designed to provide “real-time” operation. When an input signal changes, a change message is sent to change the output. The system does not require continuous messages to provide fast operation (as in a polling system). Update messages are intended to check the integrity of the system, not to provide fast operation. Update times should be selected based on this principle. The default update time is 10 minutes - we recommend that you leave these times as 10 minutes unless particular inputs are very important and deserve a smaller update time.

It is important that radio paths be reliable. For large systems, we recommend a maximum radio channel density of 100 messages per minute, including change messages and update messages. We suggest that you do not design for an average transmission rate of greater than 50 per minute - this will give a peak rate of approx 100 per minute. Note that this peak rate assumes that all radio paths are reliable - poor radio paths will require re-try transmissions and will reduce the peak channel density. If there are other users on the radio channel, then this peak figure will also decrease.

The 905 modules will only transmit one message at a time. If re-tries are necessary, another message cannot start. The time between re-tries is a random time between 1 and 5 seconds. The time for five tries is between 5 and 21 seconds. Another message cannot be sent until the last one has finished. This delay will obviously have an effect on a busy system.

3.2.3 Radio Path Reliability

Radio paths over short distances can operate reliably with a large amount of obstruction in the path. As the path distance increases, the amount of obstruction which can be tolerated decreases. At the maximum reliable distance, “line-of-sight” is required for reliable operation. If the path is over several kilometres (or miles), then the curvature of the earth is also an obstacle and must be allowed for. For example, the earth curvature over 10 km is approx 3m, requiring aerials to be elevated at least 4m to achieve “line-of-sight” even if the path is flat.

A radio path may act reliably in good weather, but poorly in bad weather - this is called a “marginal” radio path. If the radio path is more than 20% of the maximum reliable distance (see Specification section for these distances), we recommend that you test the radio path before installation. Each 905U module has a radio path testing feature - refer to section 6.2 of this manual.

There are several ways of improving a marginal path :-

- Relocate the unit to a better position. If there is an obvious obstruction causing the problem, then locating the unit to the side or higher will improve the path.
- If it is not practical to improve a marginal path, then the last method is to use another module as a repeater. A repeater does not have to be between the two modules (although often it is). If possible, use an existing module in the system which has good radio path to both modules. The repeater module can be to the side of the two modules, or even behind one of the modules, if the repeater module is installed at a high location (for example, a tower or mast). Repeater modules can have their own I/O and act as a “normal” 905U module in the system.

3.2.4 Design for Failures

All well designed systems consider system failure. I/O systems operating on a wire link will fail eventually, and a radio system is the same. Failures could be short-term (interference on the radio channel or power supply failure) or long-term (equipment failure).

The 905 modules provide the following features for system failure :-

- Outputs can reset if they do not receive a message within a configured time. If an output should receive an update or change message every 10 minutes, and it has not received a message within this time, then some form of failure is likely. If the output is controlling some machinery, then it is good design to switch off this equipment until communications has been re-established.

The 905 modules provide a “drop outputs on comms fail” time. This is a configurable time value for each output. If a message has not been received for this output within this time, then the output will reset (off, in-active, “0”). We suggest that this reset time be a little more than twice the update time of the input. It is possible to miss one update message because of short-term radio interference, however if two successive update messages are missed, then long term failure is likely and the output should be reset. For example, if the input update time is 3 minutes, set the output reset time to 7 minutes.

- A 905 module can provide an output which activates on communication failure to another module. This can be used to provide an external alarm that there is a system fault.

Chapter Four

CONFIGURATION

4.1

Introduction

The 905 modules may be configured by connecting a computer (PC) using the 905 Configuration Software programme. Alternatively, the module may be configured by the on-board miniature switches located under the blue cover on the front of the module. This chapter describes the default configuration of the module and using the Configuration Software Programme. For details on switch configuration, please refer to the separate 905 Switch Configuration Manual, available from 905 distributors.

Each 905 module is configured with a system address and a unit address. The system address is common to every module in the same system, and is used to prevent "cross-talk" between modules in different systems. Separate networks with different system addresses may operate independently in the same area without affecting each other. The system address may be any number between 1 and 32 767. The actual value of the system address is not important, provided all modules in the same system have the same system address value. **A system address of zero should not be used.**

Each unit must have a unique unit address within the one system. A valid unit address is 1 to 127. A network may have up to 95 individual modules communicating via radio (unit addresses 1 to 95), each with up to 31 modules communicating via RS485 (unit addresses 96 to 127). In the network, any individual input signal may be "mapped" to one or more outputs anywhere in the system. The unit address determines the method of communication to a module. Any module with a unit address between 96 and 127 will communicate by RS485 only. Other units with a unit address below 95 may communicate by radio *or* RS485 - the unit will determine which way to communicate depending upon the unit address of the destination module. For example, Unit 31 will talk to Unit 97 by RS485 only, but will talk to unit 59 by radio only. 105S units must always have a unit address between 96 and 127 as serial communication is the only method of communication available. **A unit address of zero should not be used.**

The three different products in the range can be used together in the same system. Inputs to one product type can be transmitted to outputs of another product type. For example, an analogue input to a 905-2 may be transmitted to an analogue output of a 905-1 or 905-3. Repeaters may be any product type.

The 905-1 and 905-2 modules require only one unit address. The 905-3 module uses two addresses, however only one unit address has to be entered. The 905-3 module requires two addresses because of the large number of output channels. If the "entered" unit address is an even number, then the second address is the next number. If the "entered" address is an odd number, then the second address is the previous number. So the two addresses are two subsequent numbers, starting with an even number. If a 905-3 module is given a unit address of 10, then it will also take up the unit address 11 and will accept messages addressed to either 10 or 11. It is important to remember this when allocating unit addresses to other modules in the system.

Warning - do not allocate the address number 1 to a 905-3 module.

In addition to these network configurations, operational parameters called **User Options** may be configured to change the features of the 905 operation. These parameters may be configured using the Configuration Software of configuration switches (see **905 Switch Configuration Manual**)

4.2 Easy Configuration Using Default Settings

If your application requires only a single pair of 905 modules, communicating via radio or serial link, default settings may satisfy your needs. If so, no configuration is required. Essentially, all inputs at Module A are reflected at the corresponding outputs at Module B. All inputs at Module B are reflected at the corresponding outputs at Module A.

For 905-1 modules, the default configuration is as follows :-

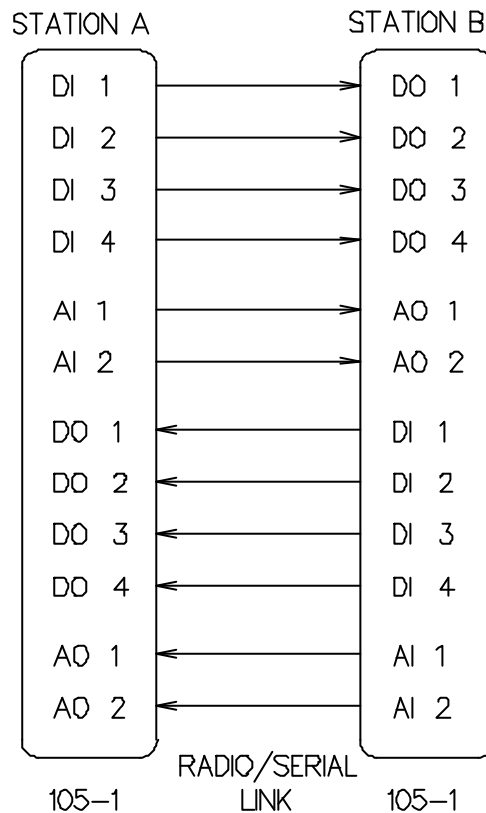

In this configuration, the “PO” Pulse output is inactive and no special action is taken on “Comms fail”, “Mains fail” or “Battery Low”. “DI 1” is configured as a digital and not a pulse input.

For 905-2 and 905-3 modules, the default configuration is as follows :-

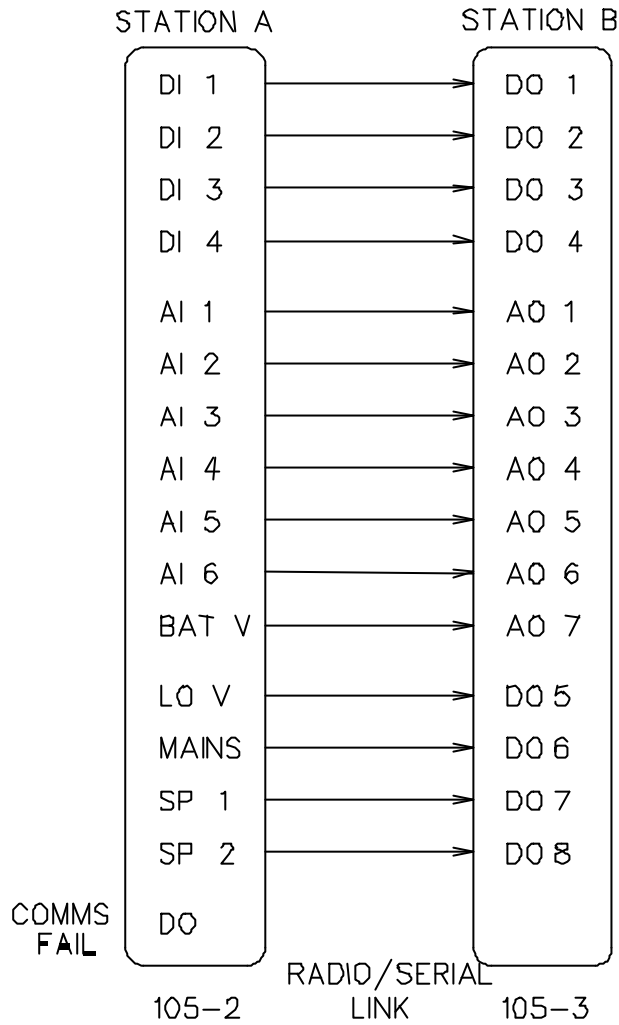

The following table details the default values for **User Options** :

Option	Factory Set Value
Update transmissions	Every 10 minutes
Analogue Change-of-state sensitivity	3%
Reset outputs on Comms fail	No
Analogue Setpoints (if mapped)	Low Set point = 30% High Set point = 75%
Pulse Output Rate Scaling (if Pulse Rate is mapped)	100 Hz
Digital Input Debounce Time	0.5 seconds

If any of the above values are not appropriate to your system, Section 4.4 below will detail how to change one or all of the above variables.

4.3

905 Configuration Software

This chapter describes installation and operation of configuration software for the 905 radio and serial telemetry modules.

Configuration software eliminates the need for configuration of the unit via the 16 DIL switches under the blue plastic plug.. This software provides all of the functions available through the switch configuration as well as additional configuration options not available through switch configuration.

The configuration software runs on a conventional PC as a “DOS” programme. The software creates a configuration file that can be loaded into a 905 module via RS232. The configuration software also allows the configuration of a 905 module to be downloaded for display and modification. Configuration files can be saved to “disk” for later retrieval.

Configuration of 905 modules consists of entering I/O mappings, and selecting User Options. An I/O mapping is a link between an input on the module being configured and an output on another module. A mapping has the form :-

DI3 → Out2 at 4 via 3, 11

This mapping links DI3 on this module to output channel 2 on the module with address 4, and modules 3 and 11 are repeaters. Up to 32 mappings may be entered for each module.

User Options may be selected to change the configuration of specific features.

4.3.1 Hardware Requirements

- IBM or compatible PC (386 or higher) with MS-DOS, MS-Windows 3.1, Windows-95/98
- 3.5" 1.44M floppy drive (for software installation)
- At least one serial port (preferably two serial ports to allow mouse operation).
- RS-232 serial cable as shown below.

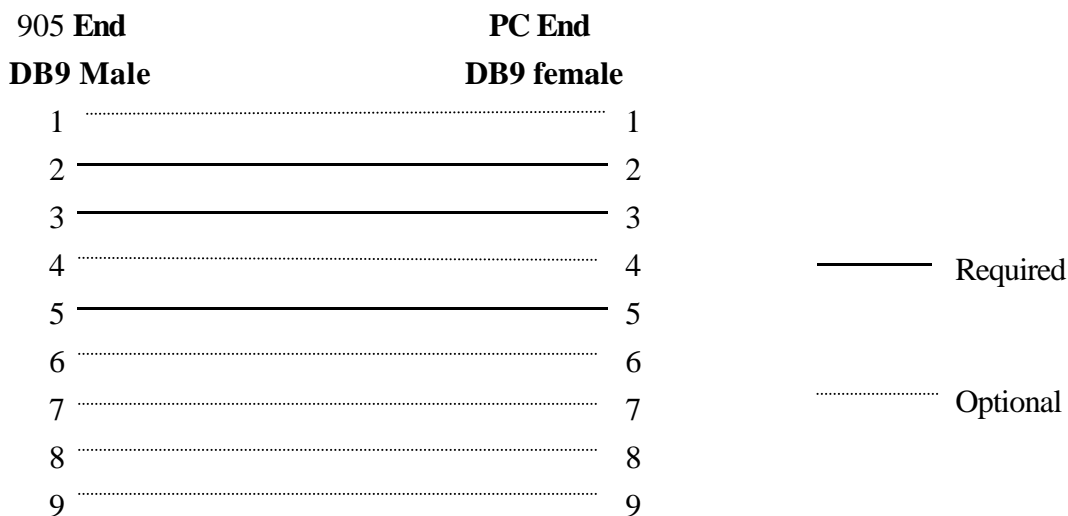

4.3.2 Installation

Running from floppy disk

The software may be run directly from the distribution disk. If the software is to be used in this manner, a copy of the distribution disk should be made, and the copy used to run the software.

Installing to a hard disk

Most users will want to install the configuration software to the hard disk of their computer. This may be simply achieved by creating a directory on the destination hard disk and copying the contents of the distribution disk to the hard disk.

For example, if the destination hard disk is drive C: and the distribution floppy is in drive A: the following sequence of instructions may be used.

```
C:> MKDIR CFG105
```

```
C:> COPY A:\*.EXE CFG105
```

Hints for Windows Users

For slower machines, the software should be run in “Full Screen” and “Exclusive” mode under Windows. If problems are experienced, exit windows and run the program from DOS.

4.3.3 Software Operation

Running from MS-DOS

Start the software by entering the directory where the configuration program is stored, and entering the executable file name. For example, if the executable is stored in C:\CFG105 type the following

```
C:\> CD CFG105
```

```
C:\CFG105> CFG105-1 To configure a 905-1 module
```

```
C:\CFG105> CFG105-2 To configure a 905-2 module
```

```
C:\CFG105> CFG105-3 To configure a 905-3 module
```

and press the <ENTER> key.

Running from MS-Windows

Select the “Run...” option from the Start menu. In the Command Line Box type:

```
C:\CFG105\CFG105-1 To configure a 905-1 module,
```

```
C:\CFG105\CFG105-2 To configure a 905-2 module,
```

```
C:\CFG105\CFG105-3 To configure a 905-3 module,
```

and press the <ENTER> key.

The Initial screen will appear as below.

This screen shows the system address, unit address, a summary of all of the mappings configured, and the current file (if any) being used. To move between editing the system address, unit address, and configuration mappings, use the <TAB> key, or use the <ALT> key in conjunction with the highlighted letter. Alternatively, simply click on the appropriate section with the mouse.

```

File  User Options  Communication
                                105-1 Configuration Software

System Address
  [ ]

Unit Address
  [ ]

Out    105  Type
Out1   -1  -2  -3L  -3H  D01  D01  D/P1  A01
Out2   D02  -   D/P2  A02
Out3   D03  -   D/P3  A03
Out4   D04  -   D/P4  A04
Out5   A01  -   D05  A05
Out6   A02  -   D06  A06
Out7   PULS -   D07  A07
Out8   -   -   D08  A08

Mappings
<empty>

Current File:  None

Alt-X Exit

```

Changing the system address and unit address

To change the system address and unit address, simply move to the appropriate box using the <TAB> key or the <ALT> + letter keys, or mouse click, and type in a new number or use the arrow keys to edit the old number.

Entering a new mapping

To enter a new mapping, move to the Mappings section of the screen using the <TAB>, <ALT> + M keys or the mouse. Hit the <INS> key or double click the left mouse button to bring up a dialogue box as shown below.

```

[ ] Select Mapping Type
(•) Input/Output
( ) Poll
( ) Comms Fail

Ok          Cancel

```

Select the desired mapping type and hit the <ENTER> key or select OK to continue.

Input/Output	Standard mapping of an input to an output at another unit.
Poll	Start-up poll of a remote unit to ensure data is up to date
Comms Fail	Set a local output on comms fail to a remote site

Changing an existing mapping

Select the mapping to change using the mouse or arrow keys, and either press the <ENTER> key, or click the right mouse button.

Deleting an existing mapping

Select the mapping to delete using the mouse or arrow keys, and press the key to delete the mapping. A message asks for confirmation to ensure mappings are not deleted accidentally.

Configuring Input/Output mapping types

On selecting an Input/Output type mapping, a dialogue box allows entry of the desired mapping. Depending on the type of unit being configured (905-1, 905-2, or 905-3), the dialogue box will vary.

The following is the display for configuration of Input/Output mappings on a 905-1 module. The 905-2 module has 32 different “inputs”, and the 10GenericName-3 module has only 4 “inputs”.

```

File  User Options  Communication
                                105-1 Configuration Software
[ ]  Enter Mapping
-----
Input                               Out 105-1 105-2 -3Low -3Hi
<•> DIN 1                           <•> DOT1 DOT1  D/P1  AOT1
< > DIN 2                           < > DOT2 -    D/P2  AOT2
< > DIN 3                           < > DOT3 -    D/P3  AOT3
< > DIN 4                           < > DOT4 -    D/P4  AOT4
< > MAINS FAIL                       < > AOT1 -    DOT5  AOT5
< > LOW VOLTS                         < > AOT2 -    DOT6  AOT6
< > SETPOINT                          < > PULSE -    DOT7  AOT7
< > PULSE COUNT                      < > - -      DOT8  AOT8
< > AIN 1
< > AIN 2
< > PULSE RATE
< > BATT VOLTS

Invert      [ ]

                                Destination Address    12
                                Store And Forward
                                9      10      13      11

                                Ok                      Cancel
  
```

Alt-X Exit

Item	Meaning
Input	The input to be mapped.
Output	The output (usually at a remote site) at which the signal is to appear.
Destination Address	The address of the site where the output is to appear.
Store And Forward	The addresses of any intermediate repeater units needed to reach the destination address (entered in order of nearest to furthest repeater).
Invert	Optional inversion of the signal (905-1 and 905-3 only).

Select the desired mapping configuration, then press <ENTER> or select the OK button on the dialogue box to return to the main screen.

Outputs are identified by the corresponding output name for each type of destination module. These correspond to the outputs of the various 905 modules as follows:

	905-1 Output	905-2 Output	905-3 First address (Even)	905-3 Second address (Odd)
Output 1	DOT 1	DOT 1	DOT/PULSE 1	AOT 1
Output 2	DOT 2	None	DOT/PULSE 2	AOT 2
Output 3	DOT 3	None	DOT/PULSE 3	AOT 3
Output 4	DOT 4	None	DOT/PULSE 4	AOT 4
Output 5	AOT 1	None	DOT 5	AOT 5
Output 6	AOT 2	None	DOT 6	AOT 6
Output 7	PULSE OUT	None	DOT 7	AOT 7
Output 8	None	None	DOT 8	AOT 8

Configuring Start-Up Polls

When a unit is first turned on, its outputs will not be set until it receives update messages from any other units in the system which have inputs configured to appear at those outputs. To ensure that outputs are set as soon as possible after start-up the unit may be configured to “Poll” any other units with mappings to its outputs. This is achieved by selecting “Poll” from the “Mapping Type” dialogue box. If “Poll” is selected from the mapping type dialogue box, then the following dialogue box is displayed.

Enter the address of the unit to poll in the “Destination address” section, and the addresses of any intermediate units required to reach this unit in the “Store and Forward” section (starting with the nearest repeater address).

Configuring Comms Fail Mappings

In situations where an indication of unsuccessful communication (comms) to a remote module is required, an output at the local module may be turned on in the event of unsuccessful comms.

Successful comms does not turn off the output, so the “Drop outputs on comms fail” (Refer below) time should be set to a period similar to the update time for the remote. This allows comms fail indication to multiple remotes to be configured to appear at the same output, which acts as a general comms fail indication. Configuring a “Comms Fail Address” of zero causes communication failure to any destination module to be indicated on the selected output.

For example, if “Comms fail to unit 12” is configured to DO1, then the 905 module will set (or activate) DO1 each time communications to unit 12 is not successful. If DO1 has a “Drop outputs on comms fail” time configured of 10 minutes, then DO1 will reset (de-activate) 10 minutes after the last comms fail to unit 12.

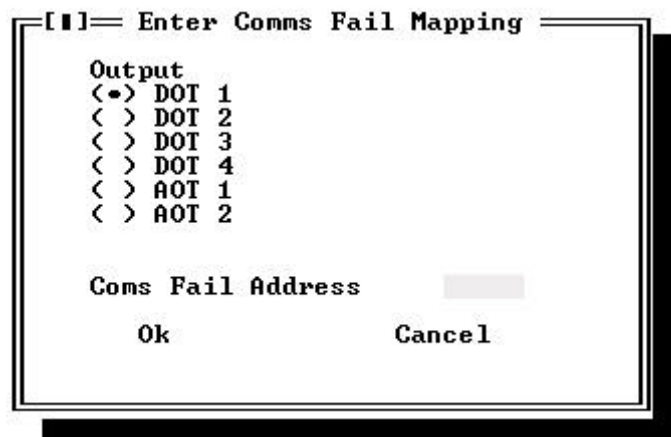

Enter the output at which the comms fail indication is to appear, and the address for which the comms fail should be indicated.

Saving and Loading Configurations to / from Disk

It is strongly recommended that the configuration for each unit in the system is saved to a backup file. In the unlikely event of unit failure, a replacement unit may be quickly configured from the saved file.

When editing a configuration is complete, it may be saved to a disk file for future use, or for further editing. The “File” menu on the top menu bar provides access to saving and restoring configuration files. Files are stored with the default extension “.905” for 905-1 configurations, extension “.205” for 905-2 configurations and “.305” for 905-3 configurations. Standard file dialogue boxes for “Load”, “Save”, and “Save As” commands provide simple file management. When a file is loaded or saved the status line at the bottom of the screen “Current File” changes to indicate the name of the current file.

4.3.4 Changing User Options

User options allow a variety of parameters of the 905 module to be modified to suit a particular application. User Options are available through the “User Options” menu on the top menu bar. User options are

- Update Times
- Analogue Sensitivity
- Reset Output on Comms Fail
- Digital/Analogue Debounce (905-1 and 905-2 only)
- Analogue Debounce (905-2 only)
- Set-points (905-1 and 905-2 only)
- Pulse Rate Scale (905-1 and 905-2 only)
- Pulse Output Update (905-1 and 905-3 only)

Update Times allows configuration of how frequently each configured mapping is updated (Integrity Update).

The period of update (check) transmissions may be configured individually for each input. The default period is 10 minutes for all inputs, except for pulse inputs (1 minute). Note that this is the *check* transmission time - updates will also be sent on any change-of-state on each input. It is important here to keep in mind the principle - “Less radio traffic means better communications”. Short update times should only be used in special circumstances, or when an RS-485 network is used, and the message is not transmitted over a radio link. Frequent updates from multiple units causes congestion of the radio channel, which results in increased communication failures and general performance degradation of the system.

Analogue Sensitivity allows configuration of the change required in an analogue input before a “Change Of State” is detected, and the new analogue value is transmitted. For input signals which vary widely over a short period of time or have a normal oscillation, the analogue sensitivity should be set to an appropriately large value. This ensures that many change messages are not transmitted in too short a time. This will result in channel congestion, as described in the preceding section.

Reset Output on Comms Fail allows the **Comms Fail Time** to be selected - this is the time for an output to reset if it has not received an update or change message.

Each output on the unit, either analogue or digital, may be configured to reset (off or 0mA) when no update transmission has been received for a certain time. The default condition is zero (no reset). This option can be used to ensure that communications failure will not result in loss of control. For example, outputs connected to pumps should be configured to reset on communications failure so that the pump will turn off.

If the reset time is less than the update time, then the output will reset when the reset time expires, and then set again when the update message is received. We recommend that the reset time be a little more than twice the update time.

Debounce is the time which an input must stay stable before the 905 module decides that a change of state has occurred. If the input changes (say 0 → 1) and changes again (1 → 0) in less than the debounce time, then the 905 module will ignore both changes. Debounce may be configured for digital inputs on the 905-1 and 905-2 modules (0.5 - 8 seconds) and the analogue inputs on the

905-2 module (0.5 - 8 seconds). The default value of 0.5 seconds is suitable for most applications. In applications where a digital input may turn on and off several times slowly (for example, security switches or float switches) a debounce time of up to 8 seconds may be configured. *The configured debounce time has no affect on pulse inputs.*

Note that the analogue debounce is not configurable for the 905-1, but is configurable in the 905-2.

Set-points allow a remote digital output to be turned on and off depending on the value of an analogue input. The “set-point status” internal input must be mapped to an output for this option to have effect. When the AI is less than the Low Set-point (LSP), the set-point status will be active (on, “1”) - when the AI is more than the High Set Point (HSP), the set-point status will be reset (off, “0”). Note that the High Set Point (HSP) must always be higher than the Low Set Point (LSP). For the 905-1 module, only AI1 has set-point values. For 905-2 modules, all six analogue inputs have set-points.

Debounce time operates on the set-point status in the same way as digital inputs.

Pulse Rate Scale is used when pulse rate is mapped to an analogue output. The pulse rate scale configures the maximum expected pulse input frequency. This is the frequency for which the pulse rate input indicates the maximum value (20 mA if mapped to an analogue output). On the 905-1, the maximum value is 100 Hz. On the 105-2, the maximum value is 1000 Hz for input 1, and 100 Hz for inputs 2-4.

Pulse input 1 on the 905-2 module can measure pulse signals up to 1000 Hz, however all pulse outputs have a maximum rate of only 100 Hz. For pulse inputs greater than 100 Hz, a Divide-by-10 function should be configured. The input count is then divided by 10 before transmitting. The default is 100Hz (no divide-by-10). Where the 1000Hz option is configured, then each output pulse means 10 pulses (or 10 counts).

Pulse Output Update is the time which pulses are output after a PI update is received. It should be configured to correspond to the pulse input update time for the corresponding pulse input. This ensures that the pulse output rate matches as closely as possible the pulse input rate which it is reflecting.

For example, if the PI update time is 1 minute, then the PO update time should also be 1 minute. If the PI update time is changed, then the PO update time at the remote module should be also changed. The PO will still operate if the time is not changed, however pulses may be output faster or slower than the input pulses.

4.3.5 Programming / Downloading Configuration

Transferring configuration to the 905 Module

Once editing of the configuration is complete, the configuration must be loaded into the 905 before the new configuration takes effect. Before proceeding, close any other programmes on the PC that is using the communications port.

- Connect the cable from the PC's serial port to the 905 serial port.
- From the Communication menu, select “Select Comms Port”

- Select the appropriate serial port from the list provided (COM1 - COM4)
- From the Communication menu, select “Program The 105”

The configuration program will now attempt to download the configuration data to the 905 module. If all goes well, a “Programming” prompt will appear. This prompt will remain until programming of the 905 is complete. If the 905 is not correctly connected, or is not turned on, it may take up to a minute for the configuration program to stop trying to connect to the 905.

Loading existing Configuration from the 905

To download the configuration from a 905 for editing or simply for checking, follow the following steps:

- Connect the cable from the PC’s serial port to the 905 serial port.
- From the Communication menu, select “Select Comms Port”
- Select the appropriate serial port from the list provided (COM1 - COM4)
- From the Communication menu, select “Load Config from 105”

The configuration program will now attempt to upload the configuration data from the 905. If all goes well, a “Loading” prompt will appear. This prompt will remain until loading of data from the 905 is complete. If the 905 is not correctly connected, or is not turned on, it may take up to a minute for the configuration program to stop trying to connect to the 905.

Chapter Five

SPECIFICATIONS

General		
Radio standards – 905U	FCC Part 15.247	902 – 928 MHz, 1W
Housing	130 x 185 x 60mm DIN rail mount	Powder-coated, extruded aluminium
Terminal blocks	Removable	Suitable for 2.5 mm ² conductors
LED indication	Power supply, OK operation, digital I/O, RX and TX	
Operating Temperature	-20 to 60 degrees C	
Power Supply		
Battery supply	11.3 - 15.0 VDC	
AC supply	12 - 24 VAC, 50/60 Hz	Overvoltage protected
DC supply	15 - 30 VDC	Overvoltage and reverse voltage protected
Mains supply	110-250 VAC	via plug-pack transformer
Battery Charging circuit	Included	for 1.2-12 ahr sealed lead acid battery
Solar regulator	Included	Direct connection of solar panel (up to 30W) and solar battery (100 Ahr)
Current Drain	70 mA quiescent for 'U' 45 mA quiescent for 'S'	+ 10 mA/active digital input + 25 mA/active digital output + 2 x analogue I/O loop (mA)
Analogue loop supply	Included	24V DC 150 mA
Mains fail status	Monitored	Can be transmitted to remote modules
Battery voltage	Monitored	As above
Radio Transceiver (905U)		
Type	Spread Spectrum	Frequency Hopping
Frequency	902 - 928 Mhz	250 kHz channel spacing
Transmit power	Fixed	1 W
Signal detect / RSSI	-120 to -80 dBm	
Aerial Connector	Reverse SMA Coaxial	
Serial Ports		
RS232 Port	DB9 female DCE	9600 baud, no parity, 8 data bits, 1 stop bit
RS485 Port	2 pin terminal block	9600 baud, no parity, 8 data bits, 1 stop bit,

		Typical distance 1km
Data transmission	On change-of-state + integrity update	Update time configurable
Protocol - serial - radio	asynchronous ARQ, with 16 bit CRC synchronous ARQ	Automatic acknowledgments with up to 4 retries
Communications fail status	May be mapped to local or remote output	Resetting of outputs on comms fail configurable
Inputs and Outputs		
Digital Inputs	905-1 Four 105-2 Four 105-3 None	Opto-isolated (5000V)inputs, suitable for voltage free contacts or NPN transistor, contact wetting current 5mA, input debounce 0.5 second
Digital Outputs	105-1 Four	Relay output contacts, normally open, AC1 5A 250V AC3 2A 250V, 5A 120V DC1 5A 30V, 5A 20V DC3 2A 30V, 5A 20V
Digital Outputs	105-2 One 105-3 Eight	FET output, 30 VDC 500mA max.
Pulse Inputs	105-1 One 105-2 Four 105-3 None	Uses DI1. Max rate 100Hz, min. off- time 5msec. Uses DI1-4. Max rate of DI1 is 1000Hz, min. off-time 0.5msec Max rate of DI2-4 is 100Hz, min. off-time 5msec.
Pulse Output	105-1 One 105-2 None 105-3 Four	FET output, 30 VDC 500mA max Max rate for 105-1 is 100 Hz. Max rate for 105-3 is 1000 Hz. Pulse signal recreated, pulse rate avail. on analogue output, (scaling configurable). Divide-by-10 available for 1000Hz inputs.
Analogue Inputs	105-1 Two 4-20 mA 105-2 Six 0-20mA	“floating” differential input, common mode voltage -0.5V to 27V. 24 VDC for powering external loops provided, 150 mA max. Resolution 15 bit,

	105-3 None	Accuracy 10 bit, Digital filter time constant 1 second (config.)
Analogue Input Setpoints	105-1 AI 1 only 105-2 AI 1-6	Configurable high & low set-points, allowing set/reset of remote digital outputs
Analogue Outputs	105-1 Two 4-20mA 105-2 None 105-3 Eight 0-20mA	current sink to common, max loop voltage 27V, Resolution 15 bit Accuracy 10 bit (0.016mA)
System Parameters		
Network Configurations	Communications via radio or RS485 or network of both	Up to 95 radio units with up to 32 serial units off each radio unit
Mapping	Any input to any output in system	
User Configuration		Via on-board DIP switches or RS232 terminal or laptop
Diagnostics		
On board diagnostics	Automatic check on start-up Via RS232 terminal or laptop	Input status Output test Incoming radio signal level Simple radio path testing

Chapter Six TROUBLESHOOTING

6.1

Diagnostics Chart

INDICATOR	CONDITION	MEANING
OK LED OFF	Continuously	<ul style="list-style-type: none"> Battery Voltage low CPU failure +24V supply failure/overload
OK LED ON	Continuously	<ul style="list-style-type: none"> Normal Operation
PWR LED ON	Continuously	<ul style="list-style-type: none"> Supply available from SUP1/SUP2 Supply available from solar panel
TX LED ON	Flashes briefly	<ul style="list-style-type: none"> Radio transmitting
RX LED ON	Flashes briefly	<ul style="list-style-type: none"> Radio Receiving Serial port communicating
RX LED ON	Flashes continuously	<ul style="list-style-type: none"> Module in Configuration Mode
RX LED ON	Continuously	<ul style="list-style-type: none"> Test Button press in Configuration Mode
No transmission on change of state		<ul style="list-style-type: none"> Unit not configured correctly - re-configure and check operation

The green OK LED on the front panel indicates correct operation of the unit. This LED extinguishes on failure as described above. When the OK LED extinguishes shutdown state is indicated. In this state, all digital outputs turn OFF and the +24V supply turns off.

On processor failure, or on failure during start-up diagnostics, the unit shuts down, and remains in shutdown until the fault is rectified. The unit also shuts down if the battery voltage falls below 10.8 volts. This is a protection feature designed to protect the battery from deep discharge in case of extended period without supply voltage.

6.2

Self Test Functions

6.2.1 Input to Output Reflection (105-1 only)

The unit will require re-configuration after SELF TEST. Ensure you know the required operational configuration including system and unit addresses so that the network can be restored after testing.

Remove the cover in the front panel, and set the DIP switches as shown below. Hold down the red button for five seconds, or until the Rx LED glows yellow, release the Red button (the Rx LED now flashes), then press and release the Red button (the flashing Rx LED extinguishes).

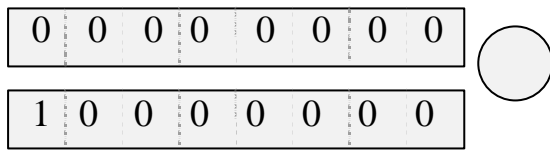

Input signals may now be connected to the input terminals of the module. If the module is operating correctly, then the input signals will be reflected to the corresponding output on the same module. For example, if DI 1 is connected to common - i.e. the first digital input is turned "ON" - then DO 1 will activate, if the module is functional. Similarly, if a 12mA signal is connected to AI 2, then a 12mA signal should be able to be measured from AO 2, if the module is functioning correctly.

If a module does not pass its self test function, then it should be returned to an authorised service agent for attention

6.2.2 Radio Testing using Tone Reversals

This function allows the unit to be configured to continuously transmit a sequence of alternate zeros and ones on the radio. This function provides the facility to check VSWR of aerials during installation, as well as checking the fade margin of the path between two units (see below - received signal strength indication).

The tone reversals function is initiated by setting all of the DIL switches to ON, and holding down the red button for approximately 5 seconds (until the RX LED lights continuously). On releasing the button, the RX LED will flash continuously, and the TX LED will light, indicating that the radio transmitter is on.

6.2.3 Diagnostics menu

To aid in the checking and set-up of the 105 unit, a user friendly menu provides access to diagnostic functions in the 105. Use of the diagnostics menu does not affect module configuration. To access these diagnostics, a terminal must be connected to the serial port on the unit. The terminal may be a standalone terminal, or a personal computer running terminal emulation software.

The terminal or terminal emulation software must be set-up for 9600 baud, 8 data bits, 1 stop bit, no parity.

The menu is accessed by connecting a terminal to the serial (DB9 RS-232) port on the 105 (ensure the RS485 port is disconnected), setting all switches to '0', and holding down the red button for approximately 5 seconds, until the RX LED lights continuously. One of the following menus will be displayed on the terminal :

105 V1.0	1052 V1.0	1053 V1.0
a) Ins	a) Digital Inputs	a) Ins
b) Tones	b) Analogue Inputs	b) Tones
c) Comms	c) Tones	c) Comms
d) DO1	d) Comms	d) DO1
e) DO2	e) DO1	e) DO2
f) DO3	f) Switch	f) DO3
g) DO4	g) Signal	g) DO4
h) AO1	>	h) DO5
i) AO2		i) DO6
j) Switch		j) DO7
k) Signal		k) DO8
>		l) AO1
		m) AO2
		n) AO3
		o) AO4
		p) AO5
		q) AO6
		r) AO7
		s) AO8
		t) Switch
		u) Signal
		>

Choose an item from the menu by entering the letter before that item. For example, to select the "Comms" function from the 105-2 Menu, enter :- d

Inputs

This option provides a dynamic display of the status of all of the inputs in the 105, both internal and external.

105-1 Modules

1234MLS	P CNT	AI1	AI2	P RATE	VBATT
0101001	00F6	C000	4000	8000	9C00

The first 7 values (1234MLS) each represent a single digital input. A '1' indicates that that input is ON, and a '0' indicates that the corresponding input is OFF. "1234" represents the four physical digital inputs, DI1 to DI4. "M" is the mains fail status ('1' for mains fail, '0' for mains OK). "L" is the battery low volts status ('1' for low volts '0' for OK). "S" is the set-point status.

P CNT, AI1, AI2, P RATE, and VBATT each represent 16 bit values, displayed as four hexadecimal digits.

P CNT is the current value of the pulsed input counter. This value should increment each time 'DI 1' turns from OFF to ON. P RATE displays the current pulse rate at DI1. This value is scaled according to the MAXRATE value configured (0 Hertz is displayed as 4000, and the maximum rate is displayed as C000).

AI1 and AI2 represent the value for the two analogue inputs. Full scale input (20 mA) is displayed as C000, 4mA is displayed as 4000, and 0mA is displayed as 2000. Analogue inputs are filtered digitally with a time constant of 1 second, so a sudden change in the analogue input current will result in a slower change in displayed analogue value, finally settling at the new value.

A guide to translate the displayed value to the analogue input current is provided below.

Add together the figures corresponding to each digit in each position to determine the current (mA) e.g. displayed value 3456 = 2.000+0.500+0.039+0.003 = 2.542mA				
Digit	Leftmost position	Next position	Next position	Rightmost position
0	-	0.000	0.000	0.000
1	-	0.125	0.008	0.000
2	0.000	0.250	0.016	0.001
3	2.000	0.375	0.023	0.001
4	4.000	0.500	0.031	0.002
5	6.000	0.625	0.039	0.002
6	8.000	0.750	0.047	0.003
7	10.000	0.875	0.055	0.003
8	12.000	1.000	0.063	0.004
9	14.000	1.125	0.070	0.004
A	16.000	1.250	0.078	0.005
B	18.000	1.375	0.086	0.005
C	20	1.500	0.094	0.006
D	22	1.625	0.102	0.006
E	-	1.750	0.109	0.007
F	-	1.875	0.117	0.007

VBATT is the current internally derived battery voltage. 4000 corresponds to 8 Volts, C000 represents 16 volts. A quicker method is use the calculation :

Battery voltage (volts) = $\frac{1}{2} I + 6$, where I is the mA value determined from the above table using VBATT. For example, a value of VBATT of A000 gives an I value of 16mA from the above table. The battery voltage corresponding to this is 14V (or $\frac{1}{2} \times 16 + 6$).

105-2 Modules

Digital Inputs

DIN SETPNT PULSED

1234MSL123456	PIN1	PIN2	PIN3	PIN4
00001001111111	0000	0000	0000	0000

Analogue Inputs

VBAT	PR1	PR2	PR3	PR4	AI1	AI2	AI3	AI4	AI5	AI6
8138	4000	4000	4000	4000	0D3A	0CD2	0CC7	0CC7	0CD4	0CC7

105-3 Modules

ML	VBAT	VSLR
00	9FA2	0000

Tones

This provides the same function as described above in 6.2.2. Tone Reversals. This function may be used in conjunction with the Signal option (described below) to check the path between two 105 units.

Comms

This function allows monitoring of all messages transmitted and received over the radio. Transmitted messages are displayed starting in the leftmost column of the display. Received messages are displayed indented by one space. Received messages which have been corrupted are displayed with a '*' in the first column of the display. The first four hexadecimal digits are the system address attached to the message, and must match for units to communicate successfully.

Example (105-1):

>c

Comms

01FA8106008005C672D4F1	Command message transmitted by this unit.
*01FA8186C6B5A7	Corrupt Acknowledge received from remote.
01FA8106008005C672D4F1	Message re-transmitted by this unit. (no Ack)
01FA818600B5A7	Valid Acknowledge received from remote.
*01FB86010080010000FEC2	Corrupt message received from remote unit.
01FA86010080010000FEC2	Re-sent message received from remote unit.
01FA868100332F	Acknowledge message from this unit to remote.

DO1 to DO8

These options allow the user to set and clear digital outputs. To set an output, select the corresponding menu item, at the prompt, type the value FFFF to turn the output ON, or 0000 to turn the output OFF. For example, to set DO1 ON,

>e

DO1

>FFFF

AO1 to AO8

These options allow the user to set analogue outputs to any value. To set the output, select the corresponding menu item. At the prompt type the value required for the analogue output as a four digit hexadecimal value. Refer to the table above for analogue current/expected value relationship. To set AO2 on 105-3 to 19 mA :

```
>m
AO2
>B800
```

Switch

This option allows testing of the DIL (Dual In Line) switches used for the configuration of the module. The diagram below indicates the layout of the switches of which there are two sets of eight, with an "Enter" button located to the right of the pair. the display indicates the current switch settings with the digit '1' corresponding to 'On' and the digit '0' corresponding to 'Off'. Changing the switch settings in this mode will change the display. Test each switch and check to ensure the display changes accordingly.

When the 'Enter' button is pressed, regardless of the previous switch setting, switches 1, 5, 9 and 13 will display as a '1' 0 x

Switches '1' or '0' **Button** Not Pressed = Pressed =

	O	
<u>Switches</u>		<u>Displayed</u>
1 1 1 0 0 0 1 0		1110001001010101
0 1 0 1 0 1 0 1		

	X	
1 1 1 0 0 0 1 0		1110101011011101
0 1 0 1 0 1 0 1		
		1 5 9 13

Signal

This option provides for testing the radio path between two 105-U units for a suitable fade margin. Although a pair of units may communicate successfully, radio communication may be affected by a

range of influences, including atmospheric conditions, changing landscape, degradation of aerials or co-axial cable, low battery voltage etc. Fade margin is an indication of how far a radio path can deteriorate before communication becomes unreliable.

When using the Signal feature, a meter is displayed with a mark indicating the current received radio signal level. To check the radio path between two units, select the signal option at the local unit. The remote unit may then be set up for tone reversals (refer 1 above) and the signal level read from the meter.

A simpler method when remote units are not easily accessible is to cause a transmission from the local unit to the remote unit (by setting a digital input which maps to the remote unit, for example). The meter will latch the received signal from the remote unit for half a second, allowing the received level to be read.

Under normal radio conditions, a reading of 0 indicates a very marginal communication path. For reliable communications, the signal reading should be 3 or above.

>k Minimum signal level for reliable comms

Signal

0123456789----

#

In areas experiencing radio interference or high background noise, reliable communications may not be achievable even with this signal level. To determine if interference is occurring the signal option may be selected without any other 105 units active. In a normal radio environment, no reading should be displayed. If a reading is displayed, then the received signal strength from the remote should be at least three counts higher than the background noise for reliable communication.

>k Displayed signal level of

Signal background noise/interference

0123456789----

#

>k Minimum signal level for reliable comms

Signal

0123456789----

#

When using directional aerials (i.e. YAGI aerials) this feature may be used to peak the received signal level. Set-up the remote unit to transmit tone reversals as described above, and observe the signal indication while adjusting the orientation of the aerial. A peak in signal level indicates optimum orientation of the aerial.

Chapter Seven WARRANTY & SERVICE

We are pleased that you have purchased this product. Your purchase is guaranteed against defects for a 365 day warranty period, commencing from the date of purchase.

This warranty does not extend to:

- Failures caused by the operation of the equipment outside the particular product's specification.
- use of the 105 module not in accordance with this User Manual, or
- abuse, misuse, neglect or damage by external causes, or
- repairs, alterations, or modifications undertaken other than by an authorised Service Agent.

Full product specifications and maintenance instructions are available from your Service Agent, your source of purchase, or from the master distributor in your country upon request and should be noted if you are in any doubt about the operating environment for your equipment purchase

In the unlikely event of your purchase being faulty, your warranty extends to free repair or replacement of the faulty unit, after its receipt at the master distributor in your country. Our warranty does not include transport or insurance charges relating to a warranty claim.

This warranty does not indemnify the purchaser of products for any consequential claim for damages or loss of operations or profits.

Should you wish to make a warranty claim, or obtain service, please forward the module to the nearest authorised Service Agent along with proof of purchase. For details of authorised Service Agents, contact your sales distributor.

Appendix A SYSTEM EXAMPLE

The following example of a system is a comprehensive guide to using some of the features of the 105 range and design of 105 system.

The example application is a pump station which supplies water from a reservoir to a tank station. Signals are transferred between the pump station and tank station by radio - the distance between the two stations is 1.5 km (1 mile), and the radio path is heavily obstructed by buildings and trees. A control station is located near the pump station, and there is an existing signal cable between the control station and the pump station.

A 105U-1 module is installed at the pump station (with address 1) and a 105U-2 module is installed at the tank station (with address 2). Because the signal cable to the control station does not have enough cores for all of the signals required, the signal cable is used as a RS485 cable and a 105S-3 module is installed at the control station (with address 96). As this module has an address greater than 95, the 105U-1 at the pump station will communicate to it via its serial port.

The following diagram represents the system :-

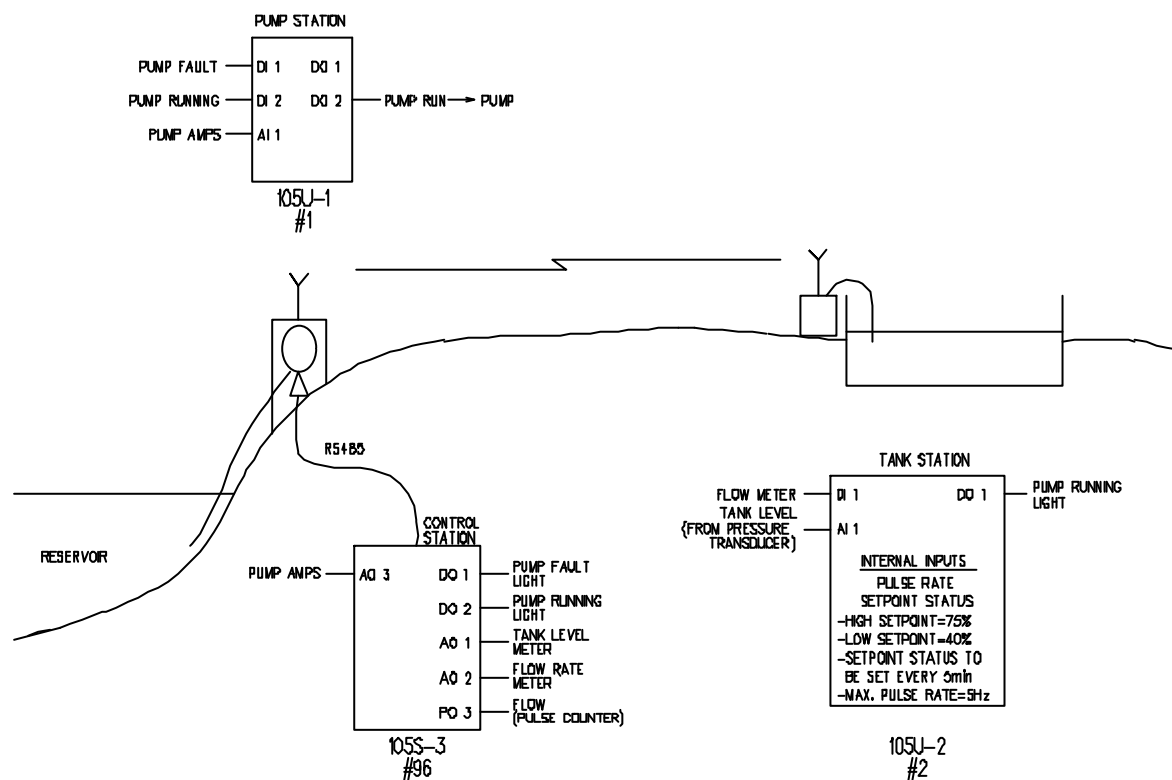

The following design points should be noted :-

- A test of the radio path between the pump station and the tank station indicated that the radio path would be reliable provided aerials were installed at 6 m above the ground. At each site, the coaxial cable would be approx 10 m in length, so it was decided to use 3 element Yagi aerials with RG58 coaxial cable - the Yagi aerials would compensate for the loss in the cable.

The system was installed in a country which permitted the use of 500mW radio power. If this had not been the case, then an intermediate repeater station would have been required.

- At the tank station, there was an existing light pole with a mains power supply - the light pole was 10m high. Permission was obtained to mount the aerial from the pole and to use the power supply for the radio telemetry module.

As there was no existing electrical panel at this station, a small steel enclosure was installed on the light pole. A 2 Amp-Hour sealed battery was installed to provide power during any mains failure. The flow and level transducer were powered from the 24VDC loop supply provided by the 105 module.

- At the pump station, the aerial was mounted on a 3 m J-bracket installed on the roof of the pump station building. The final height of the aerial was approx 6 m. Care was taken to align the Yagi aerials so they pointed at each other. The Yagi aerials were installed with horizontal polarity - that is, with the elements horizontal. These aerials will not "hear" other radio users on the same radio channel which generally use vertical polarity.

There was an existing electrical enclosure at the pump station, and the 105U module was installed inside this enclosure. The module was powered from 220VAC mains with a 2 Amp Hour sealed battery as backup.

- At the control station, the 105S module was installed inside the existing control panel enclosure. The module was powered from an existing 24VDC power supply.

Tank Station Configuration

The 105U-2 module has the following configuration :-

```

File User Options Communication
105-2 Configuration Software

System Address      Mappings
10587              PIN 1 -> Out3 at 96 via 1
                  PLSR 1 -> Out2 at 97 via 1
                  AIN 1 -> Out1 at 97 via 1
                  SEPT 1 -> Out2 at 1
                  LOW VOLT -> Out7 at 96 via 1
                  STARTUP POLL -> 1

Unit Address
2

Out      105 Type
         -1 -2 -3L -3H
Out1    D01 D01 D/P1 A01
Out2    D02 -   D/P2 A02
Out3    D03 -   D/P3 A03
Out4    D04 -   D/P4 A04
Out5    A01 -   D05 A05
Out6    A02 -   D06 A06
Out7    PULS -  D07 A07
Out8    -   -   D08 A08

Current File:  C:\MYDOCU~1\EXTANK.205

Alt-X Exit

```

```

[■]===== User Configuration Summary =====
Update Times (Min)
DIN 1    DIN 2    DIN 3    DIN 4    INU D1    INU D2    INU D3    INU D4
10.0 min 10.0 min 10.0 min 10.0 min 10.0 min 10.0 min 10.0 min 10.0 min
PIN 1    PIN 2    PIN 3    PIN 4    MNS FAIL  SLR AUL   LOW VOLT  UBATT
1.0 min  1.0 min  1.0 min  1.0 min  10.0 min  10.0 min  15.0 min  10.0 min
PLSR 1   PLSR 2   PLSR 3   PLSR 4   AIN 1    AIN 2    AIN 3    AIN 4
10.0 min 10.0 min 10.0 min 10.0 min 10.0 min 10.0 min 10.0 min 10.0 min
AIN 5    AIN 6    SETPT 1  SETPT 2  SETPT 3  SETPT 4  SETPT 5  SETPT 6
10.0 min 10.0 min 5.0 min  10.0 min 10.0 min 10.0 min 10.0 min 10.0 min

Analog Sensitivity (%)
PLSR 1   PLSR 2   PLSR 3   PLSR 4   AIN 1    AIN 2    AIN 3    AIN 4    AIN 5    AIN 6
3.1 %    3.1 %    3.1 %    3.1 %    3.1 %    3.1 %    3.1 %    3.1 %    3.1 %    3.1 %

Setpoint Configuration
AIN 1    AIN 2    AIN 3    AIN 4    AIN 5    AIN 6
Low 40.0 % 29.7 % 29.7 % 29.7 % 29.7 % 29.7 %
High 75.0 % 70.3 % 70.3 % 70.3 % 70.3 % 70.3 %

Maximum Rate (Hz)
PIN 1    PIN 2    PIN 3    PIN 4
5.00    100.0    100.0    100.0

Debounce Time (sec)
Digital  Analogue
0.52 sec 2.03 sec

Drop Output      Pulsed Input #1
Never            No Divide

```

Note the following points in the configuration :

- The configuration software used was CFG105-2.EXE as the module is a 105U-2.
- The system address is 10587 (a random selection) and unit address is 2.
- PIN1 (the flow meter) is mapped to Out3 (D/P output 3) at #96 which is the control station - #1 is a repeater.
- The pulse rate for this PIN (PLSR1) is mapped to Out2 at #97 via #1. This is AO2 of the 105S-3 at the control station. Remember that the 105S-3 has two addresses - the lower address is used for the digital outputs, and the higher address is used for the analogue outputs.

- The pulse rate scaling for PIN1 has been set to 5 Hz to match the maximum flow rate of the flow meter. Note that PIN1 has not been configured for "divide by 10" (for 1000 Hz pulse signals).
- AIN1 (the level transducer) is mapped to Out1 at #97 via #1. The analogue debounce has been set to 2 sec. This is to avoid any wave action on the surface of the tank causing un-necessary change transmissions. This debounce time will also operate on the PLSR1 value, but as the flow rate changes slowly, this will not affect the performance of this signal.
- SETPT1 (the set-point status for AI1) is mapped to Out2 (DO2) of #1 (pump station). The set-point values for SETPT1 have been set to 40% and 75%. When the tank level drops to 40%, DO2 at the pump station will activate to start the pump. When the level rises above 75%, DO2 will reset to stop the pump.
- The update time for SETPT1 has been changed to 5 minute, as required.
- An additional mapping has been entered - LOW VOLT has been mapped to Out7 at #96 via #1 (DO7 at the control station). This mapping is for future use - it will provide a low battery voltage alarm for the tank station. The update time for this mapping has been set to the maximum time of 15 minutes to reduce loading of the radio channel.
- A Start-up poll has been configured for #1, as DO1 at the tank station is controlled from the pump station. Note that no comms fail reset time has been configured for DO1. As this output drives an indication only, the indication will show the last correct status even during communication failures.

Pump Station Configuration

The 105U-1 module has the following configuration :-

```

File  User Options  Communication
                                105-1 Configuration Software

System Address  Mappings
10587          DIN 1 -> Out 1 at 96
              DIN 2 -> Out 2 at 96
              DIN 2 -> Out 1 at 2
              AIN 1 -> Out 3 at 97
              LOW VOLTS -> Out 8 at 96
              STARTUP POLL -> 1

Unit Address
1

Out      105 Type
        -1  -2  -3L  -3H
Out1    D01  D01  D/P1  A01
Out2    D02  -    D/P2  A02
Out3    D03  -    D/P3  A03
Out4    D04  -    D/P4  A04
Out5    A01  -    D05   A05
Out6    A02  -    D06   A06
Out7    PULS -    D07   A07
Out8    -    -    D08   A08

                                Current File:  C:\MYDOCU~1\EXPUMP.105

Alt-X Exit

```

User Configuration Summary					
Update Times (Min)					
DIN 1	DIN 2	DIN 3	DIN 4	MAINS	LOW VOLTS
10.0 min	10.0 min	10.0 min	10.0 min	10.0 min	10.0 min
SETPOINT	PLS COUNT	AIN 1	AIN 2	PLS RATE	UBATT
10.0 min	1.0 min	10.0 min	10.0 min	10.0 min	10.0 min
Analog Sensitivity (%)			Setpoint Configuration		
AIN 1	AIN 2	PLS RATE	Low	High	
3.1 %	3.1 %	3.1 %	29.7 %	70.3 %	
Drop Output Times (min)					
DOT 1	DOT 2	DOT 3	DOT 4	AOT 1	AOT 2
None	11.00	None	None	None	None
Pulse Out Update		Max Rate (Hz)	Digital Debounce (sec)		
1.00 min		100.000	0.52 sec		

Note the following points in the configuration :

- The configuration software used was CFG105-1.EXE as the module is a 105U-1.
- The system address is 10587 (same as before) and unit address is 1.
- DIN1 (pump fault signal) is mapped to Out1 (DO1) at #96 which is the control station. Note that no repeater address is necessary as there is a direct link between #1 and #96.
- DIN2 (pump running signal) has two mappings - a mapping to DO1 at #2 (tank station) and DO2 at #96 (control station). When DIN2 changes, there will be two separate change messages transmitted - one by radio to #2 and one by serial link to #96.
- AIN1 (pump amps) is mapped to Out3 at #97 (AO3 at control station).
- An additional mapping has been entered - LOW VOLT has been mapped to Out8 at #96 (DO8 at the control station). This mapping is for future use - it will provide a low battery voltage alarm for the pump station.
- A Start-up poll has been configured for #2, as DO2 at the pump station is controlled from the tank station. Note that a comms fail reset time of 11 minutes has been configured for DO2. This means that if a message has not been received for DO2 within 11 minutes, DO2 will reset and switch off the pump. The 11 min time was chosen as it means that two successive update messages have to be missed before the pump is reset, and there is no problems if the pump runs for 11 minutes during a system failure (the tank will not overflow during this time).

Control Station Configuration

The 105S-3 module has the following configuration :-

```

File  User Options  Communication
                                105-3 Configuration Software

System Address      Mappings
10587              STARTUP POLL -> 1
                   STARTUP POLL -> 2 via 1

Unit Address
96

Out   105 Type
     -1  -2  -3L  -3H
Out1  D01  D01  D/P1  A01
Out2  D02  -   D/P2  A02
Out3  D03  -   D/P3  A03
Out4  D04  -   D/P4  A04
Out5  A01  -   D05  A05
Out6  A02  -   D06  A06
Out7  PULS -   D07  A07
Out8  -   -   D08  A08

Current File:  C:\MYDOCU~1\EXCONTRL.305

Alt-X Exit

```

```

[ ] User Configuration Summary

Update Times (Min)
MAINS      LOW VOLTS      BATT VOLT      SOLR VOLT
10.0 min   10.0 min             10.0 min       10.0 min

Drop Output Times (min)
DOT 1      DOT 2      DOT 3      DOT 4      DOT 5      DOT 6      DOT 7      DOT 8
None       None        None       None       None       None       None       None
AOT 1      AOT 2      AOT 3      AOT 4      AOT 5      AOT 6      AOT 7      AOT 8
21.0 m     21.0 m     21.0 m     None       None       None       None       None

Pulsed Output Update Time
Pulse 1    Pulse 2    Pulse 3    Pulse 4
1.0 min    1.0 min    1.0 min    1.0 min

Pulsed Output Configuration
Pulse 1    Pulse 2    Pulse 3    Pulse 4
Disabled   Disabled   Enabled    Disabled

```

Note the following points in the configuration :

- The configuration software used was CFG105-3.EXE as the module is a 105S-3.
- The system address is 10587 (same as before) and unit address is 96. As the module is a 105-3 module, it will automatically assume addresses #96 and #97.
- The only mappings are Start-up polls. Note that there are two separate polls, one for each remote module.
- D/P Out 3 has been configured as a PO. Its pulse output update time is the same as the PI update time at the remote module (both have been left at their default value of 1 minute).
- Comms fail reset times have been selected for the analogue outputs (21 minutes) but not the

digital outputs. In the event of a system failure, the digital outputs will stay at their last correct status, but the analogue outputs will reset to 0 mA.

System Failure Alarm

After the system had been running for some time, the operators wanted a "system failure" output at the control station, to warn the operators that there was a fault with the system.

The following configuration was added :

At #2 (tank station), NOT DI4 → Out4 at 96 via 1 ; DI4 Update time = 1 minute

At #96 (control station), DO4 Comms fail reset time = 3.5 min

At the control station, DO4 was a "system OK" signal. It was normally active - if the signal reset, then this represented a system failure. At the tank station, there is no signal wired to DI4. By mapping NOT DI4 to DO4 at the control station, a message is transmitted every minute to this output to activate it. The message is transmitted via the radio link to #1, and then by the serial link to #96. If anything happened to either module #2 or module #1, or the radio link, or the serial link, then the update messages for DO4 will not be received at the control station module. After 3.5 Minutes, DO4 will reset indicating a problem.

The time of 3.5 minutes was selected as this means that 3 successive update messages have to be missed before a system alarm occurs. Also note, that if module #96 fails, DO4 will reset and give an alarm signal.