



FCC Test Report

According to

47 CFR Part 22H, 24E

Equipment : PCI Extreme
Trade Name : Wavecom
Model Name : PCIE-100
FCC ID : O9EPCIE100
Tx Frequency Range : GSM850 : 824.2 ~ 848.8MHz
GSM1900 : 1850.2 ~ 1909.8 MHz
WCDMA Band V : 826.4 ~ 846.6 MHz
WCDMA Band II : 1852.4 ~ 1907.6 MHz
Max. ERP/EIRP Power : GSM850(GPRS) : 0.76 W
GSM850(EDGE) : 0.15 W
GSM1900(GPRS) : 0.48 W
GSM1900(EDGE) : 0.19 W
WCDMA Band V : 0.06 W
WCDMA Band V(HSUPA) : 0.05 W
WCDMA Band II : 0.10 W
WCDMA Band II(HSUPA) : 0.09 W
Emission Designator : GSM : 300KGXW
EDGE : 300KG7W
WCDMA : 4M22F9W
Applicant : Wavecom S.A.
3 esplanade du Foncet, Issy-les-Moulineaux, 92442 Cedex
- France

- The test result refers exclusively to the test presented test model / sample.
- Without written approval of SPORTON International Inc., the test report shall not be reproduced except in full.
- **Certificate or Test Report must not be used by the applicant to claim the product in this test report endorsement by NVLAP or any agency of U.S. government.**
- The data shown in this test report were carried out on Aug. 10, 2008 at **Sporton International Inc. LAB.**
- Report No.: FG863020, Report Version: Rev. 01.



Roy Wu
Manager

SPORTON International Inc.

No. 52, Hwa Ya 1st Rd., Hwa Ya Technology Park, Kwei-Shan Hsiang, Tao Yuan Hsien, Taiwan, R.O.C.

SPORTON International Inc.

TEL : 886-3-327-3456

FAX : 886-3-328-4978

Report Version: Rev. 01



Table of Contents

History of This Test Report ii

1. General Information 1

1.1 Applicant..... 1

1.2 Manufacturer 1

1.3 Feature of Equipment under Test..... 1

2. Test Configuration of Equipment under Test 2

2.1 Test Manner 2

2.2 Test Mode 2

2.3 Connection Diagram of Test System 3

2.4 Ancillary Equipment List 3

3. General Information of Test Site..... 4

3.1 Test Voltage 4

3.2 Test Compliance..... 4

3.3 Frequency Range..... 4

3.4 Test Distance..... 4

4. Test Data and Test Result 5

4.1 List of Measurements and Examinations 5

4.2 RF Output Power..... 6

4.3 ERP / EIRP Measurement..... 9

4.4 Occupied Bandwidth and Band Edge Measurement 15

4.5 Conducted Emission..... 80

4.6 Field Strength of Spurious Radiation 117

4.7 Frequency Stability (Temperature Variation) 135

4.8 Frequency Stability (Voltage Variation) 140

5. List of Measurement Equipments 142

6. Uncertainty Evaluation 143

Appendix A. Photographs of EUT

Appendix B. Setup Photographs



1. General Information

1.1 Applicant

Wavecom S.A.

3 esplanade du Foncet, Issy-les-Moulineaux, 92442 Cedex - France

1.2 Manufacturer

Wavecom S.A.

3 esplanade du Foncet, Issy-les-Moulineaux, 92442 Cedex - France

1.3 Feature of Equipment under Test

Product Feature & Specification	
Tx Frequency :	GSM850 : 824 MHz ~ 849 MHz GSM1900 : 1850 MHz ~ 1910 MHz WCDMA Band V : 824 MHz ~ 849 MHz WCDMA Band II : 1850 MHz ~ 1910 MHz
Rx Frequency :	GSM850 : 869 MHz ~ 894 MHz GSM1900 : 1930 MHz ~ 1990 MHz WCDMA Band V : 869 MHz ~ 894 MHz WCDMA Band II : 1930 MHz ~ 1990 MHz
Channel Spacing :	GSM / WCDMA : 200 KHz
Maximum Output Power to Antenna :	GSM850 : 32.48 dBm GSM1900 : 29.02 dBm WCDMA Band V : 22.24 dBm WCDMA Band II : 22.43 dBm
Maximum ERP/EIRP :	GSM850(GPRS) : 0.76 W (28.81 dBm) GSM850(EDGE) : 0.15 W (21.74 dBm) GSM1900(GPRS) : 0.48 W (26.84 dBm) GSM1900(EDGE) : 0.19 W (22.76 dBm) WCDMA Band V : 0.06 W (18.04 dBm) WCDMA Band V(HSUPA) : 0.05 W (17.32 dBm) WCDMA Band II : 0.10 W (19.87 dBm) WCDMA Band II(HSUPA) : 0.09 W (19.32 dBm)
HW Version :	V410
SW Version :	CL114192
GPRS / EGPRS Multislot class :	12
Type of Modulation :	GSM / GPRS : GMSK EDGE : 8PSK WCDMA / HSDPA / HSUPA : QPSK
DUT Stage :	Production Unit



2. Test Configuration of Equipment under Test

2.1 Test Manner

1. The spurious emission measurements were carried out in semi-anechoic chamber with 3-meter test range.
2. During all testings, EUT is in link mode with base station emulator at maximum power level.
3. Frequency range investigated: radiated emission 30 MHz to 9000 MHz for GSM850 and WCDMA Band V; 30MHz to 19000 MHz for GSM1900 and WCDMA Band II.

2.2 Test Mode

Application	GSM850	GSM1900
Radiated Emission	<input checked="" type="checkbox"/> Mode 1: GPRS Link	<input checked="" type="checkbox"/> Mode 3: GPRS Link
	<input checked="" type="checkbox"/> Mode 2: EDGE Link	<input checked="" type="checkbox"/> Mode 4: EDGE Link
Conducted Measurement	<input checked="" type="checkbox"/> Mode 1: GPRS Link	<input checked="" type="checkbox"/> Mode 3: GPRS Link
	<input checked="" type="checkbox"/> Mode 2: EDGE Link	<input checked="" type="checkbox"/> Mode 4: EDGE Link

Application	WCDMA Band V	WCDMA Band II
Radiated Emission	<input checked="" type="checkbox"/> Mode 5: WCDMA Link	<input checked="" type="checkbox"/> Mode 7: WCDMA Link
	<input checked="" type="checkbox"/> Mode 6: HSUPA Link	<input checked="" type="checkbox"/> Mode 8: HSUPA Link
Conducted Measurement	<input checked="" type="checkbox"/> Mode 5: WCDMA Link	<input checked="" type="checkbox"/> Mode 7: WCDMA Link
	<input checked="" type="checkbox"/> Mode 6: HSUPA Link	<input checked="" type="checkbox"/> Mode 8: HSUPA Link

2.3 Connection Diagram of Test System

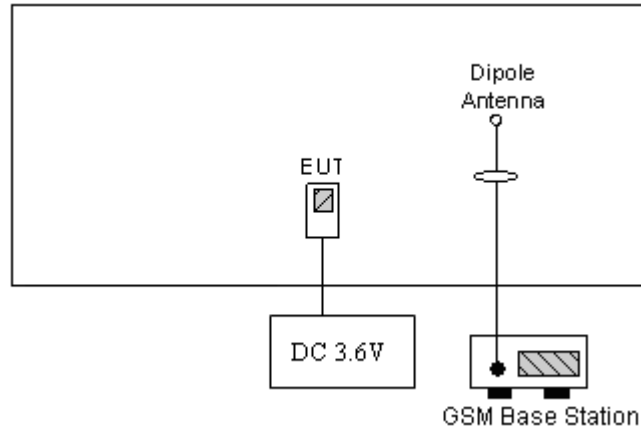

2.4 Ancillary Equipment List

Item	Equipment	Trade Name	Model No.	FCC ID	Data Cable	Power Code
1.	GSM Base Station	R&S	CMU200	N/A	N/A	Unshielded, 1.8m
2.	DC Power Supply	GW	GPC-60300	N/A	N/A	Unshielded, 1.8m



3. General Information of Test Site

Test Site Location : No. 52, Hwa Ya 1st Rd., Hwa Ya Technology Park,
Kwei-Shan Hsiang, Tao Yuan Hsien, Taiwan, R.O.C.
TEL : 886-3-327-3456
FAX : 886-3-328-4978
Test Site No : 03CH07-HY, TH02-HY
FCC Designation No : TW1022

The chamber meets the characteristics of ANSI C63.4-2003. This site is on file with the FCC.

3.1 Test Voltage

DC 3.6V

3.2 Test Compliance

47 CFR Part 22H, 24E, Part 2

Preliminary Guidance for Receiving Applications for Certification of 3G Device. May 9, 2006.

3.3 Frequency Range

- a. Radiation: from 30MHz to 9000MHz for GSM850 and WCDMA Band V.
- b. Radiation: from 30 MHz to 19000 MHz for GSM1900 and WCDMA Band II.

3.4 Test Distance

The test distance of radiated emission from antenna to EUT is 3 m.



4. Test Data and Test Result

4.1 List of Measurements and Examinations

FCC Rule	Description of Test	Result	Section
§2.1046	RF Output Power	Passed	4.2
§22.913 §24.232	ERP / EIRP	Passed	4.3
§2.1049, §22.917, §24.238(b)	Occupied Bandwidth & Band Edge Measurement	Passed	4.4
§2.1051	Conducted Emission	Passed	4.5
§2.1053	Field Strength of Spurious Radiation	Passed	4.6
§2.1055, §22.355, §24.235	Frequency Stability vs. Temperature	Passed	4.7
§2.1055, §22.355, §24.235	Frequency Stability vs. Voltage	Passed	4.8

4.2 RF Output Power

4.2.1 Measurement Instruments

As described in chapter 5 of this test report.

4.2.2 Test Procedure

- a. The transmitter output was connected to power meter and base station.
- b. Set the EUT at maximum power through base station by using below setting:
 - b1. PCL=5 for GSM850, PCL=0 for GSM1900.
 - b2. TPC with All Up Bits for WCDMA.
- c. Select lowest, middle, and highest channels for each band.

4.2.3 Test Setup Layout



4.2.4 Test Result

Bands	Channel	Frequency (MHz)	Conducted Power (dBm)	Conducted Power (Watts)
GSM850 (GPRS)	128	824.2 (Low)	32.48	1.77
	189	836.4 (Mid)	32.45	1.76
	251	848.8 (High)	32.04	1.60
GSM850 (EDGE)	128	824.2 (Low)	25.84	0.38
	189	836.4 (Mid)	25.95	0.39
	251	848.8 (High)	26.10	0.41
GSM1900 (GPRS)	512	1850.2 (Low)	29.00	0.79
	661	1880.0 (Mid)	28.97	0.79
	810	1909.8 (High)	29.02	0.80
GSM1900 (EDGE)	512	1850.2 (Low)	24.65	0.29
	661	1880.0 (Mid)	24.66	0.29
	810	1909.8 (High)	24.80	0.30



Bands	Channel	Frequency (MHz)	Conducted Power (dBm)	Conducted Power (Watts)
WCDMA Band V (12.2k bps)	4132	826.4 (Low)	21.70	0.15
	4182	836.4 (Mid)	21.70	0.15
	4233	846.6 (High)	21.78	0.15
WCDMA Band V (64k bps)	4132	826.4 (Low)	21.70	0.15
	4182	836.4 (Mid)	21.70	0.15
	4233	846.6 (High)	21.78	0.15
WCDMA Band V (144k bps)	4132	826.4 (Low)	21.97	0.16
	4182	836.4 (Mid)	21.92	0.16
	4233	846.6 (High)	21.93	0.16
WCDMA Band V (384k bps)	4132	826.4 (Low)	21.85	0.15
	4182	836.4 (Mid)	21.78	0.15
	4233	846.6 (High)	21.68	0.15
WCDMA Band V (AMR)	4132	826.4 (Low)	22.24	0.17
	4182	836.4 (Mid)	22.19	0.17
	4233	846.6 (High)	22.20	0.17
WCDMA Band V HSDPA-subtest 1	4132	826.4 (Low)	21.56	0.14
	4182	836.4 (Mid)	21.38	0.14
	4233	846.6 (High)	21.32	0.14
WCDMA Band V HSDPA-subtest 2	4132	826.4 (Low)	21.49	0.14
	4182	836.4 (Mid)	21.24	0.13
	4233	846.6 (High)	21.22	0.13
WCDMA Band V HSDPA-subtest 3	4132	826.4 (Low)	21.40	0.14
	4182	836.4 (Mid)	21.32	0.14
	4233	846.6 (High)	21.24	0.13
WCDMA Band V HSDPA-subtest 4	4132	826.4 (Low)	21.24	0.13
	4182	836.4 (Mid)	21.16	0.13
	4233	846.6 (High)	21.01	0.13
WCDMA Band V HSUPA-subtest 1	4132	826.4 (Low)	22.00	0.16
	4182	836.4 (Mid)	21.99	0.16
	4233	846.6 (High)	21.92	0.16
WCDMA Band V HSUPA-subtest 2	4132	826.4 (Low)	21.73	0.15
	4182	836.4 (Mid)	21.68	0.15
	4233	846.6 (High)	21.52	0.14
WCDMA Band V HSUPA-subtest 3	4132	826.4 (Low)	21.46	0.14
	4182	836.4 (Mid)	21.40	0.14
	4233	846.6 (High)	21.33	0.14
WCDMA Band V HSUPA-subtest 4	4132	826.4 (Low)	21.86	0.15
	4182	836.4 (Mid)	21.85	0.15
	4233	846.6 (High)	21.74	0.15
WCDMA Band V HSUPA-subtest 5	4132	826.4 (Low)	21.45	0.14
	4182	836.4 (Mid)	21.41	0.14
	4233	846.6 (High)	21.40	0.14



Bands	Channel	Frequency (MHz)	Conducted Power (dBm)	Conducted Power (Watts)
WCDMA Band II (12.2k bps)	9262	1852.4 (Low)	21.89	0.15
	9400	1880.0 (Mid)	21.82	0.15
	9538	1907.6 (High)	21.85	0.15
WCDMA Band II (64k bps)	9262	1852.4 (Low)	22.23	0.17
	9400	1880.0 (Mid)	21.89	0.15
	9538	1907.6 (High)	21.77	0.15
WCDMA Band II (144k bps)	9262	1852.4 (Low)	21.69	0.15
	9400	1880.0 (Mid)	21.61	0.14
	9538	1907.6 (High)	21.71	0.15
WCDMA Band II (384k bps)	9262	1852.4 (Low)	21.98	0.16
	9400	1880.0 (Mid)	21.66	0.15
	9538	1907.6 (High)	21.79	0.15
WCDMA Band II (AMR)	9262	1852.4 (Low)	22.08	0.16
	9400	1880.0 (Mid)	21.84	0.15
	9538	1907.6 (High)	21.71	0.15
WCDMA Band II HSDPA-subtest 1	9262	1852.4 (Low)	22.13	0.16
	9400	1880.0 (Mid)	21.42	0.14
	9538	1907.6 (High)	21.36	0.14
WCDMA Band II HSDPA-subtest 2	9262	1852.4 (Low)	21.36	0.14
	9400	1880.0 (Mid)	21.13	0.13
	9538	1907.6 (High)	21.20	0.13
WCDMA Band II HSDPA-subtest 3	9262	1852.4 (Low)	21.21	0.13
	9400	1880.0 (Mid)	21.14	0.13
	9538	1907.6 (High)	21.26	0.13
WCDMA Band II HSDPA-subtest 4	9262	1852.4 (Low)	21.51	0.14
	9400	1880.0 (Mid)	21.00	0.13
	9538	1907.6 (High)	20.93	0.12
WCDMA Band II HSUPA-subset 1	9262	1852.4 (Low)	22.43	0.17
	9400	1880.0 (Mid)	21.88	0.15
	9538	1907.6 (High)	21.66	0.15
WCDMA Band II HSUPA-subset 2	9262	1852.4 (Low)	21.60	0.14
	9400	1880.0 (Mid)	21.68	0.15
	9538	1907.6 (High)	21.75	0.15
WCDMA Band II HSUPA-subset 3	9262	1852.4 (Low)	20.93	0.12
	9400	1880.0 (Mid)	21.06	0.13
	9538	1907.6 (High)	21.23	0.13
WCDMA Band II HSUPA-subset 4	9262	1852.4 (Low)	21.30	0.13
	9400	1880.0 (Mid)	21.60	0.14
	9538	1907.6 (High)	21.81	0.15
WCDMA Band II HSUPA-subset 5	9262	1852.4 (Low)	21.15	0.13
	9400	1880.0 (Mid)	21.17	0.13
	9538	1907.6 (High)	21.38	0.14



4.3 ERP / EIRP Measurement

Equivalent isotropic radiated power measurements by substitution method according to ANSI/TIA/EIA-603-C.

4.3.1 Measurement Instruments

As described in chapter 5 of this test report.

4.3.2 Test Procedure

- a. The EUT was placed on a table with 1.0 meter height in an fully anechoic chamber.
- b. The EUT was set 1.2 meters from the receiving antenna which was mounted on the antenna tower.
- c. The table was rotated 360 degrees to determine the position of the highest radiated power.
- d. The height of the receiving antenna is also kept at 1.0M height.
- e. Taking the record of maximum ERP/EIRP.
- f. A dipole antenna was substituted in place of the EUT and was driven by a signal generator.
- g. The conducted power at the terminal of the dipole antenna is measured.
- h. Repeat step 3 to step 5 to get the maximum ERP/EIRP of the substitution antenna.
- i. $ERP/EIRP = P_s + E_t - E_s + G_s = P_s + R_t - R_s + G_s$

P_s (dBm) : Input power to substitution antenna.

G_s (dBi or dBd) : Substitution antenna Gain.

$E_t = R_t + AF$

$E_s = R_s + AF$

AF (dB/m) : Receive antenna factor

R_t : The highest received signal in Spectrum Analyzer for EUT.

R_s : The highest received signal in spectrum analyzer for substitution antenna.

4.3.3 Test Setup Layout of ERP/EIRP

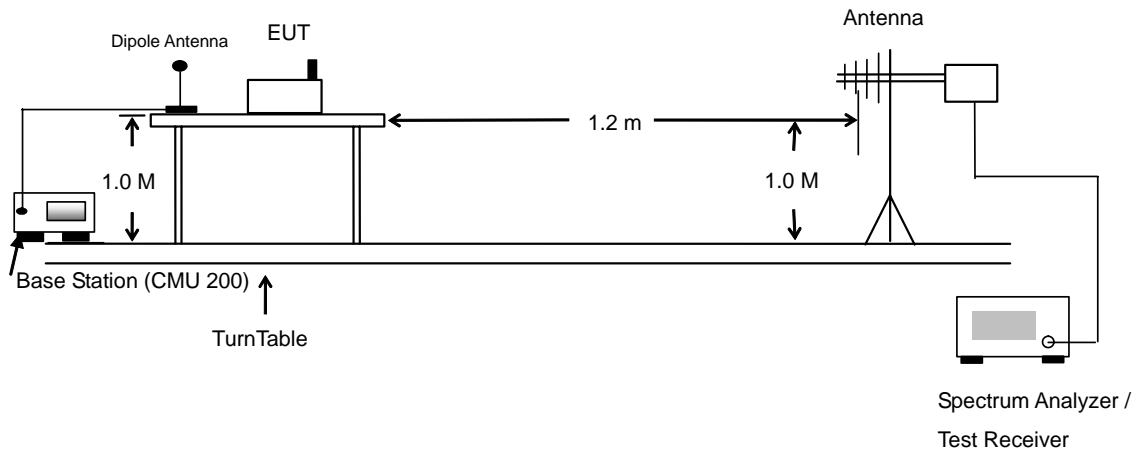



4.3.4 Test Result

GSM850 (GPRS) Radiated Power ERP						
Horizontal Polarization						
Frequency (MHz)	Rt (dBm)	Rs (dBm)	Ps (dBm)	Gs (dBd)	ERP (dBm)	ERP (W)
824.20	-39.15	-48.12	0.00	-1.08	7.89	0.01
836.40	-37.72	-48.28	0.00	-0.93	9.63	0.01
848.80	-34.28	-48.35	0.00	-0.76	13.31	0.02
Vertical Polarization						
Frequency (MHz)	Rt (dBm)	Rs (dBm)	Ps (dBm)	Gs (dBd)	ERP (dBm)	ERP (W)
824.20	-18.57	-47.97	0.00	-1.08	28.32	0.68
836.40	-19.06	-48.01	0.00	-0.93	28.02	0.63
848.80	-18.48	-48.05	0.00	-0.76	28.81	0.76

GSM850 (EDGE) Radiated Power ERP						
Horizontal Polarization						
Frequency (MHz)	Rt (dBm)	Rs (dBm)	Ps (dBm)	Gs (dBd)	ERP (dBm)	ERP (W)
824.20	-44.77	-48.12	0.00	-1.08	2.27	0.00
836.40	-43.79	-48.28	0.00	-0.93	3.56	0.00
848.80	-41.43	-48.35	0.00	-0.76	6.16	0.00
Vertical Polarization						
Frequency (MHz)	Rt (dBm)	Rs (dBm)	Ps (dBm)	Gs (dBd)	ERP (dBm)	ERP (W)
824.20	-25.15	-47.97	0.00	-1.08	21.74	0.15
836.40	-25.92	-48.01	0.00	-0.93	21.16	0.13
848.80	-26.24	-48.05	0.00	-0.76	21.05	0.13



GSM1900 (GPRS) Radiated Power EIRP						
Horizontal Polarization						
Frequency (MHz)	Rt (dBm)	Rs (dBm)	Ps (dBm)	Gs (dBi)	EIRP (dBm)	EIRP (W)
1850.20	-36.98	-51.88	0.00	1.96	16.86	0.05
1880.00	-37.31	-52.99	0.00	2.00	17.68	0.06
1909.80	-38.18	-54.28	0.00	1.98	18.08	0.06
Vertical Polarization						
Frequency (MHz)	Rt (dBm)	Rs (dBm)	Ps (dBm)	Gs (dBi)	EIRP (dBm)	EIRP (W)
1850.20	-29.62	-52.13	0.00	1.96	24.47	0.28
1880.00	-28.36	-53.17	0.00	2.00	26.81	0.48
1909.80	-29.27	-54.13	0.00	1.98	26.84	0.48

GSM1900 (EDGE) Radiated Power EIRP						
Horizontal Polarization						
Frequency (MHz)	Rt (dBm)	Rs (dBm)	Ps (dBm)	Gs (dBi)	EIRP (dBm)	EIRP (W)
1850.20	-39.86	-51.88	0.00	1.96	13.98	0.03
1880.00	-41.22	-52.99	0.00	2.00	13.77	0.02
1909.80	-43.31	-54.28	0.00	1.98	12.95	0.02
Vertical Polarization						
Frequency (MHz)	Rt (dBm)	Rs (dBm)	Ps (dBm)	Gs (dBi)	EIRP (dBm)	EIRP (W)
1850.20	-31.79	-52.13	0.00	1.96	22.30	0.17
1880.00	-32.89	-53.17	0.00	2.00	22.28	0.17
1909.80	-33.35	-54.13	0.00	1.98	22.76	0.19



WCDMA Band V Radiated Power ERP						
Horizontal Polarization						
Frequency (MHz)	Rt (dBm)	Rs (dBm)	Ps (dBm)	Gs (dBd)	ERP (dBm)	ERP (W)
826.40	-49.91	-48.12	0.00	-1.08	-2.87	0.00
836.40	-47.98	-48.28	0.00	-0.93	-0.63	0.00
846.60	-45.07	-48.35	0.00	-0.76	2.52	0.00
Vertical Polarization						
Frequency (MHz)	Rt (dBm)	Rs (dBm)	Ps (dBm)	Gs (dBd)	ERP (dBm)	ERP (W)
826.40	-28.85	-47.97	0.00	-1.08	18.04	0.06
836.40	-29.24	-48.01	0.00	-0.93	17.84	0.06
846.60	-29.57	-48.05	0.00	-0.76	17.72	0.06

WCDMA Band V (HSUPA) Radiated Power ERP						
Horizontal Polarization						
Frequency (MHz)	Rt (dBm)	Rs (dBm)	Ps (dBm)	Gs (dBd)	ERP (dBm)	ERP (W)
826.40	-50.01	-48.12	0.00	-1.08	-2.97	0.00
836.40	-48.56	-48.28	0.00	-0.93	-1.21	0.00
846.60	-45.18	-48.35	0.00	-0.76	2.41	0.00
Vertical Polarization						
Frequency (MHz)	Rt (dBm)	Rs (dBm)	Ps (dBm)	Gs (dBd)	ERP (dBm)	ERP (W)
826.40	-29.57	-47.97	0.00	-1.08	17.32	0.05
836.40	-30.05	-48.01	0.00	-0.93	17.03	0.05
846.60	-30.13	-48.05	0.00	-0.76	17.16	0.05



WCDMA Band II Radiated Power EIRP						
Horizontal Polarization						
Frequency (MHz)	Rt (dBm)	Rs (dBm)	Ps (dBm)	Gs (dBi)	EIRP (dBm)	EIRP (W)
1852.40	-43.31	-51.88	0.00	1.96	10.53	0.01
1880.00	-42.44	-52.99	0.00	2.00	12.55	0.02
1907.60	-43.55	-54.28	0.00	1.98	12.71	0.02
Vertical Polarization						
Frequency (MHz)	Rt (dBm)	Rs (dBm)	Ps (dBm)	Gs (dBi)	EIRP (dBm)	EIRP (W)
1852.40	-37.82	-52.13	0.00	1.96	16.27	0.04
1880.00	-36.39	-53.17	0.00	2.00	18.78	0.08
1907.60	-36.24	-54.13	0.00	1.98	19.87	0.10

WCDMA Band II (HSUPA) Radiated Power EIRP						
Horizontal Polarization						
Frequency (MHz)	Rt (dBm)	Rs (dBm)	Ps (dBm)	Gs (dBi)	EIRP (dBm)	EIRP (W)
1852.40	-43.57	-51.88	0.00	1.96	10.27	0.01
1880.00	-43.29	-52.99	0.00	2.00	11.70	0.01
1907.60	-44.47	-54.28	0.00	1.98	11.79	0.02
Vertical Polarization						
Frequency (MHz)	Rt (dBm)	Rs (dBm)	Ps (dBm)	Gs (dBi)	EIRP (dBm)	EIRP (W)
1852.40	-38.16	-52.13	0.00	1.96	15.93	0.04
1880.00	-36.60	-53.17	0.00	2.00	18.57	0.07
1907.60	-36.79	-54.13	0.00	1.98	19.32	0.09

4.4 Occupied Bandwidth and Band Edge Measurement

4.4.1 Measurement Instruments

As described in chapter 5 of this test report.

4.4.2 Test Procedure

- a. The EUT was connected to Spectrum Analyzer and Base Station via power divider.
- b. The 99% occupied bandwidth of middle channel for the highest and lowest RF powers were measured.
- c. The bandedge of low and high channels for the highest RF powers within the transmitting frequency band were measured. Setting RBW as roughly $BW/100$.

4.4.3 Test Setup Layout

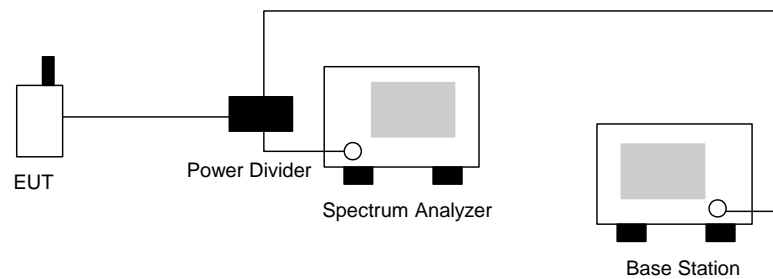



4.4.4 Test Result

- Mode 1
- Test Mode : GSM850 (GPRS) CH128 Lower Band Edge
- Power State : High

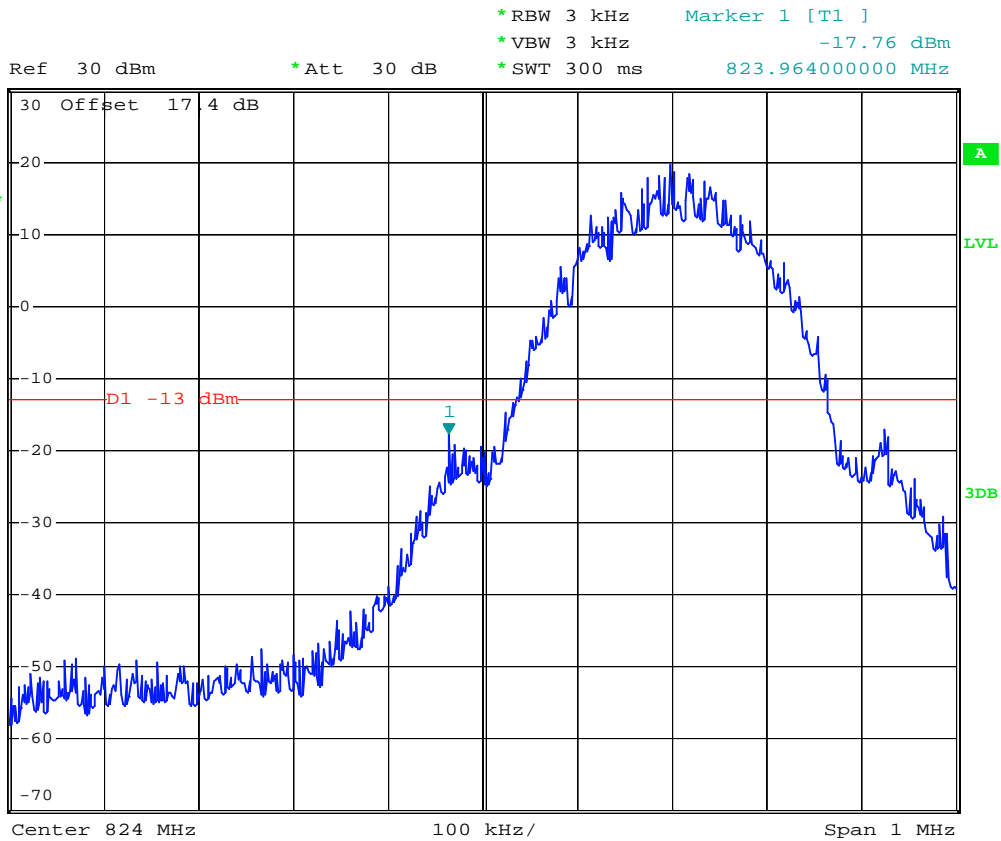

Date: 9.AUG.2008 00:53:26



- Test Mode : GSM850 (GPRS) CH128 99% Occupied Bandwidth
- Power State : High



Ref 30 dBm *Att 30 dB *RBW 3 kHz Marker 1 [T1]
 *VBW 10 kHz 24.38 dBm
 *SWT 300 ms 824.194000000 MHz

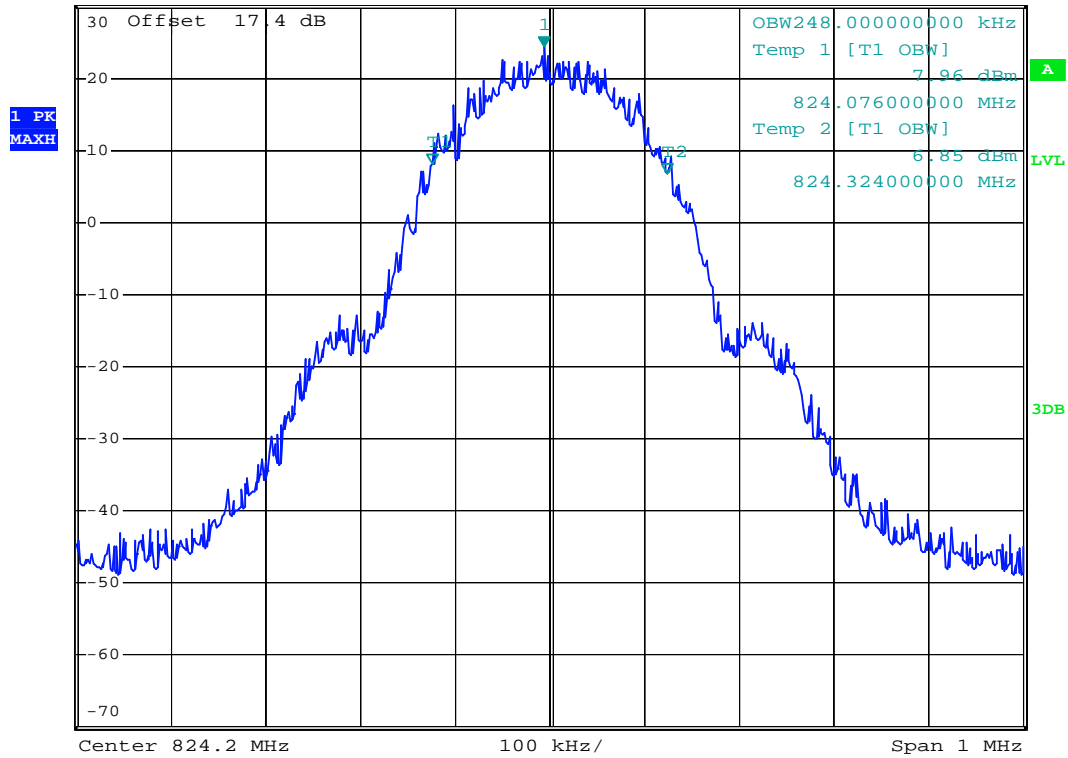

Date: 9.AUG.2008 00:51:00



- Test Mode : GSM850 (GPRS) CH189 99% Occupied Bandwidth
- Power State : High

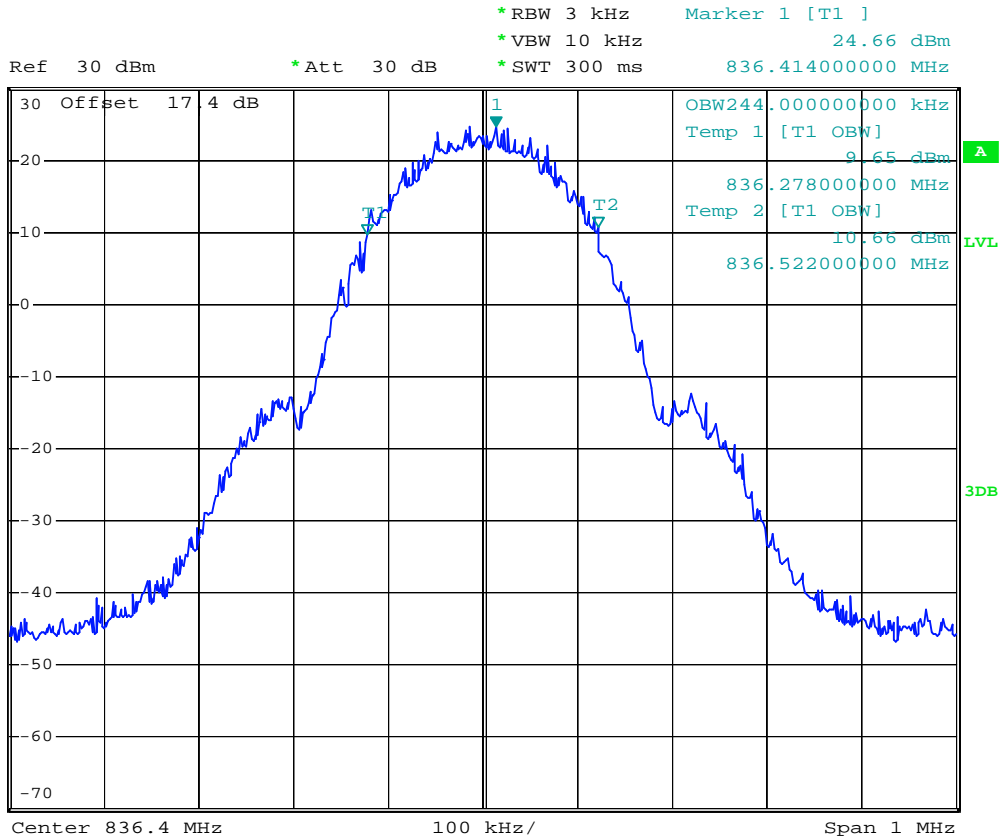

Date: 9.AUG.2008 00:50:36



- Test Mode : GSM850 (GPRS) CH 251 99% Occupied Bandwidth
- Power State : High

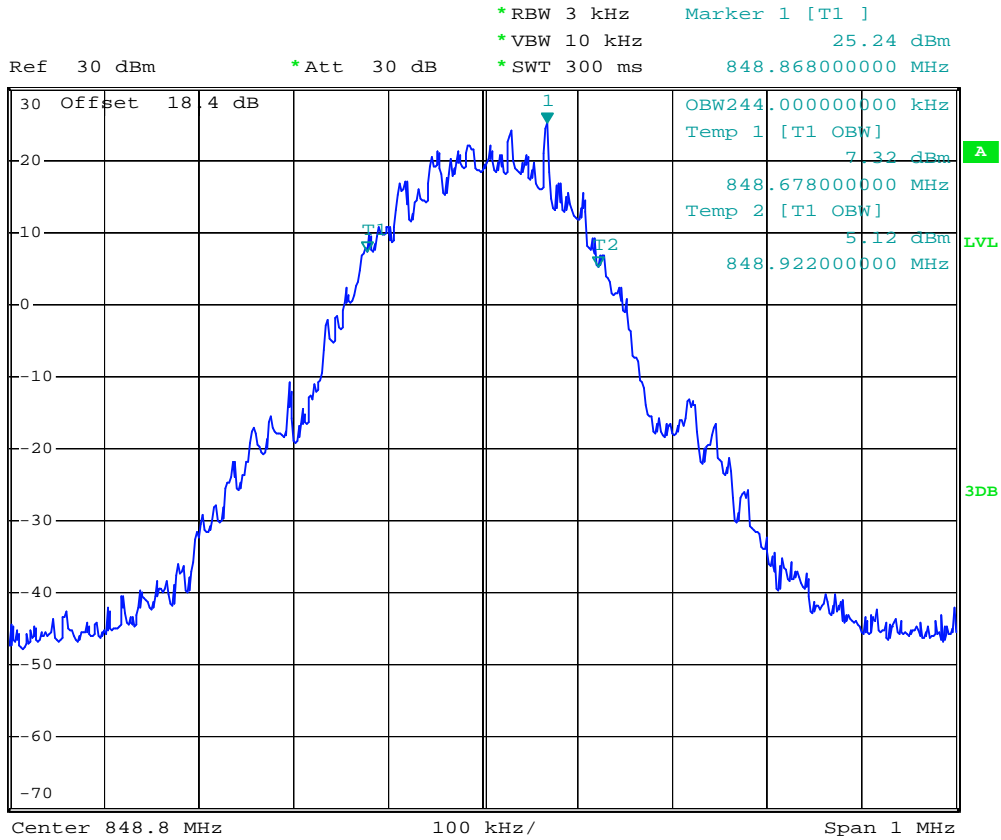

Date: 9.AUG.2008 02:36:21



- Test Mode : GSM850 (GPRS) CH128 26dB Bandwidth
- Power State : High



Ref 30 dBm *Att 30 dB *RBW 3 kHz Marker 1 [T1]
 *VBW 10 kHz 24.56 dBm
 *SWT 300 ms 824.198000000 MHz

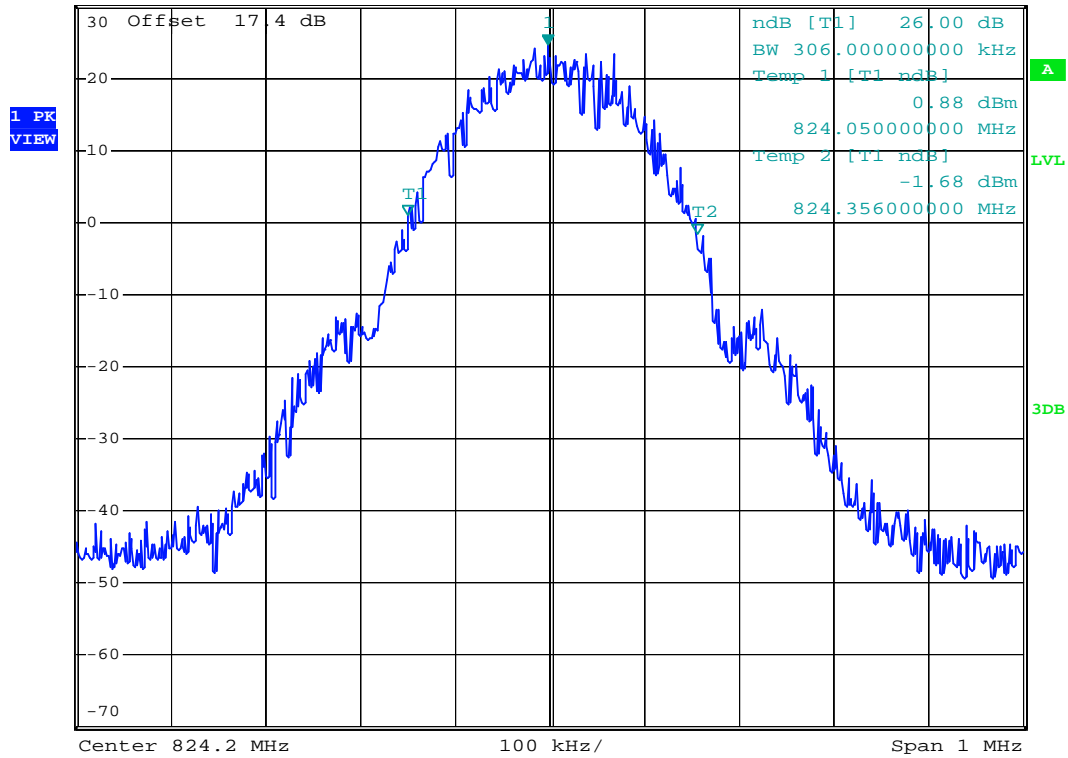

Date: 9.AUG.2008 00:47:10



- Test Mode : GSM850 (GPRS) CH189 26dB Bandwidth
- Power State : High



Ref 30 dBm *Att 30 dB *RBW 3 kHz Marker 1 [T1]
 *VBW 10 kHz 23.90 dBm
 *SWT 300 ms 836.428000000 MHz

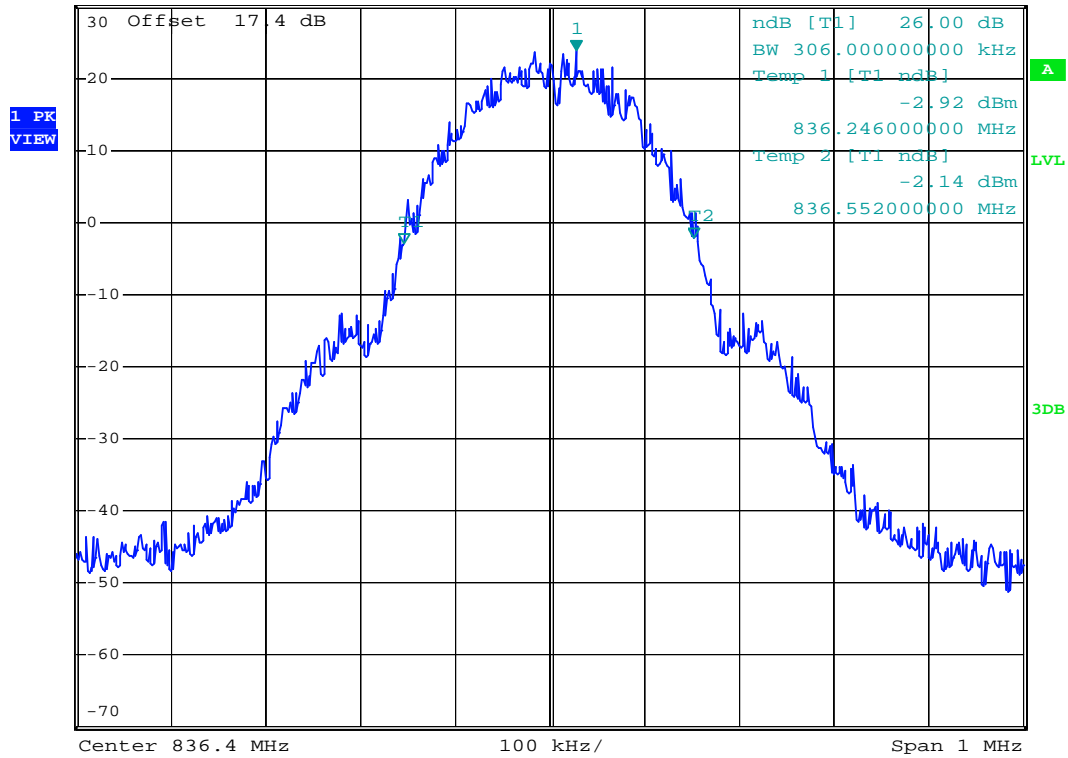

Date: 9.AUG.2008 00:47:49



- Test Mode : GSM850 (GPRS) CH 251 26dB Bandwidth
- Power State : High



Ref 30 dBm *Att 30 dB *RBW 3 kHz Marker 1 [T1]
 *VBW 10 kHz 25.60 dBm
 *SWT 300 ms 848.798000000 MHz

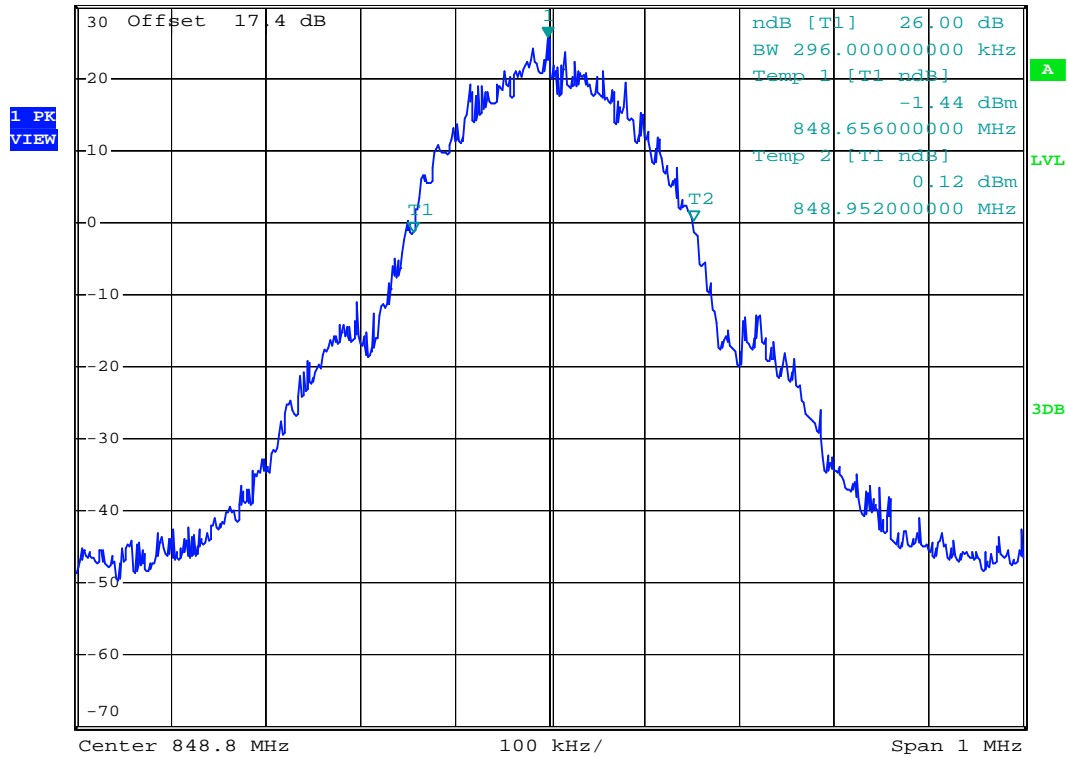

Date: 9.AUG.2008 00:48:25



- Test Mode : GSM850 (GPRS) CH251 Higher Band Edge
- Power State : High

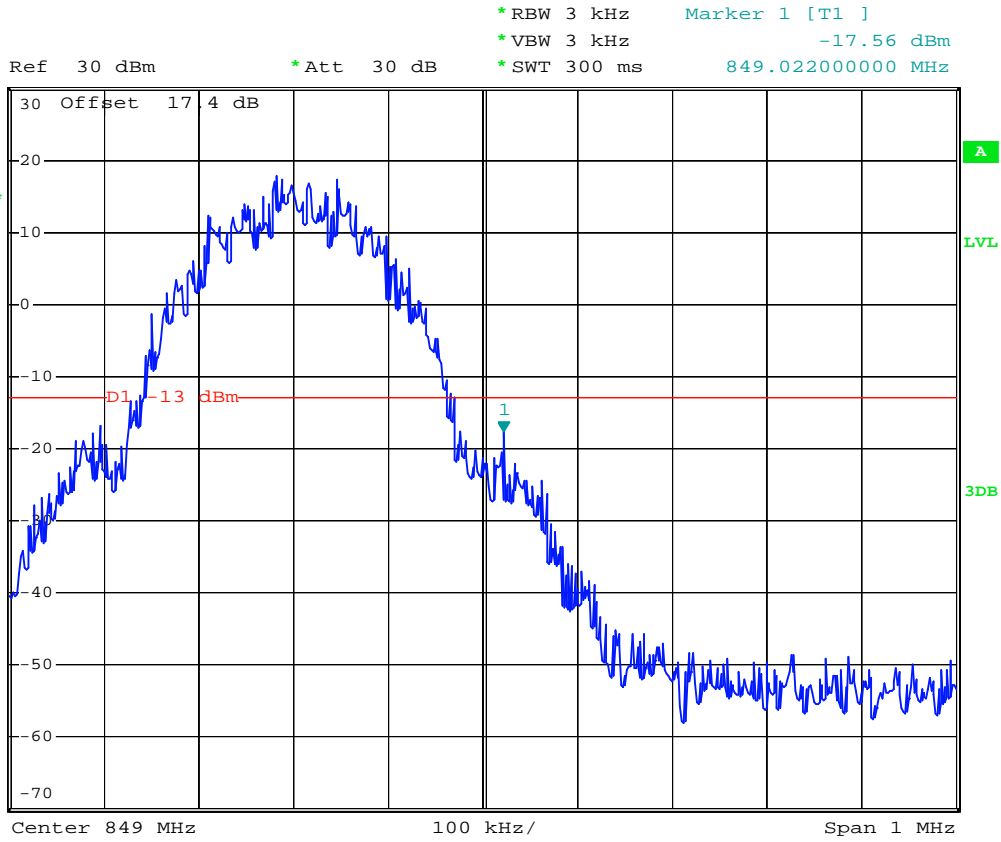

Date: 9.AUG.2008 00:54:49



- Mode 2
- Test Mode : GSM850 (EDGE) CH128 Lower Band Edge
- Power State : High

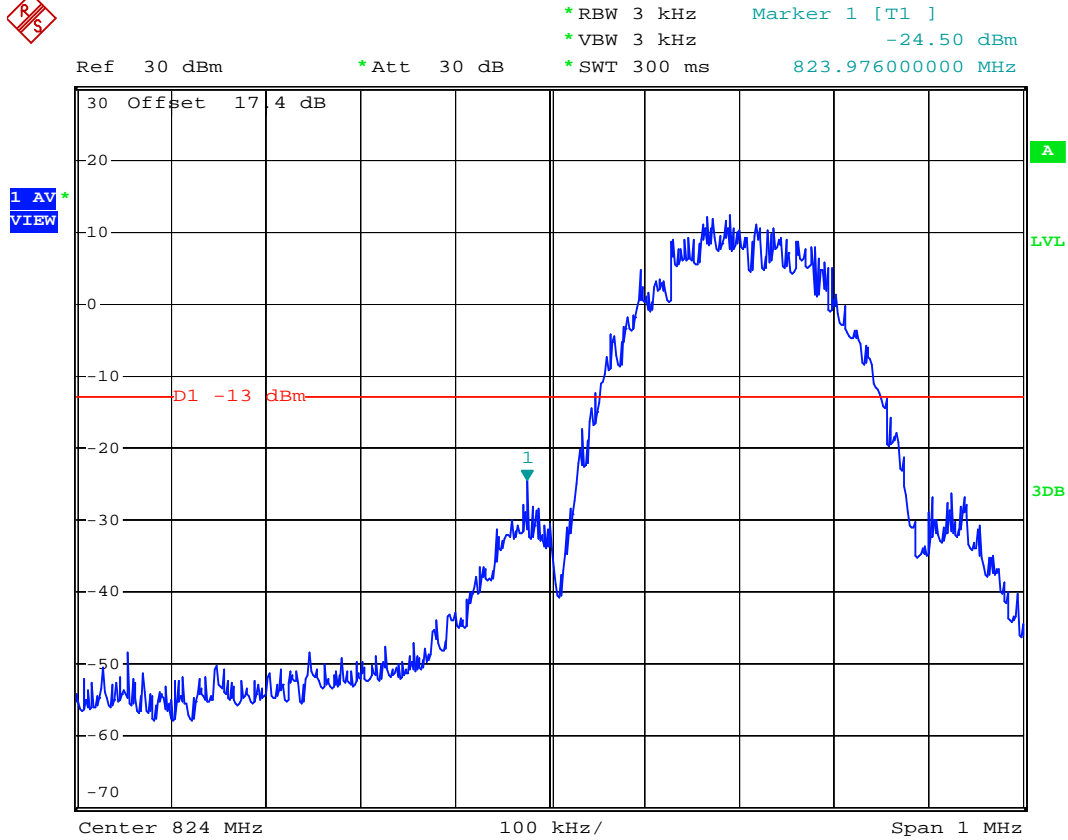

Date: 9.AUG.2008 01:29:21



- Test Mode : GSM850 (EDGE) CH128 99% Occupied Bandwidth
- Power State : High



Ref 30 dBm *Att 30 dB *RBW 3 kHz Marker 1 [T1]
 *VBW 10 kHz 17.38 dBm
 *SWT 300 ms 824.248000000 MHz

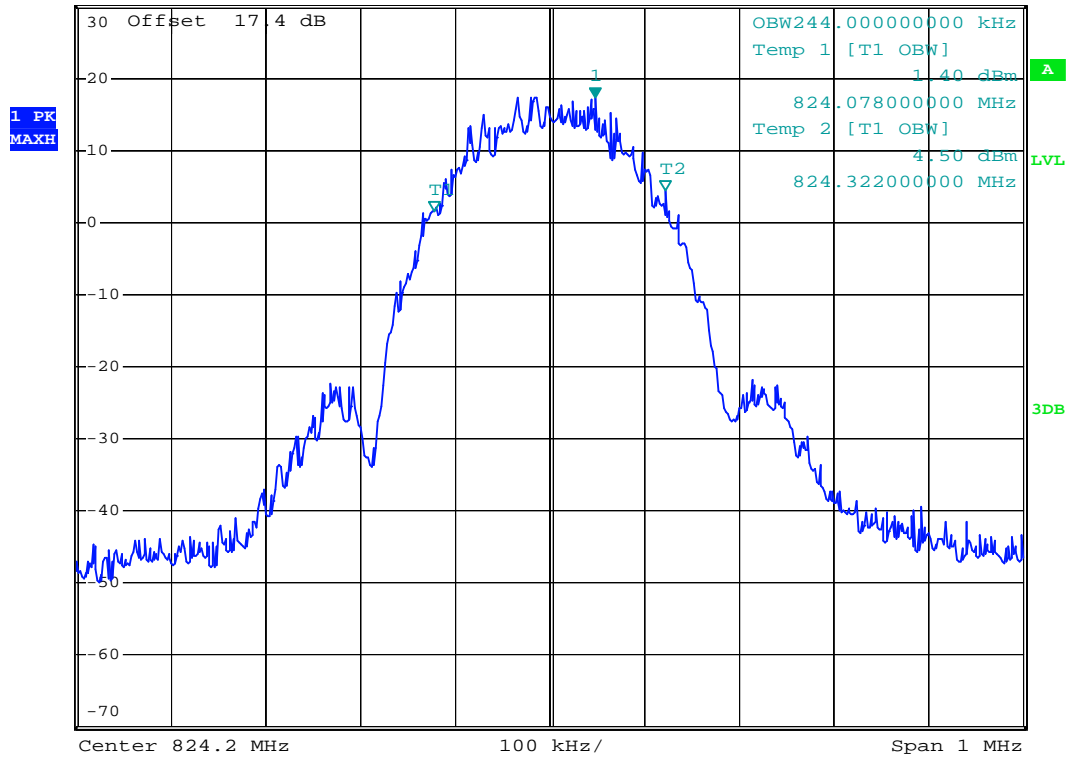

Date: 9.AUG.2008 01:21:58



- Test Mode : GSM850 (EDGE) CH189 99% Occupied Bandwidth
- Power State : High



Ref 30 dBm *Att 30 dB *RBW 3 kHz Marker 1 [T1]
 *VBW 10 kHz 17.67 dBm
 *SWT 300 ms 836.368000000 MHz

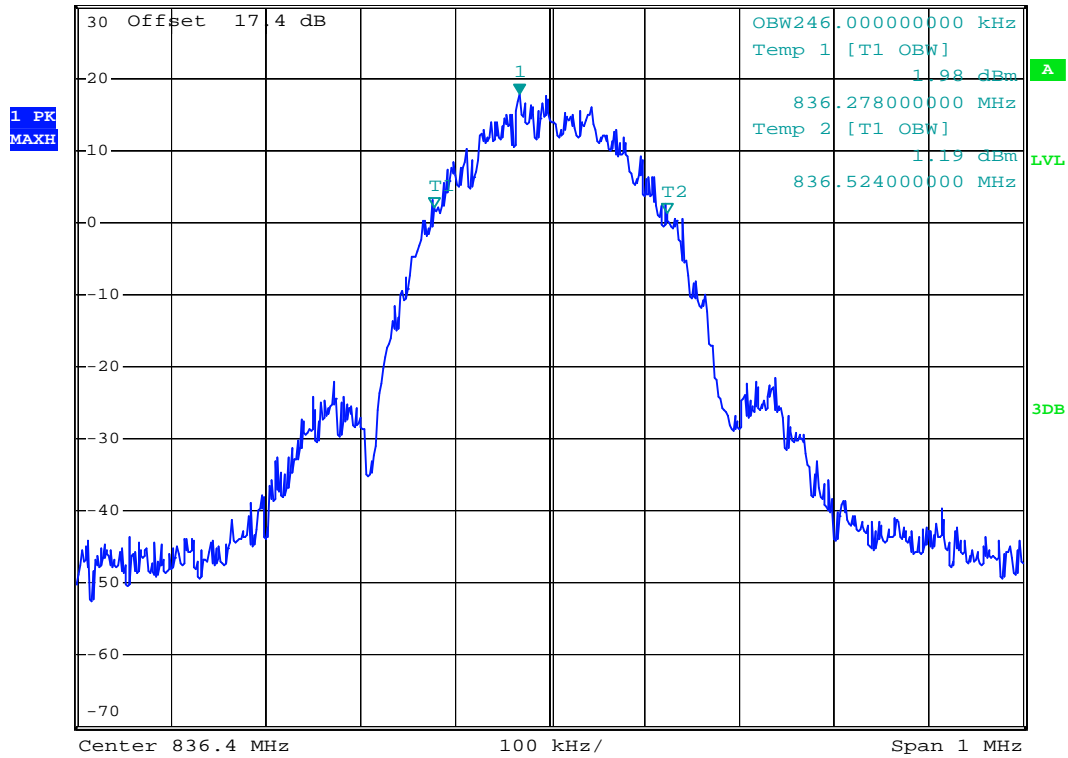

Date: 9.AUG.2008 01:21:28



- Test Mode : GSM850 (EDGE) CH 251 99% Occupied Bandwidth
- Power State : High

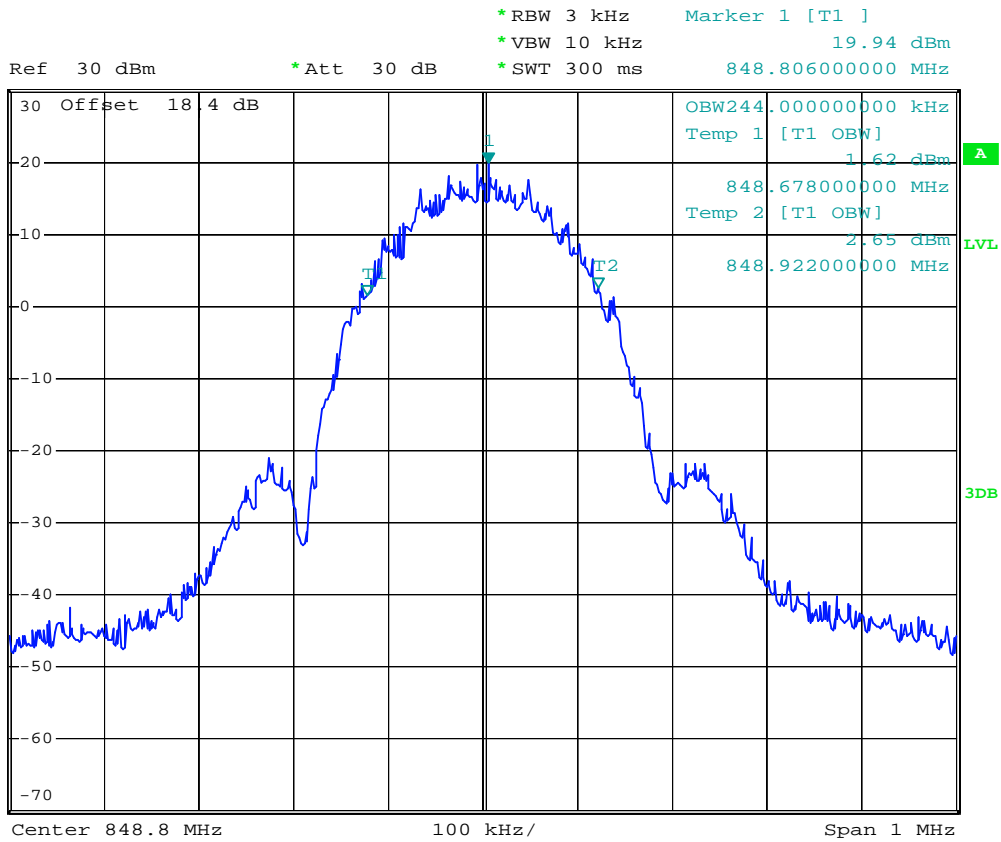

Date: 9.AUG.2008 02:37:36



- Test Mode : GSM850 (EDGE) CH189 26dB Bandwidth
- Power State : High



Ref 30 dBm *Att 30 dB *RBW 3 kHz Marker 1 [T1]
 *VBW 10 kHz 17.81 dBm
 *SWT 300 ms 836.400000000 MHz

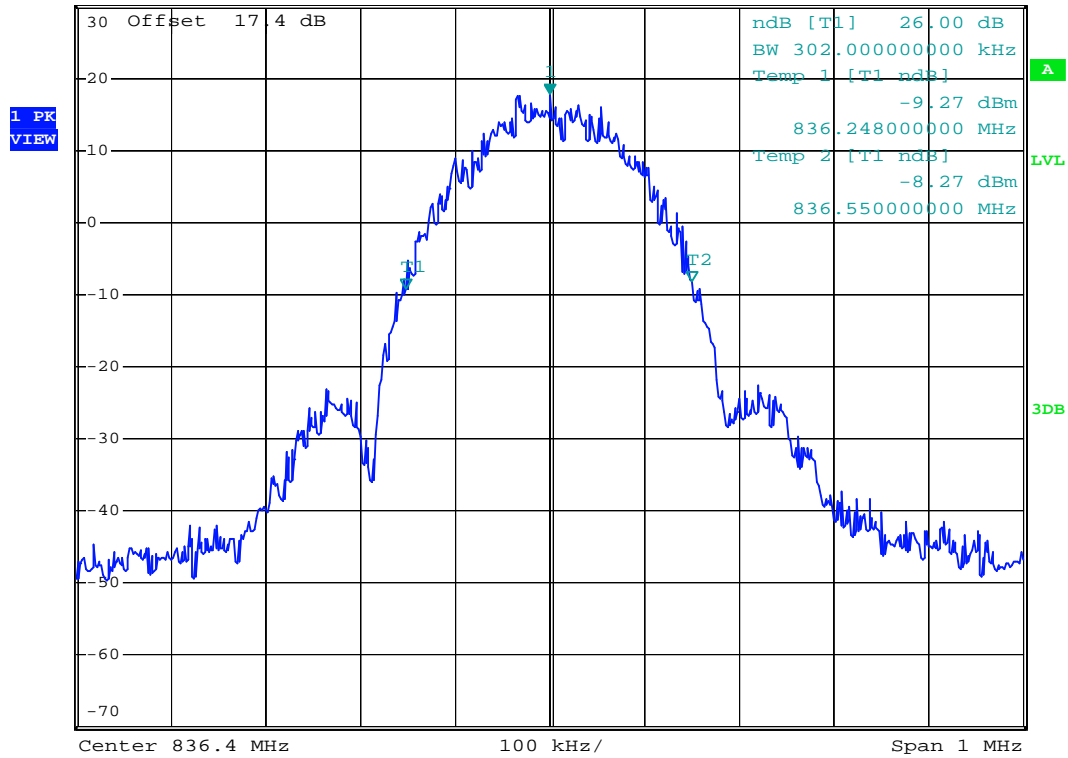

Date: 9.AUG.2008 01:16:33



- Test Mode : GSM850 (EDGE) CH251 Higher Band Edge
- Power State : High



*RBW 3 kHz Marker 1 [T1]
 *VBW 3 kHz -26.76 dBm
 *SWT 300 ms 849.036000000 MHz

Ref 30 dBm

*Att 30 dB

1 AV*
VIEW

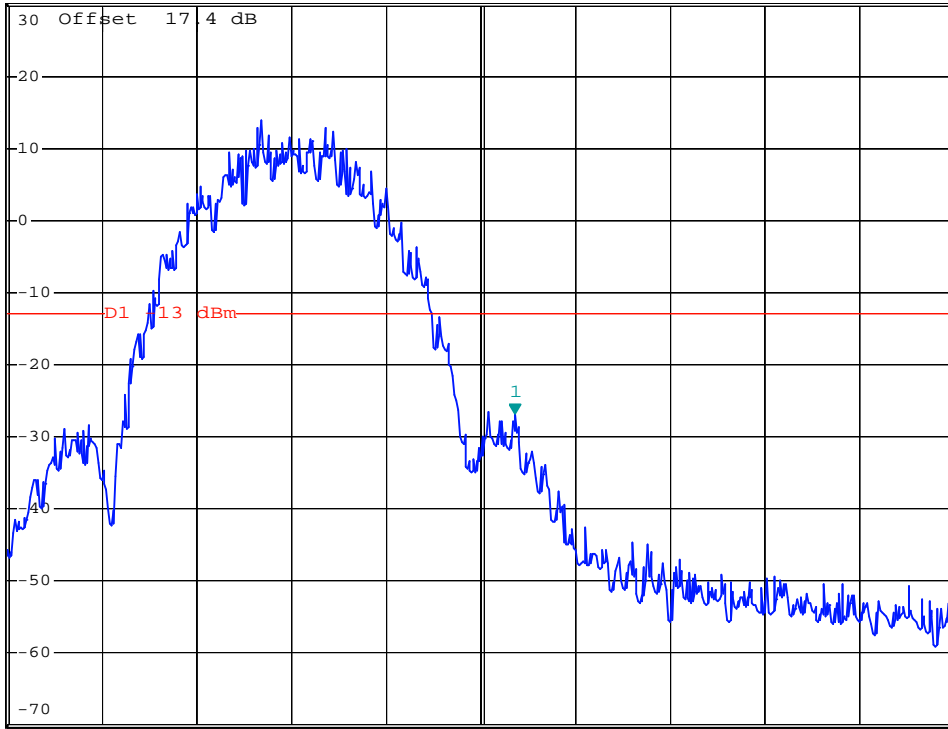

Center 849 MHz

100 kHz/

Span 1 MHz

Date: 9.AUG.2008 01:31:54



- Mode 3
- Test Mode : GSM1900 (GPRS) CH512 Lower Band Edge
- Power State : High

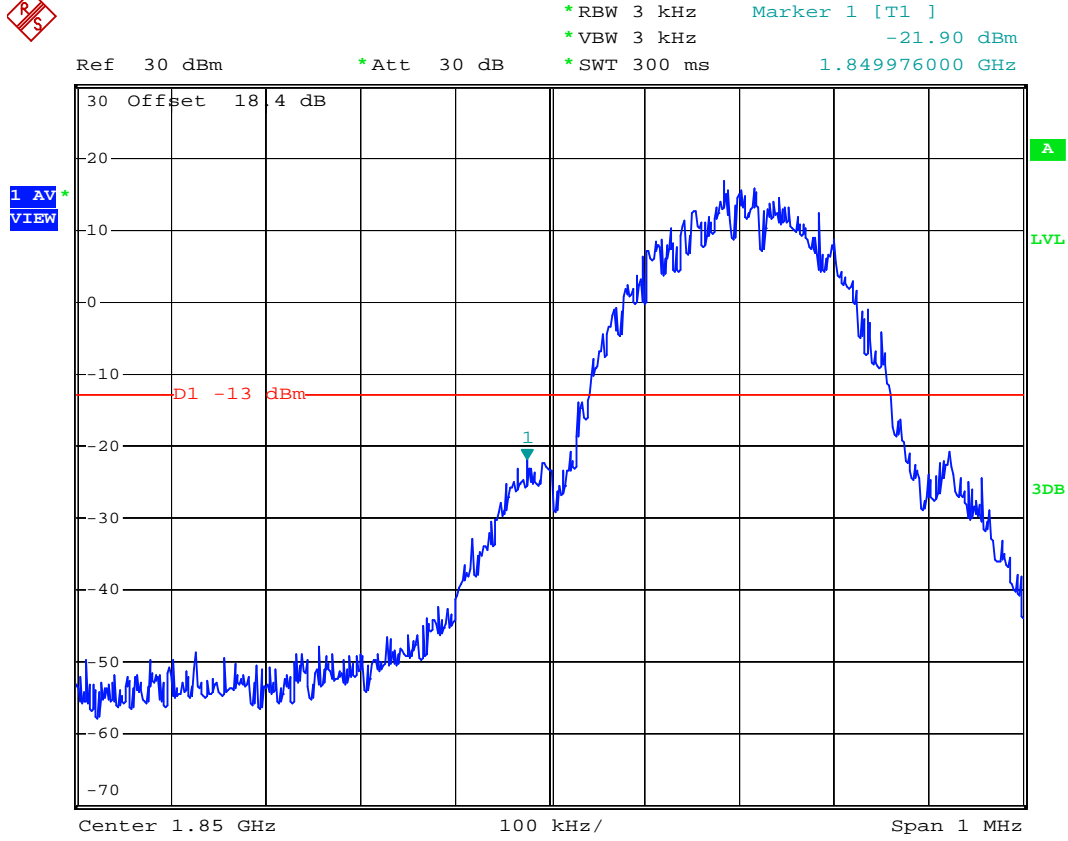

Date: 9.AUG.2008 02:00:48



- Test Mode : GSM1900 (GPRS) CH512 99% Occupied Bandwidth
- Power State : High

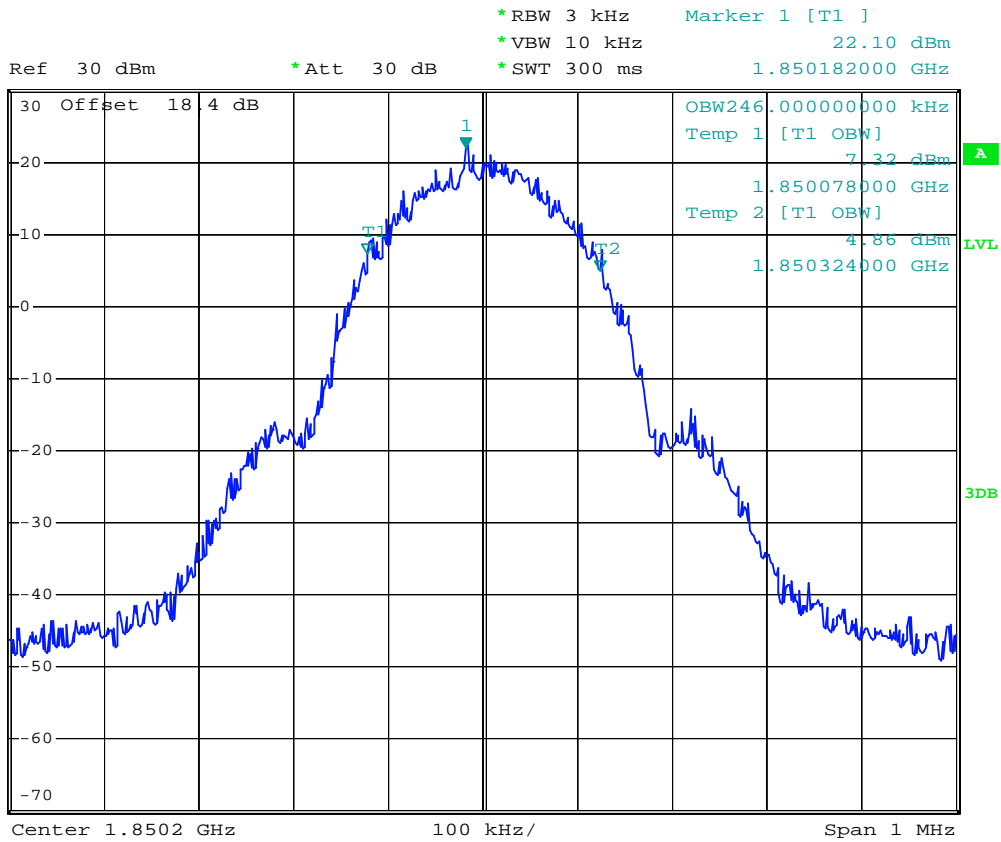

Date: 9.AUG.2008 01:49:49



- Test Mode : GSM1900 (GPRS) CH661 99% Occupied Bandwidth
- Power State : High



*RBW 3 kHz Marker 1 [T1]
 *VBW 10 kHz 21.14 dBm
 *SWT 300 ms 1.879994000 GHz
 Ref 30 dBm *Att 30 dB

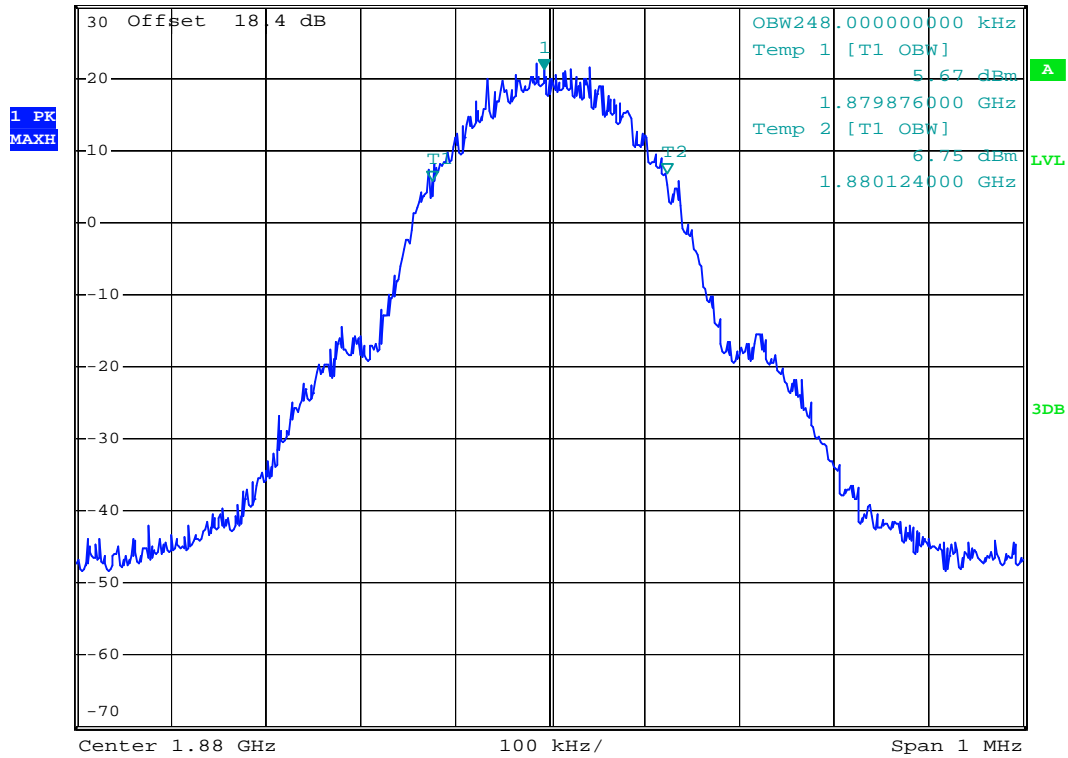

Date: 9.AUG.2008 01:49:20



- Test Mode : GSM1900 (GPRS) CH810 99% Occupied Bandwidth
- Power State : High

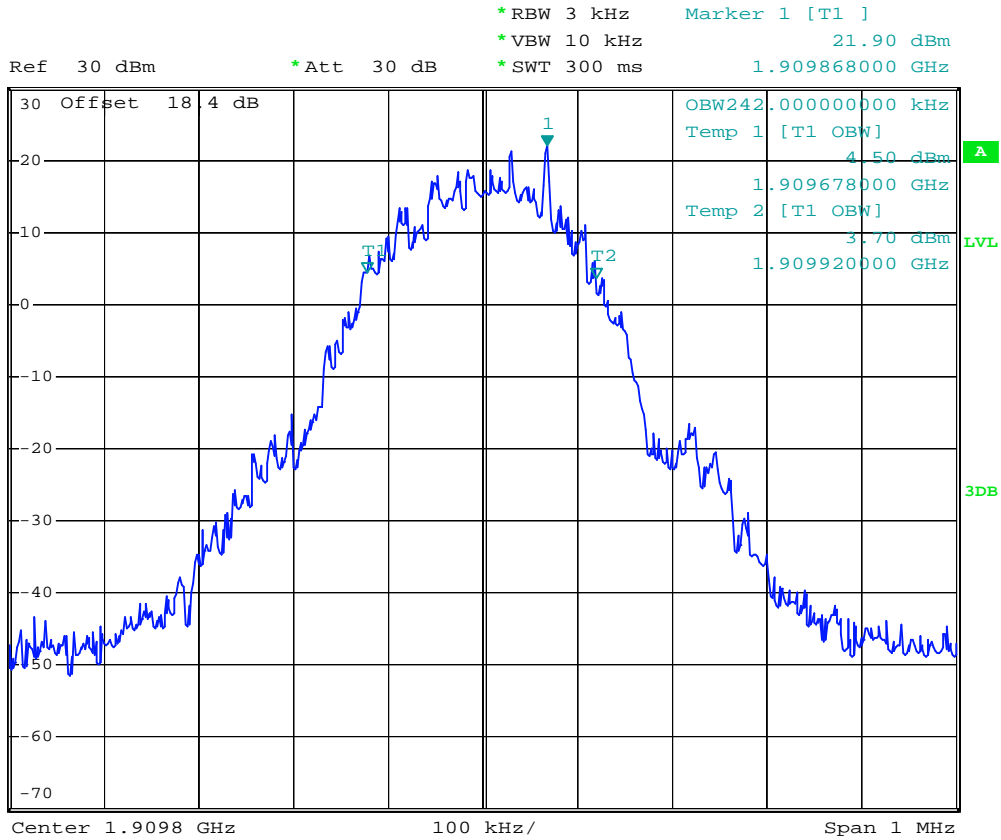

Date: 9.AUG.2008 02:35:10



- Test Mode : GSM1900 (GPRS) CH512 26dB Bandwidth
- Power State : High



Ref 30 dBm *Att 30 dB *RBW 3 kHz Marker 1 [T1] 21.92 dBm
 *VBW 10 kHz 1.850182000 GHz
 *SWT 300 ms

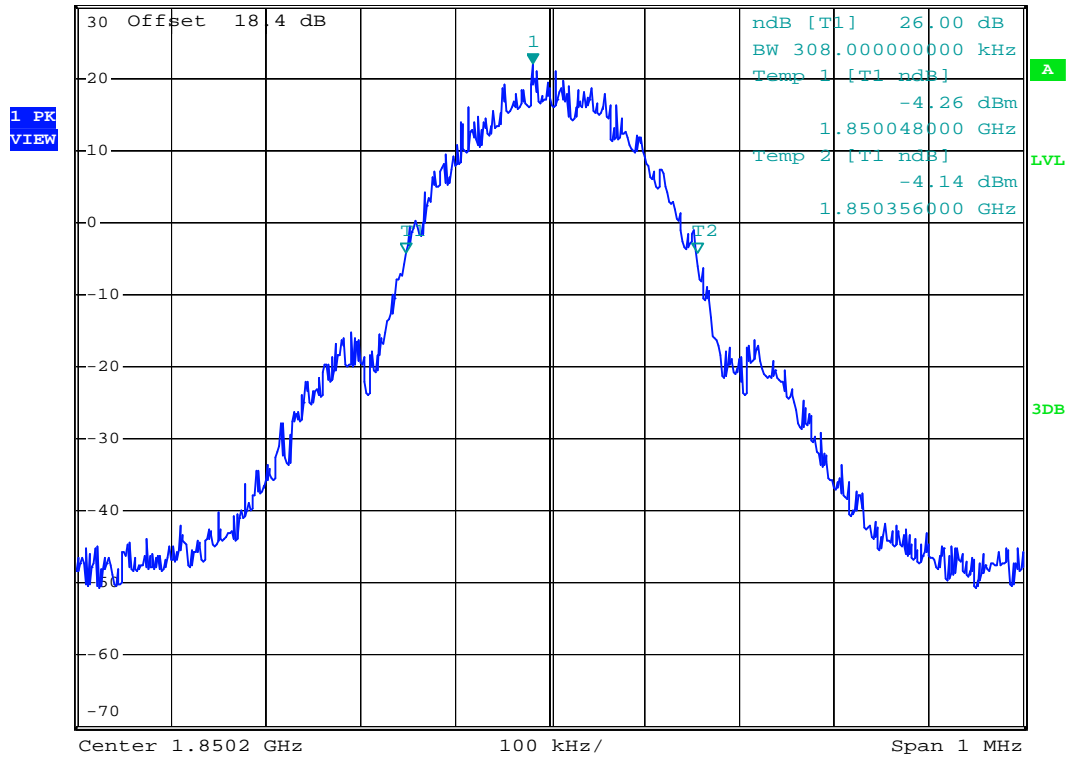

Date: 9.AUG.2008 01:42:14



- Test Mode : GSM1900 (GPRS) CH661 26dB Bandwidth
- Power State : High



Ref 30 dBm *Att 30 dB *RBW 3 kHz Marker 1 [T1] 23.41 dBm
 *VBW 10 kHz 1.88000000 GHz
 *SWT 300 ms

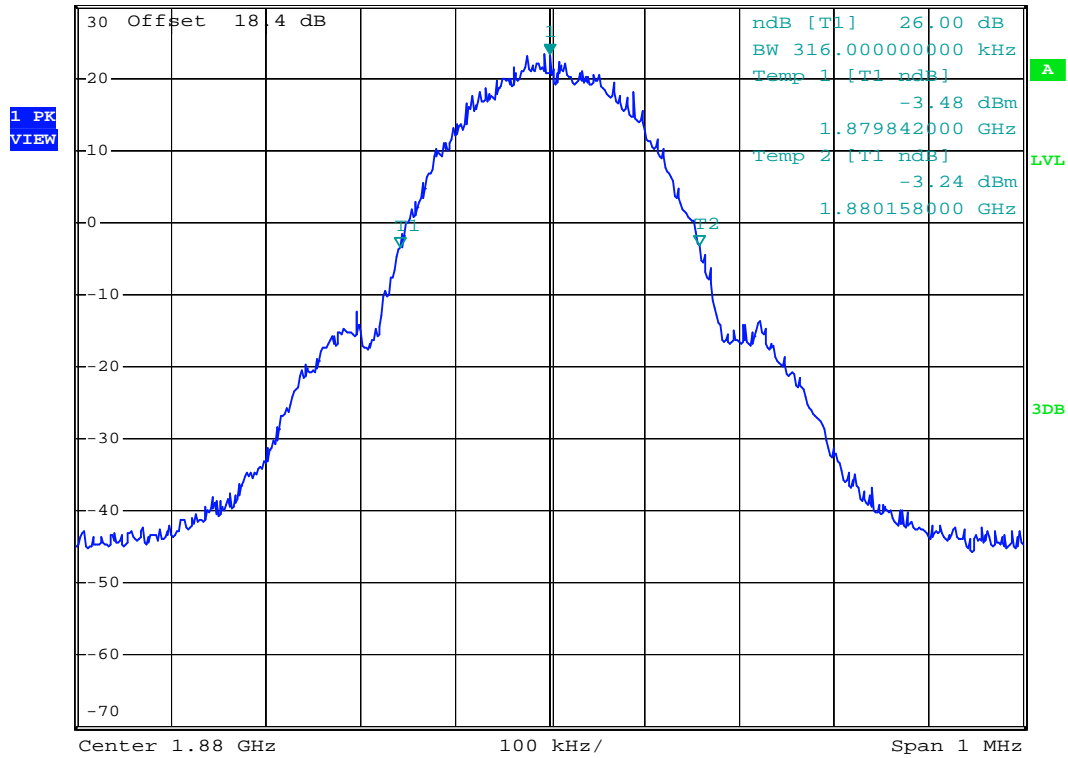

Date: 9.AUG.2008 01:47:45



- Test Mode : GSM1900 (GPRS) CH810 26dB Bandwidth
- Power State : High



Ref 30 dBm *Att 30 dB *RBW 3 kHz Marker 1 [T1]
 *VBW 10 kHz 21.16 dBm
 *SWT 300 ms 1.909806000 GHz

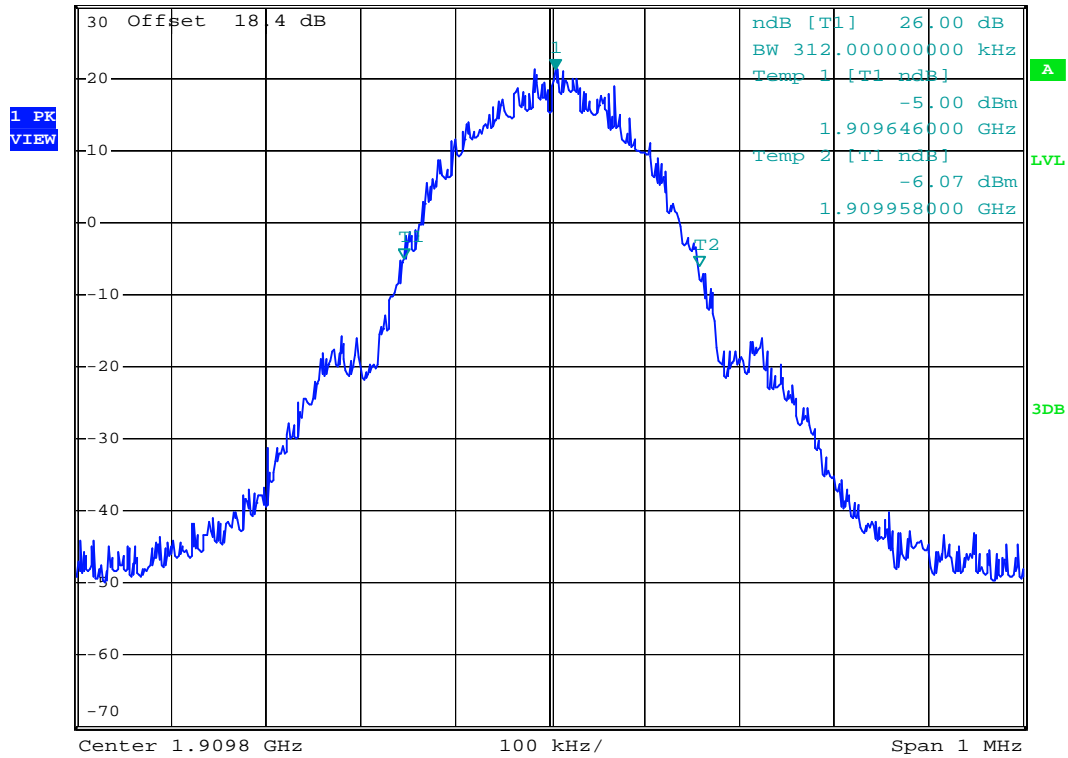

Date: 9.AUG.2008 01:48:11



- Test Mode : GSM1900 (GPRS) CH810 Higher Band Edge
- Power State : High

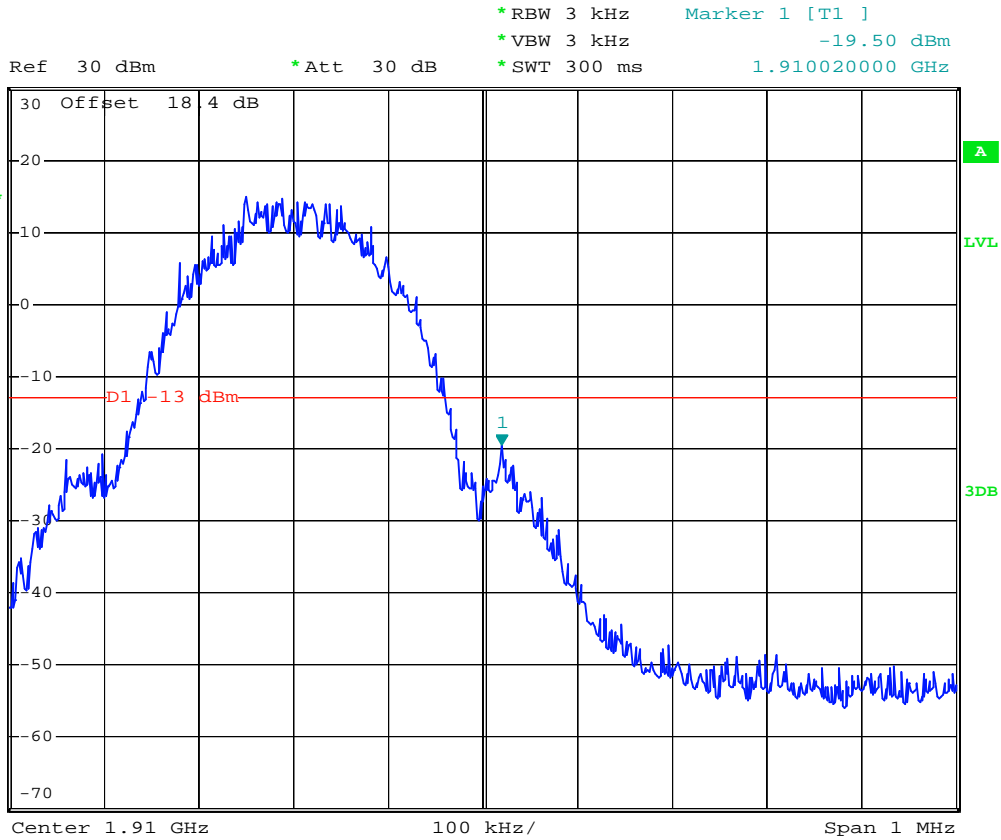

Date: 9.AUG.2008 02:02:47



- Mode 4
- Test Mode : GSM1900 (EDGE) CH512 Lower Band Edge
- Power State : High



*RBW 3 kHz Marker 1 [T1]
 *VBW 3 kHz -27.69 dBm
 *SWT 300 ms 1.849988000 GHz

Ref 30 dBm

*Att 30 dB

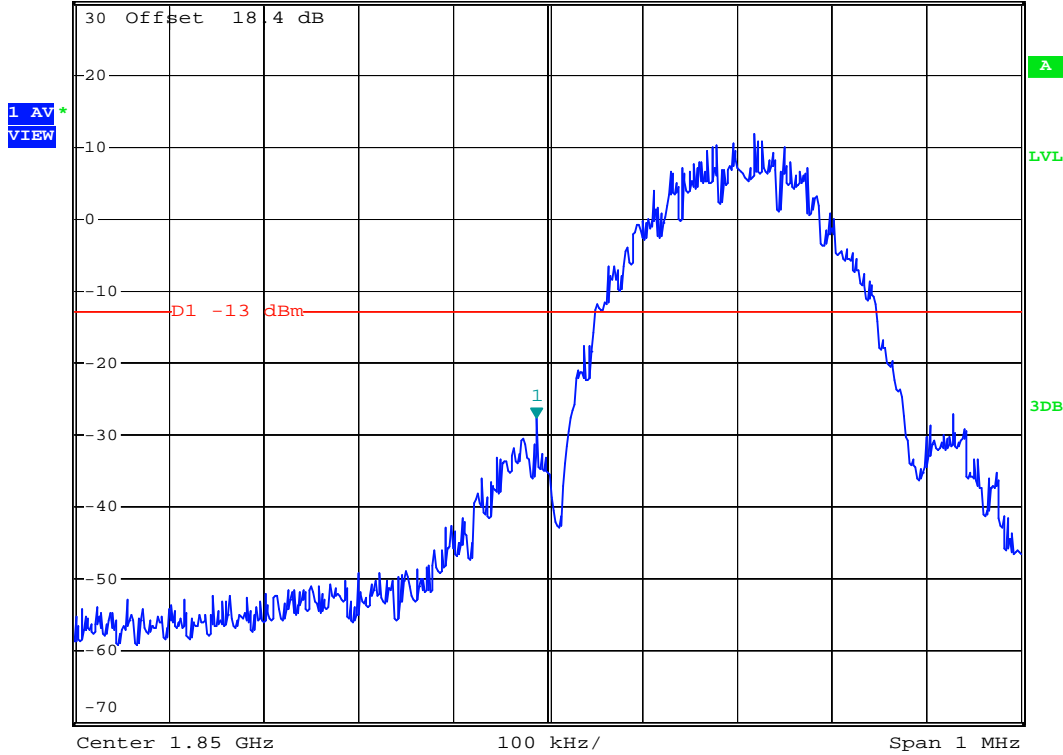

Date: 9.AUG.2008 02:28:11



- Test Mode : GSM1900 (EDGE) CH512 99% Occupied Bandwidth
- Power State : High

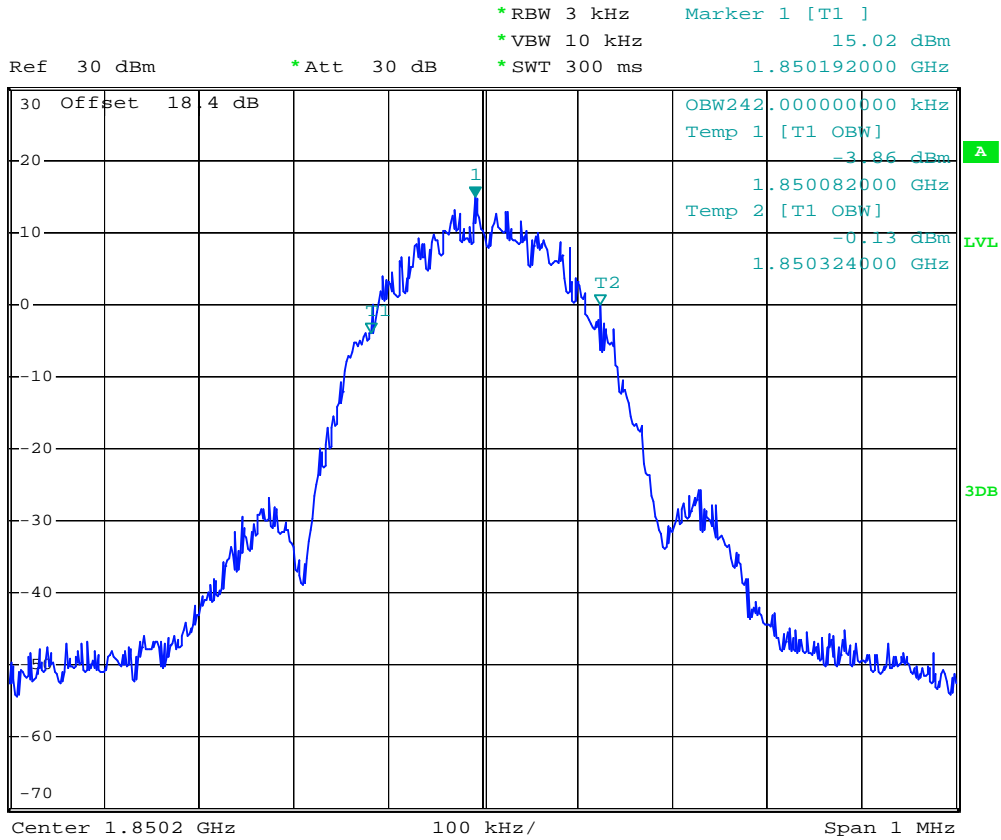

Date: 9.AUG.2008 02:26:17



- Test Mode : GSM1900 (EDGE) CH661 99% Occupied Bandwidth
- Power State : High



*RBW 3 kHz Marker 1 [T1]
 *VBW 10 kHz 13.43 dBm
 *SWT 300 ms 1.879968000 GHz

Ref 30 dBm

*Att 30 dB

1 PK
MAXH

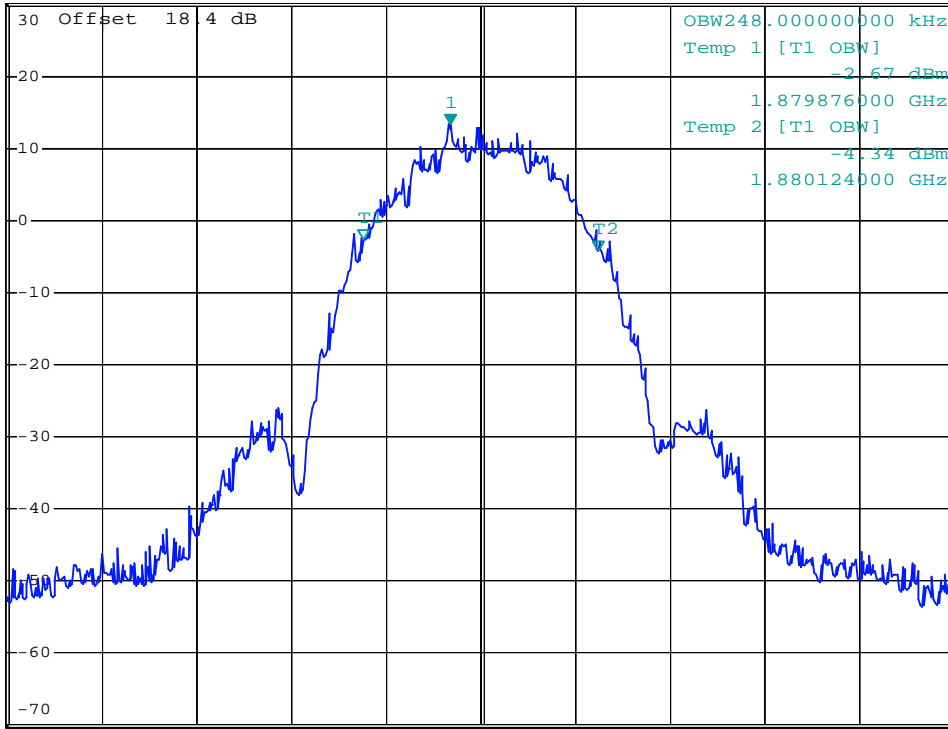

Center 1.88 GHz

100 kHz/

Span 1 MHz

Date: 9.AUG.2008 02:25:51



- Test Mode : GSM1900 (EDGE) CH810 99% Occupied Bandwidth
- Power State : High

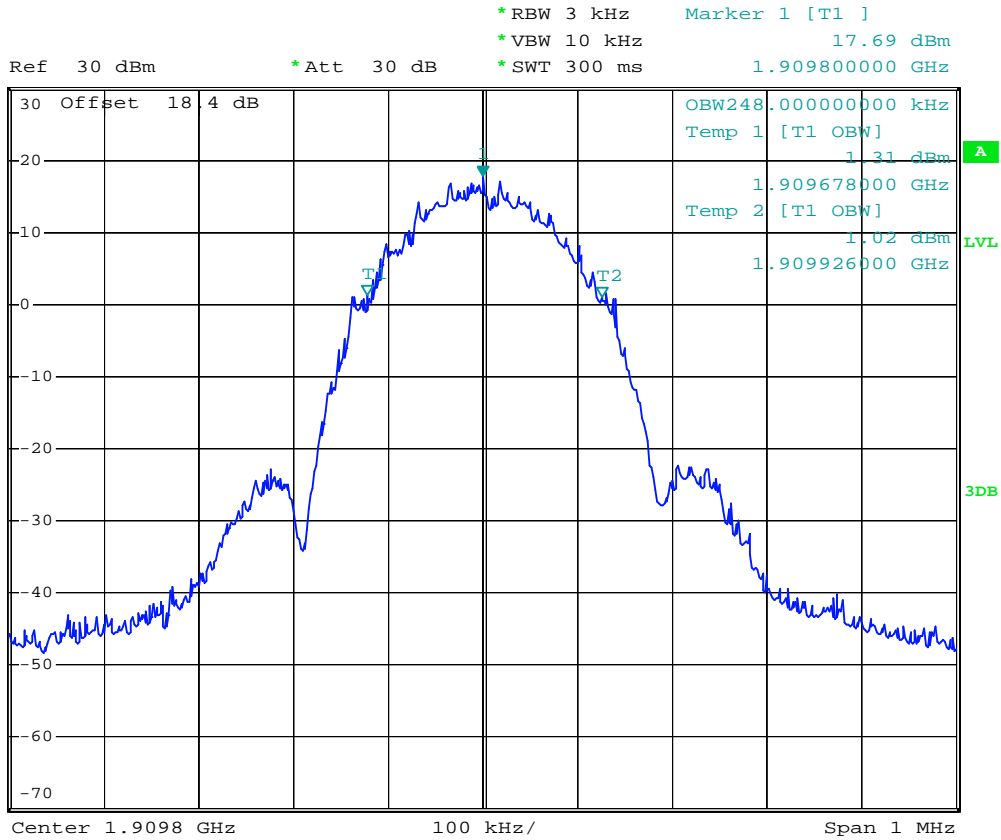

Date: 9.AUG.2008 02:34:34



- Test Mode : GSM1900 (EDGE) CH512 26dB Bandwidth
- Power State : High



Ref 30 dBm *Att 30 dB *RBW 3 kHz Marker 1 [T1] 14.79 dBm
 *VBW 10 kHz 1.850166000 GHz
 *SWT 300 ms

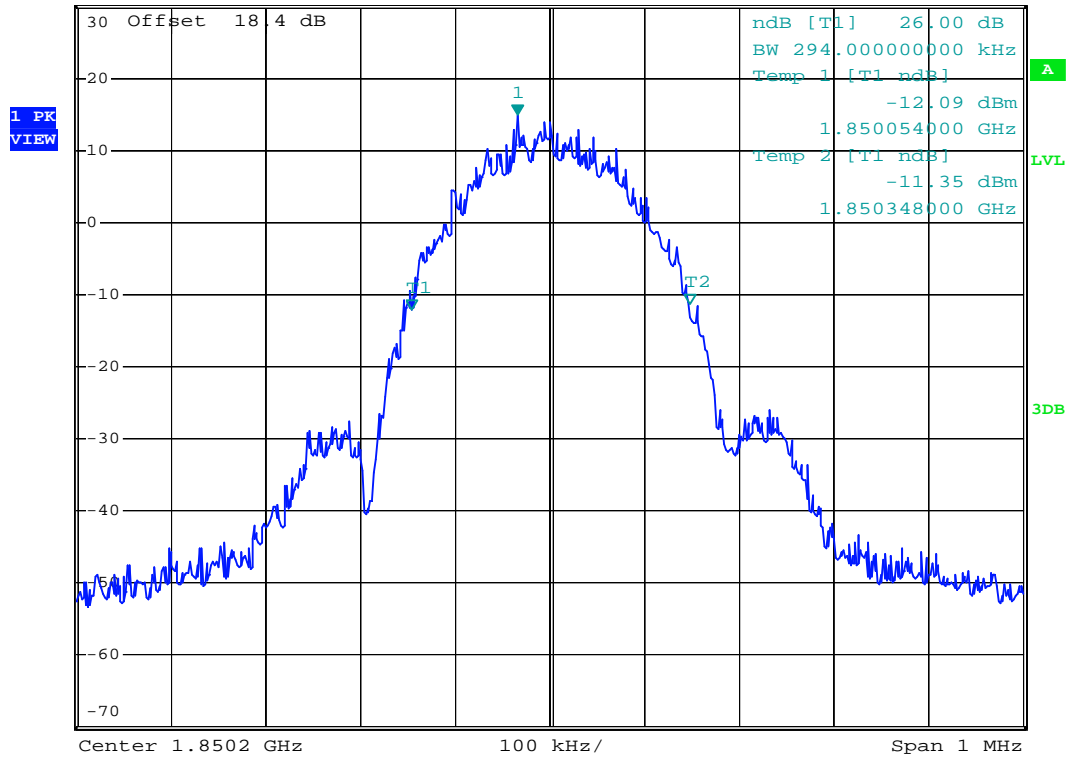

Date: 9.AUG.2008 02:22:53



- Test Mode : GSM1900 (EDGE) CH661 26dB Bandwidth
- Power State : High



Ref 30 dBm *Att 30 dB *RBW 3 kHz Marker 1 [T1] 12.97 dBm
 *VBW 10 kHz 1.880028000 GHz
 *SWT 300 ms

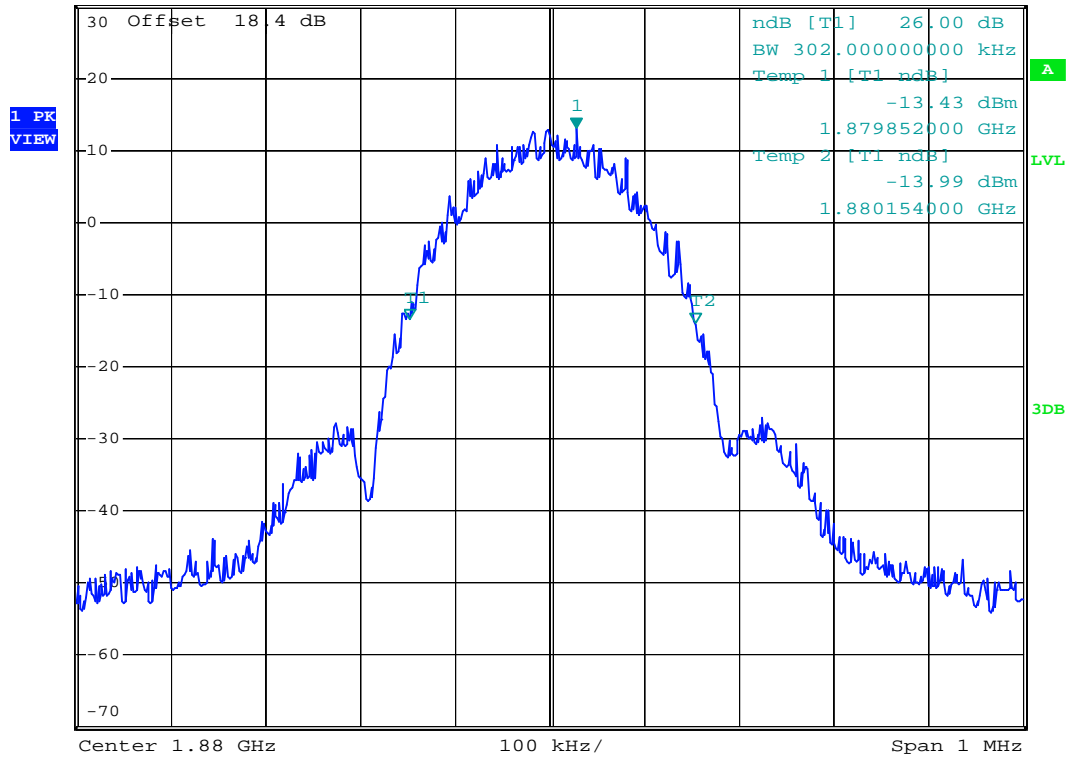

Date: 9.AUG.2008 02:23:20



- Test Mode : GSM1900 (EDGE) CH810 26dB Bandwidth
- Power State : High



Ref 30 dBm *Att 30 dB *RBW 3 kHz Marker 1 [T1]
 *VBW 10 kHz 13.67 dBm
 *SWT 300 ms 1.909766000 GHz

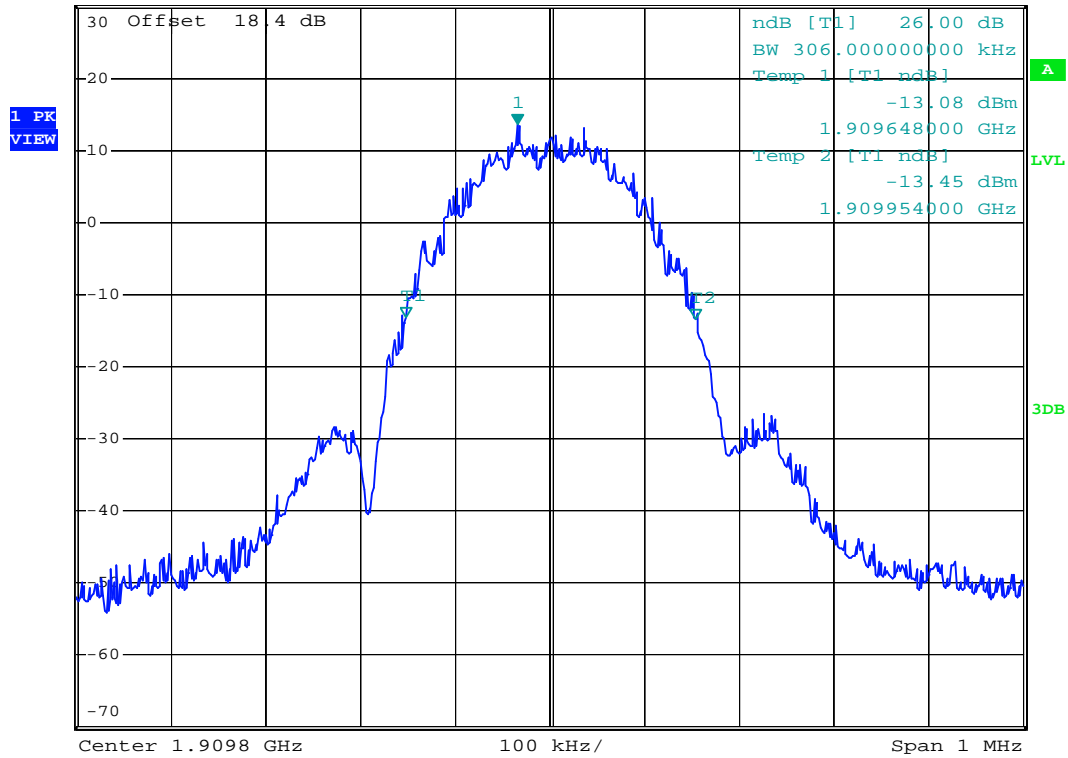

Date: 9.AUG.2008 02:24:21



- Test Mode : GSM1900(EDGE) CH810 Higher Band Edge
- Power State : High



Ref 30 dBm *Att 30 dB *RBW 3 kHz Marker 1 [T1]
*VBW 3 kHz -27.96 dBm
*SWT 300 ms 1.910032000 GHz

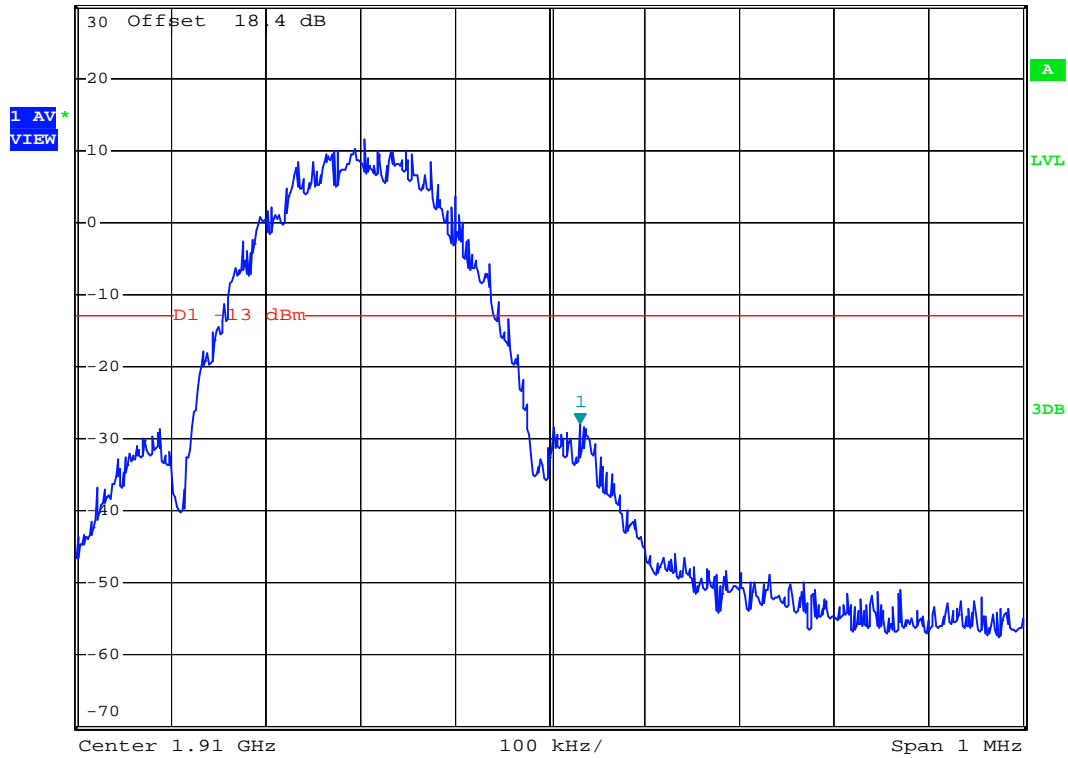

Date: 9.AUG.2008 02:31:15



- Mode 5
- Test Mode : WCDMA Band V CH4132 Lower Band Edge
- Power State : High

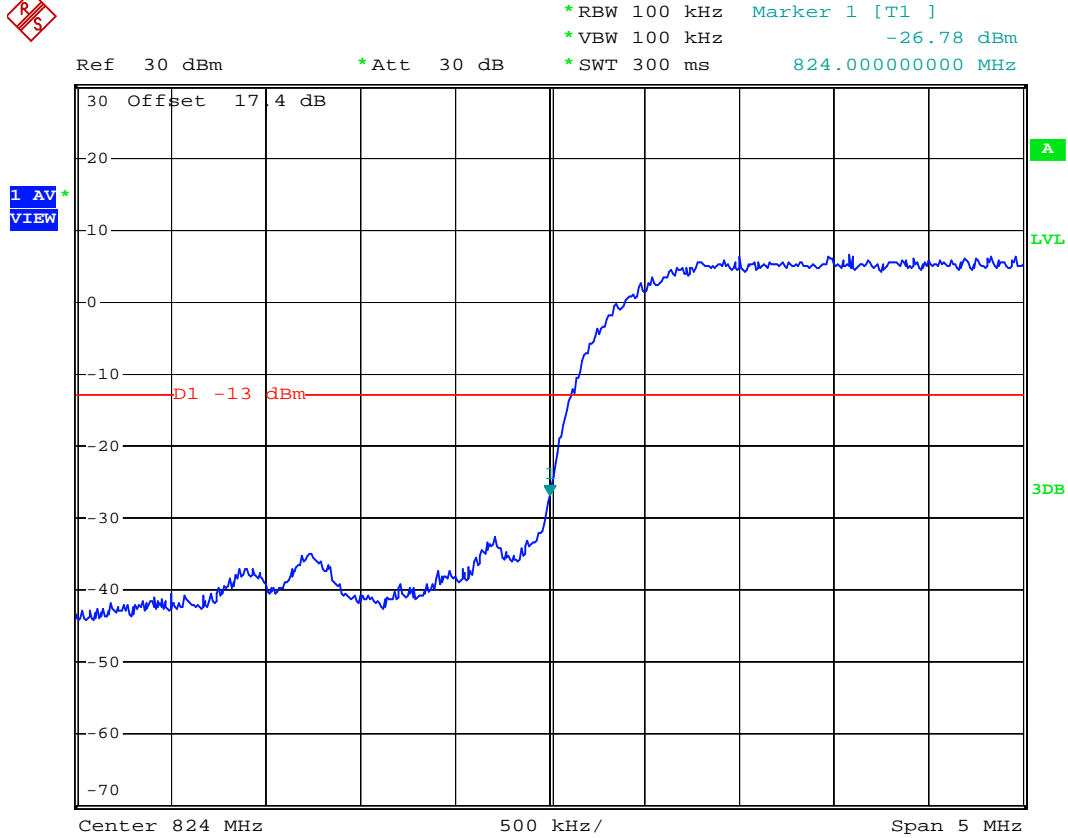

Date: 9.AUG.2008 06:11:49



- Test Mode : WCDMA Band V CH4132 99% Occupied Bandwidth
- Power State : High



Ref 30 dBm *Att 30 dB *RBW 100 kHz Marker 1 [T1]
 *VBW 300 kHz 16.81 dBm
 *SWT 300 ms 826.980000000 MHz

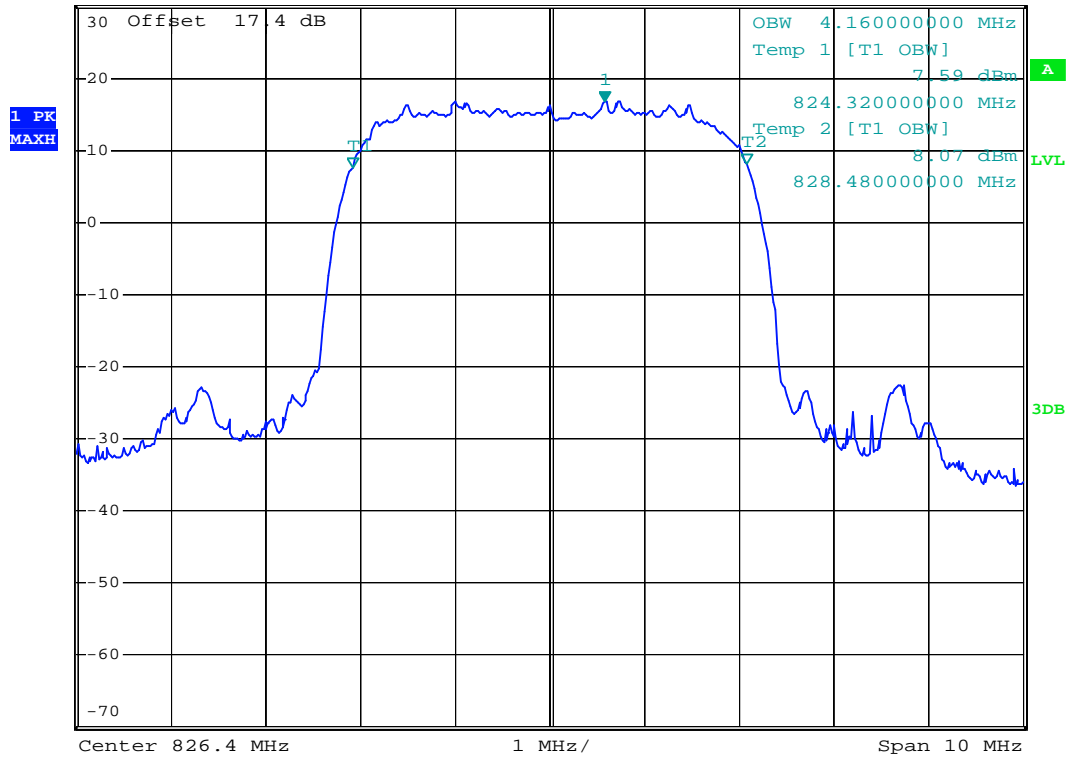

Date: 9.AUG.2008 03:44:41



- Test Mode : WCDMA Band V CH4182 99% Occupied Bandwidth
- Power State : High



Ref 30 dBm *Att 30 dB *RBW 100 kHz Marker 1 [T1]
 *VBW 300 kHz 16.93 dBm
 *SWT 300 ms 836.980000000 MHz

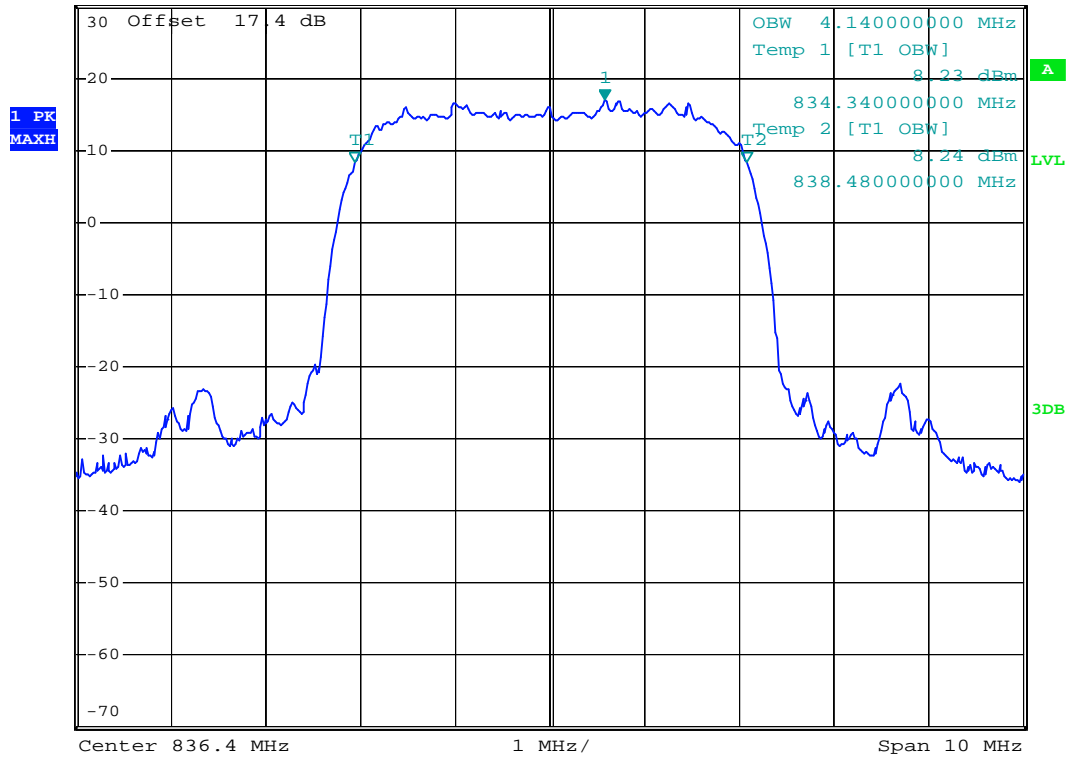

Date: 9.AUG.2008 03:42:03



- Test Mode : WCDMA Band V CH4233 99% Occupied Bandwidth
- Power State : High

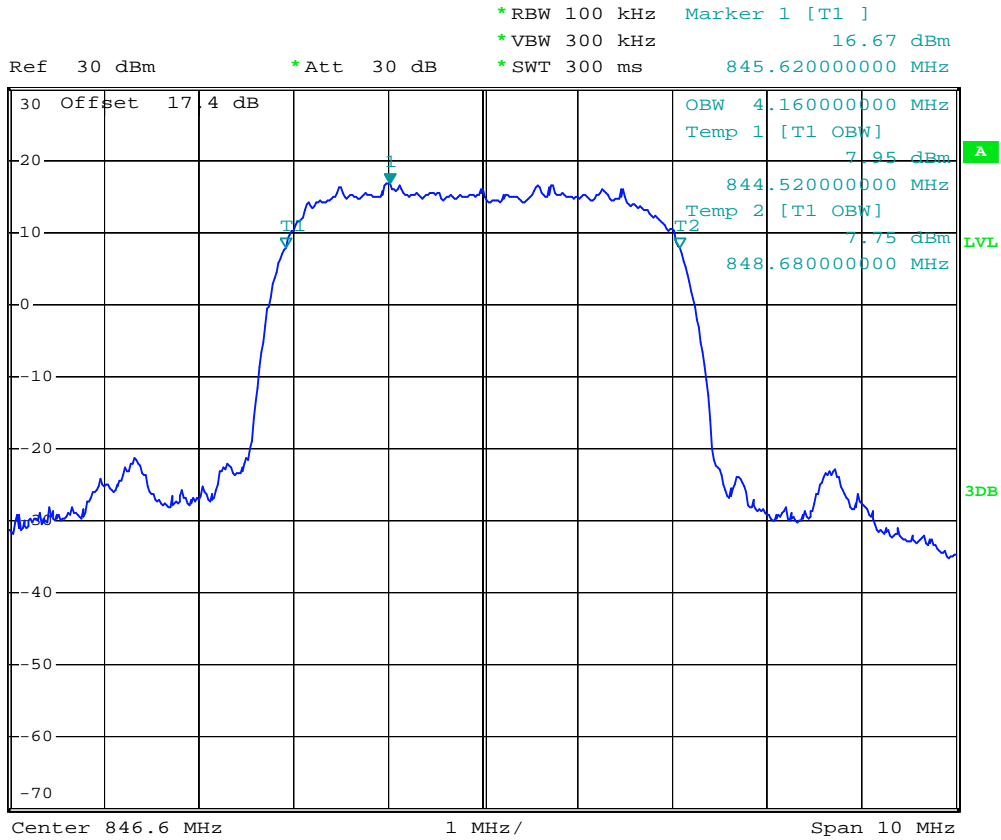

Date: 9.AUG.2008 03:45:19



- Test Mode : WCDMA Band V CH4132 26dB Bandwidth
- Power State : High



Ref 30 dBm *Att 30 dB *RBW 100 kHz Marker 1 [T1]
 *VBW 300 kHz 16.53 dBm
 *SWT 300 ms 825.400000000 MHz

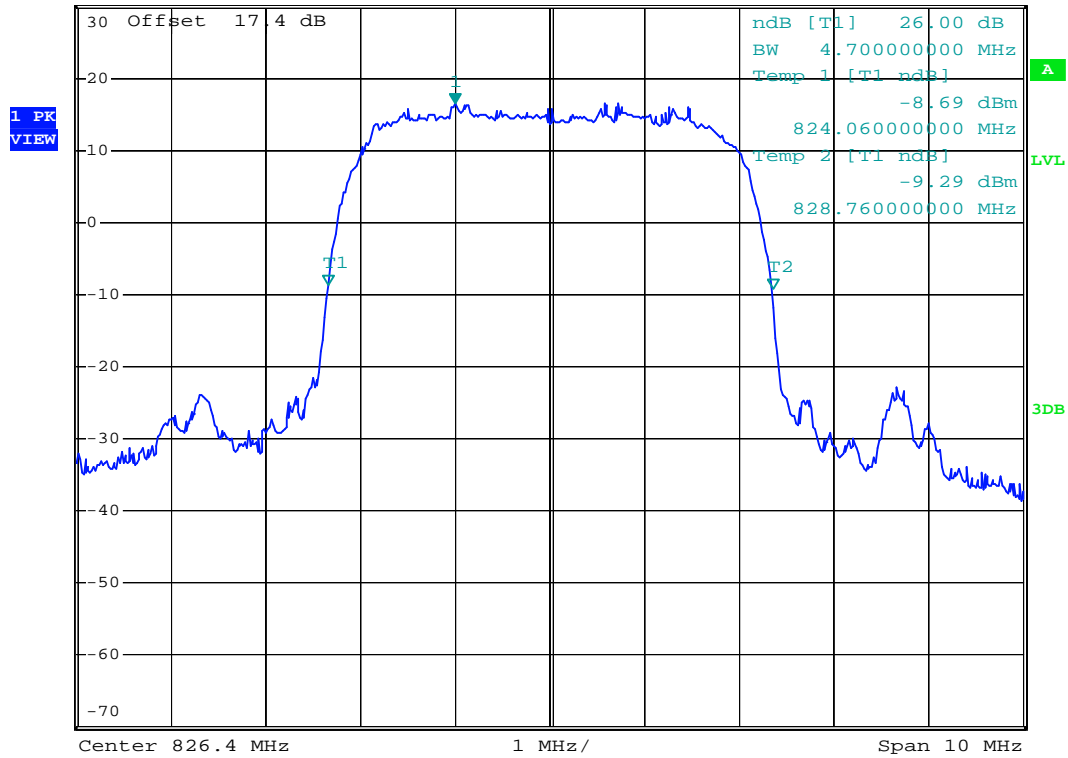

Date: 9.AUG.2008 03:40:13



- Test Mode : WCDMA Band V CH4182 26dB Bandwidth
- Power State : High



Ref 30 dBm *Att 30 dB *RBW 100 kHz Marker 1 [T1]
 *VBW 300 kHz 16.67 dBm
 *SWT 300 ms 837.12000000 MHz

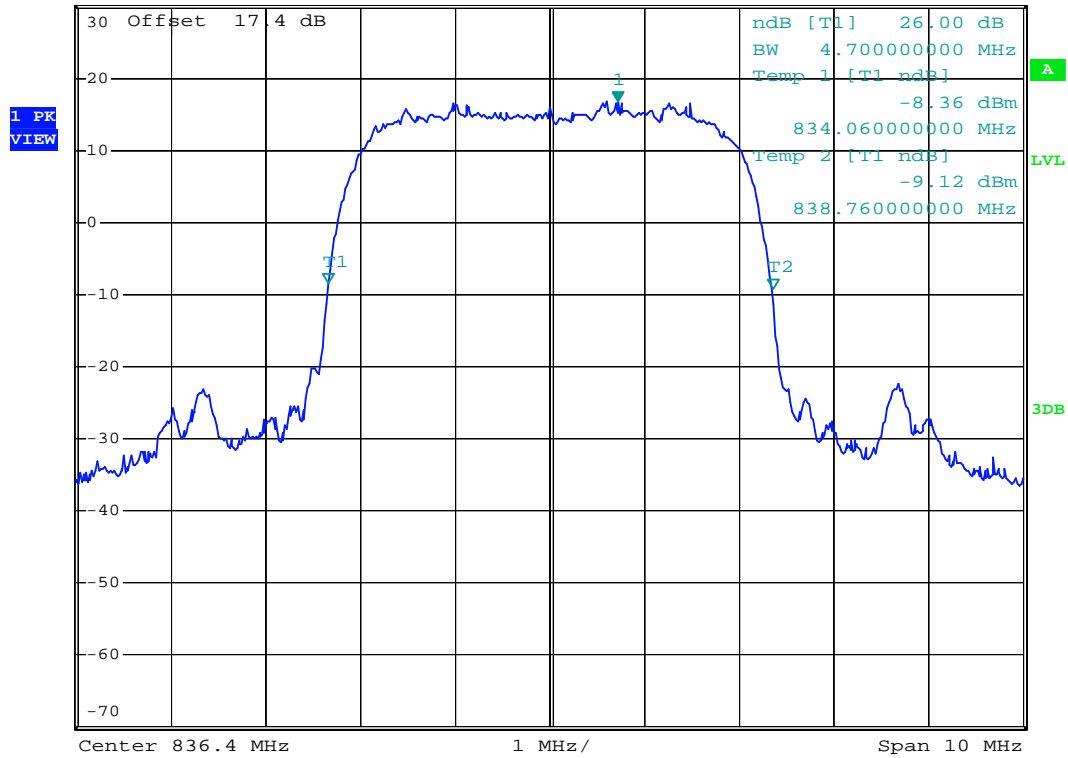

Date: 9.AUG.2008 03:40:37



- Test Mode : WCDMA Band V CH4233 26dB Bandwidth
- Power State : High



Ref 30 dBm *Att 30 dB *RBW 100 kHz Marker 1 [T1] *VBW 300 kHz 16.66 dBm *SWT 300 ms 845.580000000 MHz

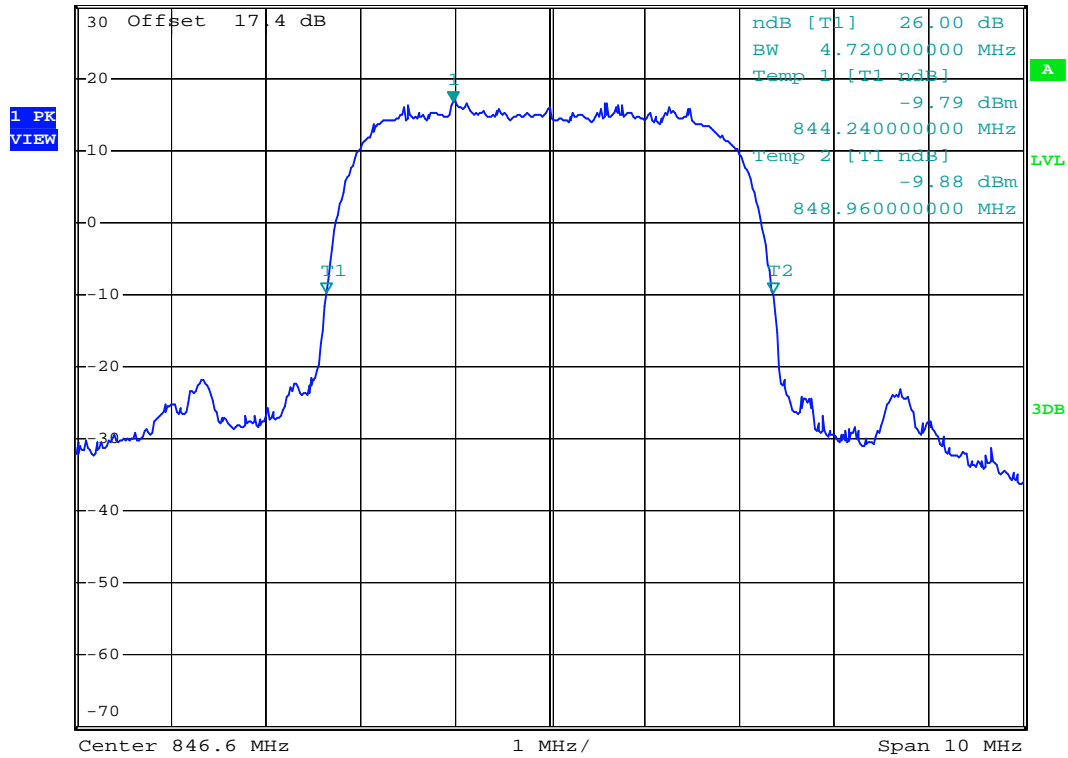

Date: 9.AUG.2008 03:40:58



- Test Mode : WCDMA Band V CH4233 Higher Band Edge
- Power State : High

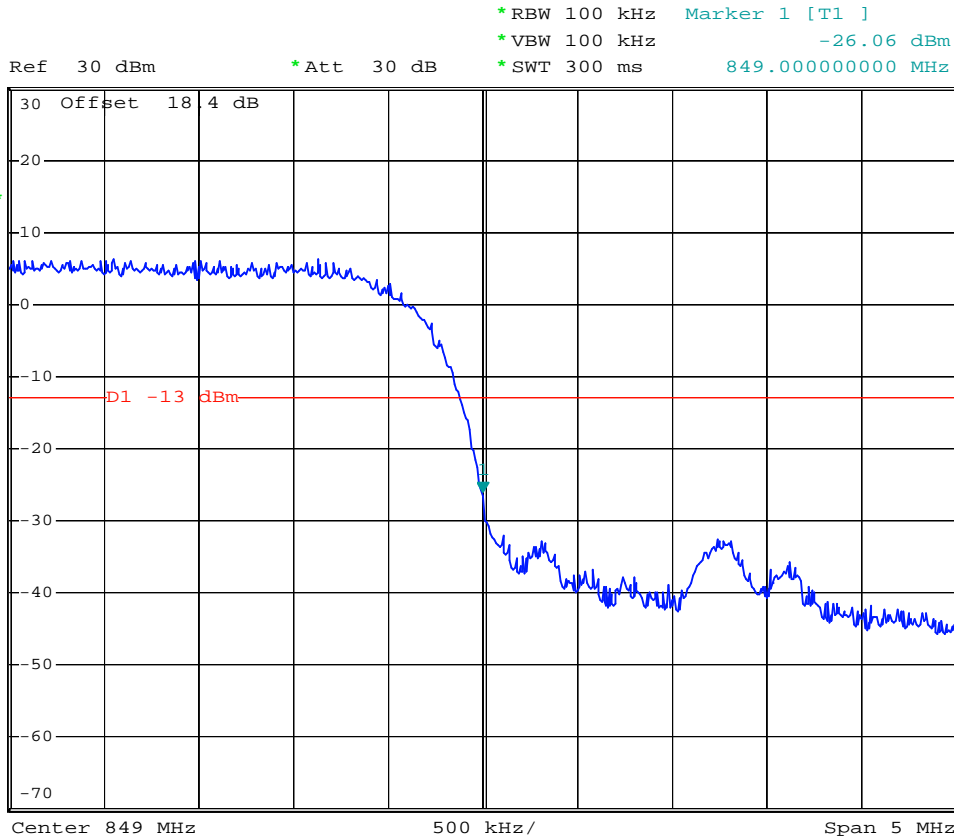

Date: 9.AUG.2008 05:02:45



- Mode 6
- Test Mode : WCDMA Band V (HSUPA) CH4132 Lower Band Edge
- Power State : High

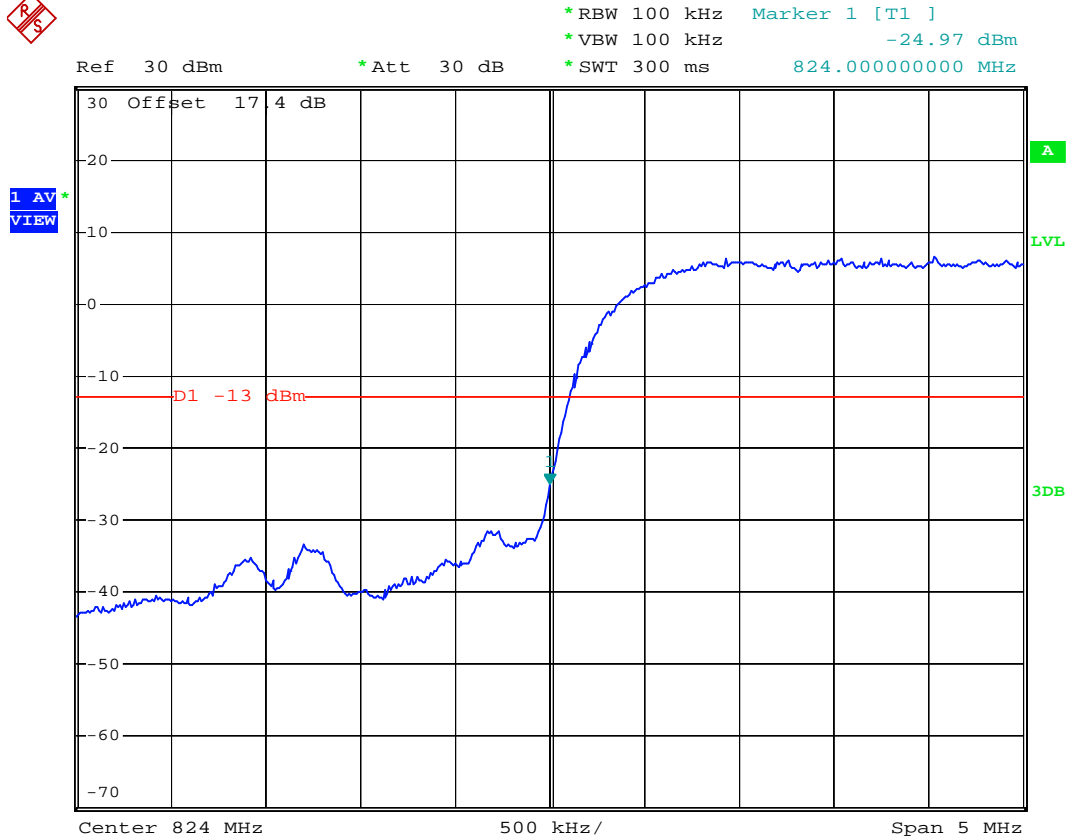

Date: 10.AUG.2008 01:36:38



- Test Mode : WCDMA Band V (HSUPA) CH4132 99% Occupied Bandwidth
- Power State : High

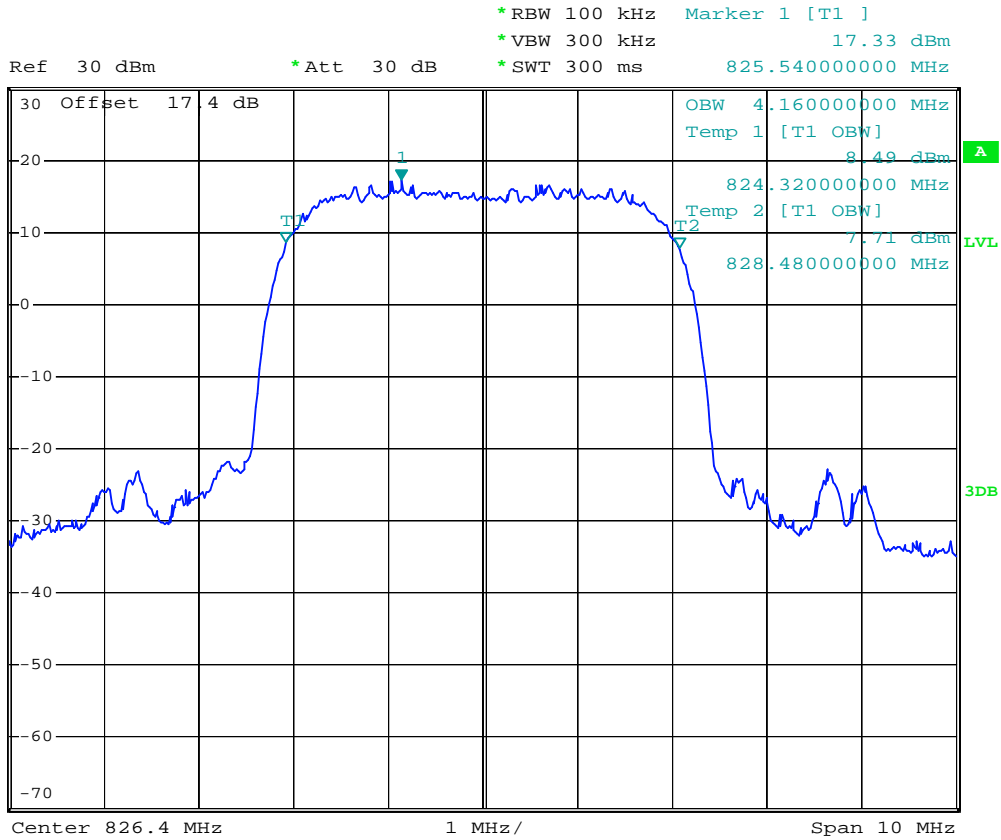

Date: 10.AUG.2008 01:32:26



- Test Mode : WCDMA Band V (HSUPA) CH4182 99% Occupied Bandwidth
- Power State : High



Ref 30 dBm *Att 30 dB *RBW 100 kHz Marker 1 [T1]
 *VBW 300 kHz 17.36 dBm
 *SWT 300 ms 835.520000000 MHz

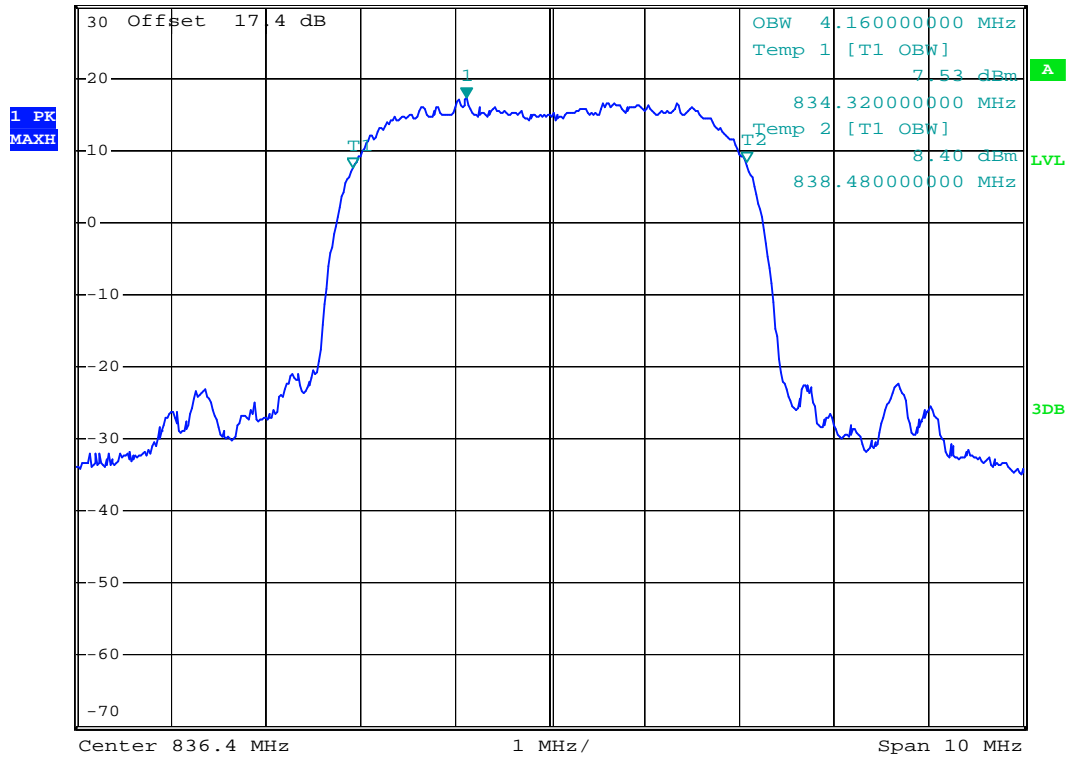

Date: 10.AUG.2008 01:32:06



- Test Mode : WCDMA Band V (HSUPA) CH4233 99% Occupied Bandwidth
- Power State : High



Ref 30 dBm *Att 30 dB *RBW 100 kHz Marker 1 [T1]
 *VBW 300 kHz 17.16 dBm
 *SWT 300 ms 845.700000000 MHz

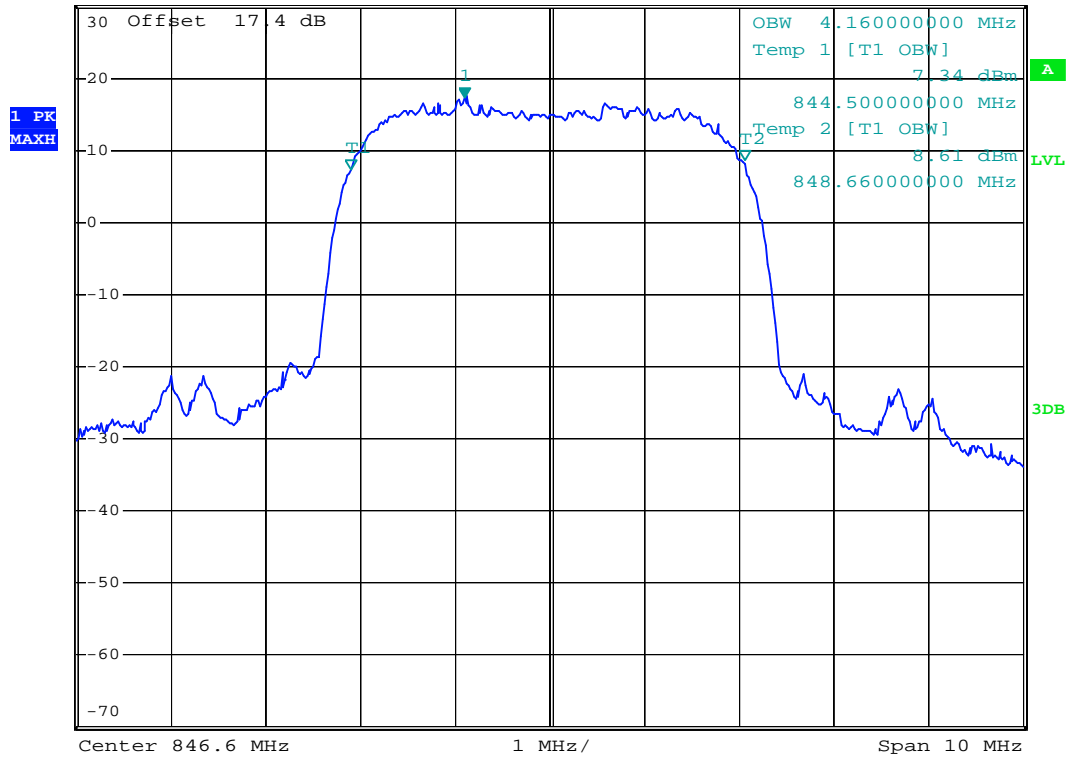

Date: 10.AUG.2008 01:31:27



- Test Mode : WCDMA Band V (HSUPA) CH4132 26dB Bandwidth
- Power State : High



Ref 30 dBm *Att 30 dB *RBW 100 kHz Marker 1 [T1]
 *VBW 300 kHz 17.04 dBm
 *SWT 300 ms 825.460000000 MHz

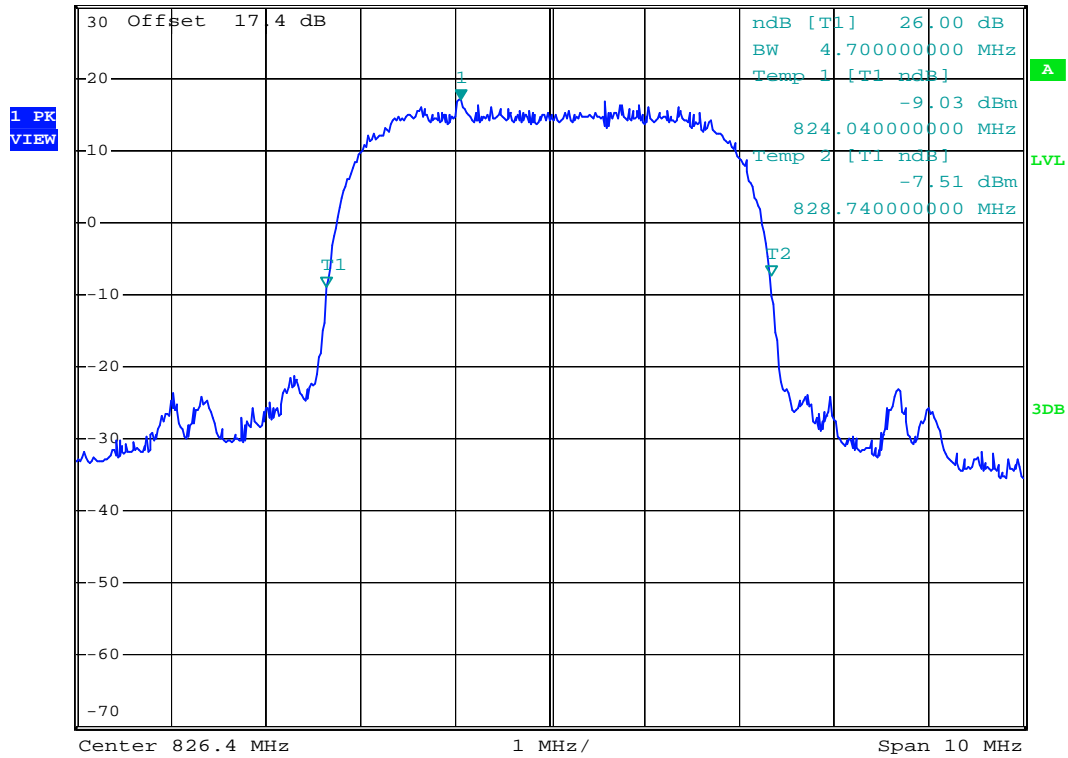

Date: 10.AUG.2008 01:25:53



- Test Mode : WCDMA Band V (HSUPA) CH4182 26dB Bandwidth
- Power State : High



Ref 30 dBm *Att 30 dB *RBW 100 kHz Marker 1 [T1]
 *VBW 300 kHz 17.50 dBm
 *SWT 300 ms 835.52000000 MHz

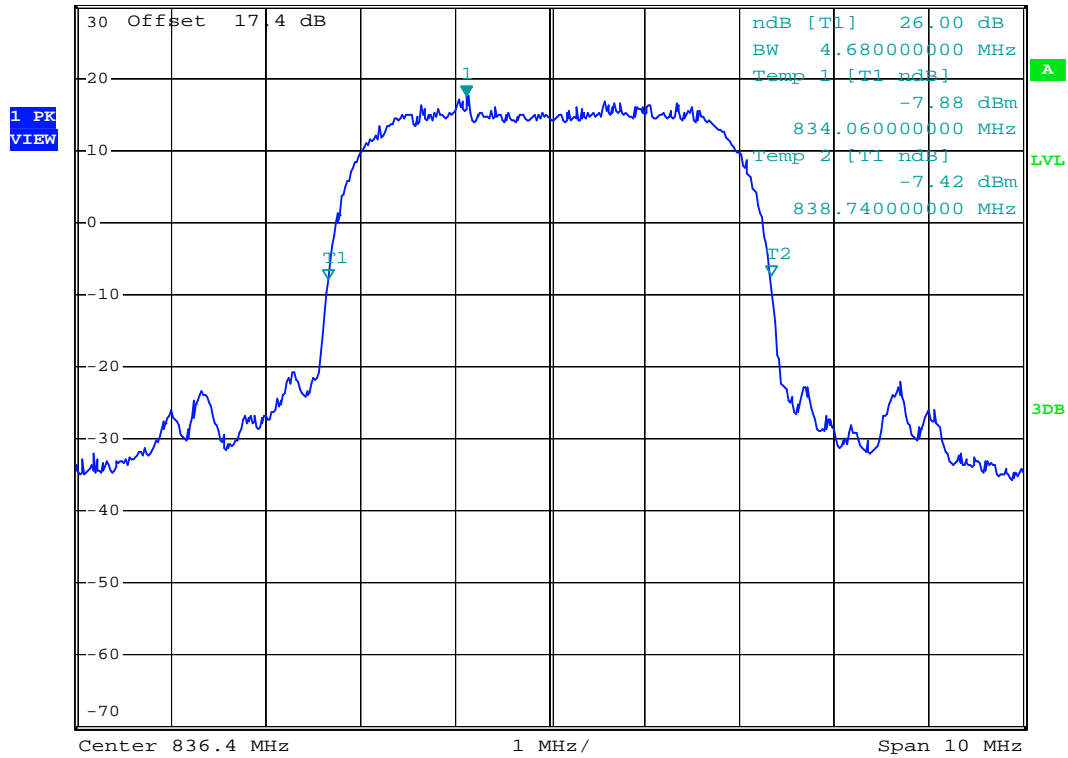

Date: 10.AUG.2008 01:25:35



- Test Mode : WCDMA Band V (HSUPA) CH4233 26dB Bandwidth
- Power State : High



Ref 30 dBm *Att 30 dB *RBW 100 kHz Marker 1 [T1]
 *VBW 300 kHz 16.57 dBm
 *SWT 300 ms 847.180000000 MHz

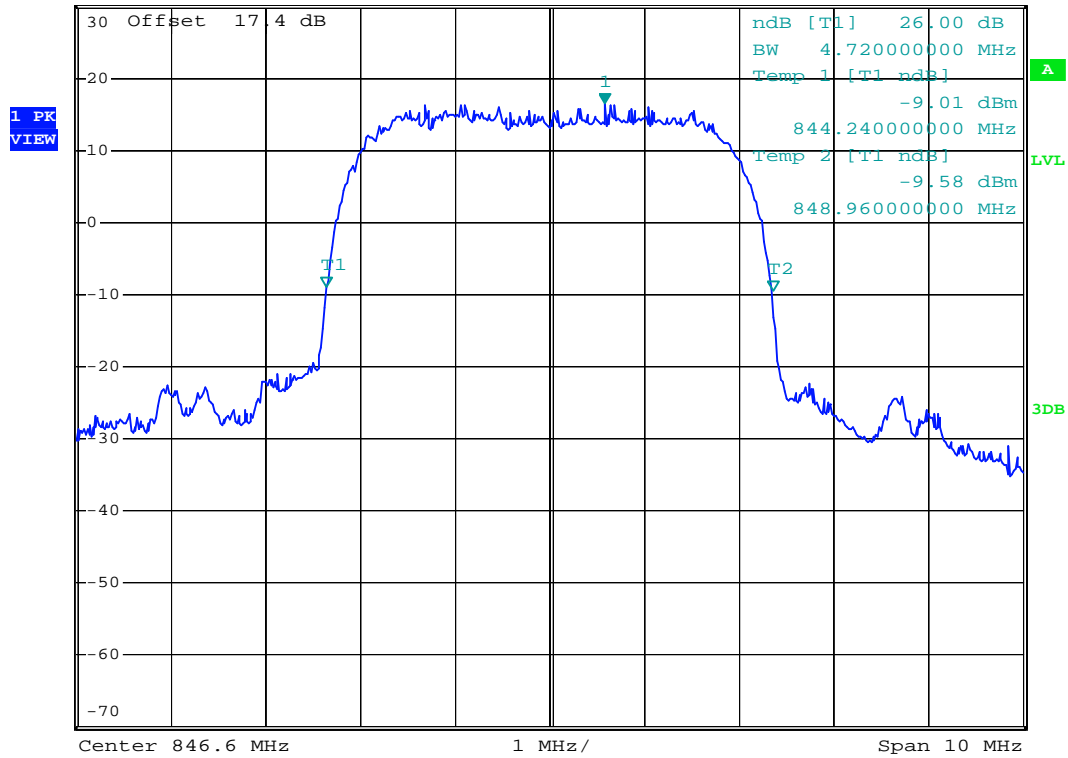

Date: 10.AUG.2008 01:26:21



- Test Mode : WCDMA Band V (HSUPA) CH4233 Higher Band Edge
- Power State : High



Ref 30 dBm *Att 30 dB *RBW 100 kHz Marker 1 [T1]
*VBW 100 kHz -26.13 dBm
*SWT 300 ms 849.00000000 MHz

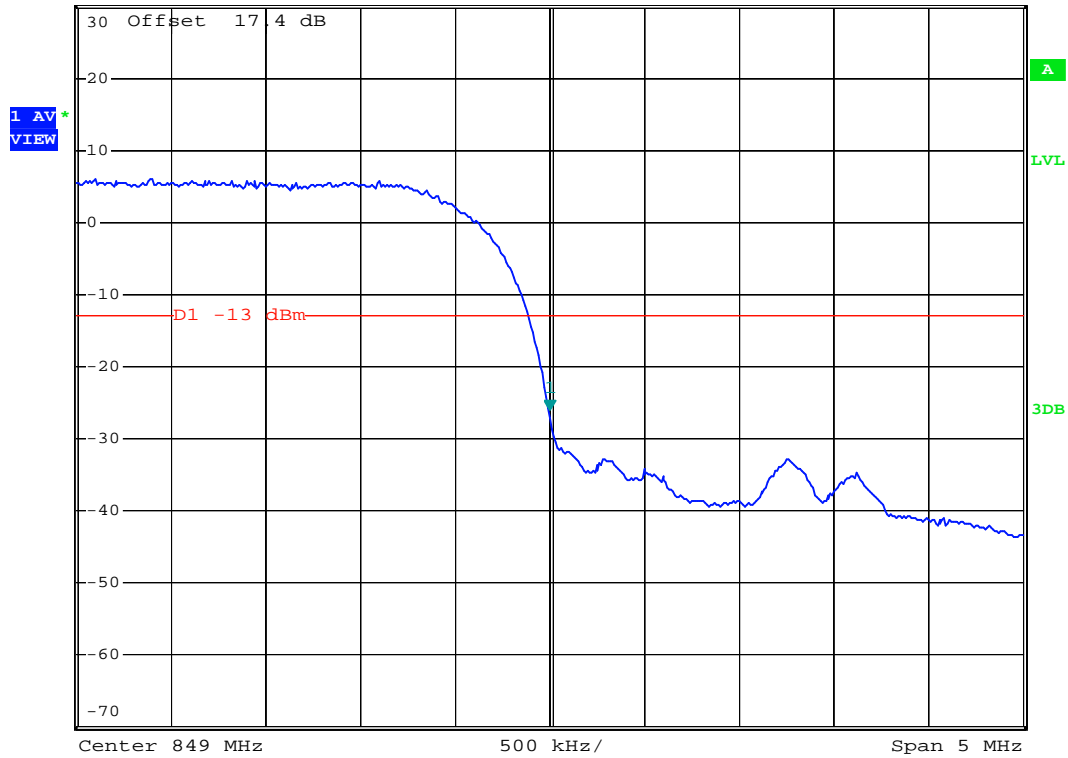

Date: 10.AUG.2008 01:37:01



- Mode 7
- Test Mode : WCDMA Band II CH9262 Lower Band Edge
- Power State : High

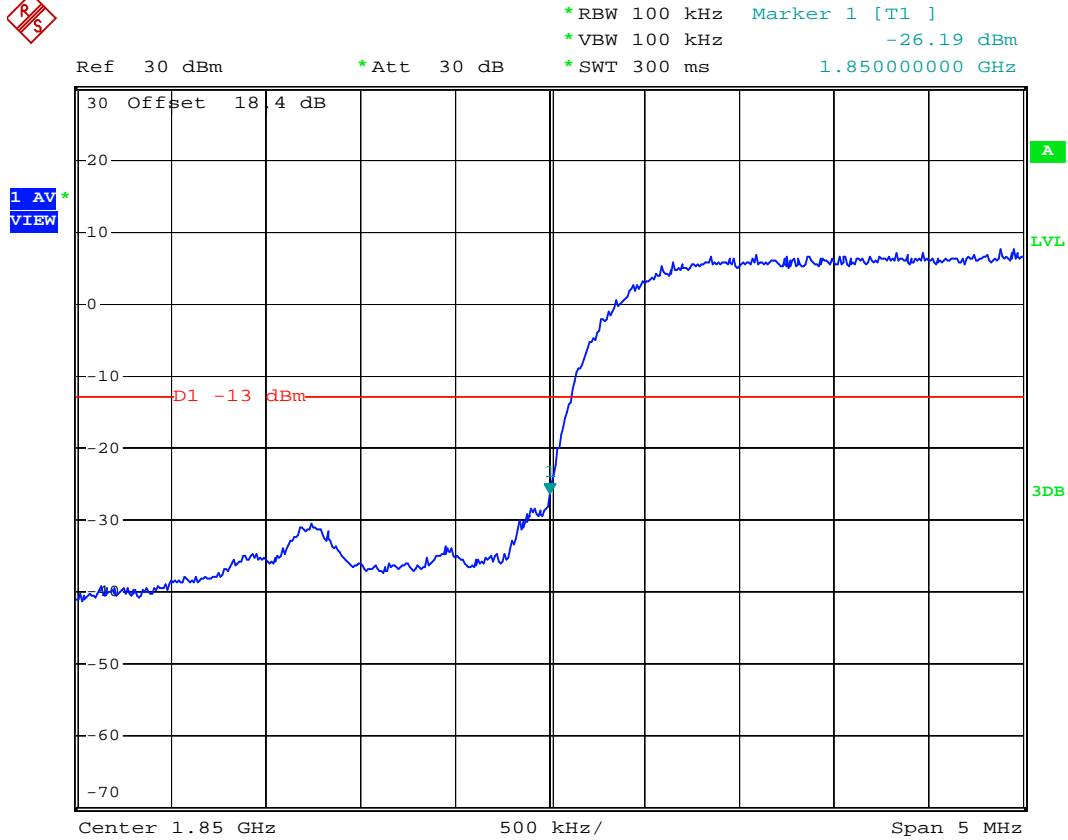

Date: 9.AUG.2008 04:49:02



- Test Mode : WCDMA Band II CH9262 99% Occupied Bandwidth
- Power State : High

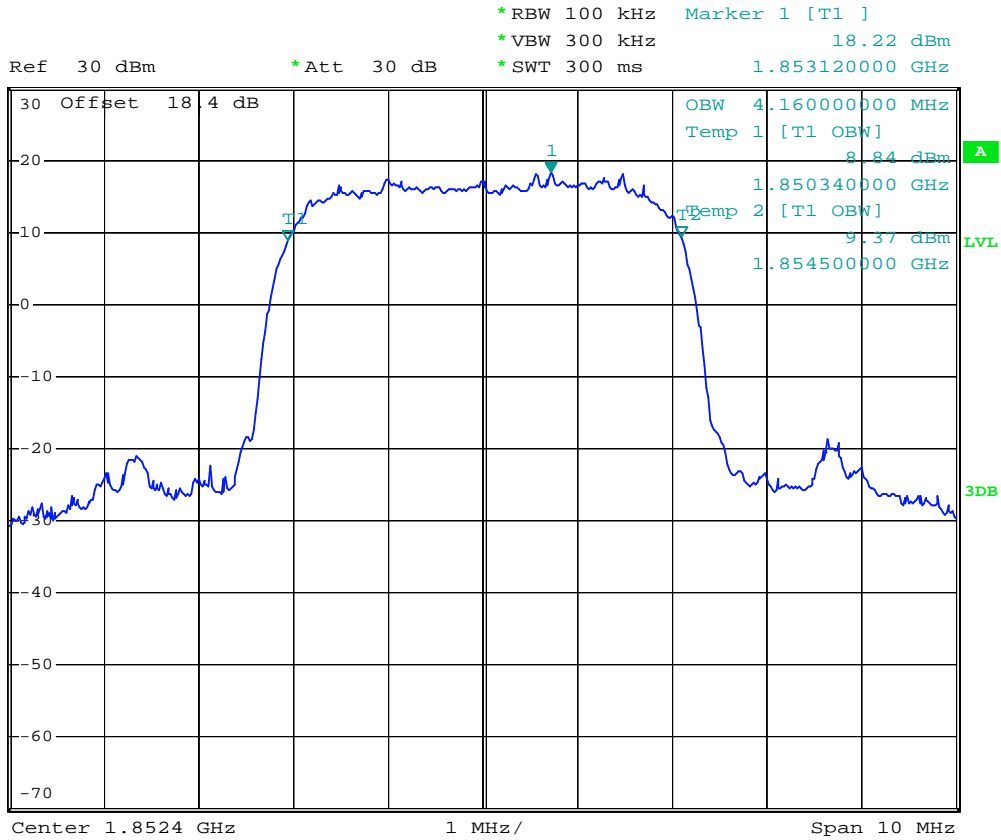

Date: 9.AUG.2008 04:20:17



- Test Mode : WCDMA Band II CH9400 99% Occupied Bandwidth
- Power State : High

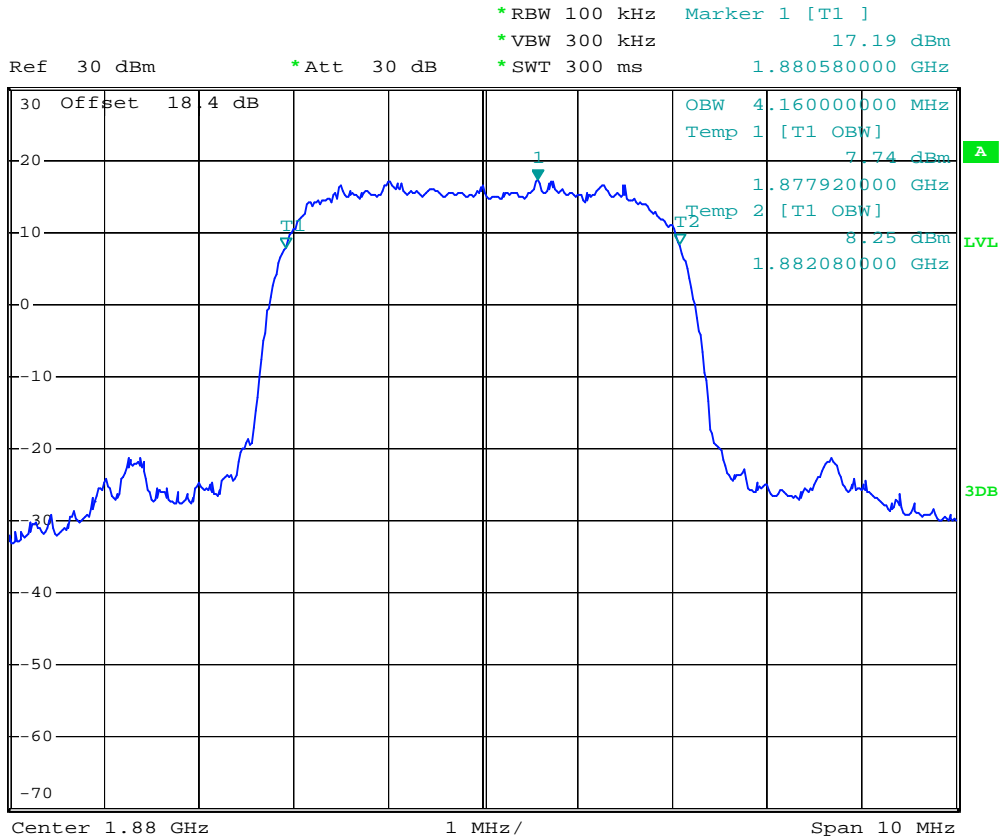

Date: 9.AUG.2008 04:19:28



- Test Mode : WCDMA Band II CH9538 99% Occupied Bandwidth
- Power State : High



*RBW 100 kHz Marker 1 [T1]
 *VBW 300 kHz 18.15 dBm
 *SWT 300 ms 1.906720000 GHz

Ref 30 dBm

*Att 30 dB

1 PK
MAXH

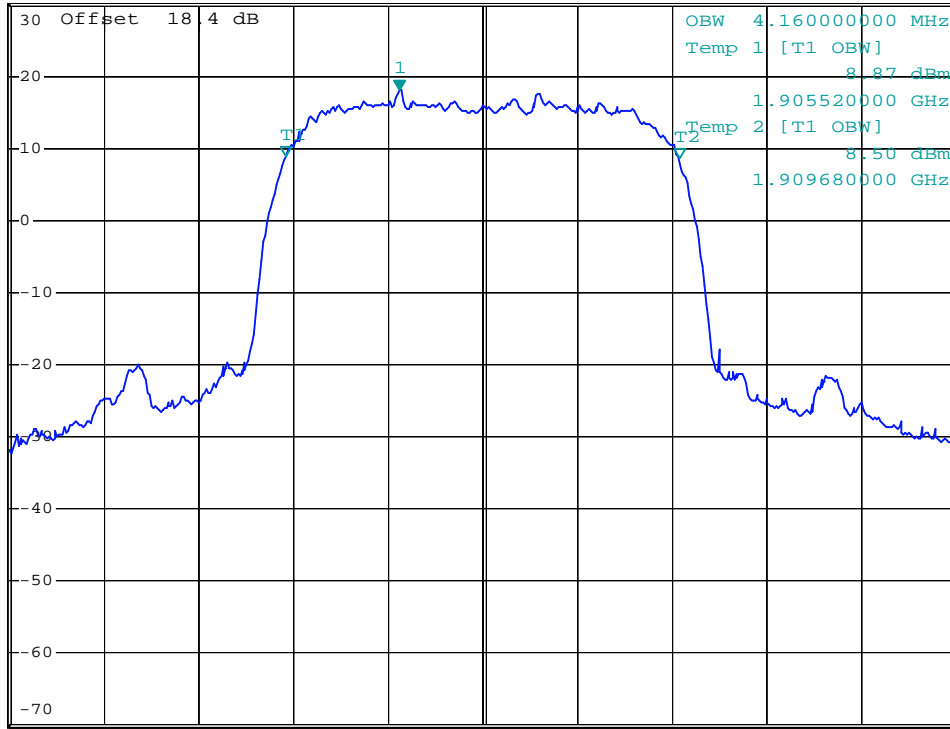

Center 1.9076 GHz

1 MHz/

Span 10 MHz

Date: 12.AUG.2008 03:16:12



- Test Mode : WCDMA Band II CH9262 26dB Bandwidth
- Power State : High



Ref 30 dBm *Att 30 dB *RBW 100 kHz Marker 1 [T1]
 *VBW 300 kHz 17.86 dBm
 *SWT 300 ms 1.853120000 GHz

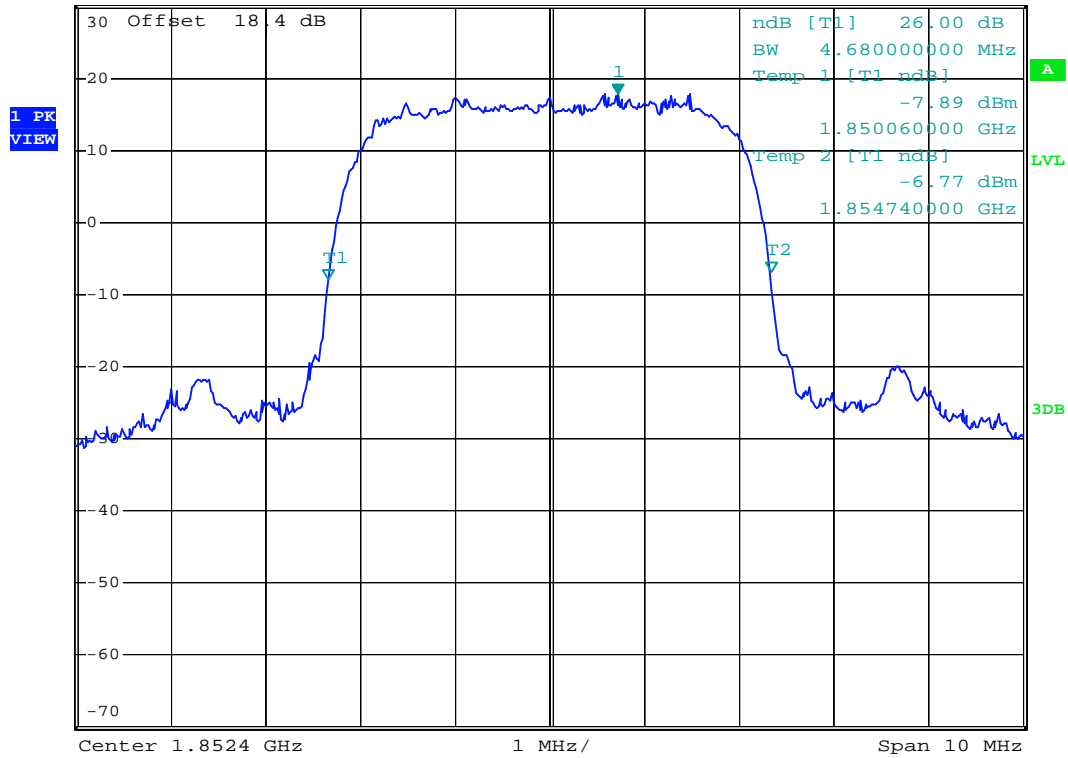

Date: 9.AUG.2008 04:14:25



- Test Mode : WCDMA Band II CH9400 26dB Bandwidth
- Power State : High



Ref 30 dBm *Att 30 dB *RBW 100 kHz Marker 1 [T1]
 *VBW 300 kHz 17.14 dBm
 *SWT 300 ms 1.880580000 GHz

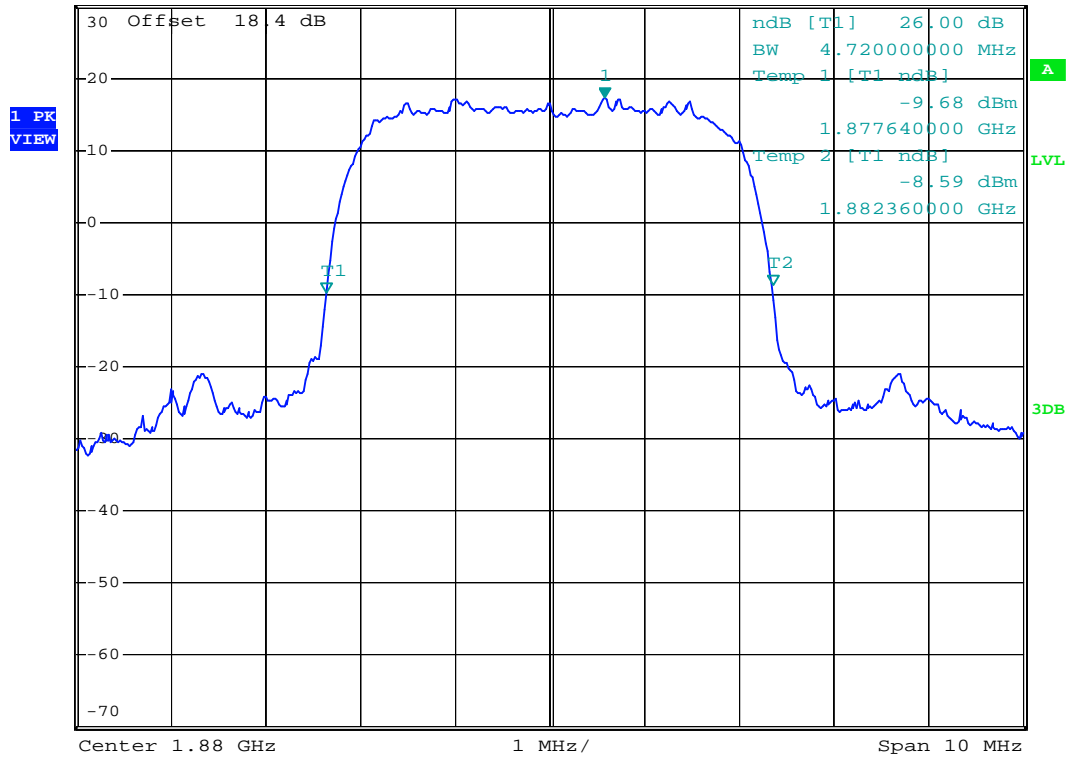

Date: 9.AUG.2008 04:15:52



- Test Mode : WCDMA Band II CH9538 26dB Bandwidth
- Power State : High



*RBW 100 kHz Marker 1 [T1]
 *VBW 300 kHz 17.11 dBm
 *SWT 300 ms 1.906580000 GHz

Ref 30 dBm

*Att 30 dB

1 PK VIEW

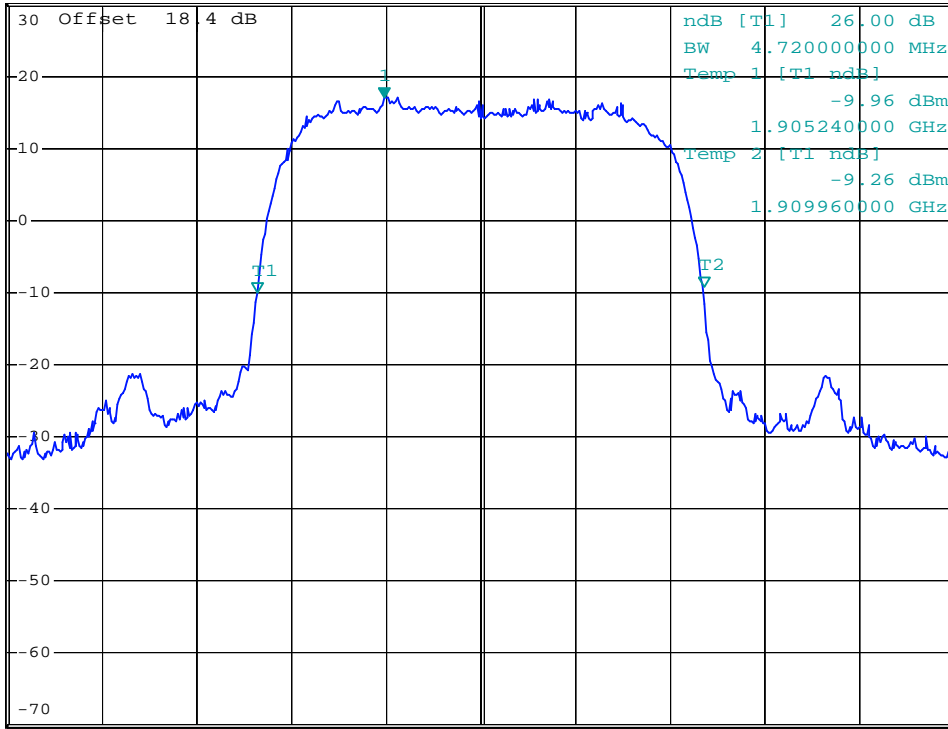

Center 1.9076 GHz

1 MHz/

Span 10 MHz

Date: 9.AUG.2008 04:18:15



- Test Mode : WCDMA Band II CH9538 Higher Band Edge
- Power State : High

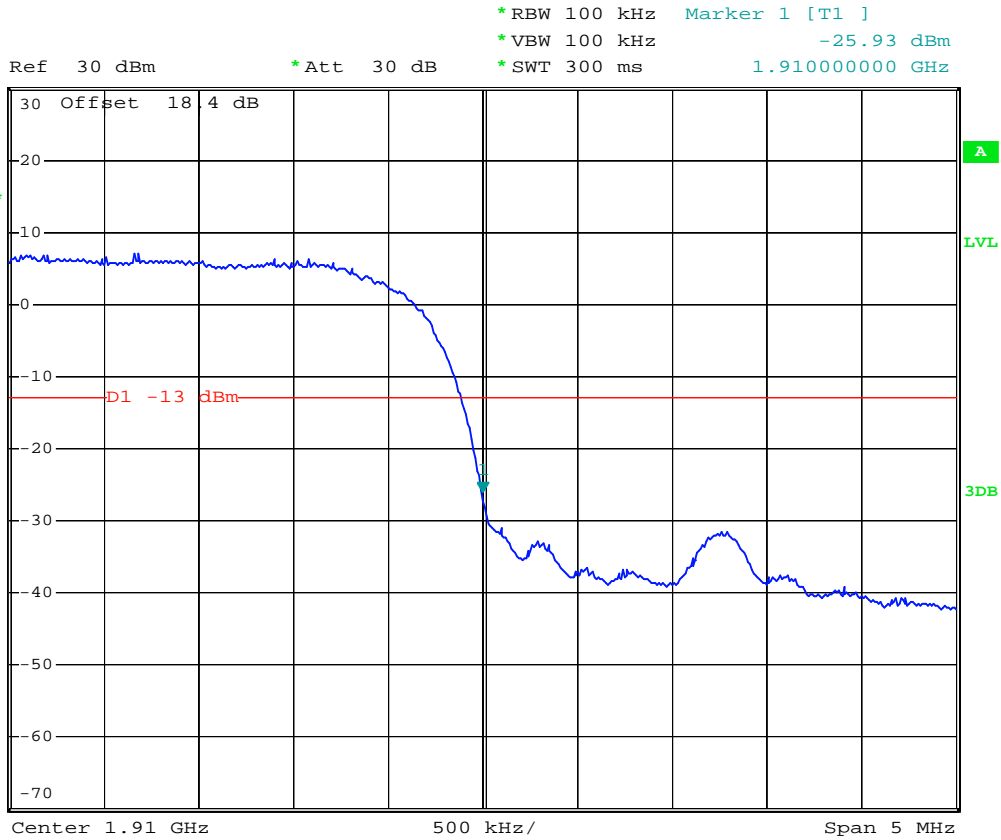

Date: 9.AUG.2008 04:45:10



- Mode 8
- Test Mode : WCDMA Band II (HSUPA) CH9262 Lower Band Edge
- Power State : High

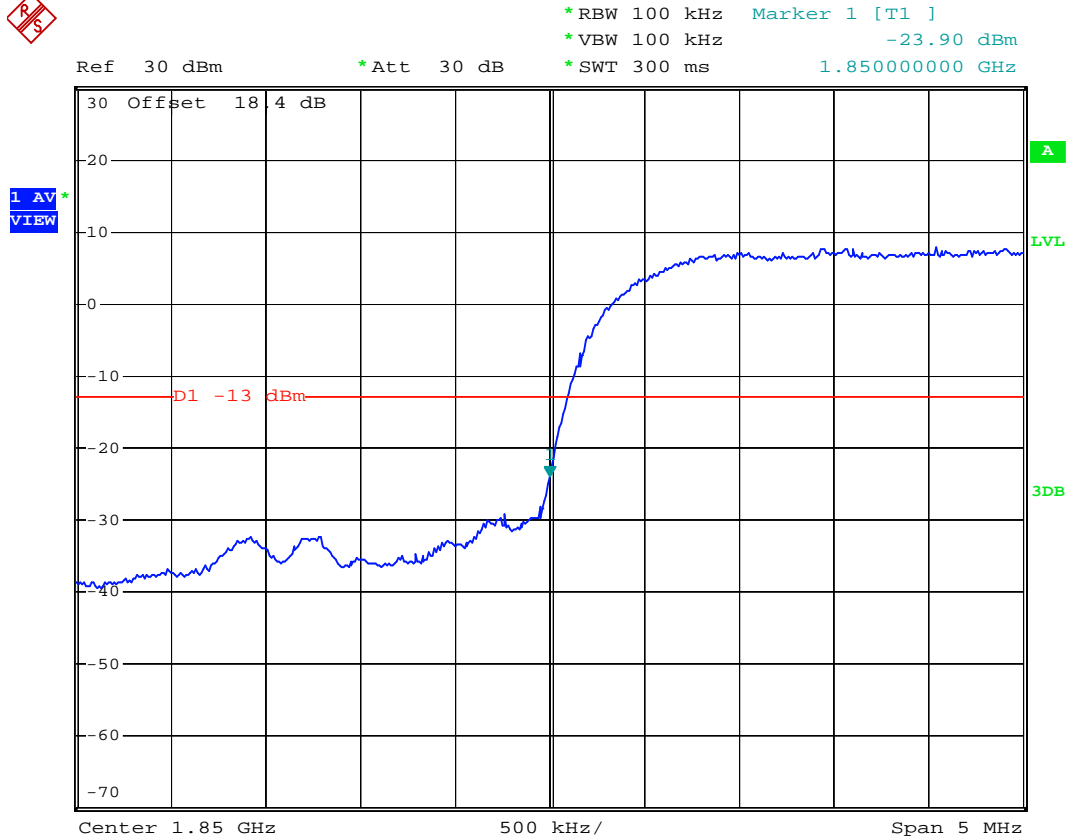

Date: 10.AUG.2008 02:03:29



- Test Mode : WCDMA Band II (HSUPA) CH9262 99% Occupid Bandwidth
- Power State : High

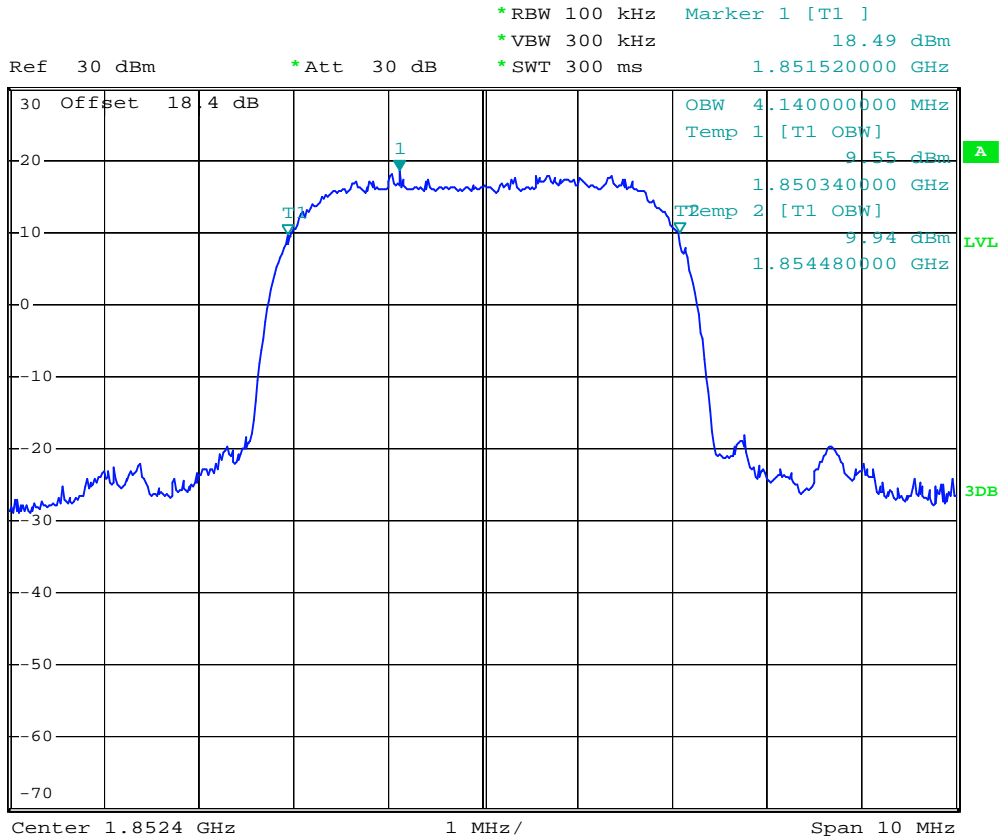

Date: 10.AUG.2008 02:01:37



- Test Mode : WCDMA Band II (HSUPA) CH9400 99% Occupid Bandwidth
- Power State : High

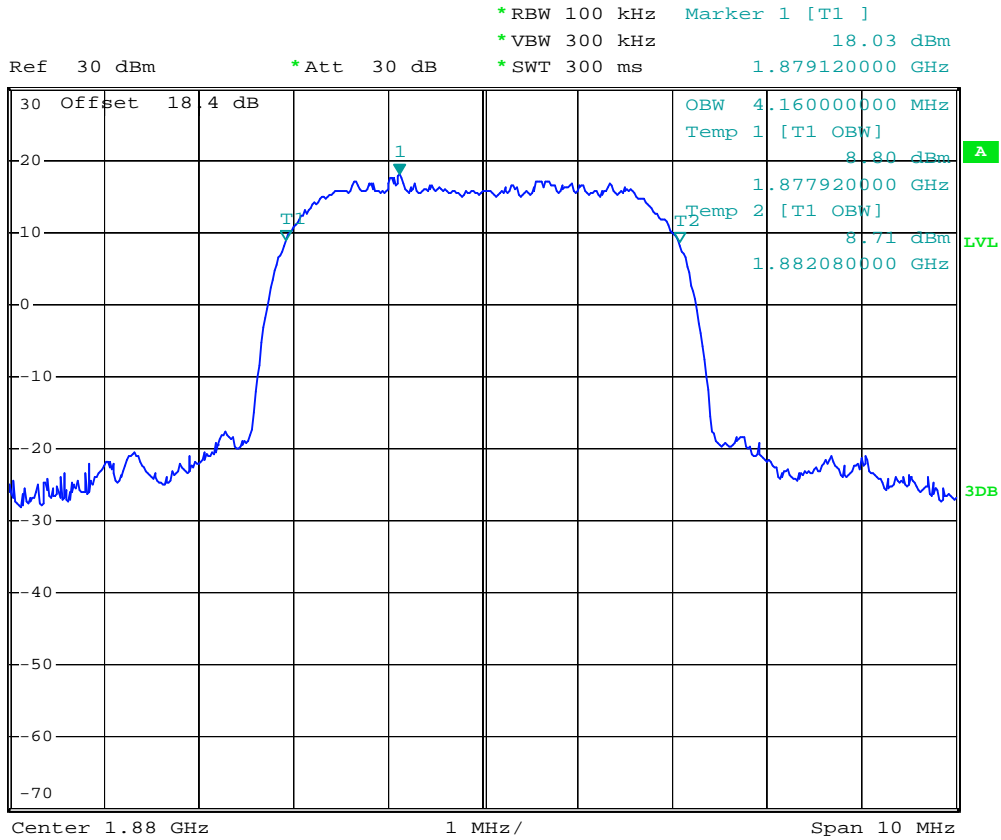

Date: 10.AUG.2008 02:01:08



- Test Mode : WCDMA Band II (HSUPA) CH9538 99% Occupid Bandwidth
- Power State : High

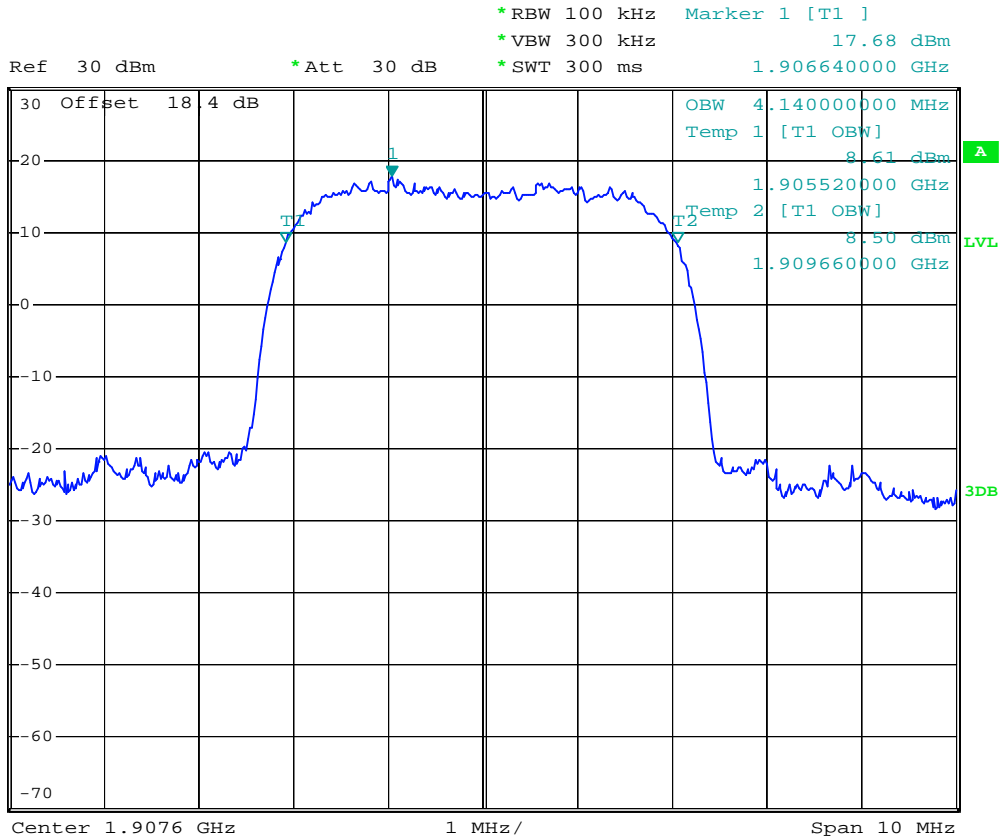

Date: 10.AUG.2008 02:06:08



- Test Mode : WCDMA Band II (HSUPA) CH9262 26dB Bandwidth
- Power State : High

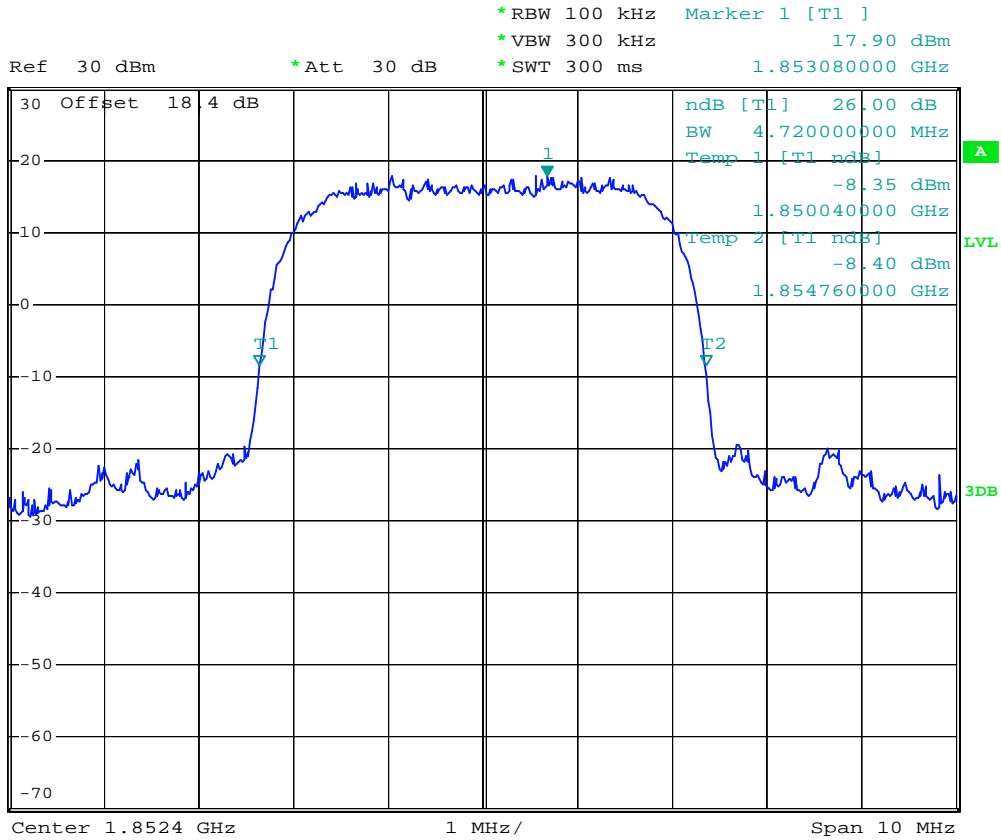

Date: 10.AUG.2008 01:59:41



- Test Mode : WCDMA Band II (HSUPA) CH9400 26dB Bandwidth
- Power State : High

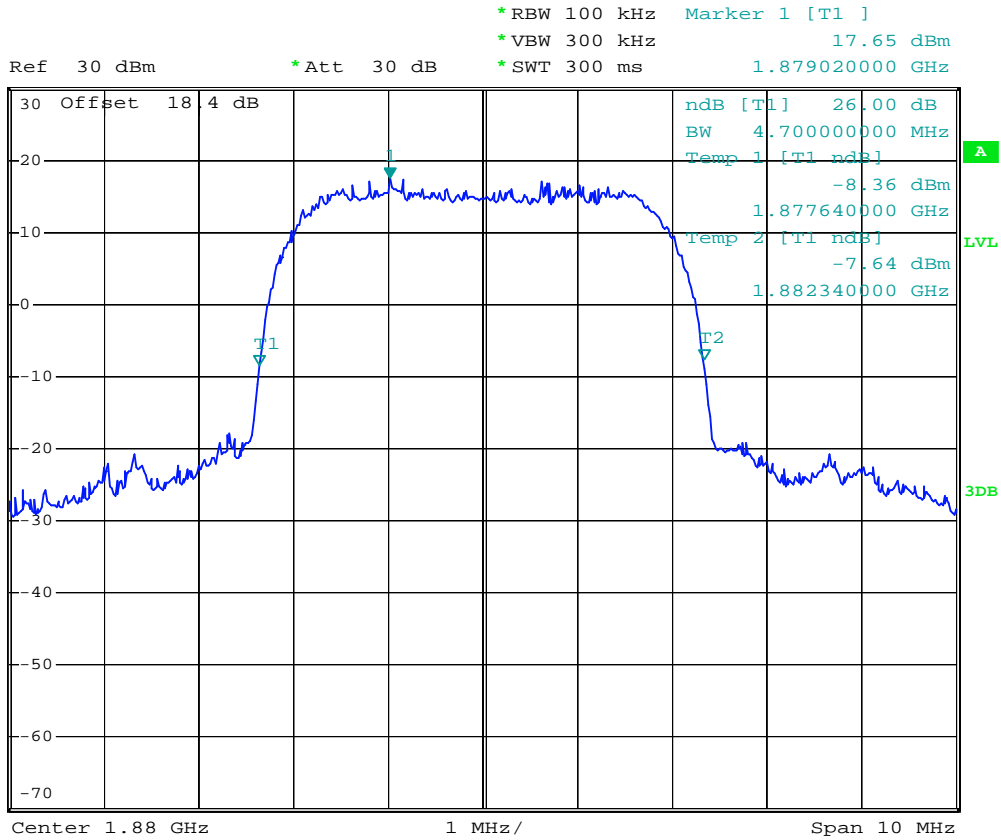

Date: 10.AUG.2008 01:59:56



- Test Mode : WCDMA Band II (HSUPA) CH9538 26dB Bandwidth
- Power State : High

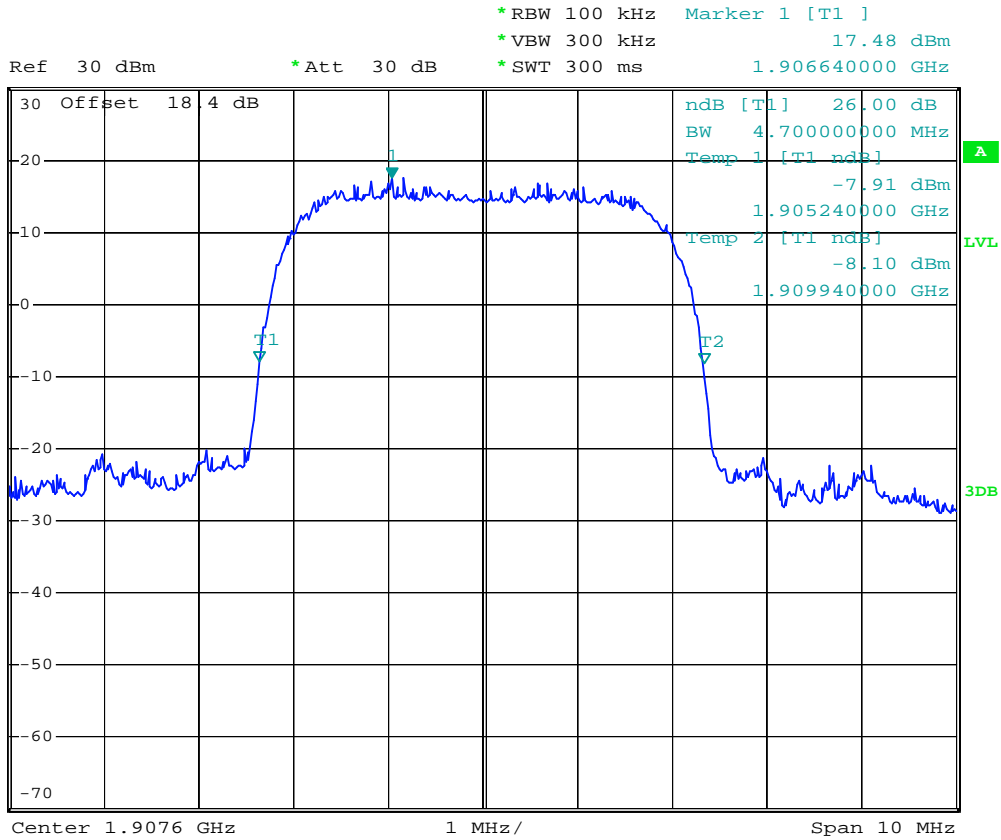

Date: 10.AUG.2008 02:00:16



- Test Mode : WCDMA Band II (HSUPA) CH9538 Higher Band Edge
- Power State : High

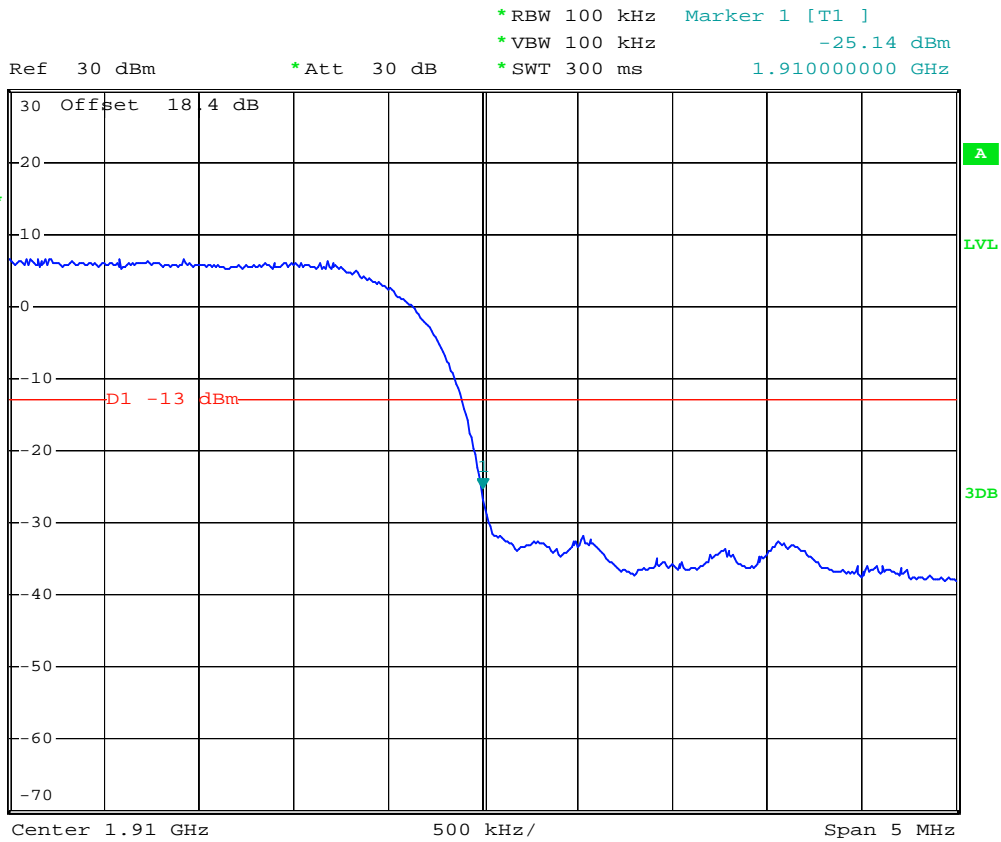

Date: 10.AUG.2008 02:05:19

4.5 Conducted Emission

4.5.1 Measurement Instruments

As described in chapter 5 of this test report.

4.5.2 Test Procedure

- a. The EUT was connected to Spectrum Analyzer and Base Station via power divider.
- b. The middle channel for the highest RF power within the transmitting frequency was measured.
- c. The conducted spurious emission for the whole frequency range was taken.

4.5.3 Test Setup Layout

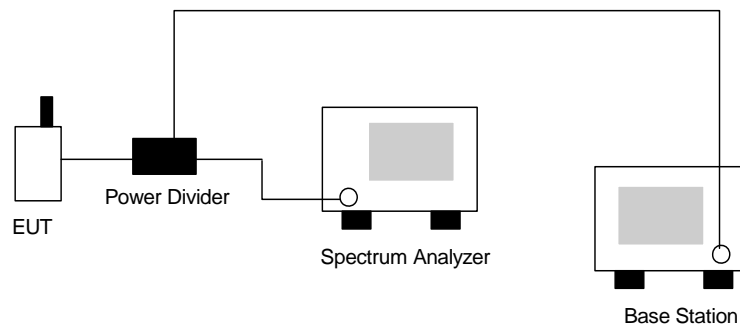



4.5.4 Test Result

- Mode 1
- Test Mode : GSM850 (GPRS) CH189
- Frequency Range : 30M-1G

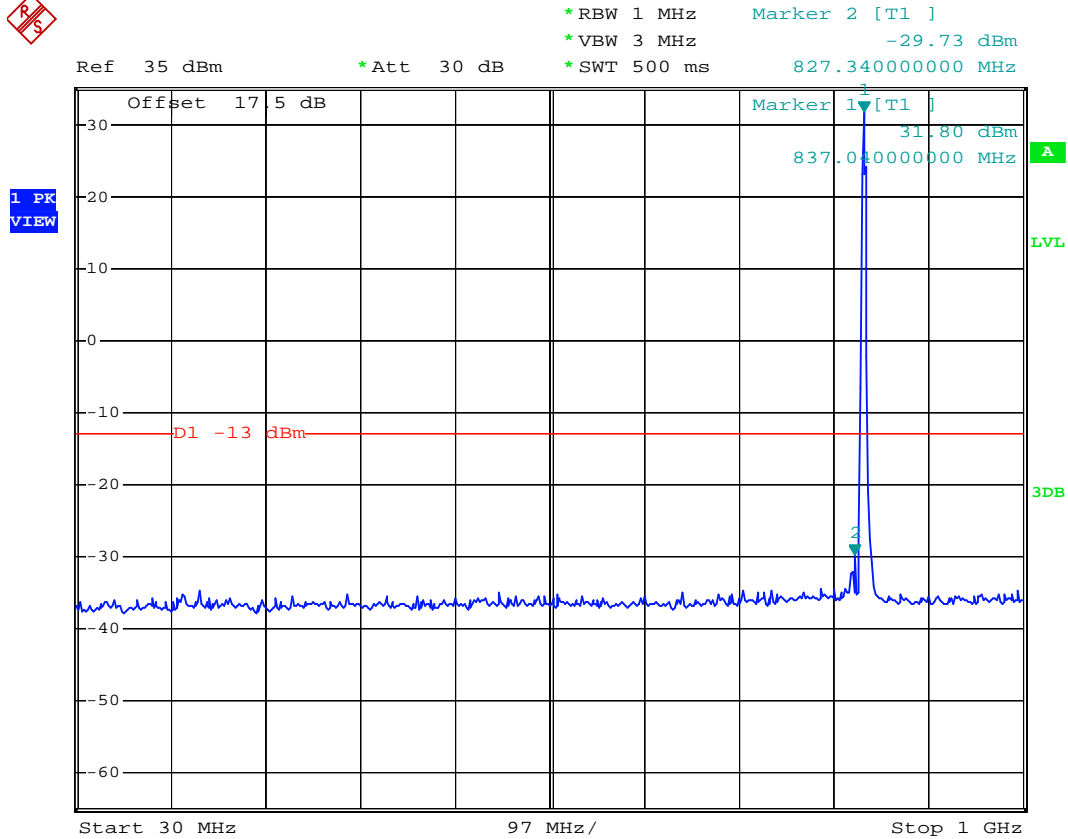

Date: 9.AUG.2008 01:01:58



- Test Mode : GSM850 (GPRS) CH189
- Frequency Range : 1G-3G



Ref 0 dBm *Att 0 dB *RBW 1 MHz Marker 2 [T1]
*VBW 3 MHz -48.97 dBm
*SWT 500 ms 1.672000000 GHz

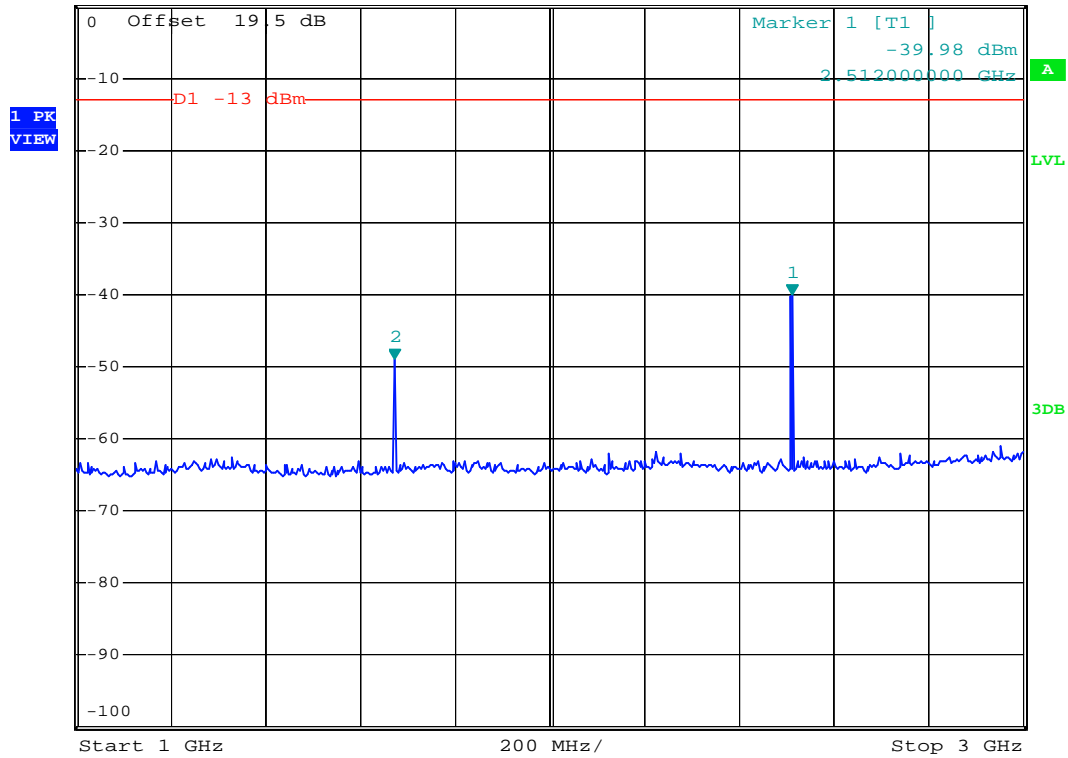

Date: 9.AUG.2008 01:03:36



- Test Mode : GSM850 (GPRS) CH189
- Frequency Range : 3G-7G

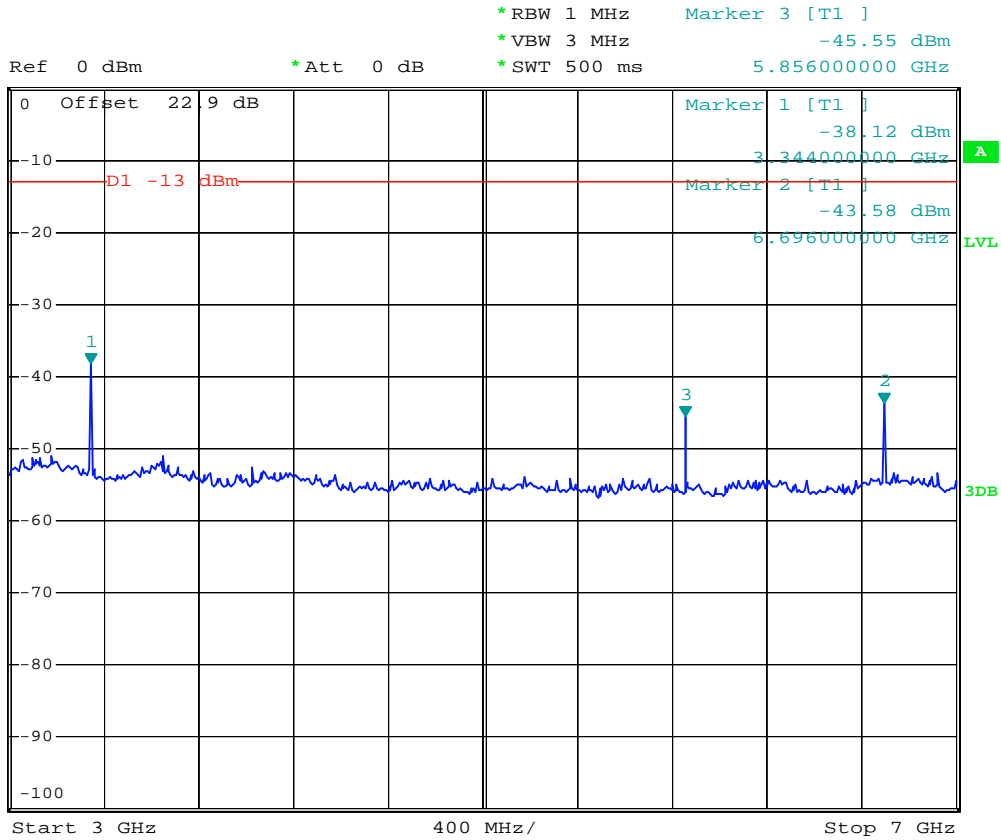

Date: 9.AUG.2008 01:04:06



- Test Mode : GSM850 (GPRS) CH189
- Frequency Range : 7G-9G

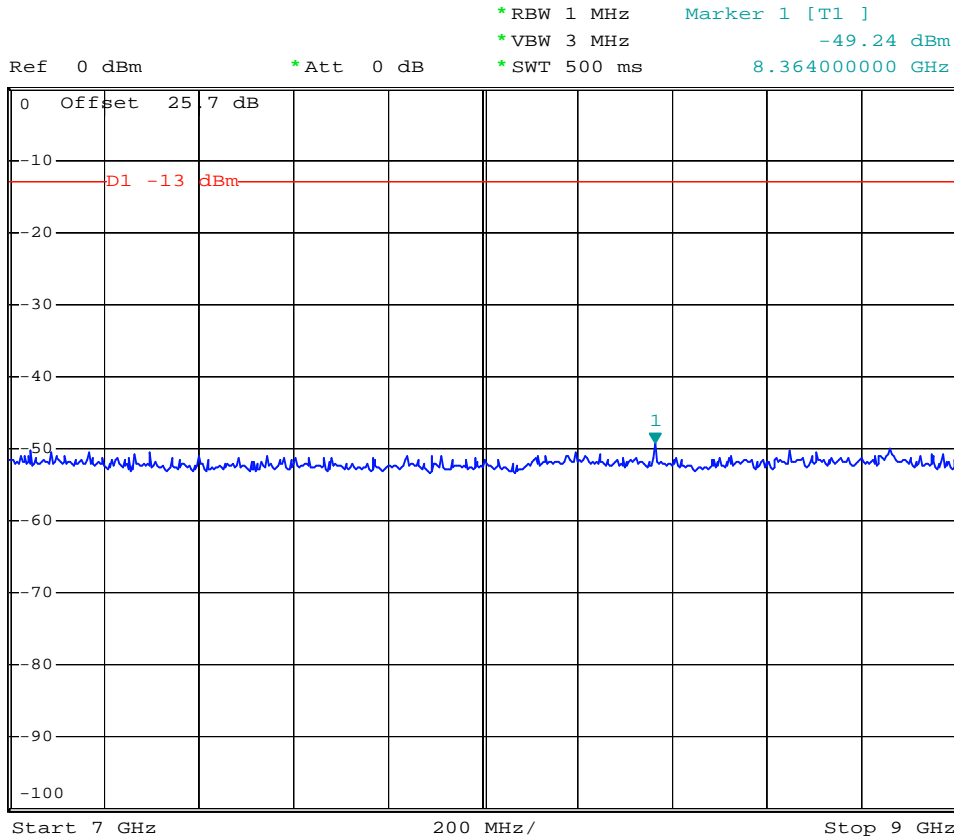

Date: 9.AUG.2008 01:04:37



- Mode 2
- Test Mode : GSM850 (EDGE) CH189
- Frequency Range : 30M-1G



Ref 35 dBm *Att 30 dB *RBW 1 MHz Marker 2 [T1]
 *VBW 3 MHz -33.33 dBm
 *SWT 500 ms 827.340000000 MHz

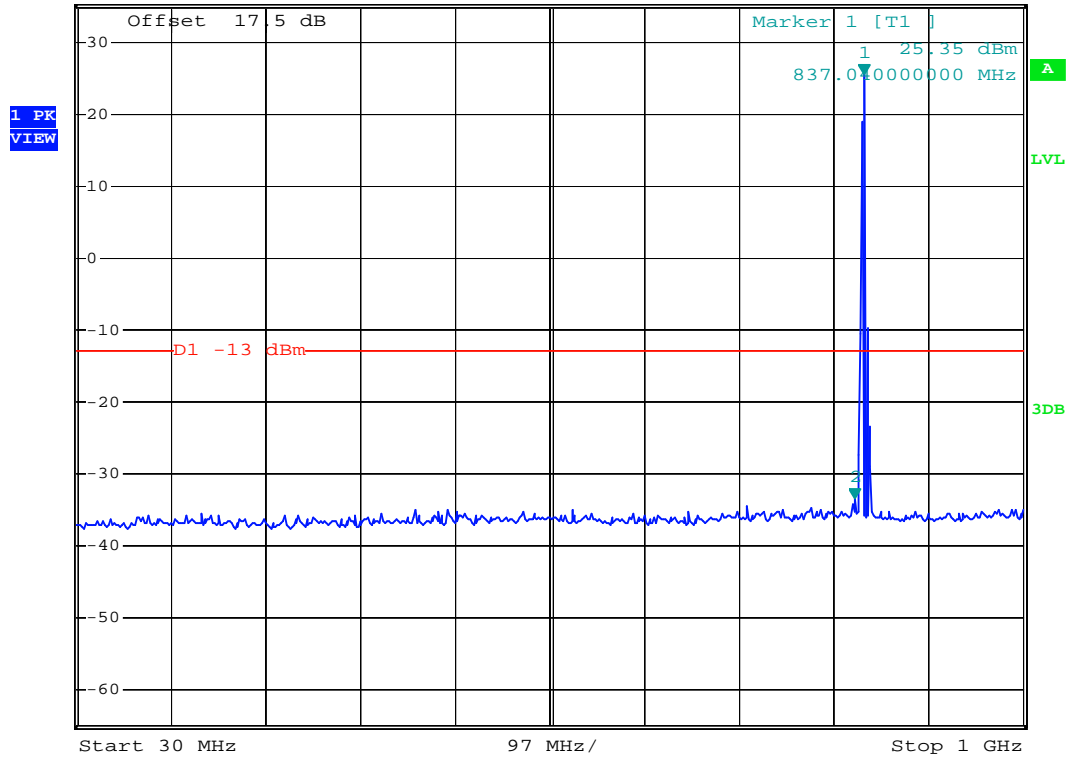

Date: 9.AUG.2008 01:14:26



- Test Mode : GSM850 (EDGE) CH189
- Frequency Range : 1G-3G

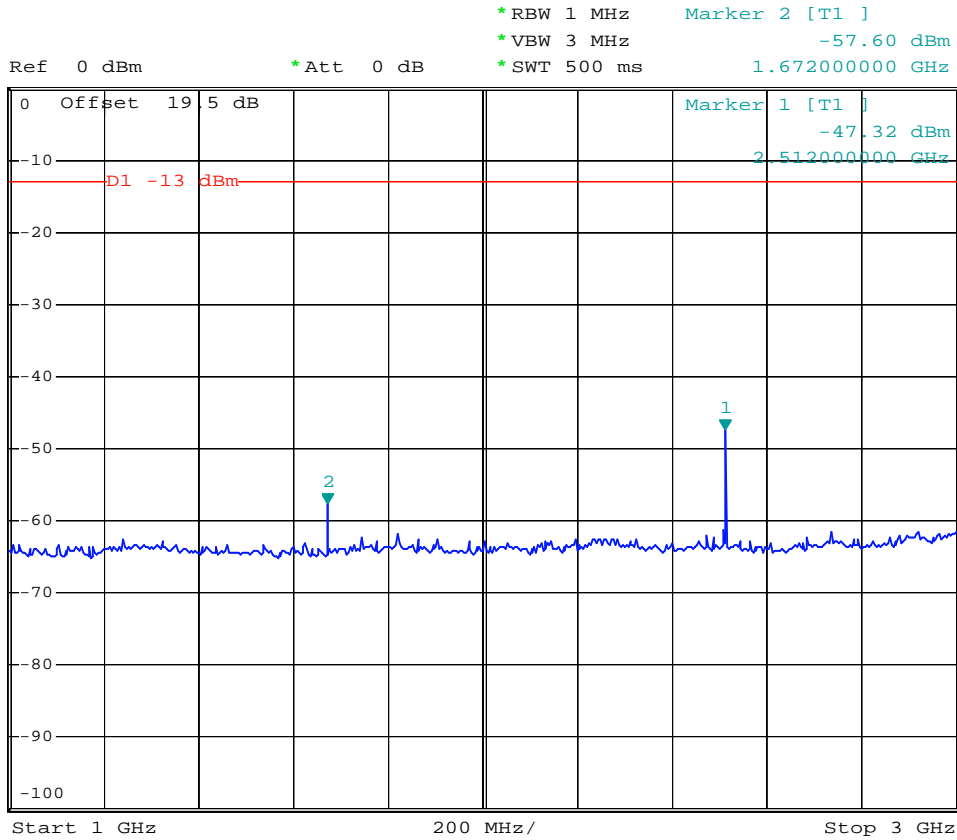

Date: 9.AUG.2008 01:11:49



- Test Mode : GSM850 (EDGE) CH189
- Frequency Range : 3G-7G

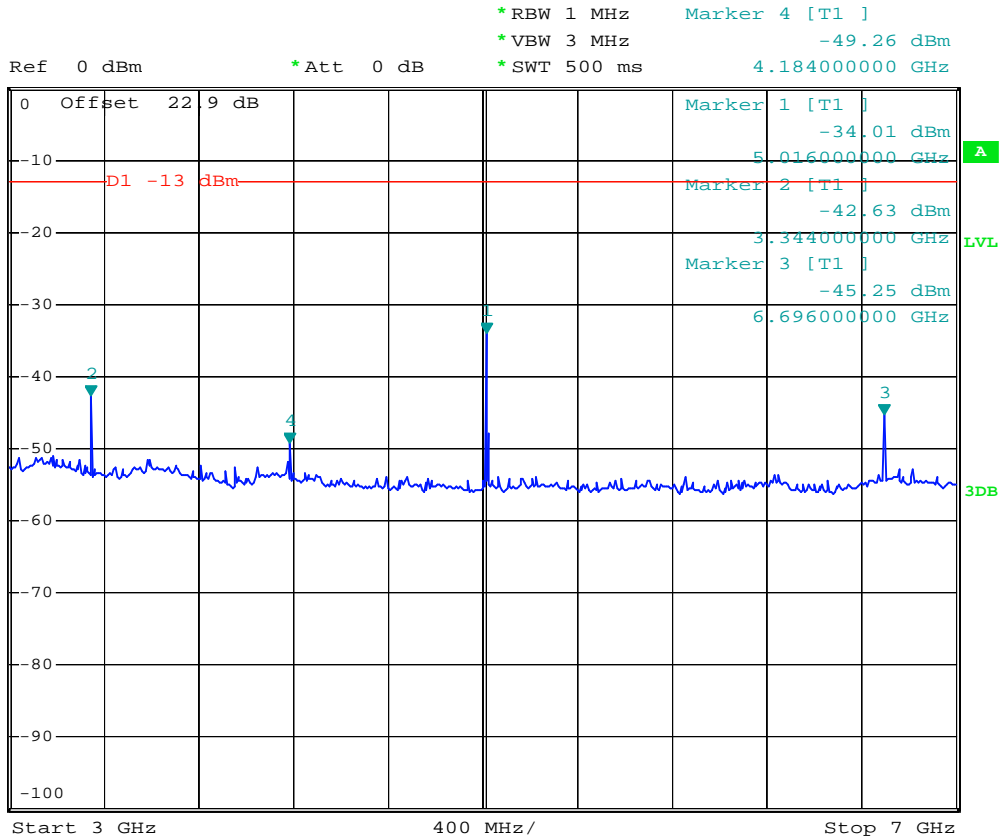

Date: 9.AUG.2008 01:10:54



- Test Mode : GSM850 (EDGE) CH189
- Frequency Range : 7G-9G

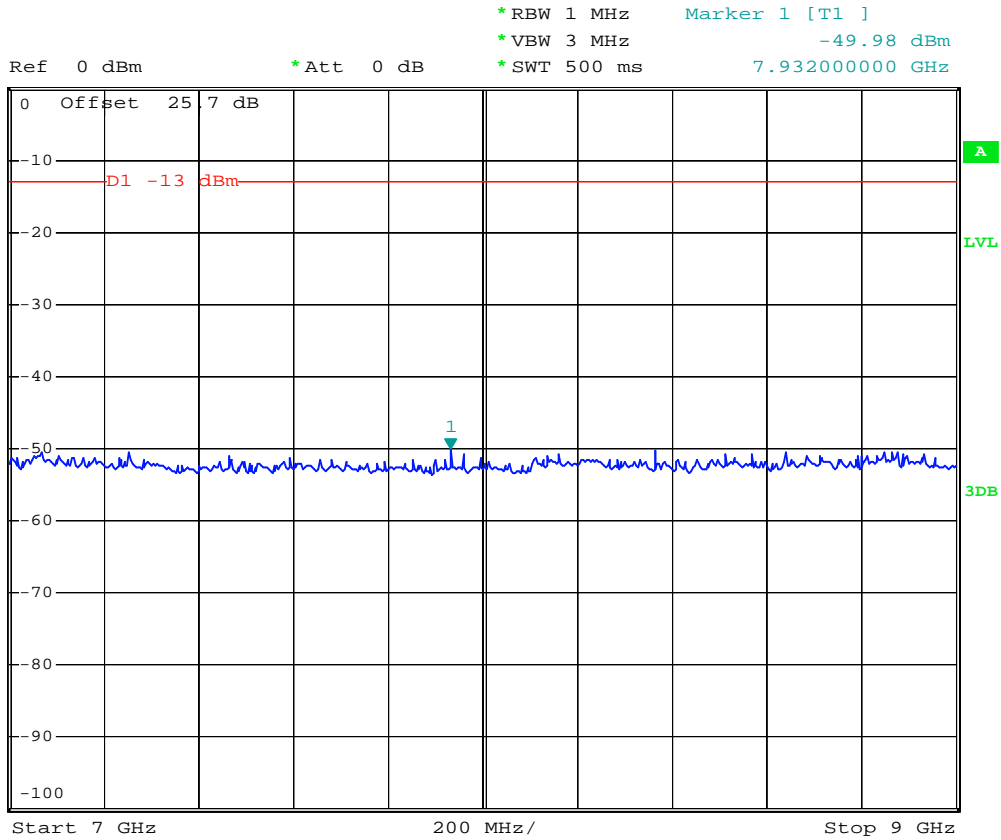

Date: 9.AUG.2008 01:09:58



- Mode 3
- Test Mode : GSM1900 (GPRS) CH661
- Frequency Range : 30M-1G

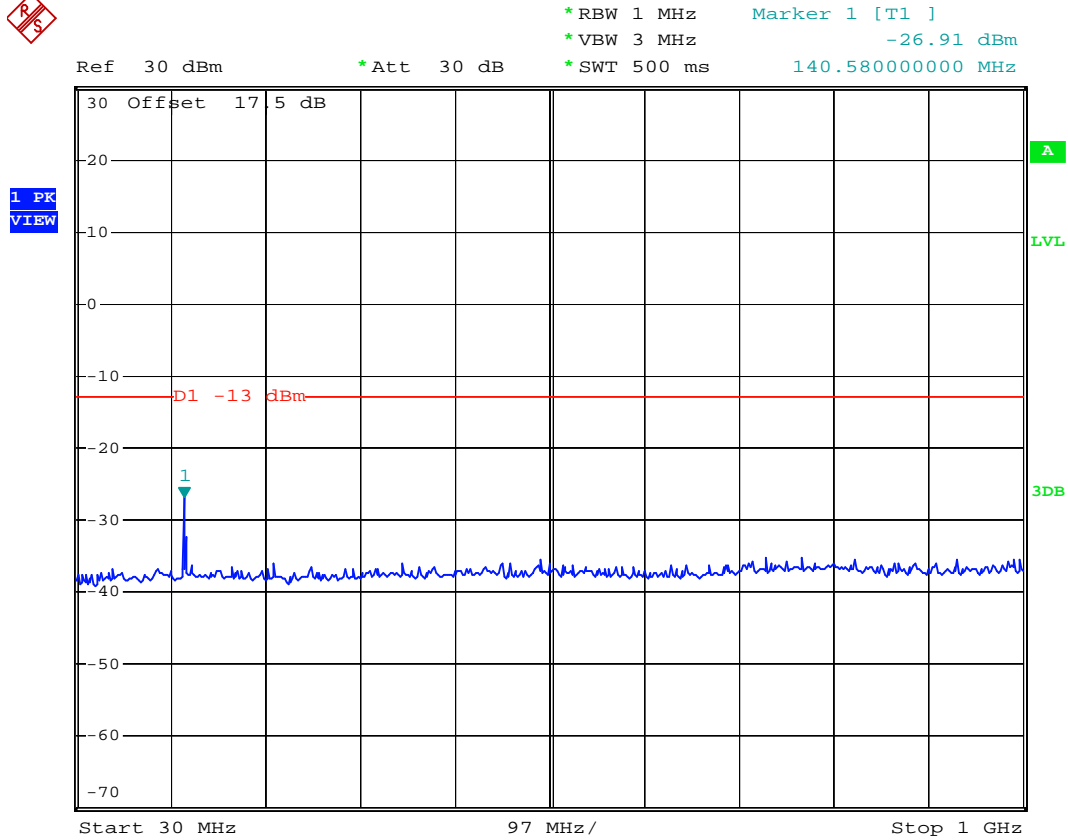

Date: 9.AUG.2008 02:05:15



- Test Mode : GSM1900 (GPRS) CH661
- Frequency Range : 1G-3G

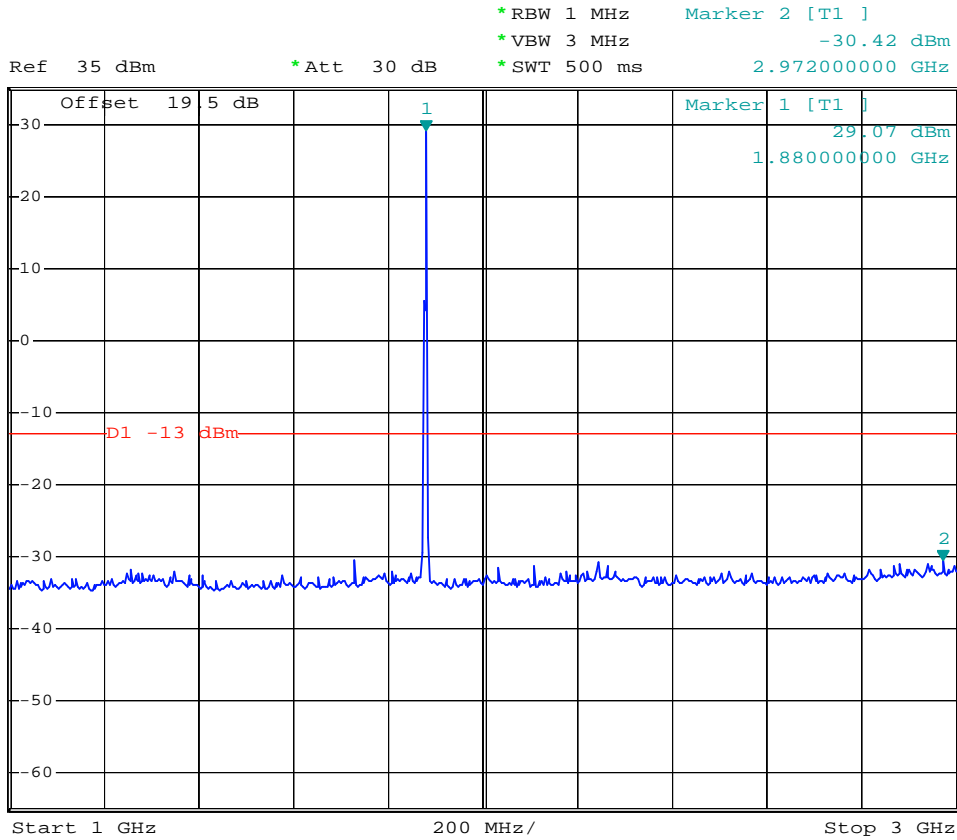

Date: 9.AUG.2008 02:07:17



- Test Mode : GSM1900 (GPRS) CH661
- Frequency Range : 7G-13.6G



Ref 0 dBm *Att 0 dB *RBW 1 MHz Marker 1 [T1]
*VBW 3 MHz -46.25 dBm
*SWT 500 ms 13.600000000 GHz

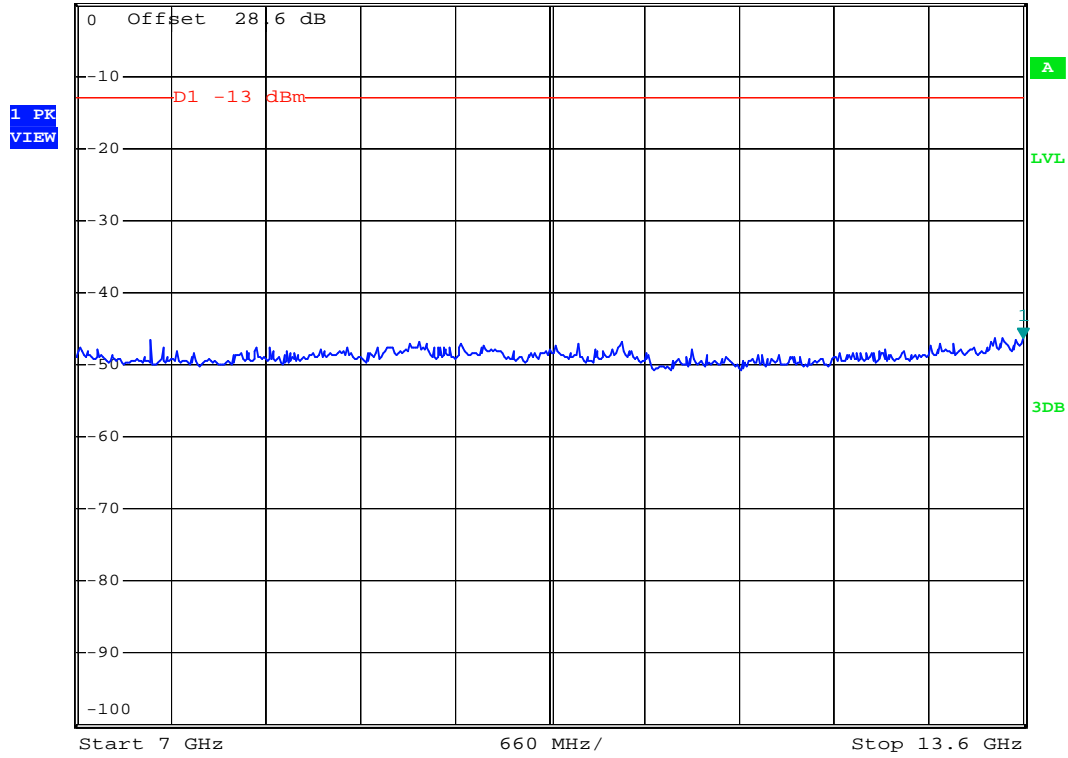

Date: 9.AUG.2008 02:09:08



- Test Mode : GSM1900 (GPRS) CH661
- Frequency Range : 13.6G-19.1G

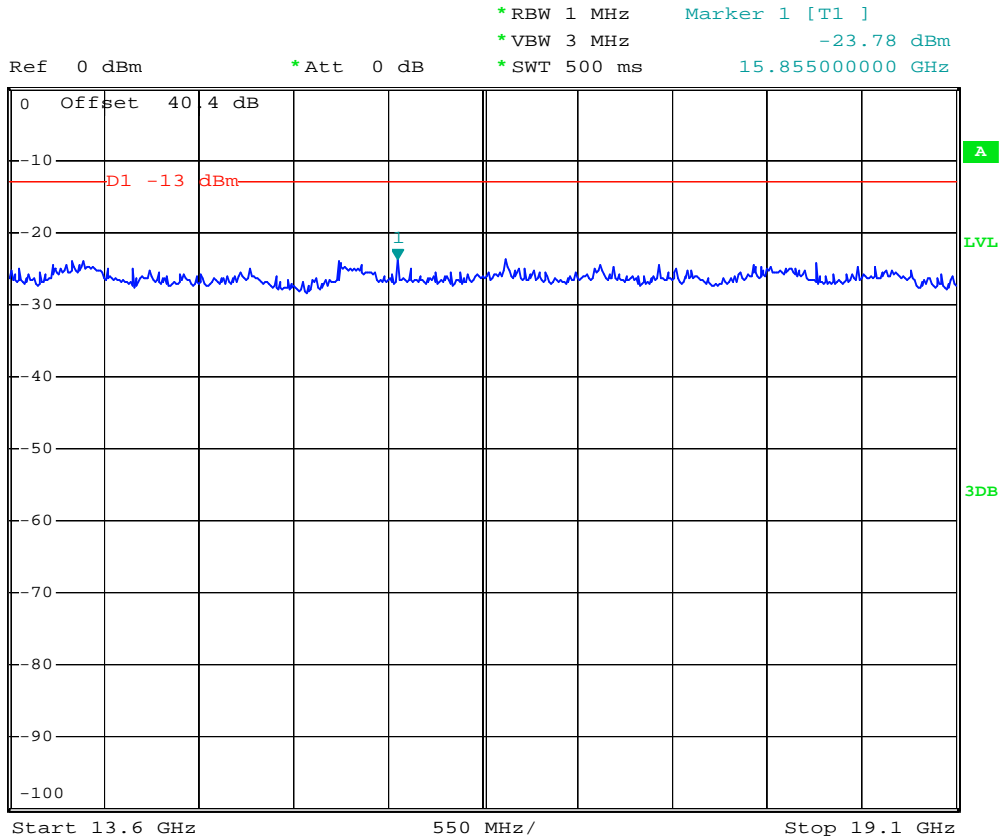

Date: 9.AUG.2008 02:09:38



- Mode 4
- Test Mode : GSM1900 (EDGE) CH661
- Frequency Range : 30M-1G



*RBW 1 MHz Marker 1 [T1]
 *VBW 3 MHz -34.68 dBm
 *SWT 500 ms 140.58000000 MHz

Ref 30 dBm

*Att 30 dB

1 PK
VIEW

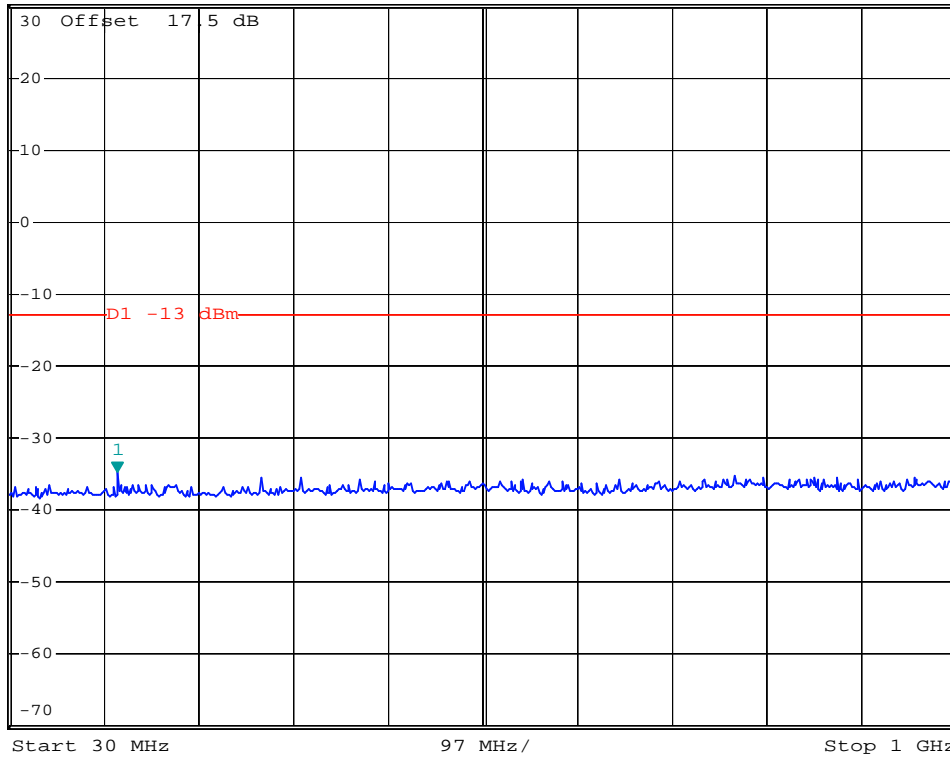

Date: 9.AUG.2008 02:21:17



- Test Mode : GSM1900 (EDGE) CH661
- Frequency Range : 1G-3G

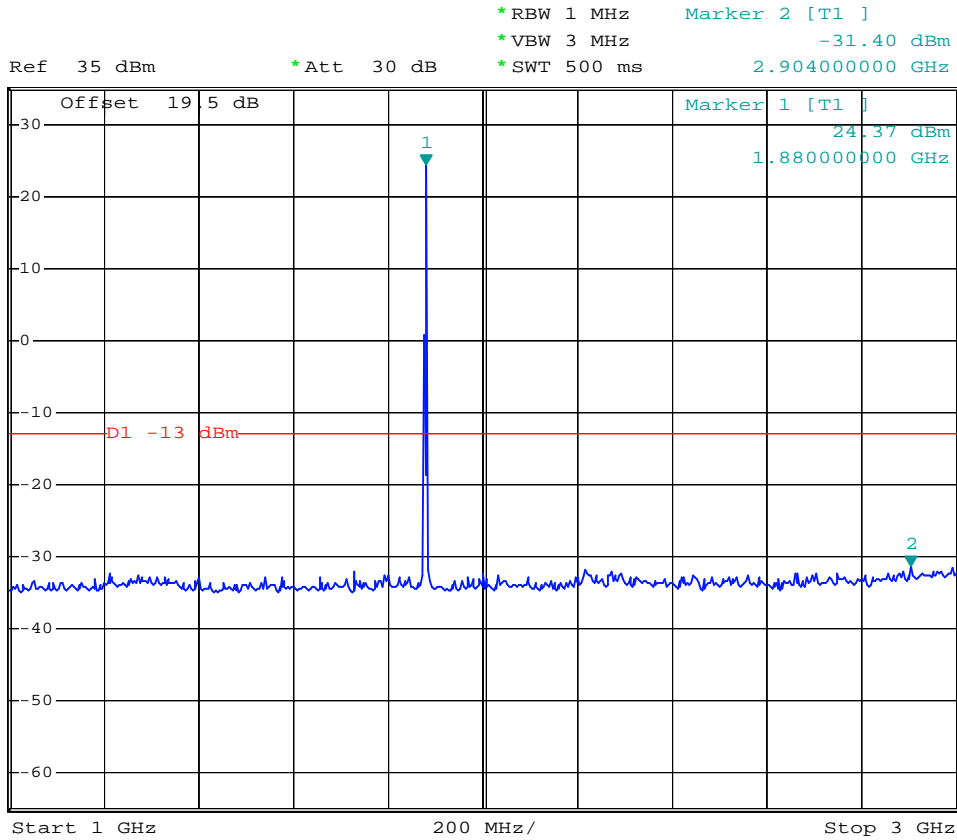

Date: 9.AUG.2008 02:20:26



- Test Mode : GSM1900 (EDGE) CH661
- Frequency Range : 3G-7G

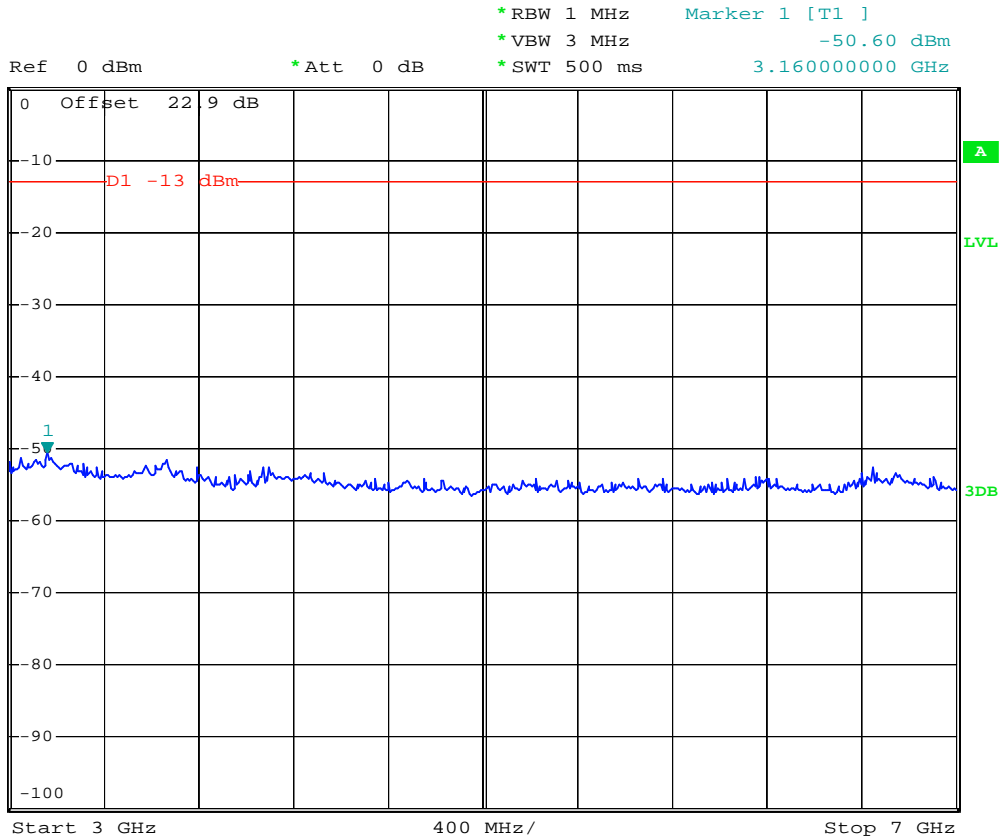

Date: 9.AUG.2008 02:16:01



- Test Mode : GSM1900 (EDGE) CH661
- Frequency Range : 7G-13.6G



*RBW 1 MHz Marker 1 [T1]
 *VBW 3 MHz -45.73 dBm
 *SWT 500 ms 13.534000000 GHz

Ref 0 dBm

*Att 0 dB

1 PK
VIEW

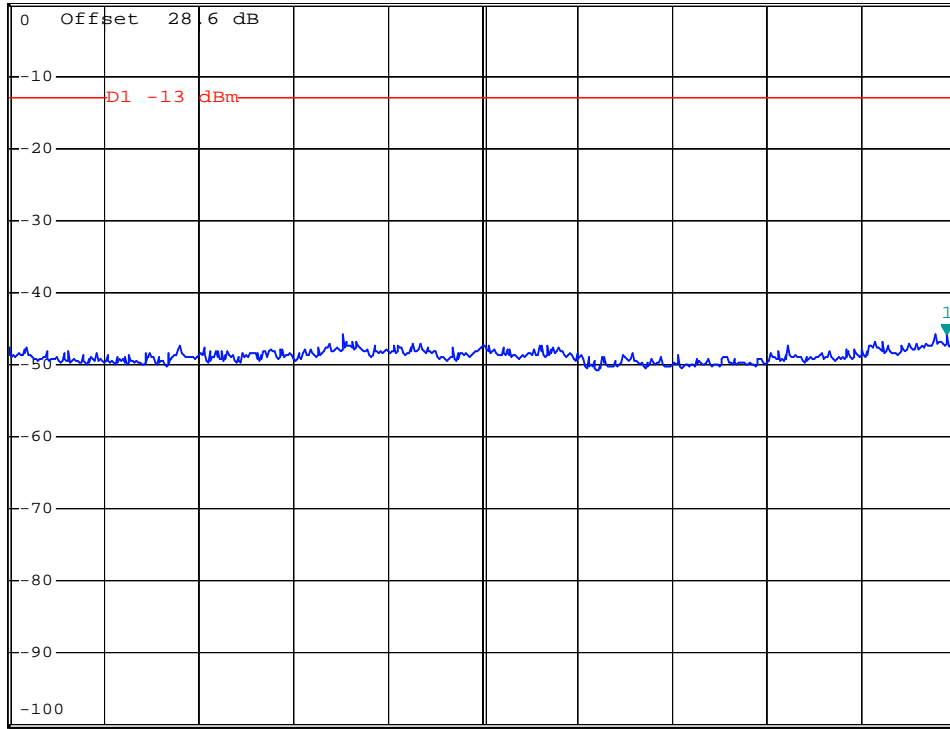

Start 7 GHz

660 MHz/

Stop 13.6 GHz

Date: 9.AUG.2008 02:15:23



- Test Mode : GSM1900 (EDGE) CH661
- Frequency Range : 13.6G-19.1G

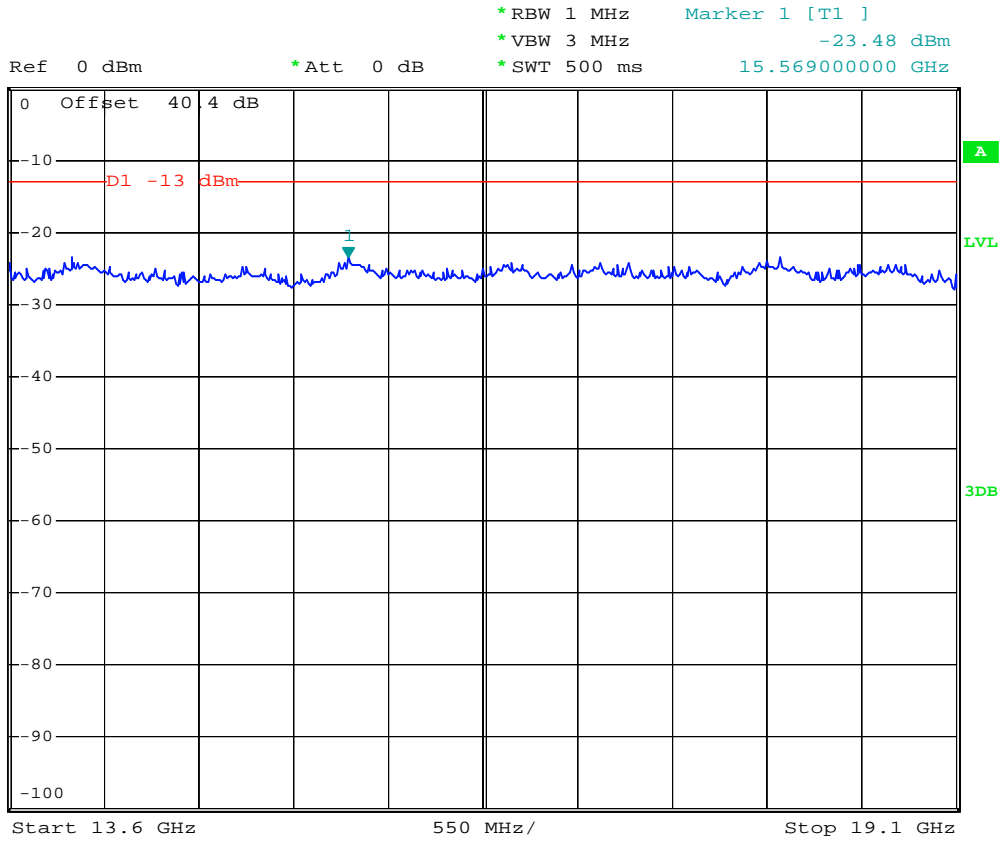

Date: 9.AUG.2008 02:14:24



- Mode 5
- Test Mode : WCDMA Band V CH4182
- Frequency Range : 30M-1G

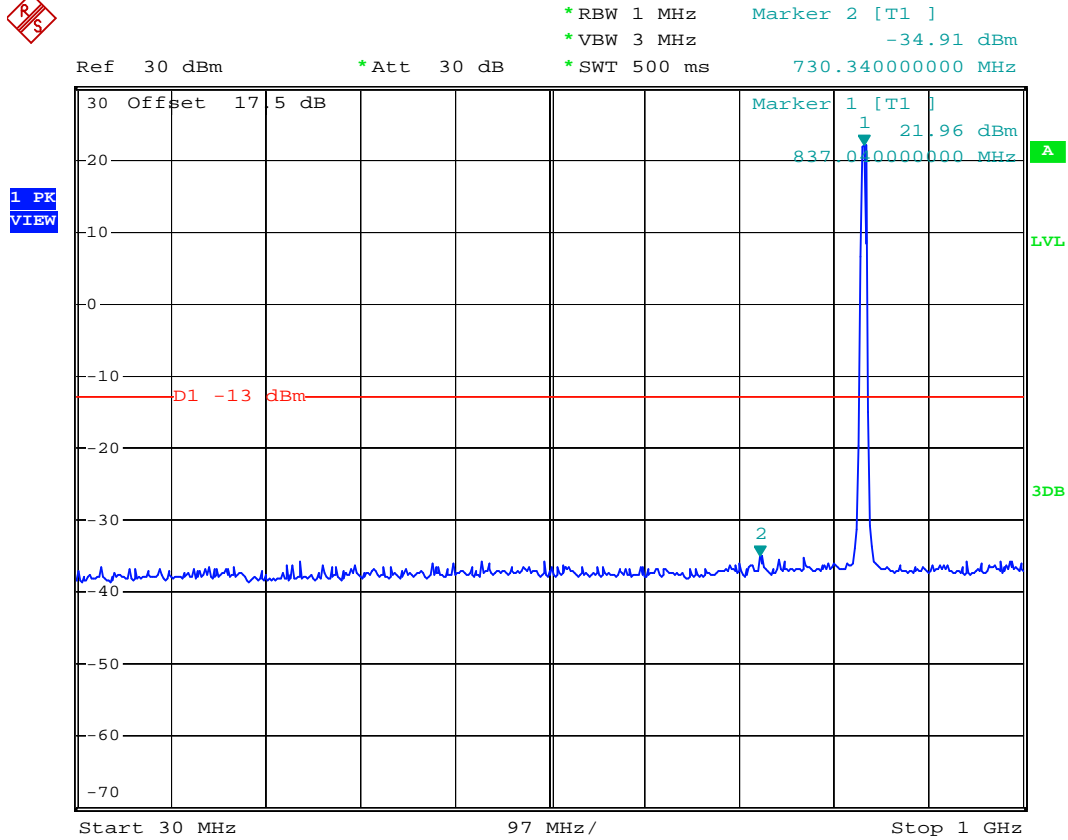

Date: 9.AUG.2008 03:59:56



- Test Mode : WCDMA Band V CH4182
- Frequency Range : 1G-3G



Ref 0 dBm *Att 0 dB *RBW 1 MHz Marker 2 [T1]
 *VBW 3 MHz -59.96 dBm
 *SWT 500 ms 2.512000000 GHz

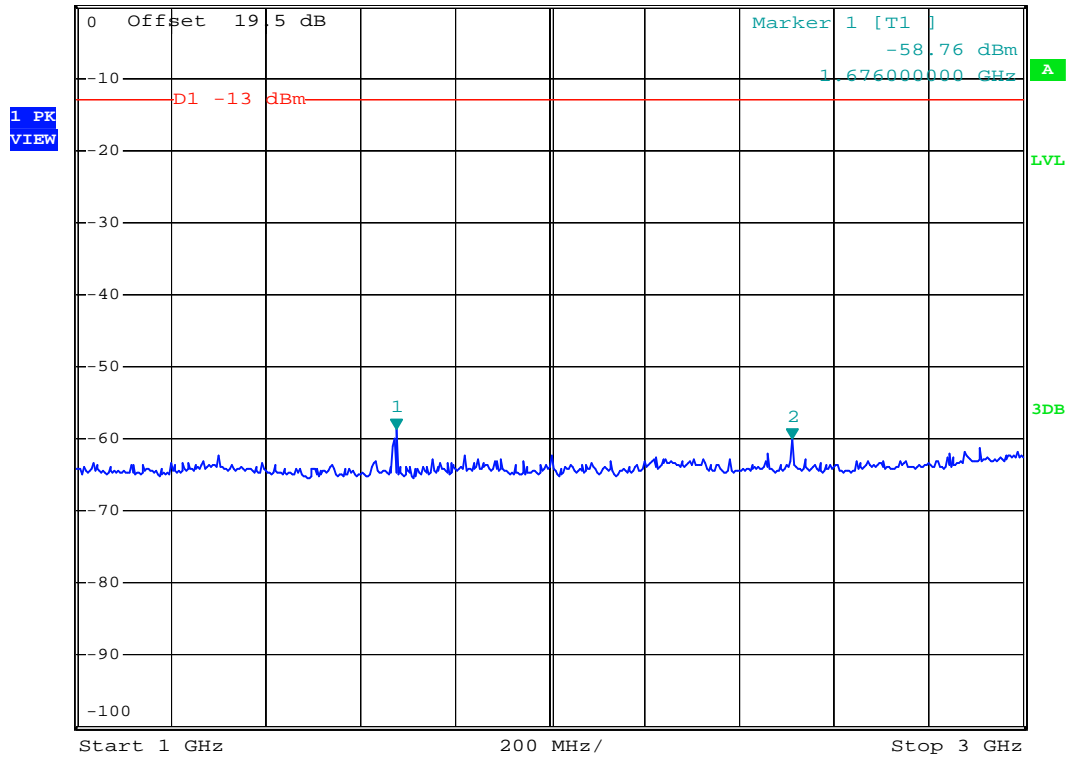

Date: 9.AUG.2008 04:01:05



- Test Mode : WCDMA Band V CH4182
- Frequency Range : 3G-7G

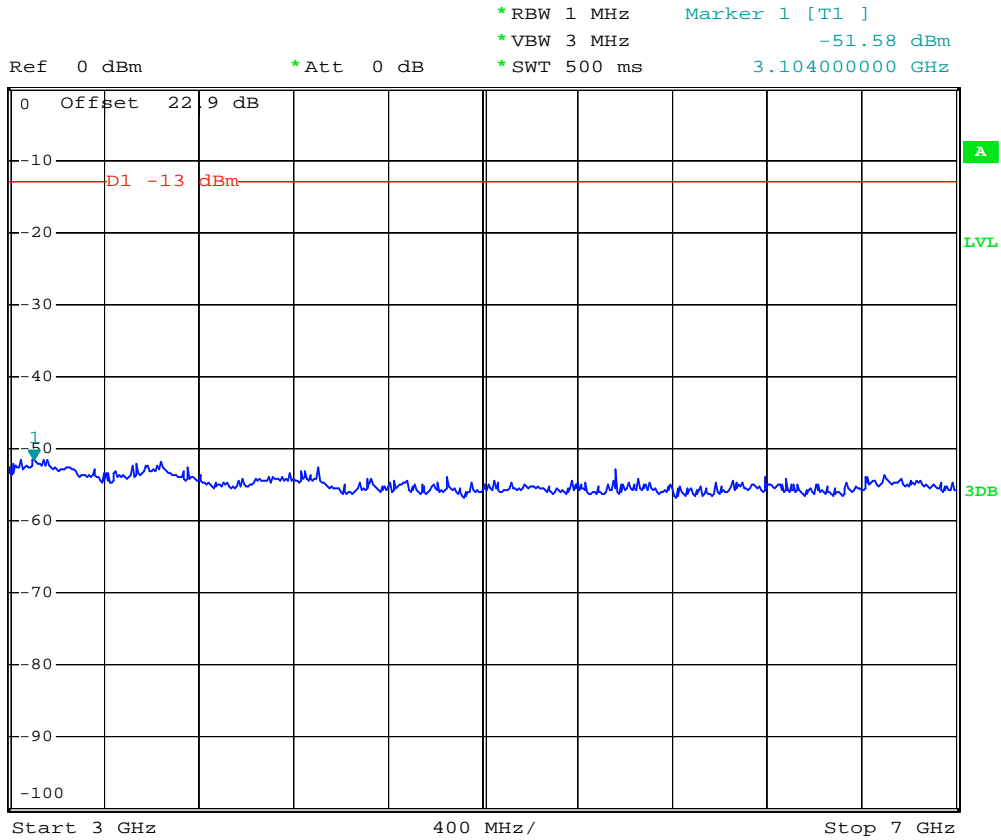

Date: 9.AUG.2008 04:01:43



- Test Mode : WCDMA Band V CH4182
- Frequency Range : 7G-9G

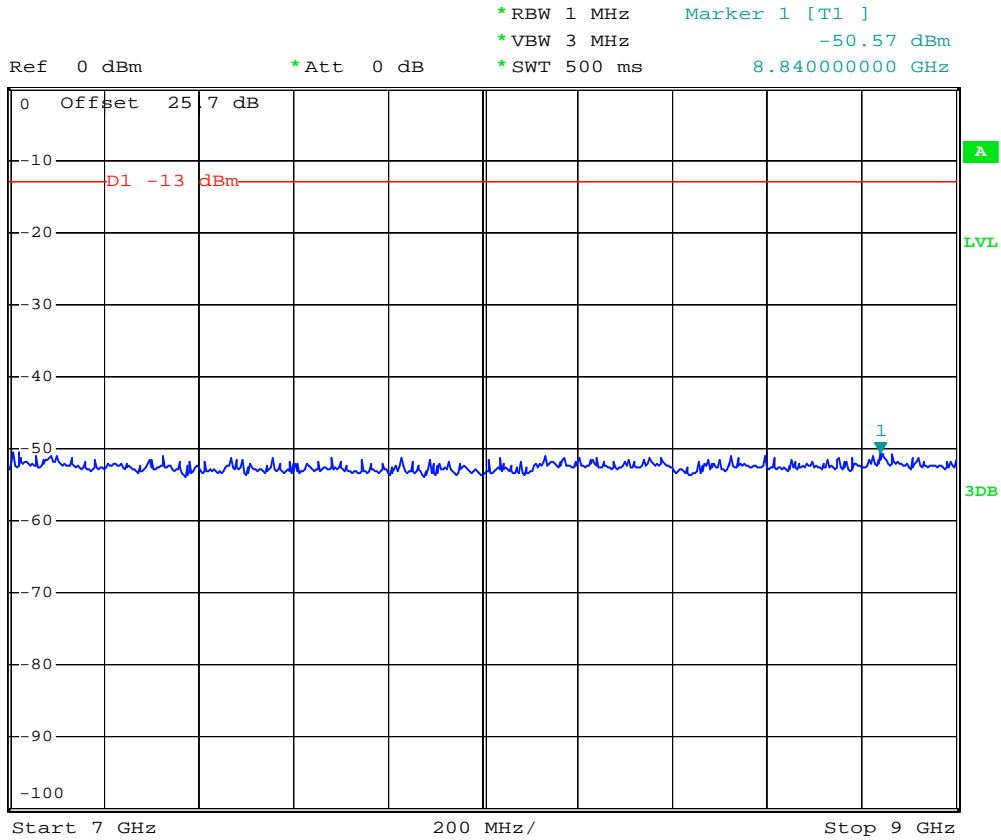

Date: 9.AUG.2008 04:02:12



- Mode 6
- Test Mode : WCDMA Band V (HSUPA) CH4182
- Frequency Range : 30M-1G

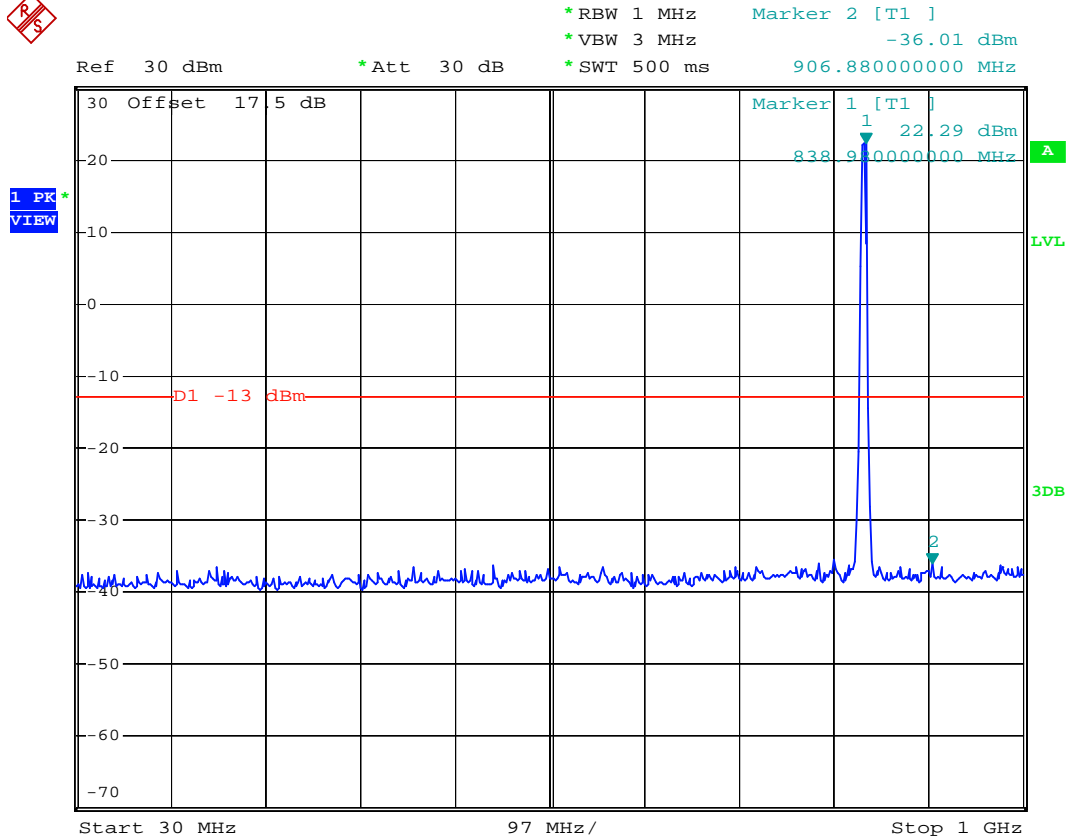

Date: 10.AUG.2008 01:42:29



- Test Mode : WCDMA Band V (HSUPA) CH4182
- Frequency Range : 1G-3G



Ref 0 dBm *Att 0 dB *RBW 1 MHz Marker 1 [T1]
 *VBW 3 MHz -58.01 dBm
 *SWT 500 ms 1.676000000 GHz

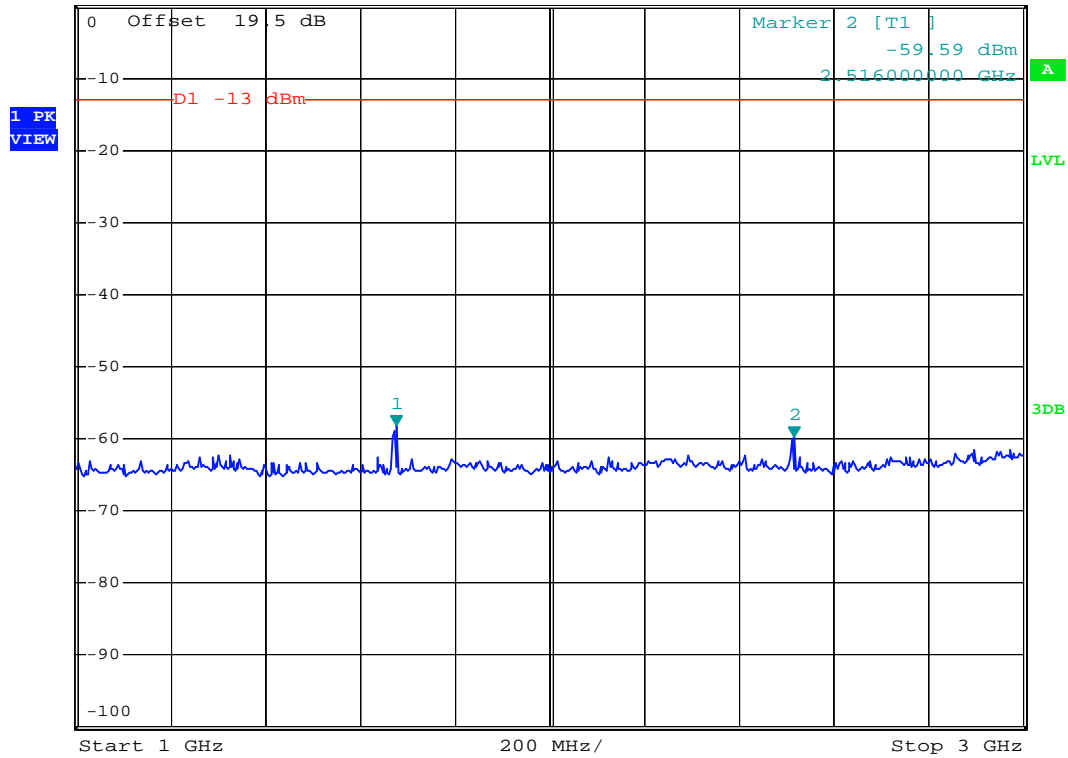

Date: 10.AUG.2008 01:43:59



- Test Mode : WCDMA Band V (HSUPA) CH4182
- Frequency Range : 3G-7G

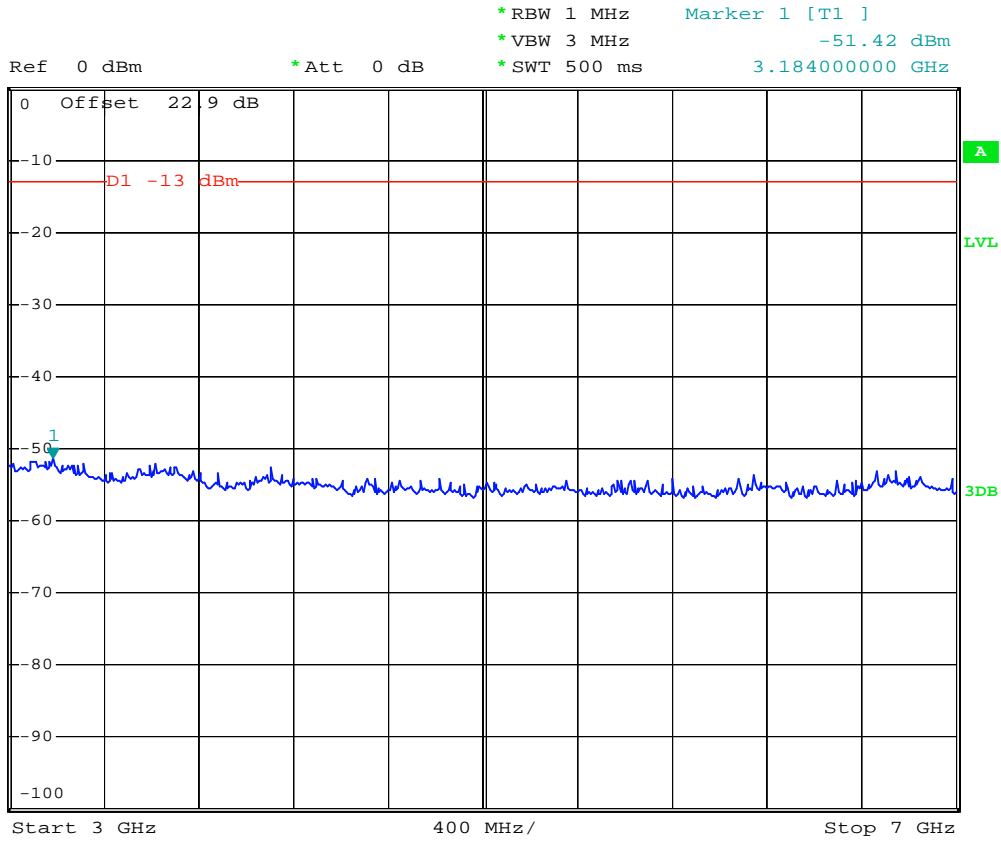

Date: 10.AUG.2008 01:44:23



- Test Mode : WCDMA Band V (HSUPA) CH4182
- Frequency Range : 7G-9G



Ref 0 dBm *Att 0 dB *RBW 1 MHz Marker 1 [T1]
*VBW 3 MHz -50.07 dBm
*SWT 500 ms 8.504000000 GHz

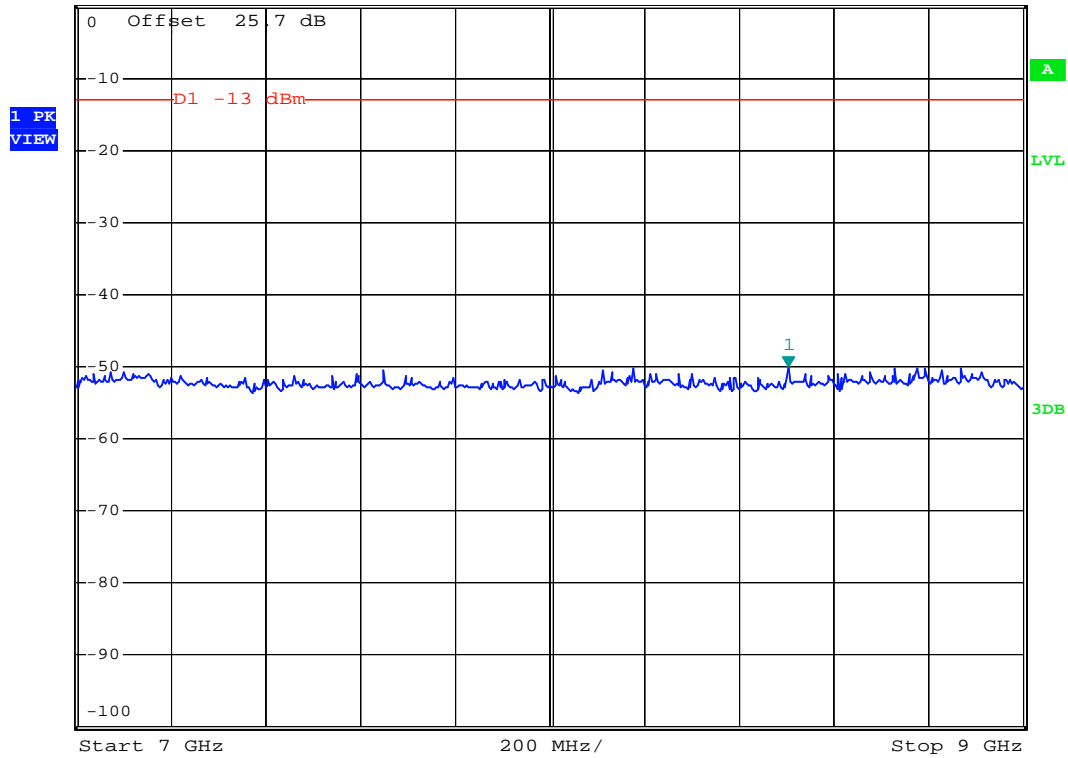

Date: 10.AUG.2008 01:44:49



- Mode 7
- Test Mode : WCDMA Band II CH9400
- Frequency Range : 30M-1G

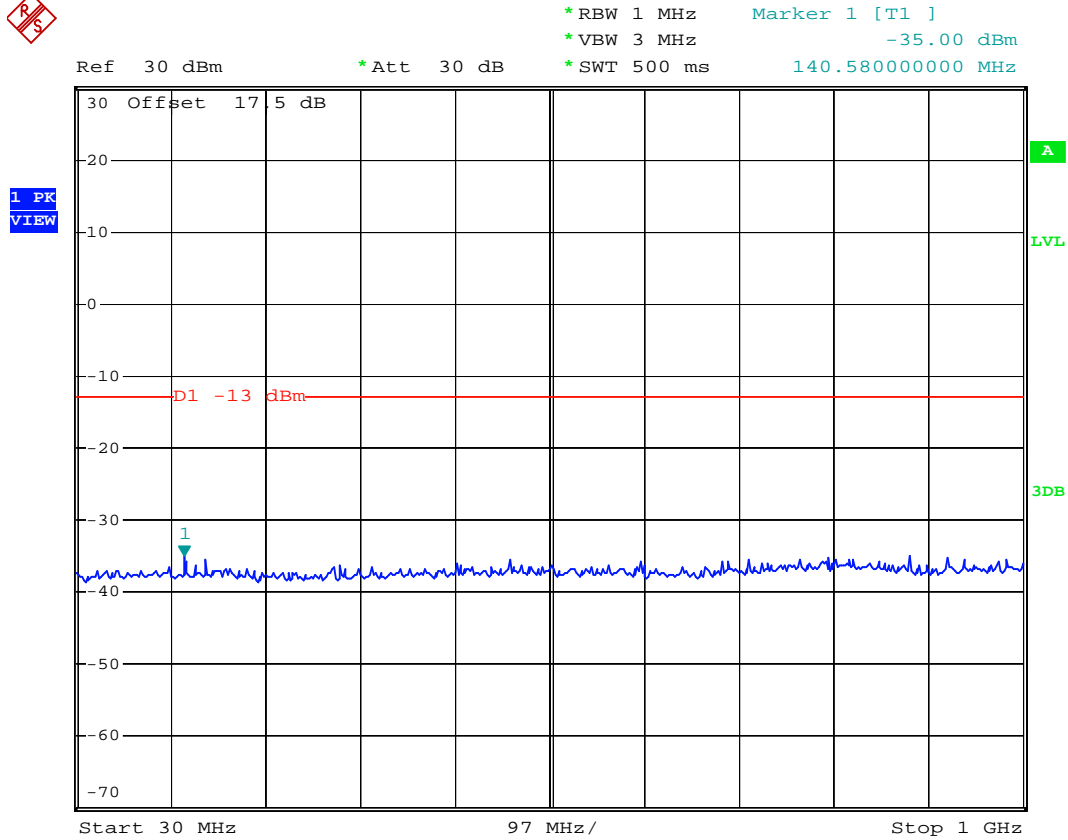

Date: 9.AUG.2008 04:12:33



- Test Mode : WCDMA Band II CH9400
- Frequency Range : 1G-3G

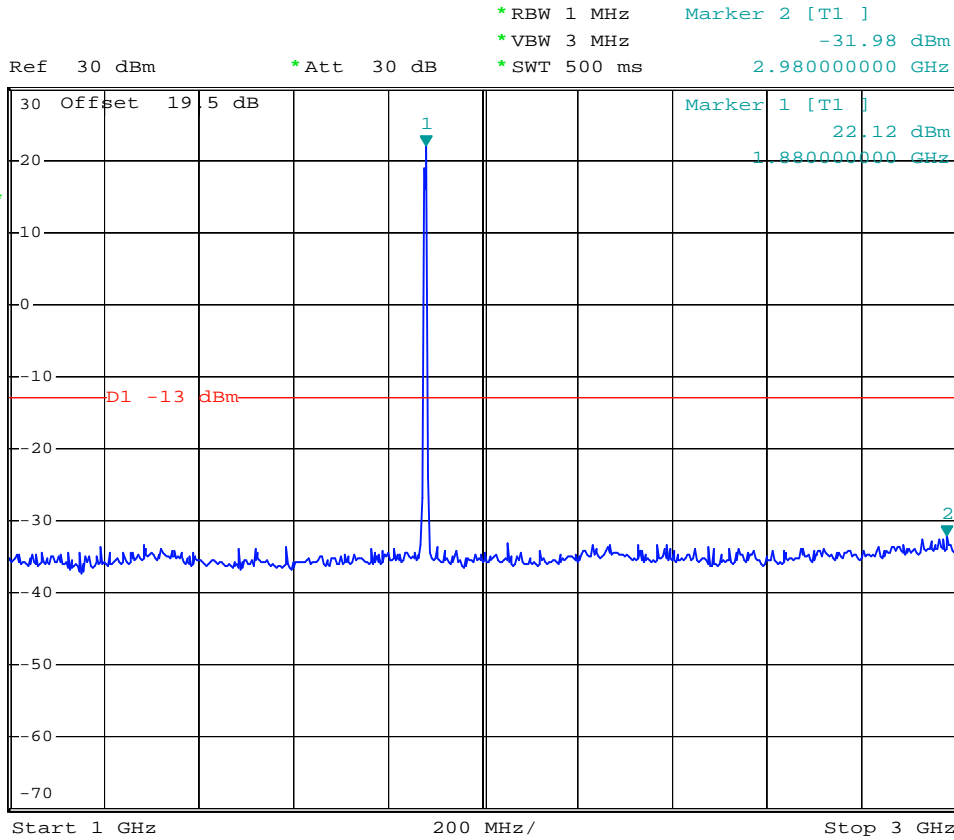

Date: 9.AUG.2008 04:10:50



- Test Mode : WCDMA Band II CH9400
- Frequency Range : 3G-7G

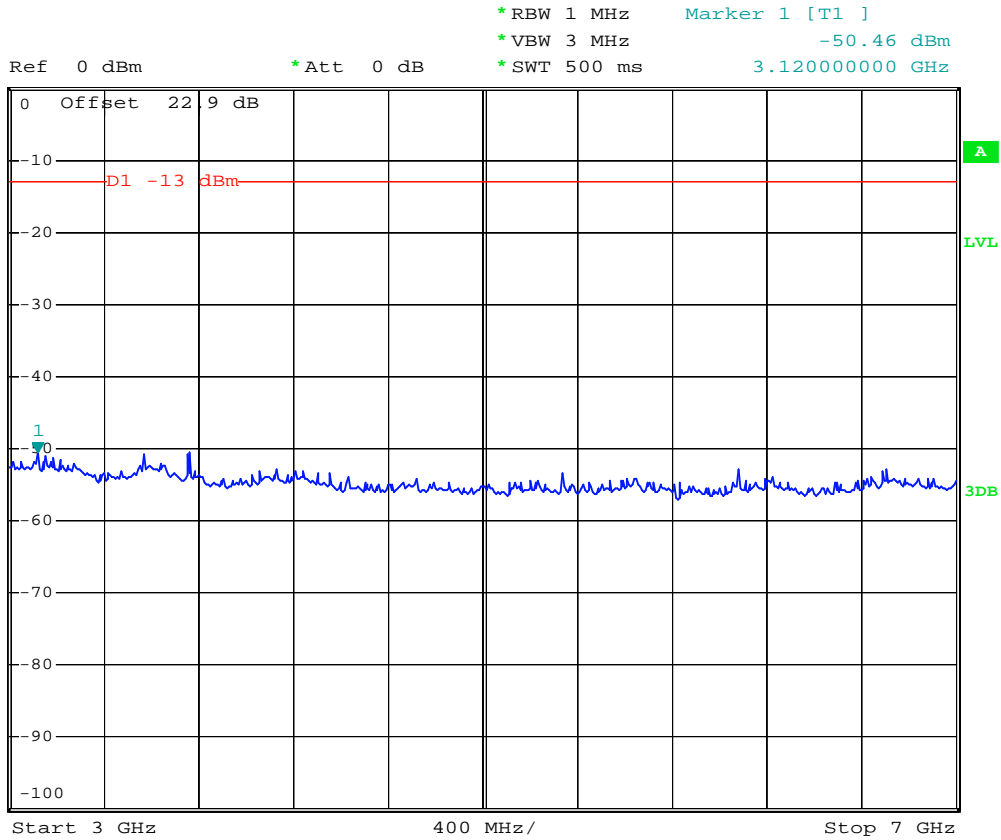

Date: 9.AUG.2008 04:08:04



- Test Mode : WCDMA Band II CH9400
- Frequency Range : 7G-13.6G

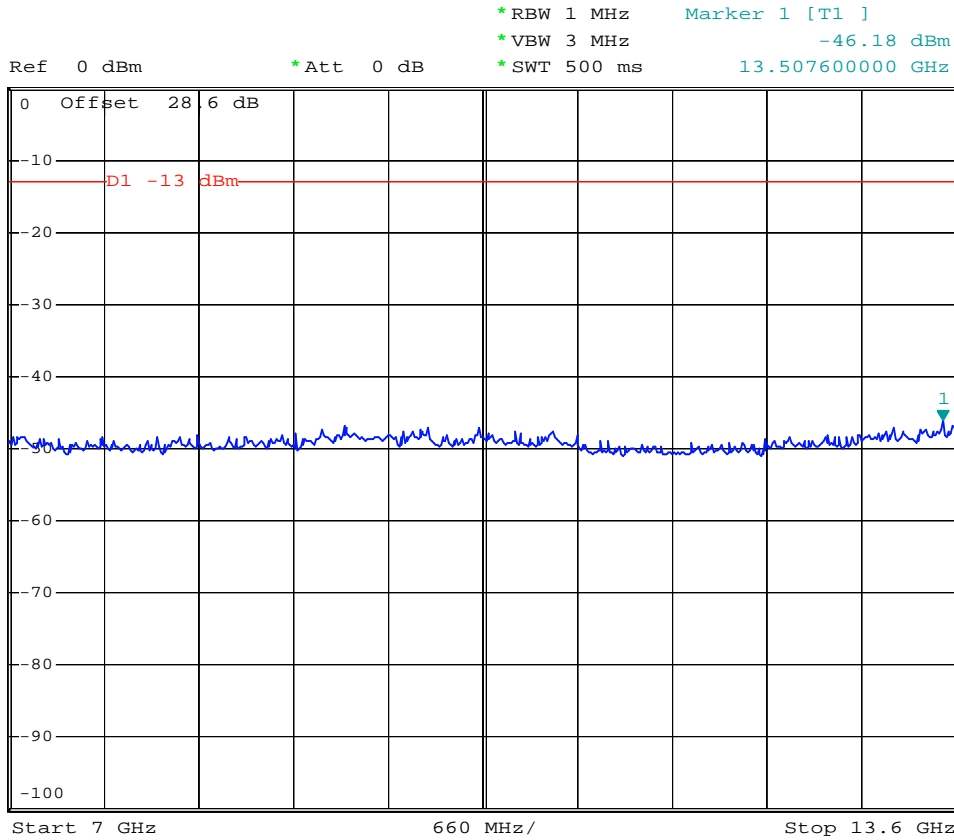

Date: 9.AUG.2008 04:07:15



- Test Mode : WCDMA Band II CH9400
- Frequency Range : 13.6G-19.1G

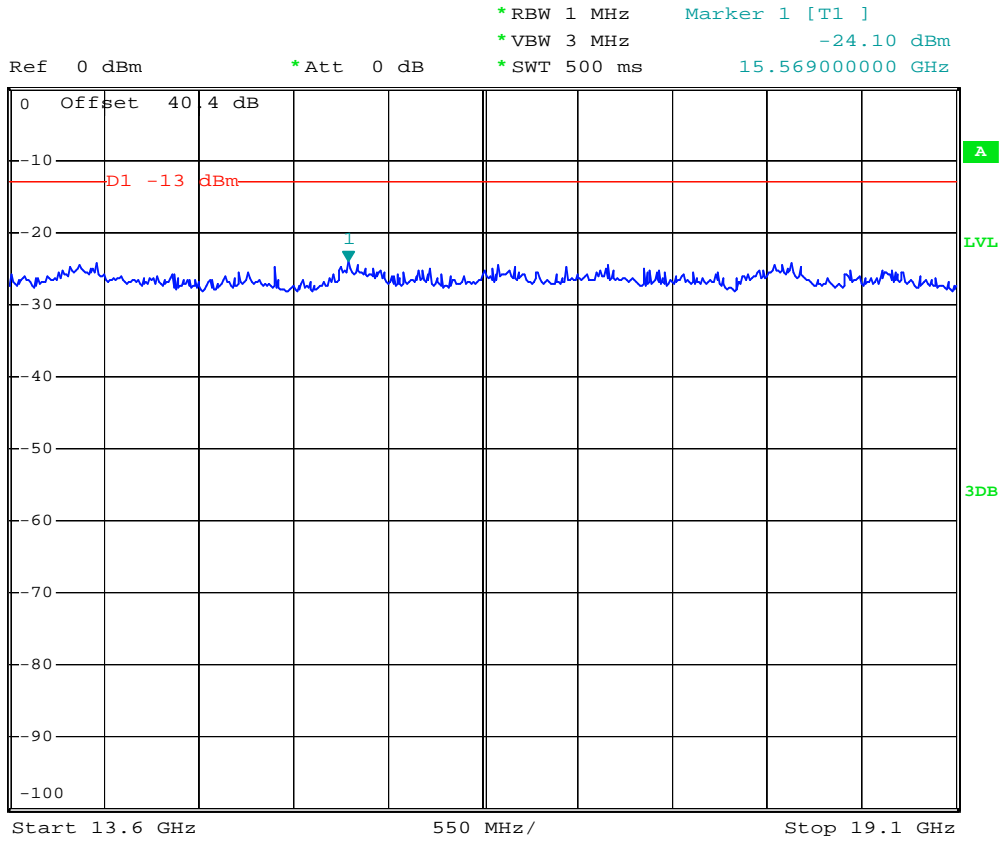

Date: 9.AUG.2008 04:05:55



- Mode 8
- Test Mode : WCDMA Band II (HSUPA) CH9400
- Frequency Range : 30M-1G

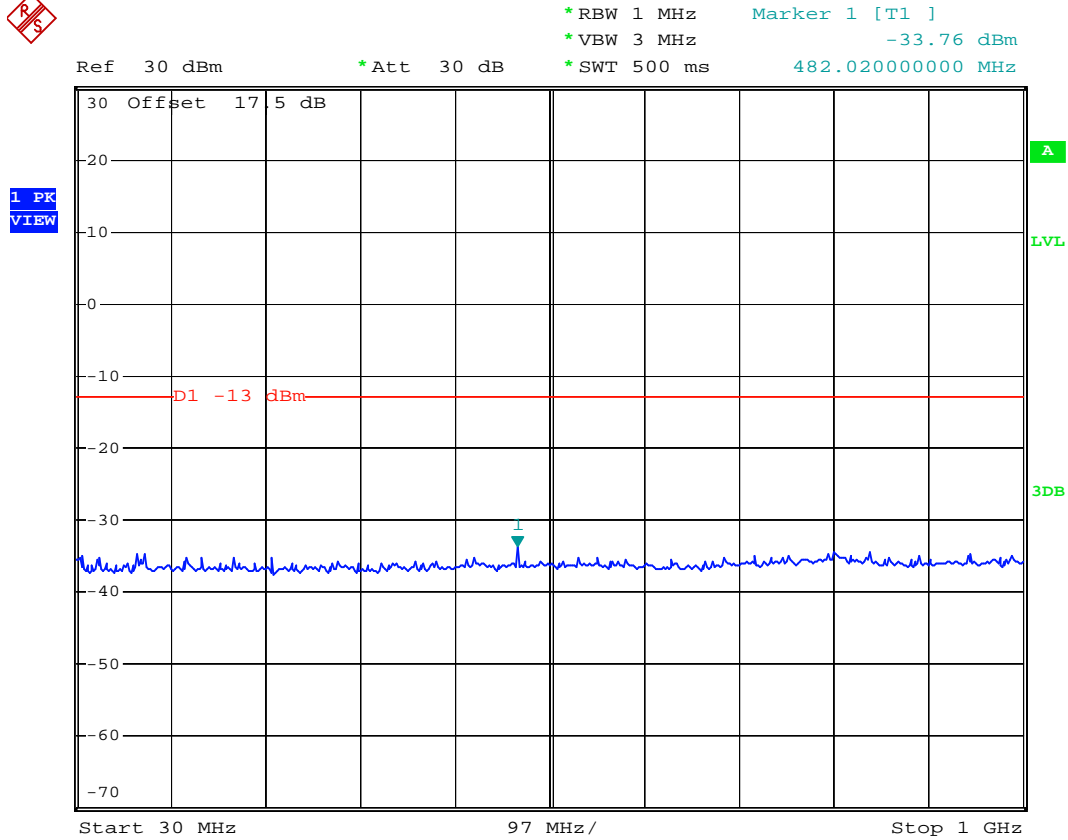

Date: 10.AUG.2008 01:58:02



- Test Mode : WCDMA Band II (HSUPA) CH9400
- Frequency Range : 1G-3G



Ref 30 dBm *Att 30 dB *RBW 1 MHz Marker 2 [T1]
 *VBW 3 MHz -32.21 dBm
 *SWT 500 ms 1.276000000 GHz

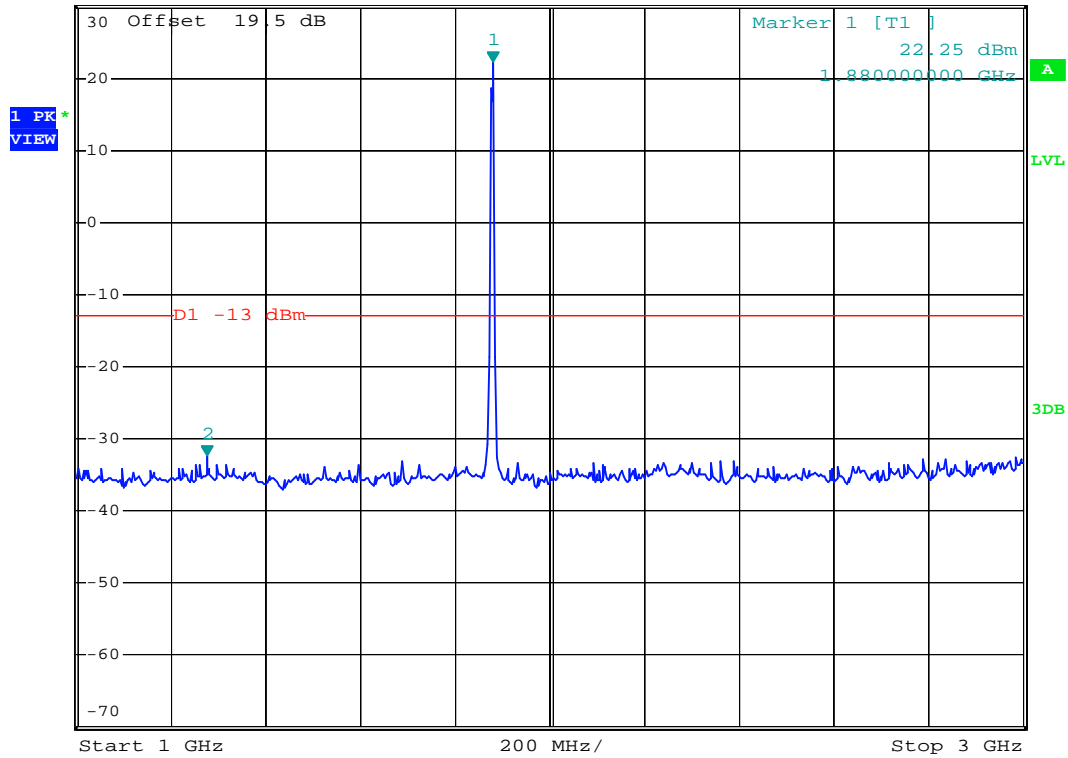

Date: 10.AUG.2008 01:51:37



- Test Mode : WCDMA Band II (HSUPA) CH9400
- Frequency Range : 3G-7G

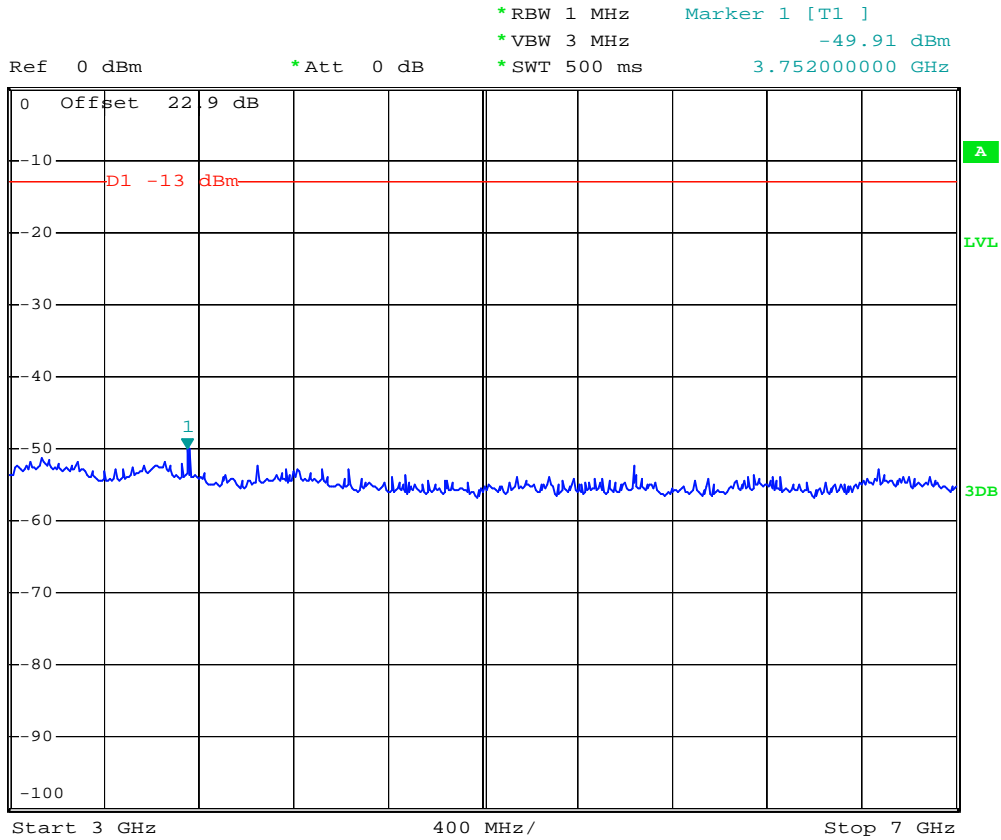

Date: 10.AUG.2008 01:48:28



- Test Mode : WCDMA Band II (HSUPA) CH9400
- Frequency Range : 7G-13.6G



Ref 0 dBm *Att 0 dB *RBW 1 MHz Marker 1 [T1]
*VBW 3 MHz -47.00 dBm
*SWT 500 ms 13.534000000 GHz

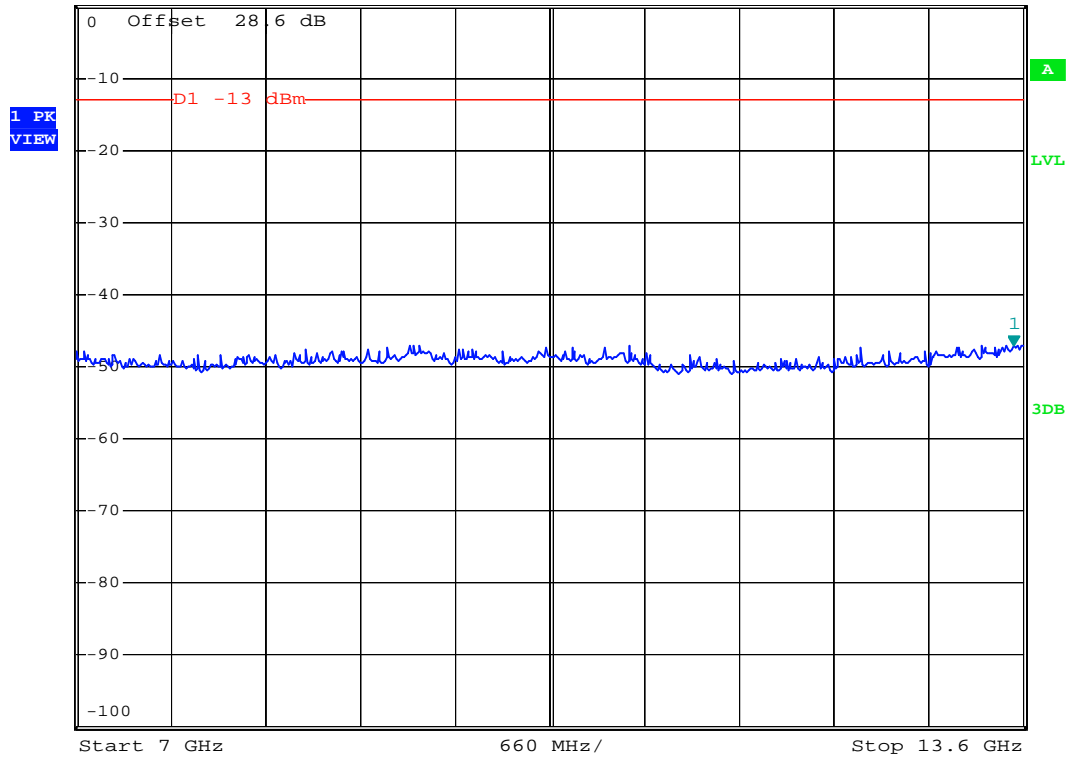

Date: 10.AUG.2008 01:48:00



4.6 Field Strength of Spurious Radiation

Equivalent isotropic radiated Power Measurements by substitution method according to ANSI/TIA/EIA-603-C.

4.6.1 Measurement Instruments

As described in chapter 5 of this test report.

4.6.2 Test Procedure

- a. The EUT was placed on a rotatable wooden table with 0.8 meter about ground.
- b. The EUT was set 3 meters from the receiving antenna which was mounted on the antenna tower.
- c. The table was rotated 360 degrees to determine the position of the highest spurious emission.
- d. The height of the receiving antenna is varied between one meter and four meters to reach the maximum spurious emission for both horizontal and vertical polarizations.
- e. Taking the record of maximum spurious emission.
- f. A Horn antenna was substituted in place of the EUT and was driven by a signal generator.
- g. Tune the output power of signal generator to the same emission level with EUT maximum spurious emission.
- h. Taking the record of output power at antenna port.
- i. Repeat step 7 to step 8 for another polarization.
- j. Emission level (dBm) = output power + substitution Gain.

4.6.3 Test Setup Layout

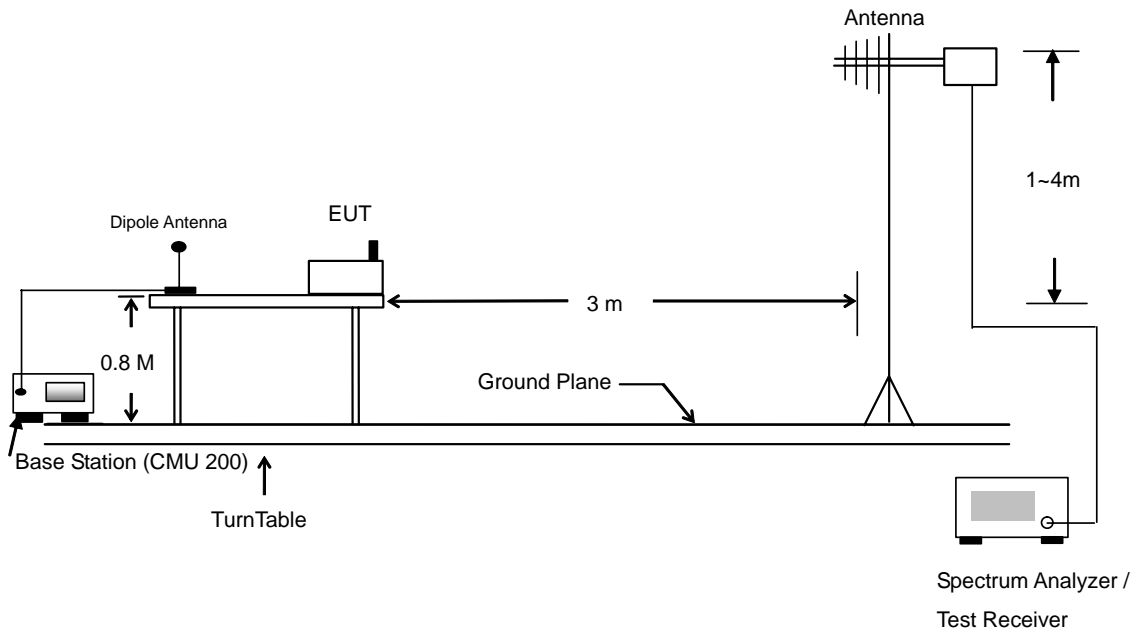



4.6.4 Test Data

- Mode 1
- Horizontal Polarization

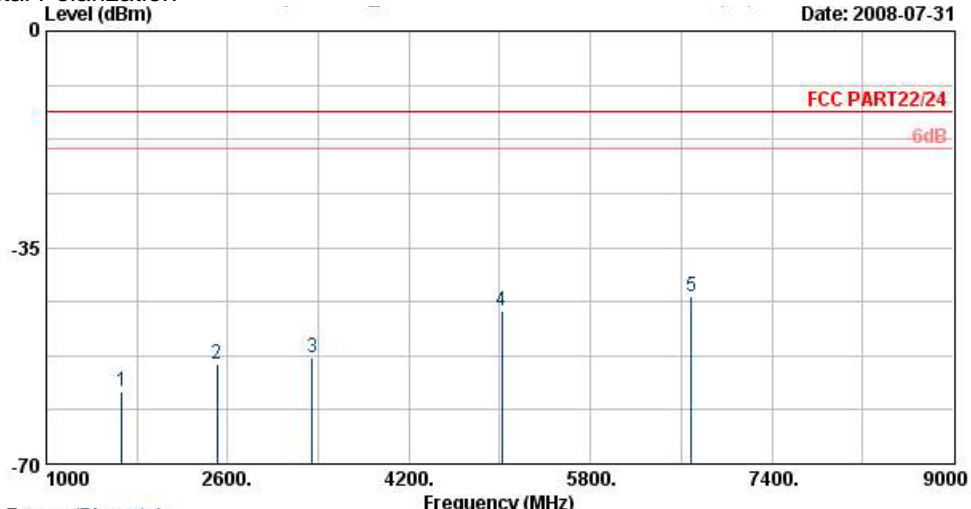

Site : 03CH07-HY
 Condition : HF-EIRP(080306) HORIZONTAL
 EUT : Module
 Power : 3.6Vdc
 Model : FG 863020
 Mode : Model

Frequency (MHz)	ERP (dBm)	Limit (dBm)	Over Limit (dB)	SPA Reading (dBm)	S.G. Power (dBm)	TX Cable loss (dB)	TX Antenna Gain (dBi)	Polarization (H/V)	Result
1669	-58.18	-13	-45.18	-61.64	-57.19	3.39	4.55	H	Pass
2509	-53.86	-13	-40.86	-64.00	-53.92	3.71	5.92	H	Pass
3346	-52.86	-13	-39.86	-63.81	-54.79	3.13	7.21	H	Pass
5015	-45.39	-13	-32.39	-58.53	-49.14	2.61	8.51	H	Pass
6690	-43.05	-13	-30.05	-64.86	-45.24	5.22	9.56	H	Pass

Remark : Spurious emissions within 30-1000MHz were found more than 20dB below limit line.



Vertical Polarization
Level (dBm)

Date: 2008-07-31

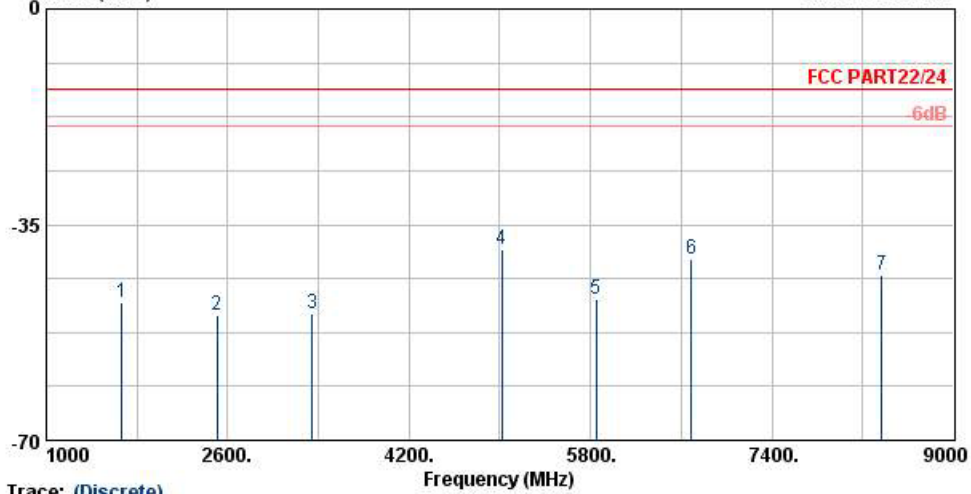

Trace: (Discrete)

Site : 03CH07-HY
Condition : HF-EIRP(080306) VERTICAL
EUT : Module
Power : 3.6Vdc
Model : FG 863020
Mode : Model

Frequency (MHz)	ERP (dBm)	Limit (dBm)	Over Limit (dB)	SPA Reading (dBm)	S.G. Power (dBm)	TX Cable loss (dB)	TX Antenna Gain (dBi)	Polarization (H/V)	Result
1669	-47.63	-13	-34.63	-55.55	-46.25	3.39	4.16	V	Pass
2509	-49.69	-13	-36.69	-60.28	-49.55	3.71	5.72	V	Pass
3346	-49.41	-13	-36.41	-58.89	-51.61	3.13	7.48	V	Pass
5015	-39.08	-13	-26.08	-55.24	-43.44	2.61	9.12	V	Pass
5850	-47.17	-13	-34.17	-65.29	-50.66	4.38	10.02	V	Pass
6690	-40.72	-13	-27.72	-61.94	-43.97	5.22	10.62	V	Pass
8370	-43.08	-13	-30.08	-64.66	-46.70	5.59	11.36	V	Pass

Remark : Spurious emissions within 30-1000MHz were found more than 20dB below limit line.



- Mode 2
- Horizontal Polarization

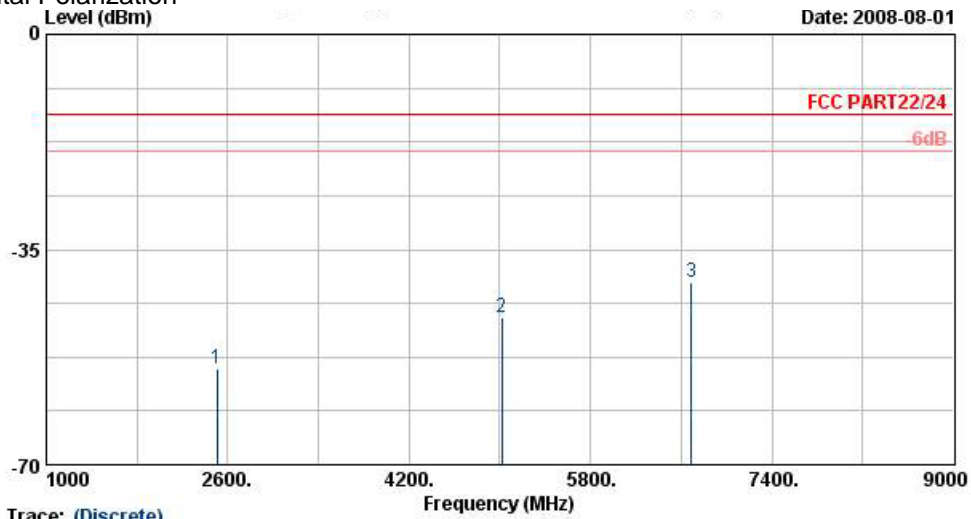

Trace: (Discrete)
 Site : 03CH07-HY
 Condition : HF-EIRP(080306) HORIZONTAL
 EUT : Module
 Power : 3.6Vdc
 Model : FG 863020
 Mode : Mode2

Frequency (MHz)	ERP (dBm)	Limit (dBm)	Over Limit (dB)	SPA Reading (dBm)	S.G. Power (dBm)	TX Cable loss (dB)	TX Antenna Gain (dBi)	Polarization (H/V)	Result
2509	-54.48	-13	-41.48	-64.62	-54.54	3.71	5.92	H	Pass
5015	-46.08	-13	-33.08	-59.61	-49.83	2.61	8.51	H	Pass
6690	-40.37	-13	-27.37	-62.18	-42.56	5.22	9.56	H	Pass

Remark : Spurious emissions within 30-1000MHz were found more than 20dB below limit line.



Vertical Polarization
Level (dBm)

Date: 2008-08-01

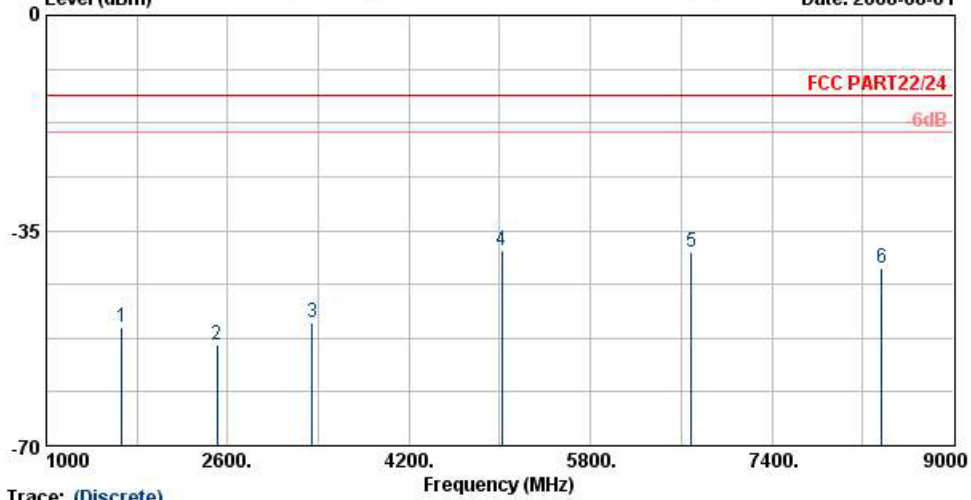

Trace: (Discrete)

Site : 03CH07-HY
Condition : HF-EIRP(080306) VERTICAL
EUT : Module
Power : 3.6Vdc
Model : FG 863020
Mode : Mode2

Frequency (MHz)	ERP (dBm)	Limit (dBm)	Over Limit (dB)	SPA Reading (dBm)	S.G. Power (dBm)	TX Cable loss (dB)	TX Antenna Gain (dBi)	Polarization (H/V)	Result
1669	-50.83	-13	-37.83	-58.75	-49.45	3.39	4.16	V	Pass
2509	-53.66	-13	-40.66	-64.25	-53.52	3.71	5.72	V	Pass
3346	-49.95	-13	-36.95	-62.39	-52.15	3.13	7.48	V	Pass
5015	-38.26	-13	-25.26	-54.35	-42.62	2.61	9.12	V	Pass
6690	-38.49	-13	-25.49	-59.71	-41.74	5.22	10.62	V	Pass
8370	-41.16	-13	-28.16	-62.74	-44.78	5.59	11.36	V	Pass

Remark : Spurious emissions within 30-1000MHz were found more than 20dB below limit line.



- Mode 3
- Horizontal Polarization

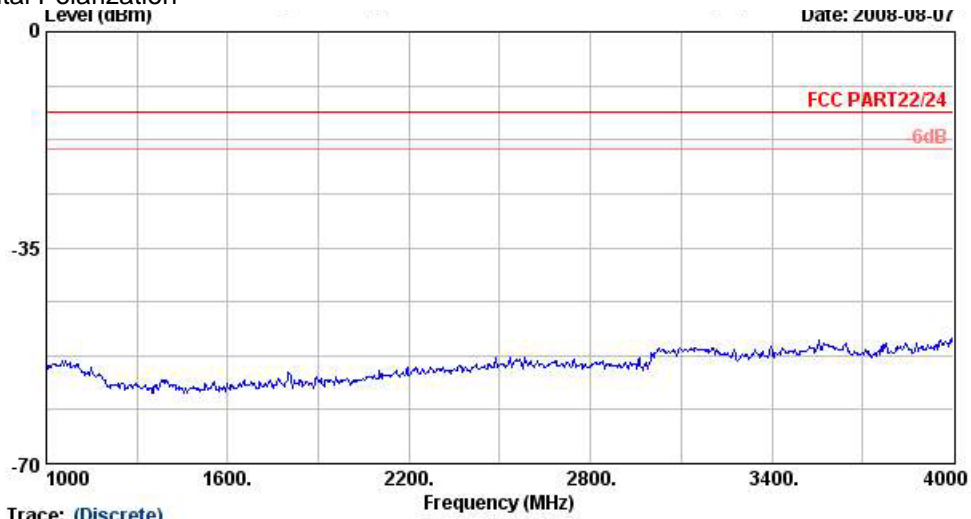

Trace: (Discrete)
Site : 03CH07-HY
Condition : HF-EIRP(080306) HORIZONTAL
EUT : Module
Power : 3.6Vdc
Model : FG 863020
Mode : Mode3

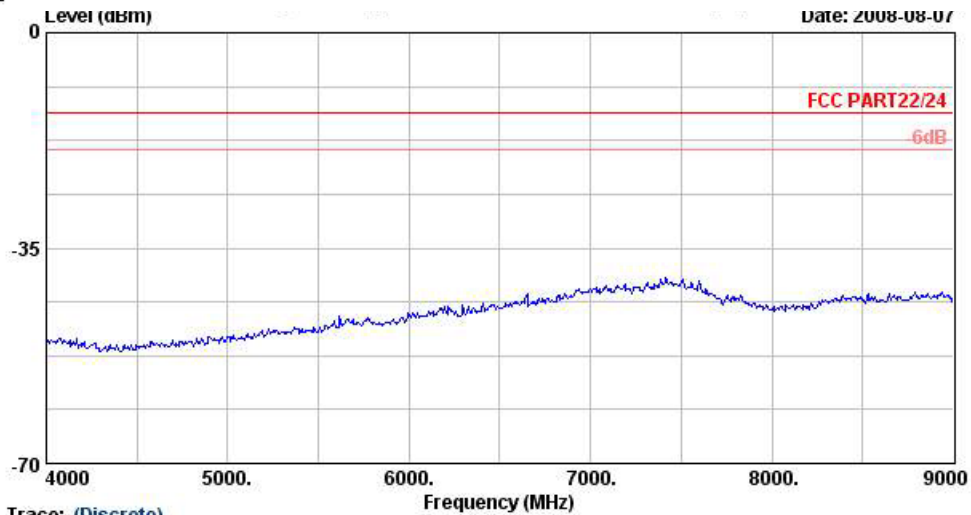

Trace: (Discrete)
Site : 03CH07-HY
Condition : HF-EIRP(080306) HORIZONTAL
EUT : Module
Power : 3.6Vdc
Model : FG 863020
Mode : Mode3



Vertical Polarization

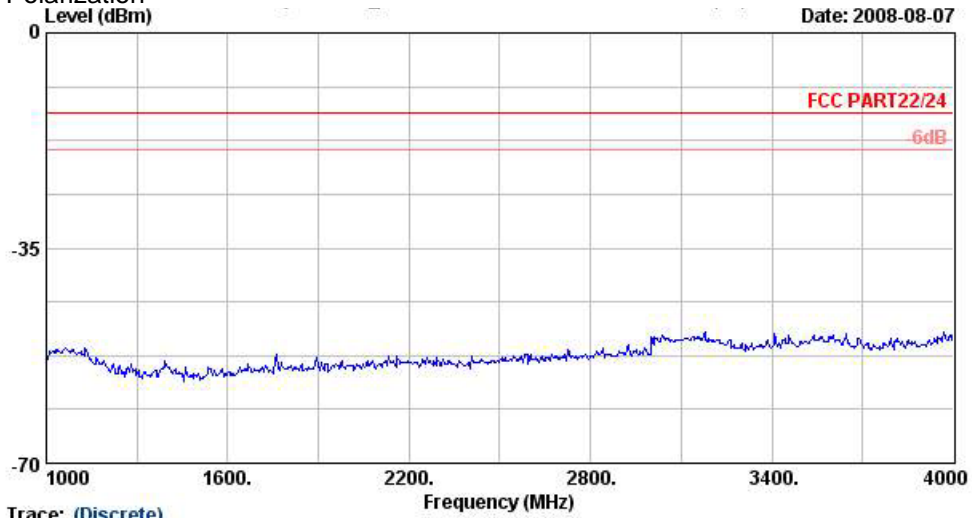

Trace: (Discrete)
Site : 03CH07-HY
Condition : HF-EIRP(080306) VERTICAL
EUT : Module
Power : 3.6Vdc
Model : FG 863020
Mode : Mode3

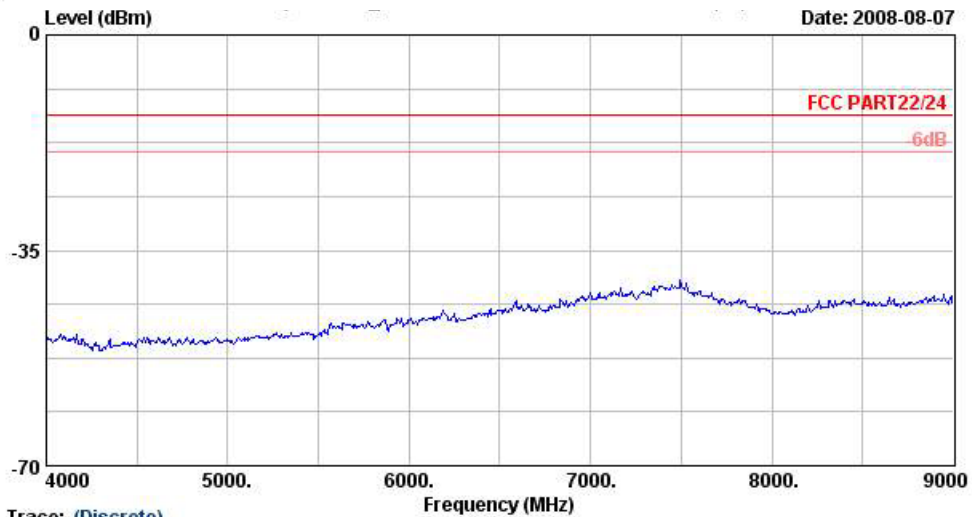

Trace: (Discrete)
Site : 03CH07-HY
Condition : HF-EIRP(080306) VERTICAL
EUT : Module
Power : 3.6Vdc
Model : FG 863020
Mode : Mode3



- Mode 4
- Horizontal Polarization

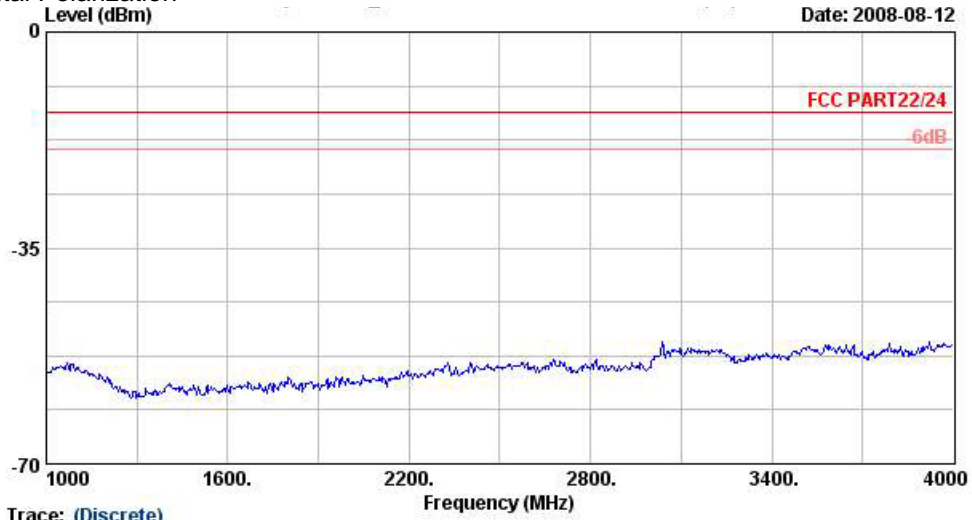

Trace: (Discrete)
Site : 03CH07-HY
Condition : HF-EIRP(080306) HORIZONTAL
EUT : Module
Power : 3.6Vdc
Model : FG 863020
Mode : Mode4

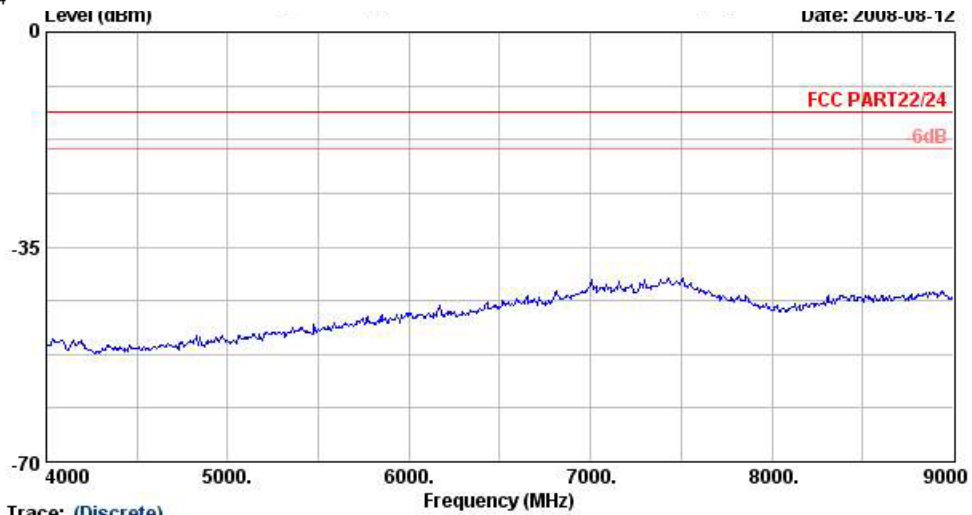

Trace: (Discrete)
Site : 03CH07-HY
Condition : HF-EIRP(080306) HORIZONTAL
EUT : Module
Power : 3.6Vdc
Model : FG 863020
Mode : Mode4



Vertical Polarization

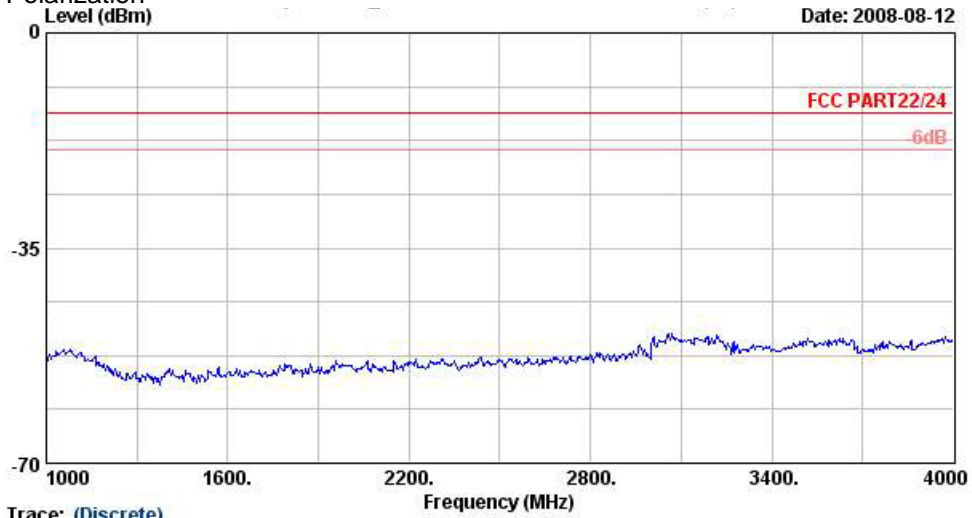

Trace: (Discrete)
Site : 03CH07-HY
Condition : HF-EIRP(080306) VERTICAL
EUT : Module
Power : 3.6Vdc
Model : FG 863020
Mode : Mode4

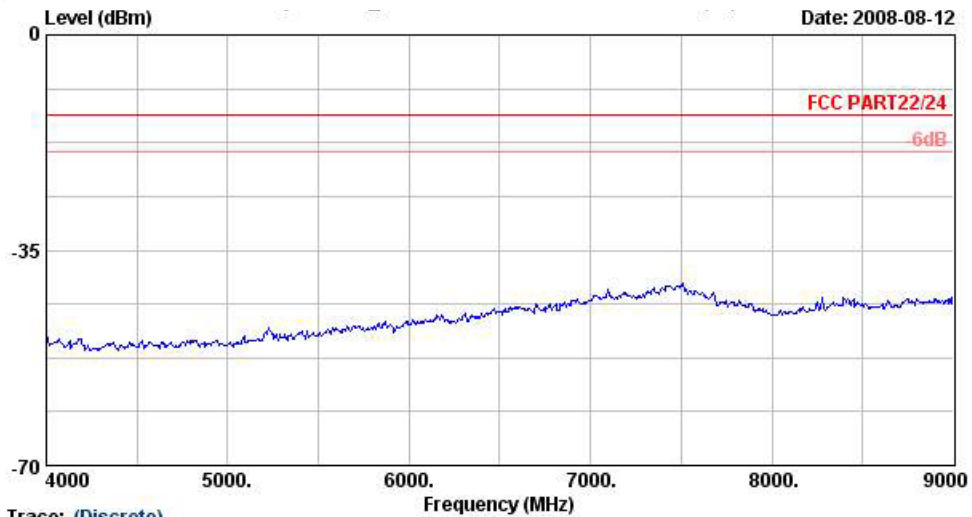

Trace: (Discrete)
Site : 03CH07-HY
Condition : HF-EIRP(080306) VERTICAL
EUT : Module
Power : 3.6Vdc
Model : FG 863020
Mode : Mode4



- Mode 5
- Horizontal Polarization

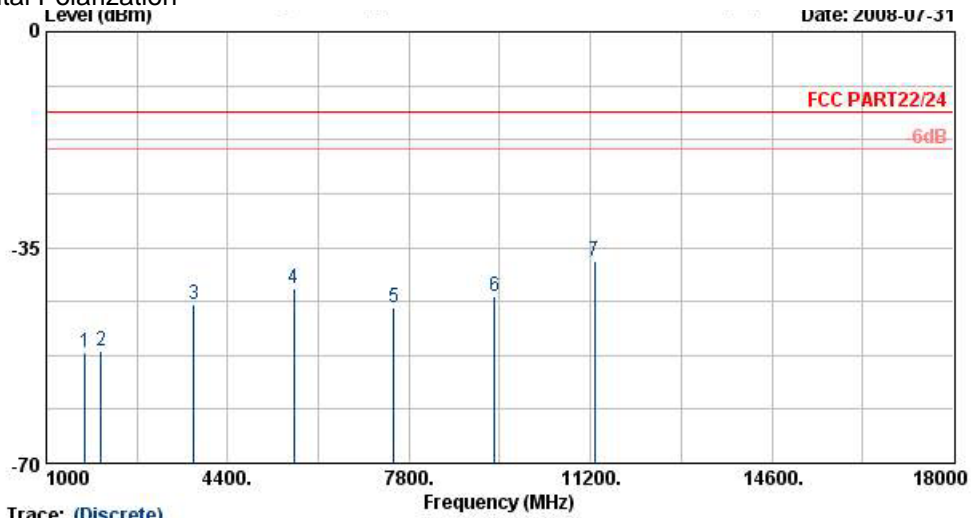

Site : 03CH07-HY
 Condition : HF-EIRP(080306) HORIZONTAL
 EUT : Module
 Power : 3.6Vdc
 Model : FG 863020
 Mode : Model

Frequency (MHz)	ERP (dBm)	Limit (dBm)	Over Limit (dB)	SPA Reading (dBm)	S.G. Power (dBm)	TX Cable loss (dB)	TX Antenna Gain (dBi)	Polarization (H/V)	Result
1726	-52.03	-13	-39.03	-60.21	-54.45	3.93	6.35	H	Pass
2030	-51.89	-13	-38.89	-61.65	-55.17	3.54	6.82	H	Pass
3760	-44.22	-13	-31.22	-58.71	-47.59	4.03	7.40	H	Pass
5636	-41.52	-13	-28.52	-61.87	-46.46	3.87	8.81	H	Pass
7520	-44.65	-13	-31.65	-65.25	-48.53	5.83	9.71	H	Pass
9396	-42.93	-13	-29.93	-65.09	-47.63	6.02	10.72	H	Pass
11280	-37.11	-13	-24.11	-67.74	-39.39	8.48	10.76	H	Pass

Remark : Spurious emissions within 30-1000MHz were found more than 20dB below limit line.



Vertical Polarization
Level (dBm)

Date: 2008-07-31

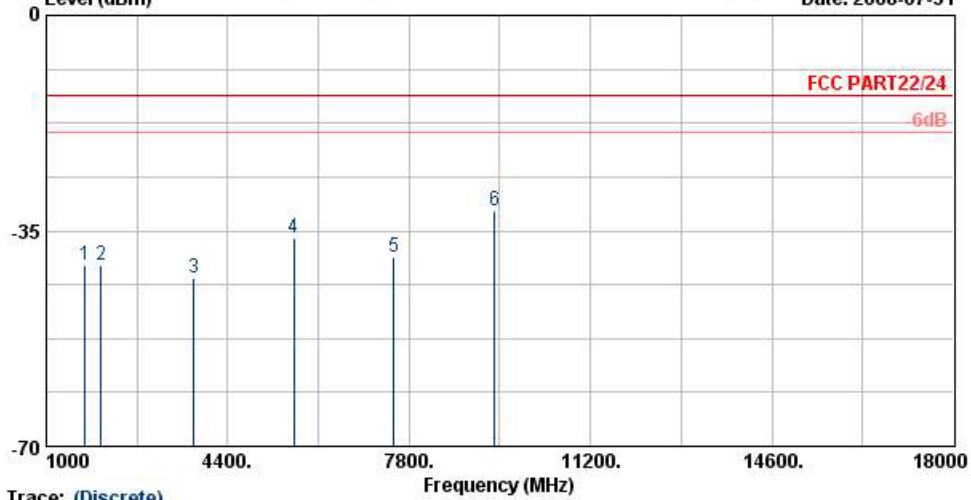

Trace: (Discrete)

Site : 03CH07-HY
Condition : HF-EIRP(080306) VERTICAL
EUT : Module
Power : 3.6Vdc
Model : FG 863020
Mode : Model

Frequency (MHz)	ERP (dBm)	Limit (dBm)	Over Limit (dB)	SPA Reading (dBm)	S.G. Power (dBm)	TX Cable loss (dB)	TX Antenna Gain (dBi)	Polarization (H/V)	Result
1726	-40.60	-13	-27.60	-51.04	-43.02	3.93	6.35	V	Pass
2030	-40.63	-13	-27.63	-52.61	-43.91	3.54	6.82	V	Pass
3760	-42.71	-13	-29.71	-58.01	-46.59	4.03	7.91	V	Pass
5636	-36.29	-13	-23.29	-58.42	-42.19	3.87	9.77	V	Pass
7520	-39.18	-13	-26.18	-61.46	-44.16	5.83	10.81	V	Pass
9396	-31.82	-13	-18.82	-60.97	-37.32	6.02	11.52	V	Pass

Remark : Spurious emissions within 30-1000MHz were found more than 20dB below limit line.



- Mode 6
- Horizontal Polarization

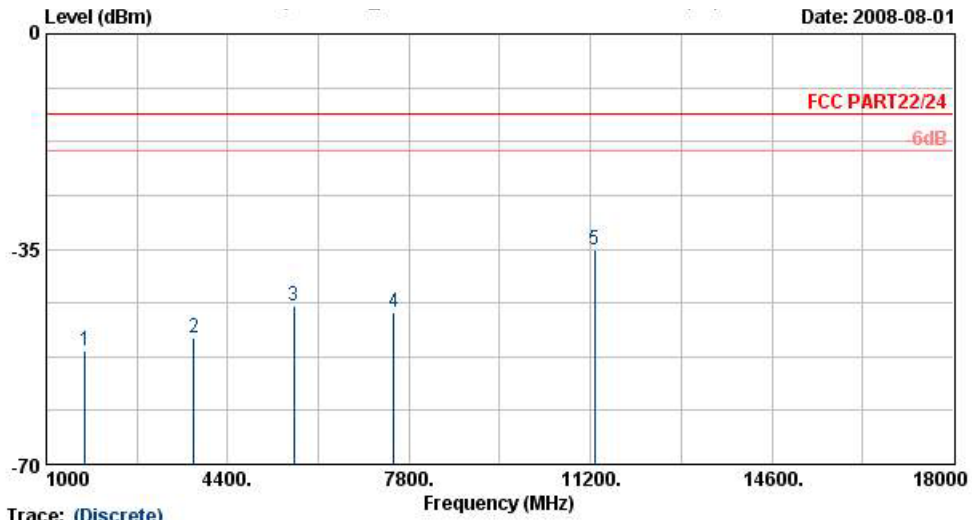

Site : 03CH07-HY
 Condition : HF-EIRP(080306) HORIZONTAL
 EUT : Module
 Power : 3.6Vdc
 Model : FG 863020
 Mode : Mode2

Frequency (MHz)	ERP (dBm)	Limit (dBm)	Over Limit (dB)	SPA Reading (dBm)	S.G. Power (dBm)	TX Cable loss (dB)	TX Antenna Gain (dBi)	Polarization (H/V)	Result
1726	-51.62	-13	-38.62	-59.80	-54.04	3.93	6.35	H	Pass
3760	-49.56	-13	-36.56	-62.06	-52.93	4.03	7.40	H	Pass
5636	-44.17	-13	-31.17	-63.09	-49.11	3.87	8.81	H	Pass
7520	-45.22	-13	-32.22	-65.82	-49.10	5.83	9.71	H	Pass
11280	-35.01	-13	-22.01	-66.52	-37.29	8.48	10.76	H	Pass

Remark : Spurious emissions within 30-1000MHz were found more than 20dB below limit line.



Vertical Polarization
Level (dBm)

Date: 2008-08-01

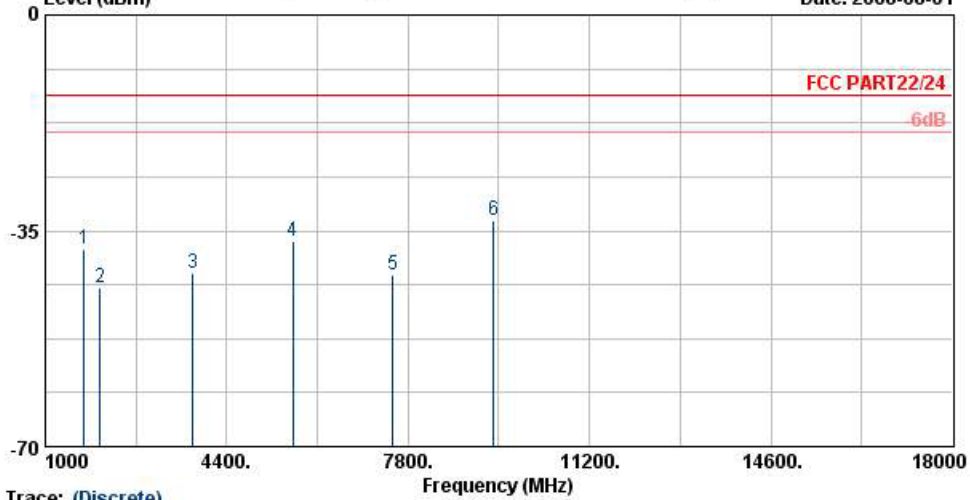

Trace: (Discrete)

Site : 03CH07-HY
 Condition : HF-EIRP(080306) VERTICAL
 EUT : Module
 Power : 3.6Vdc
 Model : FG 863020
 Mode : Mode2

Frequency (MHz)	ERP (dBm)	Limit (dBm)	Over Limit (dB)	SPA Reading (dBm)	S.G. Power (dBm)	TX Cable loss (dB)	TX Antenna Gain (dBi)	Polarization (H/V)	Result
1726	-38.12	-13	-25.12	-48.56	-40.54	3.93	6.35	V	Pass
2030	-44.31	-13	-31.31	-56.29	-47.59	3.54	6.82	V	Pass
3760	-41.90	-13	-28.90	-58.91	-45.78	4.03	7.91	V	Pass
5636	-36.62	-13	-23.62	-58.75	-42.52	3.87	9.77	V	Pass
7520	-42.16	-13	-29.16	-64.25	-47.14	5.83	10.81	V	Pass
9396	-33.37	-13	-20.37	-62.39	-38.87	6.02	11.52	V	Pass

Remark : Spurious emissions within 30-1000MHz were found more than 20dB below limit line.



- Mode 7
- Horizontal Polarization

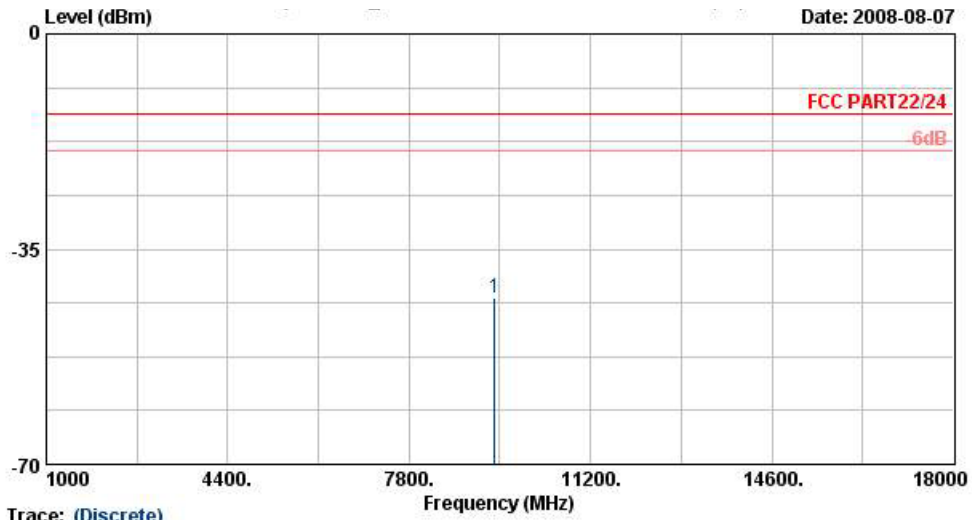

Trace: (Discrete)
 Site : 03CH07-HY
 Condition : HF-EIRP(080306) HORIZONTAL
 EUT : Module
 Power : 3.6Vdc
 Model : FG 863020
 Mode : Mode3

Frequency (MHz)	EIRP (dBm)	Limit (dBm)	Over Limit (dB)	SPA Reading (dBm)	S.G. Power (dBm)	TX Cable loss (dB)	TX Antenna Gain (dBi)	Polarization (H/V)	Result
9408	-42.87	-13	-29.87	-65.03	-47.57	6.02	10.72	H	Pass

Remark : Spurious emissions within 30-1000MHz were found more than 20dB below limit line.



Vertical Polarization

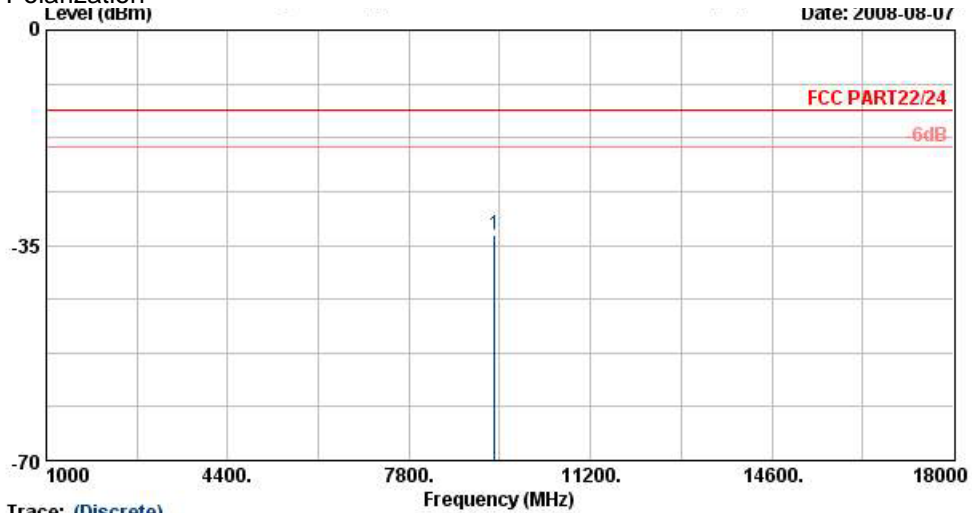

Trace: (Discrete)

Site : 03CH07-HY
 Condition : HF-EIRP(080306) VERTICAL
 EUT : Module
 Power : 3.6Vdc
 Model : FG 863020
 Mode : Mode3

Frequency (MHz)	EIRP (dBm)	Limit (dBm)	Over Limit (dB)	SPA Reading (dBm)	S.G. Power (dBm)	TX Cable loss (dB)	TX Antenna Gain (dBi)	Polarization (H/V)	Result
9408	-33.29	-13	-20.29	-62.31	-38.79	6.02	11.52	V	Pass

Remark : Spurious emissions within 30-1000MHz were found more than 20dB below limit line.



- Mode 8
- Horizontal Polarization

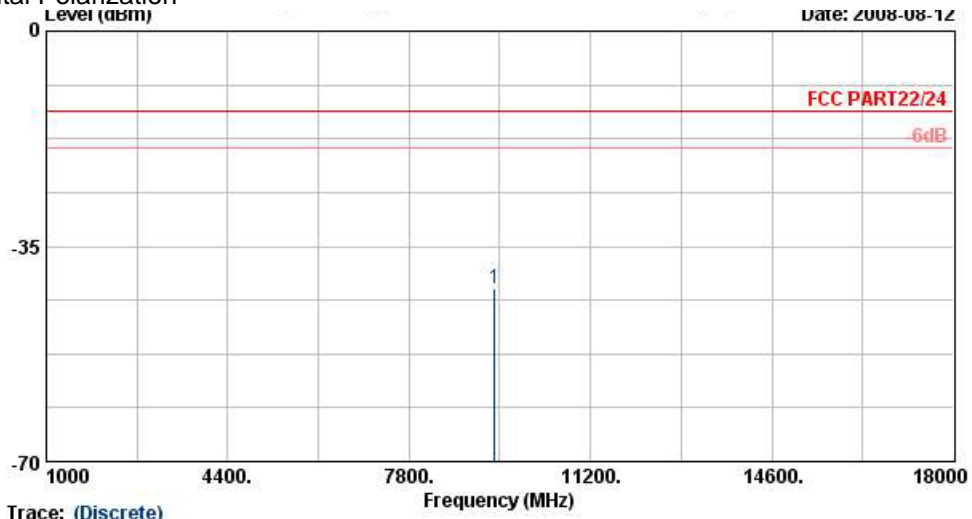

Trace: (Discrete)
 Site : 03CH07-HY
 Condition : HF-EIRP(080306) HORIZONTAL
 EUT : Module
 Power : 3.6Vdc
 Model : FG 863020
 Mode : Mode4

Frequency (MHz)	EIRP (dBm)	Limit (dBm)	Over Limit (dB)	SPA Reading (dBm)	S.G. Power (dBm)	TX Cable loss (dB)	TX Antenna Gain (dBi)	Polarization (H/V)	Result
9408	-42.01	-13	-29.01	-64.39	-46.71	6.02	10.72	H	Pass

Remark : Spurious emissions within 30-1000MHz were found more than 20dB below limit line.



Vertical Polarization

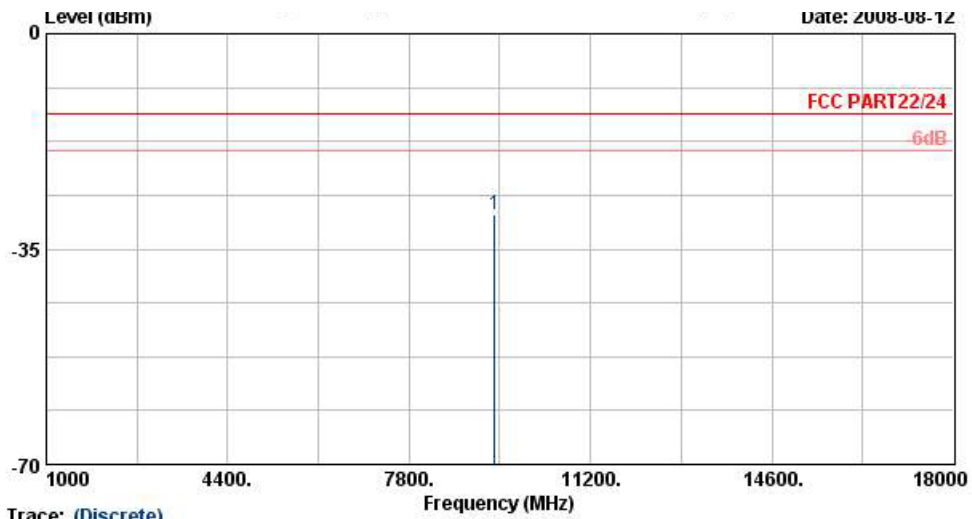

Trace: (Discrete)
 Site : 03CH07-HY
 Condition : HF-EIRP(080306) VERTICAL
 EUT : Module
 Power : 3.6Vdc
 Model : FG 863020
 Mode : Mode4

Frequency (MHz)	EIRP (dBm)	Limit (dBm)	Over Limit (dB)	SPA Reading (dBm)	S.G. Power (dBm)	TX Cable loss (dB)	TX Antenna Gain (dBi)	Polarization (H/V)	Result
9408	-29.33	-13	-16.33	-58.94	-34.83	6.02	11.52	V	Pass

Remark : Spurious emissions within 30-1000MHz were found more than 20dB below limit line.

4.7 Frequency Stability (Temperature Variation)

4.7.1 Measurement Instrument

As described in chapter 5 of this test report.

4.7.2 Test Procedure

- a. The EUT and test equipment were set up as shown on the following section.
- b. With all power removed, the temperature was decreased to -30°C and permitted to stabilize for three hours. Power was applied and the maximum change in frequency was noted within one minute.
- c. With power OFF, the temperature was raised in 10°C steps. The sample was permitted to stabilize at each step for at least one-half hour. Power was applied and the maximum frequency change was noted within one minute.
- d. The temperature tests were performed for the worst case.
- e. Test data was recorded.

4.7.3 Test Setup Layout

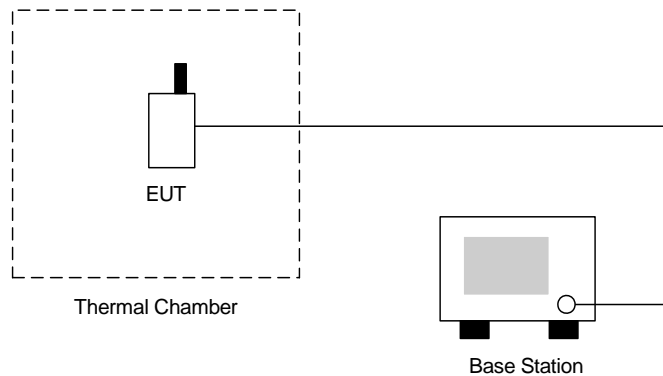



4.7.4 Test Result

• Test Mode : GSM850 (GPRS) CH189

Temperature(°C)	Change (Hz)	Change (ppm)	Limit (ppm)	Result
-30	-13	-0.01	2.5	Passed
-20	-11	-0.01		
-10	-9	-0.01		
0	-19	-0.02		
10	41	0.05		
20	49	0.06		
30	86	0.10		
40	43	0.05		
50	56	0.07		

• Test Mode : GSM850 (EDGE) CH189

Temperature(°C)	Change (Hz)	Change (ppm)	Limit (ppm)	Result
-30	8	0.00	2.5	Passed
-20	19	0.02		
-10	13	0.02		
0	15	0.02		
10	16	0.02		
20	21	0.02		
30	22	0.03		
40	25	0.03		
50	32	0.04		



• Test Mode : GSM1900 (GPRS) CH189

Temperature(°C)	Change (Hz)	Change (ppm)	Limit (ppm)	Result
-30	7	0.00	2.5	Passed
-20	-8	0.00		
-10	-14	-0.01		
0	-9	0.00		
10	-29	-0.02		
20	-49	-0.03		
30	-45	-0.02		
40	-33	-0.02		
50	-54	-0.03		

• Test Mode : GSM1900 (EDGE) CH661

Temperature(°C)	Change (Hz)	Change (ppm)	Limit (ppm)	Result
-30	10	0.01	2.5	Passed
-20	18	0.01		
-10	24	0.01		
0	10	0.01		
10	28	0.01		
20	39	0.02		
30	41	0.02		
40	45	0.02		
50	77	0.04		



• Test Mode : WCDMA Band V CH4182

Temperature(°C)	Change (Hz)	Change (ppm)	Limit (ppm)	Result
-30	-7	-0.01	2.5	Passed
-20	-13	-0.02		
-10	-16	-0.02		
0	8	0.01		
10	-10	-0.01		
20	-13	-0.02		
30	-10	-0.01		
40	-8	-0.01		
50	-12	-0.01		

• Test Mode : WCDMA Band V (HSUPA) CH4182

Temperature(°C)	Change (Hz)	Change (ppm)	Limit (ppm)	Result
-30	20	0.02	2.5	Passed
-20	17	0.02		
-10	10	0.01		
0	-22	-0.03		
10	-25	-0.03		
20	-33	-0.04		
30	-64	-0.08		
40	-72	-0.08		
50	-16	-0.02		



▪ Test Mode : WCDMA Band II CH9400

Temperature(°C)	Change (Hz)	Change (ppm)	Limit (ppm)	Result
-30	-11	-0.01	2.5	Passed
-20	-23	-0.01		
-10	-44	-0.02		
0	-49	-0.03		
10	-54	-0.03		
20	-41	-0.02		
30	-37	-0.02		
40	-44	-0.02		
50	-63	-0.03		

▪ Test Mode : WCDMA Band II (HSUPA) CH9400

Temperature(°C)	Change (Hz)	Change (ppm)	Limit (ppm)	Result
-30	-23	-0.01	2.5	Passed
-20	-26	-0.01		
-10	-17	-0.01		
0	-20	-0.01		
10	-18	-0.01		
20	-39	-0.02		
30	-40	-0.02		
40	-51	-0.03		
50	-72	-0.04		

4.8 Frequency Stability (Voltage Variation)

4.8.1 Measurement Instrument

As described in chapter 5 of this test report.

4.8.2 Test Procedure

- a. The EUT was placed in a temperature chamber at $25\pm 5^{\circ}\text{C}$ and connected as the following section.
- b. The power supply voltage to the EUT was varied from BEP to 115% of the nominal value measured at the input to the EUT.
- c. The variation in frequency was measured for the worst case.

4.8.3 Test Setup Layout

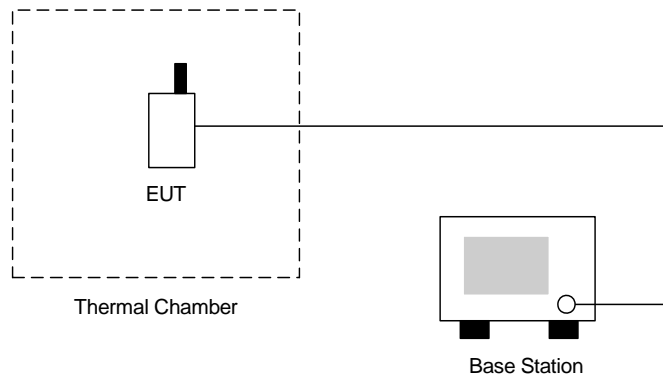

4.8.4 Test Result

- Test Mode : GSM850 (GPRS) CH189

Voltage(Volt)	Change (Hz)	Change (ppm)	Limit (ppm)	Result
3.6	49	0.06	2.5	Passed
BEP	32	0.04		
4.1	45	0.05		

- Test Mode : GSM850 (EDGE) CH189

Voltage(Volt)	Change (Hz)	Change (ppm)	Limit (ppm)	Result
3.6	21	0.02	2.5	Passed
BEP	24	0.03		
4.1	27	0.03		



- Test Mode : GSM1900 (GPRS) CH661

Voltage(Volt)	Change (Hz)	Change (ppm)	Limit (ppm)	Result
3.6	-49	-0.03	2.5	Passed
BEP	-78	-0.04		
4.1	-69	-0.04		

- Test Mode : GSM1900 (EDGE) CH661

Voltage(Volt)	Change (Hz)	Change (ppm)	Limit (ppm)	Result
3.6	39	0.02	2.5	Passed
BEP	24	0.01		
4.1	26	0.01		

- Test Mode : WCDMA Band V CH4182

Voltage(Volt)	Change (Hz)	Change (ppm)	Limit (ppm)	Result
3.6	-13	-0.02	2.5	Passed
BEP	-8	-0.01		
4.1	-5	-0.01		

- Test Mode : WCDMA Band V (HSUPA) CH4182

Voltage(Volt)	Change (Hz)	Change (ppm)	Limit (ppm)	Result
3.6	-33	-0.04	2.5	Passed
BEP	-66	-0.08		
4.1	-57	-0.07		

- Test Mode : WCDMA Band II CH9400

Voltage(Volt)	Change (Hz)	Change (ppm)	Limit (ppm)	Result
3.6	-41	-0.02	2.5	Passed
BEP	-48	-0.03		
4.1	-45	-0.02		

- Test Mode : WCDMA Band II (HSUPA) CH9400

Voltage(Volt)	Change (Hz)	Change (ppm)	Limit (ppm)	Result
3.6	-39	-0.02	2.5	Passed
BEP	11	0.01		
4.1	-23	-0.01		

Remark:

- Normal Voltage= 3.6V.
- Battery End Point (BEP)= 3.0 V.



5. List of Measurement Equipments

Instrument	Manufacturer	Model No.	Serial No.	Characteristics	Calibration Date	Due Date	Remark
Bilog Antenna	SCHAFFNER	CBL6111C	2726	30MHz-1GHz	Dec. 01, 2007	Nov. 30, 2008	Radiation (03CH07-HY)
Spectrum Analyzer	R & S	FSP	101067	9KHz~30GHz	Dec. 05, 2007	Dec. 05, 2008	Radiation (03CH07-HY)
Double Ridge Horn Antenna	ESCO	3117	75962	1G~18G	Dec. 20, 2007	Dec. 20, 2008	Radiation (03CH07-HY)
PreAmplifier	Agilent	8449B	3008A02362	1~26.5GHz	Dec. 22, 2007	Dec. 22, 2008	Radiation (03CH07-HY)
PreAmplifier	COM-POWER	PA-103A	161241	10-1000MHz.32d B.GAIN	Mar. 31, 2008	Mar.31, 2009	Radiation (03CH07-HY)
Double Ridge Horn Antenna	ESCO	3117	66584	1G~18G	Aug. 06, 2008	Aug. 05, 2009	Radiation (03CH07-HY)
Thermal Chamber	Tenyi technology	TTH-D35P	TBN-930701	N/A	Aug. 01, 2008	Jul. 31, 2009	Conducted (TH02-HY)
Spectrum	R&S	FSP40	100055	9KHz~40GHz	Jun.26,2008	Jun.25,2009	Conducted (TH02-HY)
Power Divider	ARRA	5200-1	3871	N/A	Oct. 01, 2007	Sep. 30, 2008	Conducted (TH02-HY)
DC Power Supply	TOPWARD	3303D	740889	N/A	May 25, 2007	May 24, 2009	Conducted (TH02-HY)
Power Meter	Agilent	E4416A	GB41292344	N/A	Feb. 21, 2008	Feb. 20, 2009	Conducted (TH02-HY)
Power Sensor	Agilent	E9327A	US40441548	N/A	Feb. 21, 2008	Feb. 20, 2009	Conducted (TH02-HY)

6. Uncertainty Evaluation

Uncertainty of Radiated Emission Measurement (30MHz ~ 1000MHz)

Contribution	Uncertainty of x_i		$u(x_i)$
	dB	Probability Distribution	
Receiver reading	0.41	Normal(k=2)	0.21
Antenna factor calibration	0.83	Normal(k=2)	0.42
Cable loss calibration	0.25	Normal(k=2)	0.13
Pre Amplifier Gain calibration	0.27	Normal(k=2)	0.14
RCV/SPA specification	2.50	Rectangular	0.72
Antenna Factor Interpolation for Frequency	1.00	Rectangular	0.29
Site imperfection	1.43	Rectangular	0.83
Mismatch	+0.39/-0.41	U-shaped	0.28
Combined standard uncertainty Uc(y)	1.27		
Measuring uncertainty for a level of confidence of 95% U=2Uc(y)	2.54		

Uncertainty of Radiated Emission Measurement (1GHz ~ 40GHz)

Contribution	Uncertainty of x_i		$u(x_i)$	C_i	$C_i * u(x_i)$
	dB	Probability Distribution			
Receiver reading	±0.10	Normal(k=1)	0.10	1	0.10
Antenna factor calibration	±1.70	Normal(k=2)	0.85	1	0.85
Cable loss calibration	±0.50	Normal(k=2)	0.25	1	0.25
Receiver Correction	±2.00	Rectangular	1.15	1	1.15
Antenna Factor Directional	±1.50	Rectangular	0.87	1	0.87
Site imperfection	±2.80	Triangular	1.14	1	1.14
Mismatch Receiver VSWR $\Gamma_1 = 0.197$ Antenna VSWR $\Gamma_2 = 0.194$ Uncertainty = $20 \log(1 - \Gamma_1 * \Gamma_2 * \Gamma_3)$	+0.34/-0.35	U-shaped	0.244	1	0.244
Combined standard uncertainty Uc(y)	2.36				
Measuring uncertainty for a level of confidence of 95% U=2Uc(y)	4.72				

END OF TEST REPORT



Appendix A. Photographs of EUT

Please refer to Sporton report number EP863020 as below.

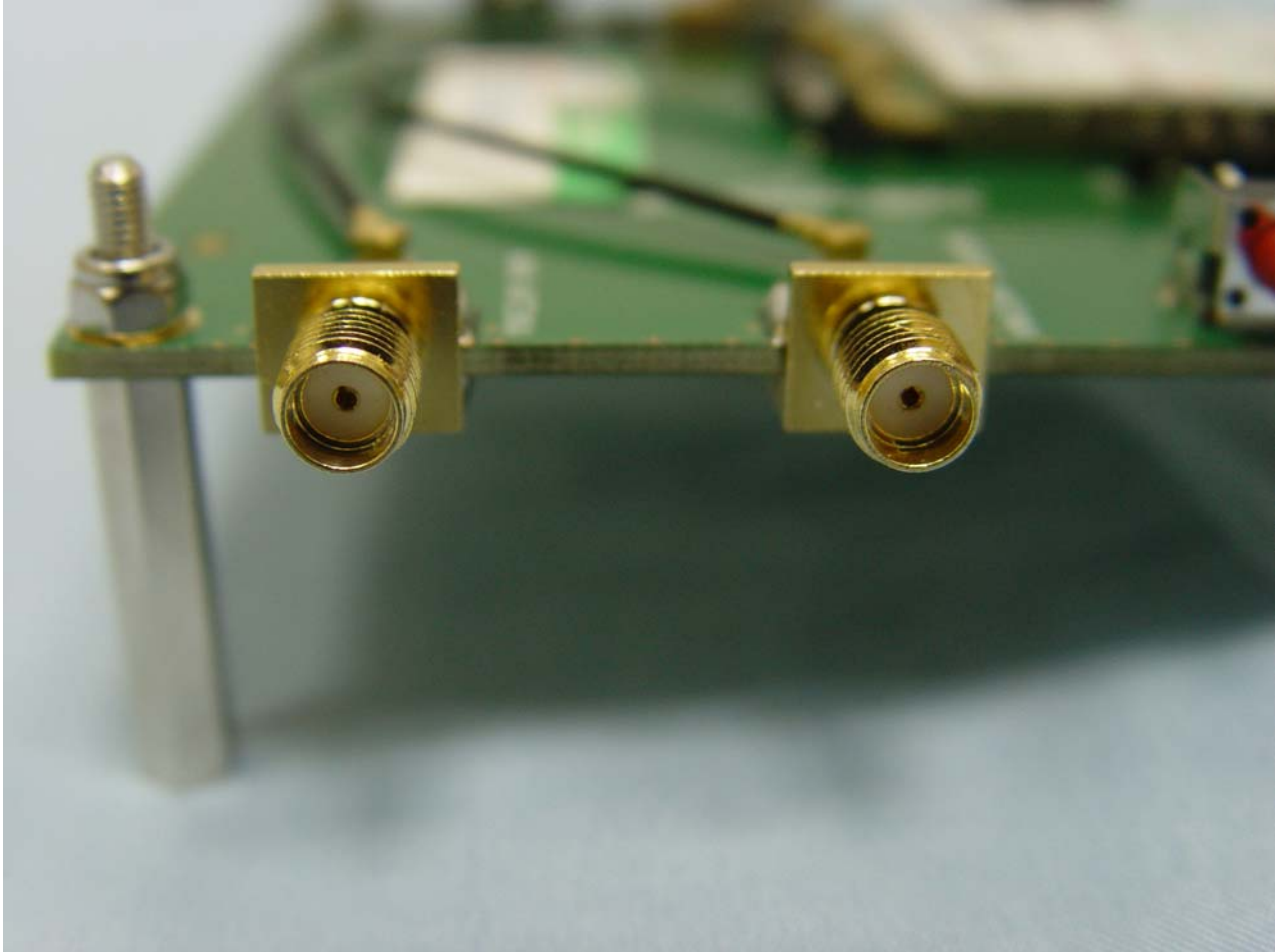
1. External Photographs of EUT**Model Name: Wavecom-PCIE100**

Model Name: Wavecom-PCIE100

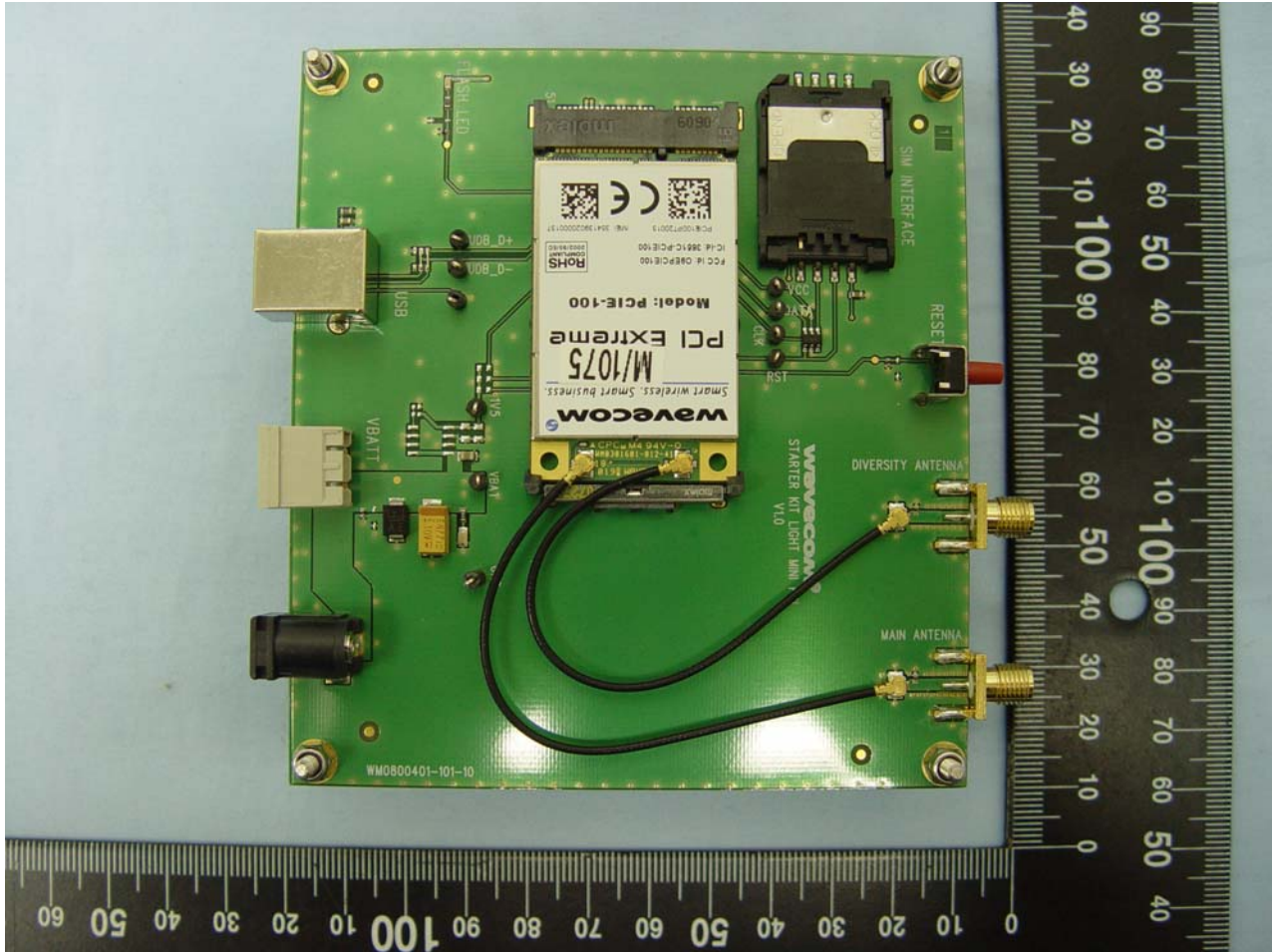

Model Name: Wavecom-PCIE100

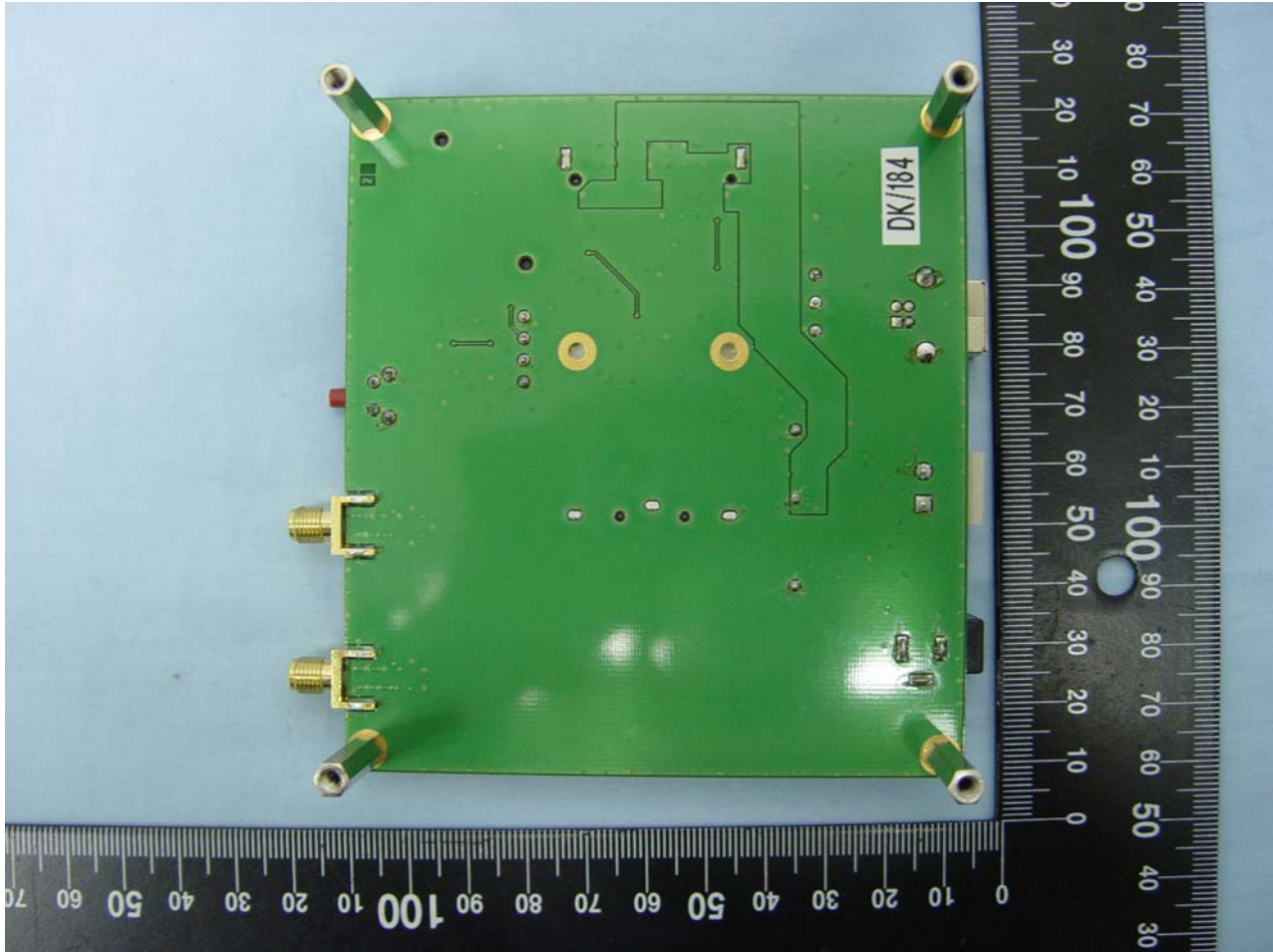

2. Internal Photographs of EUT

Model Name: Wavecom-PCIE100

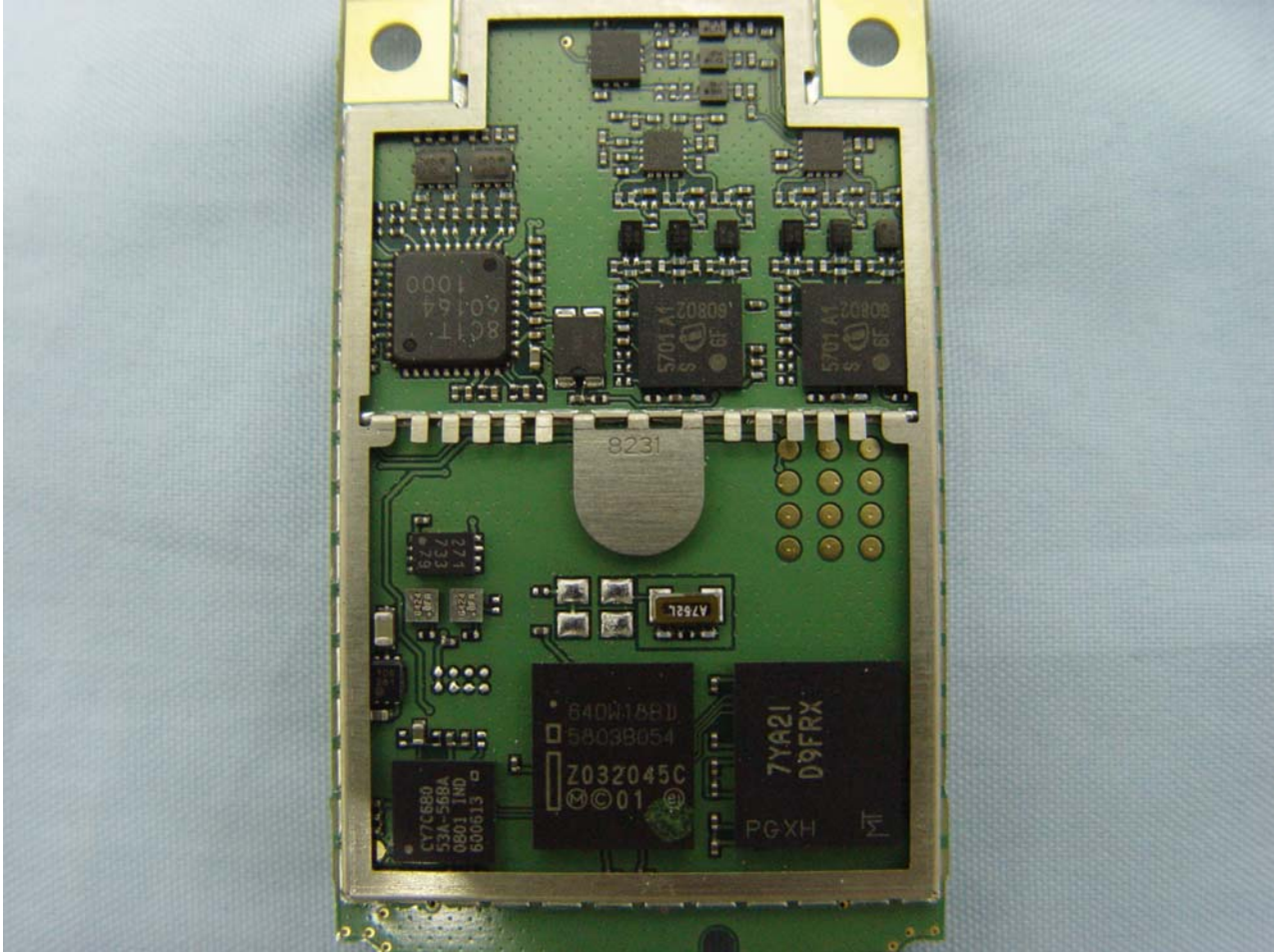

Model Name: Wavecom-PCIE100

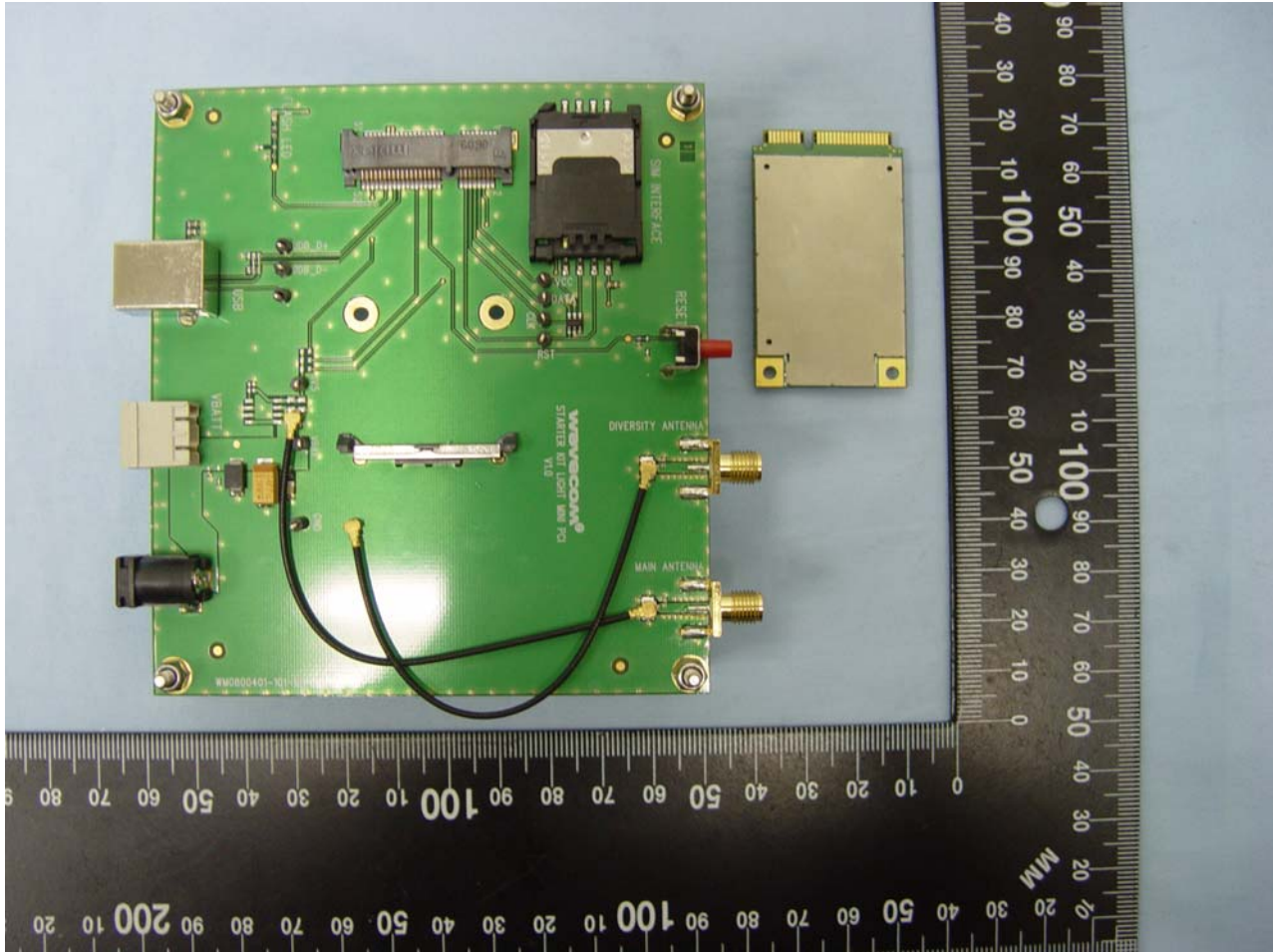

Model Name: Wavecom-PCIE100



Model Name: Wavecom-PCIE100

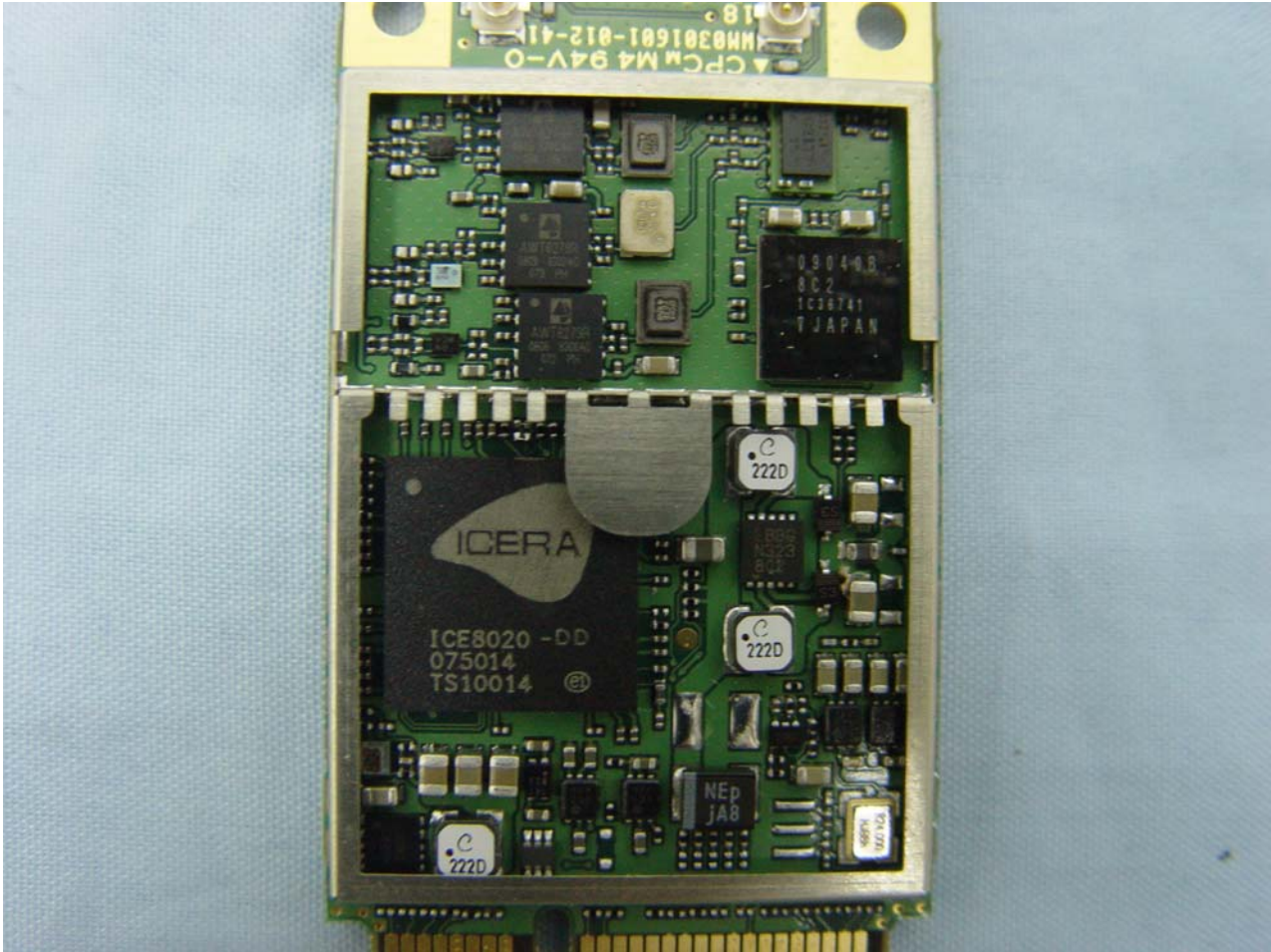



Model Name: Wavecom-PCIE100



Model Name: Wavecom-PCIE100

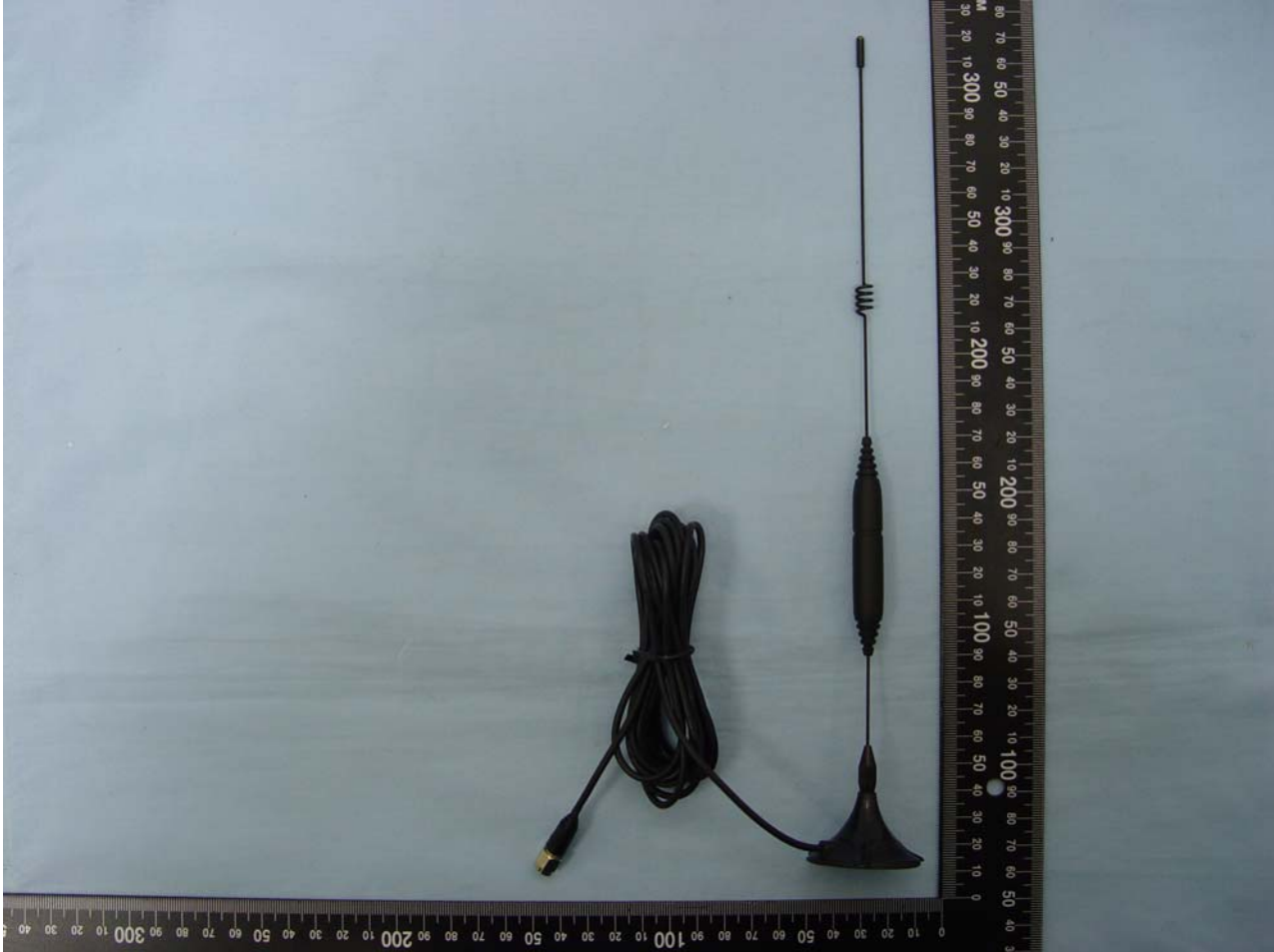

Appendix B. Setup Photographs

Spurious Radiation

FRONT VIEW

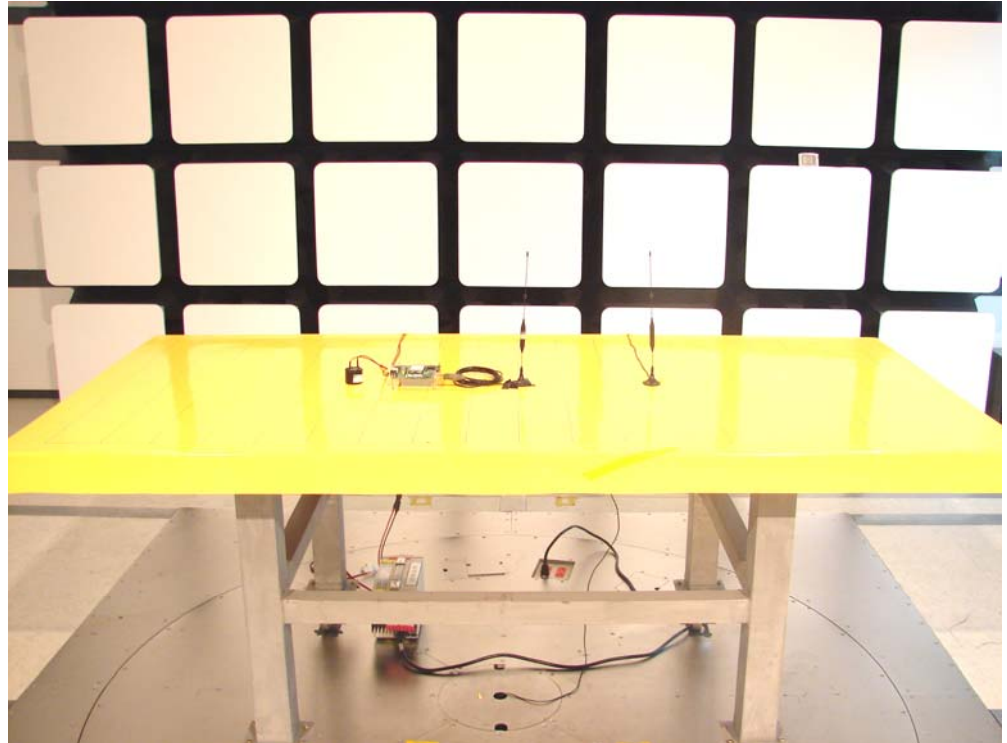

REAR VIEW

