



FCC TEST REPORT (15.247)

REPORT NO.: RF940326H02

MODEL NO.: WL-464

RECEIVED: April 6, 2005

TESTED: April 13 to May 27, 2005

ISSUED: June 9, 2005

APPLICANT: 3Com Corporation

ADDRESS: 350 Campus Drive, Marlborough, MA
01752-3064, U.S.A.

ISSUED BY: Advance Data Technology Corporation

TEST LOCATION: No. 81-1, Lu Liao Keng, 9 Ling, Wu Lung
Tsuen, Chiung Lin Hsiang, Hsin Chu Hsien,
Taiwan, R.O.C.

This test report consists of 84 pages in total. It may be duplicated completely for legal use with the approval of the applicant. It should not be reproduced except in full, without the written approval of our laboratory. The client should not use it to claim product endorsement by CNLA, A2LA or any government agencies. The test results in the report only apply to the tested sample. The test results in this report are traceable to the national or international standards.



0536

ILAC MRA



No. 2177-01



Table of Contents

1.	CERTIFICATION.....	5
2.	SUMMARY OF TEST RESULTS.....	6
3.	GENERAL INFORMATION	7
3.1	GENERAL DESCRIPTION OF EUT.....	7
3.2	DESCRIPTION OF TEST MODES.....	9
3.2.1	TEST MODE APPLICABILITY AND TESTED CHANNEL DETAIL:.....	10
3.3	GENERAL DESCRIPTION OF APPLIED STANDARDS	12
3.4	DESCRIPTION OF SUPPORT UNITS	13
3.5	CONFIGURATION OF SYSTEM UNDER TEST	14
4.	TEST TYPES AND RESULTS (802.11a, 5725~5850MHz Band).....	15
4.1	CONDUCTED EMISSION MEASUREMENT	15
4.1.1	LIMITS OF CONDUCTED EMISSION MEASUREMENT	15
4.1.2	TEST INSTRUMENTS.....	15
4.1.3	TEST PROCEDURES	16
4.1.4	DEVIATION FROM TEST STANDARD	16
4.1.5	TEST SETUP.....	17
4.1.6	EUT OPERATING CONDITIONS.....	17
4.1.7	TEST RESULTS (MODE 1)	18
4.1.8	TEST RESULTS (MODE 2)	20
4.1.9	TEST RESULTS (MODE 3)	22
4.1.10	TEST RESULTS (MODE 4)	24
4.2	RADIATED EMISSION MEASUREMENT	26
4.2.1	LIMITS OF RADIATED EMISSION MEASUREMENT	26
4.2.2	TEST INSTRUMENTS.....	27
4.2.3	TEST PROCEDURES	28
4.2.4	DEVIATION FROM TEST STANDARD	28
4.2.5	TEST SETUP.....	29
4.2.6	EUT OPERATING CONDITIONS.....	29
4.2.7	TEST RESULTS (MODE 1)	30
4.2.8	TEST RESULTS (MODE 2)	35
4.2.9	TEST RESULTS (MODE 3)	40
4.2.10	TEST RESULTS (MODE 4)	45



4.3	6DB BANDWIDTH MEASUREMENT	50
4.3.1	LIMITS OF 6DB BANDWIDTH MEASUREMENT	50
4.3.2	TEST INSTRUMENTS	50
4.3.3	TEST PROCEDURE	51
4.3.4	DEVIATION FROM TEST STANDARD	51
4.3.5	TEST SETUP	51
4.3.6	EUT OPERATING CONDITIONS	51
4.3.7	TEST RESULTS	52
4.4	MAXIMUM PEAK OUTPUT POWER	56
4.4.1	LIMITS OF MAXIMUM PEAK OUTPUT POWER MEASUREMENT	56
4.4.2	INSTRUMENTS	56
4.4.3	TEST PROCEDURES	57
4.4.4	DEVIATION FROM TEST STANDARD	57
4.4.5	TEST SETUP	57
4.4.6	EUT OPERATING CONDITIONS	57
4.4.7	TEST RESULTS	58
4.5	POWER SPECTRAL DENSITY MEASUREMENT	62
4.5.1	LIMITS OF POWER SPECTRAL DENSITY MEASUREMENT	62
4.5.2	TEST INSTRUMENTS	62
4.5.3	TEST PROCEDURE	63
4.5.4	DEVIATION FROM TEST STANDARD	63
4.5.5	TEST SETUP	63
4.5.6	EUT OPERATING CONDITION	63
4.5.7	TEST RESULTS	64
4.6	BAND EDGES MEASUREMENT	70
4.6.1	LIMITS OF BAND EDGES MEASUREMENT	70
4.6.2	TEST INSTRUMENTS	70
4.6.3	TEST PROCEDURE	71
4.6.4	DEVIATION FROM TEST STANDARD	71
4.6.5	EUT OPERATING CONDITION	71
4.6.6	TEST RESULTS	72
4.7	ANTENNA REQUIREMENT	75
4.7.1	STANDARD APPLICABLE	75
4.7.2	ANTENNA CONNECTED CONSTRUCTION	75



5.	PHOTOGRAPHS OF THE TEST CONFIGURATION.....	76
6.	INFORMATION ON THE TESTING LABORATORIES	84



1. CERTIFICATION

PRODUCT: Bridging kit - 802.11a
BRAND NAME: 3Com
MODEL NO.: WL-464
TEST SAMPLE: R&D SAMPLE
TESTED: April 13 to May 27, 2005
APPLICANT: 3Com Corporation
STANDARDS: FCC Part 15, Subpart C (Section 15.247),
ANSI C63.4-2003

The above equipment (Model: WL-464) has been tested by **Advance Data Technology Corporation**, and found compliance with the requirement of the above standards. The test record, data evaluation & Equipment Under Test (EUT) configurations represented herein are true and accurate accounts of the measurements of the sample's EMC characteristics under the conditions specified in this report.

PREPARED BY : Carol Liao , **DATE:** June 9, 2005
(Carol Liao)

TECHNICAL ACCEPTANCE : Hank Chung , **DATE:** June 9, 2005
Responsible for RF (Hank Chung)

APPROVED BY : Eric Lin , **DATE:** June 9, 2005
(Eric Lin, Manager)

2. SUMMARY OF TEST RESULTS

The EUT has been tested according to the following specifications:

APPLIED STANDARD: FCC Part 15, Subpart C (Section 15.247)			
Standard Section	Test Type and Limit	Result	Remark
15.207	AC Power Conducted Emission	PASS	Meet the requirement of limit. Minimum passing margin is -12.78dB at 1.494MHz
15.247(a)(2)	Spectrum Bandwidth of a Direct Sequence Spread Spectrum System Limit: min. 500kHz	PASS	Meet the requirement of limit.
15.247(b)	Maximum Peak Output Power Limit: max. 30dBm	PASS	Meet the requirement of limit.
15.247(d)	Radiated Emissions Limit: Table 15.209	PASS	Meet the requirement of limit. Minimum passing margin is -1.10dB at 166.70MHz
15.247(e)	Power Spectral Density Limit: max. 8dBm	PASS	Meet the requirement of limit.
15.247(d)	Band Edge Measurement Limit: 20dB less than the peak value of fundamental frequency	PASS	Meet the requirement of limit.

NOTE:

1. The EUT was operating in 5.150 ~ 5.350GHz and 5.725 ~ 5.850GHz frequencies band. This report was recorded the RF parameters 5.725 ~ 5.850GHz. For 5.150 ~ 5.350GHz RF parameters was recorded in another test report.



3. GENERAL INFORMATION

3.1 GENERAL DESCRIPTION OF EUT

EUT	Bridging kit - 802.11a
MODEL NO.	WL-464
POWER SUPPLY	48Vdc from POE (Power over Ethernet)
MODULATION TYPE	CCK, DQPSK, DBPSK for DSSS 64QAM, 16QAM, QPSK, BPSK for OFDM
MODULATION TECHNOLOGY	DSSS, OFDM
TRANSFER RATE	54/48/36/24/18/12/9/6Mbps (Turbo mode: up to 108Mbps *see Note 3)
FREQUENCY RANGE	5.15 ~ 5.35GHz and 5.725 ~ 5.850GHz
NUMBER OF CHANNEL	13 for Normal mode / 5 for Turbo mode
CHANNEL SPACING	20MHz for Normal mode / 40MHz for Turbo mode
OUTPUT POWER	19.38dBm
DATA CABLE	NA
ANTENNA TYPE	Please see note 4 (on next page)
I/O PORTS	NA
ASSOCIATED DEVICES	NA

NOTE:

1. The EUT was operated with the following POE (Power over Ethernet):

BRAND:	3Com
MODEL:	PW130RA4800N02
INPUT:	AC100-250V, 0.5A, 50/60Hz
OUTPUT:	DC 48V, 0.42A

2. The EUT operates in the 5GHz Bands and compatibility with 802.11a technology.
3. This EUT is capable of providing data rates of up to 108 Mbps in 802.11a Turbo mode depending upon reception quality.



4. There are four antennas and three antenna cables provided to this EUT, please refer to the following table:

Antenna				
No.	Model	Antnnna Type	2.4/ 5GHz Antenna Gain	Connector Type
1	3CWE591 (Z1996)	High gain omni antenna	6/ 8 dBi	N Female
2	3CWE598 (Z1997)	Medium gain panel antenna	8/ 10 dBi	N Female
3	3CWE596	High gain panel antenna	18/ 20 dBi	N Female
4	3CWE502	Small Omni (Rubber Duck)	2.5/ 2.5 dBi	SMA Male
Antenna cable				
No.	Model	Cable Length	2.4/ 5GHz Cable Loss	Connector Type
1	3CWE580	6 ft ULL antenna cable	-0.6/ -1.2 dB	SMA to N
2	3CWE581	20 ft ULL antenna cable	-2/ -4 dB	SMA to N
3	3CWE582	50ft ULL antenna cable	-5/-10 dB	SMA to N
Note:				
1. Antenna 2 and 3 can only be used in point-to-point applications.				

5. The EUT was tested under the following test modes:

Conduction Test	
Test Mode	Description
Mode 1	EUT + 3CWE580 + 3CWE591 (Z1996) (8 dBi)
Mode 2	EUT + 3CWE580 + 3CWE598 (Z1997) (10dBi)
Mode 3	EUT + 3CWE580 + 3CWE596 (20dBi)
Mode 4	EUT + 3CWE502 (2.5dBi)

6. The above EUT information was declared by the manufacturer and for more detailed features description, please refer to the manufacturer's specifications or User's Manual.

3.2 DESCRIPTION OF TEST MODES

Operated in 5725 ~ 5850MHz band:

For 802.11a (5725 ~ 5850MHz band): Five channels are provided to this EUT.

Channel	Frequency
1	5745 MHz
2	5765 MHz
3	5785 MHz
4	5805 MHz
5	5825 MHz

For 802.11a turbo mode (5725 ~ 5850MHz band): Two channels are provided to this EUT.

Channel	Frequency
1	5760 MHz
2	5800 MHz



3.2.1 TEST MODE APPLICABILITY AND TESTED CHANNEL DETAIL:

EUT configure mode	Applicable to				Description
	PLC	RE<1G	RE≥1G	APCM	
-	X	X	X	X	NA

Where PLC: Power Line Conducted Emission RE<1G RE: Radiated Emission below 1GHz
 RE≥1G: Radiated Emission above 1GHz APCM: Antenna Port Conducted Measurement

Power Line Conducted Emission Test:

- Pre-Scan has been conducted to determine the worst-case mode from all possible combinations between available modulations, data rates and antenna ports (if EUT with antenna diversity architecture).
- Following channel(s) was (were) selected for the final test as listed below.

Mode	Available Channel	Tested Channel	Modulation Technology	Modulation Type	Data Rate (Mbps)
802.11a	1 to 5	3	OFDM	BPSK	6

Radiated Emission Test (Below 1 GHz):

- Pre-Scan has been conducted to determine the worst-case mode from all possible combinations between available modulations, data rates and antenna ports (if EUT with antenna diversity architecture).
- Following channel(s) was (were) selected for the final test as listed below.

Mode	Available Channel	Tested Channel	Modulation Technology	Modulation Type	Data Rate (Mbps)
802.11a	1 to 5	3	OFDM	BPSK	6

Radiated Emission Test (Above 1 GHz):

- Pre-Scan has been conducted to determine the worst-case mode from all possible combinations between available modulations, data rates and antenna ports (if EUT with antenna diversity architecture).
- Following channel(s) was (were) selected for the final test as listed below.

Mode	Available Channel	Tested Channel	Modulation Technology	Modulation Type	Data Rate (Mbps)
802.11a	1 to 5	1, 5	OFDM	BPSK	6
802.11a turbo	1, 2	1, 2	OFDM	BPSK	12



Bandedge Measurement:

- Pre-Scan has been conducted to determine the worst-case mode from all possible combinations between available modulations, data rates and antenna ports (if EUT with antenna diversity architecture).
- Following channel(s) was (were) selected for the final test as listed below.

Mode	Available Channel	Tested Channel	Modulation Technology	Modulation Type	Data Rate (Mbps)
802.11a	1 to 5	1, 5	OFDM	BPSK	6
802.11a turbo	1, 2	1, 2	OFDM	BPSK	12

Antenna Port Conducted Measurement:

- Pre-Scan has been conducted to determine the worst-case mode from all possible combinations between available modulations, data rates and antenna ports (if EUT with antenna diversity architecture).
- Following channel(s) was (were) selected for the final test as listed below.

Mode	Available Channel	Tested Channel	Modulation Technology	Modulation Type	Data Rate (Mbps)
802.11a	1 to 5	1, 5	OFDM	BPSK	6
802.11a turbo	1, 2	1, 2	OFDM	BPSK	12



3.3 GENERAL DESCRIPTION OF APPLIED STANDARDS

The EUT is a Bridging kit - 802.11a. According to the specifications of the manufacturer, it must comply with the requirements of the following standards:

FCC Part 15, Subpart C. (15.247)

ANSI C63.4-2003

All test items have been performed and recorded as per the above standards.

NOTE: The EUT is also considered as a kind of computer peripheral, because the connection to computer is necessary for typical use. It has been verified to comply with the requirements of FCC Part 15, Subpart B, Class B (DoC). The test report has been issued separately.



3.4 DESCRIPTION OF SUPPORT UNITS

The EUT has been tested as an independent unit together with other necessary accessories or support units. The following support units or accessories were used to form a representative test configuration during the tests.

NO.	PRODUCT	BRAND	MODEL NO.	SERIAL NO.	FCC ID
1	AP	3Com	AP8850	NA	NA
2	NOTEBOOK COMPUTER	DELL	PP01L	TW-09c748- 12800-165-3171	FCC DoC

NO.	SIGNAL CABLE DESCRIPTION OF THE ABOVE SUPPORT UNITS
1	NA
2	NA

NOTE: All power cords of the above support units are non shielded (1.8m).

3.5 CONFIGURATION OF SYSTEM UNDER TEST

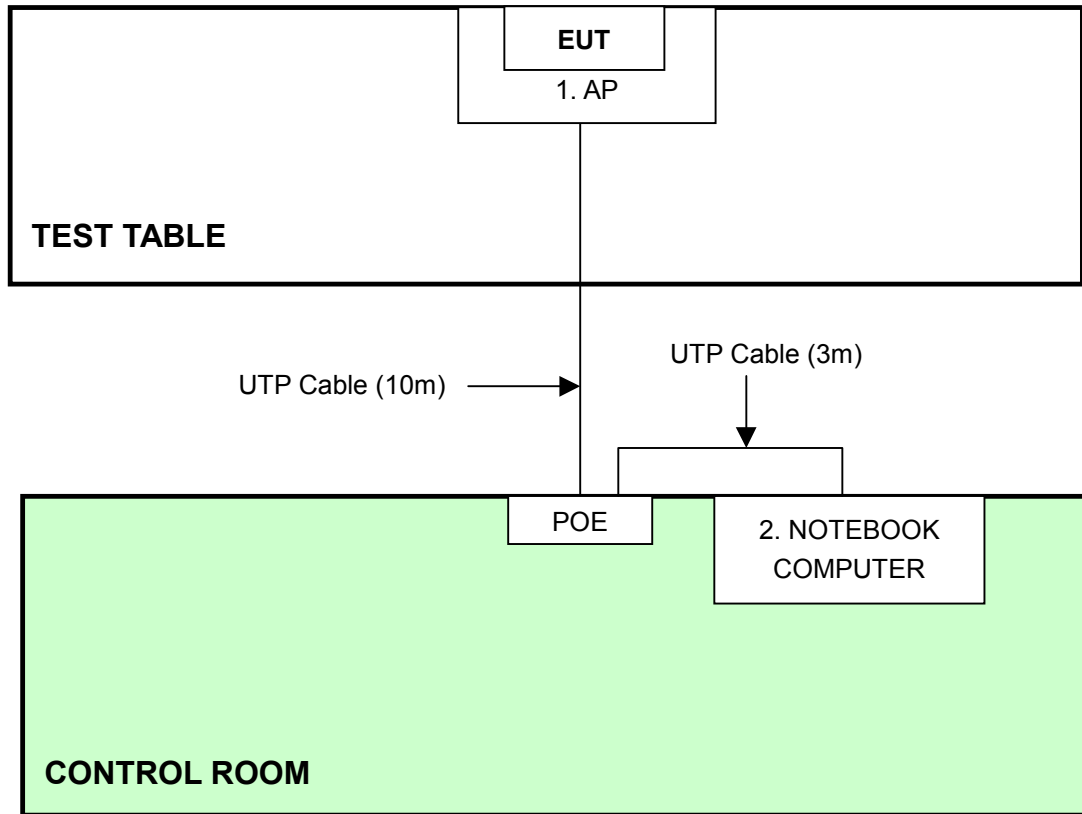

- NOTE:** 1. Support unit 2 was kept in the control room during the test.
2. Please refer to the photos of test configuration in Item 5 also.



4. TEST TYPES AND RESULTS (802.11a, 5725~5850MHz Band)

4.1 CONDUCTED EMISSION MEASUREMENT

4.1.1 LIMITS OF CONDUCTED EMISSION MEASUREMENT

FREQUENCY OF EMISSION (MHz)	CONDUCTED LIMIT (dB μ V)	
	Quasi-peak	Average
0.15-0.5	66 to 56	56 to 46
0.5-5	56	46
5-30	60	50

- NOTE:**
- The lower limit shall apply at the transition frequencies.
 - The limit decreases in line with the logarithm of the frequency in the range of 0.15 to 0.50 MHz.
 - All emanations from a class A/B digital device or system, including any network of conductors and apparatus connected thereto, shall not exceed the level of field strengths specified above.

4.1.2 TEST INSTRUMENTS

DESCRIPTION & MANUFACTURER	MODEL NO.	SERIAL NO.	CALIBRATED UNTIL
ROHDE & SCHWARZ Test Receiver	ESCS 30	847124/029	Dec. 07, 2005
ROHDE & SCHWARZ LISN (for EUT)	ESHS-Z5	848773/004	Nov. 08, 2005
KYORITSU LISN (for peripheral)	KNW-407	8/1395/12	Jul. 23, 2005
RF Cable (JETBAO)	RG233/U	Cable_CA_01	Jul. 02, 2005
Terminator(for KYORITSU)	50	3	Oct. 12, 2005
Software	Cond-V2e	NA	NA

- NOTE:**
- The calibration interval of the above test instruments is 12 months and the calibrations are traceable to NML/ROC and NIST/USA.
 - The test was performed in ADT Shielded Room No. A.
 - The VCCI Con A Registration No. is C-817.
 - The measurement uncertainty is 2.53 dB, which is calculated as per the document CISPR 16-4



4.1.3 TEST PROCEDURES

- a. The EUT was placed 0.4 meters from the conducting wall of the shielded room with EUT being connected to the power mains through a line impedance stabilization network (LISN). Other support units were connected to the power mains through another LISN. The two LISNs
- b. provide 50 ohm/ 50uH of coupling impedance for the measuring instrument.
- c. Both lines of the power mains connected to the EUT were checked for maximum conducted interference.
- d. The frequency range from 150kHz to 30MHz was searched. Emission levels under (Limit – 20dB) was not recorded.

4.1.4 DEVIATION FROM TEST STANDARD

No deviation

4.1.5 TEST SETUP

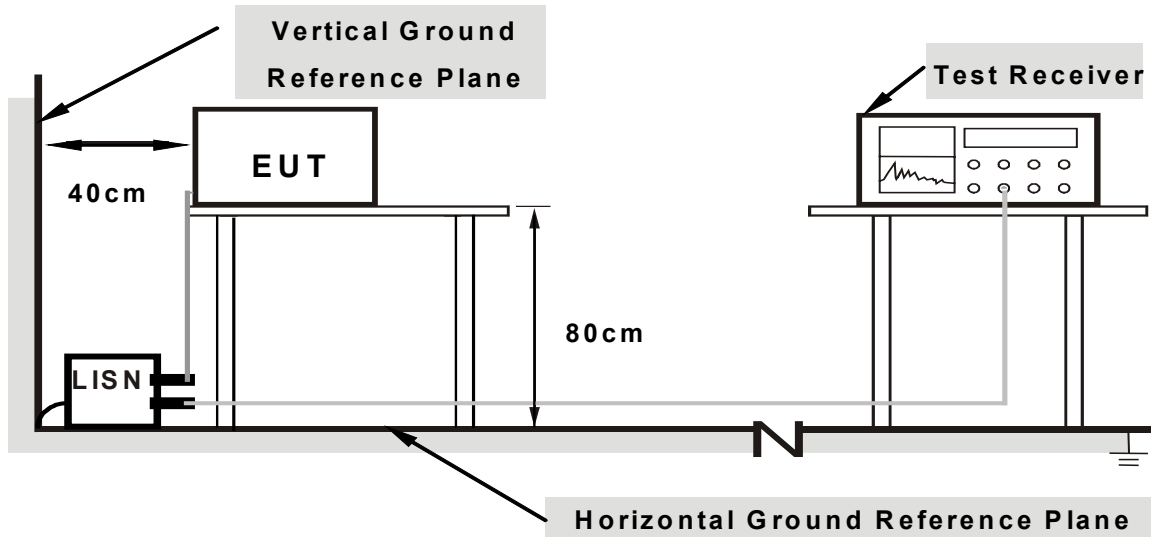

Note: 1. Support units were connected to second LISN.

2. Both of LISNs (AMN) are 80 cm from EUT and at least 80 from other units and other metal planes

For the actual test configuration, please refer to the related item – Photographs of the Test Configuration.

4.1.6 EUT OPERATING CONDITIONS

- a. Plug the EUT into the support unit 1 (AP) which placed on a testing table.
- b. Prepared another computer system to act as a communication partner and placed it outside of testing area.
- c. The communication partner run test program “Art 4.5 B6” to enable EUT under transmission/receiving condition continuously at specific channel frequency via UTP cable.



4.1.7 TEST RESULTS (Mode 1)

Conducted Worst-Case Data

EUT	Bridging kit - 802.11a	MODEL	WL-464
CHANNEL	Channel 3	6dB BANDWIDTH	9 kHz
MODULATION TYPE	BPSK	TRANSFER RATE	6Mbps
INPUT POWER (SYSTEM)	120Vac, 60 Hz	PHASE	Line (L)
ENVIRONMENTAL CONDITIONS	25deg. C, 70%RH, 960hPa	TESTED BY	Rex Huang

No	Freq. [MHz]	Corr. Factor (dB)	Reading Value [dB (uV)]		Emission Level [dB (uV)]		Limit [dB (uV)]		Margin (dB)	
			Q.P.	AV.	Q.P.	AV.	Q.P.	AV.	Q.P.	AV.
			1	0.205	0.15	35.60	-	35.75	-	63.42
2	0.408	0.17	38.16	-	38.33	-	57.69	47.69	-19.36	-
3	1.197	0.21	39.05	-	39.26	-	56.00	46.00	-16.74	-
4	1.498	0.22	42.70	-	42.92	-	56.00	46.00	-13.08	-
5	12.191	0.86	31.66	-	32.52	-	60.00	50.00	-27.48	-
6	16.227	1.07	36.67	-	37.74	-	60.00	50.00	-22.26	-

- REMARKS:**
1. Q.P. and AV. are abbreviations of quasi-peak and average individually.
 2. "-": The Quasi-peak reading value also meets average limit and measurement with the average detector is unnecessary.
 3. The emission levels of other frequencies were very low against the limit.
 4. Margin value = Emission level - Limit value
 5. Correction factor = Insertion loss + Cable loss
 6. Emission Level = Correction Factor + Reading Value.

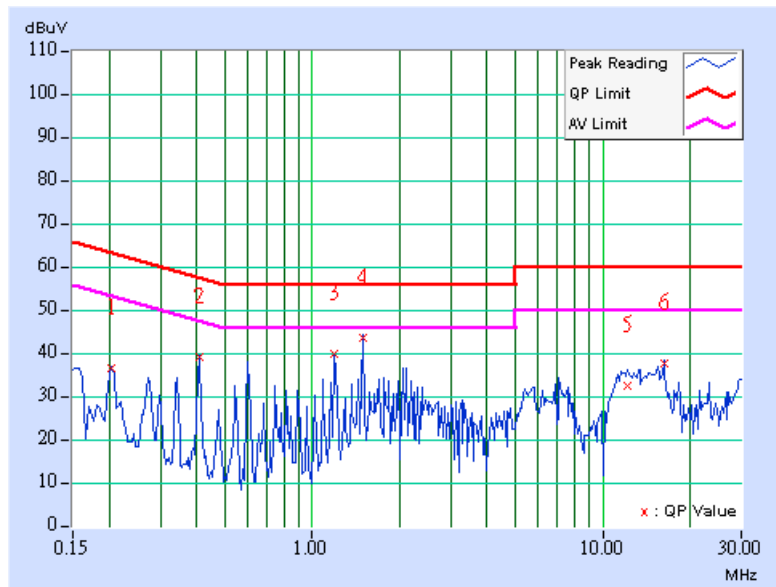



EUT	Bridging kit - 802.11a	MODEL	WL-464
CHANNEL	Channel 3	6dB BANDWIDTH	9 kHz
MODULATION TYPE	BPSK	TRANSFER RATE	6Mbps
INPUT POWER (SYSTEM)	120Vac, 60 Hz	PHASE	Neutral (N)
ENVIRONMENTAL CONDITIONS	25deg. C, 70%RH, 960hPa	TESTED BY	Rex Huang

No	Freq. [MHz]	Corr. Factor (dB)	Reading Value [dB (uV)]		Emission Level [dB (uV)]		Limit [dB (uV)]		Margin (dB)	
			Q.P.	AV.	Q.P.	AV.	Q.P.	AV.	Q.P.	AV.
			1	0.154	0.14	35.99	-	36.13	-	65.79
2	0.408	0.17	38.12	-	38.29	-	57.69	47.69	-19.40	-
3	1.197	0.21	38.53	-	38.74	-	56.00	46.00	-17.26	-
4	1.498	0.22	42.76	-	42.98	-	56.00	46.00	-13.02	-
5	11.586	0.73	33.02	-	33.75	-	60.00	50.00	-26.25	-
6	16.227	0.95	40.41	-	41.36	-	60.00	50.00	-18.64	-

- REMARKS:**
1. Q.P. and AV. are abbreviations of quasi-peak and average individually.
 2. "-": The Quasi-peak reading value also meets average limit and measurement with the average detector is unnecessary.
 3. The emission levels of other frequencies were very low against the limit.
 4. Margin value = Emission level - Limit value
 5. Correction factor = Insertion loss + Cable loss
 6. Emission Level = Correction Factor + Reading Value.

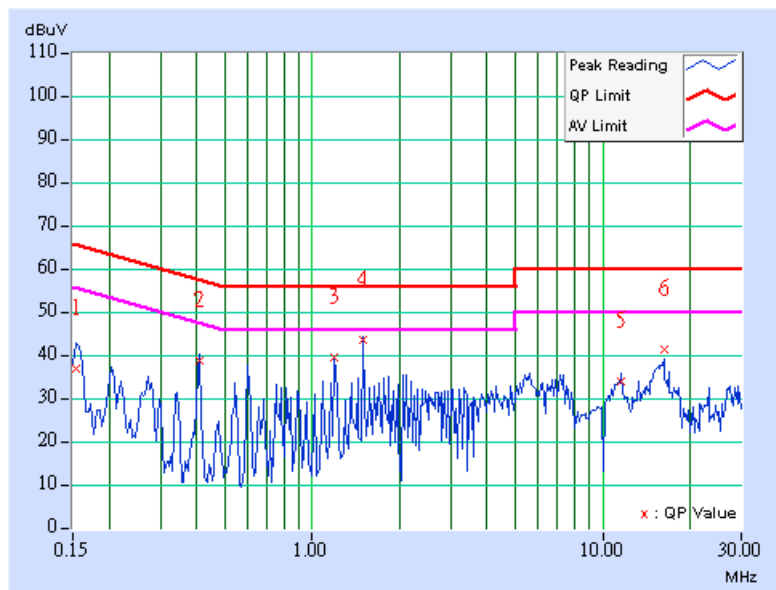



4.1.8 TEST RESULTS (Mode 2)

Conducted Worst-Case Data

EUT	Bridging kit - 802.11a	MODEL	WL-464
CHANNEL	Channel 3	6dB BANDWIDTH	9 kHz
MODULATION TYPE	BPSK	TRANSFER RATE	6Mbps
INPUT POWER (SYSTEM)	120Vac, 60 Hz	PHASE	Line (L)
ENVIRONMENTAL CONDITIONS	25deg. C, 70%RH, 960hPa	TESTED BY	Rex Huang

No	Freq. [MHz]	Corr. Factor (dB)	Reading Value [dB (uV)]		Emission Level [dB (uV)]		Limit [dB (uV)]		Margin (dB)	
			Q.P.	AV.	Q.P.	AV.	Q.P.	AV.	Q.P.	AV.
			1	0.205	0.15	35.04	-	35.19	-	63.42
2	0.408	0.17	38.14	-	38.31	-	57.69	47.69	-19.38	-
3	1.197	0.21	38.93	-	39.14	-	56.00	46.00	-16.86	-
4	1.494	0.22	43.00	-	43.22	-	56.00	46.00	-12.78	-
5	11.824	0.84	7.43	-	8.27	-	60.00	50.00	-51.73	-
6	15.430	1.02	27.07	-	28.09	-	60.00	50.00	-31.91	-

- REMARKS:**
1. Q.P. and AV. are abbreviations of quasi-peak and average individually.
 2. "-": The Quasi-peak reading value also meets average limit and measurement with the average detector is unnecessary.
 3. The emission levels of other frequencies were very low against the limit.
 4. Margin value = Emission level - Limit value
 5. Correction factor = Insertion loss + Cable loss
 6. Emission Level = Correction Factor + Reading Value.

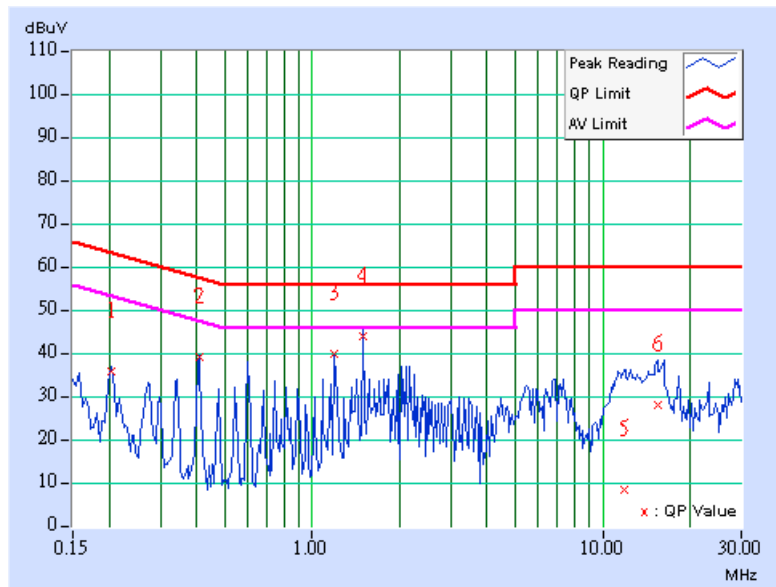



EUT	Bridging kit - 802.11a	MODEL	WL-464
CHANNEL	Channel 3	6dB BANDWIDTH	9 kHz
MODULATION TYPE	BPSK	TRANSFER RATE	6Mbps
INPUT POWER (SYSTEM)	120Vac, 60 Hz	PHASE	Neutral (N)
ENVIRONMENTAL CONDITIONS	25deg. C, 70%RH, 960hPa	TESTED BY	Rex Huang

No	Freq. [MHz]	Corr. Factor (dB)	Reading Value [dB (uV)]		Emission Level [dB (uV)]		Limit [dB (uV)]		Margin (dB)	
			Q.P.	AV.	Q.P.	AV.	Q.P.	AV.	Q.P.	AV.
			1	0.158	0.14	35.31	-	35.45	-	65.58
2	0.408	0.17	37.98	-	38.15	-	57.69	47.69	-19.54	-
3	1.197	0.21	38.47	-	38.68	-	56.00	46.00	-17.32	-
4	1.498	0.22	42.72	-	42.94	-	56.00	46.00	-13.06	-
5	6.883	0.55	33.12	-	33.67	-	60.00	50.00	-26.33	-
6	16.230	0.95	39.05	-	40.00	-	60.00	50.00	-20.00	-

- REMARKS:**
1. Q.P. and AV. are abbreviations of quasi-peak and average individually.
 2. "-": The Quasi-peak reading value also meets average limit and measurement with the average detector is unnecessary.
 3. The emission levels of other frequencies were very low against the limit.
 4. Margin value = Emission level - Limit value
 5. Correction factor = Insertion loss + Cable loss
 6. Emission Level = Correction Factor + Reading Value.

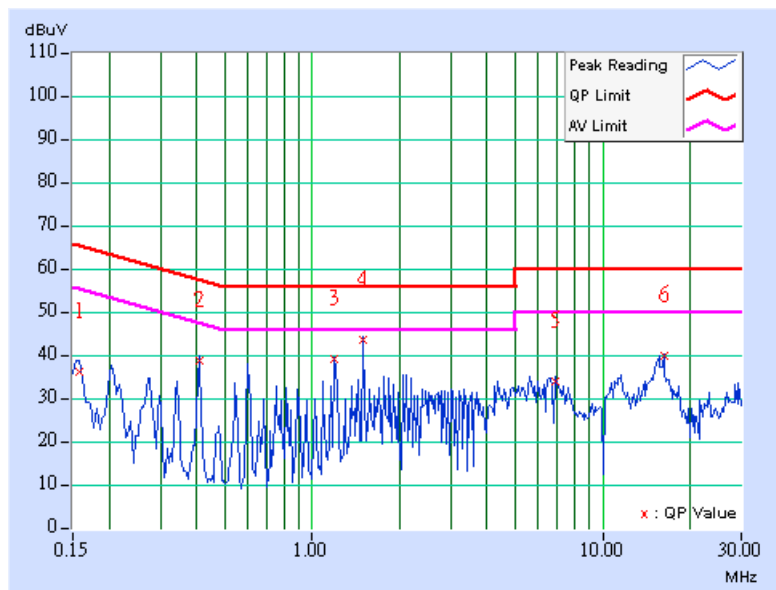



4.1.9 TEST RESULTS (Mode 3)

Conducted Worst-Case Data

EUT	Bridging kit - 802.11a	MODEL	WL-464
CHANNEL	Channel 3	6dB BANDWIDTH	9 kHz
MODULATION TYPE	BPSK	TRANSFER RATE	6Mbps
INPUT POWER (SYSTEM)	120Vac, 60 Hz	PHASE	Line (L)
ENVIRONMENTAL CONDITIONS	25deg. C, 70%RH, 960hPa	TESTED BY	Rex Huang

No	Freq. [MHz]	Corr. Factor (dB)	Reading Value		Emission Level		Limit		Margin	
			[dB (uV)]		[dB (uV)]		[dB (uV)]		(dB)	
			Q.P.	AV.	Q.P.	AV.	Q.P.	AV.	Q.P.	AV.
1	0.205	0.15	35.94	-	36.09	-	63.42	53.42	-27.33	-
2	0.205	0.15	35.32	-	35.47	-	63.42	53.42	-27.95	-
3	0.408	0.17	38.08	-	38.25	-	57.69	47.69	-19.44	-
4	1.197	0.21	38.99	-	39.20	-	56.00	46.00	-16.80	-
5	1.494	0.22	42.46	-	42.68	-	56.00	46.00	-13.32	-
6	11.914	0.84	29.61	-	30.45	-	60.00	50.00	-29.55	-
7	15.250	1.01	32.87	-	33.88	-	60.00	50.00	-26.12	-

- REMARKS:**
1. Q.P. and AV. are abbreviations of quasi-peak and average individually.
 2. "-": The Quasi-peak reading value also meets average limit and measurement with the average detector is unnecessary.
 3. The emission levels of other frequencies were very low against the limit.
 4. Margin value = Emission level - Limit value
 5. Correction factor = Insertion loss + Cable loss
 6. Emission Level = Correction Factor + Reading Value.

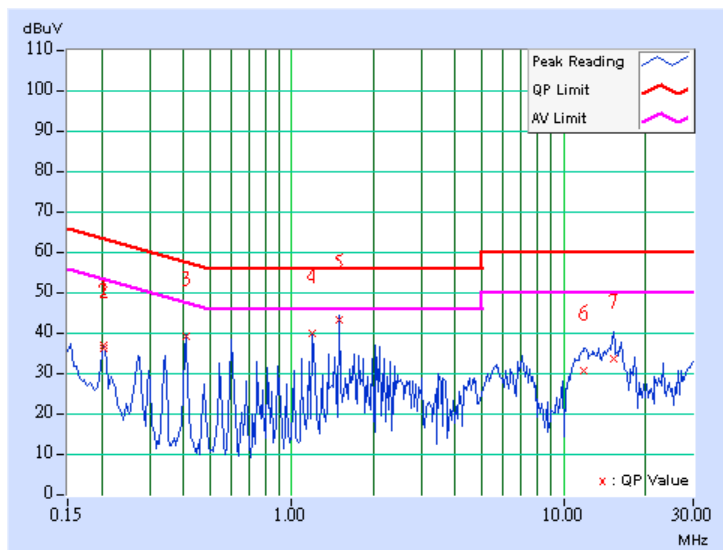



EUT	Bridging kit - 802.11a	MODEL	WL-464
CHANNEL	Channel 3	6dB BANDWIDTH	9 kHz
MODULATION TYPE	BPSK	TRANSFER RATE	6Mbps
INPUT POWER (SYSTEM)	120Vac, 60 Hz	PHASE	Neutral (N)
ENVIRONMENTAL CONDITIONS	25deg. C, 70%RH, 960hPa	TESTED BY	Rex Huang

No	Freq. [MHz]	Corr. Factor (dB)	Reading Value [dB (uV)]		Emission Level [dB (uV)]		Limit [dB (uV)]		Margin (dB)	
			Q.P.	AV.	Q.P.	AV.	Q.P.	AV.	Q.P.	AV.
			1	0.158	0.14	36.21	-	36.35	-	65.58
2	0.408	0.17	37.94	-	38.11	-	57.69	47.69	-19.58	-
3	1.197	0.21	38.43	-	38.64	-	56.00	46.00	-17.36	-
4	1.498	0.22	42.66	-	42.88	-	56.00	46.00	-13.12	-
5	6.887	0.55	33.94	-	34.49	-	60.00	50.00	-25.51	-
6	16.227	0.95	40.35	-	41.30	-	60.00	50.00	-18.70	-

- REMARKS:**
1. Q.P. and AV. are abbreviations of quasi-peak and average individually.
 2. "-": The Quasi-peak reading value also meets average limit and measurement with the average detector is unnecessary.
 3. The emission levels of other frequencies were very low against the limit.
 4. Margin value = Emission level - Limit value
 5. Correction factor = Insertion loss + Cable loss
 6. Emission Level = Correction Factor + Reading Value.

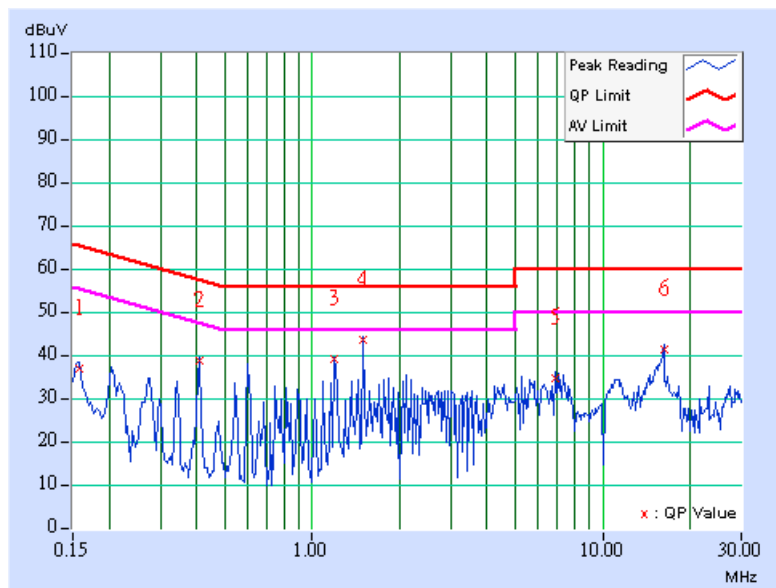



4.1.10 TEST RESULTS (Mode 4)

Conducted Worst-Case Data

EUT	Bridging kit - 802.11a	MODEL	WL-464
CHANNEL	Channel 3	6dB BANDWIDTH	9 kHz
MODULATION TYPE	BPSK	TRANSFER RATE	6Mbps
INPUT POWER (SYSTEM)	120Vac, 60 Hz	PHASE	Line (L)
ENVIRONMENTAL CONDITIONS	25deg. C, 70%RH, 960hPa	TESTED BY	Rex Huang

No	Freq. [MHz]	Corr. Factor (dB)	Reading Value [dB (uV)]		Emission Level [dB (uV)]		Limit [dB (uV)]		Margin (dB)	
			Q.P.	AV.	Q.P.	AV.	Q.P.	AV.	Q.P.	AV.
			1	0.205	0.15	35.94	-	36.09	-	63.42
2	0.205	0.15	35.32	-	35.47	-	63.42	53.42	-27.95	-
3	0.408	0.17	38.08	-	38.25	-	57.69	47.69	-19.44	-
4	1.197	0.21	38.99	-	39.20	-	56.00	46.00	-16.80	-
5	1.494	0.22	42.46	-	42.68	-	56.00	46.00	-13.32	-
6	11.914	0.84	29.61	-	30.45	-	60.00	50.00	-29.55	-
7	15.250	1.01	32.87	-	33.88	-	60.00	50.00	-26.12	-

- REMARKS:**
1. Q.P. and AV. are abbreviations of quasi-peak and average individually.
 2. "-": The Quasi-peak reading value also meets average limit and measurement with the average detector is unnecessary.
 3. The emission levels of other frequencies were very low against the limit.
 4. Margin value = Emission level - Limit value
 5. Correction factor = Insertion loss + Cable loss
 6. Emission Level = Correction Factor + Reading Value.

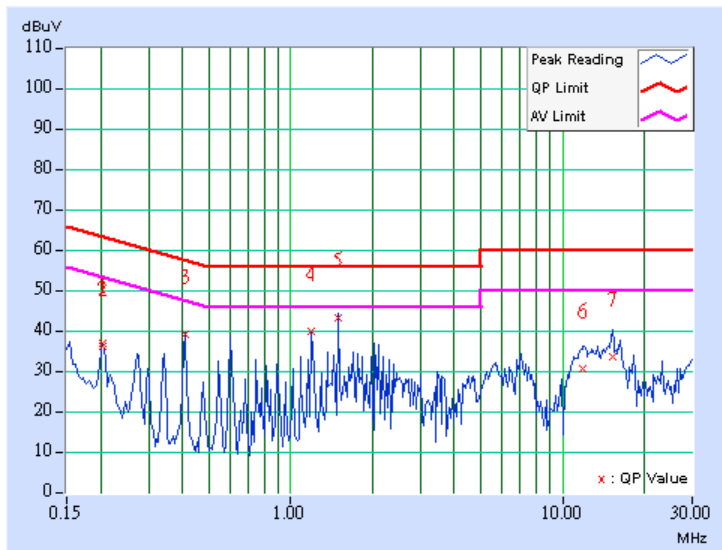



EUT	Bridging kit - 802.11a	MODEL	WL-464
CHANNEL	Channel 3	6dB BANDWIDTH	9 kHz
MODULATION TYPE	BPSK	TRANSFER RATE	6Mbps
INPUT POWER (SYSTEM)	120Vac, 60 Hz	PHASE	Neutral (N)
ENVIRONMENTAL CONDITIONS	25deg. C, 70%RH, 960hPa	TESTED BY	Rex Huang

No	Freq. [MHz]	Corr. Factor (dB)	Reading Value [dB (uV)]		Emission Level [dB (uV)]		Limit [dB (uV)]		Margin (dB)	
			Q.P.	AV.	Q.P.	AV.	Q.P.	AV.	Q.P.	AV.
			1	0.158	0.14	36.21	-	36.35	-	65.58
2	0.408	0.17	37.94	-	38.11	-	57.69	47.69	-19.58	-
3	1.197	0.21	38.43	-	38.64	-	56.00	46.00	-17.36	-
4	1.498	0.22	42.66	-	42.88	-	56.00	46.00	-13.12	-
5	6.887	0.55	33.94	-	34.49	-	60.00	50.00	-25.51	-
6	16.227	0.95	40.35	-	41.30	-	60.00	50.00	-18.70	-

- REMARKS:**
1. Q.P. and AV. are abbreviations of quasi-peak and average individually.
 2. "-": The Quasi-peak reading value also meets average limit and measurement with the average detector is unnecessary.
 3. The emission levels of other frequencies were very low against the limit.
 4. Margin value = Emission level - Limit value
 5. Correction factor = Insertion loss + Cable loss
 6. Emission Level = Correction Factor + Reading Value.

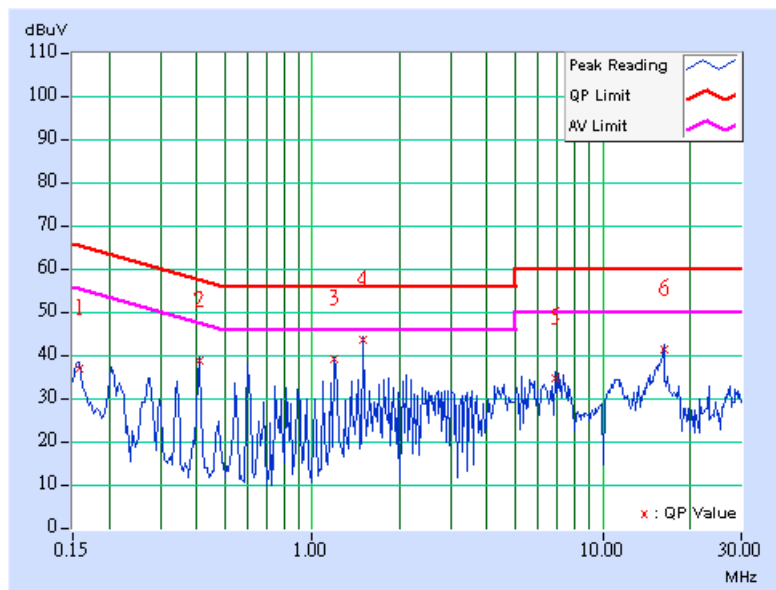



4.2 RADIATED EMISSION MEASUREMENT

4.2.1 LIMITS OF RADIATED EMISSION MEASUREMENT

Emissions radiated outside of the specified bands, shall be according to the general radiated limits in 15.209 as following:

Frequencies (MHz)	Field strength (microvolts/meter)	Measurement distance (meters)
0.009-0.490	2400/F(kHz)	300
0.490-1.705	24000/F(kHz)	30
1.705-30.0	30	30
30-88	100	3
88-216	150	3
216-960	200	3
Above 960	500	3

NOTE:

1. The lower limit shall apply at the transition frequencies.
2. Emission level (dBuV/m) = 20 log Emission level (uV/m).
3. As shown in 15.35(b), for frequencies above 1000MHz, the field strength limits are based on average detector, however, the peak field strength of any emission shall not exceed the maximum permitted average limits, specified above by more than 20dB under any condition of modulation.



4.2.2 TEST INSTRUMENTS

DESCRIPTION & MANUFACTURER	MODEL NO.	SERIAL NO.	CALIBRATED UNTIL
HP Spectrum Analyzer	8594E	3710A04861	Sep. 23, 2005
ADVANTEST Spectrum Analyzer	R3271A	85060311	Jun. 29, 2005
CHASE RF Pre_Amplifier	CPA9232	1057	Aug 06, 2005
HP Pre_Amplifier	8449B	3008A01922	Oct. 13, 2005
ROHDE & SCHWARZ Test Receiver	ESCS30	100287	Dec. 08, 2005
CHASE Broadband Antenna	VULB9168	138	Dec. 21, 2005
Schwarzbeck Horn_Antenna	BBHA9120	D124	Jun. 16, 2005
Schwarzbeck Horn_Antenna	BBHA 9170	BBHA9170153	Jan. 30, 2006
SCHWARZBECK Biconical Antenna	VHBA9123	459	Jun. 26, 2006
SCHWARZBECK Tunable Periodic Antenna	UPA6108	1148	Jun. 26, 2006
RF Switches (ARNITSU)	CS-201	1565157	Jul. 15, 2005
RF CABLE (Chaintek) 1GHz-20GHz	SF102	22054-2	Nov. 15, 2005
RF Cable(RICHTEC)	9913-30M	STCCAB-30M-1GHz-021	Jul. 15, 2005
Software	ADT_Radiated_V 5.14	NA	NA
CHANCE MOST Antenna Tower	AT-100	0203	NA
CHANCE MOST Turn Table	TT-100	0203	NA

Note: 1. The calibration interval of the above test instruments is 12 months (36 months for Tunable Periodic Antenna) and the calibrations are traceable to NML/ROC and NIST/USA.

2. The horn antenna and HP preamplifier (model: 8449B) are used only for the measurement of emission frequency above 1GHz if tested.
3. The test was performed in ADT Open Site No. C.
4. The FCC Site Registration No. is 656396.
5. The VCCI Site Registration No. is R-1626.
6. The CANADA Site Registration No. is IC 4824-3.
7. The following table is for the measurement uncertainty, which is calculated as per the document CISPR 16-4.

Measurement	Value
Radiated emissions (30MHz-1GHz)	2.98 dB
Radiated emissions (1GHz ~18GHz)	2.21 dB
Radiated emissions (18GHz ~20GHz)	1.88 dB



4.2.3 TEST PROCEDURES

- a. The EUT was placed on the top of a rotating table 0.8 meters above the ground at a 3 meter semi-anechoic chamber. The table was rotated 360 degrees to determine the position of the highest radiation.
- b. The EUT was set 3 meters away from the interference-receiving antenna, which was mounted on the top of a variable-height antenna tower.
- c. The antenna is a broadband antenna, and its height is varied from one meter to four meters above the ground to determine the maximum value of the field strength. Both horizontal and vertical polarizations of the antenna are set to make the measurement.
- d. For each suspected emission, the EUT was arranged to its worst case and then the antenna was tuned to heights from 1 meter to 4 meters and the rotatable table was turned from 0 degrees to 360 degrees to find the maximum reading.
- e. The test-receiver system was set to Peak Detect Function and Specified Bandwidth with Maximum Hold Mode.
- f. If the emission level of the EUT in peak mode was 10dB lower than the limit specified, then testing could be stopped and the peak values of the EUT would be reported. Otherwise the emissions that did not have 10dB margin would be re-tested one by one using peak, quasi-peak or average method as specified and then reported in a data sheet.

NOTE:

1. The resolution bandwidth and video bandwidth of test receiver/spectrum analyzer is 120kHz for Peak detection (PK) and Quasi-peak detection (QP) at frequency below 1GHz.
2. The resolution bandwidth and video bandwidth of test receiver/spectrum analyzer is 1 MHz for Peak detection at frequency above 1GHz.
3. The resolution bandwidth of test receiver/spectrum analyzer is 1 MHz and the video bandwidth is 10 Hz for Average detection (AV) at frequency above 1GHz.

4.2.4 DEVIATION FROM TEST STANDARD

No deviation

4.2.5 TEST SETUP

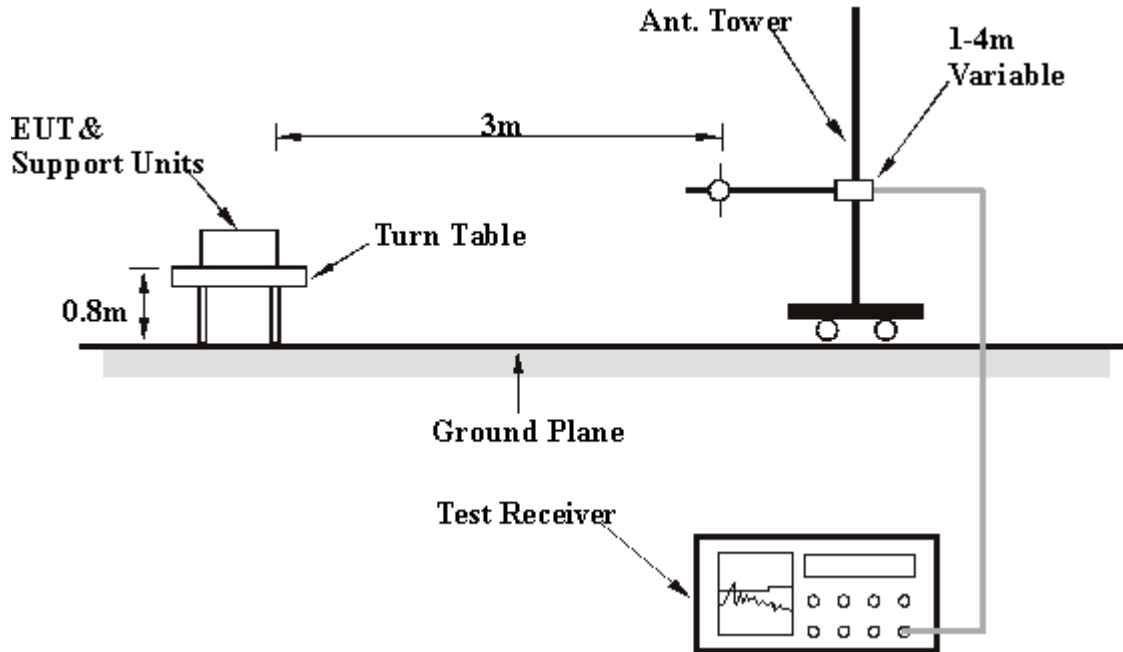

For the actual test configuration, please refer to the related item – Photographs of the Test Configuration.

4.2.6 EUT OPERATING CONDITIONS

Same as 4.1.6

4.2.7 TEST RESULTS (MODE 1)

Below 1GHz Worst-Case Data

EUT	Bridging kit - 802.11a	MODEL	WL-464
CHANNEL	Channel 3	FREQUENCY RANGE	Below 1000MHz
MODULATION TYPE	BPSK	TRANSFER RATE	6Mbps
INPUT POWER (SYSTEM)	120Vac, 60 Hz	DETECTOR FUNCTION	Quasi-Peak
ENVIRONMENTAL CONDITIONS	27deg. C, 57%RH, 960hPa	TESTED BY	Tony Chen

ANTENNA POLARITY & TEST DISTANCE: HORIZONTAL AT 3 M

No.	Freq. (MHz)	Emission Level (dBuV/m)	Limit (dBuV/m)	Margin (dB)	Antenna Height (m)	Table Angle (Degree)	Raw Value (dBuV)	Correction Factor (dB/m)
1	79.90	19.30 QP	40.00	-20.70	1.20 H	102	9.40	9.90
2	160.00	23.20 QP	43.50	-20.30	1.02 H	36	9.50	13.80
3	250.00	35.00 QP	46.00	-11.00	1.29 H	103	21.70	13.30
4	299.99	23.60 QP	46.00	-22.40	2.01 H	230	7.30	16.30
5	400.00	28.00 QP	46.00	-18.00	1.54 H	148	9.60	18.40
6	500.01	28.10 QP	46.00	-17.90	1.63 H	60	7.20	20.90
7	639.90	25.70 QP	46.00	-20.30	1.86 H	306	1.80	23.90

ANTENNA POLARITY & TEST DISTANCE: VERTICAL AT 3 M

No.	Freq. (MHz)	Emission Level (dBuV/m)	Limit (dBuV/m)	Margin (dB)	Antenna Height (m)	Table Angle (Degree)	Raw Value (dBuV)	Correction Factor (dB/m)
1	80.00	21.20 QP	40.00	-18.80	1.04 V	7	11.40	9.90
2	125.00	25.90 QP	43.50	-17.60	1.05 V	24	14.00	11.90
3	200.00	22.30 QP	43.50	-21.20	1.32 V	65	11.10	11.20
4	250.00	33.50 QP	46.00	-12.50	1.76 V	326	20.20	13.30
5	400.00	24.10 QP	46.00	-21.90	1.00 V	201	5.70	18.40
6	480.00	22.00 QP	46.00	-24.00	1.26 V	13	1.50	20.40
7	500.00	27.40 QP	46.00	-18.60	1.08 V	279	6.60	20.90
8	624.99	26.90 QP	46.00	-19.10	1.54 V	24	3.20	23.80

- REMARKS:**
1. Emission level(dBuV/m)=Raw Value(dBuV) + Correction Factor(dB/m)
 2. Correction Factor(dB/m) = Antenna Factor (dB/m) + Cable Factor (dB)
 3. The other emission levels were very low against the limit.
 4. Margin value = Emission level – Limit value

**802.11a OFDM modulation**

EUT	Bridging kit - 802.11a	MODEL	WL-464
CHANNEL	Channel 1	FREQUENCY RANGE	1 ~ 40 GHz
MODULATION TYPE	BPSK	TRANSFER RATE	6Mbps
INPUT POWER (SYSTEM)	120Vac, 60 Hz	DETECTOR FUNCTION	Peak(PK) Average (AV)
ENVIRONMENTAL CONDITIONS	20deg. C, 65%RH, 960hPa	TESTED BY	Rex Huang

ANTENNA POLARITY & TEST DISTANCE: HORIZONTAL AT 3 M

No.	Freq. (MHz)	Emission Level (dBuV/m)	Limit (dBuV/m)	Margin (dB)	Antenna Height (m)	Table Angle (Degree)	Raw Value (dBuV)	Correction Factor (dB/m)
1	*5745.00	100.70 PK			1.89 H	301	64.20	36.40
1	*5745.00	91.80 AV			1.89 H	301	55.40	36.40
2	#11490.00	55.80 PK	74.00	-18.20	1.74 H	336	4.70	51.10
2	#11490.00	44.50 AV	54.00	-9.50	1.74 H	336	-6.60	51.10

ANTENNA POLARITY & TEST DISTANCE: VERTICAL AT 3 M

No.	Freq. (MHz)	Emission Level (dBuV/m)	Limit (dBuV/m)	Margin (dB)	Antenna Height (m)	Table Angle (Degree)	Raw Value (dBuV)	Correction Factor (dB/m)
1	*5745.00	114.30 PK			1.63 V	83	77.90	36.40
1	*5745.00	105.10 AV			1.63 V	83	68.70	36.40
2	#11490.00	56.00 PK	74.00	-18.00	1.76 V	242	4.90	51.10
2	#11490.00	44.90 AV	54.00	-9.10	1.76 V	242	-6.20	51.10

- NOTE:**
1. Emission level(dBuV/m)=Raw Value(dBuV) + Correction Factor(dB/m)
 2. Correction Factor(dB/m) = Antenna Factor (dB/m) + Cable Factor (dB)
 3. The other emission levels were very low against the limit.
 4. Margin value = Emission level – Limit value
 5. "*" : Fundamental frequency
 6. "#"The radiated frequency falling in the restricted band.
 7. The limit value is defined as per 15.247

EUT	Bridging kit - 802.11a	MODEL	WL-464
CHANNEL	Channel 5	FREQUENCY RANGE	1 ~ 40 GHz
MODULATION TYPE	BPSK	TRANSFER RATE	6Mbps
INPUT POWER (SYSTEM)	120Vac, 60 Hz	DETECTOR FUNCTION	Peak(PK) Average (AV)
ENVIRONMENTAL CONDITIONS	20deg. C, 65%RH, 960hPa	TESTED BY	Rex Huang

ANTENNA POLARITY & TEST DISTANCE: HORIZONTAL AT 3 M

No.	Freq. (MHz)	Emission Level (dBuV/m)	Limit (dBuV/m)	Margin (dB)	Antenna Height (m)	Table Angle (Degree)	Raw Value (dBuV)	Correction Factor (dB/m)
1	*5825.00	100.30 PK			1.88 H	302	63.70	36.60
1	*5825.00	91.30 AV			1.88 H	302	54.70	36.60
2	#11650.00	57.20 PK	74.00	-16.80	1.77 H	338	6.60	50.60
2	#11650.00	46.00 AV	54.00	-8.00	1.77 H	338	-4.60	50.60

ANTENNA POLARITY & TEST DISTANCE: VERTICAL AT 3 M

No.	Freq. (MHz)	Emission Level (dBuV/m)	Limit (dBuV/m)	Margin (dB)	Antenna Height (m)	Table Angle (Degree)	Raw Value (dBuV)	Correction Factor (dB/m)
1	*5825.00	113.50 PK			1.68 V	52	76.90	36.60
1	*5825.00	104.70 AV			1.68 V	52	68.10	36.60
2	#11650.00	57.30 PK	74.00	-16.70	1.79 V	237	6.70	50.60
2	#11650.00	46.20 AV	54.00	-7.80	1.79 V	237	-4.40	50.60

- NOTE:**
1. Emission level(dBuV/m)=Raw Value(dBuV) + Correction Factor(dB/m)
 2. Correction Factor(dB/m) = Antenna Factor (dB/m) + Cable Factor (dB)
 3. The other emission levels were very low against the limit.
 4. Margin value = Emission level – Limit value
 5. "*" : Fundamental frequency
 6. "#"The radiated frequency falling in the restricted band.
 7. The limit value is defined as per 15.247



802.11a Turbo OFDM modulation

EUT	Bridging kit - 802.11a	MODEL	WL-464
CHANNEL	Channel 1	FREQUENCY RANGE	1 ~ 40 GHz
MODULATION TYPE	BPSK	TRANSFER RATE	12Mbps
INPUT POWER (SYSTEM)	120Vac, 60 Hz	DETECTOR FUNCTION	Peak(PK) Average (AV)
ENVIRONMENTAL CONDITIONS	20deg. C, 65%RH, 960hPa	TESTED BY	Rex Huang

ANTENNA POLARITY & TEST DISTANCE: HORIZONTAL AT 3 M

No.	Freq. (MHz)	Emission Level (dBuV/m)	Limit (dBuV/m)	Margin (dB)	Antenna Height (m)	Table Angle (Degree)	Raw Value (dBuV)	Correction Factor (dB/m)
1	*5760.00	97.60 PK			1.91 H	297	61.20	36.40
1	*5760.00	88.70 AV			1.91 H	297	52.30	36.40
2	#11520.00	56.50 PK	74.00	-17.50	1.72 H	343	5.40	51.10
2	#11520.00	45.40 AV	54.00	-8.60	1.72 H	343	-5.70	51.10

ANTENNA POLARITY & TEST DISTANCE: VERTICAL AT 3 M

No.	Freq. (MHz)	Emission Level (dBuV/m)	Limit (dBuV/m)	Margin (dB)	Antenna Height (m)	Table Angle (Degree)	Raw Value (dBuV)	Correction Factor (dB/m)
1	*5760.00	111.20 PK			1.67 V	52	74.80	36.40
1	*5760.00	102.20 AV			1.67 V	52	65.80	36.40
2	#11520.00	57.00 PK	74.00	-17.00	1.53 V	72	5.90	51.10
2	#11520.00	45.90 AV	54.00	-8.10	1.53 V	72	-5.20	51.10

- NOTE:**
1. Emission level(dBuV/m)=Raw Value(dBuV) + Correction Factor(dB/m)
 2. Correction Factor(dB/m) = Antenna Factor (dB/m) + Cable Factor (dB)
 3. The other emission levels were very low against the limit.
 4. Margin value = Emission level – Limit value
 5. "*" : Fundamental frequency
 6. "#"The radiated frequency falling in the restricted band.
 7. The limit value is defined as per 15.247



EUT	Bridging kit - 802.11a	MODEL	WL-464
CHANNEL	Channel 2	FREQUENCY RANGE	1 ~ 40 GHz
MODULATION TYPE	BPSK	TRANSFER RATE	12Mbps
INPUT POWER (SYSTEM)	120Vac, 60 Hz	DETECTOR FUNCTION	Peak(PK) Average (AV)
ENVIRONMENTAL CONDITIONS	20deg. C, 65%RH, 960hPa	TESTED BY	Rex Huang

ANTENNA POLARITY & TEST DISTANCE: HORIZONTAL AT 3 M

No.	Freq. (MHz)	Emission Level (dBuV/m)	Limit (dBuV/m)	Margin (dB)	Antenna Height (m)	Table Angle (Degree)	Raw Value (dBuV)	Correction Factor (dB/m)
1	*5800.00	97.40 PK			1.88 H	298	60.80	36.60
1	*5800.00	88.70 AV			1.88 H	298	52.10	36.60
2	#11600.00	55.80 PK	74.00	-18.20	1.76 H	339	5.00	50.80
2	#11600.00	44.80 AV	54.00	-9.20	1.76 H	339	-6.00	50.80

ANTENNA POLARITY & TEST DISTANCE: VERTICAL AT 3 M

No.	Freq. (MHz)	Emission Level (dBuV/m)	Limit (dBuV/m)	Margin (dB)	Antenna Height (m)	Table Angle (Degree)	Raw Value (dBuV)	Correction Factor (dB/m)
1	*5800.00	111.50 PK			1.66 V	50	74.90	36.60
1	*5800.00	102.50 AV			1.66 V	50	65.90	36.60
2	#11600.00	56.40 PK	74.00	-17.60	1.61 V	66	5.60	50.80
2	#11600.00	45.50 AV	54.00	-8.50	1.61 V	66	-5.30	50.80

- NOTE:**
1. Emission level(dBuV/m)=Raw Value(dBuV) + Correction Factor(dB/m)
 2. Correction Factor(dB/m) = Antenna Factor (dB/m) + Cable Factor (dB)
 3. The other emission levels were very low against the limit.
 4. Margin value = Emission level – Limit value
 5. "*" : Fundamental frequency
 6. "#"The radiated frequency falling in the restricted band.
 7. The limit value is defined as per 15.247

4.2.8 TEST RESULTS (MODE 2)

Below 1GHz Worst-Case Data

EUT	Bridging kit - 802.11a	MODEL	WL-464
CHANNEL	Channel 3	FREQUENCY RANGE	Below 1000MHz
MODULATION TYPE	BPSK	TRANSFER RATE	6Mbps
INPUT POWER (SYSTEM)	120Vac, 60 Hz	DETECTOR FUNCTION	Quasi-Peak
ENVIRONMENTAL CONDITIONS	27deg. C, 57%RH, 960hPa	TESTED BY	Tony Chen

ANTENNA POLARITY & TEST DISTANCE: HORIZONTAL AT 3 M

No.	Freq. (MHz)	Emission Level (dBuV/m)	Limit (dBuV/m)	Margin (dB)	Antenna Height (m)	Table Angle (Degree)	Raw Value (dBuV)	Correction Factor (dB/m)
1	80.02	15.90 QP	40.00	-24.10	1.34 H	45	6.00	9.90
2	160.00	27.00 QP	43.50	-16.50	1.52 H	30	13.20	13.80
3	250.00	24.60 QP	46.00	-21.40	1.00 H	326	11.30	13.30
4	320.00	28.20 QP	46.00	-17.80	1.23 H	65	11.70	16.50
5	374.99	25.00 QP	46.00	-21.00	1.00 H	2	7.40	17.60
6	500.00	23.10 QP	46.00	-22.90	1.01 H	21	2.20	20.90
7	639.99	23.60 QP	46.00	-22.40	2.01 H	23	-0.30	23.90

ANTENNA POLARITY & TEST DISTANCE: VERTICAL AT 3 M

No.	Freq. (MHz)	Emission Level (dBuV/m)	Limit (dBuV/m)	Margin (dB)	Antenna Height (m)	Table Angle (Degree)	Raw Value (dBuV)	Correction Factor (dB/m)
1	80.00	31.00 QP	40.00	-9.00	2.56 V	326	21.10	9.90
2	133.33	31.60 QP	43.50	-11.90	1.02 V	54	19.00	12.60
3	166.70	42.40 QP	43.50	-1.10	2.05 V	65	29.00	13.40
4	199.25	39.50 QP	43.50	-4.00	2.37 V	21	28.30	11.20
5	299.45	38.00 QP	46.00	-8.00	2.30 V	306	21.70	16.30
6	499.92	27.60 QP	46.00	-18.40	1.98 V	63	6.70	20.90
7	699.70	33.00 QP	46.00	-13.00	2.00 V	258	8.10	24.90

- REMARKS:**
1. Emission level(dBuV/m)=Raw Value(dBuV) + Correction Factor(dB/m)
 2. Correction Factor(dB/m) = Antenna Factor (dB/m) + Cable Factor (dB)
 3. The other emission levels were very low against the limit.
 4. Margin value = Emission level – Limit value

802.11a OFDM modulation

EUT	Bridging kit - 802.11a	MODEL	WL-464
CHANNEL	Channel 1	FREQUENCY RANGE	1 ~ 40 GHz
MODULATION TYPE	BPSK	TRANSFER RATE	6Mbps
INPUT POWER (SYSTEM)	120Vac, 60 Hz	DETECTOR FUNCTION	Peak(PK) Average (AV)
ENVIRONMENTAL CONDITIONS	20deg. C, 65%RH, 960hPa	TESTED BY	Rex Huang

ANTENNA POLARITY & TEST DISTANCE: HORIZONTAL AT 3 M

No.	Freq. (MHz)	Emission Level (dBuV/m)	Limit (dBuV/m)	Margin (dB)	Antenna Height (m)	Table Angle (Degree)	Raw Value (dBuV)	Correction Factor (dB/m)
1	*5745.00	98.80 PK			1.72 H	16	62.40	36.40
1	*5745.00	90.10 AV			1.72 H	16	53.70	36.40
2	#11490.00	58.00 PK	74.00	-16.00	1.54 H	28	6.80	51.10
2	#11490.00	47.50 AV	54.00	-6.50	1.54 H	28	-3.60	51.10

ANTENNA POLARITY & TEST DISTANCE: VERTICAL AT 3 M

No.	Freq. (MHz)	Emission Level (dBuV/m)	Limit (dBuV/m)	Margin (dB)	Antenna Height (m)	Table Angle (Degree)	Raw Value (dBuV)	Correction Factor (dB/m)
1	*5745.00	114.70 PK			1.06 V	18	78.30	36.40
1	*5745.00	105.20 AV			1.06 V	18	68.80	36.40
2	#11490.00	59.20 PK	74.00	-14.80	1.24 V	23	8.10	51.10
2	#11490.00	47.80 AV	54.00	-6.20	1.24 V	23	-3.30	51.10

- NOTE:**
1. Emission level(dBuV/m)=Raw Value(dBuV) + Correction Factor(dB/m)
 2. Correction Factor(dB/m) = Antenna Factor (dB/m) + Cable Factor (dB)
 3. The other emission levels were very low against the limit.
 4. Margin value = Emission level – Limit value
 5. "*" : Fundamental frequency
 6. "#"The radiated frequency falling in the restricted band.
 7. The limit value is defined as per 15.247



EUT	Bridging kit - 802.11a	MODEL	WL-464
CHANNEL	Channel 5	FREQUENCY RANGE	1 ~ 40 GHz
MODULATION TYPE	BPSK	TRANSFER RATE	6Mbps
INPUT POWER (SYSTEM)	120Vac, 60 Hz	DETECTOR FUNCTION	Peak(PK) Average (AV)
ENVIRONMENTAL CONDITIONS	20deg. C, 65%RH, 960hPa	TESTED BY	Rex Huang

ANTENNA POLARITY & TEST DISTANCE: HORIZONTAL AT 3 M								
No.	Freq. (MHz)	Emission Level (dBuV/m)	Limit (dBuV/m)	Margin (dB)	Antenna Height (m)	Table Angle (Degree)	Raw Value (dBuV)	Correction Factor (dB/m)
1	*5825.00	97.70 PK			1.77 H	32	61.10	36.60
1	*5825.00	88.70 AV			1.77 H	32	52.10	36.60
2	#11650.00	56.60 PK	74.00	-17.40	1.63 H	337	6.00	50.60
2	#11650.00	45.00 AV	54.00	-9.00	1.63 H	337	-5.60	50.60

ANTENNA POLARITY & TEST DISTANCE: VERTICAL AT 3 M								
No.	Freq. (MHz)	Emission Level (dBuV/m)	Limit (dBuV/m)	Margin (dB)	Antenna Height (m)	Table Angle (Degree)	Raw Value (dBuV)	Correction Factor (dB/m)
1	*5825.00	112.60 PK			1.06 V	17	76.00	36.60
1	*5825.00	103.30 AV			1.06 V	17	66.70	36.60
2	#11650.00	57.40 PK	74.00	-16.60	1.26 V	25	6.80	50.60
2	#11650.00	45.80 AV	54.00	-8.20	1.26 V	25	-4.80	50.60

- NOTE:**
1. Emission level(dBuV/m)=Raw Value(dBuV) + Correction Factor(dB/m)
 2. Correction Factor(dB/m) = Antenna Factor (dB/m) + Cable Factor (dB)
 3. The other emission levels were very low against the limit.
 4. Margin value = Emission level – Limit value
 5. "*" : Fundamental frequency
 6. "#"The radiated frequency falling in the restricted band.
 7. The limit value is defined as per 15.247

802.11a Turbo OFDM modulation

EUT	Bridging kit - 802.11a	MODEL	WL-464
CHANNEL	Channel 1	FREQUENCY RANGE	1 ~ 40 GHz
MODULATION TYPE	BPSK	TRANSFER RATE	12Mbps
INPUT POWER (SYSTEM)	120Vac, 60 Hz	DETECTOR FUNCTION	Peak(PK) Average (AV)
ENVIRONMENTAL CONDITIONS	20deg. C, 65%RH, 960hPa	TESTED BY	Rex Huang

ANTENNA POLARITY & TEST DISTANCE: HORIZONTAL AT 3 M

No.	Freq. (MHz)	Emission Level (dBuV/m)	Limit (dBuV/m)	Margin (dB)	Antenna Height (m)	Table Angle (Degree)	Raw Value (dBuV)	Correction Factor (dB/m)
1	*5760.00	85.70 PK			1.77 H	342	49.30	36.40
1	*5760.00	86.80 AV			1.77 H	342	50.40	36.40
2	#11520.00	56.20 PK	74.00	-17.80	1.61 H	31	5.10	51.10
2	#11520.00	45.00 AV	54.00	-9.00	1.61 H	31	-6.10	51.10

ANTENNA POLARITY & TEST DISTANCE: VERTICAL AT 3 M

No.	Freq. (MHz)	Emission Level (dBuV/m)	Limit (dBuV/m)	Margin (dB)	Antenna Height (m)	Table Angle (Degree)	Raw Value (dBuV)	Correction Factor (dB/m)
1	*5760.00	111.70 PK			1.06 V	7	75.20	36.40
1	*5760.00	102.80 AV			1.06 V	7	66.30	36.40
2	#11520.00	57.40 PK	74.00	-16.60	1.27 V	33	6.30	51.10
2	#11520.00	45.80 AV	54.00	-8.20	1.27 V	33	-5.30	51.10

- NOTE:**
1. Emission level(dBuV/m)=Raw Value(dBuV) + Correction Factor(dB/m)
 2. Correction Factor(dB/m) = Antenna Factor (dB/m) + Cable Factor (dB)
 3. The other emission levels were very low against the limit.
 4. Margin value = Emission level – Limit value
 5. "*" : Fundamental frequency
 6. "#"The radiated frequency falling in the restricted band.
 7. The limit value is defined as per 15.247



EUT	Bridging kit - 802.11a	MODEL	WL-464
CHANNEL	Channel 2	FREQUENCY RANGE	1 ~ 40 GHz
MODULATION TYPE	BPSK	TRANSFER RATE	12Mbps
INPUT POWER (SYSTEM)	120Vac, 60 Hz	DETECTOR FUNCTION	Peak(PK) Average (AV)
ENVIRONMENTAL CONDITIONS	20deg. C, 65%RH, 960hPa	TESTED BY	Rex Huang

ANTENNA POLARITY & TEST DISTANCE: HORIZONTAL AT 3 M

No.	Freq. (MHz)	Emission Level (dBuV/m)	Limit (dBuV/m)	Margin (dB)	Antenna Height (m)	Table Angle (Degree)	Raw Value (dBuV)	Correction Factor (dB/m)
1	*5800.00	96.90 PK			1.78 H	336	60.30	36.60
1	*5800.00	88.10 AV			1.78 H	336	51.50	36.60
2	#11600.00	56.80 PK	74.00	-17.20	1.64 H	26	6.00	50.80
2	#11600.00	44.90 AV	54.00	-9.10	1.64 H	26	-5.90	50.80

ANTENNA POLARITY & TEST DISTANCE: VERTICAL AT 3 M

No.	Freq. (MHz)	Emission Level (dBuV/m)	Limit (dBuV/m)	Margin (dB)	Antenna Height (m)	Table Angle (Degree)	Raw Value (dBuV)	Correction Factor (dB/m)
1	*5800.00	110.00 PK			1.07 V	10	73.40	36.60
1	*5800.00	101.50 AV			1.07 V	10	64.90	36.60
2	#11600.00	57.40 PK	74.00	-16.60	1.31 V	36	6.60	50.80
2	#11600.00	45.70 AV	54.00	-8.30	1.31 V	36	-5.10	50.80

- NOTE:**
1. Emission level(dBuV/m)=Raw Value(dBuV) + Correction Factor(dB/m)
 2. Correction Factor(dB/m) = Antenna Factor (dB/m) + Cable Factor (dB)
 3. The other emission levels were very low against the limit.
 4. Margin value = Emission level – Limit value
 5. "*" : Fundamental frequency
 6. "#"The radiated frequency falling in the restricted band.
 7. The limit value is defined as per 15.247

4.2.9 TEST RESULTS (MODE 3)

Below 1GHz Worst-Case Data

EUT	Bridging kit - 802.11a	MODEL	WL-464
CHANNEL	Channel 3	FREQUENCY RANGE	Below 1000MHz
MODULATION TYPE	BPSK	TRANSFER RATE	6Mbps
INPUT POWER (SYSTEM)	120Vac, 60 Hz	DETECTOR FUNCTION	Quasi-Peak
ENVIRONMENTAL CONDITIONS	25deg. C, 55%RH, 960hPa	TESTED BY	Tony Chen

ANTENNA POLARITY & TEST DISTANCE: HORIZONTAL AT 3 M

No.	Freq. (MHz)	Emission Level (dBuV/m)	Limit (dBuV/m)	Margin (dB)	Antenna Height (m)	Table Angle (Degree)	Raw Value (dBuV)	Correction Factor (dB/m)
1	80.00	19.60 QP	40.00	-20.40	1.11 H	223	9.80	9.90
2	160.00	23.60 QP	43.50	-19.90	1.02 H	326	9.90	13.80
3	200.00	22.60 QP	43.50	-20.90	1.94 H	234	11.40	11.20
4	250.00	35.20 QP	46.00	-10.80	1.02 H	36	21.90	13.30
5	400.00	28.60 QP	46.00	-17.40	1.69 H	63	10.30	18.40
6	500.01	29.40 QP	46.00	-16.60	1.02 H	247	8.50	20.90
7	640.00	26.00 QP	46.00	-20.00	1.87 H	54	2.10	23.90

ANTENNA POLARITY & TEST DISTANCE: VERTICAL AT 3 M

No.	Freq. (MHz)	Emission Level (dBuV/m)	Limit (dBuV/m)	Margin (dB)	Antenna Height (m)	Table Angle (Degree)	Raw Value (dBuV)	Correction Factor (dB/m)
1	80.00	29.60 QP	40.00	-10.40	1.54 V	65	19.70	9.90
2	125.00	22.60 QP	43.50	-20.90	1.27 V	232	10.70	11.90
3	200.00	25.80 QP	43.50	-17.70	1.28 V	283	14.60	11.20
4	400.00	26.00 QP	46.00	-20.00	2.00 V	198	7.60	18.40
5	480.00	22.00 QP	46.00	-24.00	1.40 V	20	1.60	20.40
6	500.00	31.20 QP	46.00	-14.80	1.47 V	58	10.40	20.90
7	625.01	26.60 QP	46.00	-19.40	1.47 V	246	2.80	23.80

- REMARKS:**
1. Emission level(dBuV/m)=Raw Value(dBuV) + Correction Factor(dB/m)
 2. Correction Factor(dB/m) = Antenna Factor (dB/m) + Cable Factor (dB)
 3. The other emission levels were very low against the limit.
 4. Margin value = Emission level – Limit value

802.11a OFDM modulation

EUT	Bridging kit - 802.11a	MODEL	WL-464
CHANNEL	Channel 1	FREQUENCY RANGE	1 ~ 40 GHz
MODULATION TYPE	BPSK	TRANSFER RATE	6Mbps
INPUT POWER (SYSTEM)	120Vac, 60 Hz	DETECTOR FUNCTION	Peak(PK) Average (AV)
ENVIRONMENTAL CONDITIONS	20deg. C, 65%RH, 960hPa	TESTED BY	Rex Huang

ANTENNA POLARITY & TEST DISTANCE: HORIZONTAL AT 3 M

No.	Freq. (MHz)	Emission Level (dBuV/m)	Limit (dBuV/m)	Margin (dB)	Antenna Height (m)	Table Angle (Degree)	Raw Value (dBuV)	Correction Factor (dB/m)
1	*5745.00	104.00 PK			1.13 H	345	67.60	36.40
1	*5745.00	94.70 AV			1.13 H	345	58.30	36.40
2	#11490.00	58.00 PK	74.00	-16.00	1.64 H	347	6.90	51.10
2	#11490.00	47.40 AV	54.00	-6.60	1.64 H	347	-3.70	51.10

ANTENNA POLARITY & TEST DISTANCE: VERTICAL AT 3 M

No.	Freq. (MHz)	Emission Level (dBuV/m)	Limit (dBuV/m)	Margin (dB)	Antenna Height (m)	Table Angle (Degree)	Raw Value (dBuV)	Correction Factor (dB/m)
1	*5745.00	12.90 PK			1.11 V	0	-23.50	36.40
1	*5745.00	111.50 AV			1.11 V	0	75.10	36.40
2	#11490.00	59.70 PK	74.00	-14.30	1.53 V	6	8.60	51.10
2	#11490.00	48.20 AV	54.00	-5.80	1.53 V	6	-2.90	51.10

- NOTE:**
1. Emission level(dBuV/m)=Raw Value(dBuV) + Correction Factor(dB/m)
 2. Correction Factor(dB/m) = Antenna Factor (dB/m) + Cable Factor (dB)
 3. The other emission levels were very low against the limit.
 4. Margin value = Emission level – Limit value
 5. "*" : Fundamental frequency
 6. "#"The radiated frequency falling in the restricted band.
 7. The limit value is defined as per 15.247



EUT	Bridging kit - 802.11a	MODEL	WL-464
CHANNEL	Channel 5	FREQUENCY RANGE	1 ~ 40 GHz
MODULATION TYPE	BPSK	TRANSFER RATE	6Mbps
INPUT POWER (SYSTEM)	120Vac, 60 Hz	DETECTOR FUNCTION	Peak(PK) Average (AV)
ENVIRONMENTAL CONDITIONS	20deg. C, 65%RH, 960hPa	TESTED BY	Rex Huang

ANTENNA POLARITY & TEST DISTANCE: HORIZONTAL AT 3 M

No.	Freq. (MHz)	Emission Level (dBuV/m)	Limit (dBuV/m)	Margin (dB)	Antenna Height (m)	Table Angle (Degree)	Raw Value (dBuV)	Correction Factor (dB/m)
1	*5825.00	103.70 PK			1.09 H	344	67.10	36.60
1	*5825.00	94.30 AV			1.09 H	344	57.70	36.60
2	#11650.00	56.90 PK	74.00	-17.10	1.68 H	343	6.30	50.60
2	#11650.00	45.20 AV	54.00	-8.80	1.68 H	343	-5.40	50.60

ANTENNA POLARITY & TEST DISTANCE: VERTICAL AT 3 M

No.	Freq. (MHz)	Emission Level (dBuV/m)	Limit (dBuV/m)	Margin (dB)	Antenna Height (m)	Table Angle (Degree)	Raw Value (dBuV)	Correction Factor (dB/m)
1	*5825.00	120.70 PK			1.11 V	359	84.10	36.60
1	*5825.00	111.20 AV			1.11 V	359	74.60	36.60
2	#11650.00	57.90 PK	74.00	-16.10	1.51 V	7	7.30	50.60
2	#11650.00	46.40 AV	54.00	-7.60	1.51 V	7	-4.20	50.60

- NOTE:**
1. Emission level(dBuV/m)=Raw Value(dBuV) + Correction Factor(dB/m)
 2. Correction Factor(dB/m) = Antenna Factor (dB/m) + Cable Factor (dB)
 3. The other emission levels were very low against the limit.
 4. Margin value = Emission level – Limit value
 5. "*" : Fundamental frequency
 6. "#"The radiated frequency falling in the restricted band.
 7. The limit value is defined as per 15.247

802.11a Turbo OFDM modulation

EUT	Bridging kit - 802.11a	MODEL	WL-464
CHANNEL	Channel 1	FREQUENCY RANGE	1 ~ 40 GHz
MODULATION TYPE	BPSK	TRANSFER RATE	12Mbps
INPUT POWER (SYSTEM)	120Vac, 60 Hz	DETECTOR FUNCTION	Peak(PK) Average (AV)
ENVIRONMENTAL CONDITIONS	20deg. C, 65%RH, 960hPa	TESTED BY	Rex Huang

ANTENNA POLARITY & TEST DISTANCE: HORIZONTAL AT 3 M

No.	Freq. (MHz)	Emission Level (dBuV/m)	Limit (dBuV/m)	Margin (dB)	Antenna Height (m)	Table Angle (Degree)	Raw Value (dBuV)	Correction Factor (dB/m)
1	*5760.00	100.40 PK			1.13 H	345	64.00	36.40
1	*5760.00	91.40 AV			1.13 H	345	55.00	36.40
2	#11520.00	56.70 PK	74.00	-17.30	1.65 H	342	5.60	51.10
2	#11520.00	45.20 AV	54.00	-8.80	1.65 H	342	-5.90	51.10

ANTENNA POLARITY & TEST DISTANCE: VERTICAL AT 3 M

No.	Freq. (MHz)	Emission Level (dBuV/m)	Limit (dBuV/m)	Margin (dB)	Antenna Height (m)	Table Angle (Degree)	Raw Value (dBuV)	Correction Factor (dB/m)
1	*5760.00	117.80 PK			1.12 V	359	81.40	36.40
1	*5760.00	109.10 AV			1.12 V	359	72.70	36.40
2	#11520.00	57.90 PK	74.00	-16.10	1.53 V	6	6.80	51.10
2	#11520.00	46.20 AV	54.00	-7.80	1.53 V	6	-4.90	51.10

- NOTE:**
1. Emission level(dBuV/m)=Raw Value(dBuV) + Correction Factor(dB/m)
 2. Correction Factor(dB/m) = Antenna Factor (dB/m) + Cable Factor (dB)
 3. The other emission levels were very low against the limit.
 4. Margin value = Emission level – Limit value
 5. "*" : Fundamental frequency
 6. "#"The radiated frequency falling in the restricted band.
 7. The limit value is defined as per 15.247



EUT	Bridging kit - 802.11a	MODEL	WL-464
CHANNEL	Channel 2	FREQUENCY RANGE	1 ~ 40 GHz
MODULATION TYPE	BPSK	TRANSFER RATE	12Mbps
INPUT POWER (SYSTEM)	120Vac, 60 Hz	DETECTOR FUNCTION	Peak(PK) Average (AV)
ENVIRONMENTAL CONDITIONS	20deg. C, 65%RH, 960hPa	TESTED BY	Rex Huang

ANTENNA POLARITY & TEST DISTANCE: HORIZONTAL AT 3 M

No.	Freq. (MHz)	Emission Level (dBuV/m)	Limit (dBuV/m)	Margin (dB)	Antenna Height (m)	Table Angle (Degree)	Raw Value (dBuV)	Correction Factor (dB/m)
1	*5800.00	100.30 PK			1.21 H	344	63.80	36.60
1	*5800.00	91.20 AV			1.21 H	344	54.70	36.60
2	#11600.00	56.60 PK	74.00	-17.40	1.66 H	346	5.80	50.80
2	#11600.00	44.80 AV	54.00	-9.20	1.66 H	346	-6.00	50.80

ANTENNA POLARITY & TEST DISTANCE: VERTICAL AT 3 M

No.	Freq. (MHz)	Emission Level (dBuV/m)	Limit (dBuV/m)	Margin (dB)	Antenna Height (m)	Table Angle (Degree)	Raw Value (dBuV)	Correction Factor (dB/m)
1	*5800.00	118.30 PK			1.10 V	0	81.80	36.60
1	*5800.00	109.70 AV			1.10 V	0	73.10	36.60
2	#11600.00	57.70 PK	74.00	-16.30	1.55 V	8	6.90	50.80
2	#11600.00	45.90 AV	54.00	-8.10	1.55 V	8	-4.90	50.80

- NOTE:**
1. Emission level(dBuV/m)=Raw Value(dBuV) + Correction Factor(dB/m)
 2. Correction Factor(dB/m) = Antenna Factor (dB/m) + Cable Factor (dB)
 3. The other emission levels were very low against the limit.
 4. Margin value = Emission level – Limit value
 5. "*" : Fundamental frequency
 6. "#"The radiated frequency falling in the restricted band.
 7. The limit value is defined as per 15.247

4.2.10 TEST RESULTS (MODE 4)

Below 1GHz Worst-Case Data

EUT	Bridging kit - 802.11a	MODEL	WL-464
CHANNEL	Channel 3	FREQUENCY RANGE	Below 1000MHz
MODULATION TYPE	BPSK	TRANSFER RATE	6Mbps
INPUT POWER (SYSTEM)	120Vac, 60 Hz	DETECTOR FUNCTION	Quasi-Peak
ENVIRONMENTAL CONDITIONS	25deg. C, 55%RH, 960hPa	TESTED BY	Tony Chen

ANTENNA POLARITY & TEST DISTANCE: HORIZONTAL AT 3 M

No.	Freq. (MHz)	Emission Level (dBuV/m)	Limit (dBuV/m)	Margin (dB)	Antenna Height (m)	Table Angle (Degree)	Raw Value (dBuV)	Correction Factor (dB/m)
1	64.77	22.40 QP	40.00	-17.60	2.14 H	94	9.50	12.90
2	125.00	23.50 QP	43.50	-20.00	2.01 H	315	11.60	11.90
3	143.30	26.80 QP	43.50	-16.70	1.96 H	308	13.60	13.20
4	250.00	34.70 QP	46.00	-11.30	1.84 H	87	21.40	13.30
5	375.04	27.10 QP	46.00	-18.90	1.64 H	249	9.50	17.60
6	499.99	30.70 QP	46.00	-15.30	1.54 H	62	9.80	20.90
7	625.02	32.80 QP	46.00	-13.20	1.45 H	187	9.00	23.80
8	750.00	36.10 QP	46.00	-9.90	1.34 H	45	9.70	26.40
9	875.00	36.10 QP	46.00	-9.90	1.32 H	41	8.40	27.70
10	1000.00	39.30 QP	54.00	-14.70	1.14 H	283	10.40	28.90

ANTENNA POLARITY & TEST DISTANCE: VERTICAL AT 3 M

No.	Freq. (MHz)	Emission Level (dBuV/m)	Limit (dBuV/m)	Margin (dB)	Antenna Height (m)	Table Angle (Degree)	Raw Value (dBuV)	Correction Factor (dB/m)
1	64.78	31.20 QP	40.00	-8.80	1.00 V	43	18.30	12.90
2	125.00	25.10 QP	43.50	-18.40	1.00 V	143	13.20	11.90
3	143.31	30.40 QP	43.50	-13.10	1.00 V	314	17.20	13.20
4	250.01	37.40 QP	46.00	-8.60	1.00 V	31	24.10	13.30
5	375.02	29.60 QP	46.00	-16.40	1.04 V	23	12.00	17.60
6	500.01	33.40 QP	46.00	-12.60	1.23 V	149	12.50	20.90
7	625.00	32.90 QP	46.00	-13.10	1.43 V	85	9.10	23.80
8	750.00	36.60 QP	46.00	-9.40	1.62 V	276	10.20	26.40
9	875.02	37.70 QP	46.00	-8.30	1.04 V	306	10.00	27.70
10	999.99	38.70 QP	54.00	-15.30	1.24 V	84	9.80	28.90

- REMARKS:**
1. Emission level(dBuV/m)=Raw Value(dBuV) + Correction Factor(dB/m)
 2. Correction Factor(dB/m) = Antenna Factor (dB/m) + Cable Factor (dB)
 3. The other emission levels were very low against the limit.
 4. Margin value = Emission level – Limit value



802.11a OFDM modulation

EUT	Bridging kit - 802.11a	MODEL	WL-464
CHANNEL	Channel 1	FREQUENCY RANGE	1 ~ 40 GHz
MODULATION TYPE	BPSK	TRANSFER RATE	6Mbps
INPUT POWER (SYSTEM)	120Vac, 60 Hz	DETECTOR FUNCTION	Peak(PK) Average (AV)
ENVIRONMENTAL CONDITIONS	20deg. C, 65%RH, 960hPa	TESTED BY	Rex Huang

ANTENNA POLARITY & TEST DISTANCE: HORIZONTAL AT 3 M

No.	Freq. (MHz)	Emission Level (dBuV/m)	Limit (dBuV/m)	Margin (dB)	Antenna Height (m)	Table Angle (Degree)	Raw Value (dBuV)	Correction Factor (dB/m)
1	*5745.00	106.60 PK			1.27 H	252	70.20	36.40
1	*5745.00	98.10 AV			1.27 H	252	61.70	36.40
2	#11490.00	56.90 PK	74.00	-17.10	1.54 H	39	5.80	51.10
2	#11490.00	45.80 AV	54.00	-8.20	1.54 H	39	-5.30	51.10

ANTENNA POLARITY & TEST DISTANCE: VERTICAL AT 3 M

No.	Freq. (MHz)	Emission Level (dBuV/m)	Limit (dBuV/m)	Margin (dB)	Antenna Height (m)	Table Angle (Degree)	Raw Value (dBuV)	Correction Factor (dB/m)
1	*5745.00	109.80 PK			1.83 V	10	73.40	36.40
1	*5745.00	101.00 AV			1.83 V	10	64.60	36.40
2	#11490.00	56.90 PK	74.00	-17.10	1.53 V	334	5.80	51.10
2	#11490.00	46.00 AV	54.00	-8.00	1.53 V	334	-5.10	51.10

- NOTE:**
1. Emission level(dBuV/m)=Raw Value(dBuV) + Correction Factor(dB/m)
 2. Correction Factor(dB/m) = Antenna Factor (dB/m) + Cable Factor (dB)
 3. The other emission levels were very low against the limit.
 4. Margin value = Emission level – Limit value
 5. "*" : Fundamental frequency
 6. "#"The radiated frequency falling in the restricted band.
 7. The limit value is defined as per 15.247



EUT	Bridging kit - 802.11a	MODEL	WL-464
CHANNEL	Channel 5	FREQUENCY RANGE	1 ~ 40 GHz
MODULATION TYPE	BPSK	TRANSFER RATE	6Mbps
INPUT POWER (SYSTEM)	120Vac, 60 Hz	DETECTOR FUNCTION	Peak(PK) Average (AV)
ENVIRONMENTAL CONDITIONS	20deg. C, 65%RH, 960hPa	TESTED BY	Rex Huang

ANTENNA POLARITY & TEST DISTANCE: HORIZONTAL AT 3 M

No.	Freq. (MHz)	Emission Level (dBuV/m)	Limit (dBuV/m)	Margin (dB)	Antenna Height (m)	Table Angle (Degree)	Raw Value (dBuV)	Correction Factor (dB/m)
1	*5825.00	106.90 PK			1.28 H	258	70.30	36.60
1	*5825.00	98.20 AV			1.28 H	258	61.60	36.60
2	#11650.00	56.60 PK	74.00	-17.40	1.53 H	36	6.00	50.60
2	#11650.00	45.70 AV	54.00	-8.30	1.53 H	36	-4.90	50.60

ANTENNA POLARITY & TEST DISTANCE: VERTICAL AT 3 M

No.	Freq. (MHz)	Emission Level (dBuV/m)	Limit (dBuV/m)	Margin (dB)	Antenna Height (m)	Table Angle (Degree)	Raw Value (dBuV)	Correction Factor (dB/m)
1	*5825.00	109.70 PK			1.74 V	20	73.10	36.60
1	*5825.00	100.90 AV			1.74 V	20	64.30	36.60
2	#11650.00	56.90 PK	74.00	-17.10	1.56 V	341	6.30	50.60
2	#11650.00	46.00 AV	54.00	-8.00	1.56 V	341	-4.60	50.60

- NOTE:**
1. Emission level(dBuV/m)=Raw Value(dBuV) + Correction Factor(dB/m)
 2. Correction Factor(dB/m) = Antenna Factor (dB/m) + Cable Factor (dB)
 3. The other emission levels were very low against the limit.
 4. Margin value = Emission level – Limit value
 5. "*" : Fundamental frequency
 6. "#"The radiated frequency falling in the restricted band.
 7. The limit value is defined as per 15.247



802.11a Turbo OFDM modulation

EUT	Bridging kit - 802.11a	MODEL	WL-464
CHANNEL	Channel 1	FREQUENCY RANGE	1 ~ 40 GHz
MODULATION TYPE	BPSK	TRANSFER RATE	12Mbps
INPUT POWER (SYSTEM)	120Vac, 60 Hz	DETECTOR FUNCTION	Peak(PK) Average (AV)
ENVIRONMENTAL CONDITIONS	20deg. C, 65%RH, 960hPa	TESTED BY	Rex Huang

ANTENNA POLARITY & TEST DISTANCE: HORIZONTAL AT 3 M

No.	Freq. (MHz)	Emission Level (dBuV/m)	Limit (dBuV/m)	Margin (dB)	Antenna Height (m)	Table Angle (Degree)	Raw Value (dBuV)	Correction Factor (dB/m)
1	*5760.00	102.90 PK			1.29 H	267	66.50	36.40
1	*5760.00	94.30 AV			1.29 H	267	57.90	36.40
2	#11520.00	56.90 PK	74.00	-17.10	1.51 H	14	5.80	51.10
2	#11520.00	45.50 AV	54.00	-8.50	1.51 H	14	-5.60	51.10

ANTENNA POLARITY & TEST DISTANCE: VERTICAL AT 3 M

No.	Freq. (MHz)	Emission Level (dBuV/m)	Limit (dBuV/m)	Margin (dB)	Antenna Height (m)	Table Angle (Degree)	Raw Value (dBuV)	Correction Factor (dB/m)
1	*5760.00	106.30 PK			2.11 V	9	69.90	36.40
1	*5760.00	97.50 AV			2.11 V	9	61.10	36.40
2	#11520.00	57.70 PK	74.00	-16.30	1.55 V	343	6.60	51.10
2	#11520.00	46.50 AV	54.00	-7.50	1.55 V	343	-4.60	51.10

- NOTE:**
1. Emission level(dBuV/m)=Raw Value(dBuV) + Correction Factor(dB/m)
 2. Correction Factor(dB/m) = Antenna Factor (dB/m) + Cable Factor (dB)
 3. The other emission levels were very low against the limit.
 4. Margin value = Emission level – Limit value
 5. "*" : Fundamental frequency
 6. "#"The radiated frequency falling in the restricted band.
 7. The limit value is defined as per 15.247



EUT	Bridging kit - 802.11a	MODEL	WL-464
CHANNEL	Channel 2	FREQUENCY RANGE	1 ~ 40 GHz
MODULATION TYPE	BPSK	TRANSFER RATE	12Mbps
INPUT POWER (SYSTEM)	120Vac, 60 Hz	DETECTOR FUNCTION	Peak(PK) Average (AV)
ENVIRONMENTAL CONDITIONS	20deg. C, 65%RH, 960hPa	TESTED BY	Rex Huang

ANTENNA POLARITY & TEST DISTANCE: HORIZONTAL AT 3 M

No.	Freq. (MHz)	Emission Level (dBuV/m)	Limit (dBuV/m)	Margin (dB)	Antenna Height (m)	Table Angle (Degree)	Raw Value (dBuV)	Correction Factor (dB/m)
1	*5800.00	103.30 PK			1.31 H	264	66.70	36.60
1	*5800.00	94.80 AV			1.31 H	264	58.20	36.60
2	*11600.00	56.20 PK	74.00	-17.80	1.52 H	16	5.40	50.80
2	*11600.00	45.40 AV	54.00	-8.60	1.52 H	16	-5.40	50.80

ANTENNA POLARITY & TEST DISTANCE: VERTICAL AT 3 M

No.	Freq. (MHz)	Emission Level (dBuV/m)	Limit (dBuV/m)	Margin (dB)	Antenna Height (m)	Table Angle (Degree)	Raw Value (dBuV)	Correction Factor (dB/m)
1	*5800.00	106.90 PK			2.04 V	9	70.30	36.60
1	*5800.00	98.20 AV			2.04 V	9	61.60	36.60
2	*11600.00	57.20 PK	74.00	-16.80	1.56 V	337	6.40	50.80
2	*11600.00	46.00 AV	54.00	-8.00	1.56 V	337	-4.80	50.80

- NOTE:**
1. Emission level(dBuV/m)=Raw Value(dBuV) + Correction Factor(dB/m)
 2. Correction Factor(dB/m) = Antenna Factor (dB/m) + Cable Factor (dB)
 3. The other emission levels were very low against the limit.
 4. Margin value = Emission level – Limit value
 5. "*" : Fundamental frequency
 6. "#"The radiated frequency falling in the restricted band.
 7. The limit value is defined as per 15.247



4.3 6dB BANDWIDTH MEASUREMENT

4.3.1 LIMITS OF 6dB BANDWIDTH MEASUREMENT

The minimum of 6dB Bandwidth Measurement is 0.5 MHz.

4.3.2 TEST INSTRUMENTS

Description & Manufacturer	Model No.	Serial No.	Calibrated Until
R&S SPECTRUM ANALYZER	FSP40	100036	Nov. 23, 2005

NOTE:

- 1.The measurement uncertainty is less than +/- 2.6dB, which is calculated as per the NAMAS document NIS81.
- 2.The calibration interval of the above test instruments is 12 months and the calibrations are traceable to NML/ROC and NIST/USA.

4.3.3 TEST PROCEDURE

The transmitter output was connected to the spectrum analyzer through an attenuator. The bandwidth of the fundamental frequency was measured by spectrum analyzer with 100kHz RBW and 100kHz VBW. The 6dB bandwidth is defined as the total spectrum the power of which is higher than peak power minus 6dB.

4.3.4 DEVIATION FROM TEST STANDARD

No deviation

4.3.5 TEST SETUP

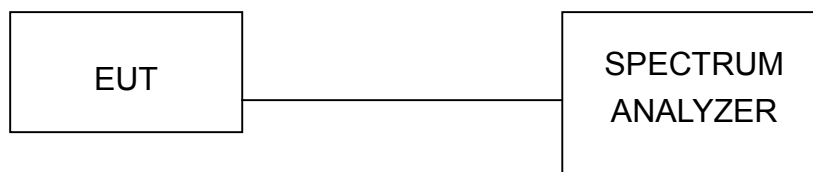

4.3.6 EUT OPERATING CONDITIONS

The software provided by client to enable the EUT under transmission condition continuously at lowest, middle and highest channel frequencies individually.



4.3.7 TEST RESULTS

802.11a OFDM modulation

EUT	Bridging kit - 802.11a	MODEL	WL-464
MODULATION TYPE	BPSK	TRANSFER RATE	6Mbps
INPUT POWER (SYSTEM)	120Vac, 60 Hz	ENVIRONMENTAL CONDITIONS	27deg. C, 62%RH, 960 hPa
TESTED BY	Rex Huang		

CHANNEL	CHANNEL FREQUENCY (MHz)	6dB BANDWIDTH (MHz)	MINIMUM LIMIT (MHz)	PASS/FAIL
1	5745	16.40	0.5	PASS
5	5825	16.35	0.5	PASS

CH 1

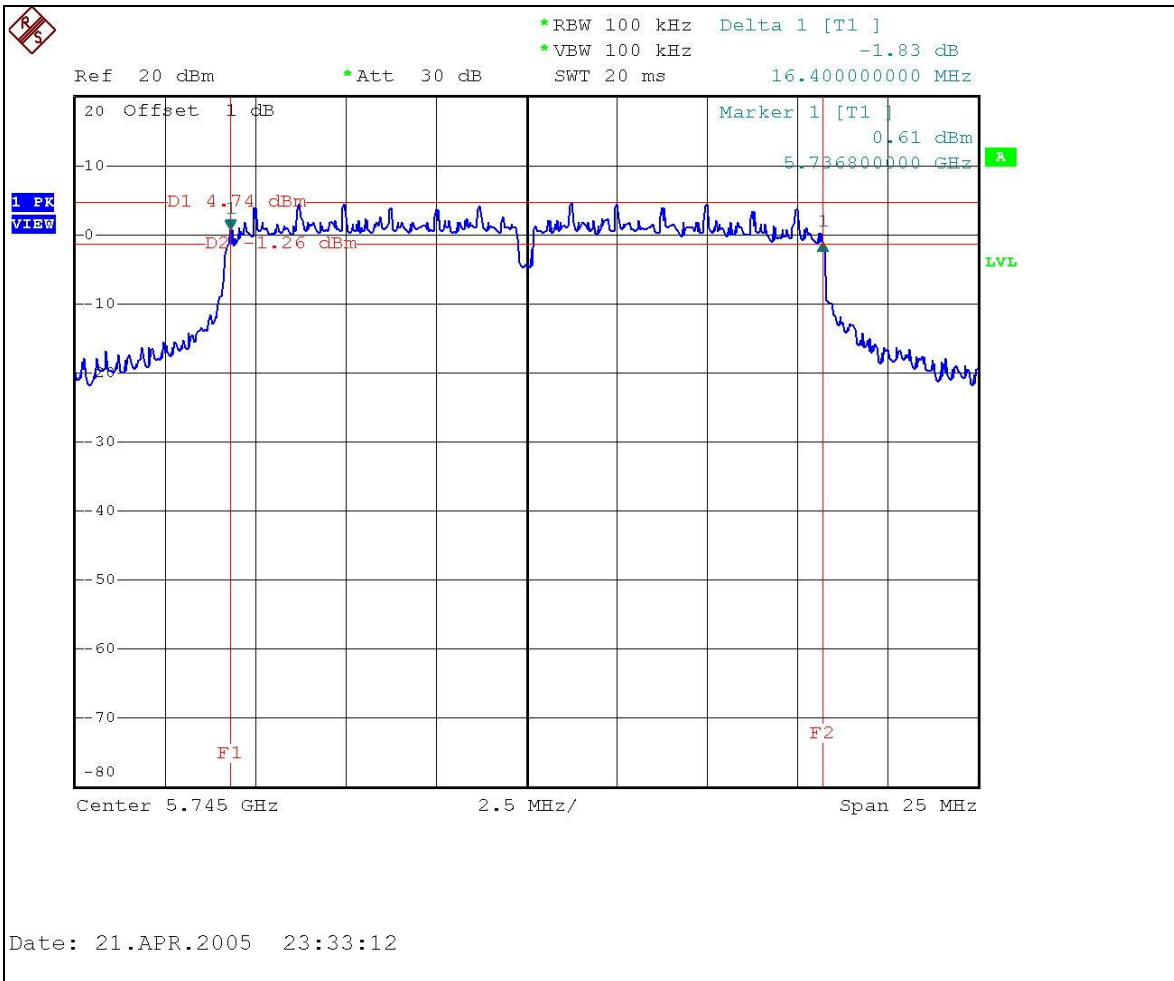



CH 5

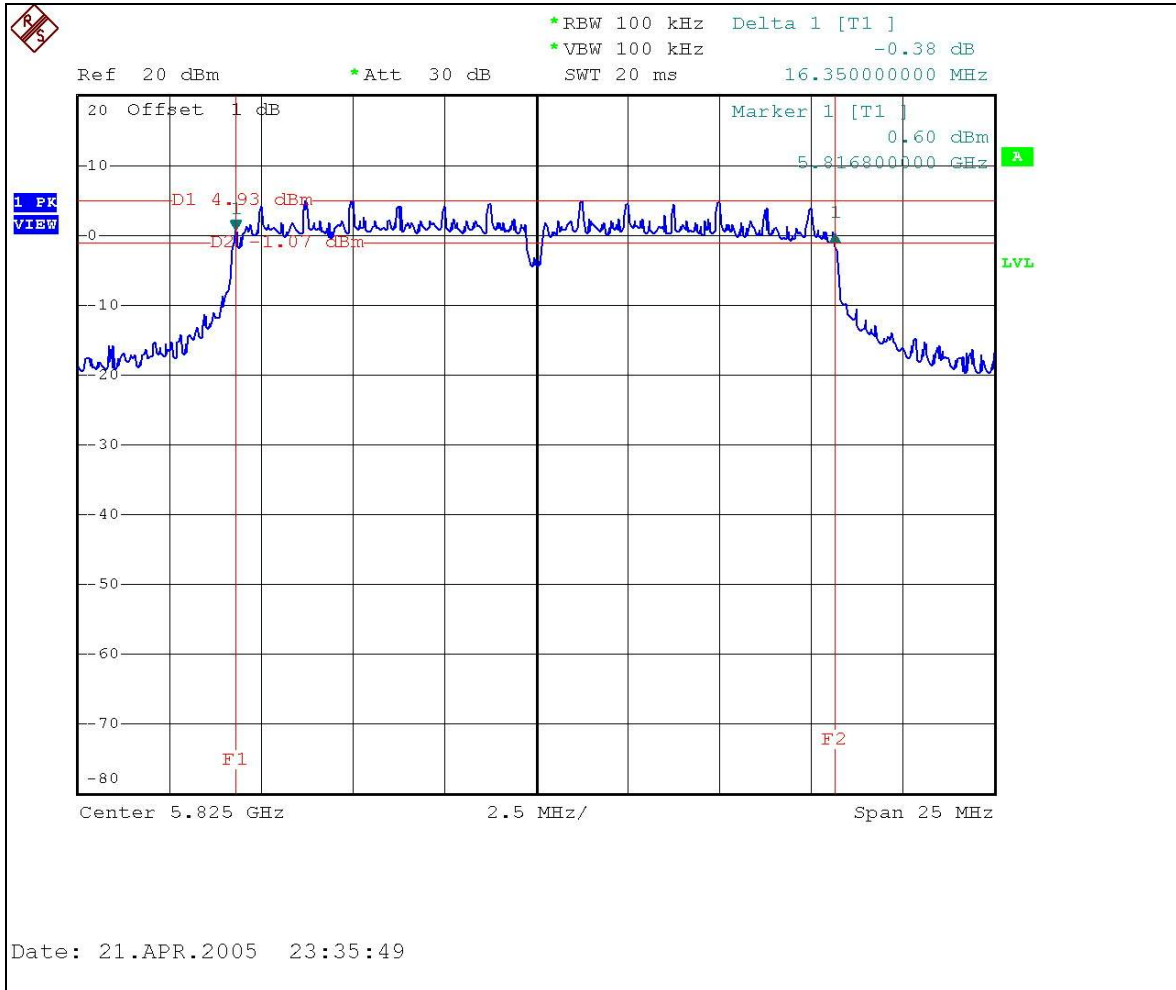



802.11a Turbo OFDM modulation

EUT	Bridging kit - 802.11a	MODEL	WL-464
MODULATION TYPE	BPSK	TRANSFER RATE	12Mbps
INPUT POWER (SYSTEM)	120Vac, 60 Hz	ENVIRONMENTAL CONDITIONS	27deg. C, 62%RH, 960 hPa
TESTED BY	Rex Huang		

CHANNEL	CHANNEL FREQUENCY (MHz)	6dB BANDWIDTH (MHz)	MINIMUM LIMIT (MHz)	PASS/FAIL
1	5760	32.6	0.5	PASS
2	5800	32.5	0.5	PASS

CH 1

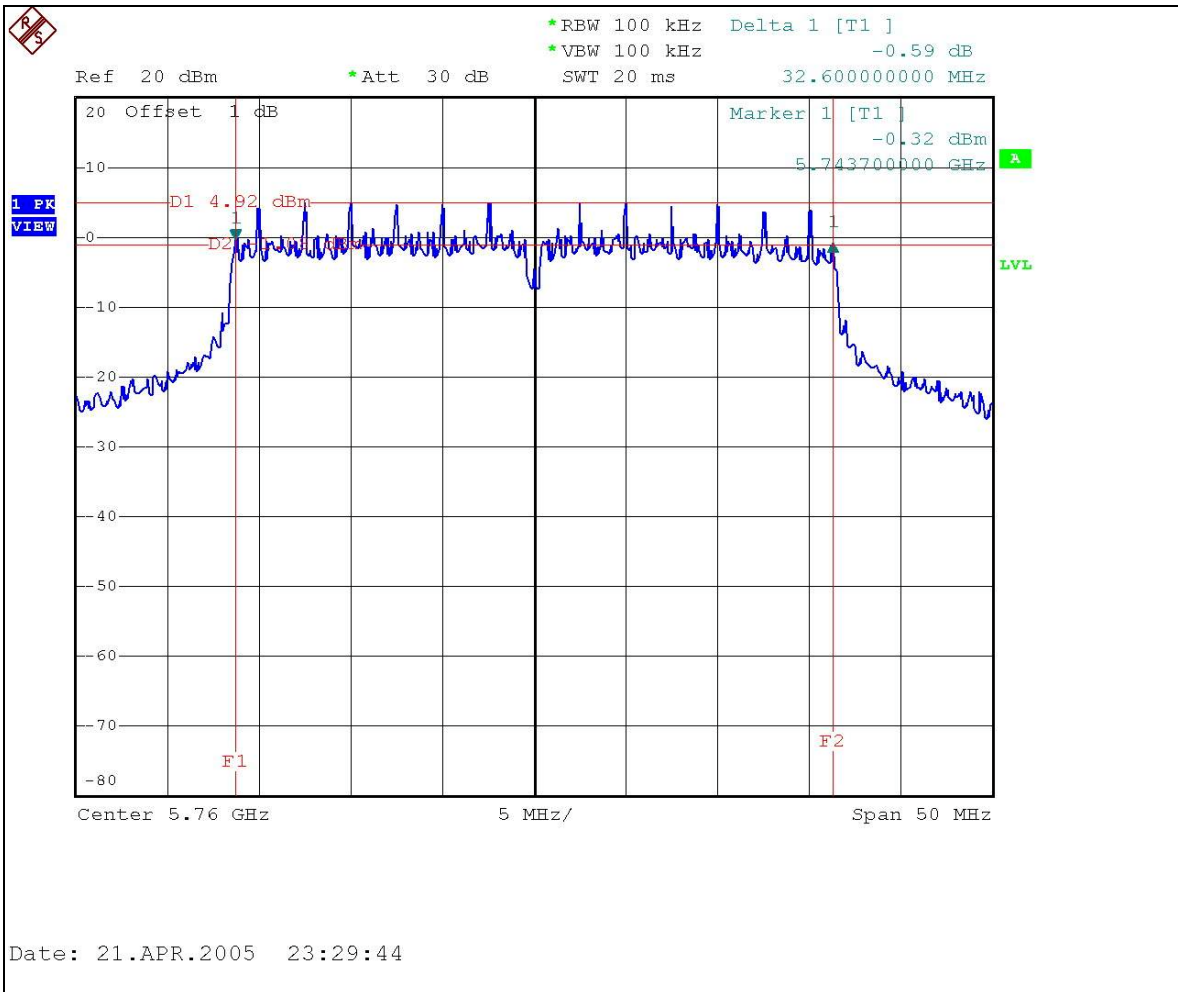



CH 2

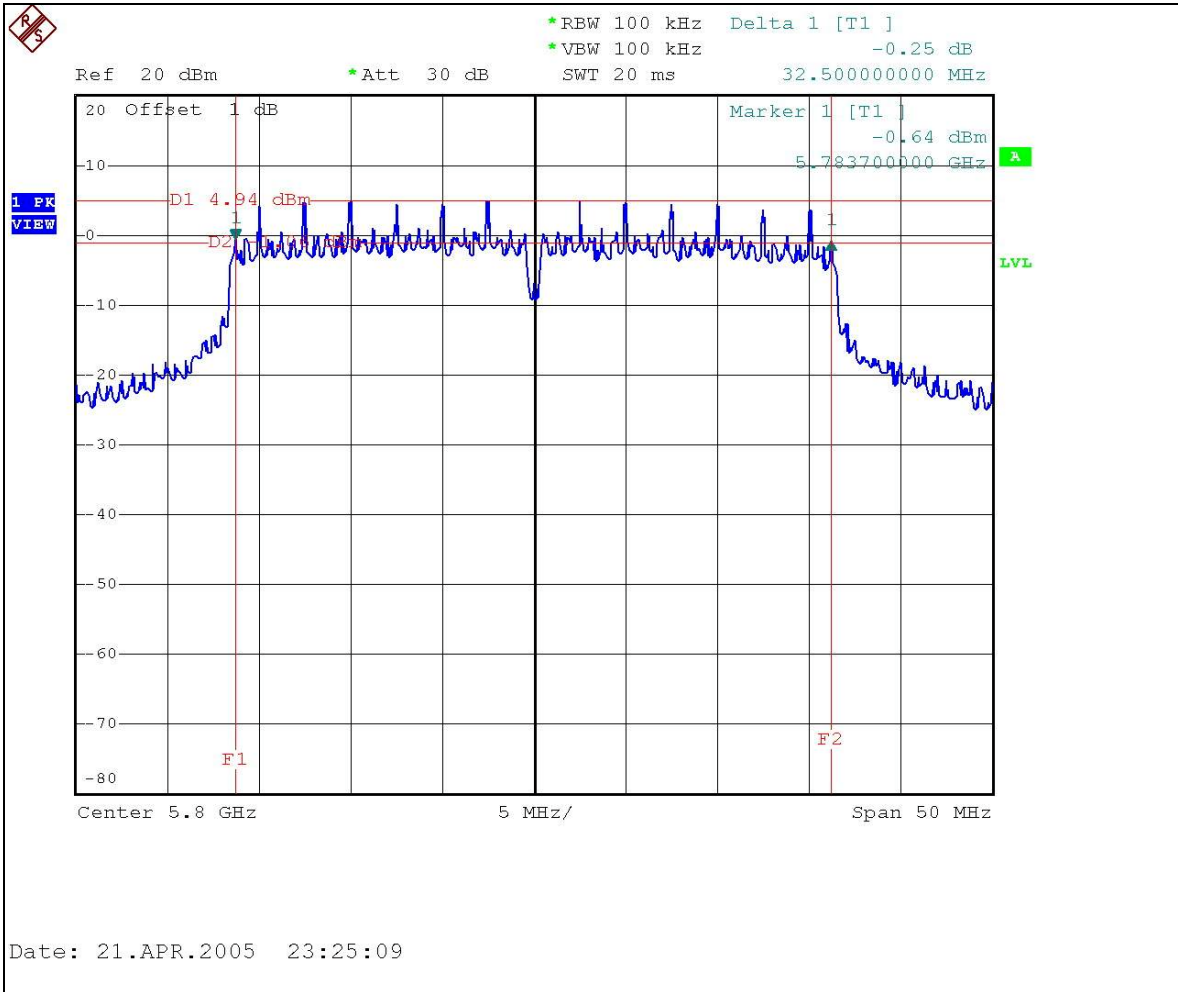



4.4 MAXIMUM PEAK OUTPUT POWER

4.4.1 LIMITS OF MAXIMUM PEAK OUTPUT POWER MEASUREMENT

The Maximum Peak Output Power Measurement is 30dBm.

4.4.2 INSTRUMENTS

Description & Manufacturer	Model No.	Serial No.	Calibrated Until
R&S SPECTRUM ANALYZER	FSP40	100036	Nov. 23, 2005
Agilent SIGNAL GENERATOR	E8257C	MY43320668	Dec. 07, 2005
TEKTRONIX OSCILLOSCOPE	TDS 220	B027241	Jun. 30, 2005
NARDA DETECTOR	4503A	FSCM99899	NA

NOTE:

The calibration interval of the above test instruments is 12 months and the calibrations are traceable to NML/ROC and NIST/USA.

4.4.3 TEST PROCEDURES

1. A detector was used on the output port of the EUT. An oscilloscope was used to read the response of the detector.
2. Replaced the EUT by the signal generator . The center frequency of the S.G was adjusted to the center frequency of the measured channel.
3. Adjusted the power to have the same reading on oscilloscope. Record the power level.

4.4.4 DEVIATION FROM TEST STANDARD

No deviation

4.4.5 TEST SETUP



4.4.6 EUT OPERATING CONDITIONS

Same as Item 4.3.6

4.4.7 TEST RESULTS

802.11a OFDM modulation

EUT	Bridging kit - 802.11a	MODEL	WL-464
MODULATION TYPE	BPSK	TRANSFER RATE	6Mbps
INPUT POWER (SYSTEM)	120Vac, 60 Hz	ENVIRONMENTAL CONDITIONS	27deg. C, 62%RH, 960 hPa
TESTED BY	Rex Huang		

Antenna 1 (Gain : 8 dBi) +Cable loss (1.2dB)

CHANNEL	CHANNEL FREQUENCY (MHz)	PEAK POWER OUTPUT (dBm)	PEAK POWER LIMIT (dBm)	PASS/FAIL
1	5745	19.34	29.2	PASS
5	5825	19.22	29.2	PASS

Antenna 2 (Gain : 10 dBi) +Cable loss (1.2dB)

CHANNEL	CHANNEL FREQUENCY (MHz)	PEAK POWER OUTPUT (dBm)	PEAK POWER LIMIT (dBm)	PASS/FAIL
1	5745	19.34	30	PASS
5	5825	19.22	30	PASS



Antenna 3 (Gain : 20 dBi) +Cable loss (1.2dB)

CHANNEL	CHANNEL FREQUENCY (MHz)	PEAK POWER OUTPUT (dBm)	PEAK POWER LIMIT (dBm)	PASS/FAIL
1	5745	19.34	30	PASS
5	5825	19.22	30	PASS

Antenna 4 (Gain : 2.5 dBi)

CHANNEL	CHANNEL FREQUENCY (MHz)	PEAK POWER OUTPUT (dBm)	PEAK POWER LIMIT (dBm)	PASS/FAIL
1	5745	19.34	30	PASS
5	5825	19.22	30	PASS

**802.11a Turbo OFDM modulation**

EUT	Bridging kit - 802.11a	MODEL	WL-464
MODULATION TYPE	BPSK	TRANSFER RATE	12Mbps
INPUT POWER (SYSTEM)	120Vac, 60 Hz	ENVIRONMENTAL CONDITIONS	27deg. C, 62%RH, 960 hPa
TESTED BY	Rex Huang		

Antenna 1 (Gain : 8 dBi) +Cable loss (1.2dB)

CHANNEL	CHANNEL FREQUENCY (MHz)	PEAK POWER OUTPUT (dBm)	PEAK POWER LIMIT (dBm)	PASS/FAIL
1	5760	19.38	29.2	PASS
2	5800	19.32	29.2	PASS

Antenna 2 (Gain : 10 dBi) +Cable loss (1.2dB)

CHANNEL	CHANNEL FREQUENCY (MHz)	PEAK POWER OUTPUT (dBm)	PEAK POWER LIMIT (dBm)	PASS/FAIL
1	5760	19.38	30	PASS
2	5800	19.32	30	PASS



Antenna 3 (Gain : 20 dBi) +Cable loss (1.2dB)

CHANNEL	CHANNEL FREQUENCY (MHz)	PEAK POWER OUTPUT (dBm)	PEAK POWER LIMIT (dBm)	PASS/FAIL
1	5760	19.38	30	PASS
2	5800	19.32	30	PASS

Antenna 4 (Gain : 2.5 dBi)

CHANNEL	CHANNEL FREQUENCY (MHz)	PEAK POWER OUTPUT (dBm)	PEAK POWER LIMIT (dBm)	PASS/FAIL
1	5760	19.38	30	PASS
2	5800	19.32	30	PASS