

EMC TEST REPORT

CFR 47 FCC Part 15.247

Report No. : TS08020044-EME

Model No. : WL-600

Issued Date : Feb. 18, 2008

Applicant: 3Com Corporation
350 Campus Drive, Marlborough, MA 01752-3064, USA

Test By: Intertek Testing Services Taiwan Ltd.
No. 11, Lane 275, Ko-Nan 1 Street, Chia-Tung Li,
Shiang-Shan District, Hsinchu City, Taiwan

This test report consists of 144 pages in total. It may be duplicated completely for legal use with the allowance of the applicant. It shall not be reproduced except in full, without the written approval of Intertek Laboratory. The test result(s) in this report only applies to the tested sample(s).

Report Engineer

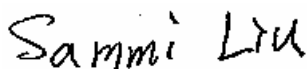

Sammi Liu

Project Engineer

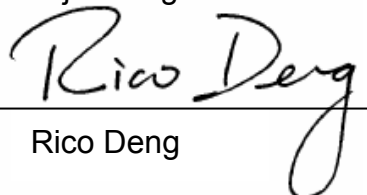

Rico Deng

Reviewed By



Kevin Chen

1. Summary of Test Data

Test/Requirement Description	Applicable Rule	Result
Minimum 6dB Bandwidth	15.247(a)(2)	Pass
Maximum Output Power	15.247(b)	Pass
Power Spectral Density	15.247(e)	Pass
RF Antenna Conducted Spurious	15.247(d)	Pass
Radiated Spurious Emission	15.247(d), 15.205, 15.209	Pass
Emission on the Band Edge	15.247(d)	Pass
AC Power Line Conducted Emission	15.207	Pass

2. General Information

Identification of the EUT

Applicant	: 3Com Corporation
Product	: 3Com Wireless 11n USB Adapter
Model No.	: WL-600
FCC ID.	: O9C-WL600
Frequency Range	: 2412MHz to 2462MHz for 802.11b, 802.11g, 802.11n 20MHz 2422MHz to 2452MHz for 802.11n 40MHz
Channel Number	: 11 channels for 802.11b, 802.11g, 802.11n 20MHz : 7 channels for 802.11n 40MHz
Rated Power	: DC 5V
Power Cord	: N/A
Sample Received	: Jun. 25, 2007
Test Date(s)	: Jun. 26, 2007 ~ Jul. 18, 2007

Description of EUT

The EUT is a 3Com Wireless 11n USB Adapter, it supports two transmission and receive MIMO functions, and was defined as information technology equipment.

For more detail features, please refer to User's manual as file name "Installation guide.pdf"

Antenna description**DAC0**

The EUT uses a permanently connected antenna.

Antenna Gain : -1.31dBi max
Antenna Type : PCB Printed
Connector Type : N/A

DAC1

The EUT uses a permanently connected antenna.

Antenna Gain : -1.31dBi max
Antenna Type : PCB Printed
Connector Type : N/A

3. Maximum 6dB Bandwidth

Name of Test	Maximum 6dB Bandwidth
Base Standard	FCC 15.247 a(2)

Tested By: Marx Yan
Test Date: Jul. 16, 2007

Test Equipment: EC365

Test Result: Complies
Test Method: See Appendix A
Measurement Data: See Table & plots below

Note: The EUT was tested while in a continuous transmit mode. The EUT was tuned to a low, middle and high channel.

Table1. Maximum 6dB Bandwidth

Mode	Channel	Frequency (MHz)	6dB Bandwidth (MHz)		Min. Limit (MHz)	Pass/Fail
			DAC0	DAC1		
802.11b	1	2412	12.56	12.56	0.5	Pass
	6	2437	12.72	12.72	0.5	Pass
	11	2462	12.72	12.72	0.5	Pass
802.11g	1	2412	16.80	16.80	0.5	Pass
	6	2437	16.80	16.80	0.5	Pass
	11	2462	16.80	16.80	0.5	Pass
802.11n 20MHz	1	2412	18.00	17.92	0.5	Pass
	6	2437	17.92	17.92	0.5	Pass
	11	2462	18.00	17.92	0.5	Pass
802.11n 40MHz	3	2422	36.80	36.80	0.5	Pass
	6	2437	36.80	36.80	0.5	Pass
	9	2452	36.80	36.80	0.5	Pass

DAC0: 6dB Bandwidth @ 802.11b mode channel 1

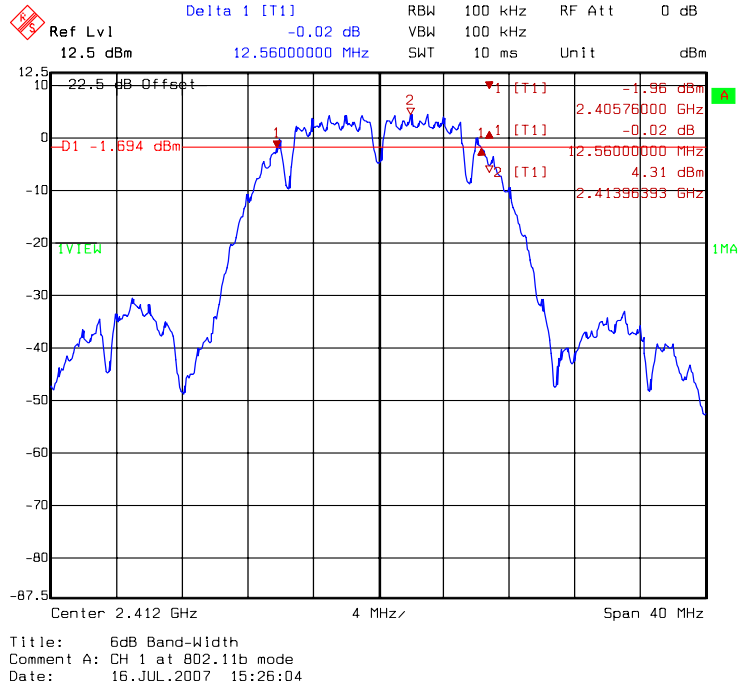

DAC0: 6dB Bandwidth @ 802.11b mode channel 6

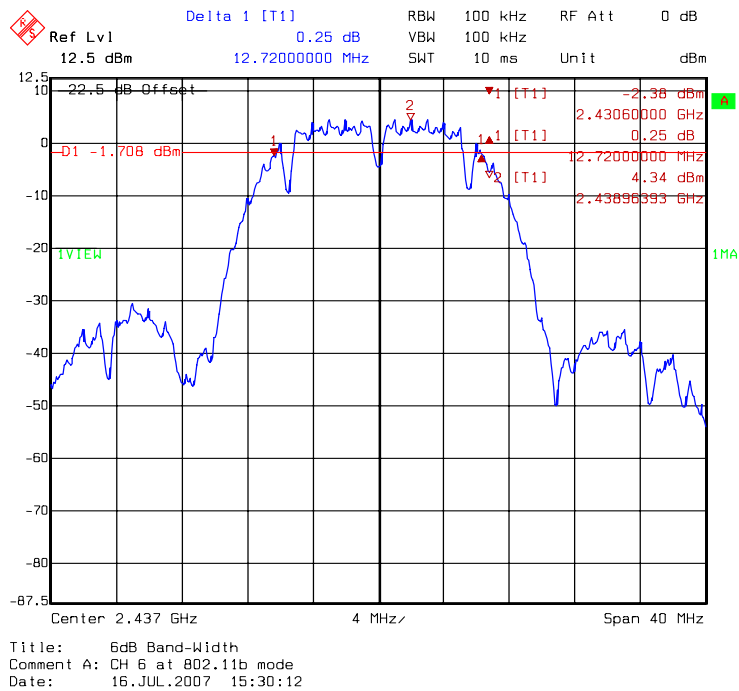

DAC0: 6dB Bandwidth @ 802.11b mode channel 11

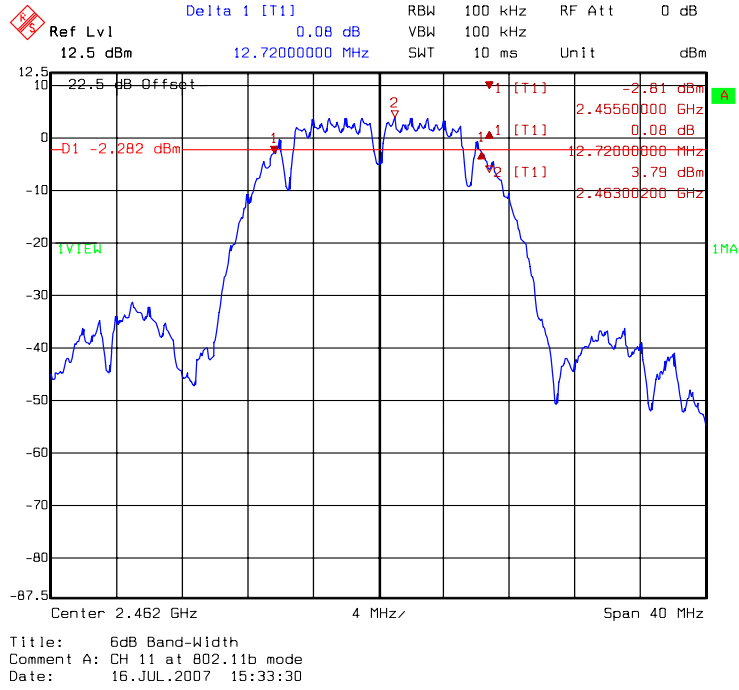

DAC0: 6dB Bandwidth @ 802.11g mode channel 1

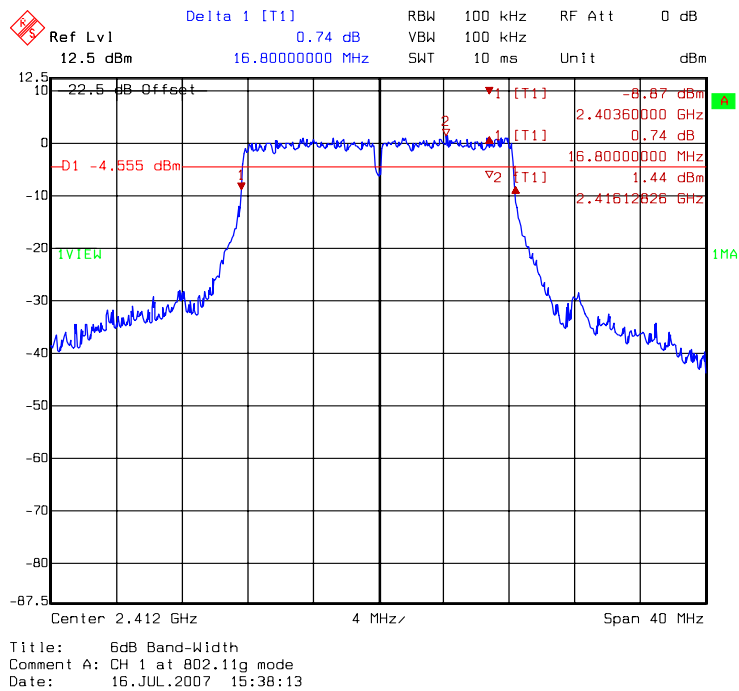

DAC0: 6dB Bandwidth @ 802.11g mode channel 6

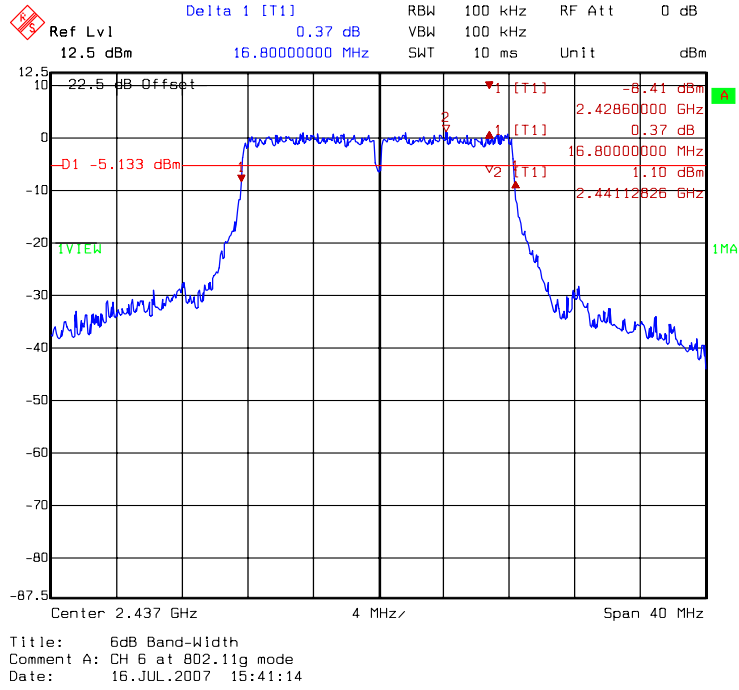

DAC0: 6dB Bandwidth @ 802.11g mode channel 11

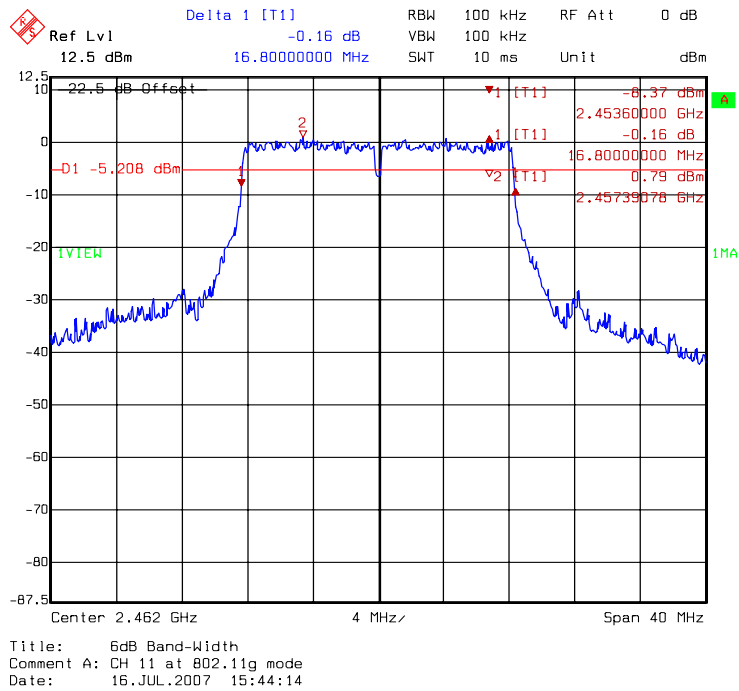

DAC0: 6dB Bandwidth @ draft 802.11n 20MHz mode channel 1

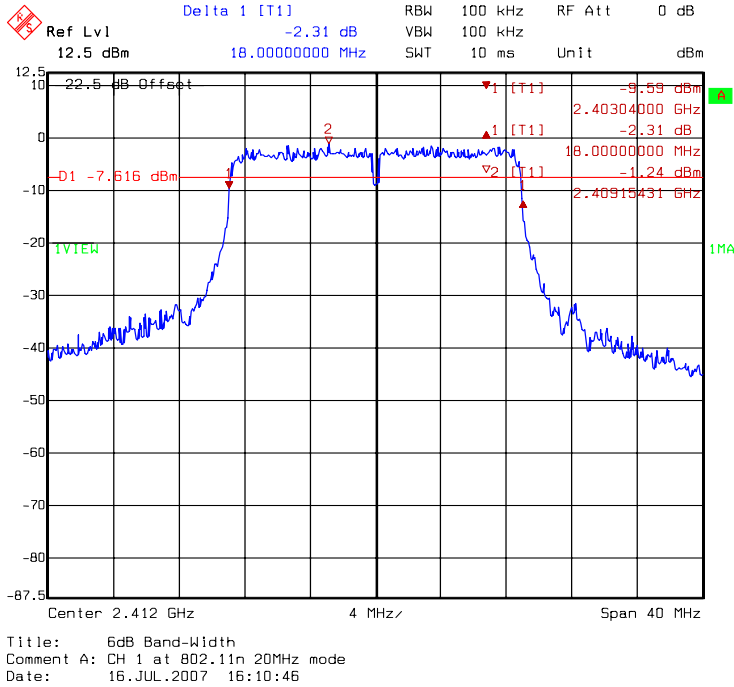

DAC0: 6dB Bandwidth @ draft 802.11n 20MHz mode channel 6

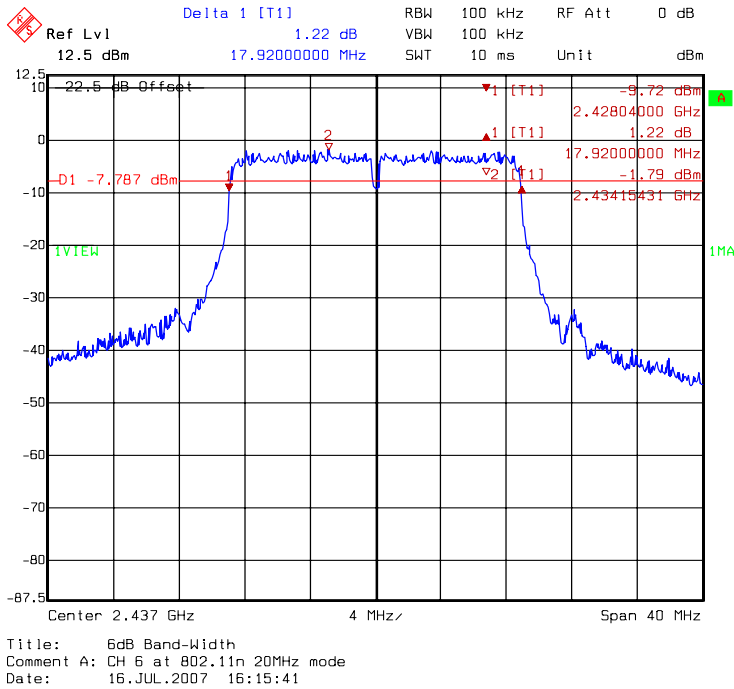

DAC0: 6dB Bandwidth @ draft 802.11n 20MHz mode channel 11

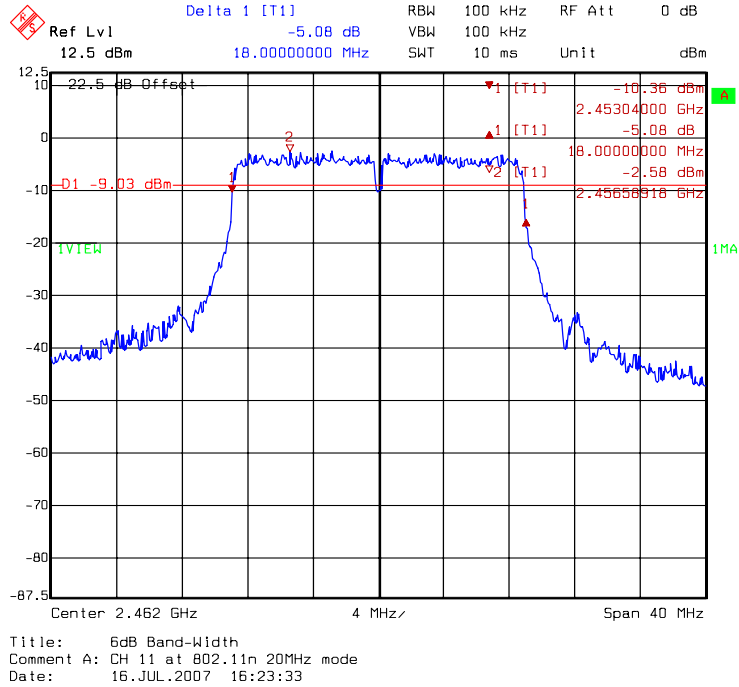

DAC0: 6dB Bandwidth @ draft 802.11n 40MHz mode channel 3

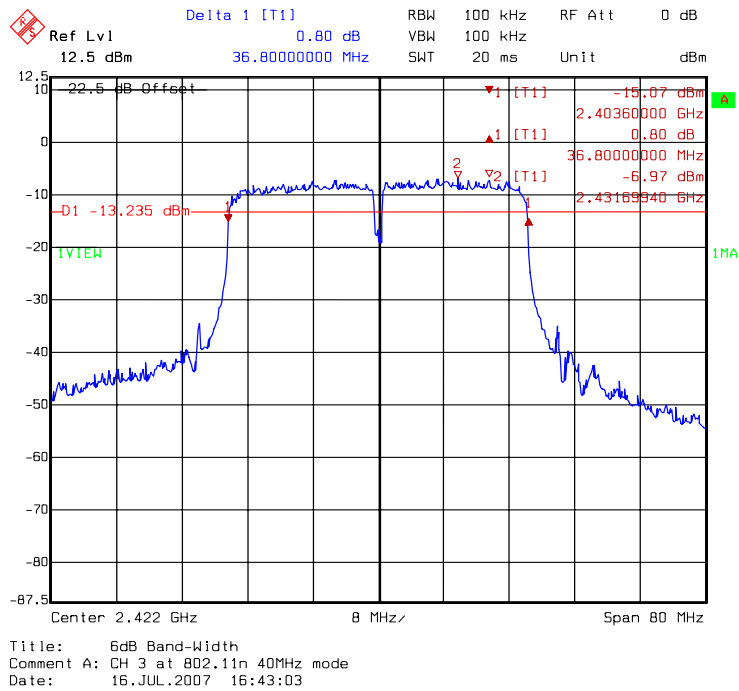

DAC0: 6dB Bandwidth @ draft 802.11n 40MHz mode channel 6

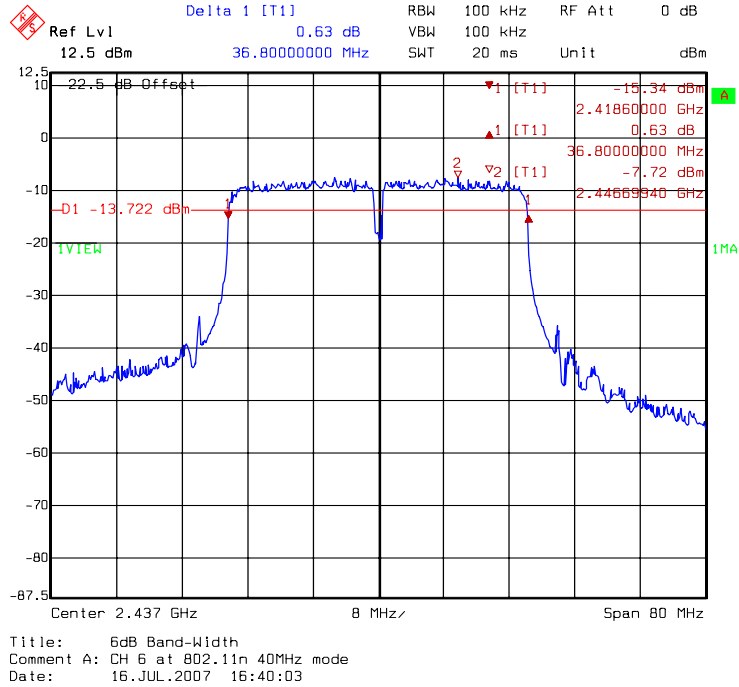

DAC0: 6dB Bandwidth @ draft 802.11n 40MHz mode channel 9

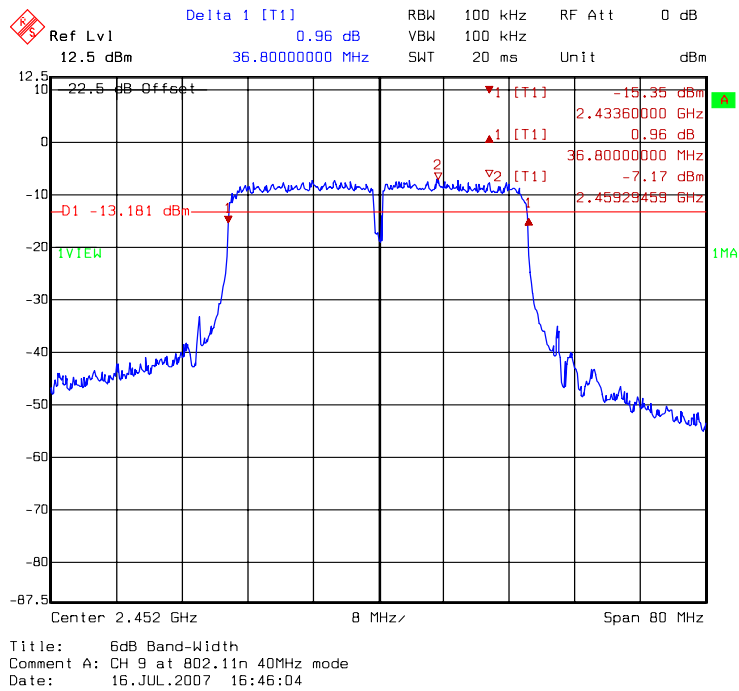

DAC1: 6dB Bandwidth @ 802.11b mode channel 1

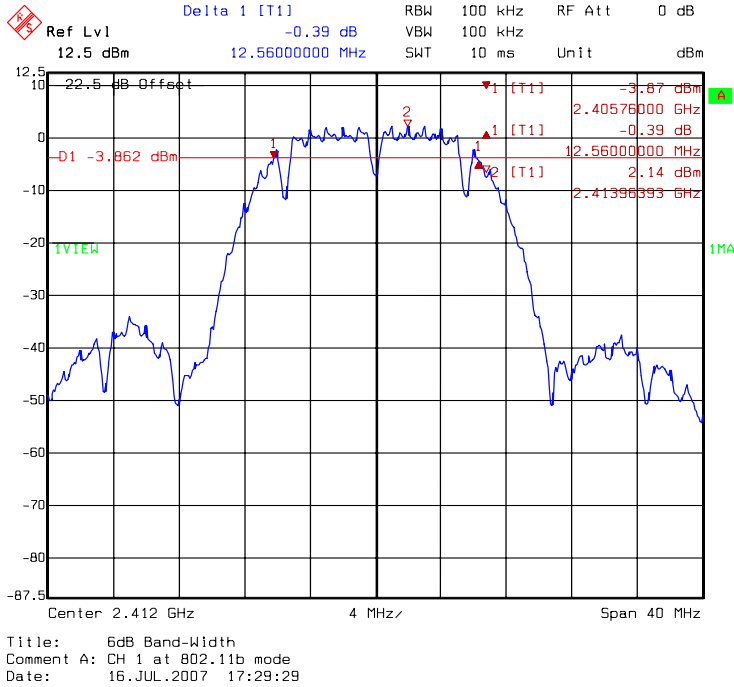

DAC1: 6dB Bandwidth @ 802.11b mode channel 6

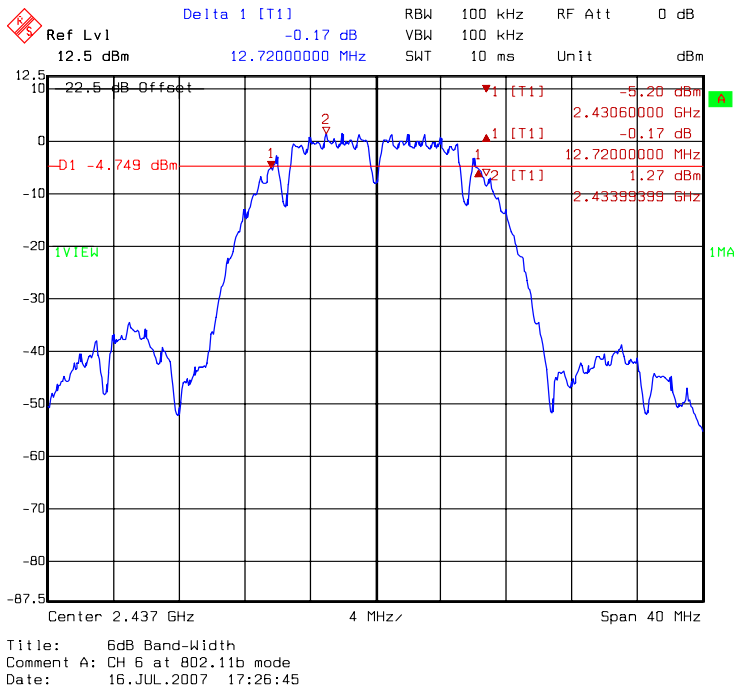

DAC1: 6dB Bandwidth @ 802.11b mode channel 11

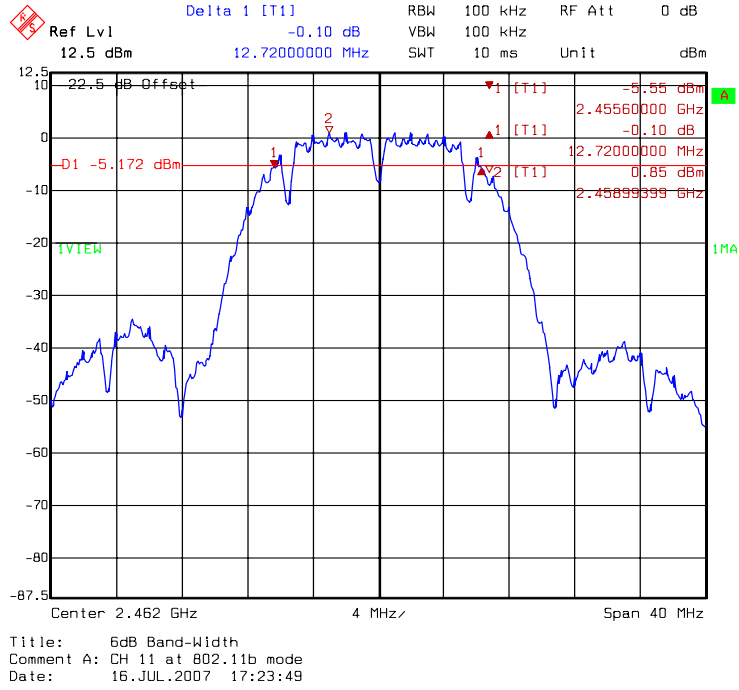

DAC1: 6dB Bandwidth @ 802.11g mode channel 1

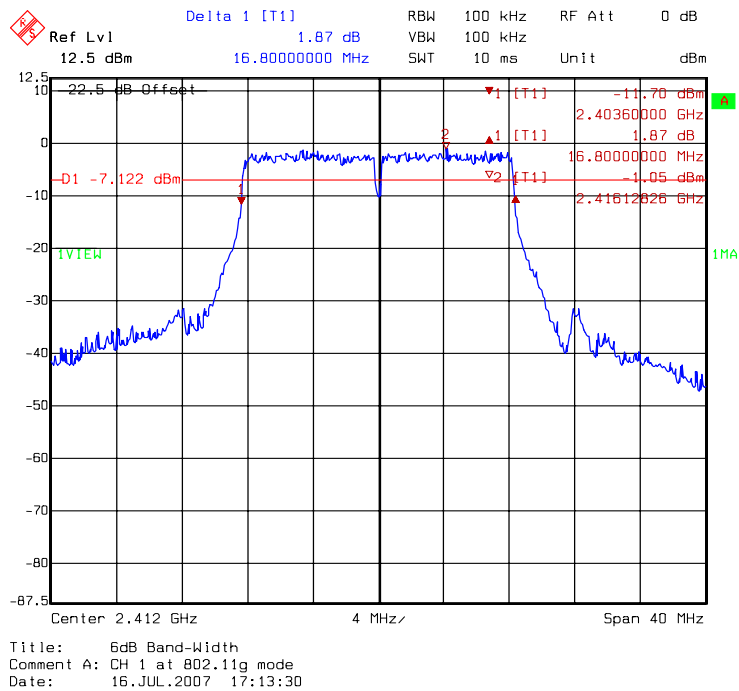

DAC1: 6dB Bandwidth @ 802.11g mode channel 6

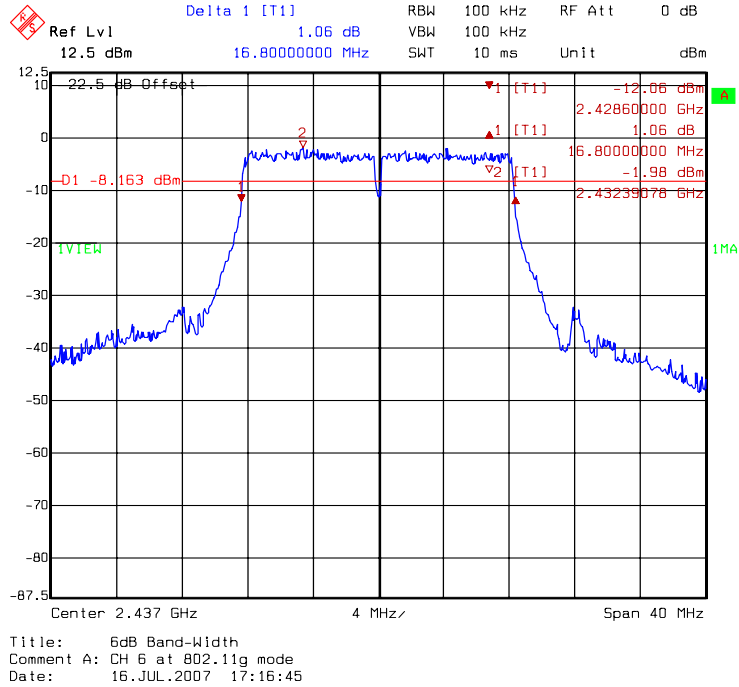

DAC1: 6dB Bandwidth @ 802.11g mode channel 11

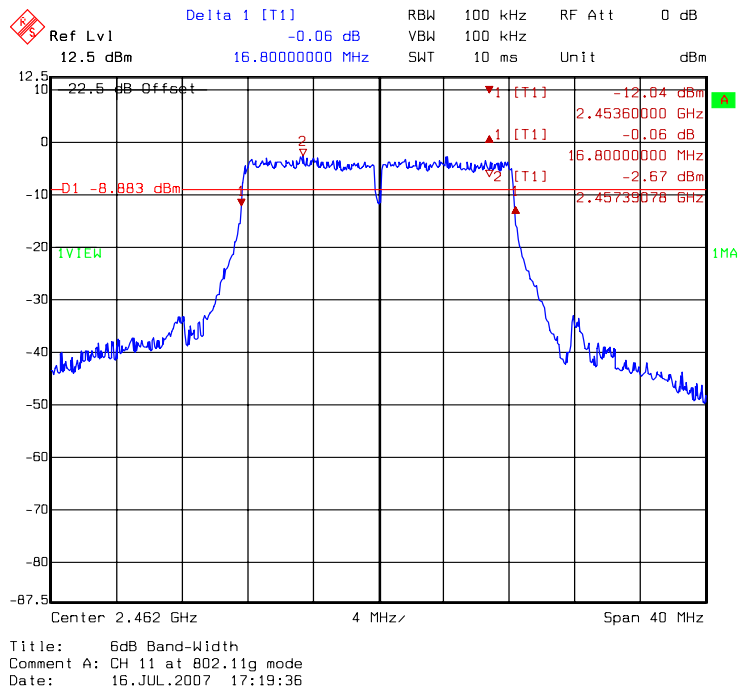

DAC1: 6dB Bandwidth @ draft 802.11n 20MHz mode channel 1

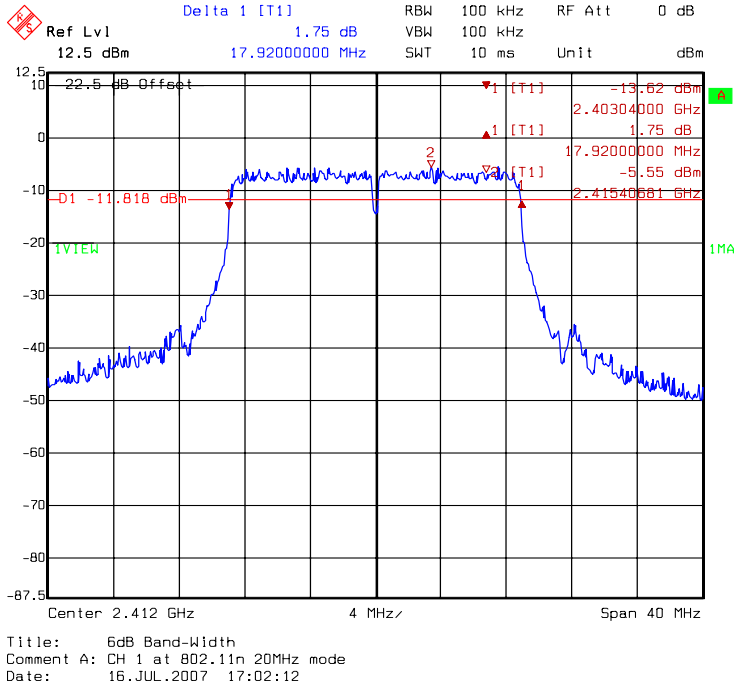

DAC1: 6dB Bandwidth @ draft 802.11n 20MHz mode channel 6

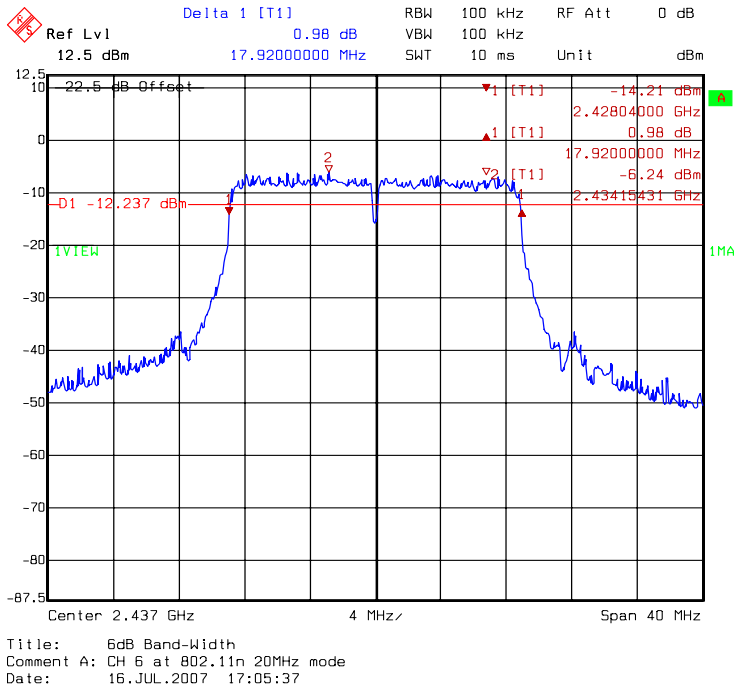

DAC1: 6dB Bandwidth @ draft 802.11n 20MHz mode channel 11

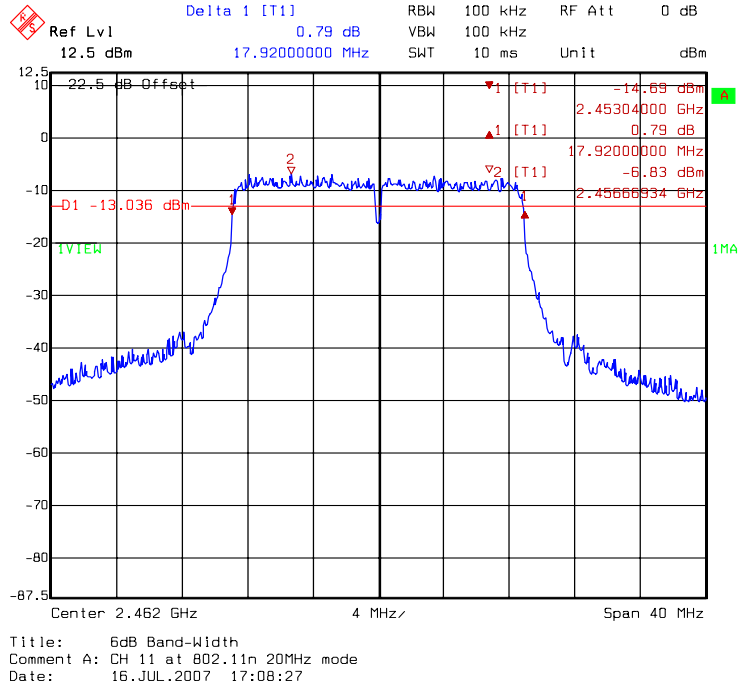

DAC1: 6dB Bandwidth @ draft 802.11n 40MHz mode channel 3

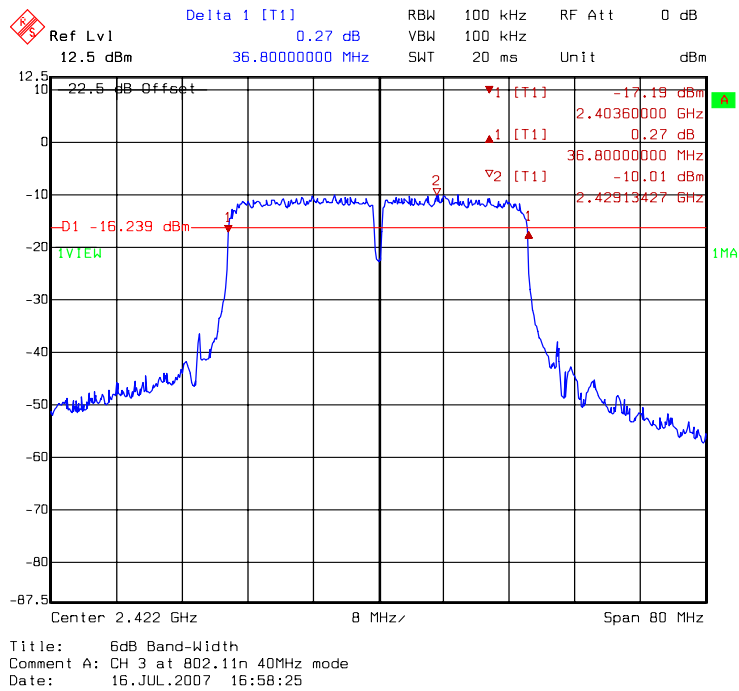

DAC1: 6dB Bandwidth @ draft 802.11n 40MHz mode channel 6

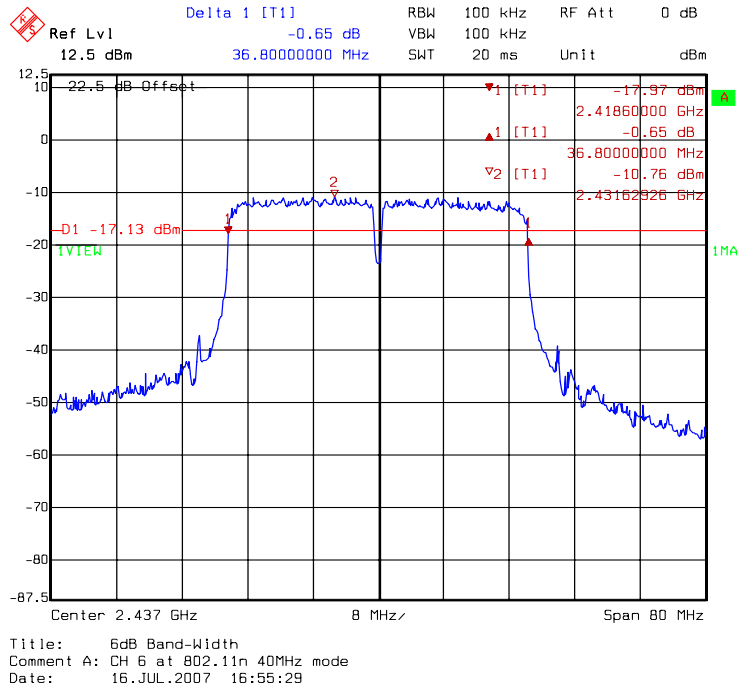

DAC1: 6dB Bandwidth @ draft 802.11n 40MHz mode channel 9

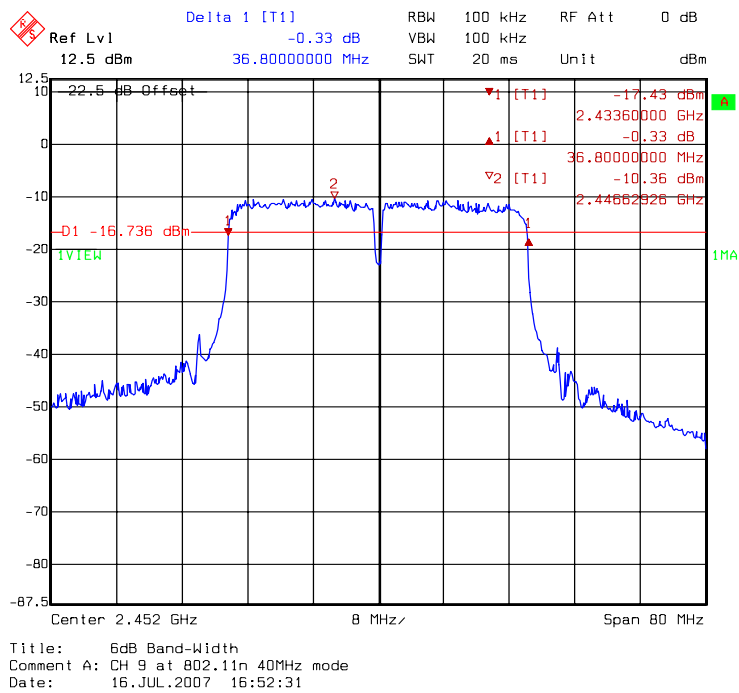

4. 99% Occupied Bandwidth

Name of Test	99% Occupied Bandwidth
Base Standard	None; for reporting purposes only

Tested By: Marx Yan
Test Date: Jul. 18, 2007

Test Equipment: EC365

Test Result: Complies
Test Method: See Appendix A
Measurement Data: See Table & plots below

Note: The EUT was tested while in a continuous transmit mode. The EUT was tuned to a low, middle and high channel.

Table2. 99% Occupied Bandwidth

Mode	Channel	Frequency (MHz)	99% Bandwidth (MHz)	
			DAC0	DAC1
802.11b	1	2412	14.99	14.91
	6	2437	14.91	14.99
	11	2462	14.91	14.99
802.11g	1	2412	16.51	16.43
	6	2437	16.51	16.51
	11	2462	16.51	16.51
802.11n 20MHz	1	2412	17.64	17.64
	6	2437	17.64	17.64
	11	2462	17.64	17.64
802.11n 40MHz	3	2422	36.07	36.07
	6	2437	36.07	36.07
	9	2452	36.07	36.07

DAC0: 99% Occupied Bandwidth @ 802.11b mode channel 1

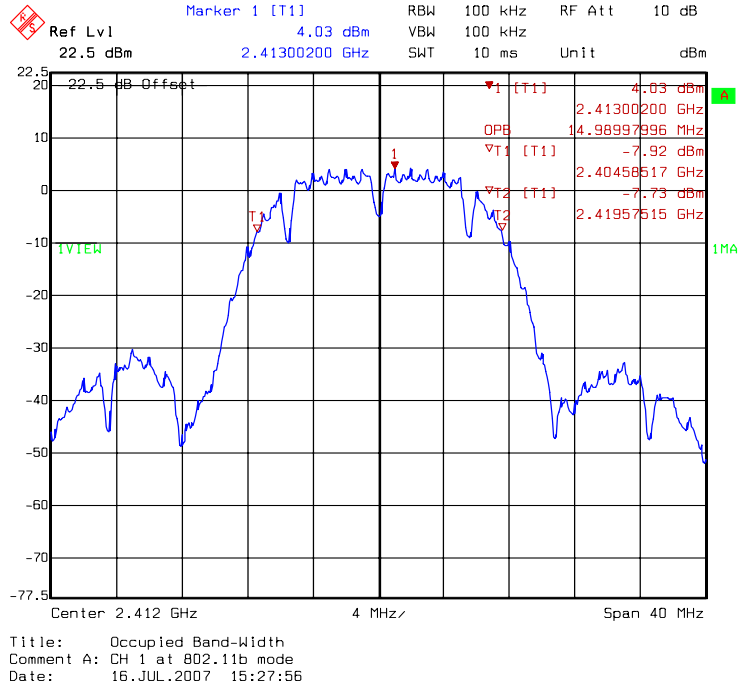

DAC0: 99% Occupied Bandwidth @ 802.11b mode channel 6

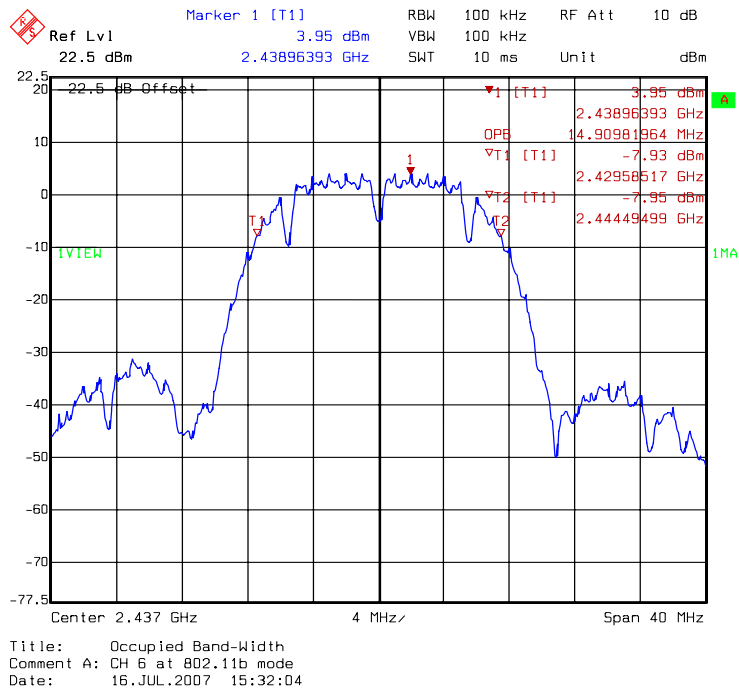

DAC0: 99% Occupied Bandwidth @ 802.11b mode channel 11

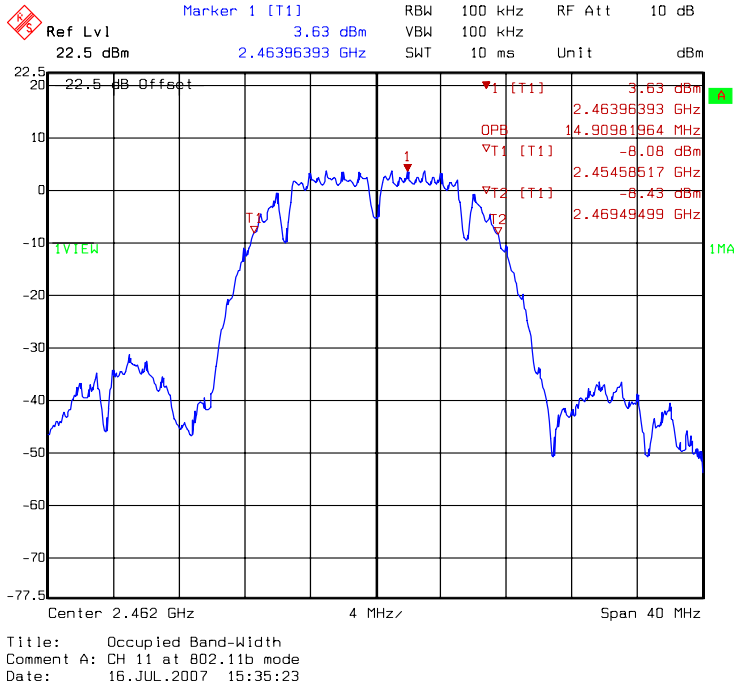

DAC0: 99% Occupied Bandwidth @ 802.11g mode channel 1

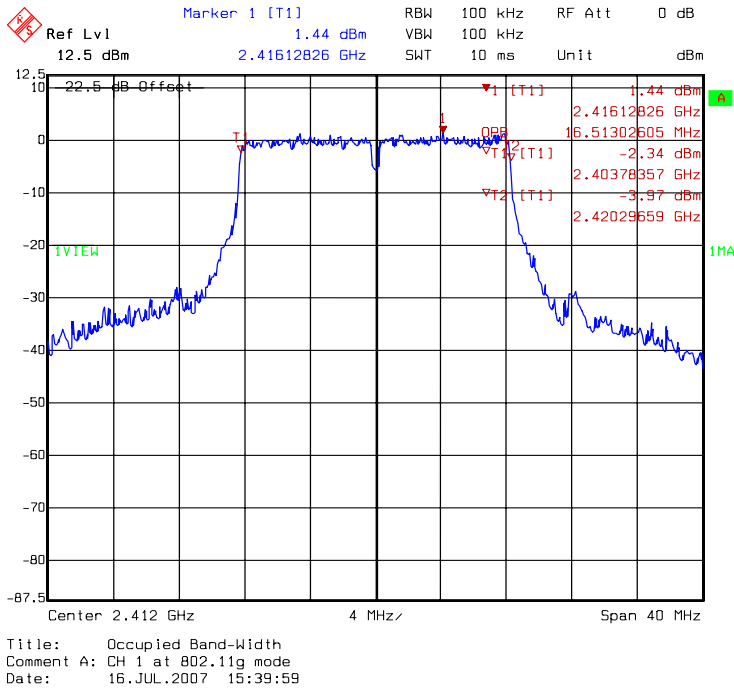

DAC0: 99% Occupied Bandwidth @ 802.11g mode channel 6

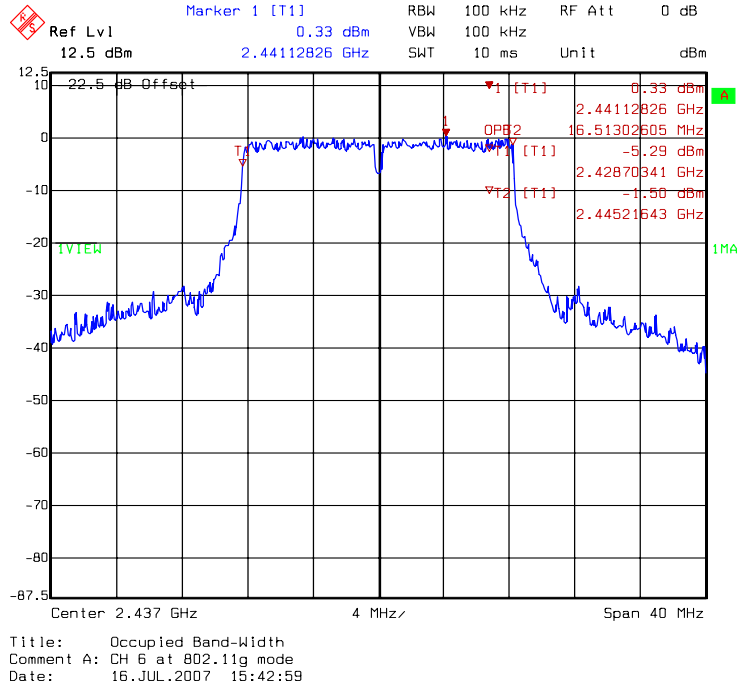

DAC0: 99% Occupied Bandwidth @ 802.11g mode channel 11

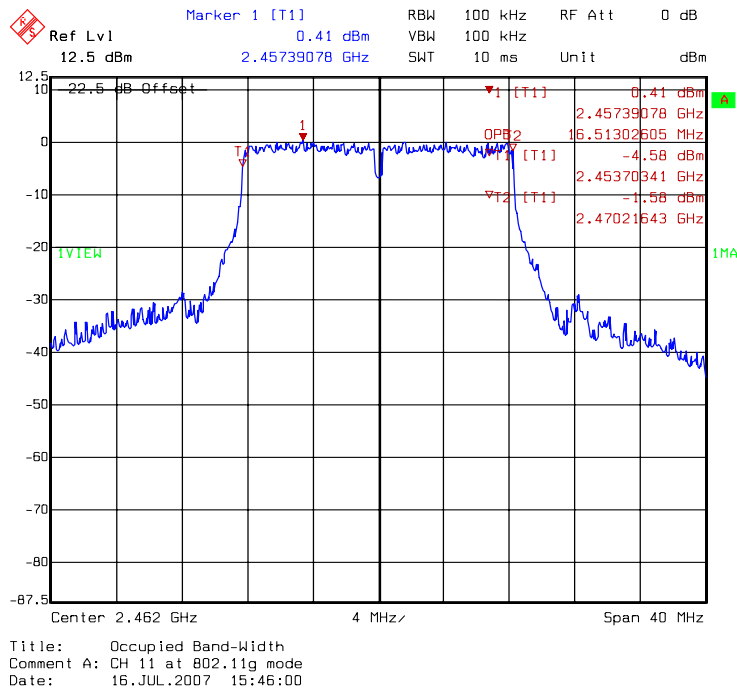

DAC0: 99% Occupied Bandwidth @ draft 802.11n 20MHz mode channel 1

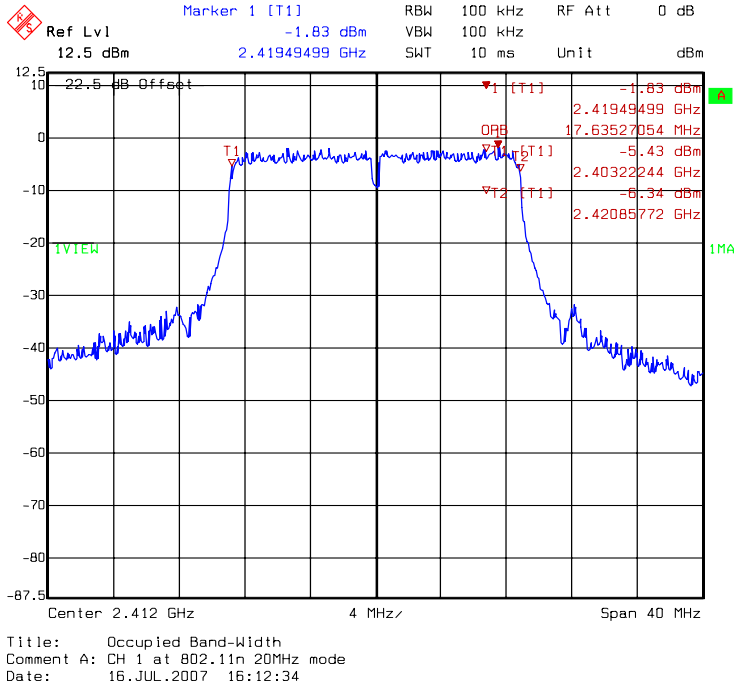

DAC0: 99% Occupied Bandwidth @ draft 802.11n 20MHz mode channel 6

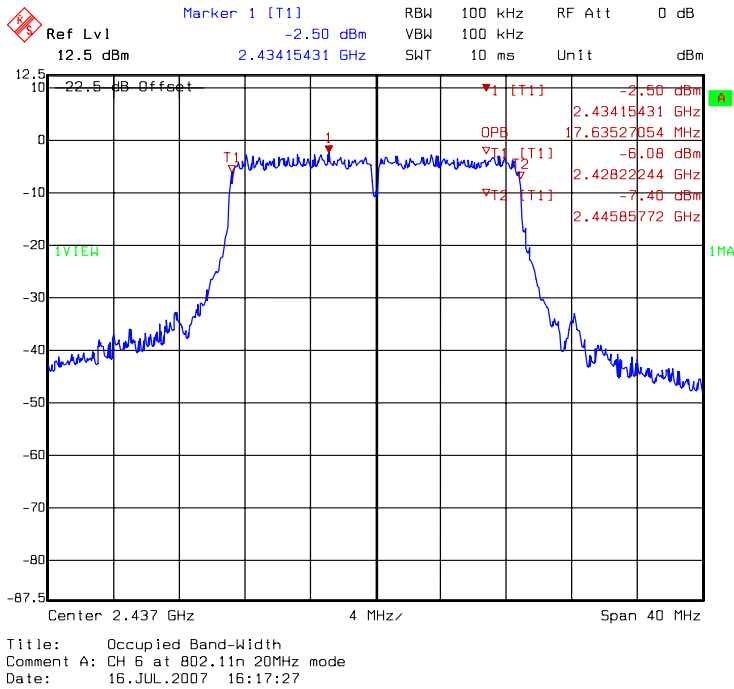

DAC0: 99% Occupied Bandwidth @ draft 802.11n 20MHz mode channel 11

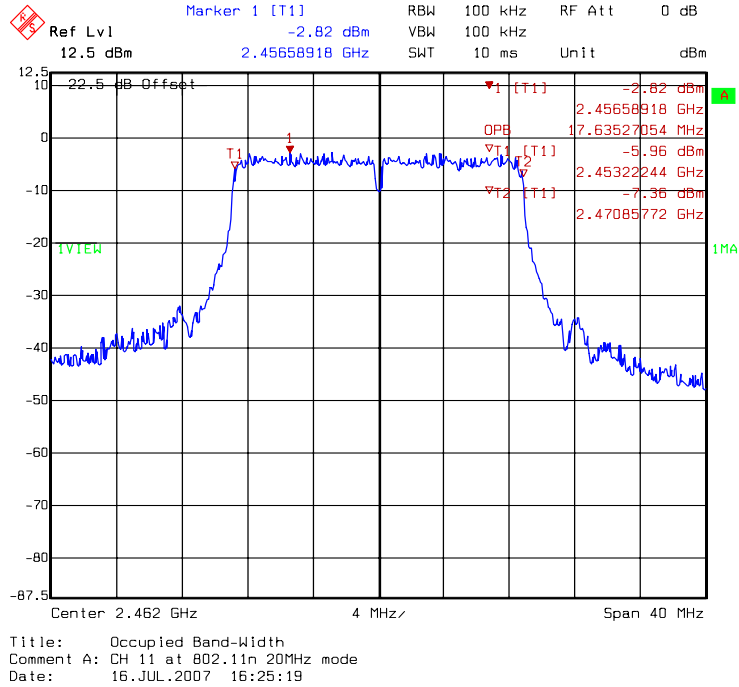

DAC0: 99% Occupied Bandwidth @ draft 802.11n 40MHz mode channel 3

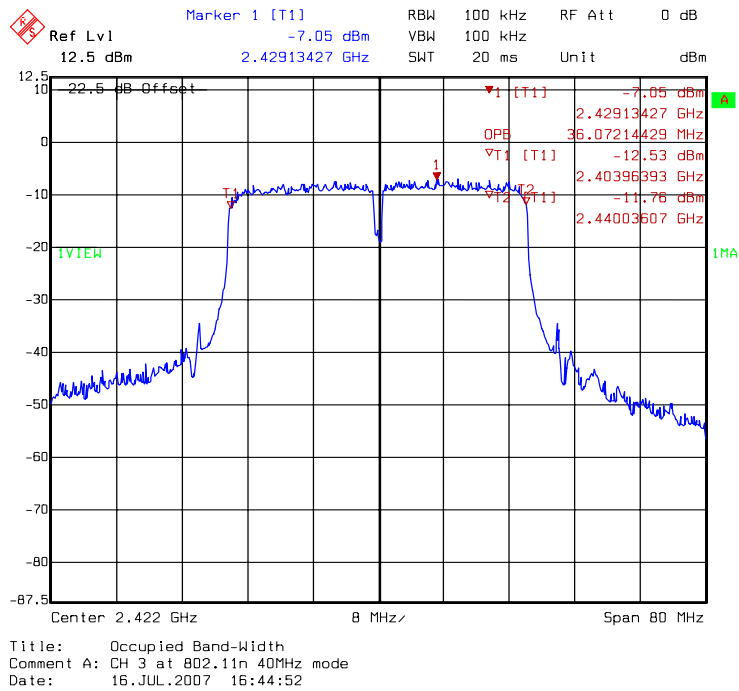

DAC0: 99% Occupied Bandwidth @ draft 802.11n 40MHz mode channel 6

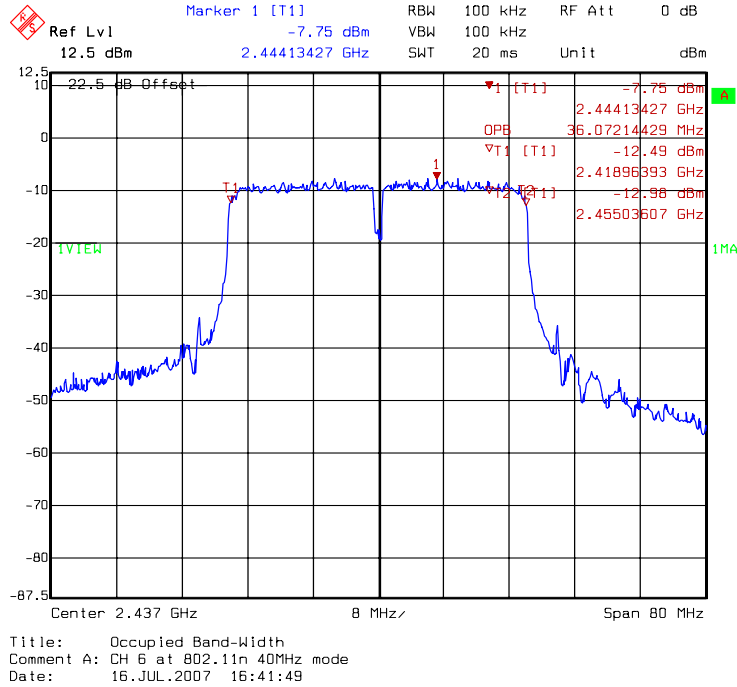

DAC0: 99% Occupied Bandwidth @ draft 802.11n 40MHz mode channel 9

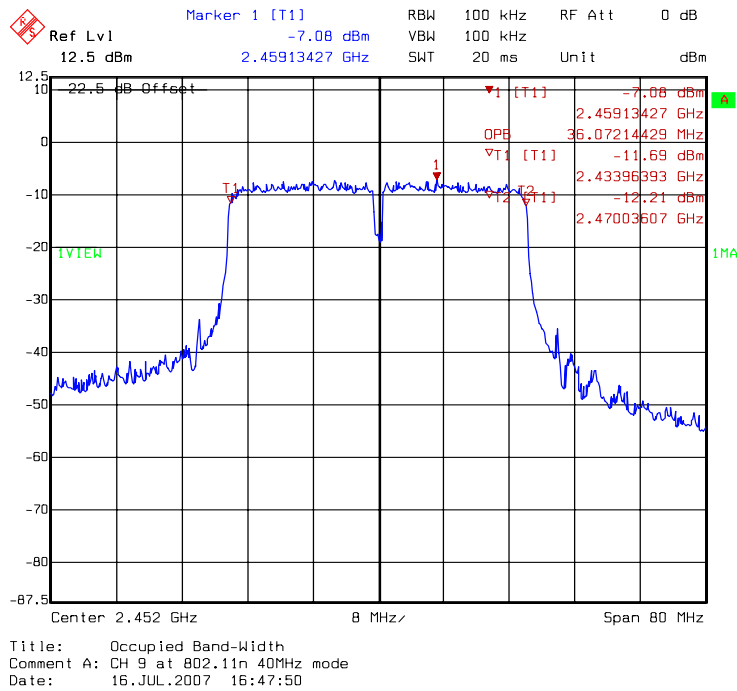

DAC1: 99% Occupied Bandwidth @ 802.11b mode channel 1

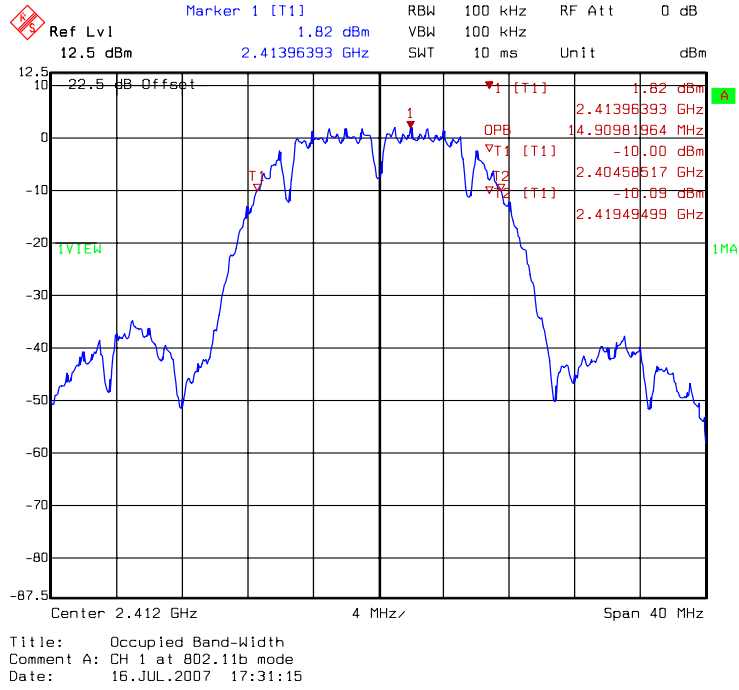

DAC1: 99% Occupied Bandwidth @ 802.11b mode channel 6

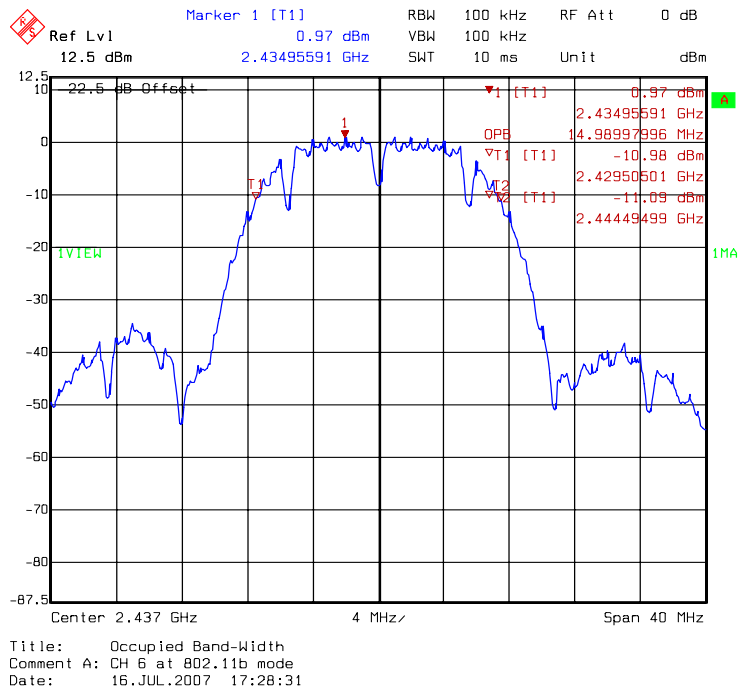

DAC1: 99% Occupied Bandwidth @ 802.11b mode channel 11

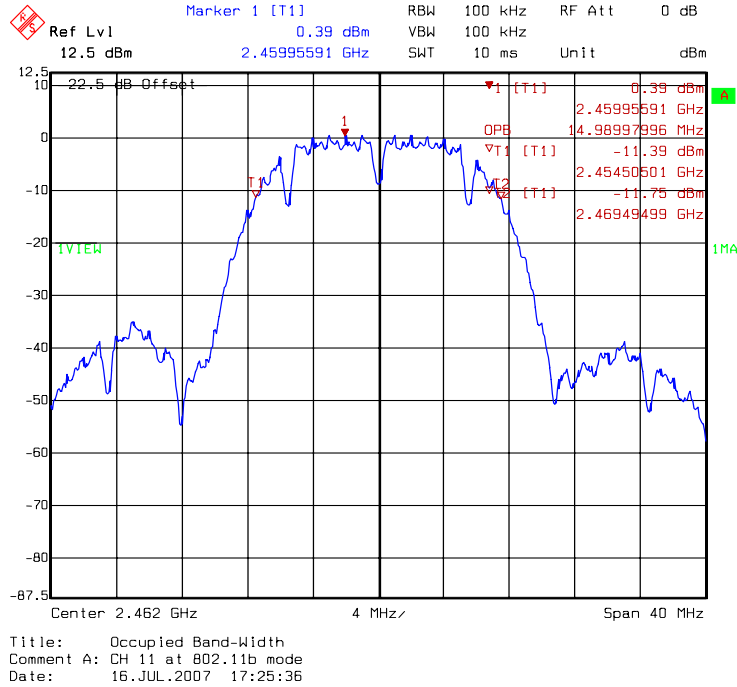

DAC1: 99% Occupied Bandwidth @ 802.11g mode channel 1

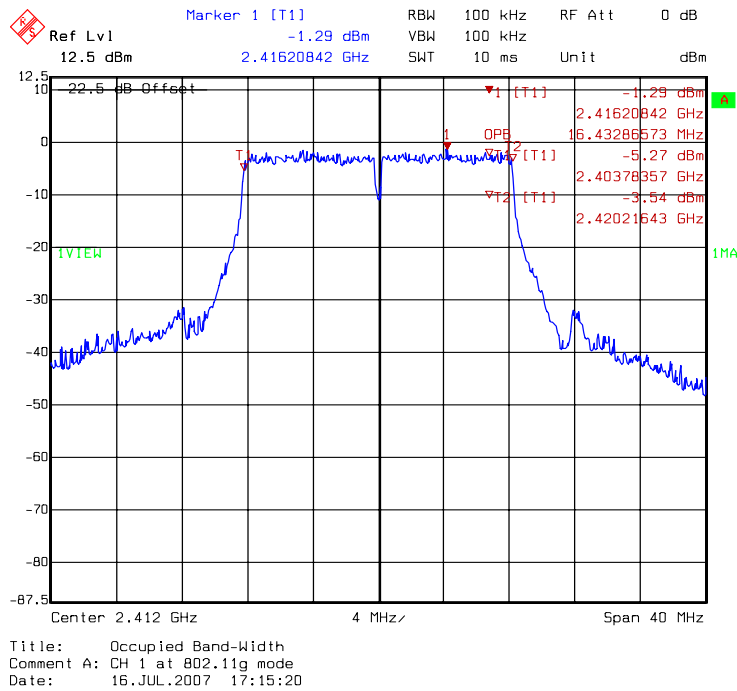

DAC1: 99% Occupied Bandwidth @ 802.11g mode channel 6

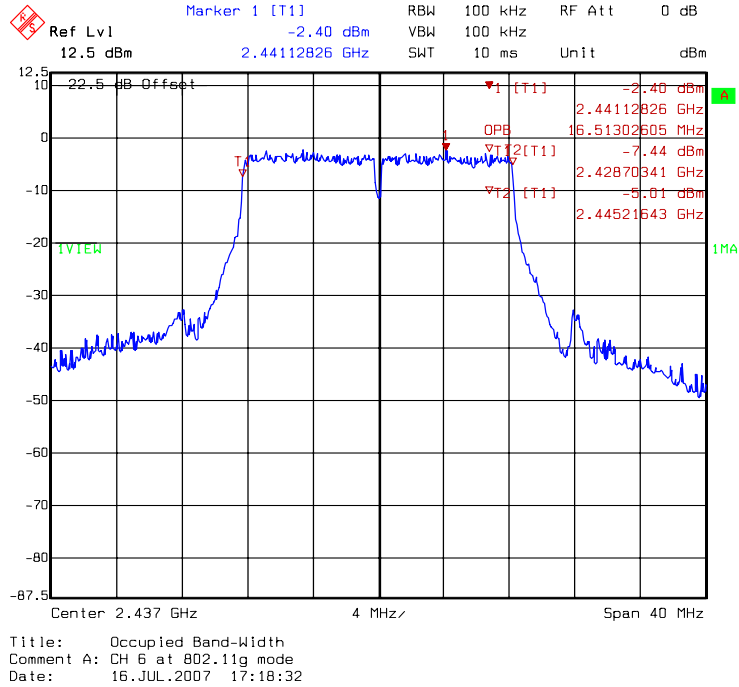

DAC1: 99% Occupied Bandwidth @ 802.11g mode channel 11

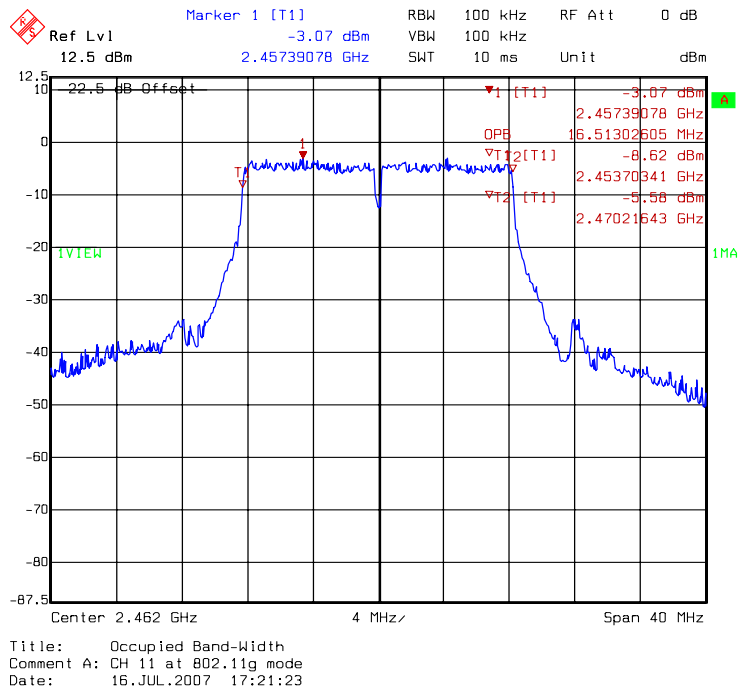

DAC1: 99% Occupied Bandwidth @ draft 802.11n 20MHz mode channel 1

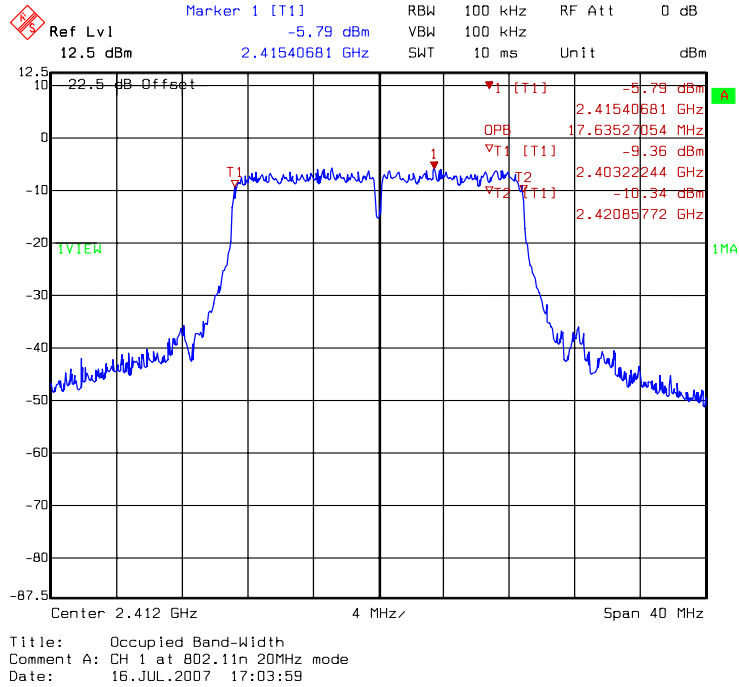

DAC1: 99% Occupied Bandwidth @ draft 802.11n 20MHz mode channel 6

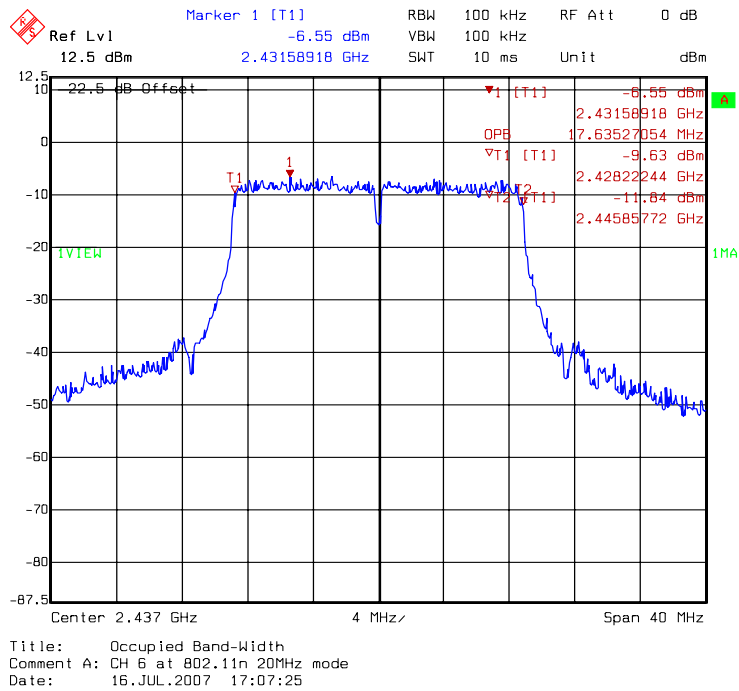

DAC1: 99% Occupied Bandwidth @ draft 802.11n 20MHz mode channel 11

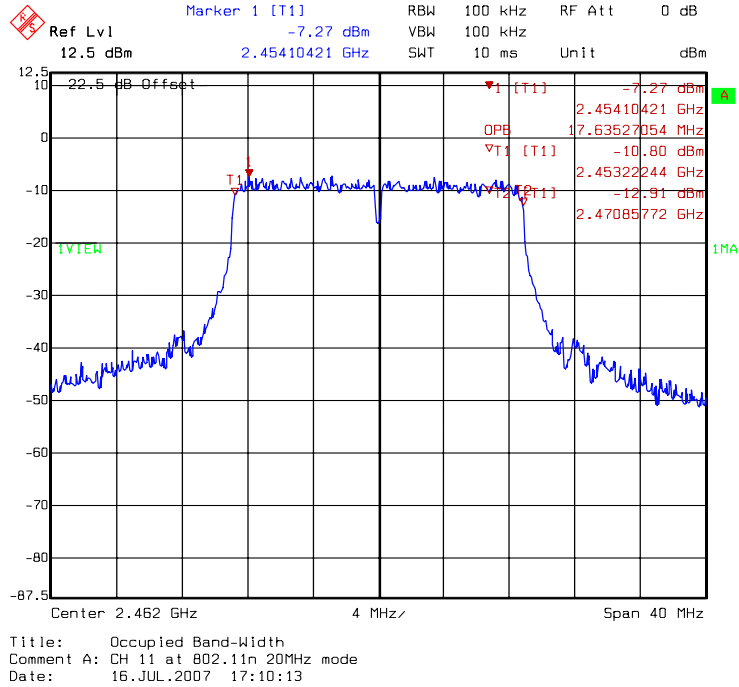

DAC1: 99% Occupied Bandwidth @ draft 802.11n 40MHz mode channel 3

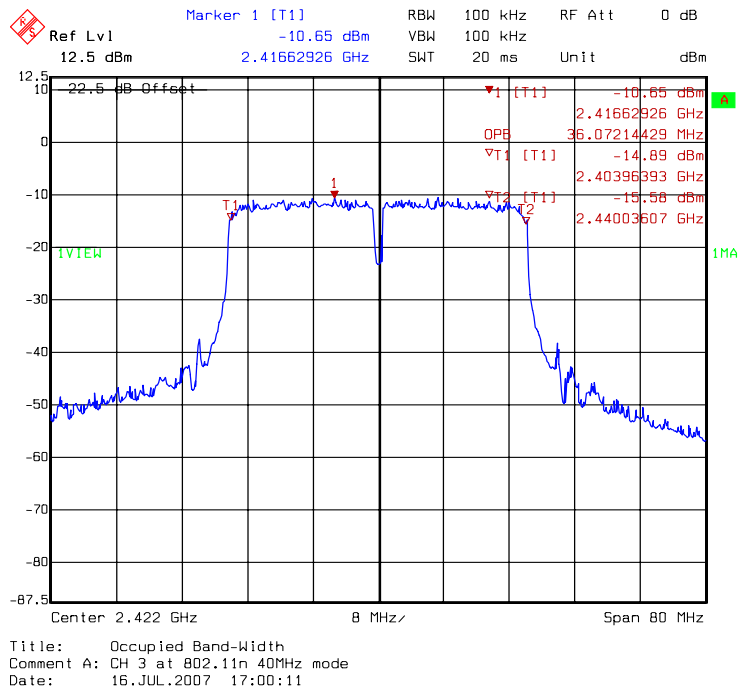

DAC1: 99% Occupied Bandwidth @ draft 802.11n 40MHz mode channel 6

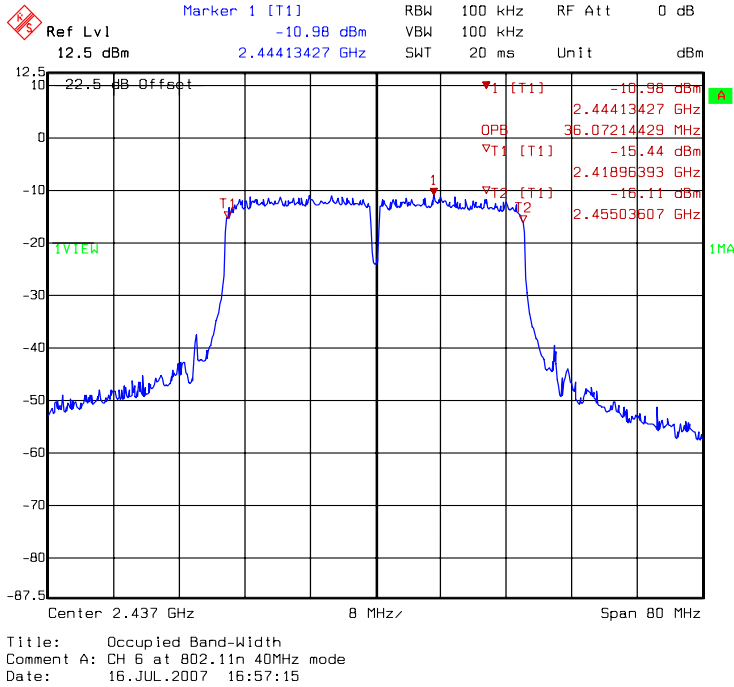

DAC1: 99% Occupied Bandwidth @ draft 802.11n 40MHz mode channel 9

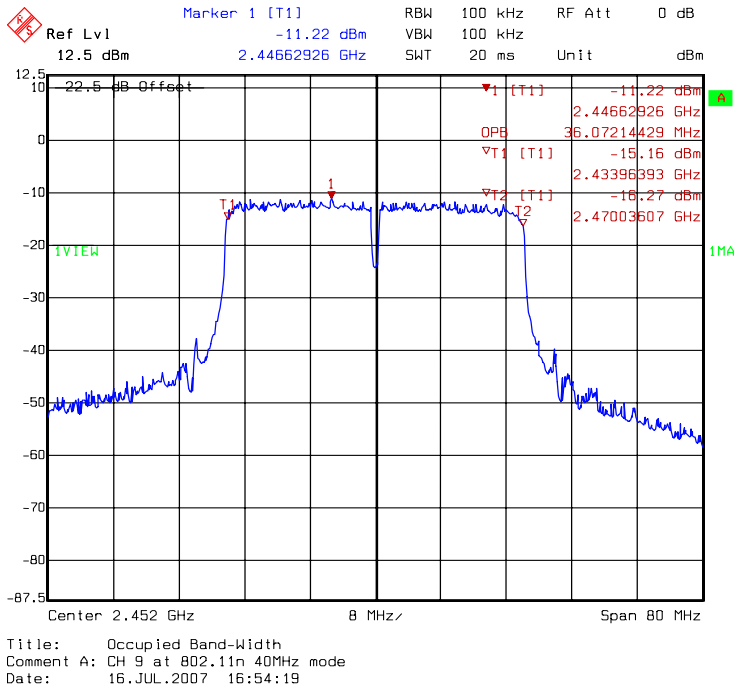

5. Maximum Output Power

Name of Test	Maximum output power
Base Standard	FCC 15.247(b)

Tested By: Marx Yan
Test Date: May 31, 2007

Test Equipment: EC396, EC396-1
Measurement Uncertainty: ±2dB (k=2)

Test Result: Complies
Test Method: See Appendix B
Measurement Data: See Table below

Note: The EUT was tested while in a continuous transmit mode. The EUT was tuned to a low, middle and high channel.

Table3. Maximum output power
Single Tx

Mode	Channel	Frequency (MHz)	Output Power (dBm)				Limit (dBm)	Margin (dB)
			DAC0		DAC1			
			PK	AV	PK	AV		
802.11b	1	2412	20.16	17.24	20.45	17.23	30	-9.44
	6	2437	20.02	17.12	20.13	17.15	30	-9.40
	11	2462	20.01	17.12	20.11	17.06	30	-9.40
802.11g	1	2412	25.21	16.15	25.85	16.21	30	-5.66
	6	2437	25.34	16.08	25.68	16.1	30	-5.26
	11	2462	25.65	16.38	25.38	16.04	30	-5.53
802.11n 20MHz	1	2412	21.43	12.15	21.38	12.32	30	-6.28
	6	2437	21.53	12.23	21.29	12.28	30	-6.00
	11	2462	21.82	12.23	21.03	12.05	30	-6.09
802.11n 40MHz	3	2422	20.28	11.05	20.37	11.38	30	-9.90
	6	2437	20.17	11.02	20.45	11.12	30	-9.74
	9	2452	20.53	11.04	20.48	11.18	30	-9.78

Dual Tx

Mode	Channel	Frequency (MHz)	Output Power (dBm)				Total Power (PK)		Total Power (AV)		Limit (dBm)
			DAC0		DAC1		mW	dBm	mW	dBm	
			PK	AV	PK	AV					
802.11n 20MHz	1	2412	21.43	12.15	21.38	12.32	276.40	24.42	33.47	15.25	30
	6	2437	21.53	12.23	21.29	12.28	276.82	24.42	33.62	15.27	30
	11	2462	21.82	12.23	21.03	12.05	278.82	24.45	32.74	15.15	30
802.11n 40MHz	3	2422	20.28	11.05	20.37	11.38	215.55	23.34	26.48	14.23	30
	6	2437	20.17	11.02	20.45	11.12	214.91	23.32	25.59	14.08	30
	9	2452	20.53	11.04	20.48	11.18	224.67	23.52	25.83	14.12	30

6. Power Spectral Density

Name of Test	Power Spectral Density
Base Standard	FCC 15.247(e)

Tested By: Marx Yan
Test Date: Jul. 18, 2007

Test Equipment: EC365

Test Result: Complies
Test Method: See Appendix C
Measurement Data: See Table & plots below

Note: The EUT was tested while in a continuous transmit mode. The EUT was tuned to a low, middle and high channel.

Table4. Power Spectral Density
Single Tx

Mode	Channel	Frequency (MHz)	PSD (dBm)		Limit (dBm)	Margin (dB)
			DAC0	DAC1		
802.11b	1	2412	-13.42	-15.45	30	-9.44
	6	2437	-13.07	-16.46	30	-9.40
	11	2462	-13.81	-17.01	30	-9.40
802.11g	1	2412	-12.29	-15.15	30	-5.66
	6	2437	-13.58	-16.48	30	-5.26
	11	2462	-13.10	-16.77	30	-5.53
802.11n 20MHz	1	2412	-15.23	-19.12	30	-6.28
	6	2437	-16.73	-20.62	30	-6.00
	11	2462	-16.2	-20.87	30	-6.09
802.11n 40MHz	3	2422	-20.00	-23.40	30	-9.90
	6	2437	-20.07	-24.01	30	-9.74
	9	2452	-20.35	-23.89	30	-9.78

Dual Tx

Mode	Channel	Frequency (MHz)	PSD (dBm)		Total Power		Limit (dBm)	Margin (dB)
			DAC0	DAC1	mW	dBm		
802.11n 20MHz	1	2412	-15.23	-19.12	0.04	-13.74	8	-21.74
	6	2437	-16.73	-20.62	0.03	-15.24	8	-23.24
	11	2462	-16.20	-20.87	0.03	-14.93	8	-22.93
802.11n 40MHz	3	2422	-20.00	-23.40	0.01	-18.37	8	-26.37
	6	2437	-20.07	-24.01	0.01	-18.60	8	-26.60
	9	2452	-20.35	-23.89	0.01	-18.76	8	-26.76

Single Tx

DAC0: Power Spectral Density @ 802.11b mode channel 1

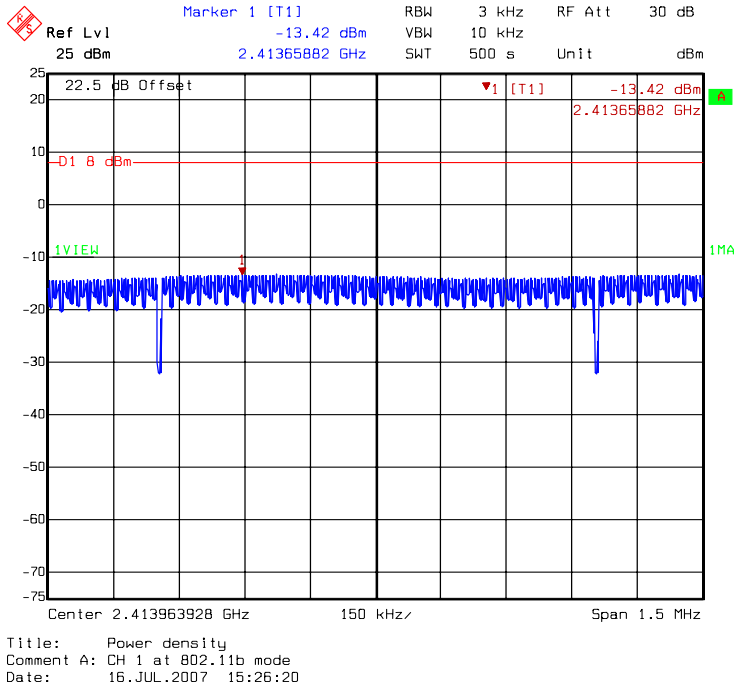

DAC0: Power Spectral Density @ 802.11b mode channel 6

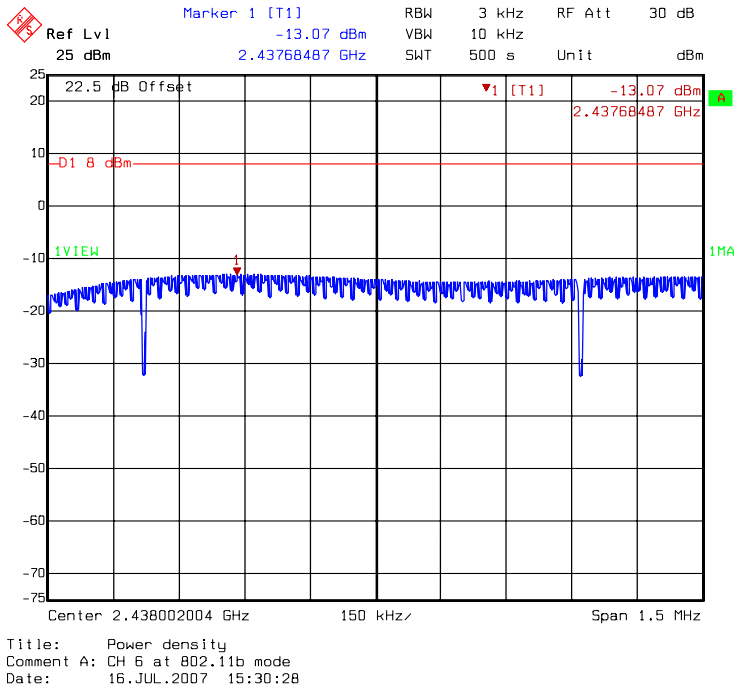

DAC0: Power Spectral Density @ 802.11b mode channel 11

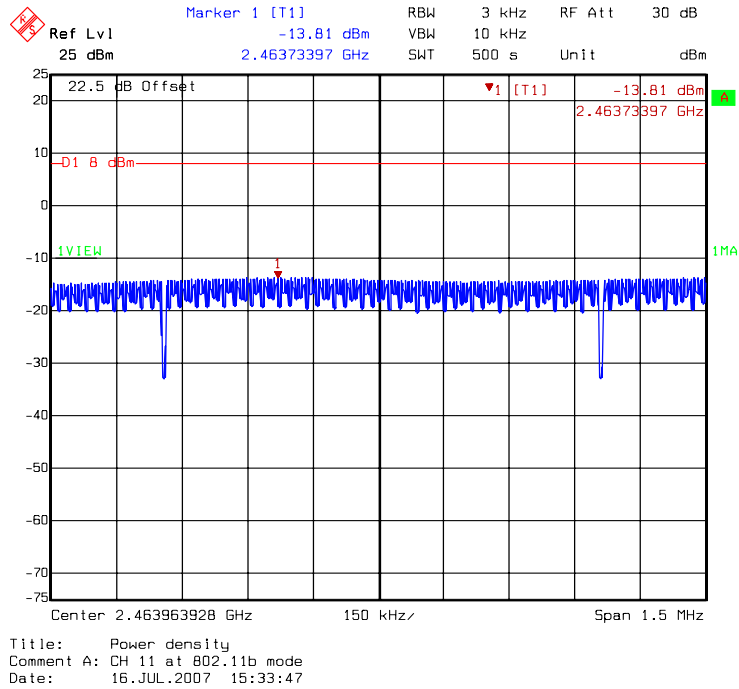

DAC0: Power Spectral Density @ 802.11g mode channel 1

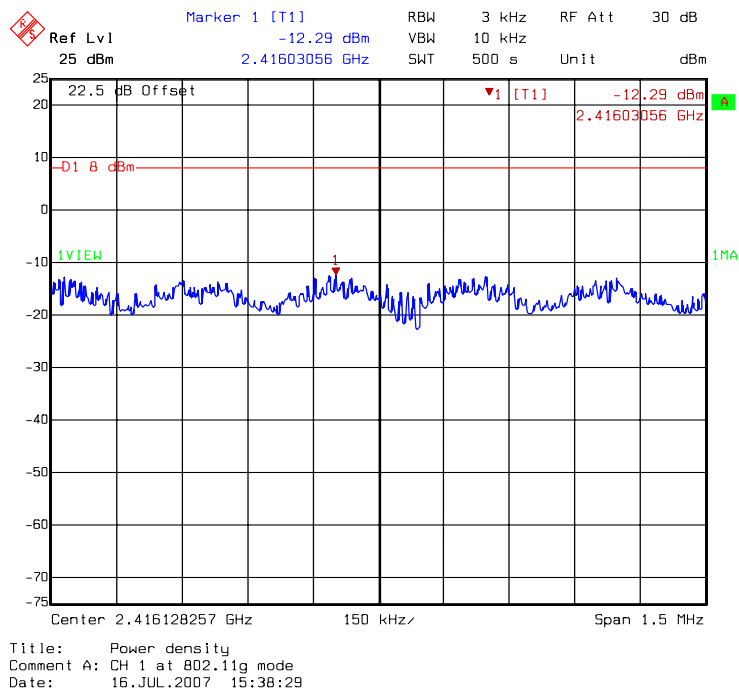

DAC0: Power Spectral Density @ 802.11g mode channel 6

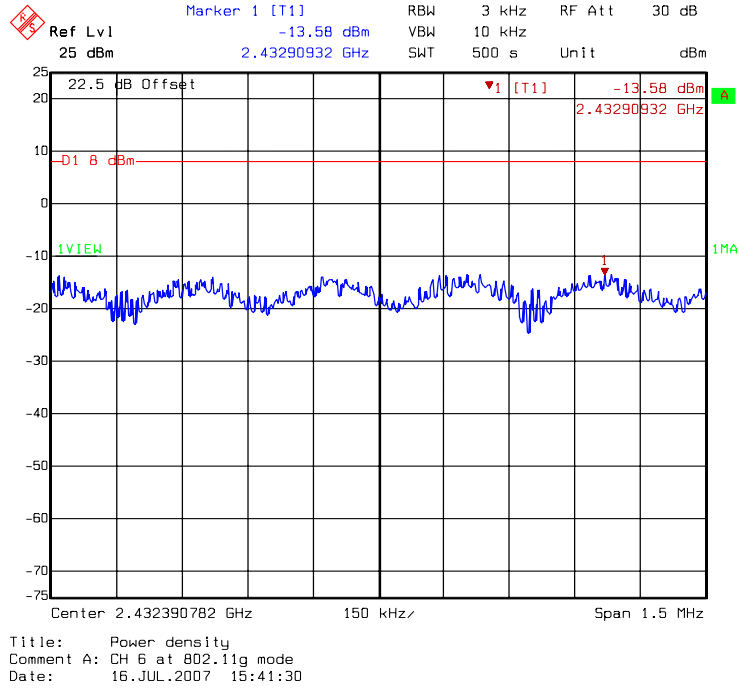

DAC0: Power Spectral Density @ 802.11g mode channel 11

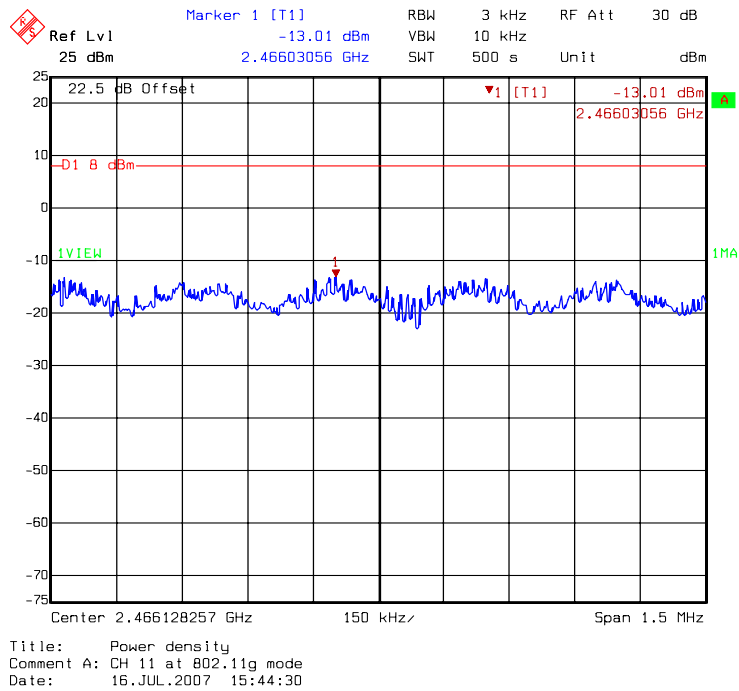

DAC0: Power Spectral Density @ draft 802.11n 20MHz mode channel 1

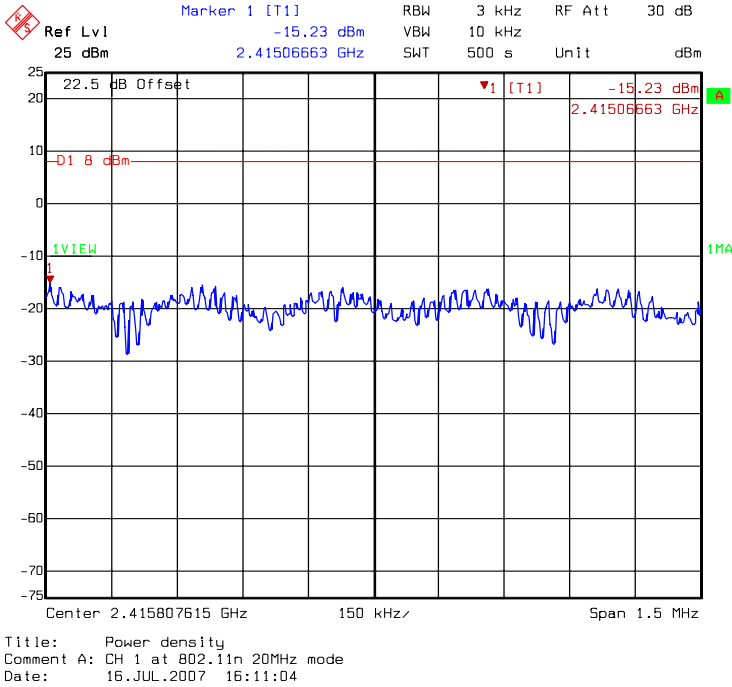

DAC0: Power Spectral Density @ draft 802.11n 20MHz mode channel 6

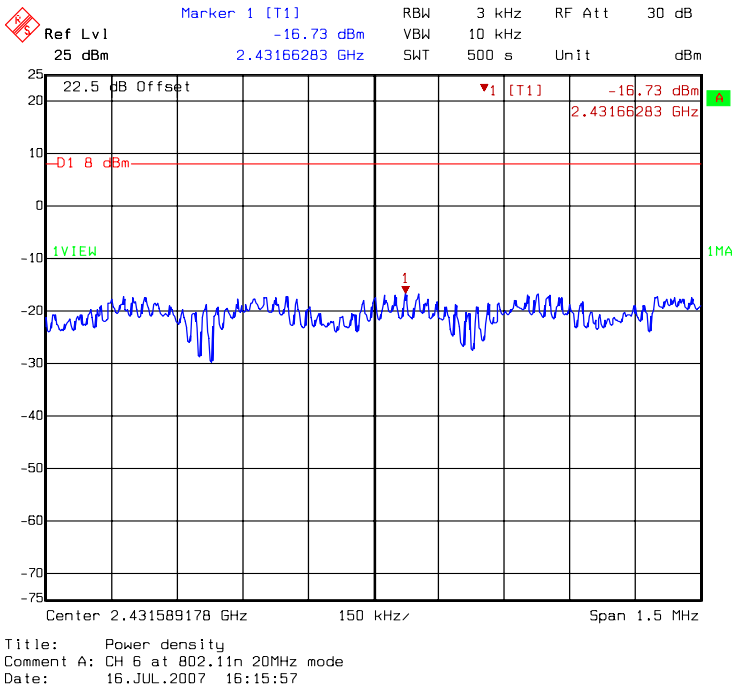

DAC0: Power Spectral Density @ draft 802.11n 20MHz mode channel 11

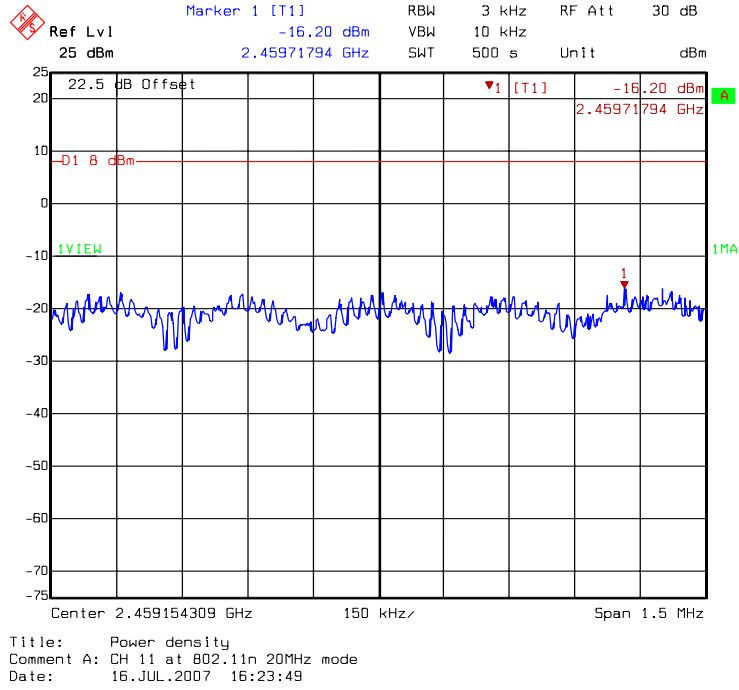

DAC0: Power Spectral Density @ draft 802.11n 40MHz mode channel 3

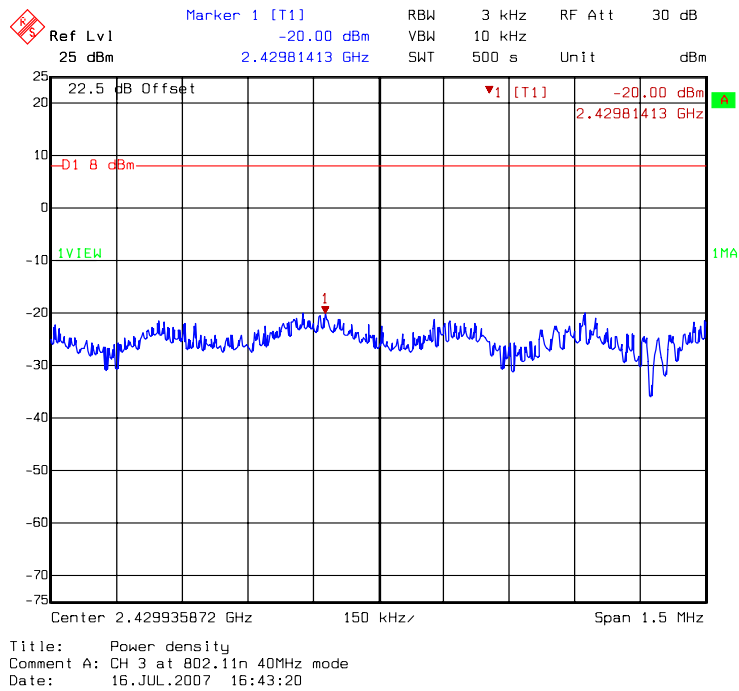

DAC0: Power Spectral Density @ draft 802.11n 40MHz mode channel 6

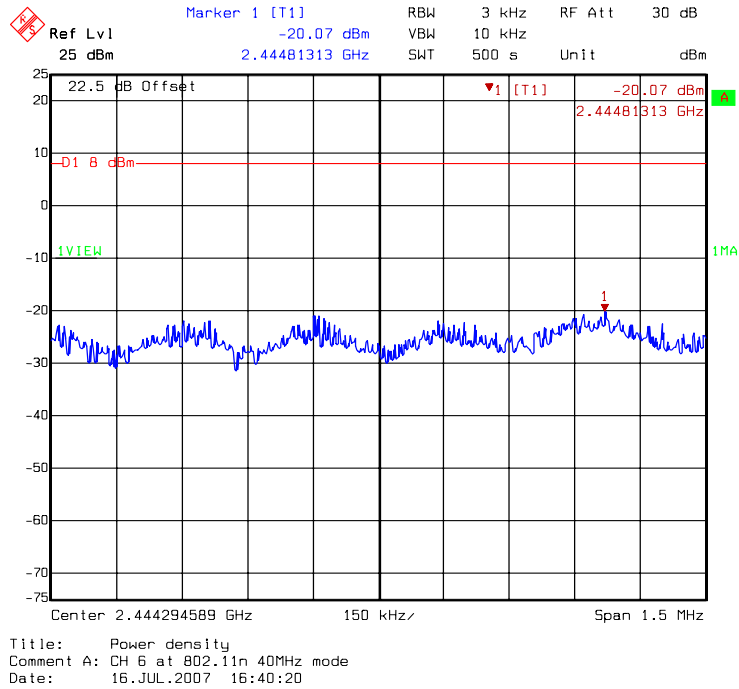

DAC0: Power Spectral Density @ draft 802.11n 40MHz mode channel 9

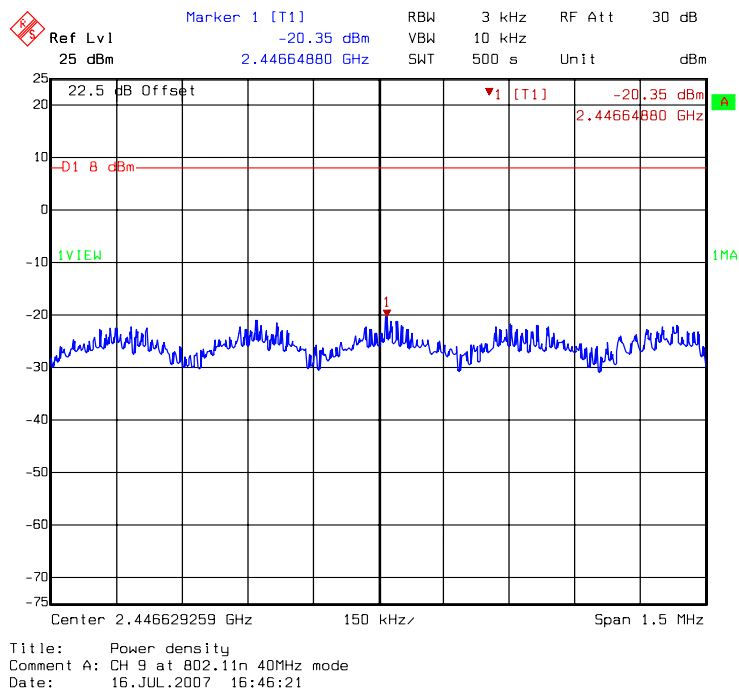

DAC1: Power Spectral Density @ 802.11b mode channel 1

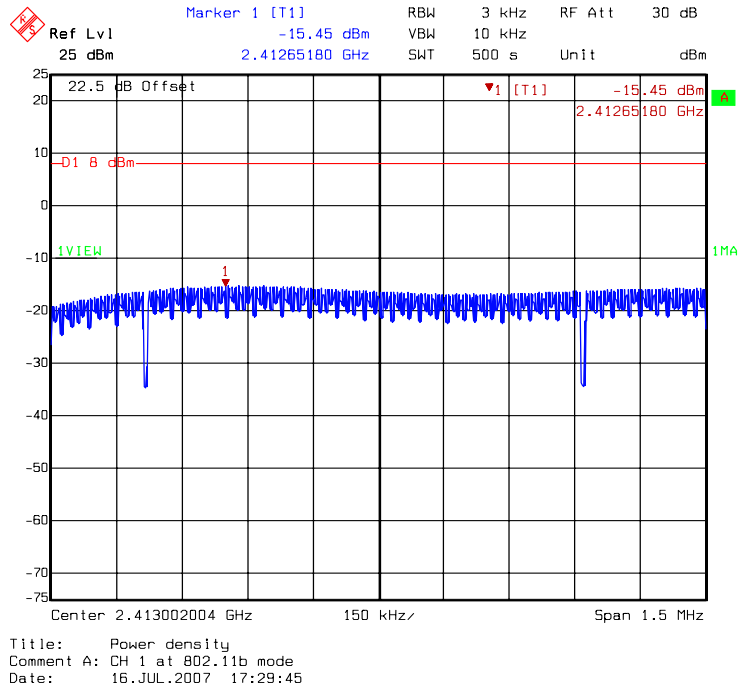

DAC1: Power Spectral Density @ 802.11b mode channel 6

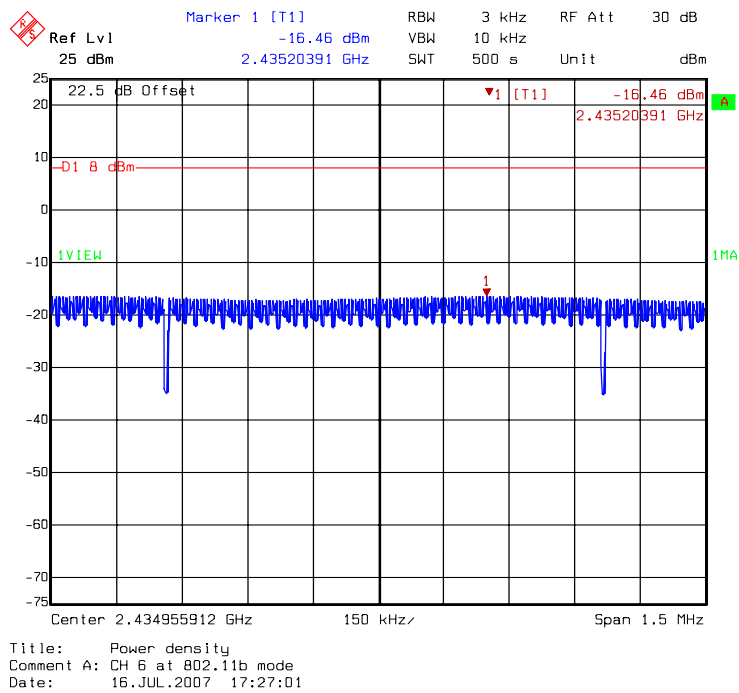

DAC1: Power Spectral Density @ 802.11b mode channel 11

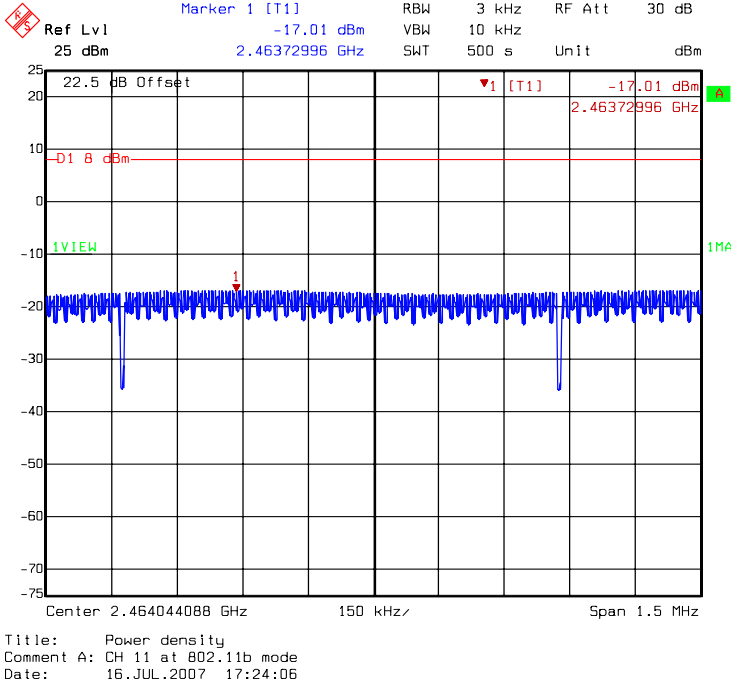

DAC1: Power Spectral Density @ 802.11g mode channel 1

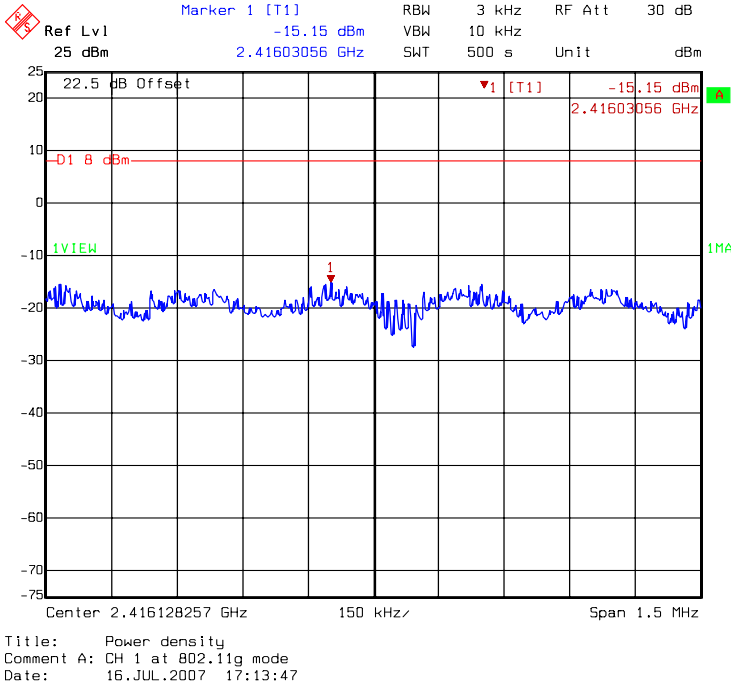

DAC1: Power Spectral Density @ 802.11g mode channel 6

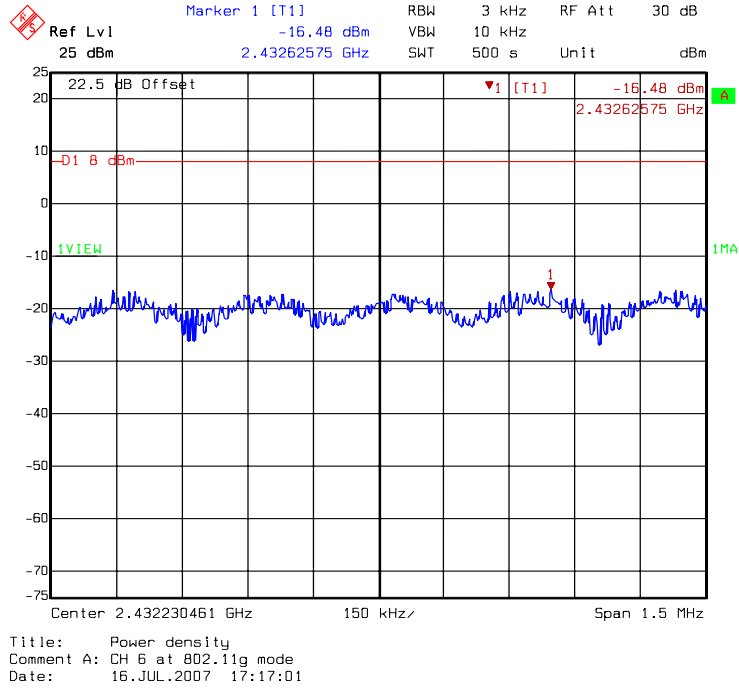

DAC1: Power Spectral Density @ 802.11g mode channel 11

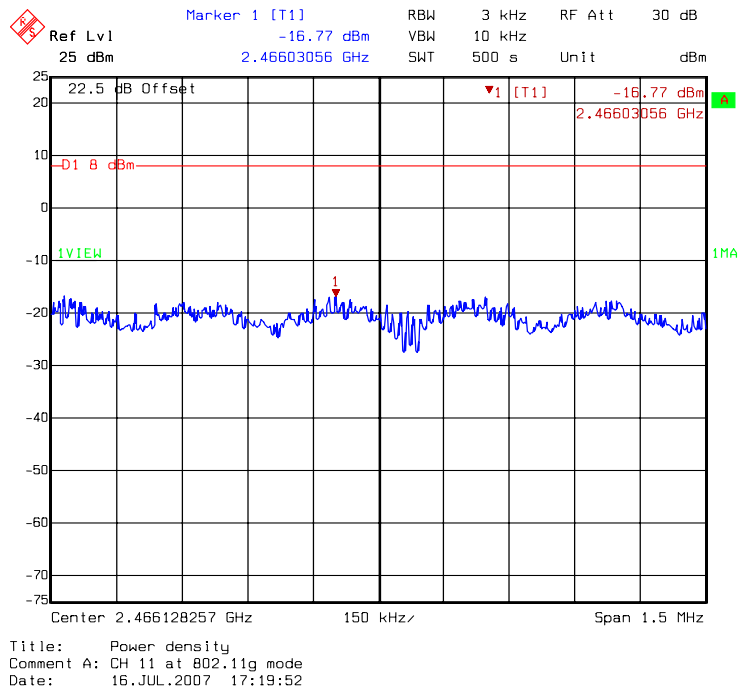

DAC1: Power Spectral Density @ draft 802.11n 20MHz mode channel 1

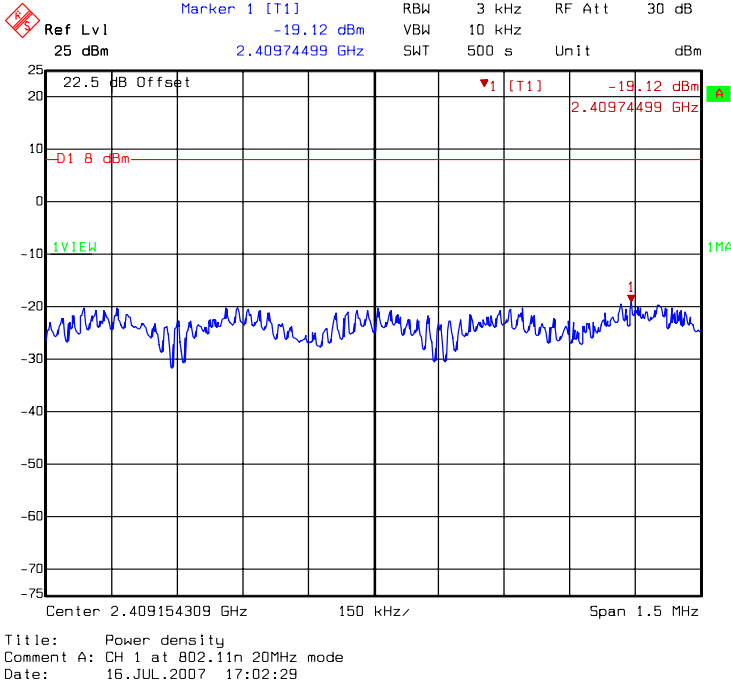

DAC1: Power Spectral Density @ draft 802.11n 20MHz mode channel 6

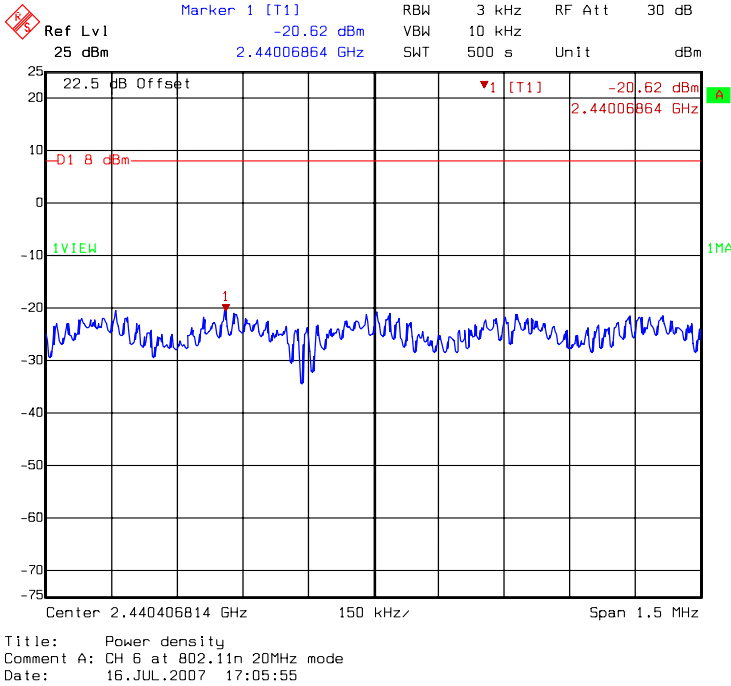

DAC1: Power Spectral Density @ draft 802.11n 20MHz mode channel 11

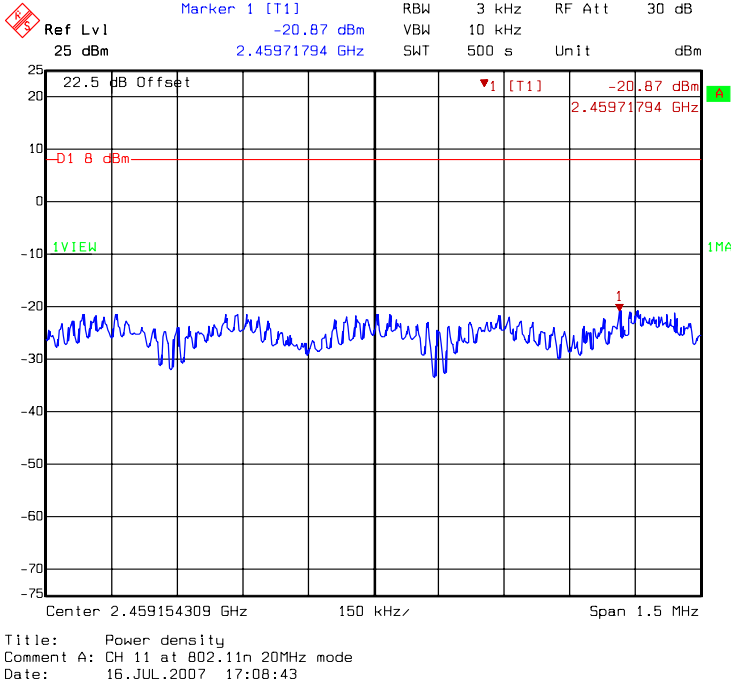

DAC1: Power Spectral Density @ draft 802.11n 40MHz mode channel 3

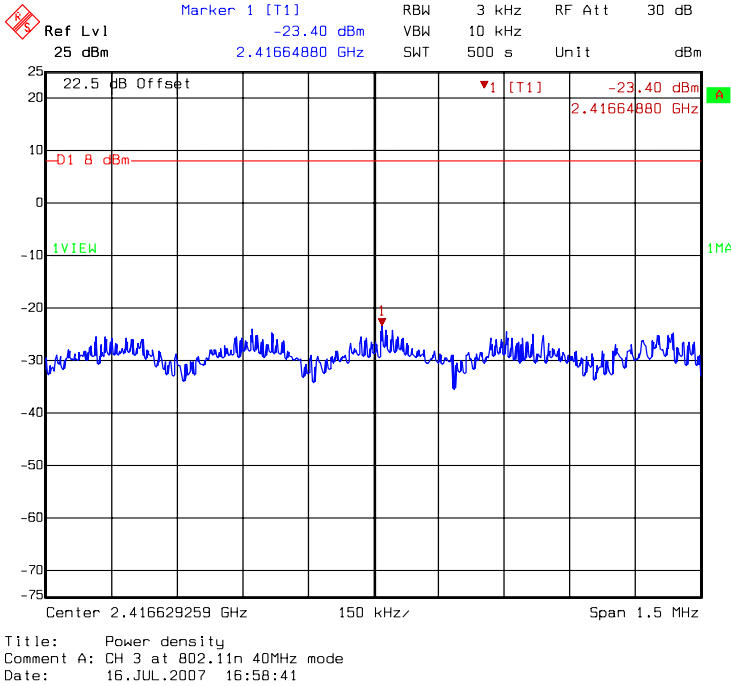

DAC1: Power Spectral Density @ draft 802.11n 40MHz mode channel 6

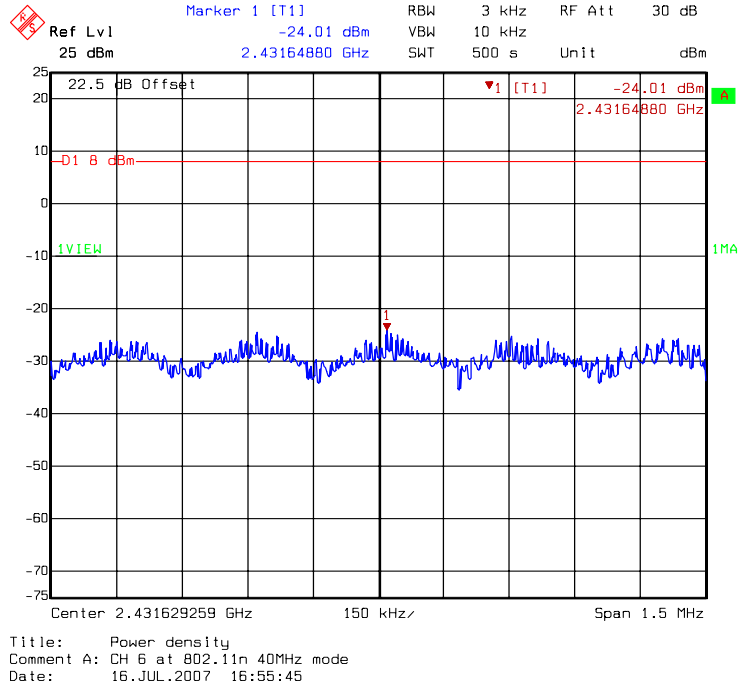

DAC1: Power Spectral Density @ draft 802.11n 40MHz mode channel 9

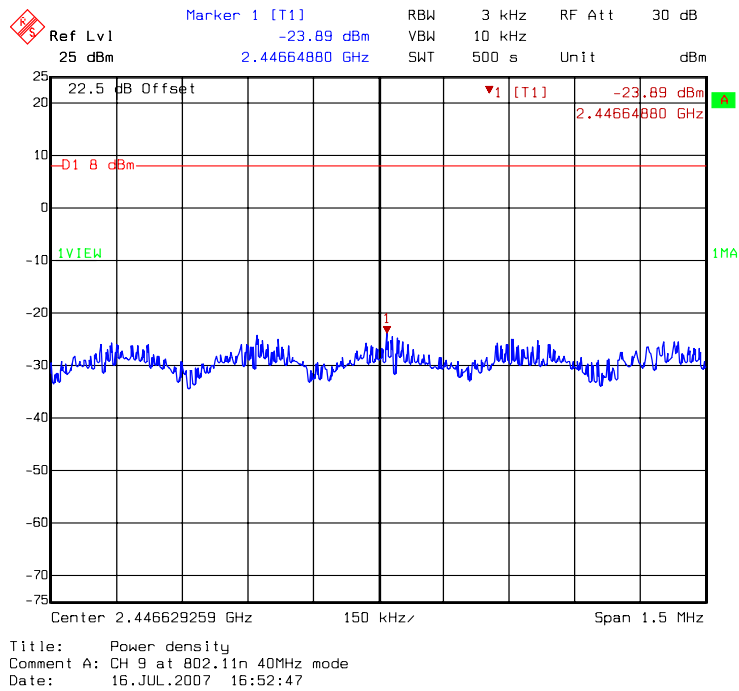

Dual Tx

DAC0: Power Spectral Density @ draft 802.11n 20MHz mode channel 1

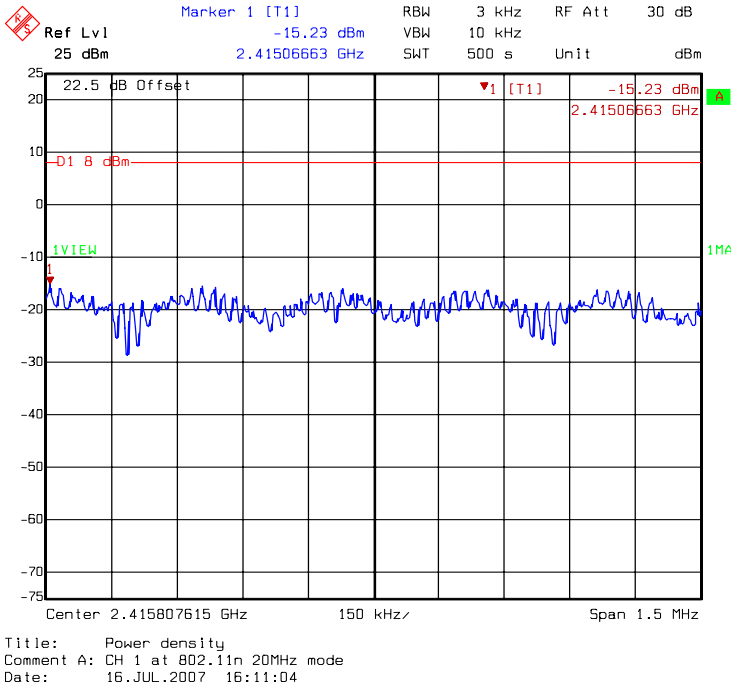

DAC0: Power Spectral Density @ draft 802.11n 20MHz mode channel 6

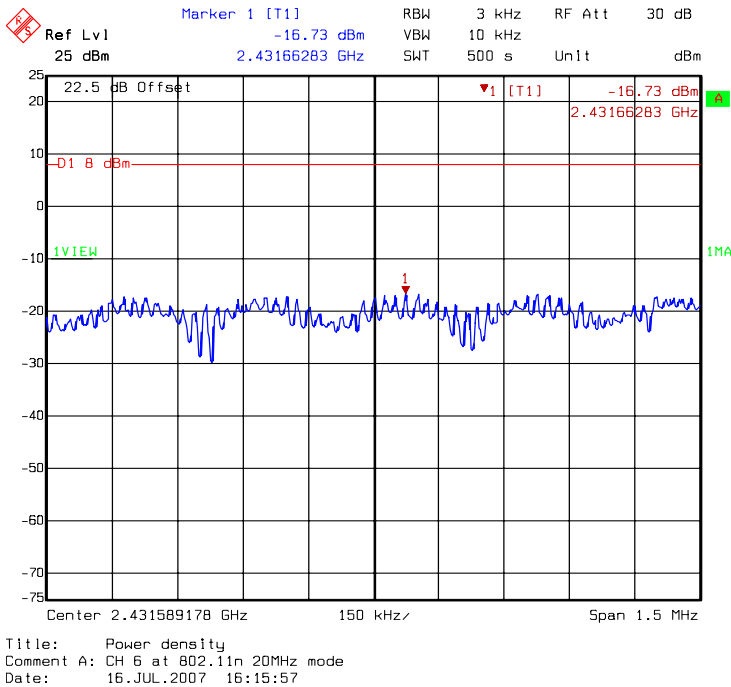

DAC0: Power Spectral Density @ draft 802.11n 20MHz mode channel 11

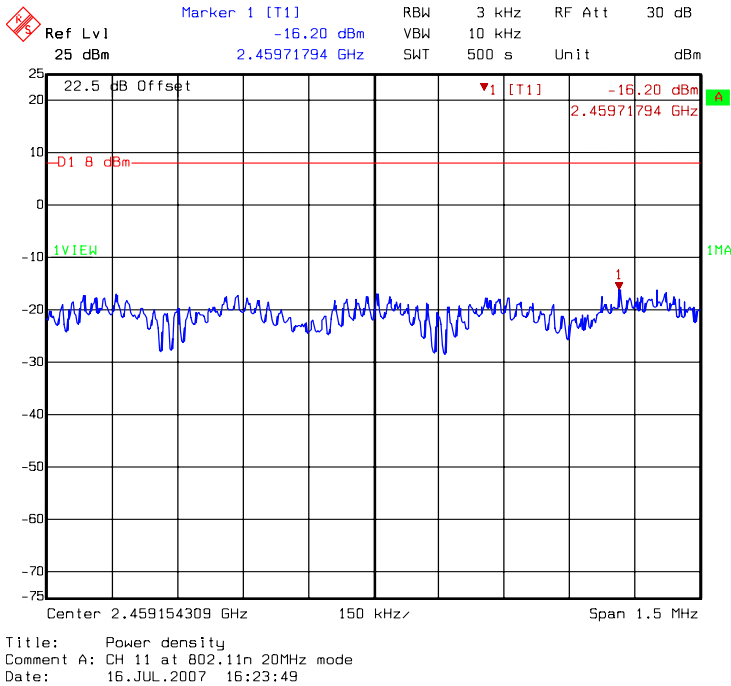

DAC0: Power Spectral Density @ draft 802.11n 40MHz mode channel 3

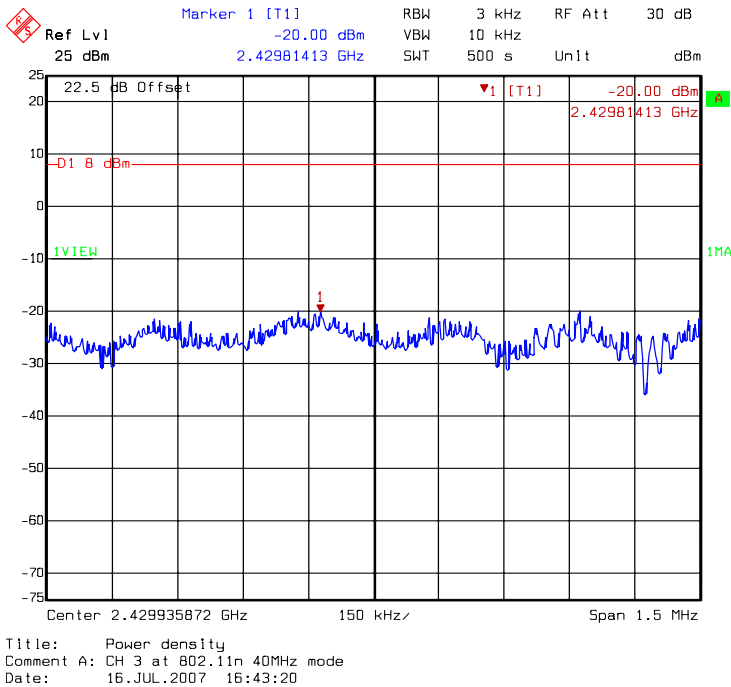

DAC0: Power Spectral Density @ draft 802.11n 40MHz mode channel 6

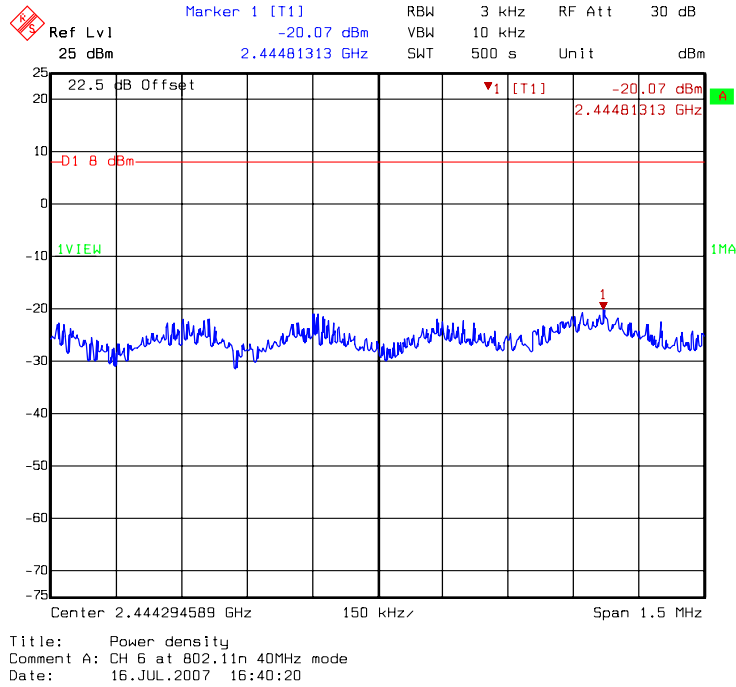

DAC0: Power Spectral Density @ draft 802.11n 40MHz mode channel 9

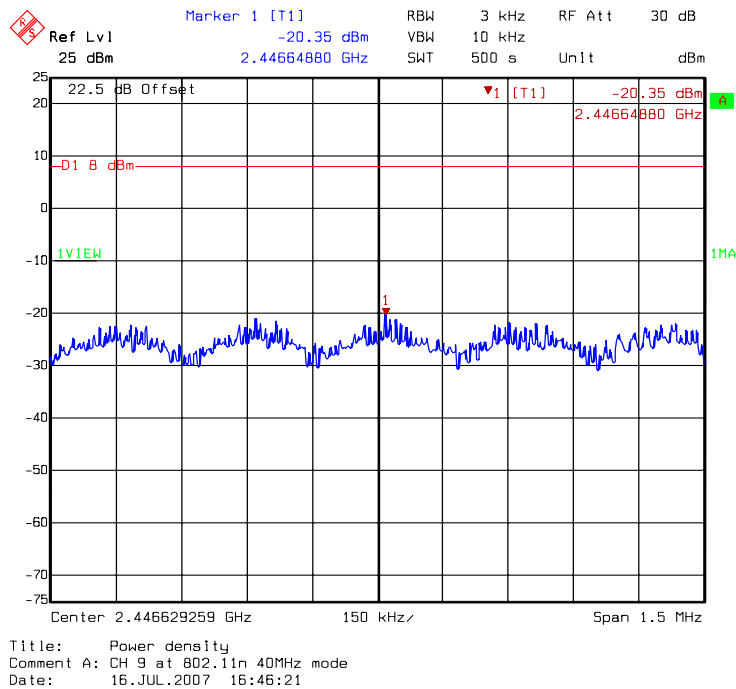

DAC1: Power Spectral Density @ draft 802.11n 20MHz mode channel 1

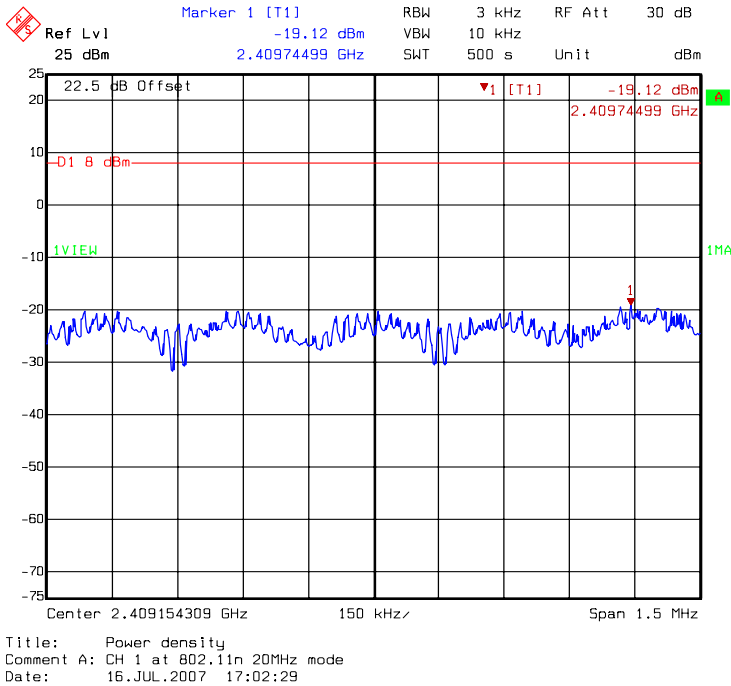

DAC1: Power Spectral Density @ draft 802.11n 20MHz mode channel 6

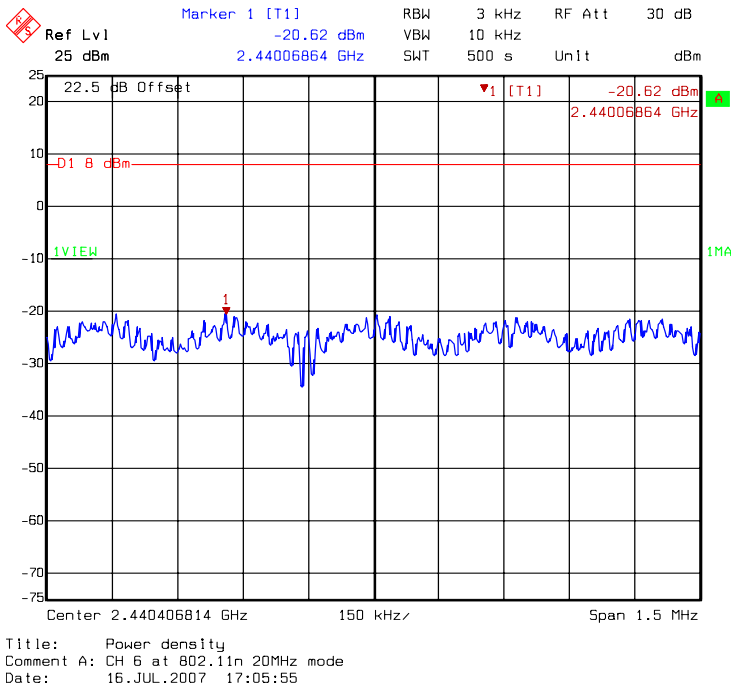

DAC1: Power Spectral Density @ draft 802.11n 20MHz mode channel 11

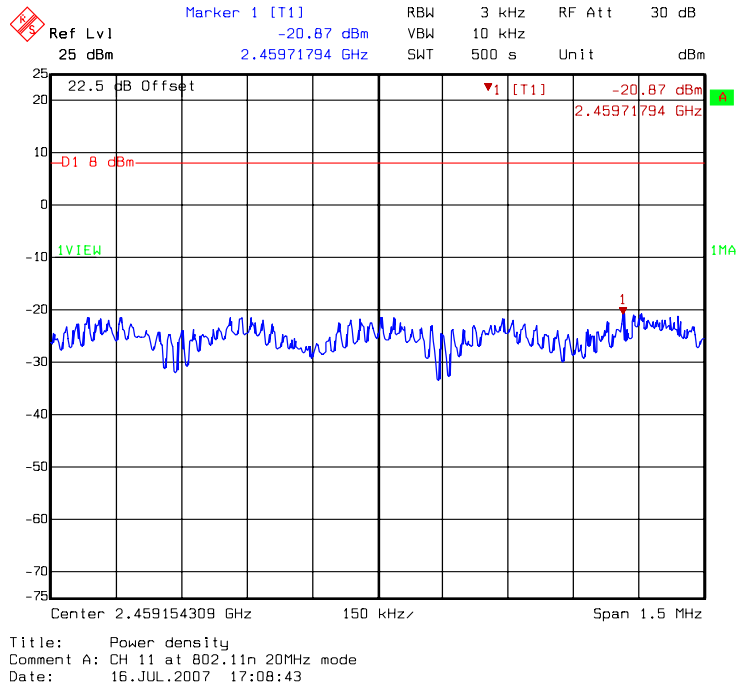

DAC1: Power Spectral Density @ draft 802.11n 40MHz mode channel 3

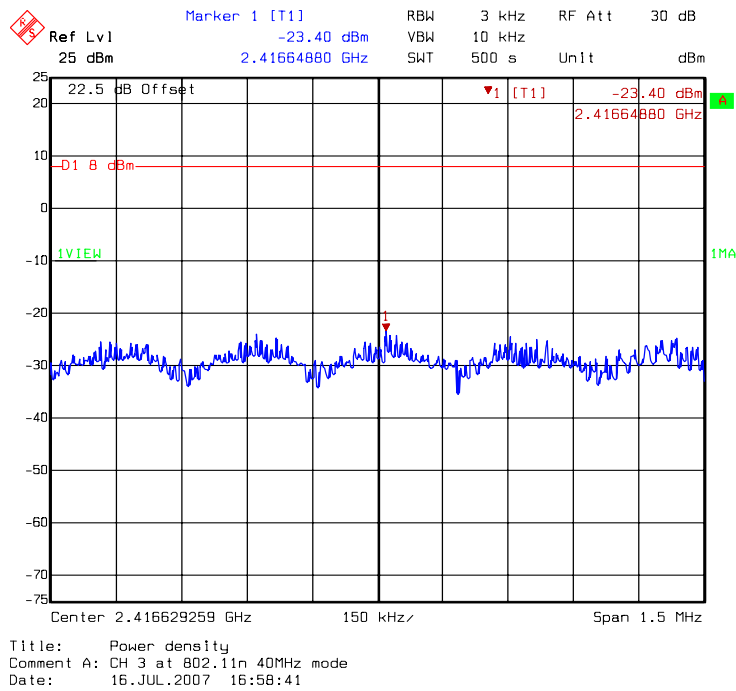

DAC1: Power Spectral Density @ draft 802.11n 40MHz mode channel 6

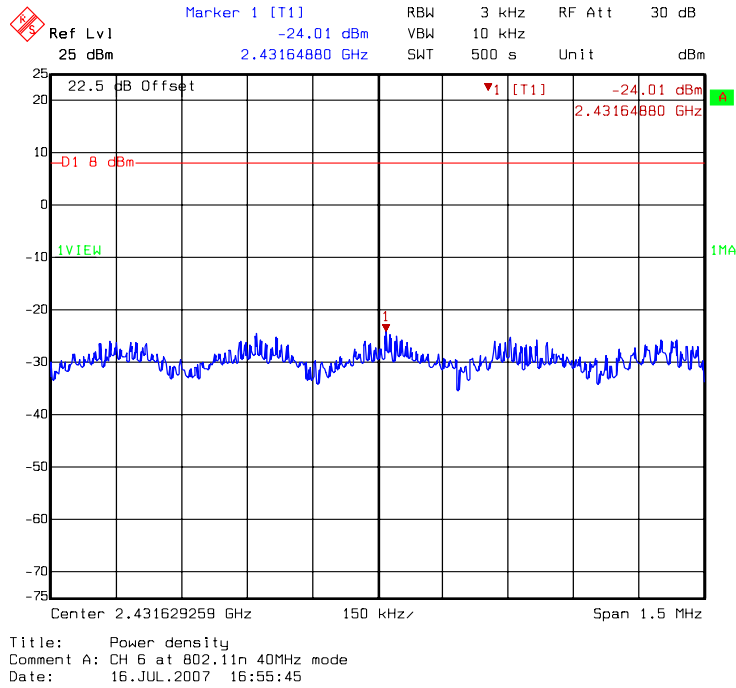

DAC1: Power Spectral Density @ draft 802.11n 40MHz mode channel 9

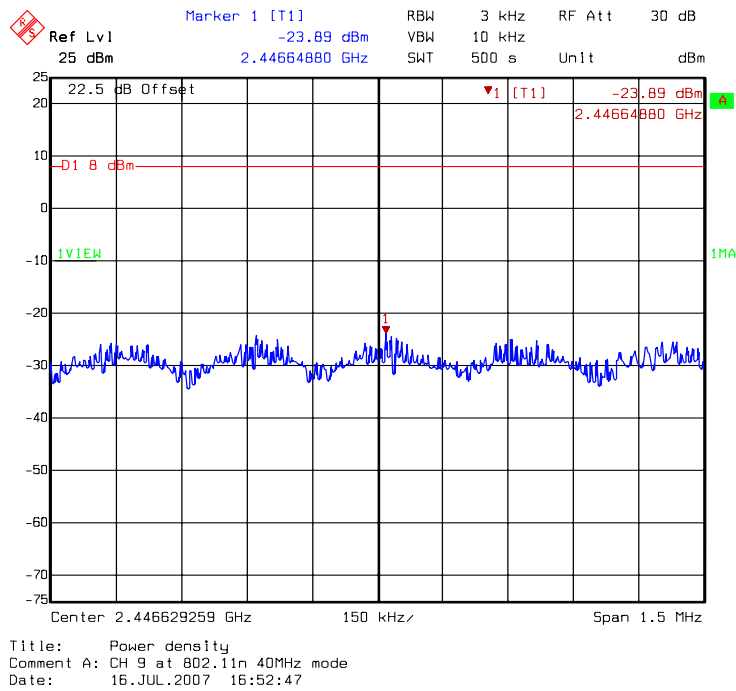

7. RF Antenna conducted Spurious

Name of Test	RF Antenna Conducted Spurious
Base Standard	FCC 15.247(d)

Tested By: Marx Yan
Test Date: Jul. 18, 2007

Test Equipment: EC365

Test Result: Complies
Test Method: See Appendix D
Measurement Data: See plots below

Note: (1) The EUT was tested while in a continuous transmit mode. The EUT was tuned to a low, middle and high channel.
(2) The EUT operating at 2.4GHz ISM band. Frequency Range scanned from 30MHz to 25GHz.

DAC0: conducted spurious @ 802.11b mode channel 1 (1 of 3)

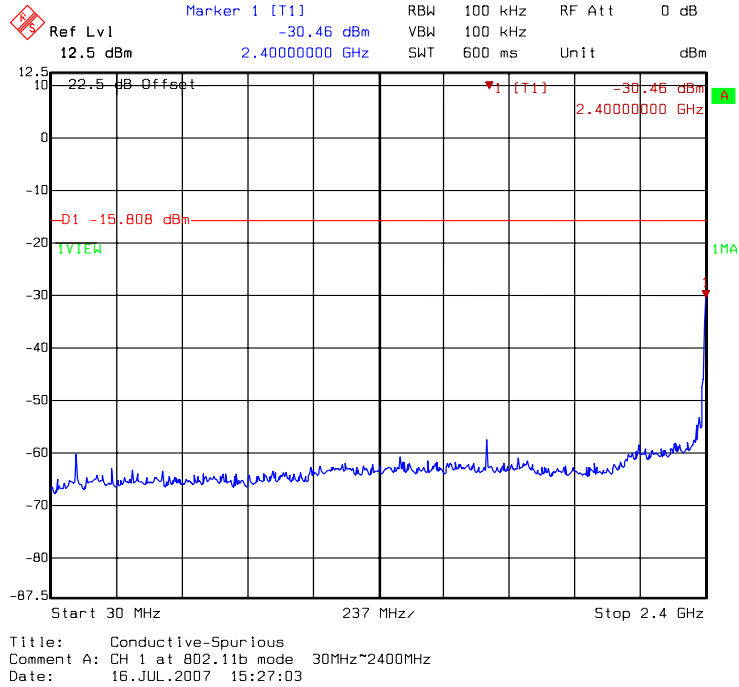

DAC0: conducted spurious @ 802.11b mode channel 1 (2 of 3)

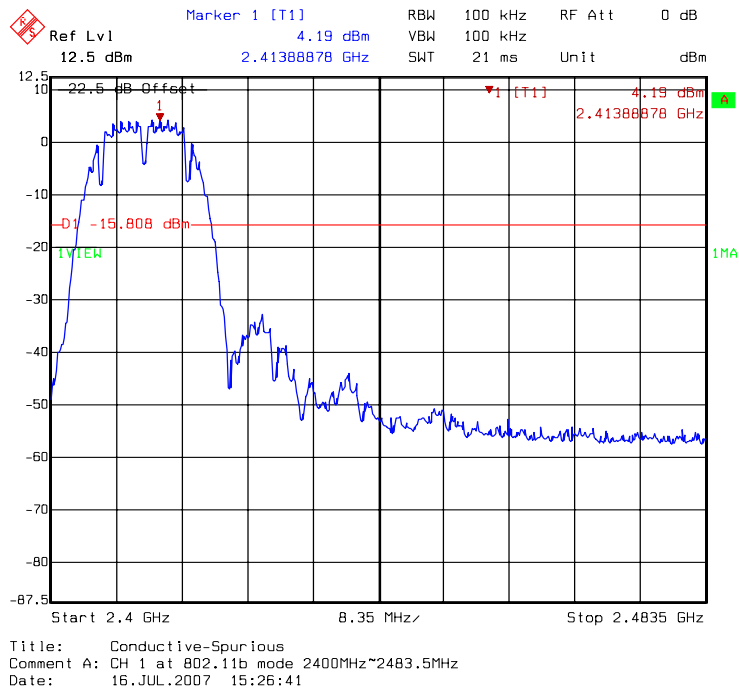

DAC0: conducted spurious @ 802.11b mode channel 1 (3 of 3)

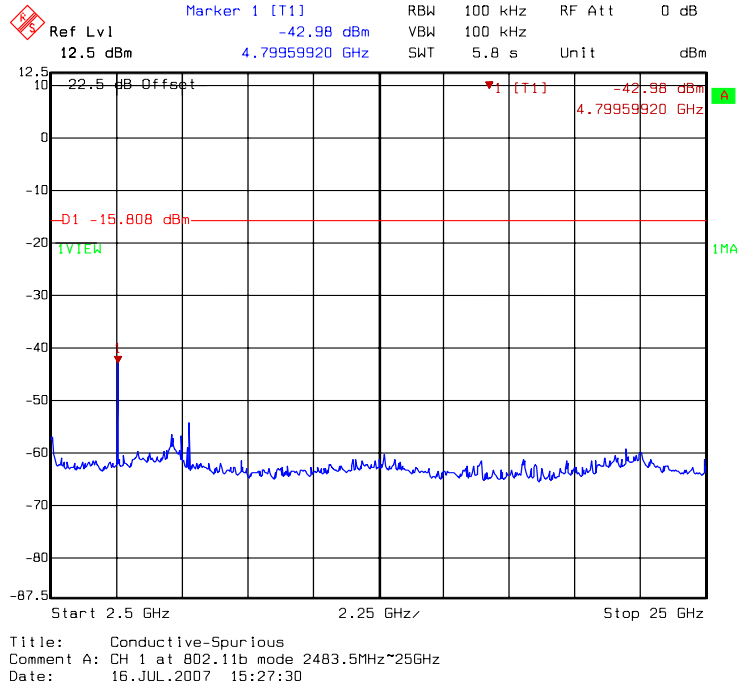

DAC0: conducted spurious @ 802.11b mode channel 6 (1 of 3)

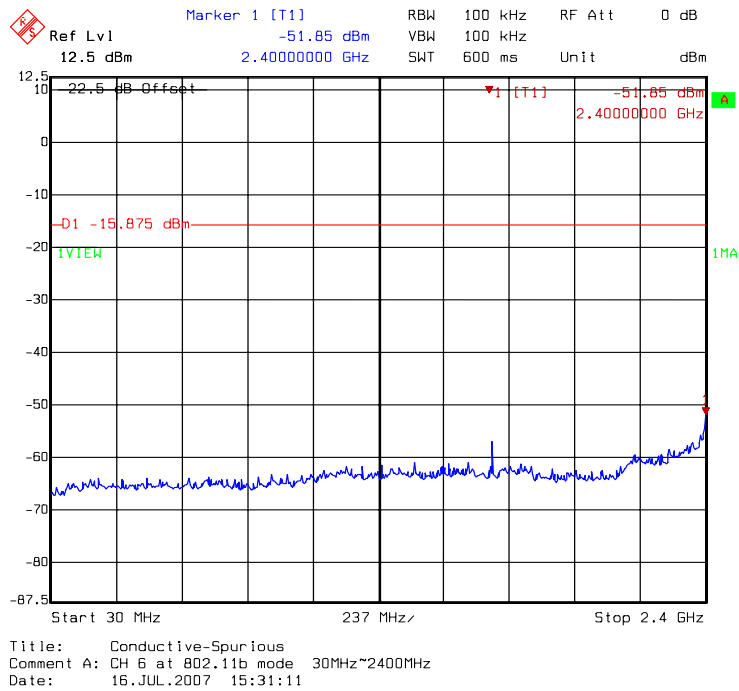

DAC0: conducted spurious @ 802.11b mode channel 6 (2 of 3)

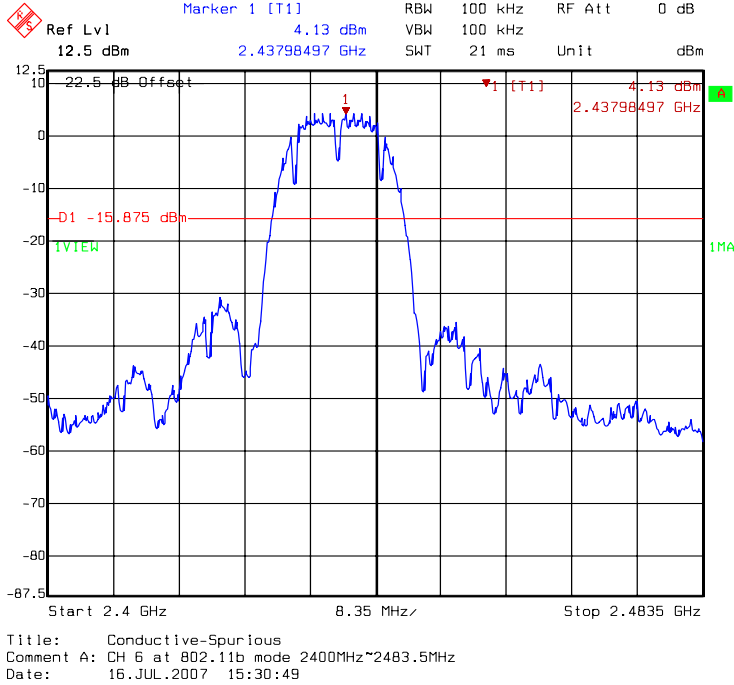

DAC0: conducted spurious @ 802.11b mode channel 6 (3 of 3)

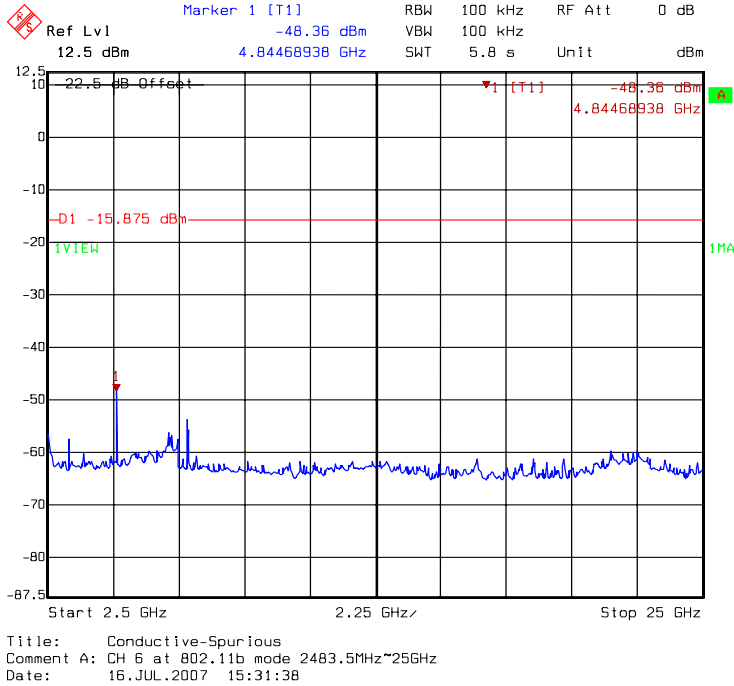

DAC0: conducted spurious @ 802.11b mode channel 11 (1 of 3)

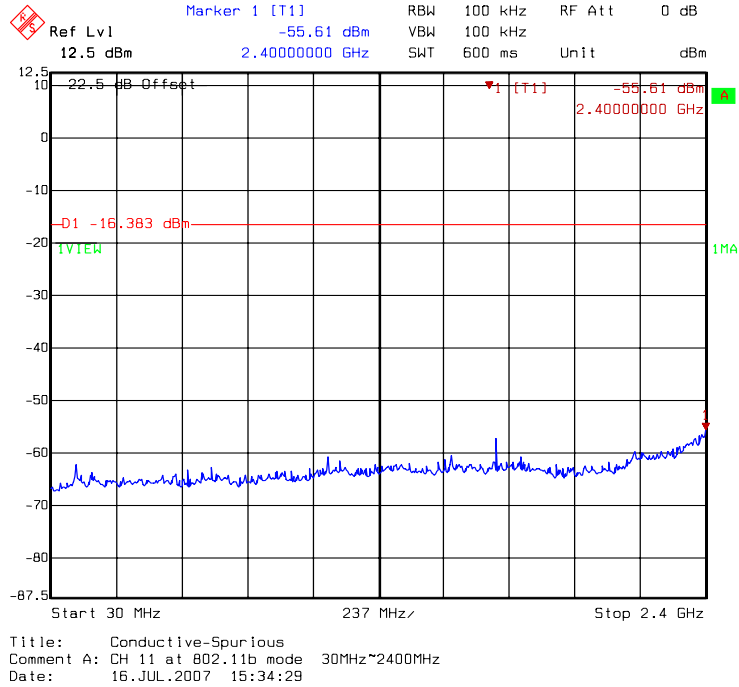

DAC0: conducted spurious @ 802.11b mode channel 11 (2 of 3)

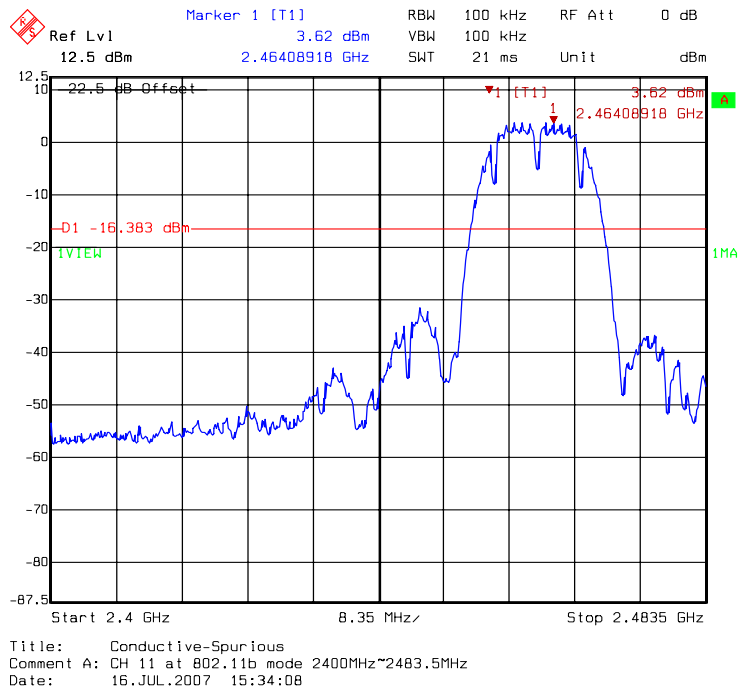

DAC0: conducted spurious @ 802.11b mode channel 11 (3 of 3)

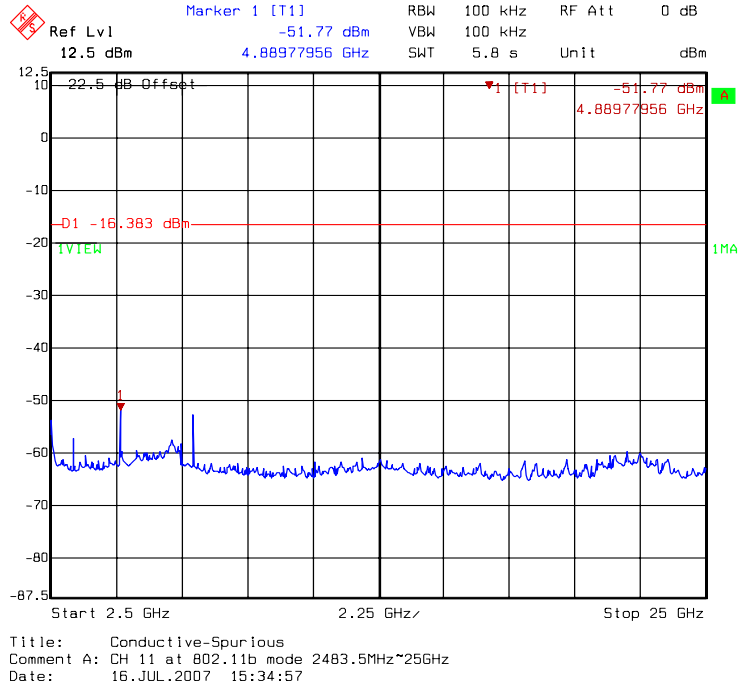

DAC0: conducted spurious @ 802.11g mode channel 1 (1 of 3)

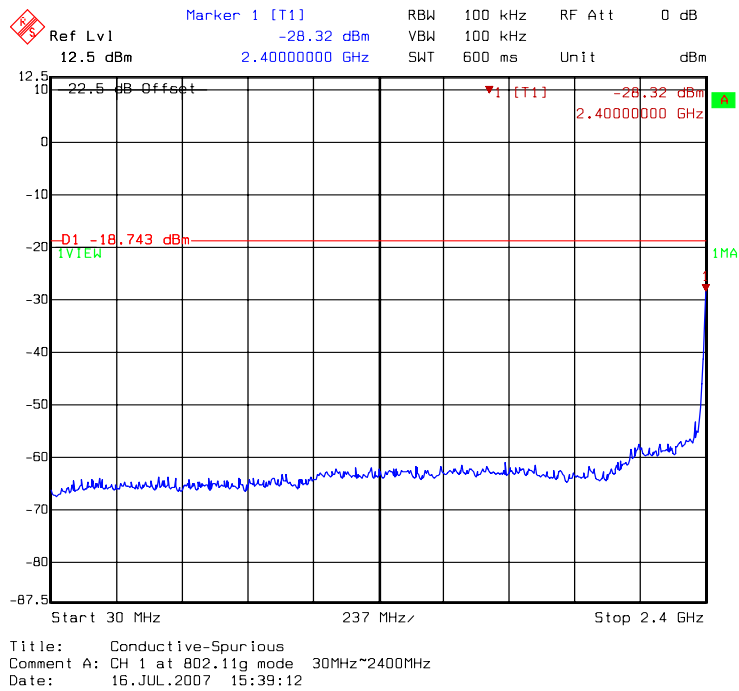

DAC0: conducted spurious @ 802.11g mode channel 1 (2 of 3)

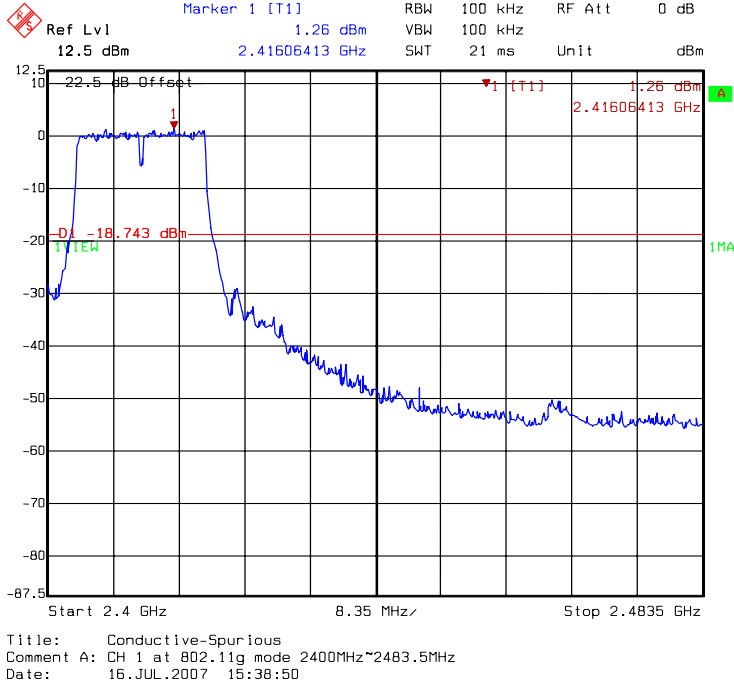

DAC0: conducted spurious @ 802.11g mode channel 1 (3 of 3)

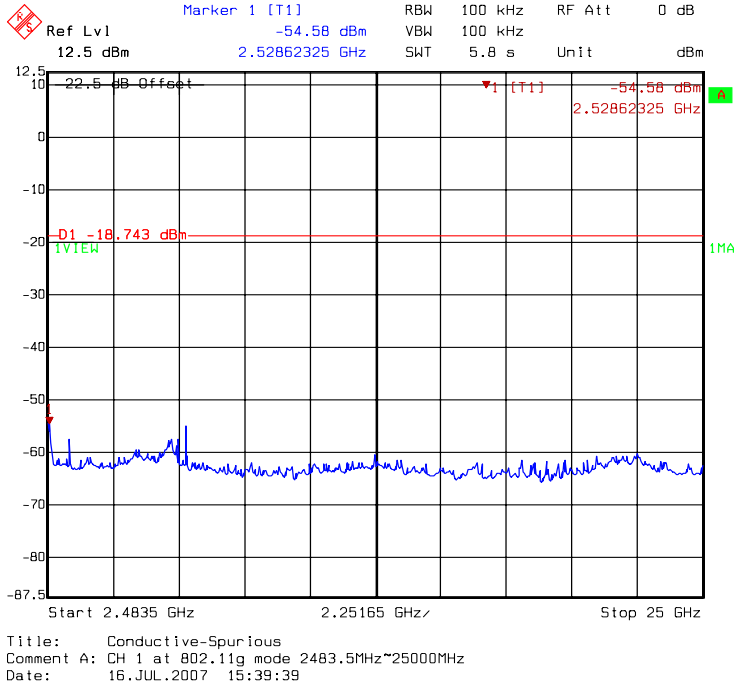

DAC0: conducted spurious @ 802.11g mode channel 6 (1 of 3)

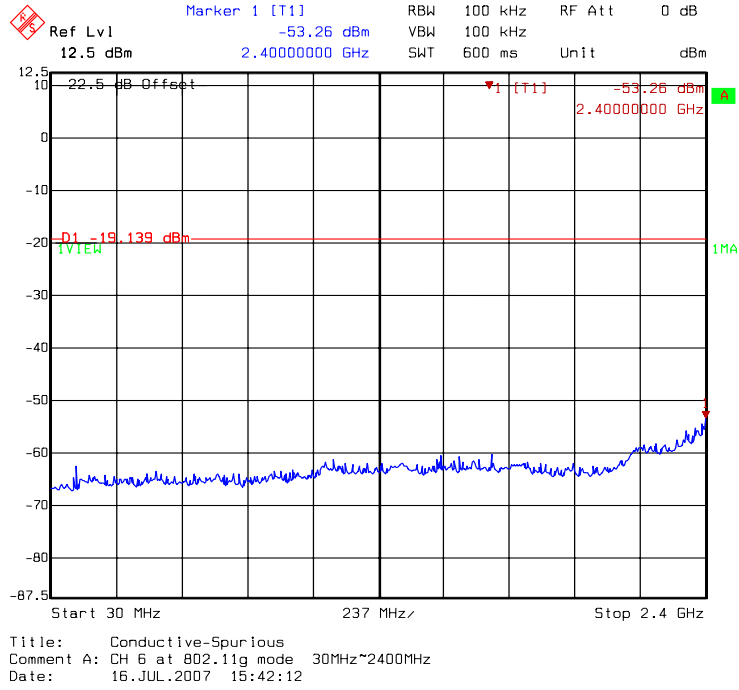

DAC0: conducted spurious @ 802.11g mode channel 6 (2 of 3)

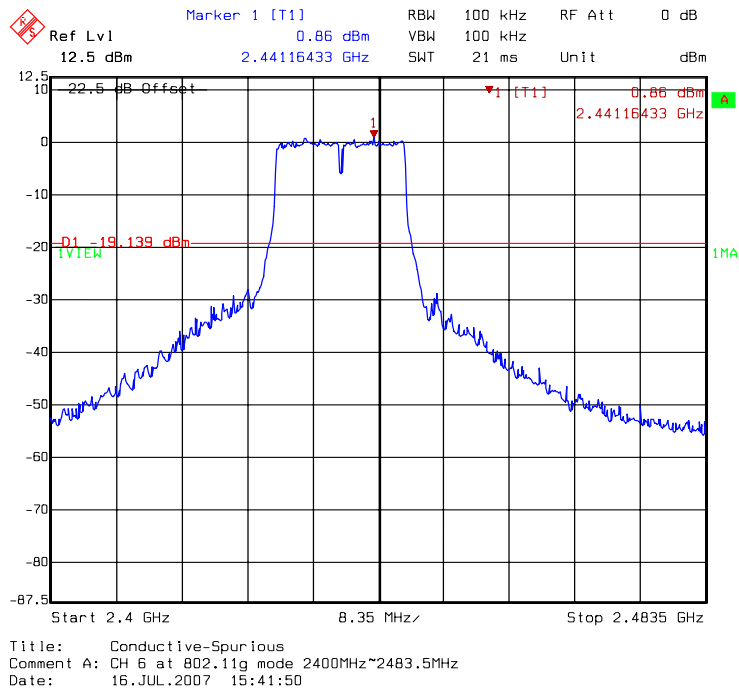

DAC0: conducted spurious @ 802.11g mode channel 6 (3 of 3)

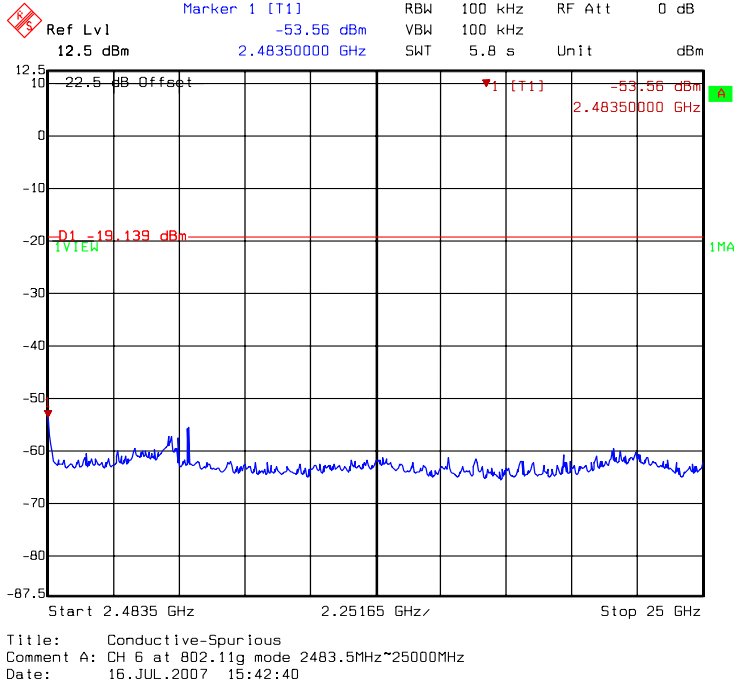

DAC0: conducted spurious @ 802.11g mode channel 11 (1 of 3)

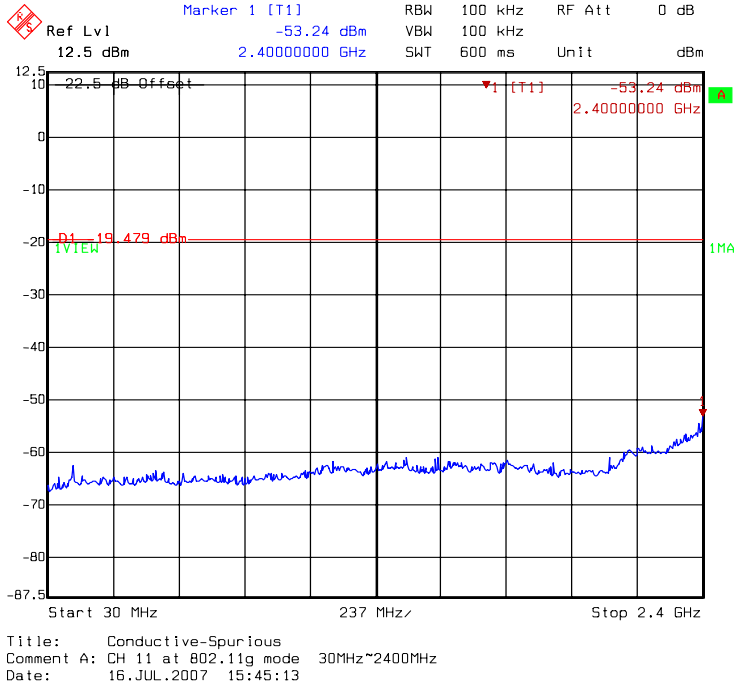

DAC0: conducted spurious @ 802.11g mode channel 11 (2 of 3)

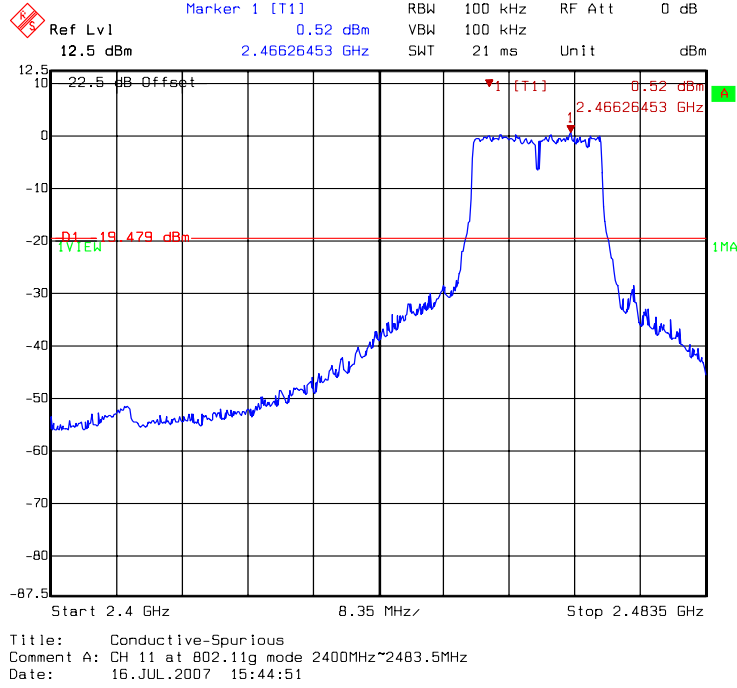

DAC0: conducted spurious @ 802.11g mode channel 11 (3 of 3)

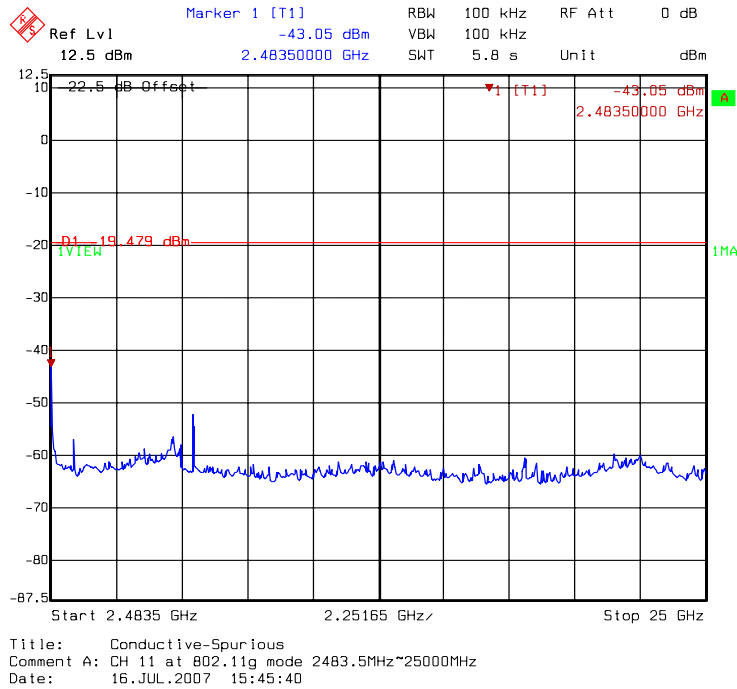

DAC0: conducted spurious @ draft 802.11n 20MHz mode channel 1 (1 of 3)

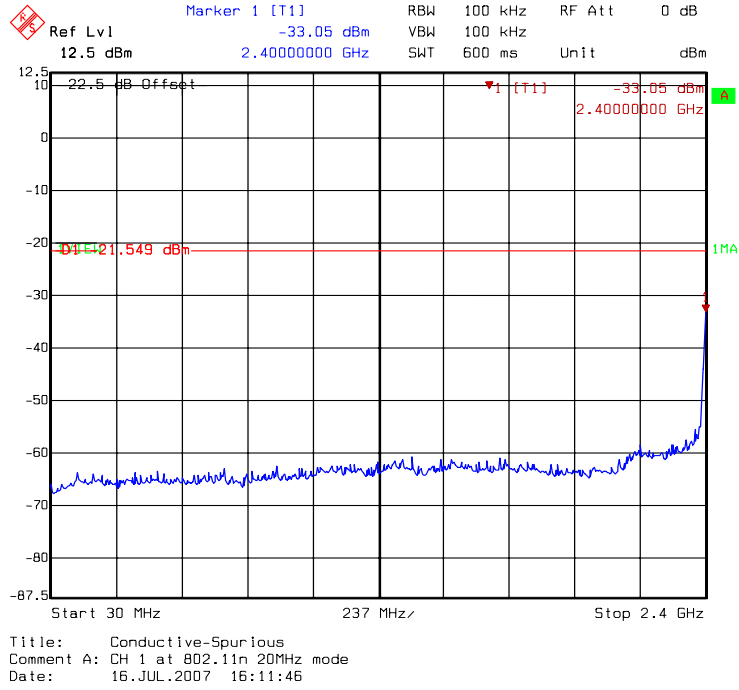

DAC0: conducted spurious @ draft 802.11n 20MHz mode channel 1 (2 of 3)

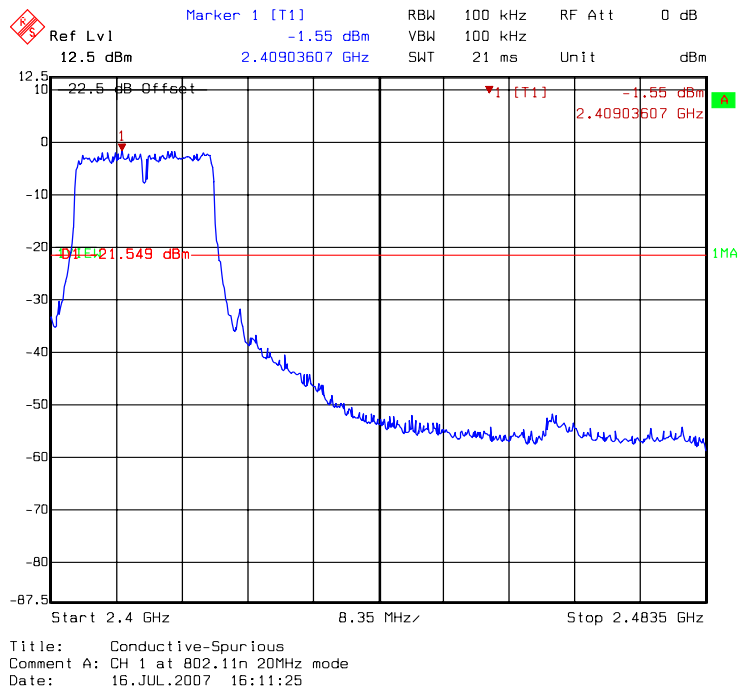

DAC0: conducted spurious @ draft 802.11n 20MHz mode channel 1 (3 of 3)

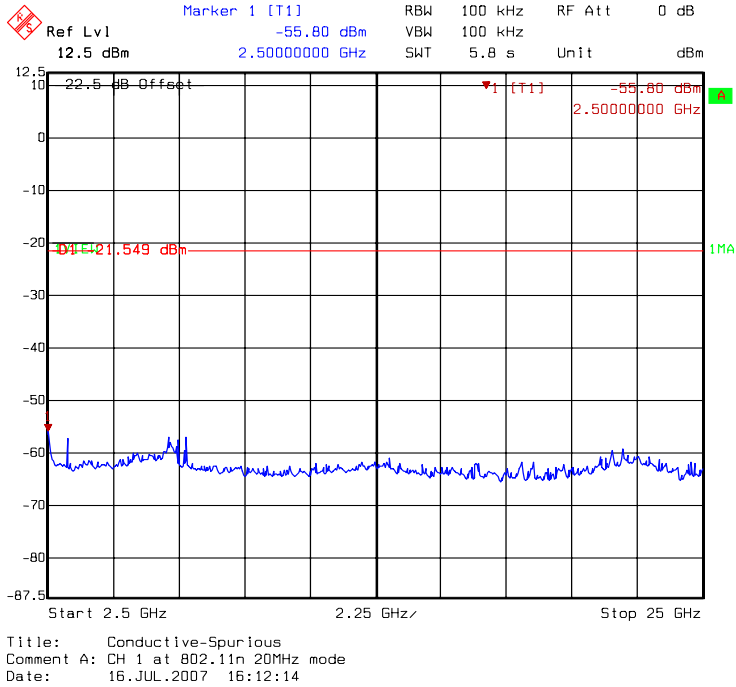

DAC0: conducted spurious @ draft 802.11n 20MHz mode channel 6 (1 of 3)

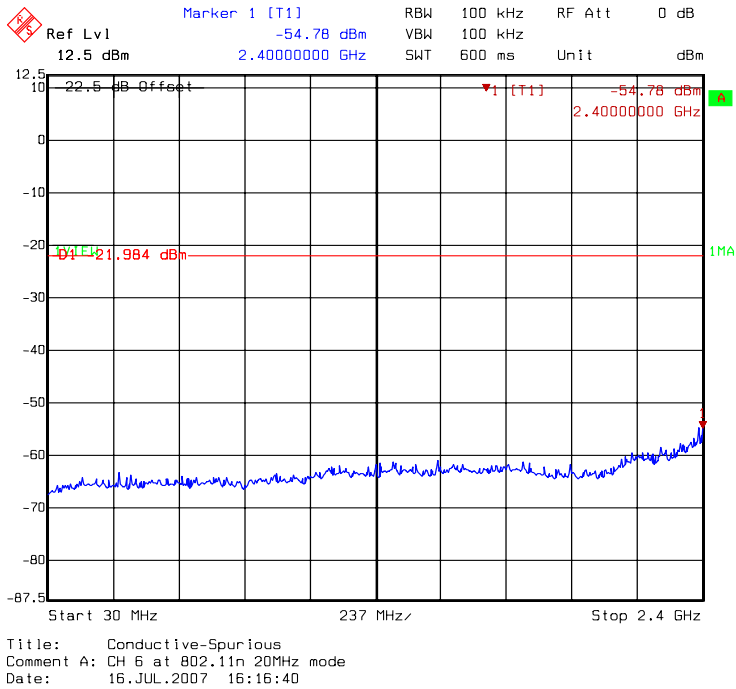

DAC0: conducted spurious @ draft 802.11n 20MHz mode channel 6 (2 of 3)

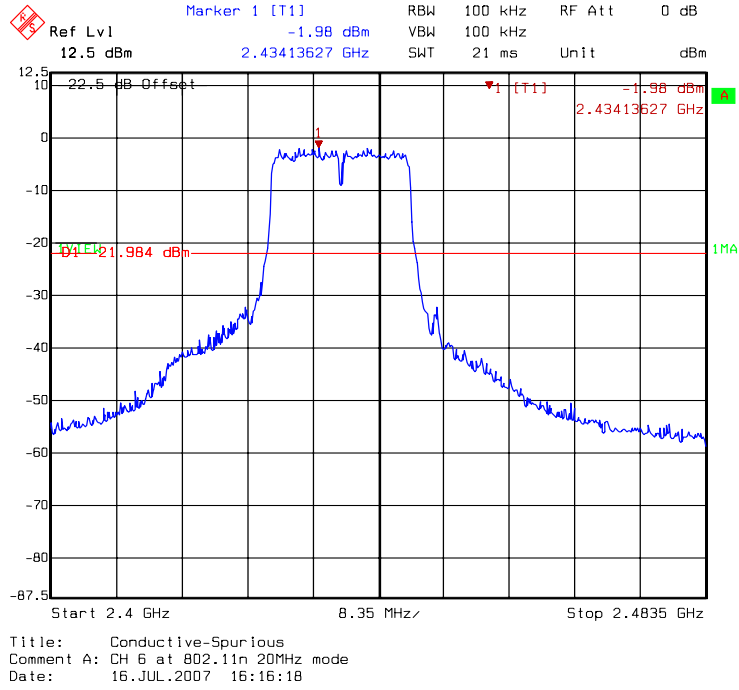

DAC0: conducted spurious @ draft 802.11n 20MHz mode channel 6 (3 of 3)

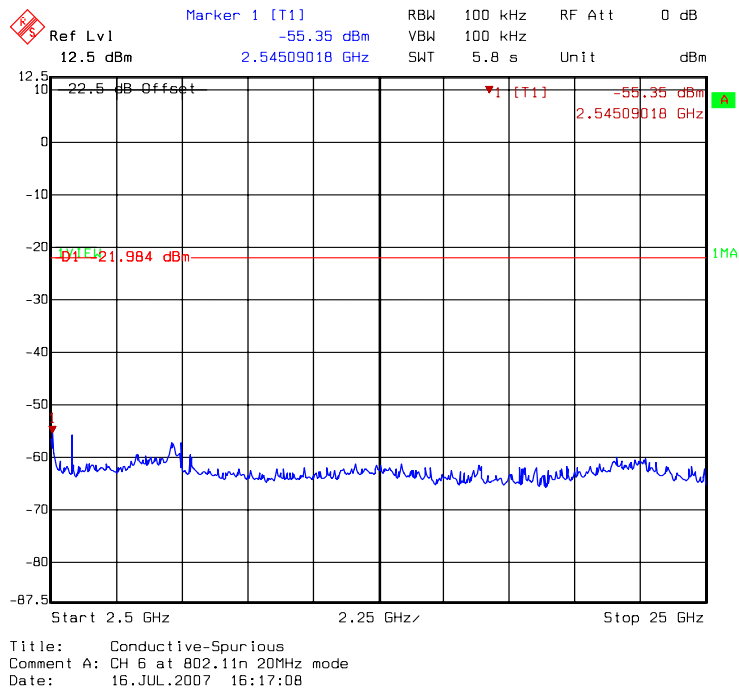

DAC0: conducted spurious @ draft 802.11n 20MHz mode channel 11 (1 of 3)

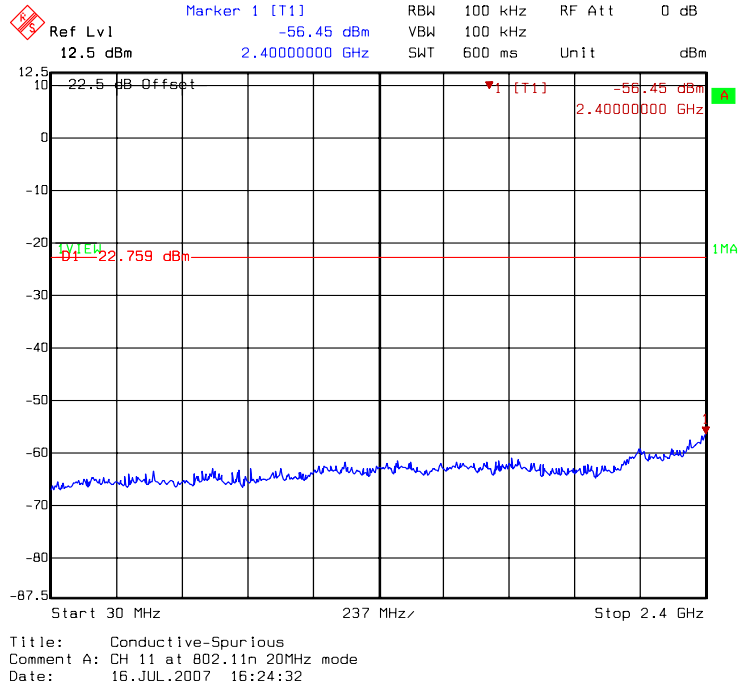

DAC0: conducted spurious @ draft 802.11n 20MHz mode channel 11 (2 of 3)

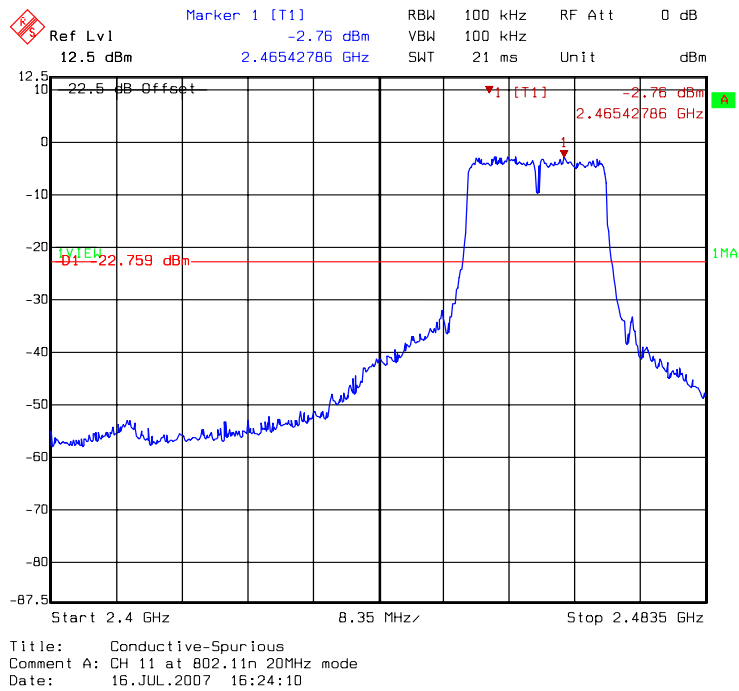

DAC0: conducted spurious @ draft 802.11n 20MHz mode channel 11 (3 of 3)

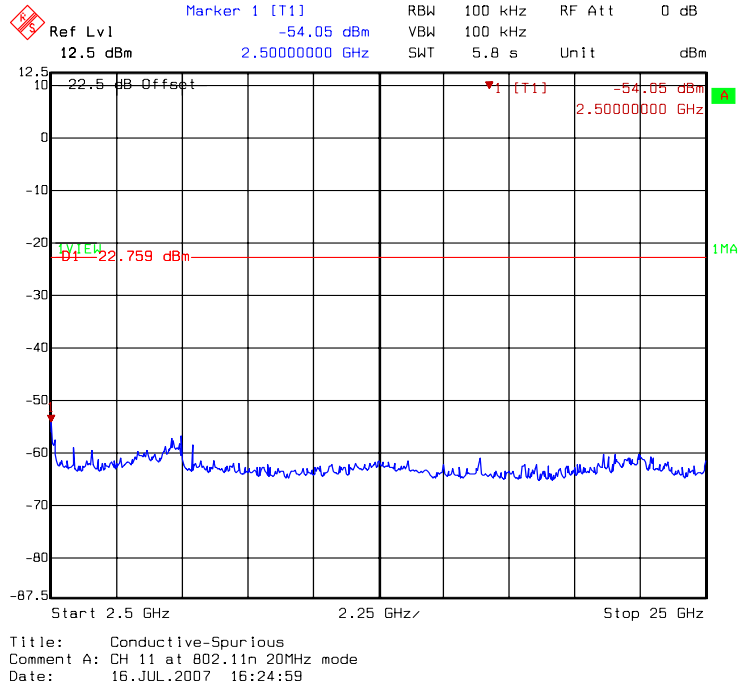

DAC0: conducted spurious @ draft 802.11n 40MHz mode channel 3 (1 of 3)

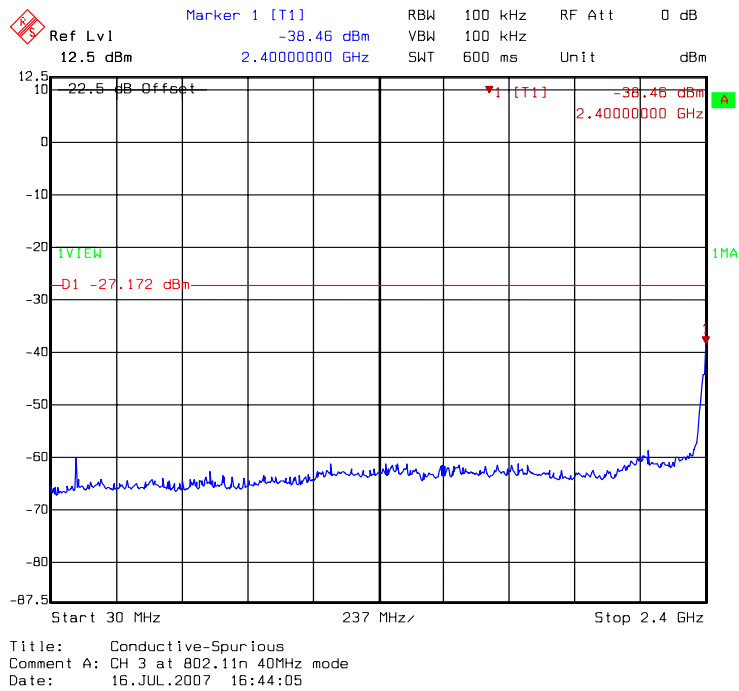

DAC0: conducted spurious @ draft 802.11n 40MHz mode channel 3 (2 of 3)

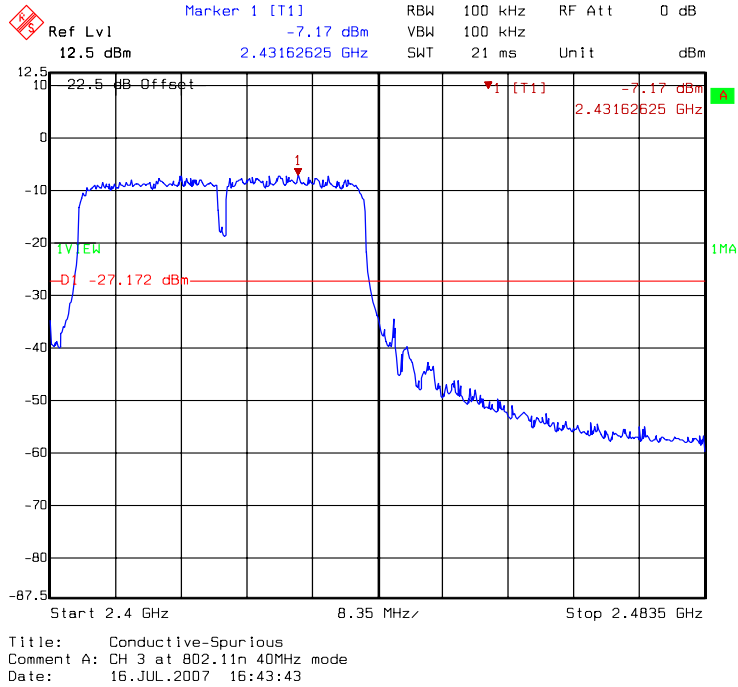

DAC0: conducted spurious @ draft 802.11n 40MHz mode channel 3 (3 of 3)

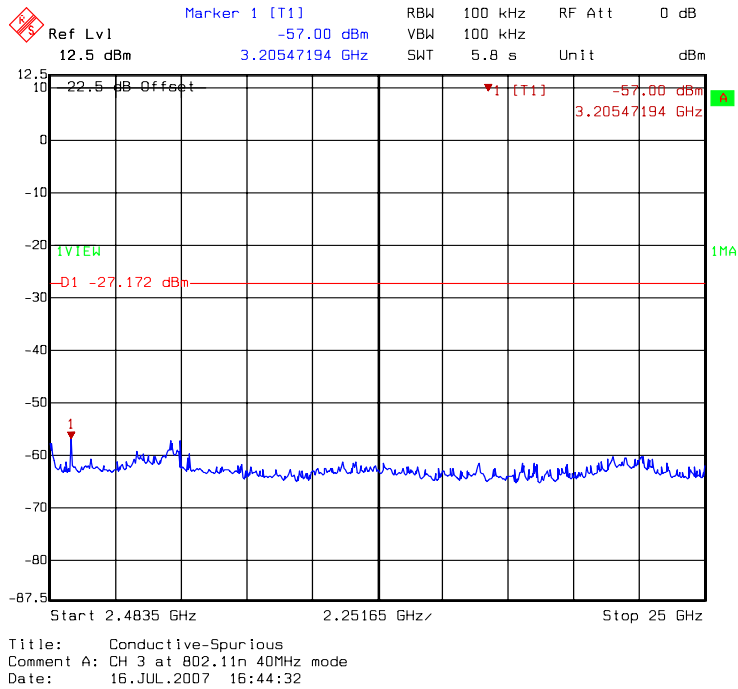

DAC0: conducted spurious @ draft 802.11n 40MHz mode channel 6 (1 of 3)

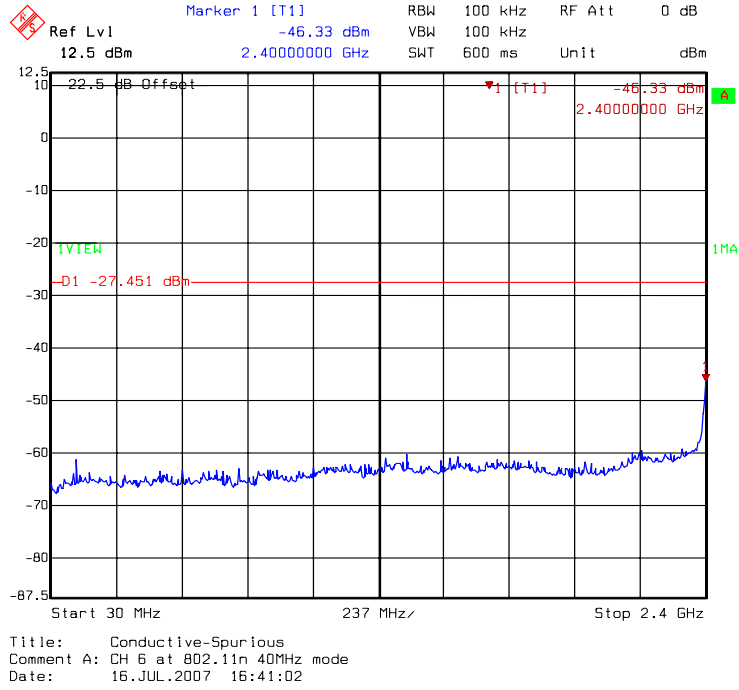

DAC0: conducted spurious @ draft 802.11n 40MHz mode channel 6 (2 of 3)

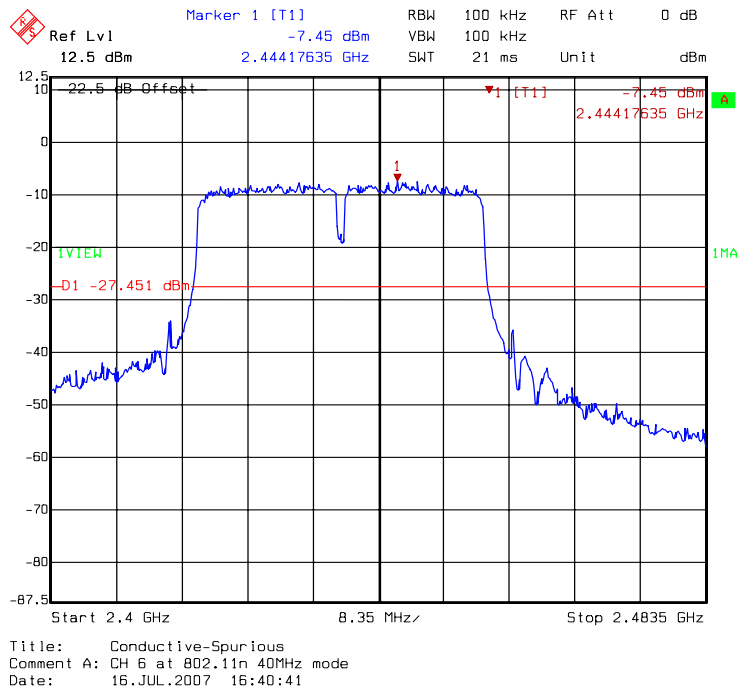

DAC0: conducted spurious @ draft 802.11n 40MHz mode channel 6 (3 of 3)

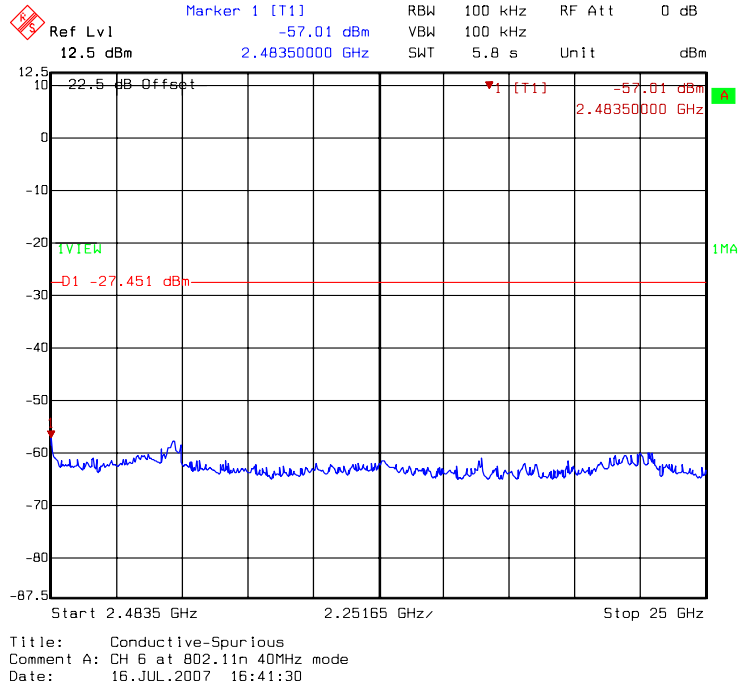

DAC0: conducted spurious @ draft 802.11n 40MHz mode channel 9 (1 of 3)

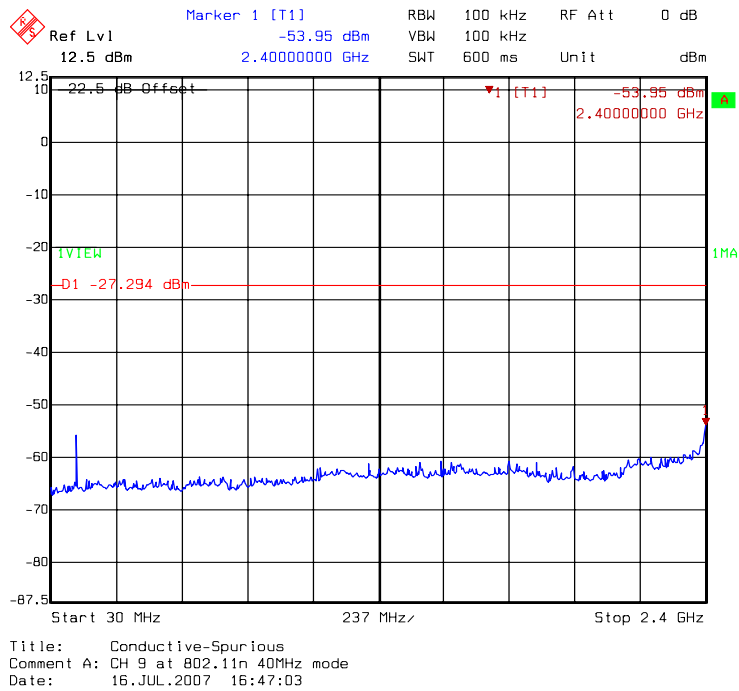

DAC0: conducted spurious @ draft 802.11n 40MHz mode channel 9 (2 of 3)

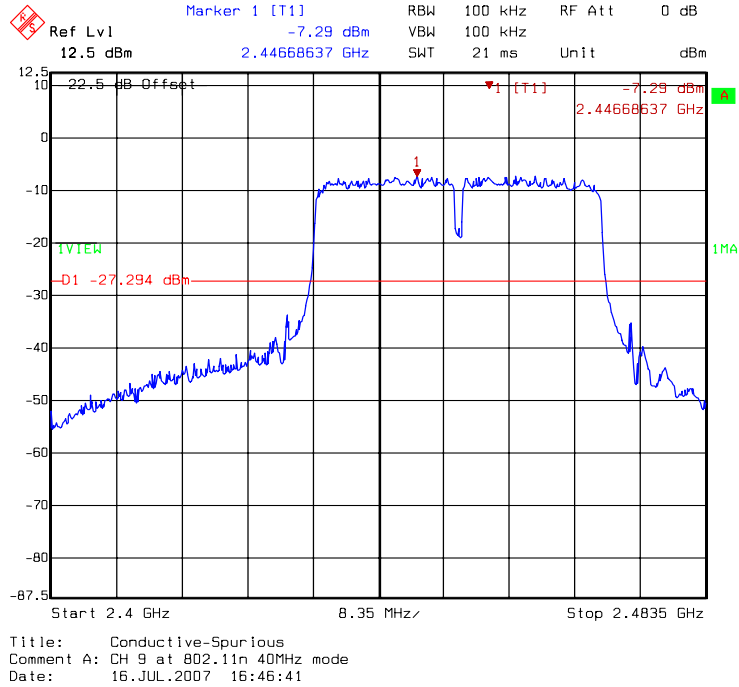

DAC0: conducted spurious @ draft 802.11n 40MHz mode channel 9 (3 of 3)

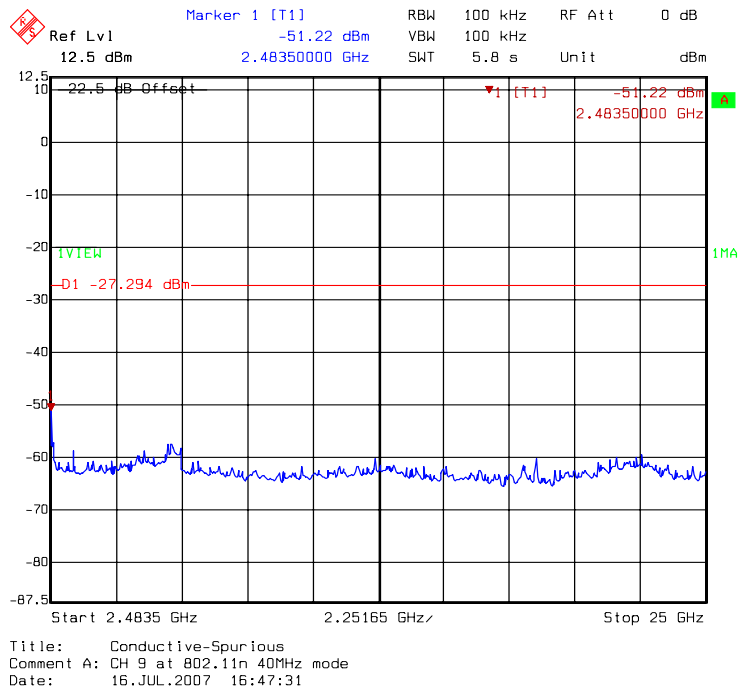

DAC1: conducted spurious @ 802.11b mode channel 1 (1 of 3)

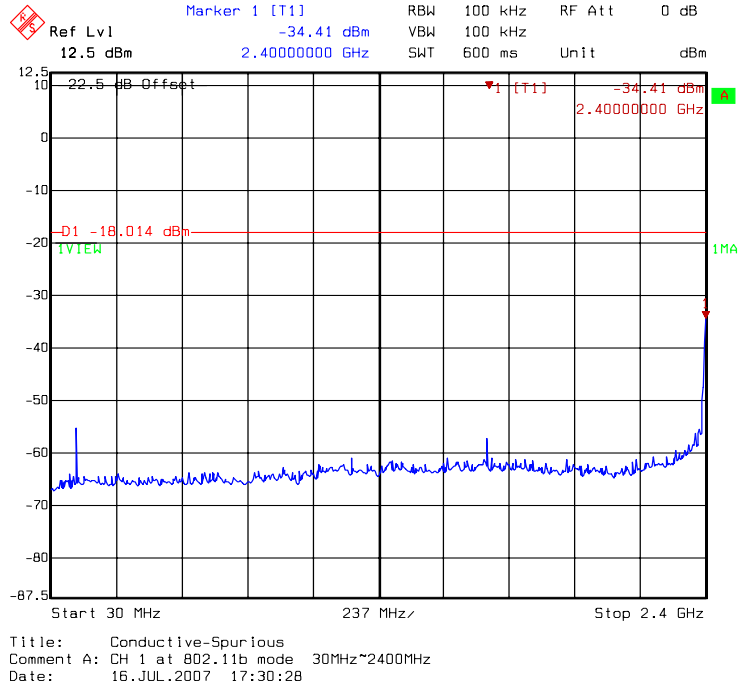

DAC1: conducted spurious @ 802.11b mode channel 1 (2 of 3)

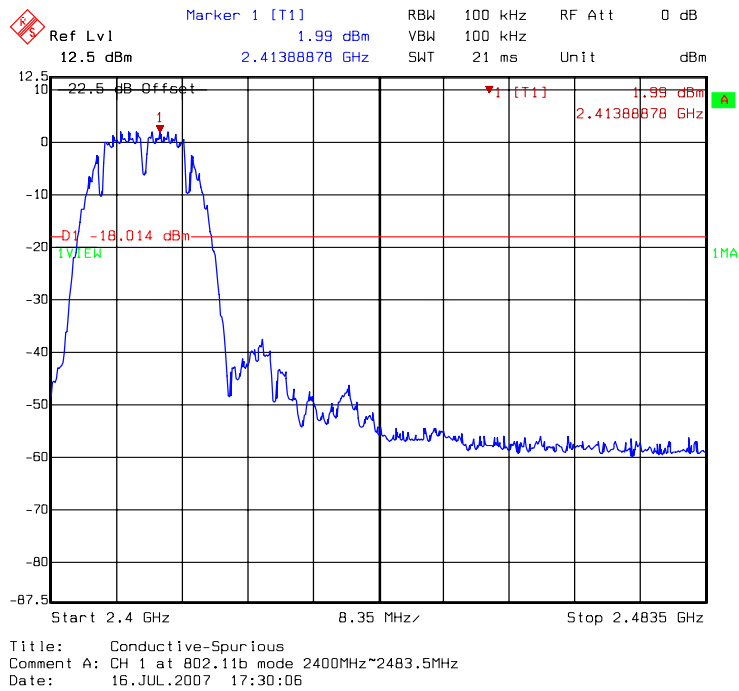

DAC1: conducted spurious @ 802.11b mode channel 1 (3 of 3)

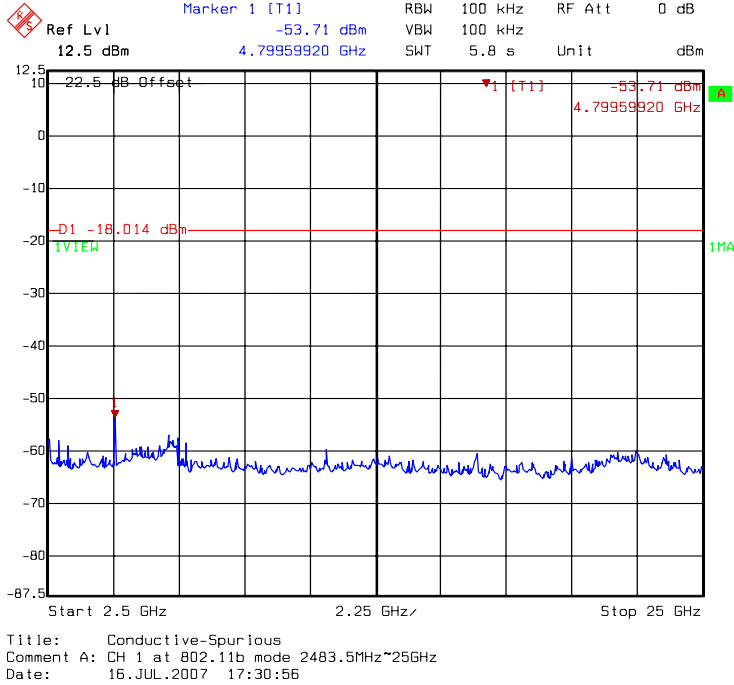

DAC1: conducted spurious @ 802.11b mode channel 6 (1 of 3)

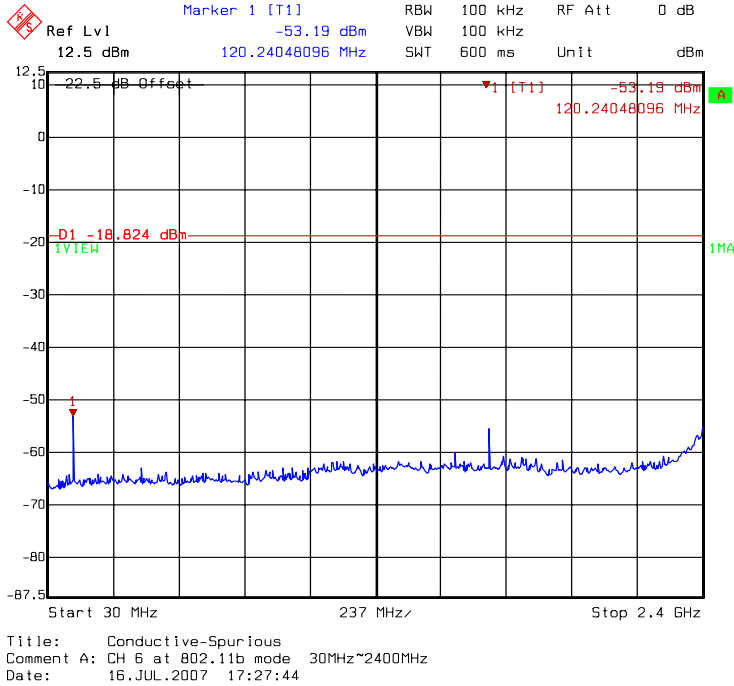

DAC1: conducted spurious @ 802.11b mode channel 6 (2 of 3)

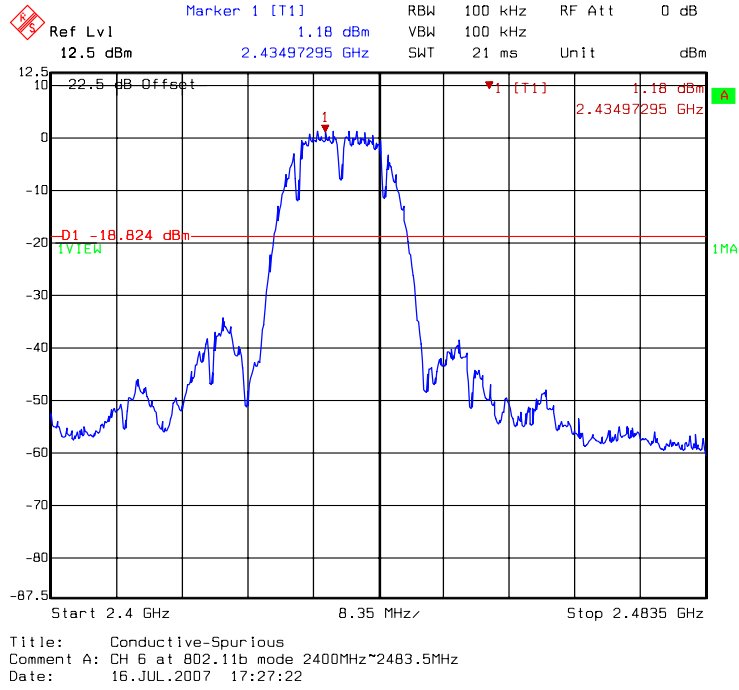

DAC1: conducted spurious @ 802.11b mode channel 6 (3 of 3)

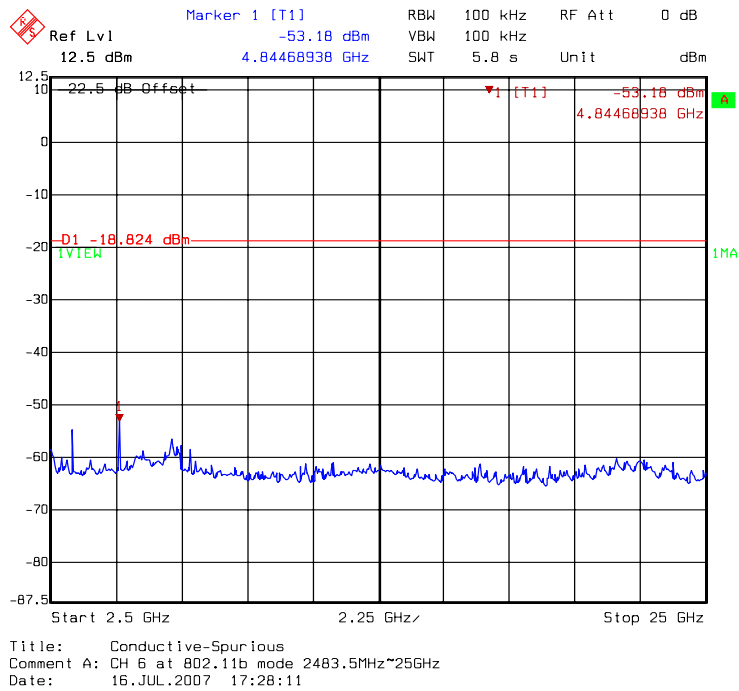

DAC1: conducted spurious @ 802.11b mode channel 11 (1 of 3)

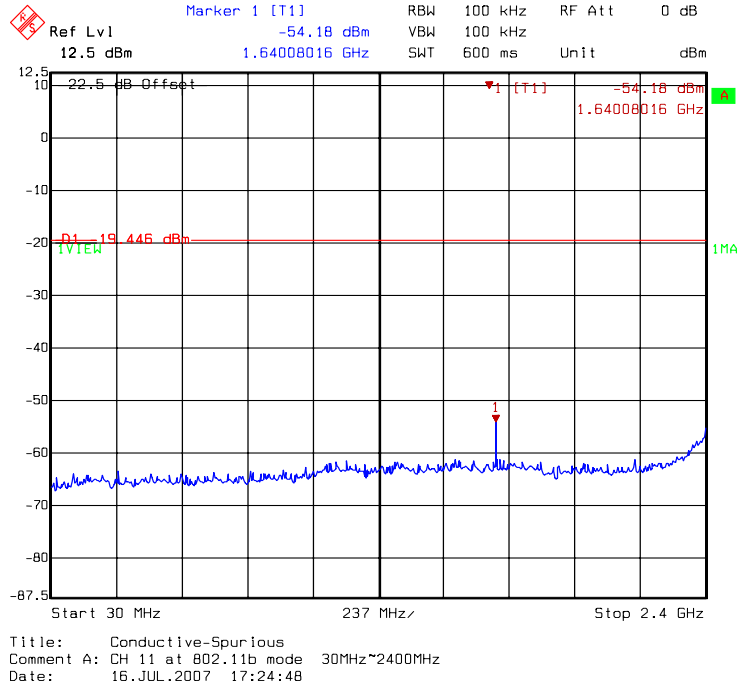

DAC1: conducted spurious @ 802.11b mode channel 11 (2 of 3)

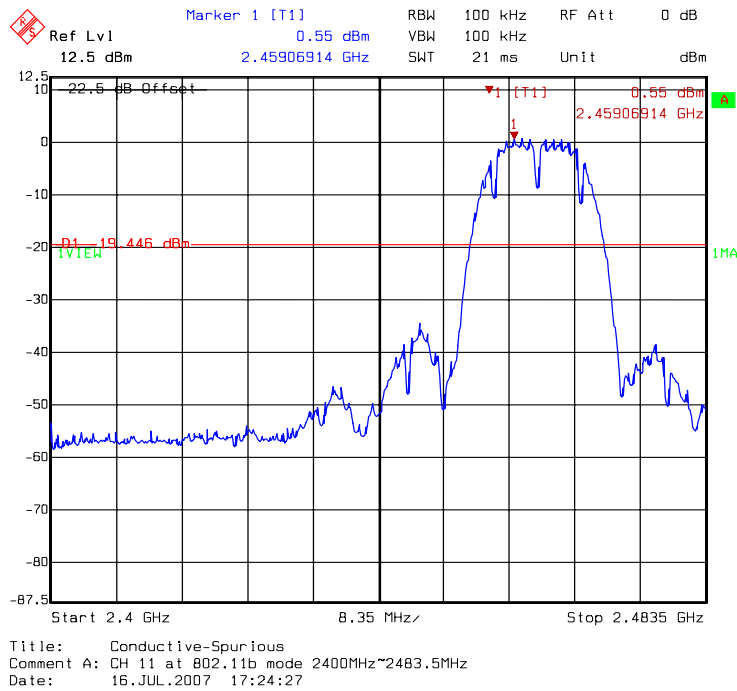

DAC1: conducted spurious @ 802.11b mode channel 11 (3 of 3)

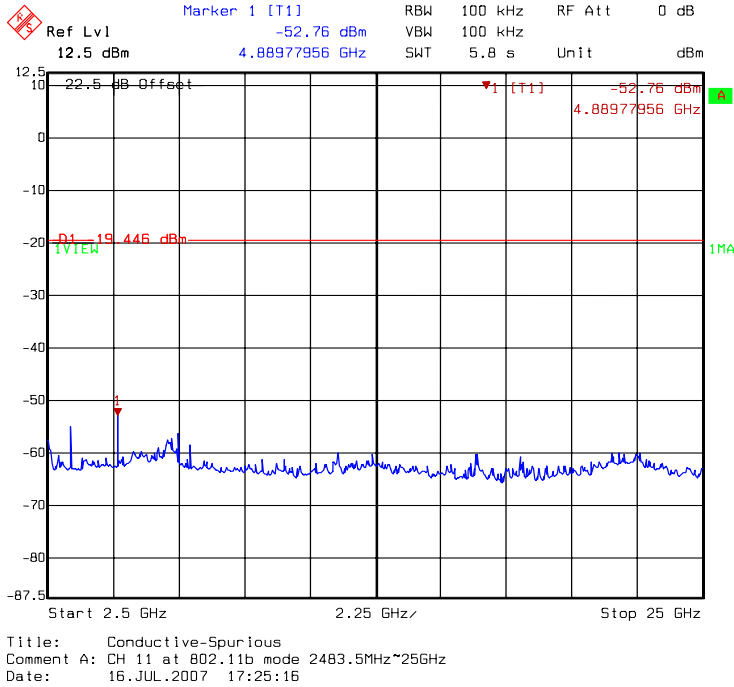

DAC1: conducted spurious @ 802.11g mode channel 1 (1 of 3)

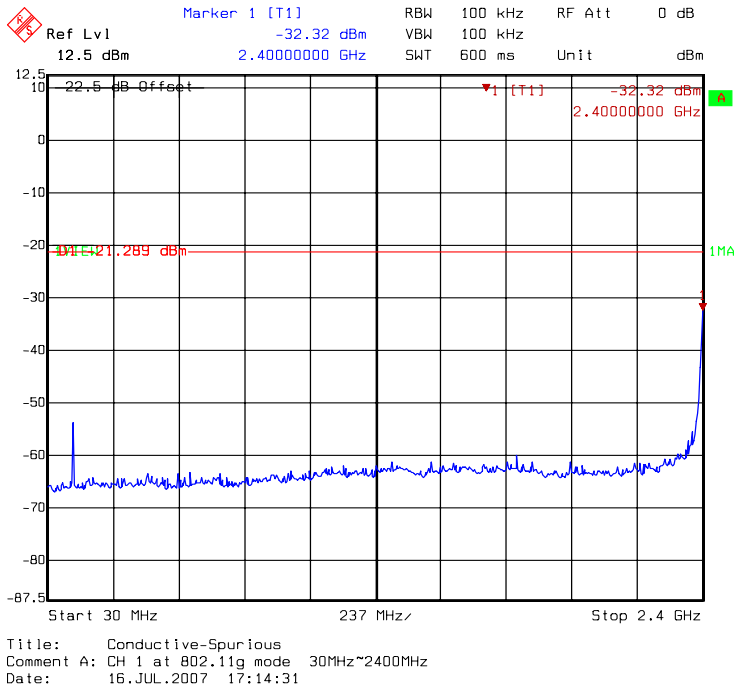

DAC1: conducted spurious @ 802.11g mode channel 1 (2 of 3)

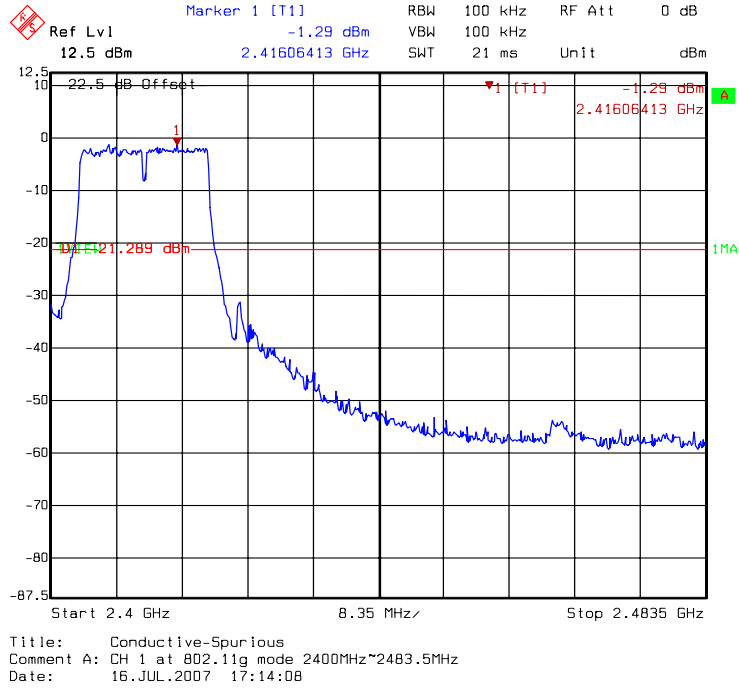

DAC1: conducted spurious @ 802.11g mode channel 1 (3 of 3)

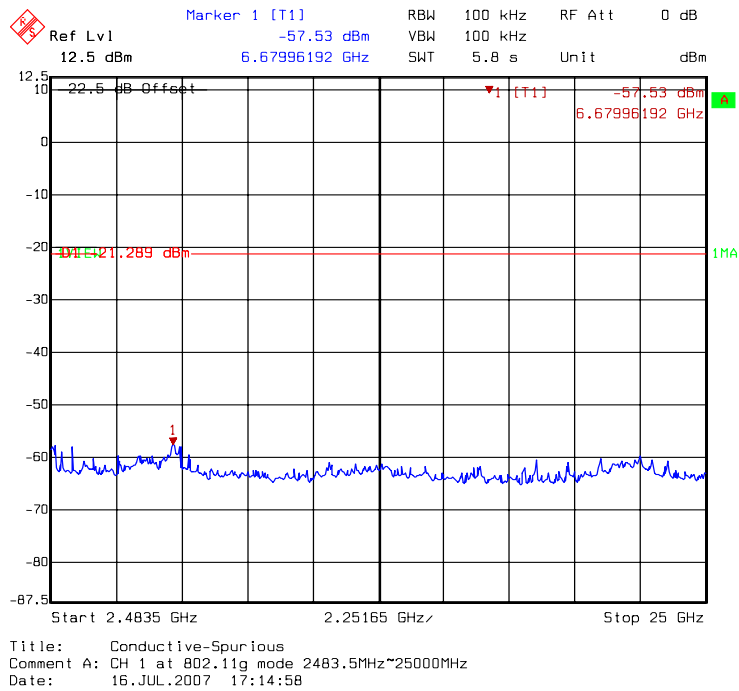

DAC1: conducted spurious @ 802.11g mode channel 6 (1 of 3)

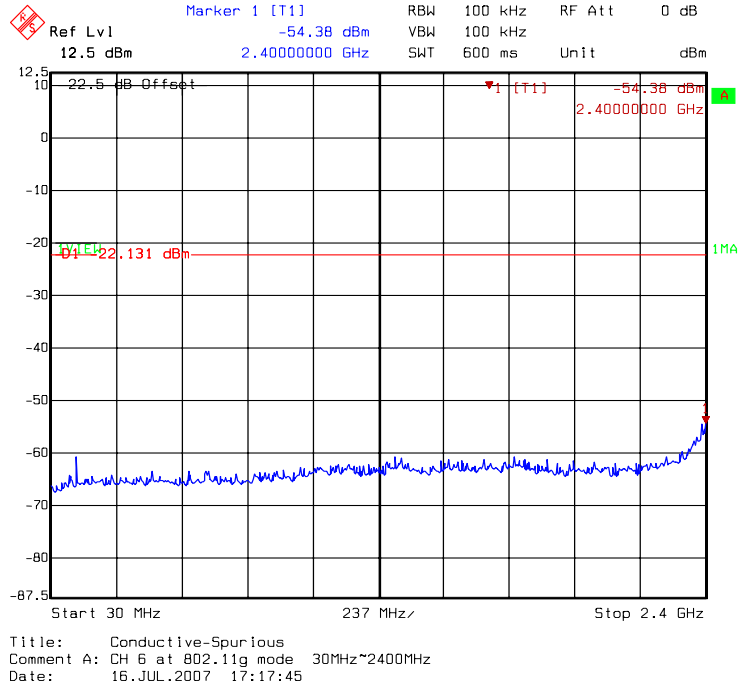

DAC1: conducted spurious @ 802.11g mode channel 6 (2 of 3)

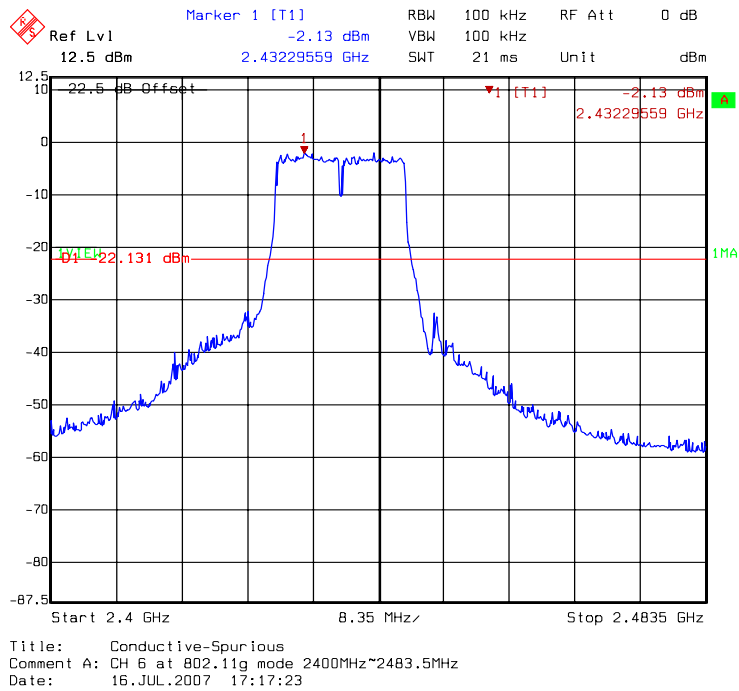

DAC1: conducted spurious @ 802.11g mode channel 6 (3 of 3)

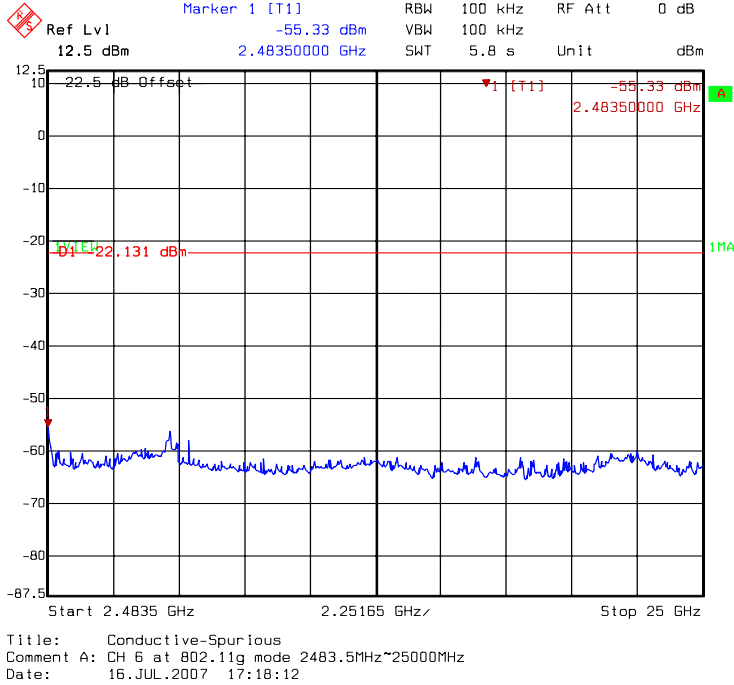

DAC1: conducted spurious @ 802.11g mode channel 11 (1 of 3)

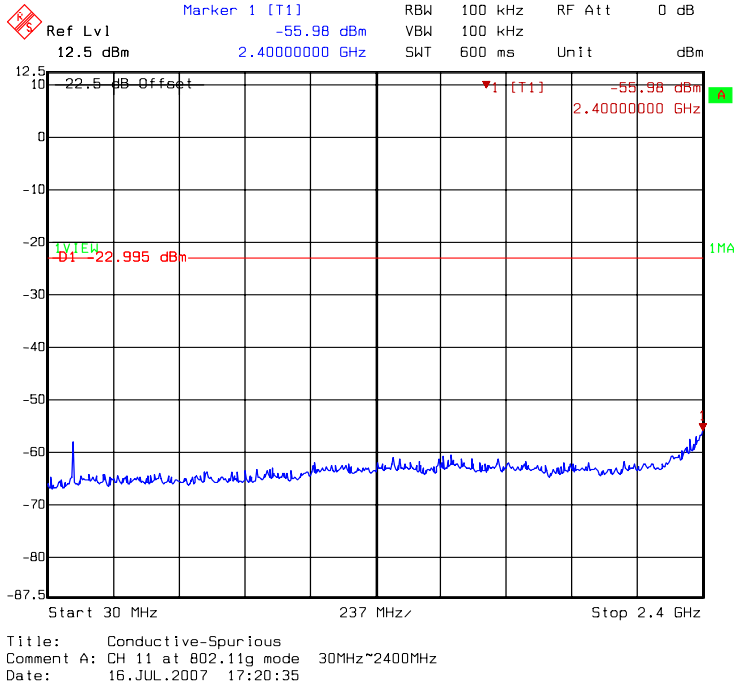

DAC1: conducted spurious @ 802.11g mode channel 11 (2 of 3)

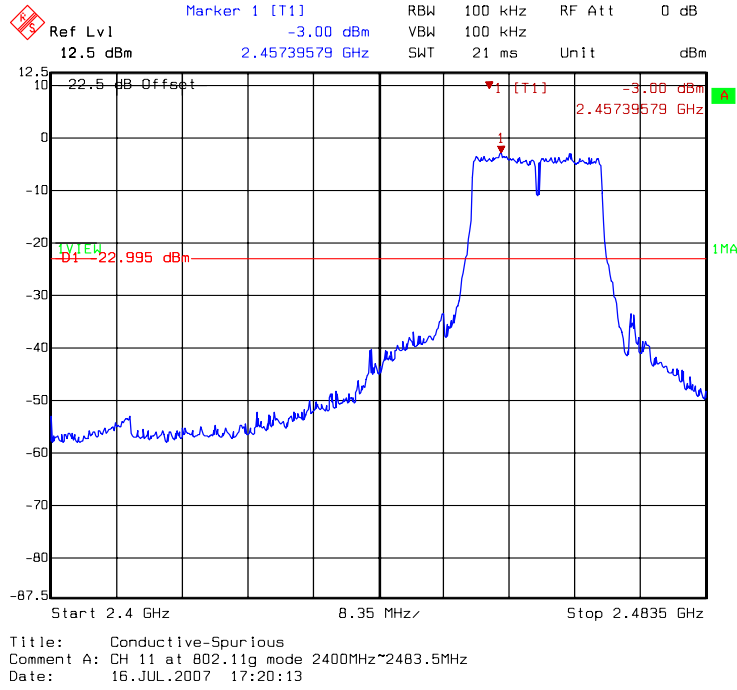

DAC1: conducted spurious @ 802.11g mode channel 11 (3 of 3)

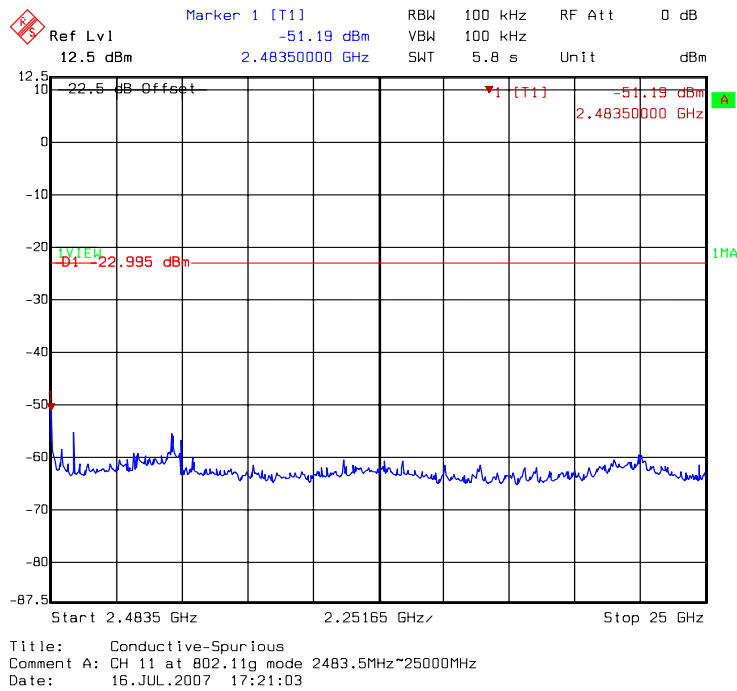

DAC1: conducted spurious @ draft 802.11n 20MHz mode channel 1 (1 of 3)

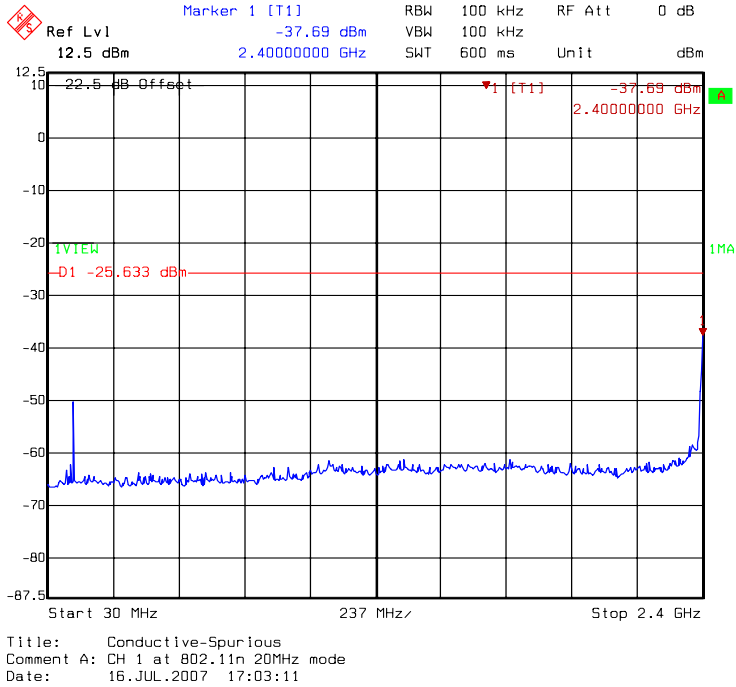

DAC1: conducted spurious @ draft 802.11n 20MHz mode channel 1 (2 of 3)

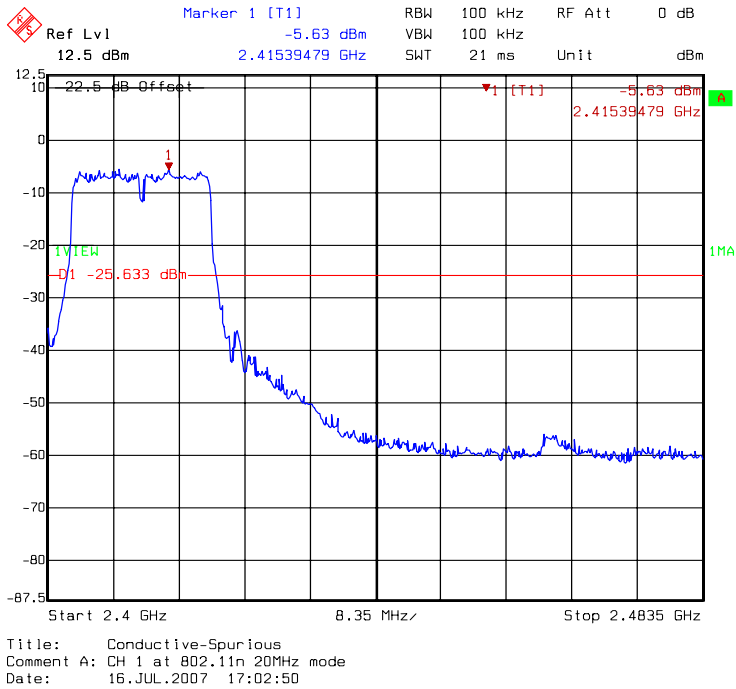

DAC1: conducted spurious @ draft 802.11n 20MHz mode channel 1 (3 of 3)

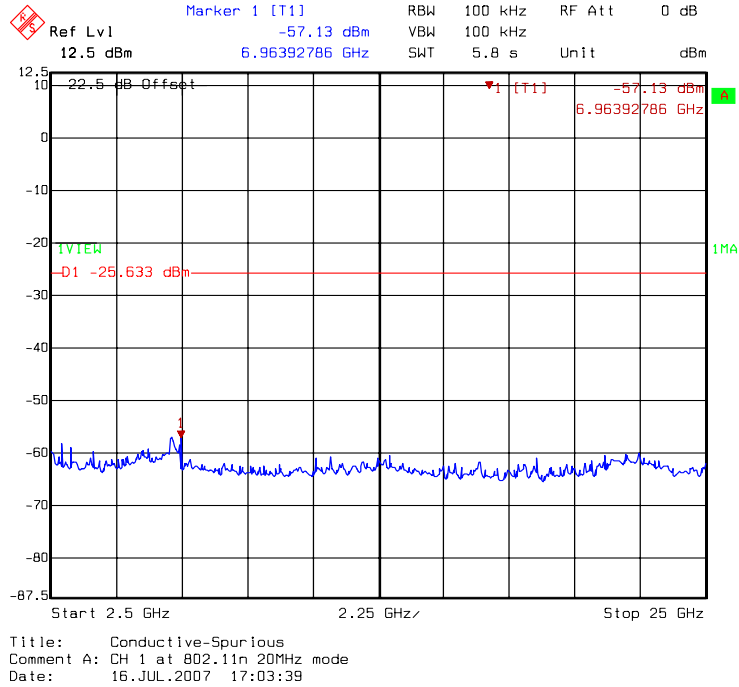

DAC1: conducted spurious @ draft 802.11n 20MHz mode channel 6 (1 of 3)

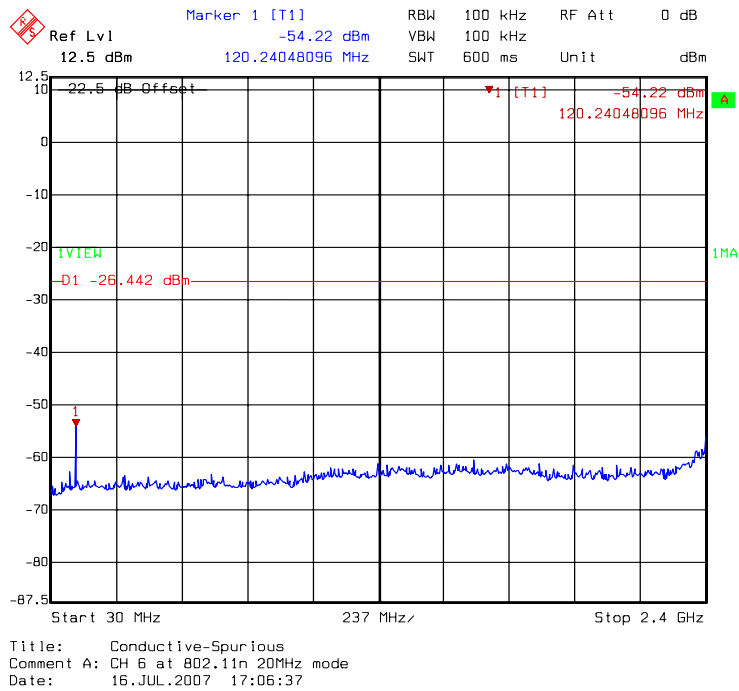

DAC1: conducted spurious @ draft 802.11n 20MHz mode channel 6 (2 of 3)

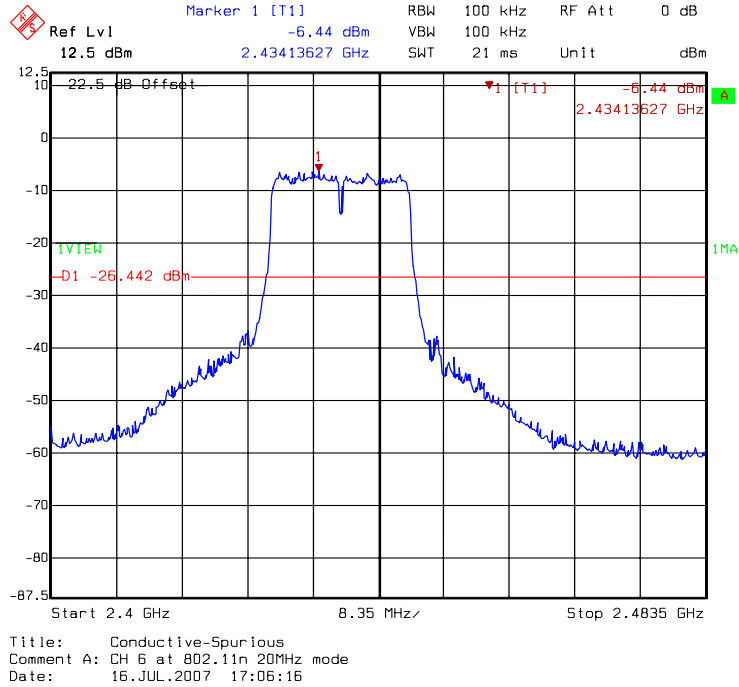

DAC1: conducted spurious @ draft 802.11n 20MHz mode channel 6 (3 of 3)

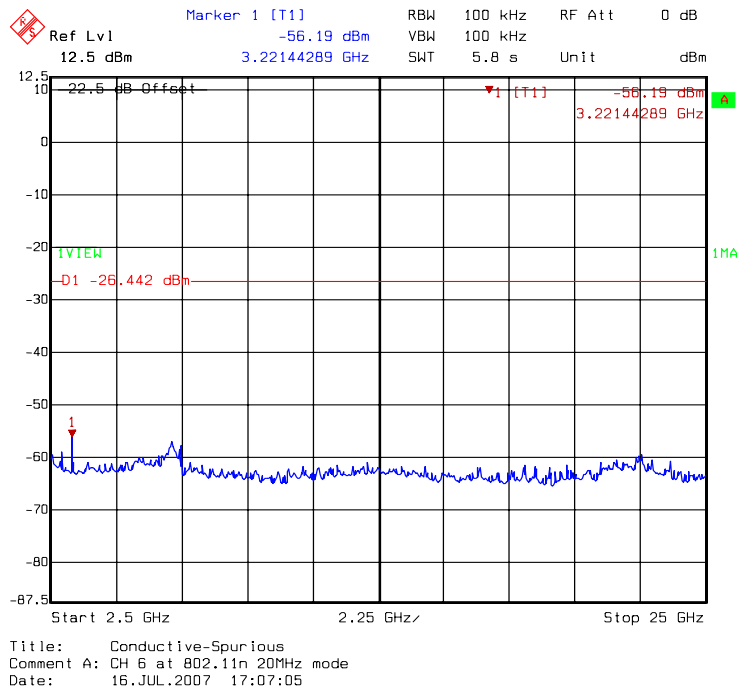

DAC1: conducted spurious @ draft 802.11n 20MHz mode channel 11 (1 of 3)

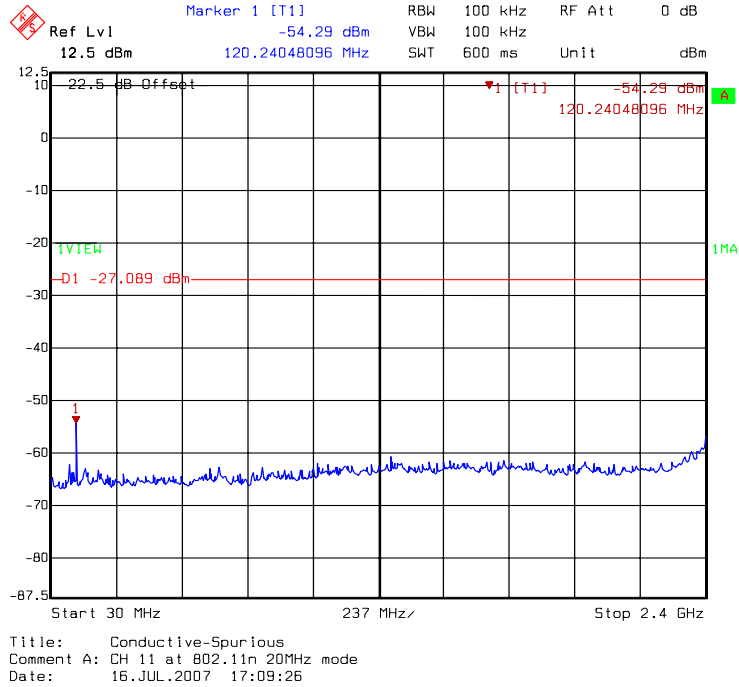

DAC1: conducted spurious @ draft 802.11n 20MHz mode channel 11 (2 of 3)

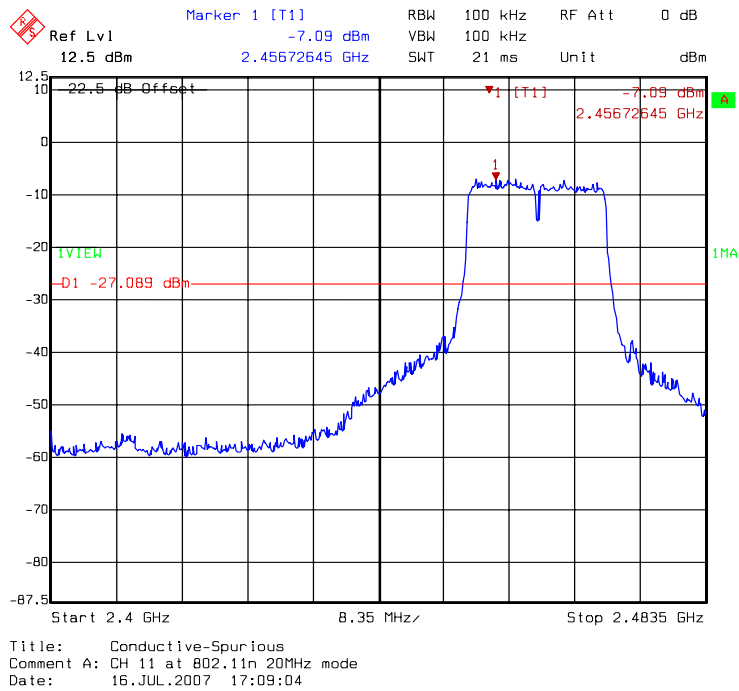

DAC1: conducted spurious @ draft 802.11n 20MHz mode channel 11 (3 of 3)

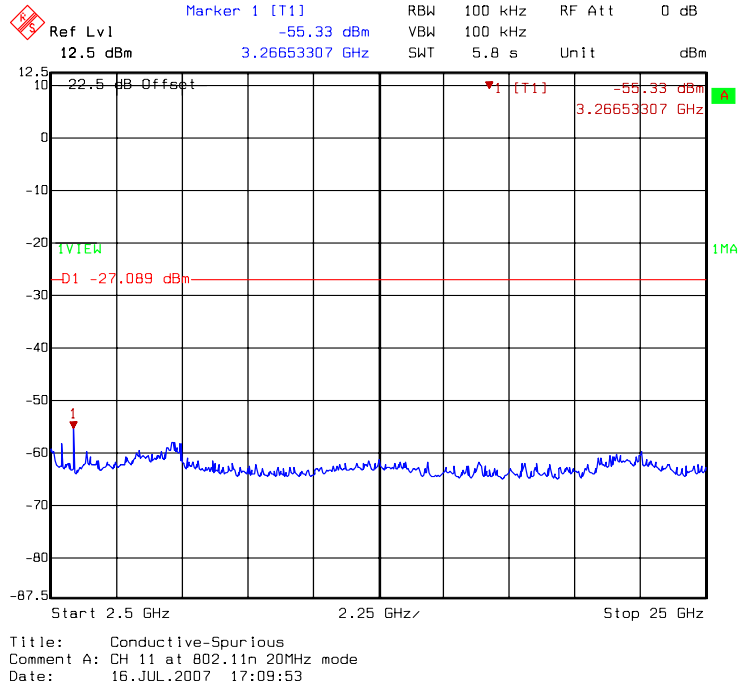

DAC1: conducted spurious @ draft 802.11n 40MHz mode channel 3 (1 of 3)

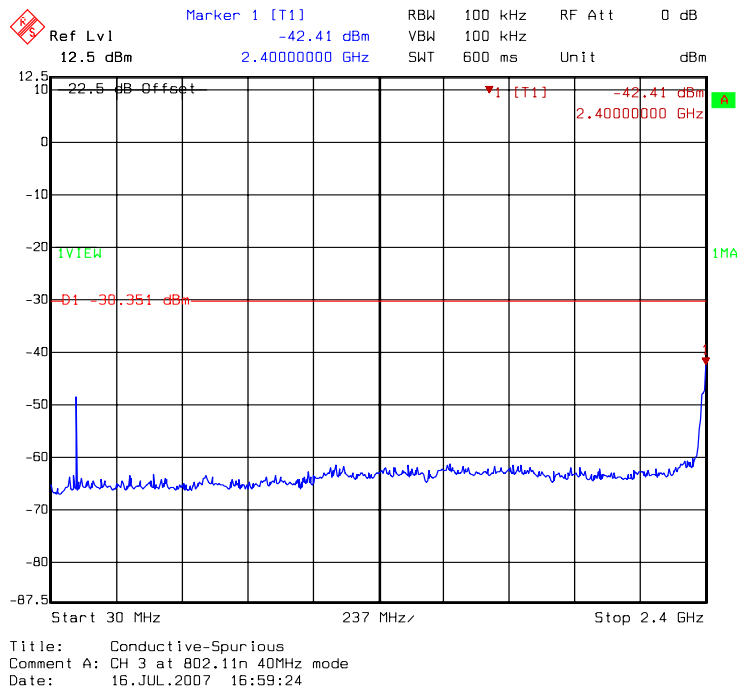

DAC1: conducted spurious @ draft 802.11n 40MHz mode channel 3 (2 of 3)

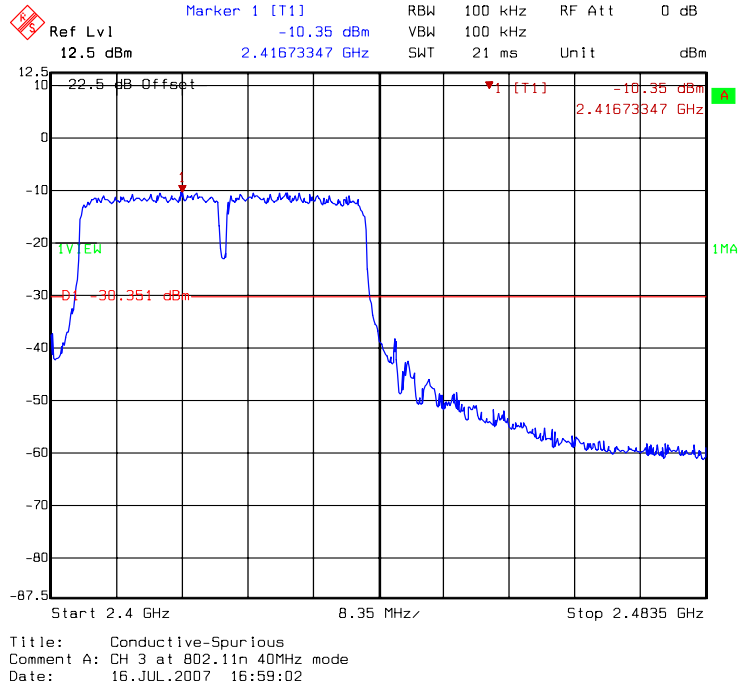

DAC1: conducted spurious @ draft 802.11n 40MHz mode channel 3 (3 of 3)

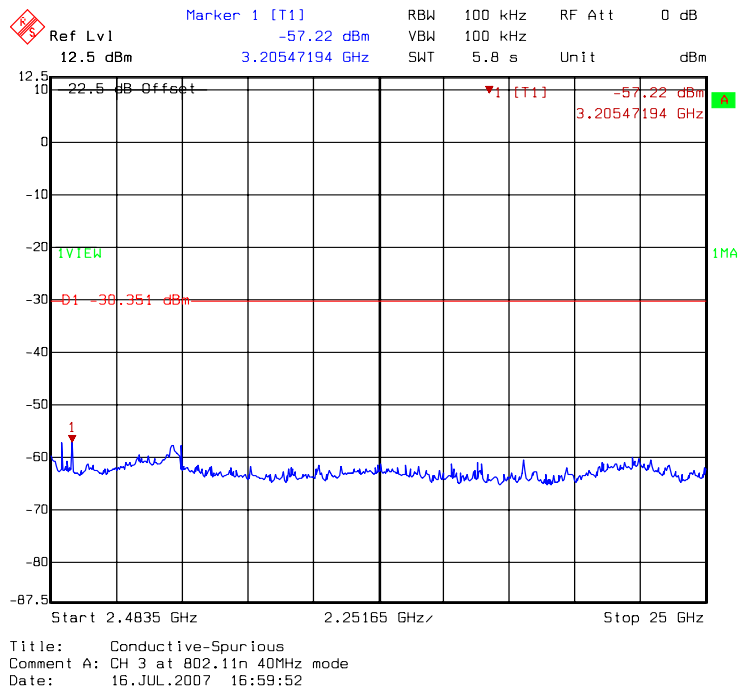

DAC1: conducted spurious @ draft 802.11n 40MHz mode channel 6 (1 of 3)

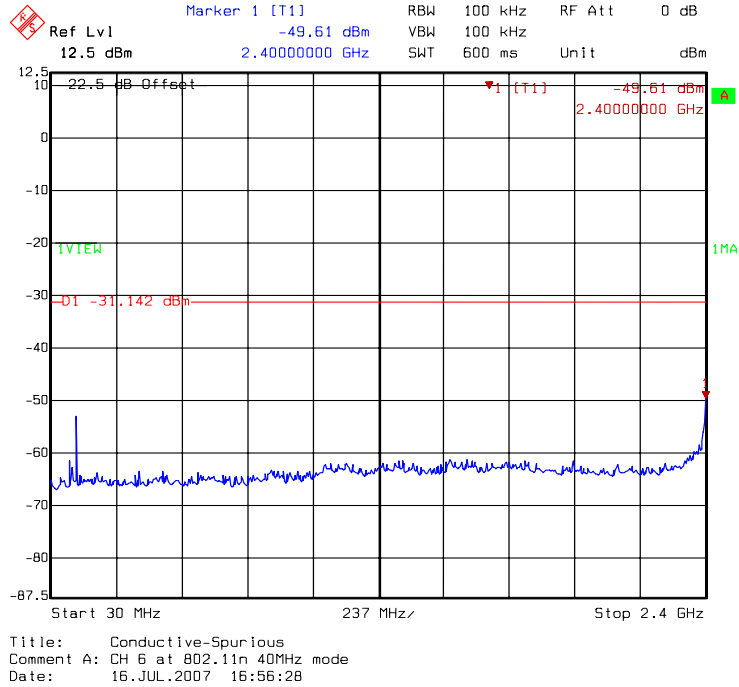

DAC1: conducted spurious @ draft 802.11n 40MHz mode channel 6 (2 of 3)

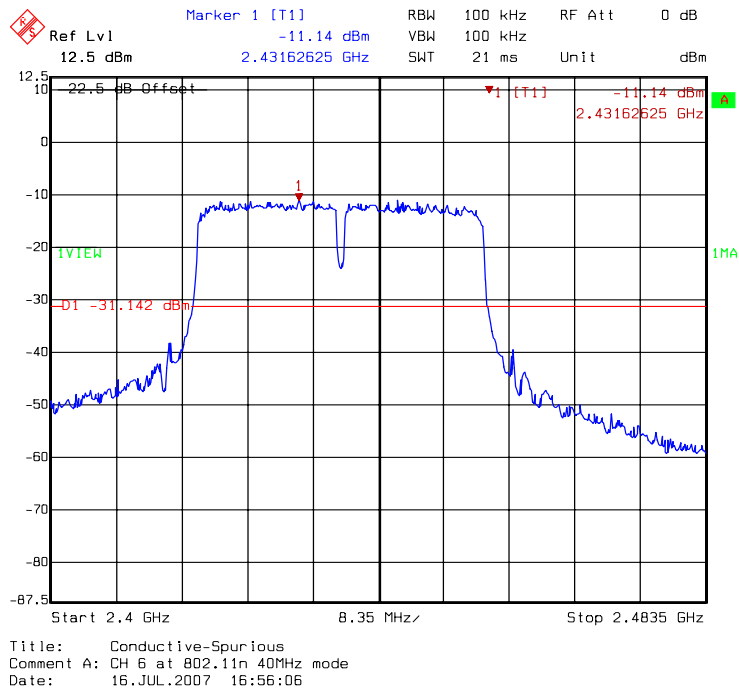

DAC1: conducted spurious @ draft 802.11n 40MHz mode channel 6 (3 of 3)

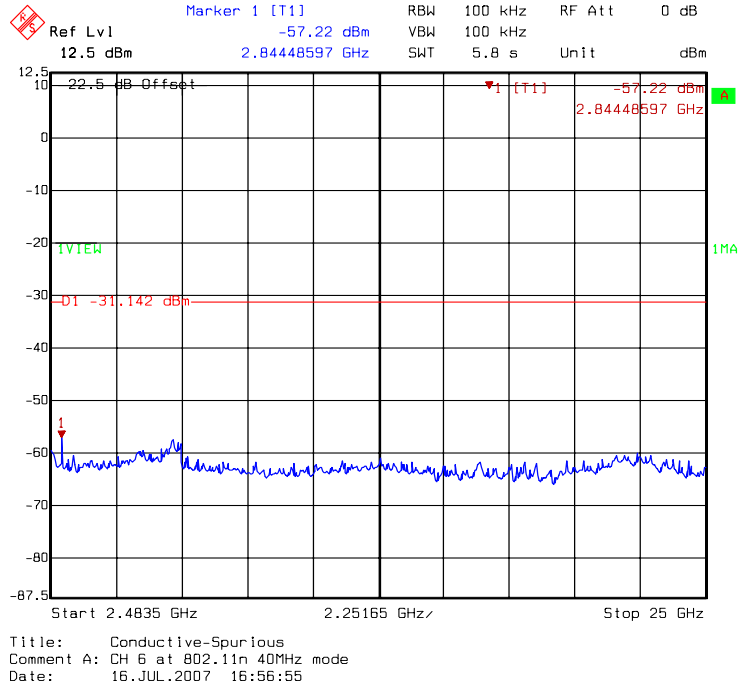

DAC1: conducted spurious @ draft 802.11n 40MHz mode channel 9 (1 of 3)

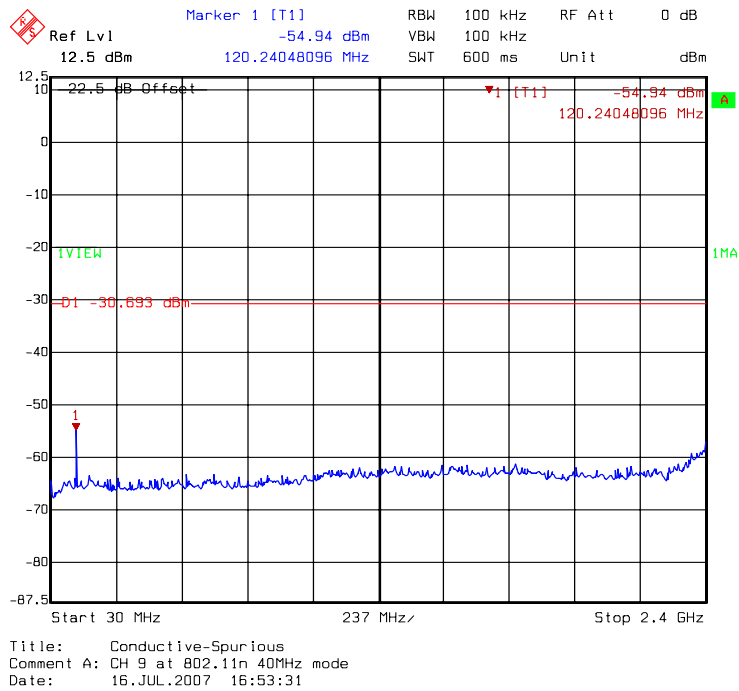

DAC1: conducted spurious @ draft 802.11n 40MHz mode channel 9 (2 of 3)

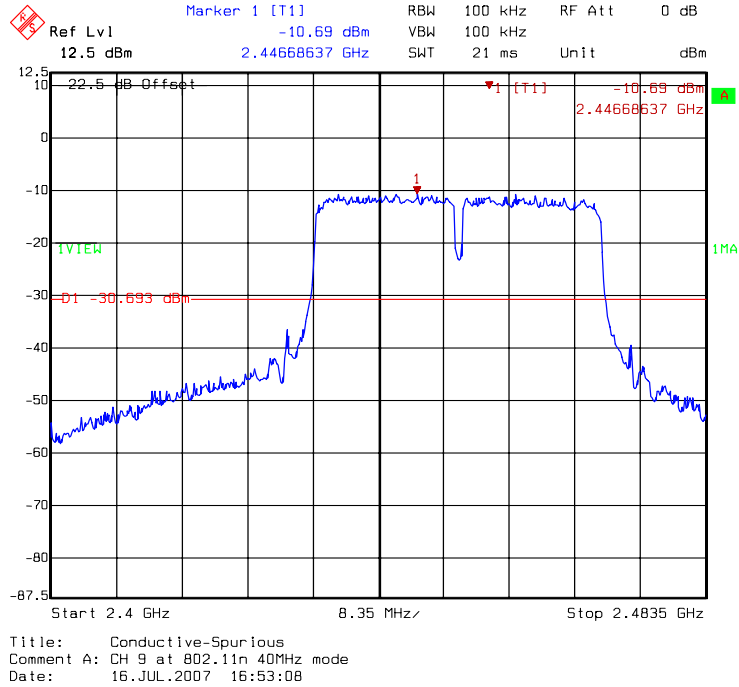

DAC1: conducted spurious @ draft 802.11n 40MHz mode channel 9 (3 of 3)

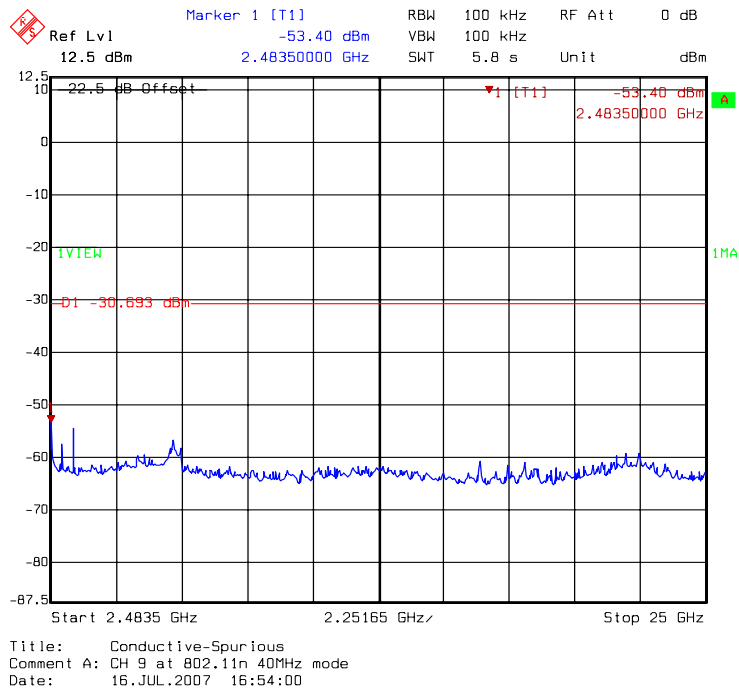

8. Radiated Spurious Emission

Name of Test	Radiated Spurious Emission
Base Standard	FCC 15.247(d), 15.209, 15.205

Tested By: Marx Yan
Test Date: Jul. 18, 2007

Test Equipment: EC365

Test Result: Complies
Test Method: See Appendix E
Measurement Data: See Tables below

Note: (1) The EUT was tested while in a continuous transmit mode. The EUT was tuned to a low, middle and high channel.
(2) The EUT operating at 2.4GHz ISM band. Frequency Range scanned from 30MHz to 25GHz.

Measurement results: frequencies equal to or less than 1 GHz

The test was performed on EUT under 802.11b/g/n continuously transmitting mode. Channel 1, 6, 11 were verified. The worst case occurred at 802.11n (20MHz) Tx channel 1.

EUT : WL-600
Worst Case : 802.11n(20MHz) dual Tx at channel 1

Antenna Polariz. (V/H)	Freq. (MHz)	Receiver Detector	Corr. Factor (dB/m)	Reading (dBuV)	Corrected Level (dBuV/m)	Limit @ 3 m (dBuV/m)	Margin (dB)
V	132.820	QP	11.39	15.56	26.95	43.50	-16.55
V	365.620	QP	15.06	17.05	32.11	46.00	-13.89
V	474.260	QP	17.68	11.95	29.63	46.00	-16.37
V	499.480	QP	18.43	13.47	31.90	46.00	-14.11
V	599.390	QP	20.71	13.52	34.23	46.00	-11.77
V	903.000	QP	24.32	13.73	38.05	46.00	-7.96
H	249.220	QP	12.36	12.81	25.17	46.00	-20.83
H	339.430	QP	14.40	12.86	27.26	46.00	-18.75
H	365.620	QP	15.48	20.56	36.04	46.00	-9.97
H	399.570	QP	16.74	12.82	29.56	46.00	-16.44
H	408.300	QP	16.81	13.57	30.38	46.00	-15.62
H	852.560	QP	24.12	8.87	32.99	46.00	-13.02

Remark:

1. Corr. Factor = Antenna Factor + Cable Loss
2. Corrected Level = Reading + Corr. Factor

Measurement results: frequency above 1GHz

Single Tx

EUT : WL-600
Test : 802.11b Tx at channel 1 (DAC0)

Frequency (MHz)	Spectrum Analyzer Detector	Antenna Polariz. (H/V)	Preamp. Gain (dB)	Correction Factor (dB/m)	Reading (dBuV)	Corrected Level (dBuV/m)	Limit @ 3 m (dBuV/m)	Margin (dB)
7230.00	PK	V	36.18	43.97	44.53	52.32	54	-1.68

Remark:

1. Correction Factor = Antenna Factor + Cable Loss
2. Corrected Level = Reading + Correction Factor – Preamp. Gain
3. The frequency measured ranges from 1GHz to 25GHz.The data value listed above which is higher than the system noise floor.

EUT : WL-600
Test : 802.11b Tx at channel 6 (DAC0)

Frequency (MHz)	Spectrum Analyzer Detector	Antenna Polariz. (H/V)	Preamp. Gain (dB)	Correction Factor (dB/m)	Reading (dBuV)	Corrected Level (dBuV/m)	Limit @ 3 m (dBuV/m)	Margin (dB)
7230.00	PK	V	36.18	43.97	45.43	53.22	54	-0.78

Remark:

1. Correction Factor = Antenna Factor + Cable Loss
2. Corrected Level = Reading + Correction Factor – Preamp. Gain
3. The frequency measured ranges from 1GHz to 25GHz.The data value listed above which is higher than the system noise floor.

EUT : WL-600
Test : 802.11b Tx at channel 11 (DAC0)

Frequency (MHz)	Spectrum Analyzer Detector	Antenna Polariz. (H/V)	Preamp. Gain (dB)	Correction Factor (dB/m)	Reading (dBuV)	Corrected Level (dBuV/m)	Limit @ 3 m (dBuV/m)	Margin (dB)
7380.00	PK	V	36.18	43.97	43.63	51.42	54	-2.58

Remark:

1. Correction Factor = Antenna Factor + Cable Loss
2. Corrected Level = Reading + Correction Factor – Preamp. Gain
3. The frequency measured ranges from 1GHz to 25GHz. The data value listed above which is higher than the system noise floor.

EUT : WL-600
Test : 802.11b Tx at channel 1 (DAC1)

No spurious emission was found above the system noise floor.

EUT : WL-600
Test : 802.11b Tx at channel 6 (DAC1)

No spurious emission was found above the system noise floor.

EUT : WL-600
Test : 802.11b Tx at channel 11 (DAC1)

Frequency (MHz)	Spectrum Analyzer Detector	Antenna Polariz. (H/V)	Preamp. Gain (dB)	Correction Factor (dB/m)	Reading (dBuV)	Corrected Level (dBuV/m)	Limit @ 3 m (dBuV/m)	Margin (dB)
4980.00	PK	V	36.07	37.77	43.17	44.87	54	-9.13

Remark:

1. Correction Factor = Antenna Factor + Cable Loss
2. Corrected Level = Reading + Correction Factor – Preamp. Gain
3. The frequency measured ranges from 1GHz to 25GHz.The data value listed above which is higher than the system noise floor.

EUT : WL-600
Test : 802.11g Tx at channel 1 (DAC0)

Frequency (MHz)	Spectrum Analyzer Detector	Antenna Polariz. (H/V)	Preamp. Gain (dB)	Correction Factor (dB/m)	Reading (dBuV)	Corrected Level (dBuV/m)	Limit @ 3 m (dBuV/m)	Margin (dB)
7230.00	PK	V	36.18	43.97	42.38	50.17	54	-3.83

Remark:

1. Correction Factor = Antenna Factor + Cable Loss
2. Corrected Level = Reading + Correction Factor – Preamp. Gain
3. The frequency measured ranges from 1GHz to 25GHz.The data value listed above which is higher than the system noise floor.

EUT : WL-600
Test : 802.11g Tx at channel 6 (DAC0)

Frequency (MHz)	Spectrum Analyzer Detector	Antenna Polariz. (H/V)	Preamp. Gain (dB)	Correction Factor (dB/m)	Reading (dBuV)	Corrected Level (dBuV/m)	Limit @ 3 m (dBuV/m)	Margin (dB)
7320.00	PK	V	36.18	43.97	42.59	50.38	54	-3.62

Remark:

1. Correction Factor = Antenna Factor + Cable Loss
2. Corrected Level = Reading + Correction Factor – Preamp. Gain
3. The frequency measured ranges from 1GHz to 25GHz.The data value listed above which is higher than the system noise floor.

EUT : WL-600
Test : 802.11g Tx at channel 11 (DAC0)

Frequency (MHz)	Spectrum Analyzer Detector	Antenna Polariz. (H/V)	Preamp. Gain (dB)	Correction Factor (dB/m)	Reading (dBuV)	Corrected Level (dBuV/m)	Limit @ 3 m (dBuV/m)	Margin (dB)
4980.00	PK	V	36.07	37.77	42.78	44.48	54	-9.52

Remark:

1. Correction Factor = Antenna Factor + Cable Loss
2. Corrected Level = Reading + Correction Factor – Preamp. Gain
3. The frequency measured ranges from 1GHz to 25GHz. The data value listed above which is higher than the system noise floor.

EUT : WL-600
Test : 802.11g Tx at channel 1 (DAC1)

No spurious emission was found above the system noise floor.

EUT : WL-600
Test : 802.11g Tx at channel 6 (DAC1)

No spurious emission was found above the system noise floor.

EUT : WL-600
Test : 802.11g Tx at channel 11 (DAC1)

No spurious emission was found above the system noise floor.

EUT : WL-600
Test : 802.11n 20MHz Tx at channel 1 (DAC0)

Frequency (MHz)	Spectrum Analyzer Detector	Antenna Polariz. (H/V)	Preamp. Gain (dB)	Correction Factor (dB/m)	Reading (dBuV)	Corrected Level (dBuV/m)	Limit @ 3 m (dBuV/m)	Margin (dB)
5700.00	PK	V	36.69	40.55	41.1	44.96	54	-9.04

Remark:

1. Correction Factor = Antenna Factor + Cable Loss
2. Corrected Level = Reading + Correction Factor – Preamp. Gain
3. The frequency measured ranges from 1GHz to 25GHz. The data value listed above which is higher than the system noise floor.

EUT : WL-600
Test : 802.11n 20MHz Tx at channel 6 (DAC0)

No spurious emission was found above the system noise floor.

EUT : WL-600
Test : 802.11n 20MHz Tx at channel 11 (DAC0)

No spurious emission was found above the system noise floor.

EUT : WL-600
Test : 802.11n 20MHz Tx at channel 1 (DAC1)

No spurious emission was found above the system noise floor.

EUT : WL-600
Test : 802.11n 20MHz Tx at channel 6 (DAC1)

Frequency (MHz)	Spectrum Analyzer Detector	Antenna Polariz. (H/V)	Preamp. Gain (dB)	Correction Factor (dB/m)	Reading (dBuV)	Corrected Level (dBuV/m)	Limit @ 3 m (dBuV/m)	Margin (dB)
4950.00	PK	H	36.07	37.77	42.31	44.01	54	-9.99

Remark:

1. Correction Factor = Antenna Factor + Cable Loss
2. Corrected Level = Reading + Correction Factor – Preamp. Gain
3. The frequency measured ranges from 1GHz to 25GHz.The data value listed above which is higher than the system noise floor.

EUT : WL-600
Test : 802.11n 20MHz Tx at channel 11 (DAC1)

Frequency (MHz)	Spectrum Analyzer Detector	Antenna Polariz. (H/V)	Preamp. Gain (dB)	Correction Factor (dB/m)	Reading (dBuV)	Corrected Level (dBuV/m)	Limit @ 3 m (dBuV/m)	Margin (dB)
3720.00	PK	V	35.62	34.57	44.42	43.37	54	-10.63
3960.00	PK	V	35.62	34.57	43.48	42.43	54	-11.57

Remark:

1. Correction Factor = Antenna Factor + Cable Loss
2. Corrected Level = Reading + Correction Factor – Preamp. Gain
3. The frequency measured ranges from 1GHz to 25GHz.The data value listed above which is higher than the system noise floor.

EUT : WL-600
Test : 802.11n 40MHz Tx at channel 3 (DAC0)

No spurious emission was found above the system noise floor.

EUT : WL-600
Test : 802.11n 40MHz Tx at channel 6 (DAC0)

No spurious emission was found above the system noise floor.

EUT : WL-600
Test : 802.11n 40MHz Tx at channel 9 (DAC0)

No spurious emission was found above the system noise floor.

EUT : WL-600
Test : 802.11n 40MHz Tx at channel 3 (DAC1)

No spurious emission was found above the system noise floor.

EUT : WL-600
Test : 802.11n 40MHz Tx at channel 6 (DAC1)

No spurious emission was found above the system noise floor.

EUT : WL-600
Test : 802.11n 40MHz Tx at channel 9 (DAC1)

No spurious emission was found above the system noise floor.

Dual Tx

EUT : WL-600
Test : 802.11n 20MHz Tx at channel 1 (DAC0 & DAC1)

Frequency (MHz)	Spectrum Analyzer Detector	Antenna Polariz. (H/V)	Preamp. Gain (dB)	Correction Factor (dB/m)	Reading (dBuV)	Corrected Level (dBuV/m)	Limit @ 3 m (dBuV/m)	Margin (dB)
4980.00	PK	V	36.07	37.77	42.38	44.08	54	-9.92
5190.00	PK	V	36.38	38.73	42.04	44.39	54	-9.61
7230.00	PK	V	36.18	43.97	43.72	51.51	54	-2.49

Remark:

1. Correction Factor = Antenna Factor + Cable Loss
2. Corrected Level = Reading + Correction Factor – Preamp. Gain
3. The frequency measured ranges from 1GHz to 25GHz.The data value listed above which is higher than the system noise floor.

EUT : WL-600
Test : 802.11n 20MHz Tx at channel 6 (DAC0 & DAC1)

Frequency (MHz)	Spectrum Analyzer Detector	Antenna Polariz. (H/V)	Preamp. Gain (dB)	Correction Factor (dB/m)	Reading (dBuV)	Corrected Level (dBuV/m)	Limit @ 3 m (dBuV/m)	Margin (dB)
6480.00	PK	H	36.65	40.87	43.36	47.58	54	-6.42

Remark:

1. Correction Factor = Antenna Factor + Cable Loss
2. Corrected Level = Reading + Correction Factor – Preamp. Gain
3. The frequency measured ranges from 1GHz to 25GHz.The data value listed above which is higher than the system noise floor.

EUT : WL-600
Test : 802.11n 20MHz Tx at channel 11 (DAC0 & DAC1)

Frequency (MHz)	Spectrum Analyzer Detector	Antenna Polariz. (H/V)	Preamp. Gain (dB)	Correction Factor (dB/m)	Reading (dBuV)	Corrected Level (dBuV/m)	Limit @ 3 m (dBuV/m)	Margin (dB)
5220.00	PK	V	36.38	38.73	41.08	43.43	54	-10.57

Remark:

1. Correction Factor = Antenna Factor + Cable Loss
2. Corrected Level = Reading + Correction Factor – Preamp. Gain
3. The frequency measured ranges from 1GHz to 25GHz. The data value listed above which is higher than the system noise floor.

EUT : WL-600
Test : 802.11n 40MHz Tx at channel 3 (DAC0&DAC1)

No spurious emission was found above the system noise floor.

EUT : WL-600
Test : 802.11n 40MHz Tx at channel 6 (DAC0&DAC1)

No spurious emission was found above the system noise floor.

EUT : WL-600
Test : 802.11n 40MHz Tx at channel 9 (DAC0&DAC1)

No spurious emission was found above the system noise floor.

9. Emission on Band Edge

Name of Test	Emission Band Edge
Base Standard	FCC 15.247(d)

Tested By: Marx Yan
Test Date: Jul. 18, 2007

Test Equipment: EC365

Test Result: Complies
Test Method: See Appendix F
Measurement Data: See Tables & plots below

Note: The EUT was tested while in a continuous transmit mode. The EUT was tuned to a low and high channel.

Single Tx

Test Mode: 802.11b (DAC0)

Channel	Measurement Freq.Band (MHz)	Detector	The Max. Field Strength in Restrict Band (dBuV/m)	Limit @ 3 m (dBuV/m)	Margin (dB)
1 (lowest)	2310-2390	PK	61.58	74	-12.42
		AV	52.87	54	-1.13
11 (highest)	2483.5-2500	PK	63.62	74	-10.38
		AV	53.68	54	-0.32

Test Mode: 802.11g (DAC0)

Channel	Measurement Freq.Band (MHz)	Detector	The Max. Field Strength in Restrict Band (dBuV/m)	Limit @ 3 m (dBuV/m)	Margin (dB)
1 (lowest)	2310-2390	PK	66.72	74	-7.28
		AV	53.30	54	-0.70
11 (highest)	2483.5-2500	PK	67.81	74	-6.19
		AV	53.57	54	-0.43

Test Mode: 802.11n 20MHz (DAC0)

Channel	Measurement Freq.Band (MHz)	Detector	The Max. Field Strength in Restrict Band (dBuV/m)	Limit @ 3 m (dBuV/m)	Margin (dB)
1 (lowest)	2310-2390	PK	67.42	74	-6.58
		AV	53.55	54	-0.45
11 (highest)	2483.5-2500	PK	63.42	74	-10.58
		AV	50.69	54	-3.31

Test Mode: 802.11n 40MHz (DAC0)

Channel	Measurement Freq.Band (MHz)	Detector	The Max. Field Strength in Restrict Band (dBuV/m)	Limit @ 3 m (dBuV/m)	Margin (dB)
3 (lowest)	2310-2390	PK	65.97	74	-8.03
		AV	53.96	54	-0.04
9 (highest)	2483.5-2500	PK	60.75	74	-13.25
		AV	50.07	54	-3.93

Test Mode: 802.11b (DAC1)

Channel	Measurement Freq.Band (MHz)	Detector	The Max. Field Strength in Restrict Band (dBuV/m)	Limit @ 3 m (dBuV/m)	Margin (dB)
1 (lowest)	2310-2390	PK	62.09	74	-11.91
		AV	51.80	54	-2.20
11 (highest)	2483.5-2500	PK	61.53	74	-12.47
		AV	52.05	54	-1.95

Test Mode: 802.11g (DAC1)

Channel	Measurement Freq.Band (MHz)	Detector	The Max. Field Strength in Restrict Band (dBuV/m)	Limit @ 3 m (dBuV/m)	Margin (dB)
1 (lowest)	2310-2390	PK	64.09	74	-9.91
		AV	50.21	54	-3.79
11 (highest)	2483.5-2500	PK	63.19	74	-10.81
		AV	50.86	54	-3.14

Test Mode: 802.11n 20MHz (DAC1)

Channel	Measurement Freq.Band (MHz)	Detector	The Max. Field Strength in Restrict Band (dBuV/m)	Limit @ 3 m (dBuV/m)	Margin (dB)
1 (lowest)	2310-2390	PK	64.40	74	-9.60
		AV	50.69	54	-3.31
11 (highest)	2483.5-2500	PK	67.78	74	-6.22
		AV	49.46	54	-4.54

Test Mode: 802.11n 40MHz (DAC1)

Channel	Measurement Freq.Band (MHz)	Detector	The Max. Field Strength in Restrict Band (dBuV/m)	Limit @ 3 m (dBuV/m)	Margin (dB)
3 (lowest)	2310-2390	PK	61.18	74	-12.82
		AV	49.82	54	-4.18
9 (highest)	2483.5-2500	PK	60.26	74	-13.74
		AV	49.16	54	-4.84

Dual Tx

Test Mode: 802.11n 20MHz (DAC0&DAC1)

Channel	Measurement Freq.Band (MHz)	Detector	The Max. Field Strength in Restrict Band (dBuV/m)	Limit @ 3 m (dBuV/m)	Margin (dB)
1 (lowest)	2310-2390	PK	68.99	74	-5.01
		AV	53.58	54	-0.42
11 (highest)	2483.5-2500	PK	68.95	74	-5.05
		AV	51.04	54	-2.96

Test Mode: 802.11n 40MHz (DAC0&DAC1)

Channel	Measurement Freq.Band (MHz)	Detector	The Max. Field Strength in Restrict Band (dBuV/m)	Limit @ 3 m (dBuV/m)	Margin (dB)
3 (lowest)	2310-2390	PK	64.38	74	-9.62
		AV	52.34	54	-1.66
9 (highest)	2483.5-2500	PK	63.03	74	-10.97
		AV	51.78	54	-2.22

Single Tx

DAC0: Bandage @ 802.11b mode channel 1 (PK)

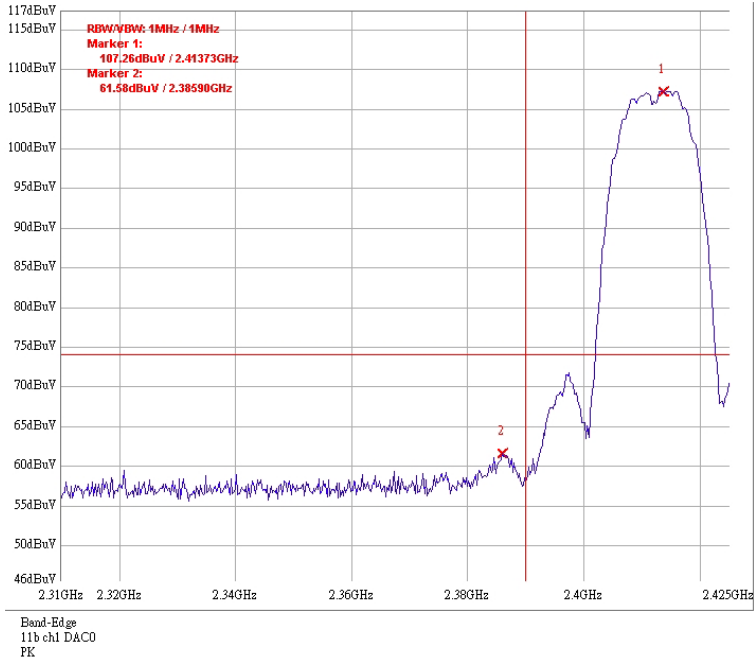

DAC0: Bandage @ 802.11b mode channel 1 (AV)

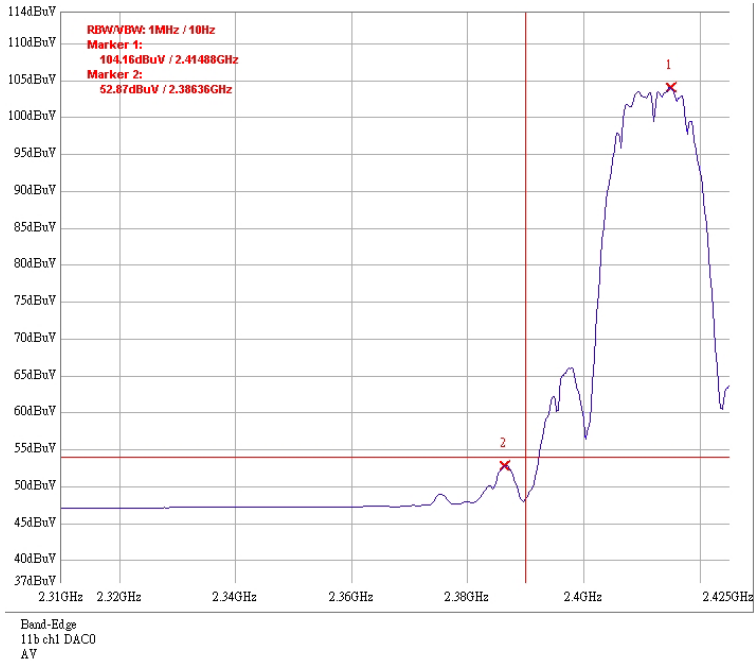

DAC0: Bandage @ 802.11b mode channel 11 (PK)

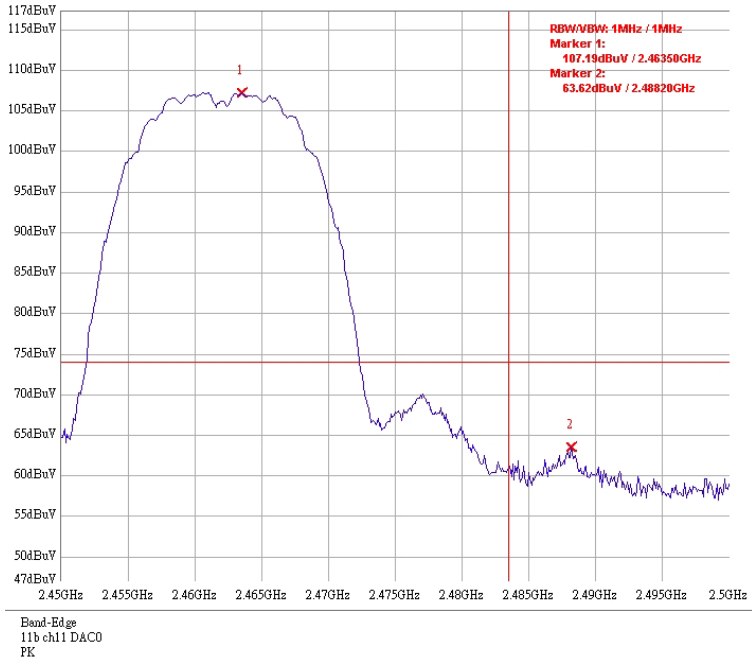

DAC0: Bandage @ 802.11b mode channel 11 (AV)

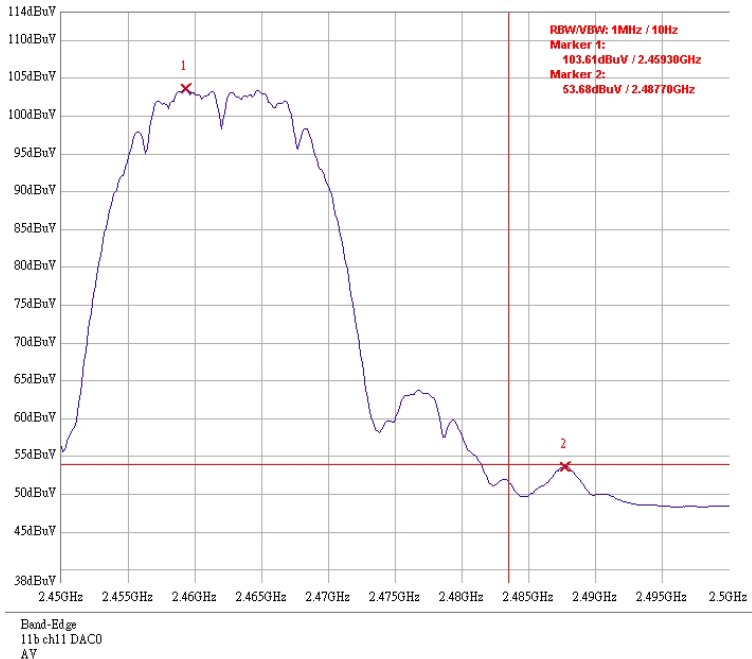

DAC0: Bandage @ 802.11g mode channel 1 (PK)

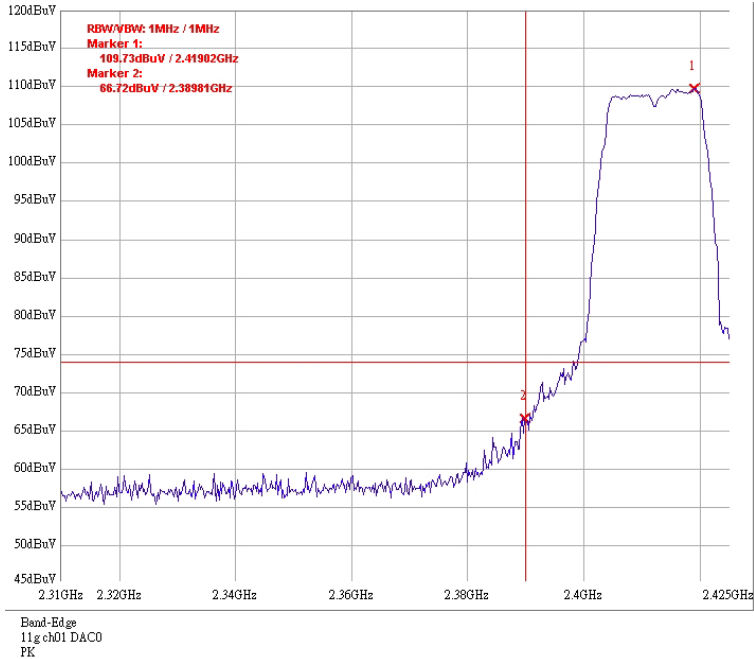

DAC0: Bandage @ 802.11g mode channel 1 (AV)

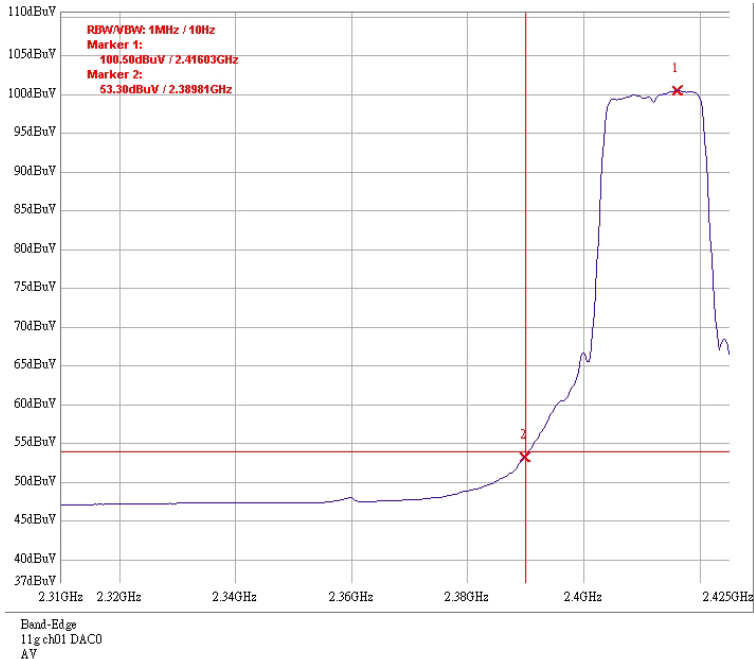

DAC0: Bandage @ 802.11g mode channel 11 (PK)

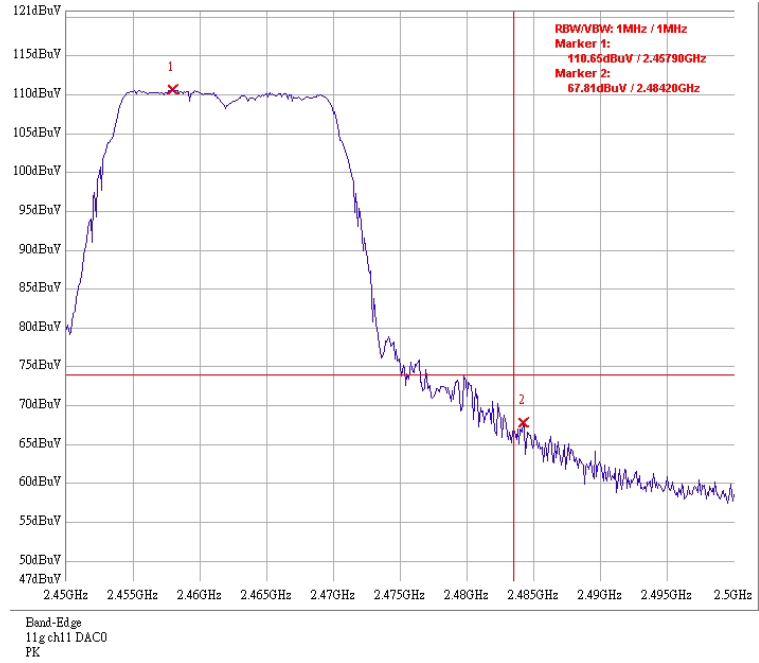

DAC0: Bandage @ 802.11g mode channel 11 (AV)

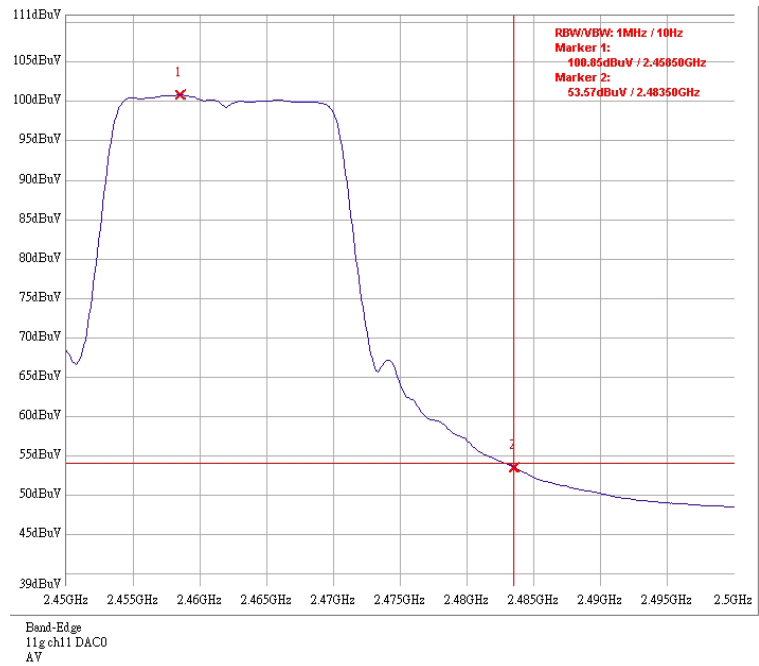

DAC0: Bandage @ Draft 802.11n 20MHz mode channel 1 (PK)

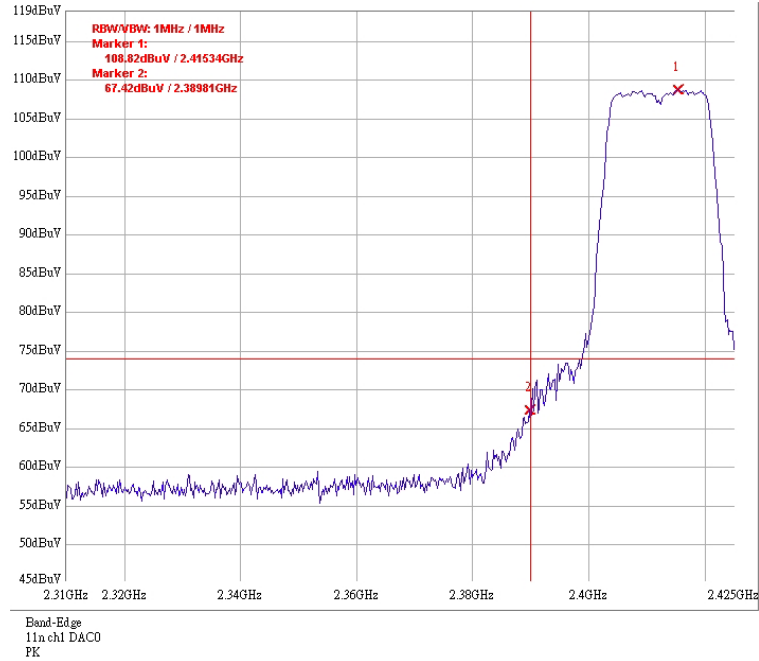

DAC0: Bandage @ Draft 802.11n 20MHz mode channel 1 (AV)

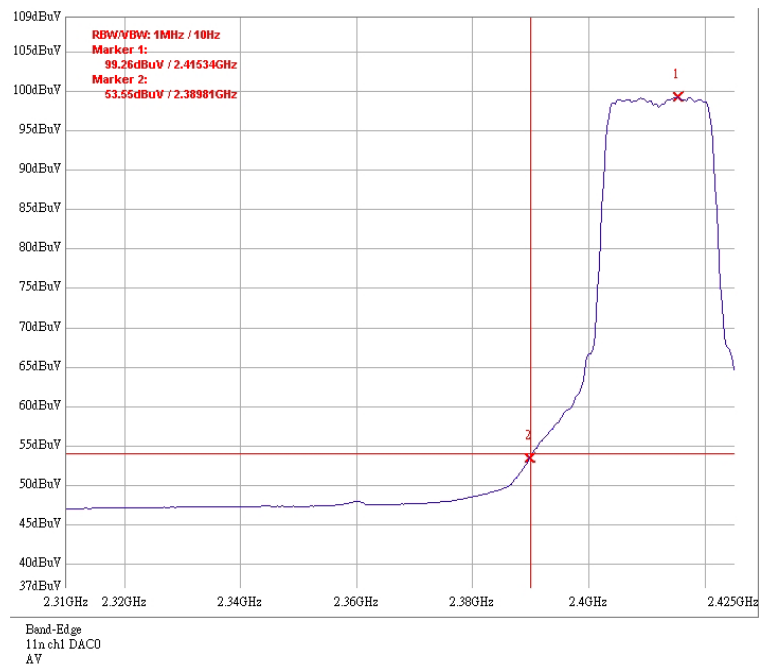

DAC0: Bandage @ Draft 802.11n 20MHz mode channel 11 (PK)

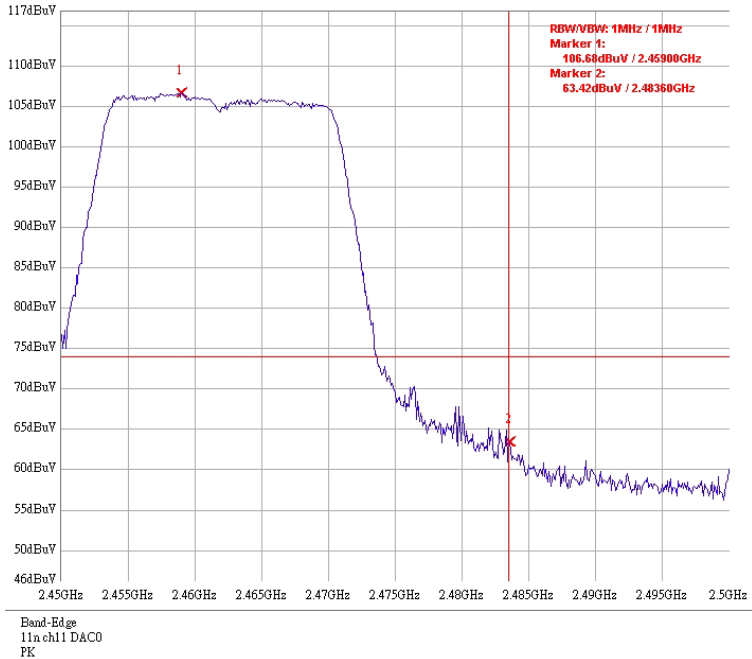

DAC0: Bandage @ Draft 802.11n 20MHz mode channel 11 (AV)

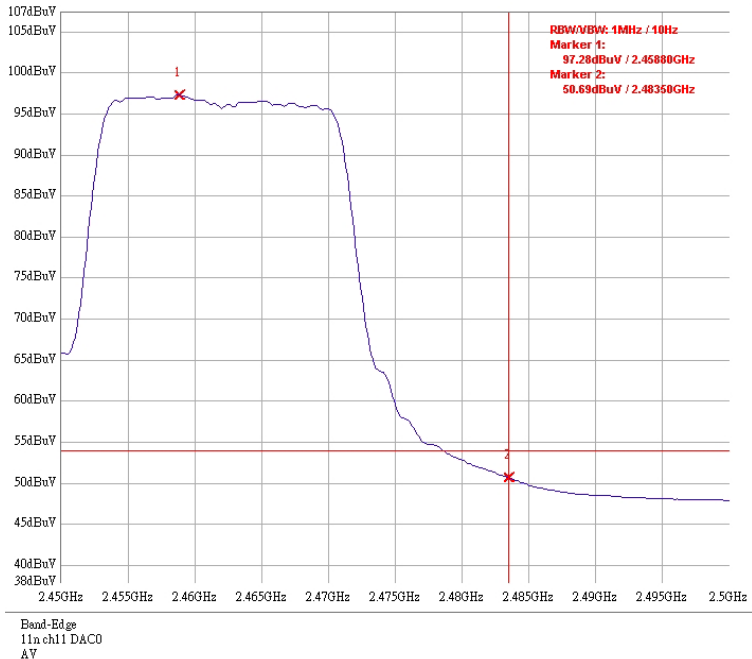

DAC0: Bandage @ Draft 802.11n 40MHz mode channel 3 (PK)

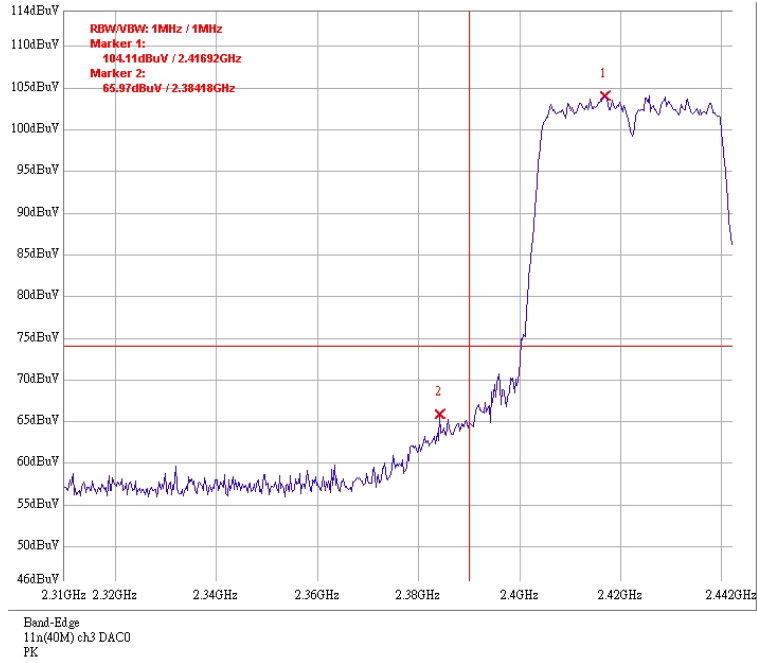

DAC0: Bandage @ Draft 802.11n 40MHz mode channel 3 (AV)

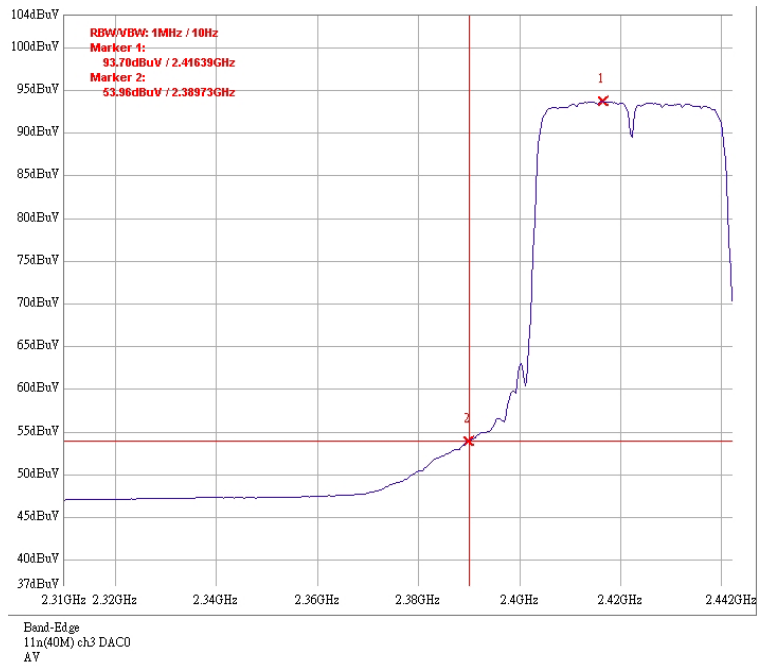

DAC0: Bandage @ Draft 802.11n 40MHz mode channel 9 (PK)

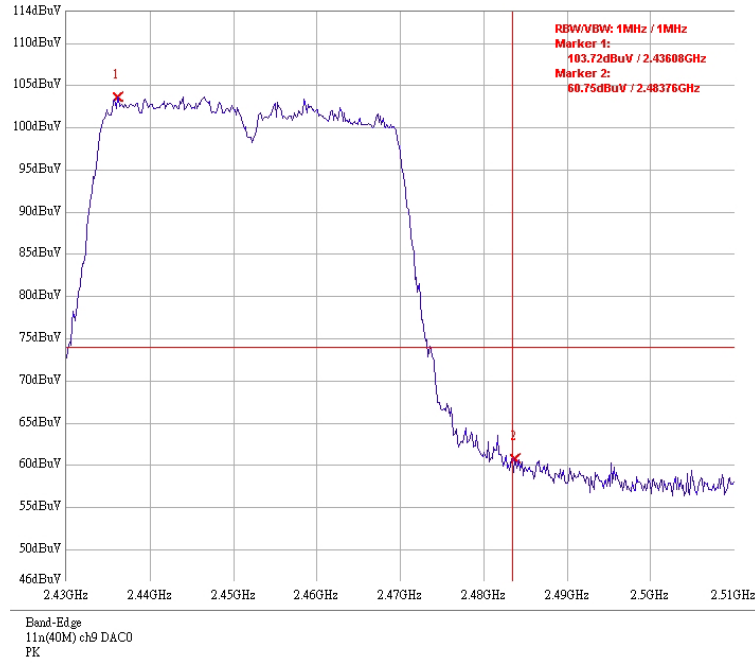

DAC0: Bandage @ Draft 802.11n 40MHz mode channel 9 (AV)

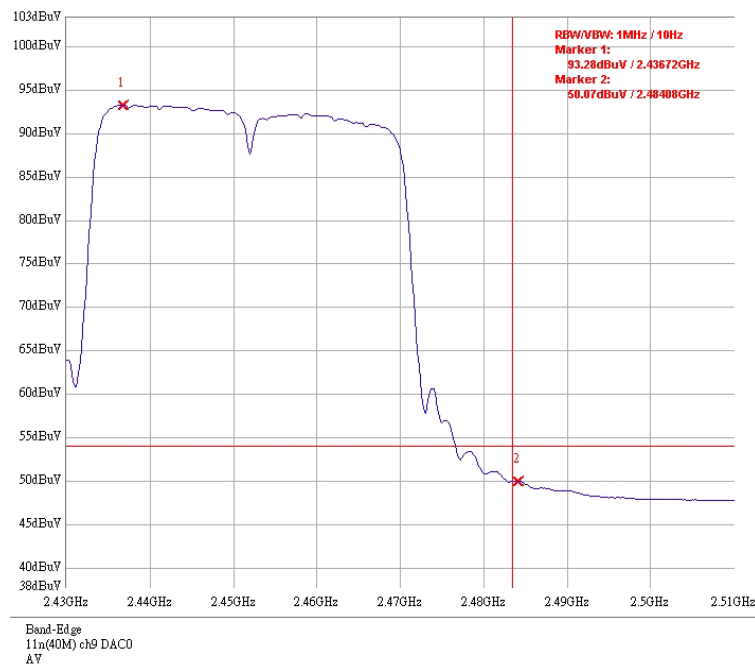

DAC1: Bandage @ 802.11b mode channel 1 (PK)

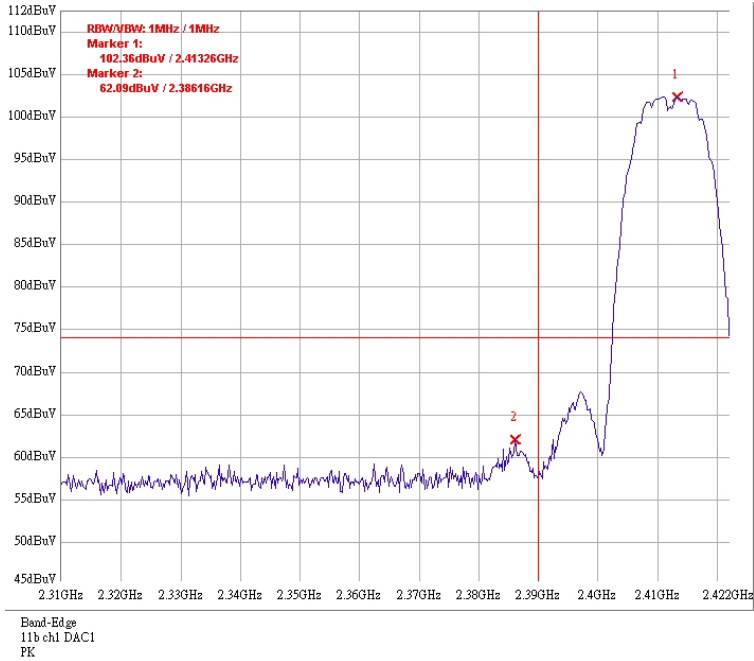

DAC1: Bandage @ 802.11b mode channel 1 (AV)

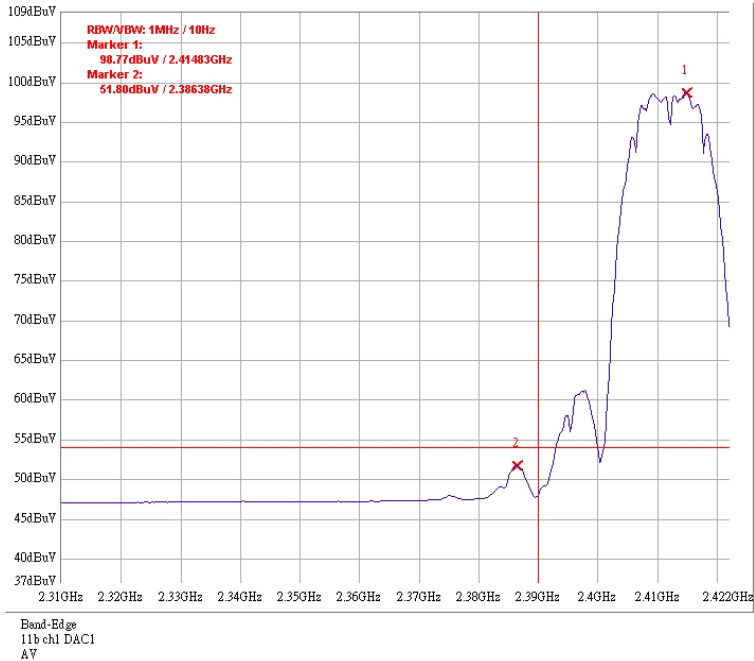

DAC1: Bandage @ 802.11b mode channel 11 (PK)

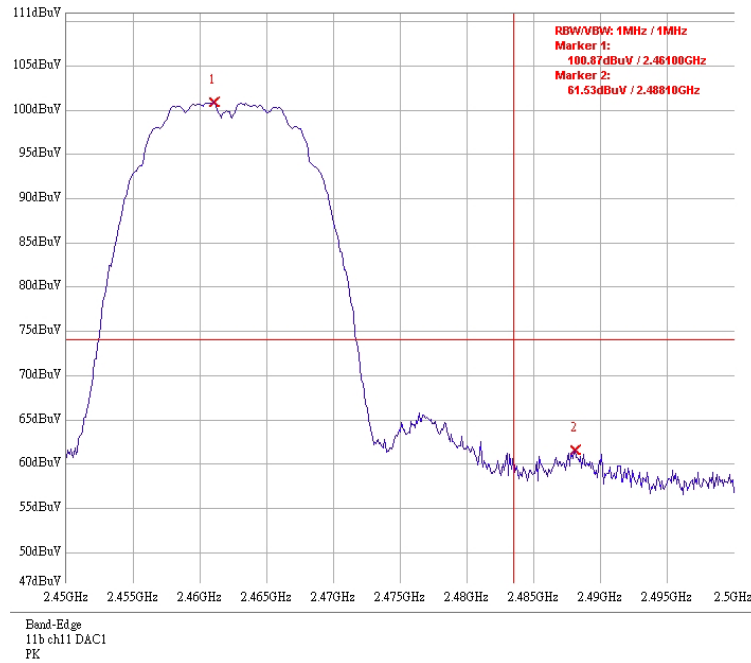

DAC1: Bandage @ 802.11b mode channel 11 (AV)

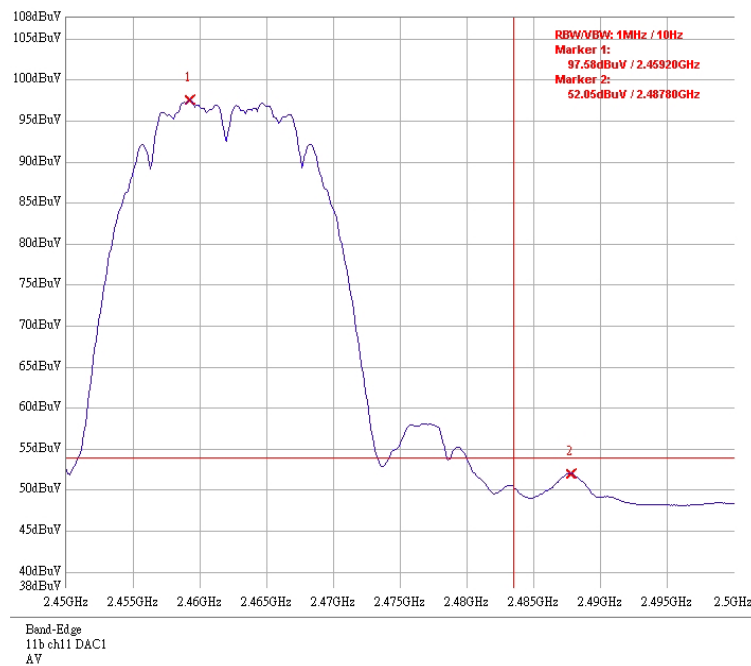

DAC1: Bandage @ 802.11g mode channel 1 (PK)

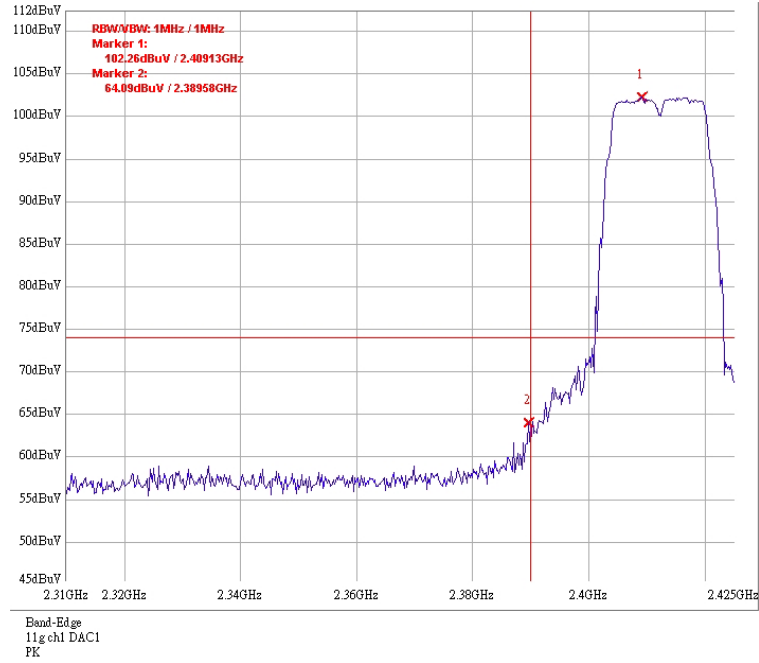

DAC1: Bandage @ 802.11g mode channel 1 (AV)

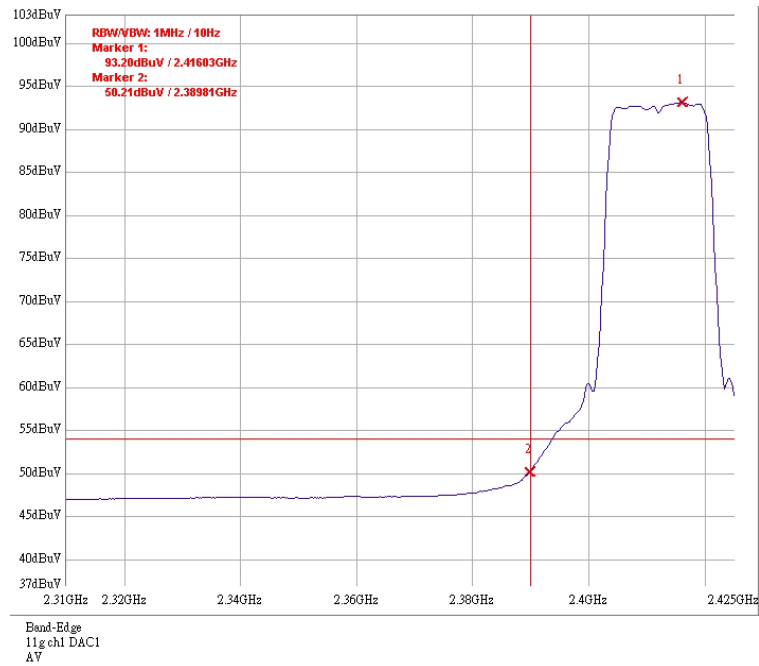

DAC1: Bandage @ 802.11g mode channel 11 (PK)

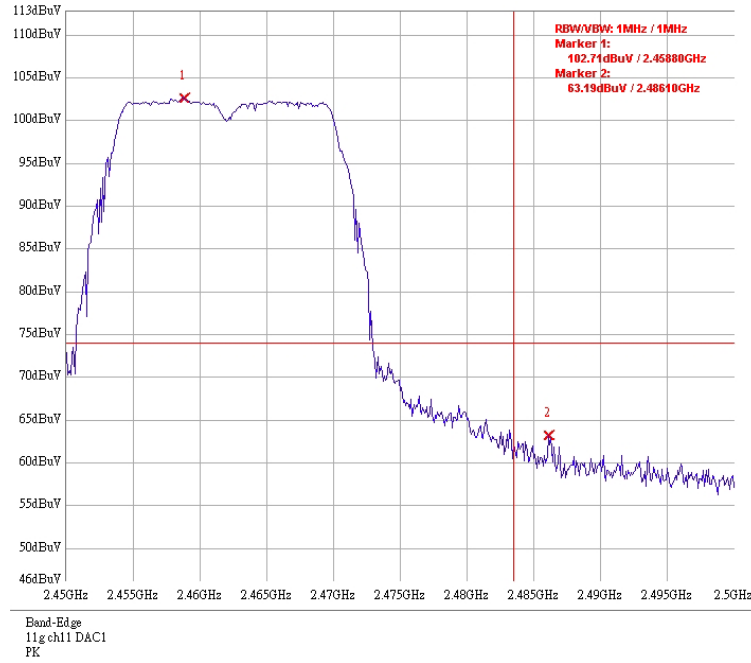

DAC1: Bandage @ 802.11g mode channel 11 (AV)

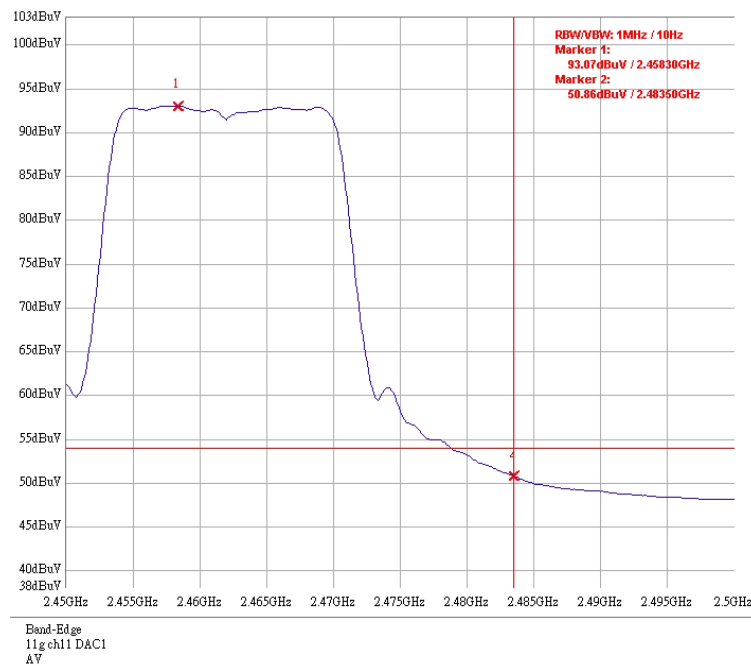

DAC1: Bandage @ Draft 802.11n 20MHz mode channel 1 (PK)

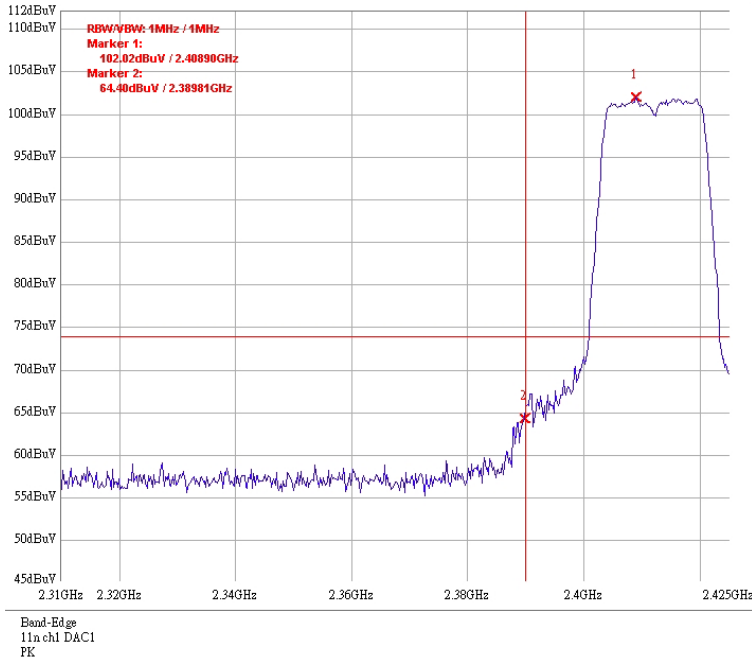

DAC1: Bandage @ Draft 802.11n 20MHz mode channel 1 (AV)

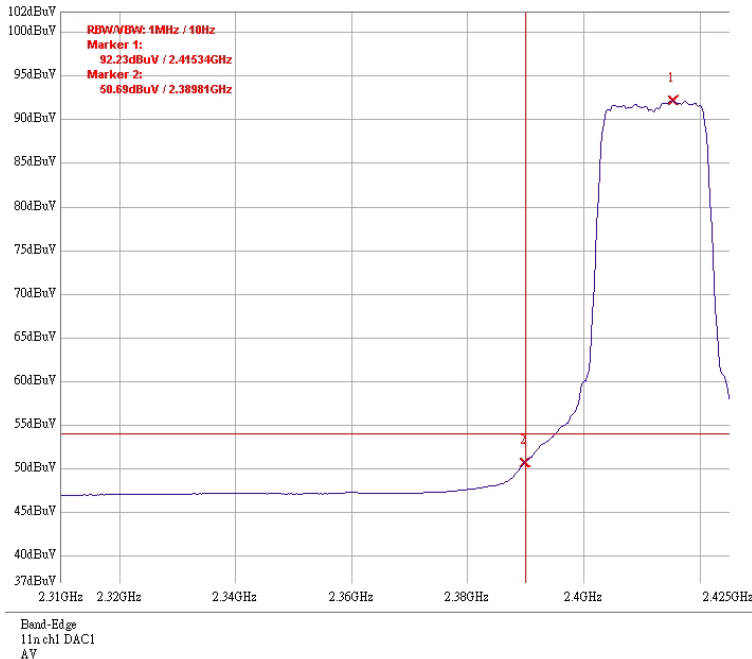

DAC1: Bandage @ Draft 802.11n 20MHz mode channel 11 (PK)

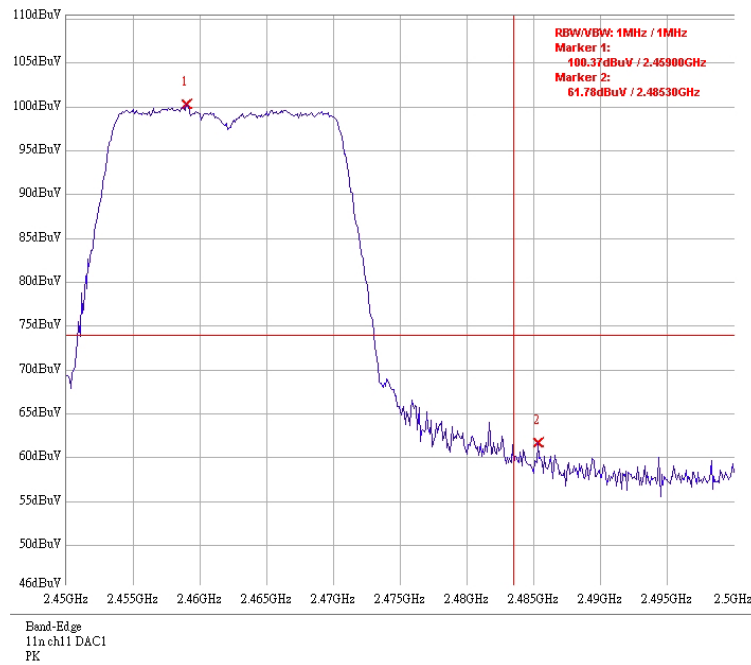

DAC1: Bandage @ Draft 802.11n 20MHz mode channel 11 (AV)

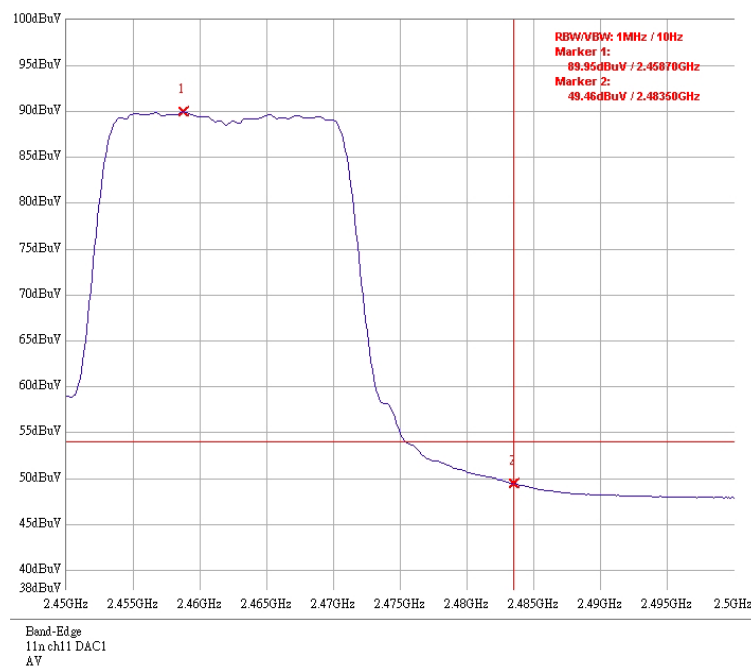

DAC1: Bandage @ Draft 802.11n 40MHz mode channel 3 (PK)

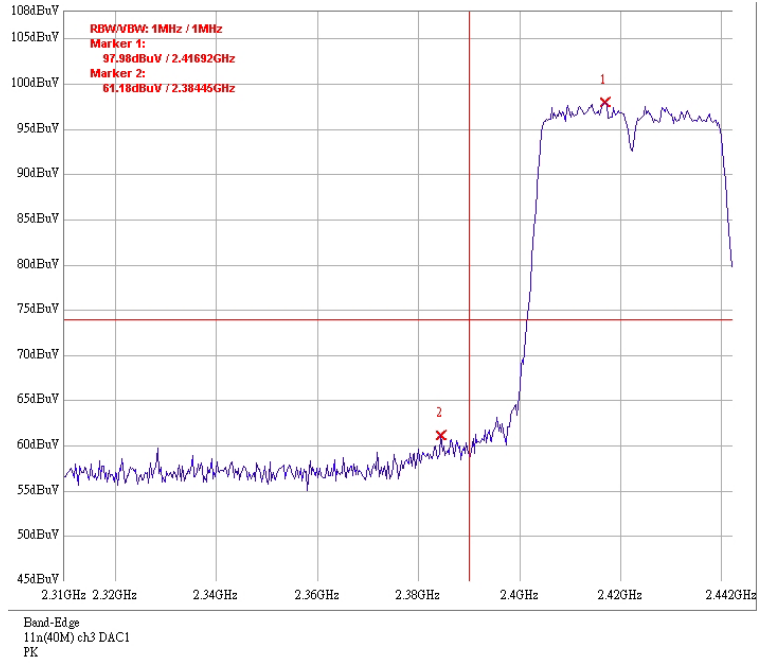

DAC1: Bandage @ Draft 802.11n 40MHz mode channel 3 (AV)

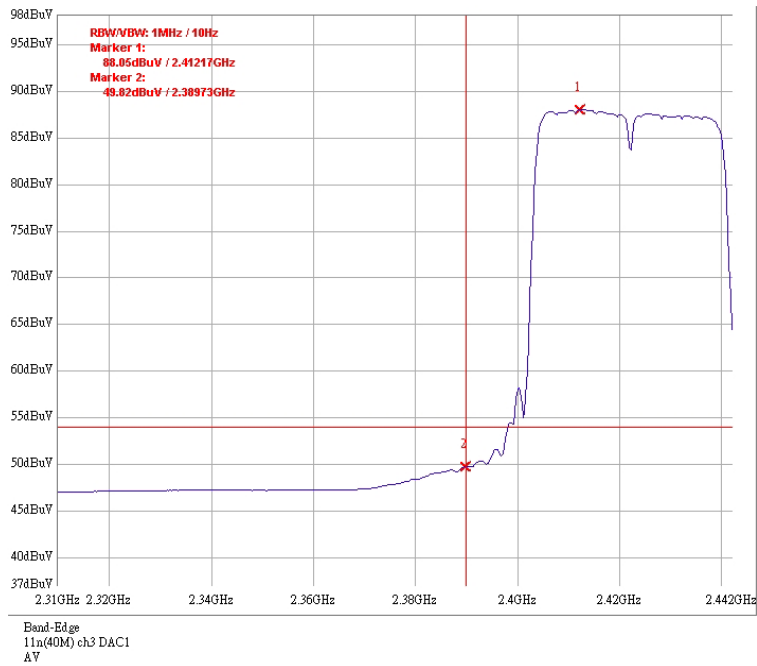

DAC1: Bandage @ Draft 802.11n 40MHz mode channel 9 (PK)

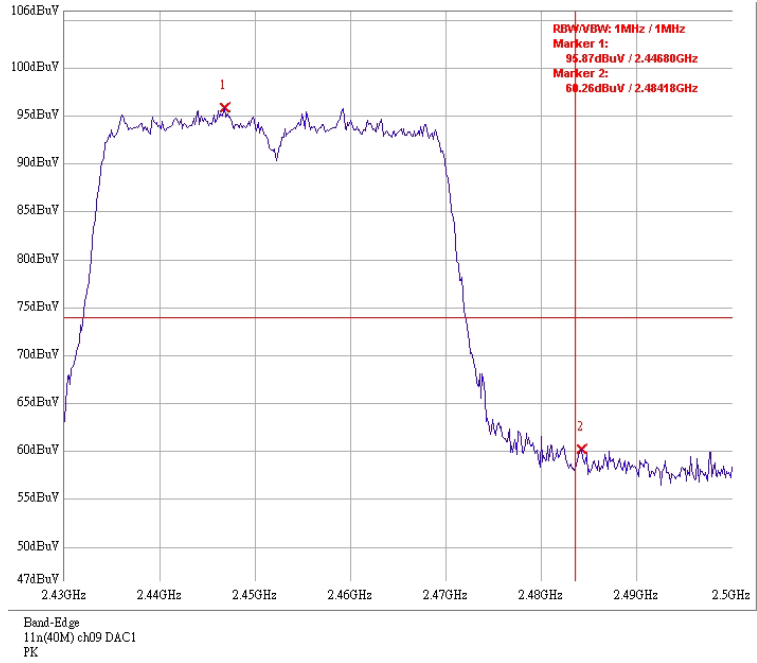

DAC1: Bandage @ Draft 802.11n 40MHz mode channel 9 (AV)

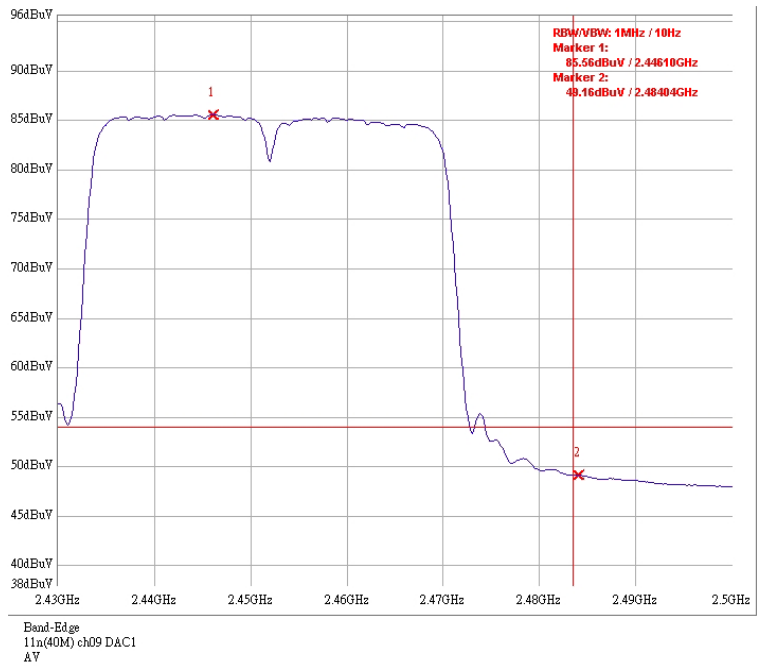

Dual Tx

DAC0 & DAC1: Bandage @ Draft 802.11n 20MHz mode channel 1 (PK)

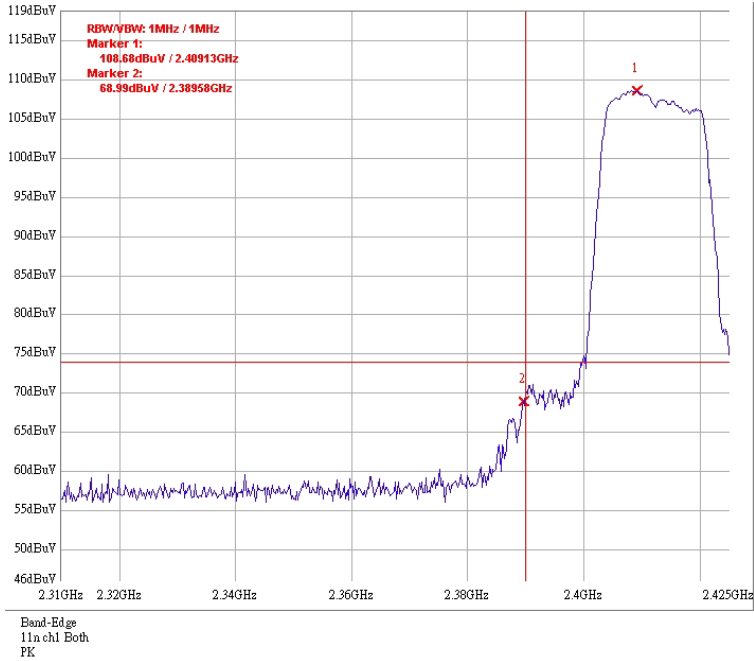

DAC0 & DAC1: Bandage @ Draft 802.11n 20MHz mode channel 1 (AV)

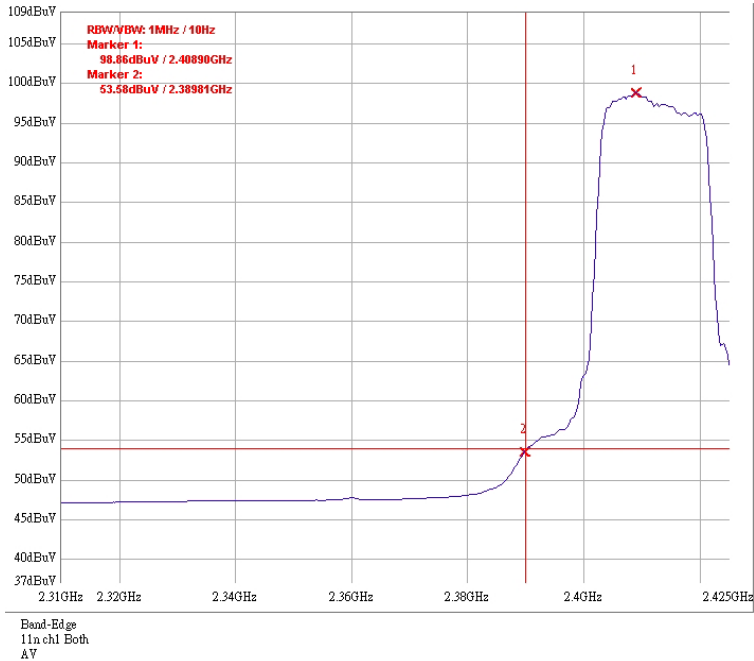

DAC0 & DAC1: Bandage @ Draft 802.11n 20MHz mode channel 11 (PK)

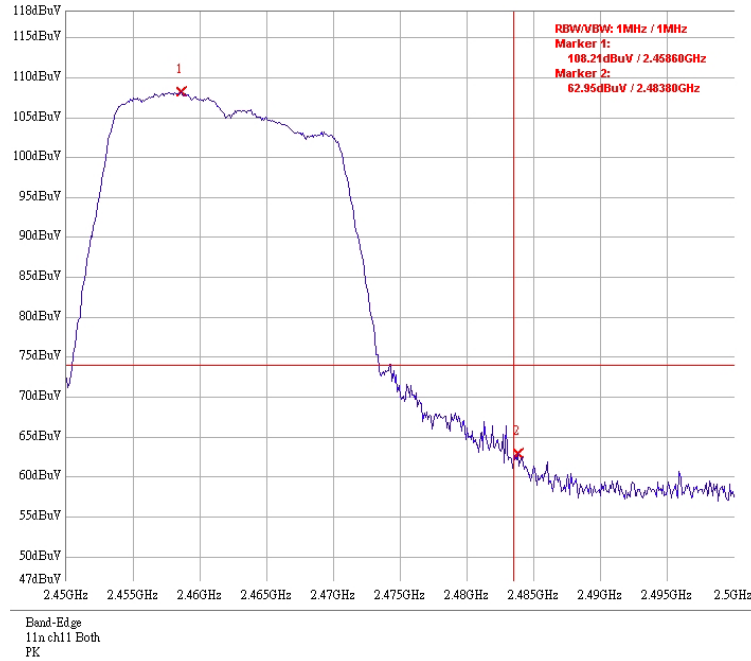

DAC0 & DAC1: Bandage @ Draft 802.11n 20MHz mode channel 11 (AV)

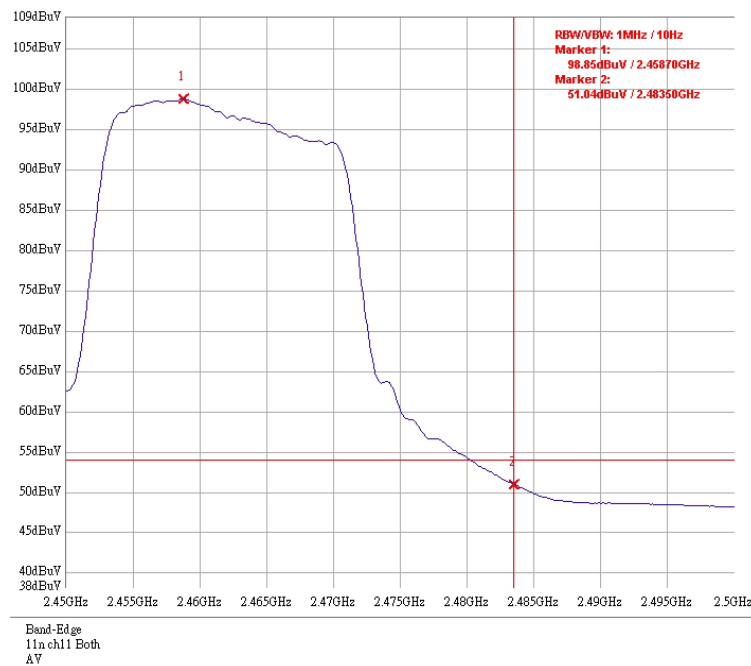

DAC0 & DAC1: Bandage @ Draft 802.11n 40MHz mode channel 3 (PK)

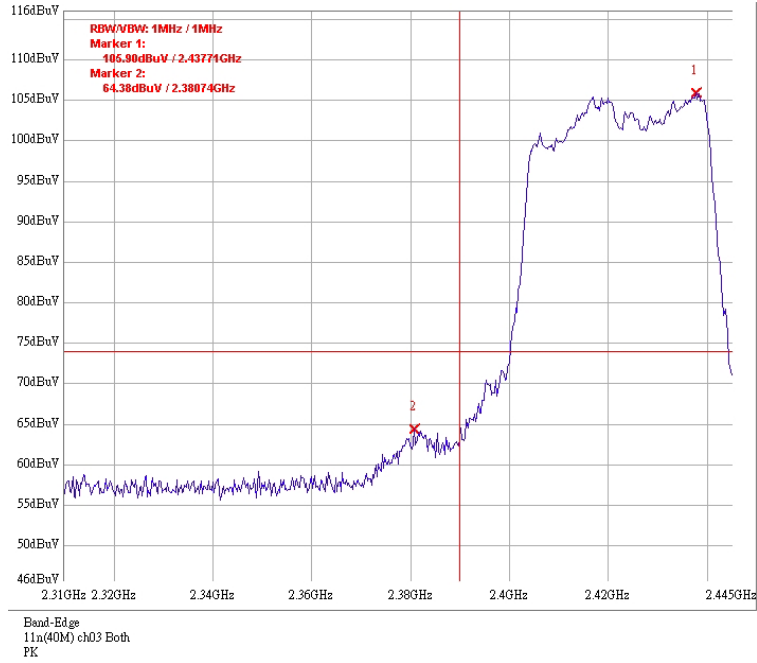

DAC0 & DAC1: Bandage @ Draft 802.11n 40MHz mode channel 3 (AV)

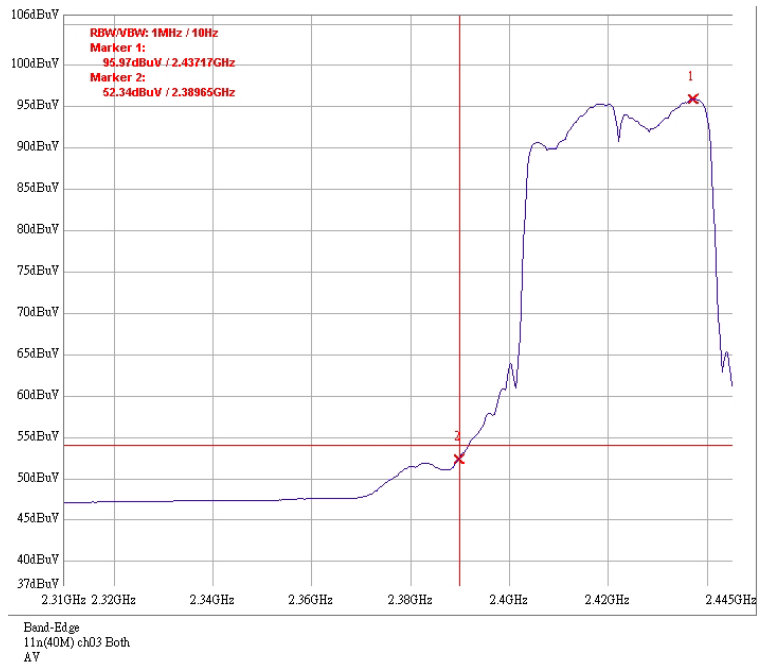

DAC0 & DAC1: Bandage @ Draft 802.11n 40MHz mode channel 9 (PK)

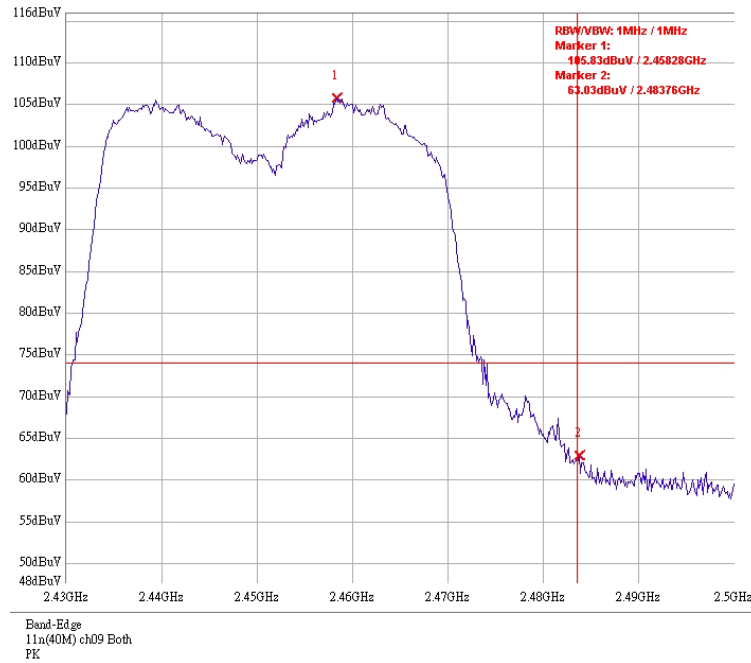

DAC0 & DAC1: Bandage @ Draft 802.11n 40MHz mode channel 9 (AV)

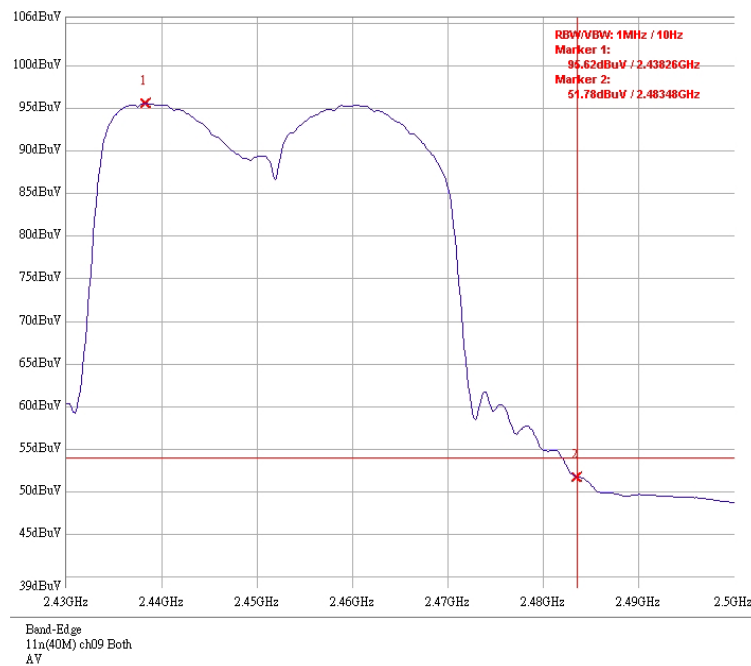

10. AC power line conducted emission

Name of Test	AC power line conducted emission
Base Standard	FCC 15.207

Tested By: Marx Yan
Test Date: Jul. 18, 2007

Test Equipment: EC365

Test Result: Complies
Test Method: See Appendix G
Measurement Data: See Tables & plots below

Note: The EUT was tested while in normal communication mode.

Phase : Line
EUT : WL-600
Worst Case : 802.11n normal operating mode

Frequency (MHz)	Corr. Factor (dB)	Level Qp (dBuV)	Limit Qp (dBuV)	Level AV (dBuV)	Limit Av (dBuV)	Margin (dB)	
						Qp	Av
0.168	0.10	48.15	65.08	38.70	55.08	-16.93	-16.38
0.222	0.10	40.79	62.76	35.03	52.76	-21.97	-17.73
0.333	0.10	37.71	59.38	32.77	49.38	-21.67	-16.61
3.148	0.19	35.20	56.00	23.27	46.00	-20.80	-22.73
3.692	0.22	38.45	56.00	24.83	46.00	-17.55	-21.17
4.062	0.24	34.24	56.00	21.82	46.00	-21.76	-24.18

Remark:

1. Correction Factor (dB)= LISN Factor (dB) + Cable Loss (dB)
2. Margin (dB) = Level (dBuV) – Limit (dBuV)

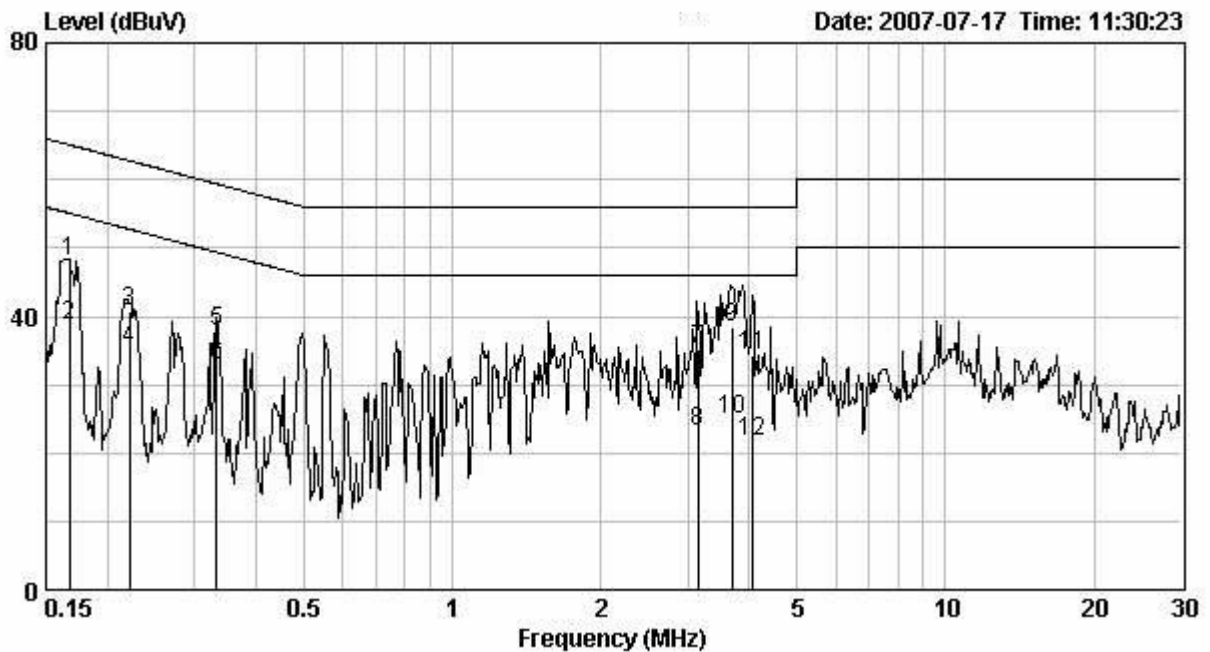

Phase : Neutral
EUT : WL-600
Worst Case : 802.11n normal operating mode

Frequency (MHz)	Corr. Factor (dB)	Level Qp (dBuV)	Limit Qp (dBuV)	Level AV (dBuV)	Limit Av (dBuV)	Margin (dB)	
						Qp	Av
0.169	0.10	49.23	65.01	37.71	55.01	-15.78	-17.30
0.225	0.10	43.76	62.62	32.16	52.62	-18.86	-20.46
0.329	0.10	37.67	59.48	30.84	49.48	-21.81	-18.64
1.574	0.11	36.49	56.00	28.17	46.00	-19.51	-17.83
3.548	0.21	41.62	56.00	26.61	46.00	-14.38	-19.39
3.662	0.22	42.01	56.00	28.18	46.00	-13.99	-17.82

Remark:

1. Correction Factor (dB)= LISN Factor (dB) + Cable Loss (dB)
2. Margin (dB) = Level (dBuV) – Limit (dBuV)

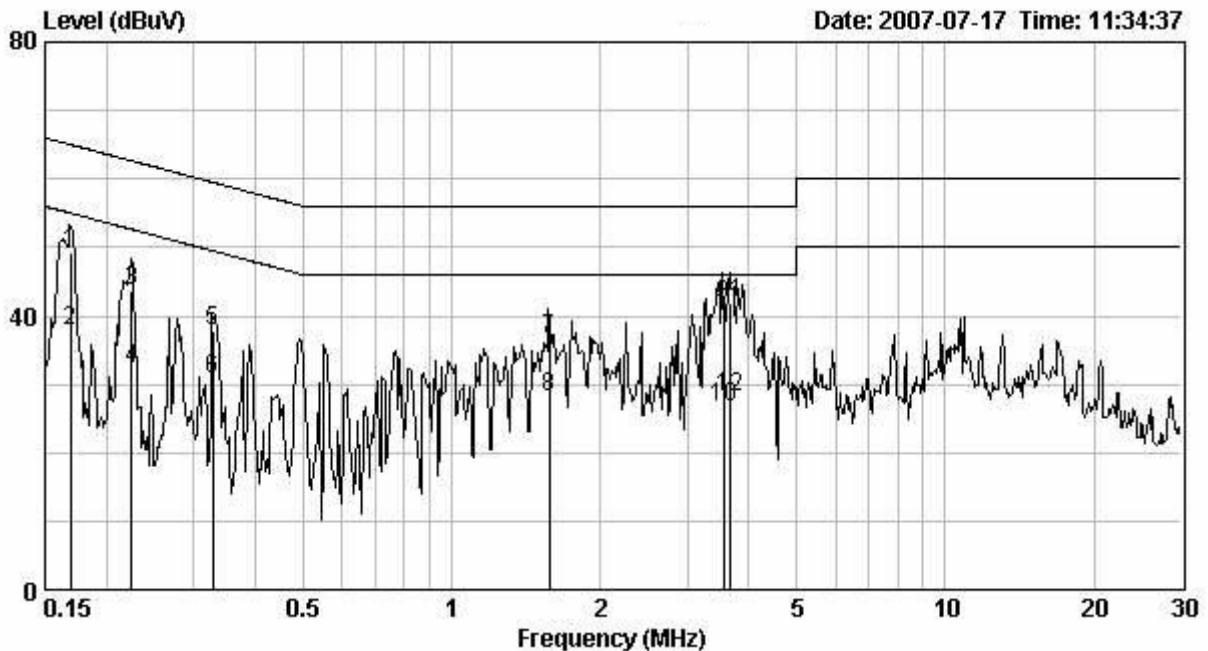

APPENDICES

Appendix A: 2.1046 - RF Power Output

A1. Method of Measurement:

The peak power at antenna terminals is measured using a Power Meter. Power output is measured with the maximum rated input level.

A2. Test Diagram:

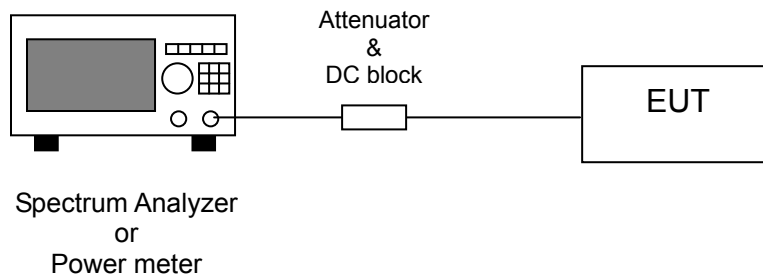

Appendix B: 2.1049 - Occupied Bandwidth**B1. Method of Measurement:**

A portion of the transmitted signal is coupled to a Spectrum Analyzer with a resolution bandwidth of at least 1% of the bandwidth of the transmitted signal. The resolution bandwidth is chosen so as not to reduce the peak level of the measured waveform. The appropriate bandwidth mask is applied to the output waveform to verify compliance.

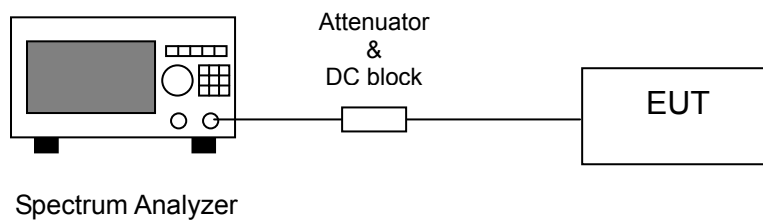
B1. Test Diagram:

Appendix C: 2.1051 - Spurious Emission at Antenna Terminal

C1. Method of Measurement:

The measurements were performed from 30MHz to 25GHz RF antenna conducted per FCC 15.247 (d) was measured from the EUT antenna port using a 50ohm spectrum analyzer with the resolution bandwidth set at 100 kHz, and the video bandwidth set at 100 kHz. Harmonics and spurious noise must be at least 20dB down from the highest emission level within the authorized band as measured with a 100 kHz RBW. The table below is the results from the highest emission for each channel within the authorized band. This table was used to determine the spurious limits for each channel.

C2. Test Diagram:

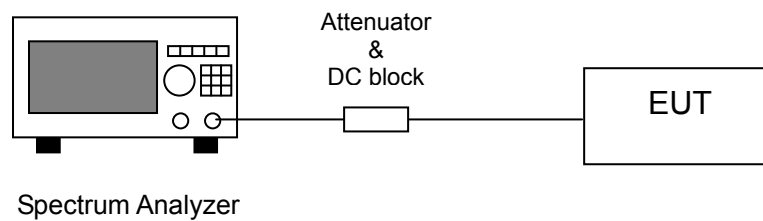

Appendix D: 2.1053 – Field Strength of Spurious Radiation

D1. Method of Measurement:

The frequency range from 30MHz to 1000MHz using Bilog Antenna.
The frequency range over 1GHz using Horn Antenna.

Radiated emissions were investigated cover the frequency range from 30MHz to 1000MHz using a receiver RBW of 120kHz record QP reading, and the frequency over 1GHz using a spectrum analyzer RBW of 1MHz and 10Hz VBW record Average reading. (15.209 paragraph), the Peak reading (1MHz RBW/VBW) recorded also on the report.

The EUT for testing is arranged on a wooden turntable. If some peripherals apply to the EUT, the peripherals will be connected to EUT and the whole system. During the test, all cables were arranged to produce worst-case emissions. The signal is maximized through rotation. The height of antenna and polarization is changing constantly for exploring for maximum signal level. The height of antenna can be up to 4 meters and down to 1 meter. The measurement for radiated emission will be done at the distance of three meters unless the signal level is too low to measure at that distance. In the case of the reading under noise floor, a pre-amplifier is used and/or the test is conducted at a closer distance. And then all readings are extrapolated back to the equivalent 3 meter reading using inverse scaling with distance.

The EUT configuration please refer to the “Spurious set-up photo.pdf”.

D2. Test Diagram:

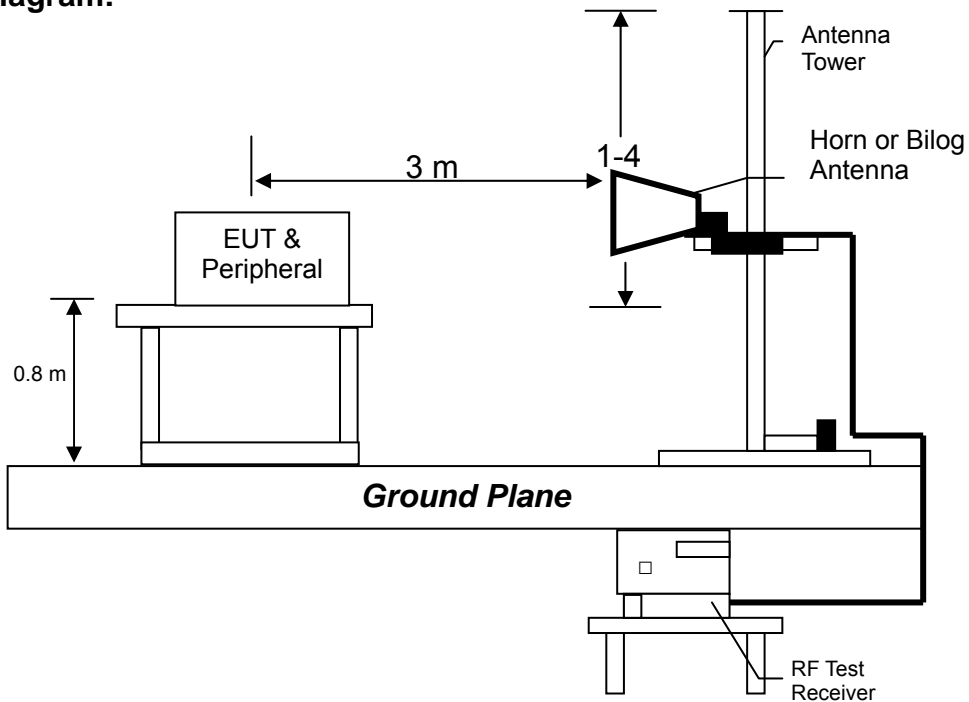

D3. Emission Limit:

The spurious Emission shall test through the 10th harmonic. In addition, radiated emissions which fall in the restricted bands, as defined in §15.205(a), must also comply with the radiated emission limits specified in §15.209(a).

Frequency (MHz)	Limits (dBµV/m@3m)
30-88	40
88-216	43.5
216-960	46
Above 960	54

Remark:

1. In the above table, the tighter limit applies at the band edges.
2. Distance refers to the distance in meters between the measuring instrument antenna and the closed point of any part of the device or system

Appendix E: 15.207 – AC power line conducted emission

E1. Method of Measurement:

The EUT are connected to the main power through a line impedance stabilization network (LISN). This provides a 50 ohm/50uH coupling impedance for the measuring equipment. The peripheral devices are also connected to the main power through a LISN that provides a 50ohm/50uH coupling impedance with 50ohm termination.

Both sides (Line and Neutral) of AC line are checked for maximum conducted interference. In order to find the maximum emission, the relative positions of equipment and all of the interface cables must be changed according to ANSI C63.4/2003 on conducted measurement.

The bandwidth of the field strength meter (R & S Test Receiver ESCS 30) is set at 9kHz.

The EUT configuration please refer to the “Conducted set-up photo.pdf”.

E2. Test Diagram:

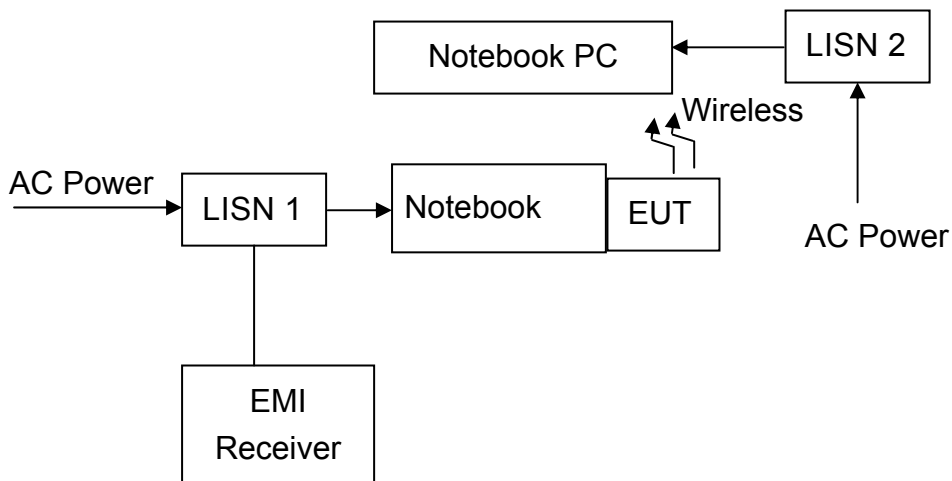

E3. Emission Limit:

Freq. (MHz)	Conducted Limit (dBuV)	
	Q.P.	Ave.
0.15~0.50	66 – 56*	56 – 46*
0.50~5.00	56	46
5.00~30.0	60	50

*Decreases with the logarithm of the frequency.

Appendix F: Test Equipment List

Intertek ID No.	Equipment	Brand	Model No.	Calculation Due
EC303	EMI Test Receiver	Rohde & Schwarz	ESCS 30	04/26/2008
EC353	Spectrum Analyzer	Rohde & Schwarz	FSP 30	08/06/2007
EC365	Spectrum Analyzer	Rohde & Schwarz	FSEK 30	11/12/2007
EC354	Signal Generator	Rohde & Schwarz	SMR27	11/14/2007
EC371	Horn Antenna	SCHWARZBECK	BBHA 9120 D	12/22/2007
EC351	Horn Antenna	SCHWARZBECK	BBHA 9170	03/04/2008
EC347	Bilog Antenna	SCHWARZBECK	VULB 9168	12/23/2007
EC373	Pre-Amplifier	MITEQ	919981	03/07/2009
EC374	Pre-Amplifier	MITEQ	828825	01/15/2008
EP346	Controller	HDGmbH	CM 100	N/A
EP347	Antenna Tower	HDGmbH	MA 2400	N/A
EC344	LISN	Rohde & Schwarz	ESH3-Z5	03/29/2008
EC396	Wideband Peak Power Meter/ Sensor	Anritsu	ML2497A/ MA2491A	11/12/2007
EC363	Temperature Humidity Test Chamber	Juror	TR-4010	09/18/2007

- Note: 1. The above equipments are within the valid calibration period.
2. The test antennas (receiving antenna) are calibration per 3 years.

Measurement Uncertainty:

Measurement uncertainty was calculated in accordance with NAMAS NIS 81.

Parameter	Uncertainty
Radiated Emission	±4.98 dB
Conducted Emission	±2.6 dB

This uncertainty represents an expanded uncertainty expressed at approximately the 95% confidence level using a coverage factor of k=2.