



FCC TEST REPORT

REPORT NO.: RF950321L10

MODEL NO.: WL-553

RECEIVED: Mar. 31, 2006

TESTED: Apr. 28 ~ May 03, 2006

ISSUED: May 19, 2006

APPLICANT: 3Com Corporation

ADDRESS: 350 Campus Drive, Marlborough, MA 01752-3064, U.S.A.

ISSUED BY : Advance Data Technology Corporation

LAB ADDRESS : No. 47, 14th Ling, Chia Pau Tsuen, Lin Kou Hsiang 244, Taipei Hsien, Taiwan, R.O.C.

TEST LOCATION : No. 19, Hwa Ya 2nd Rd., Wen Hwa Tsuen, Kwei Shan Hsiang, Taoyuan Hsien 333, Taiwan, R.O.C.

This test report consists of 76 pages in total. It may be duplicated completely for legal use with the approval of the applicant. It should not be reproduced except in full, without the written approval of our laboratory. The client should not use it to claim product endorsement by CNLA, A2LA or any government agencies. The test results in the report only apply to the tested sample.





Table of Contents

1	CERTIFICATION.....	4
2	SUMMARY OF TEST RESULTS	5
2.1	MEASUREMENT UNCERTAINTY	5
3	GENERAL INFORMATION.....	6
3.1	GENERAL DESCRIPTION OF EUT	6
3.2	DESCRIPTION OF TEST MODES.....	7
3.2.1	CONFIGURATION OF SYSTEM UNDER TEST.....	7
3.2.2	TEST MODE APPLICABILITY AND TESTED CHANNEL DETAIL	8
3.3	GENERAL DESCRIPTION OF APPLIED STANDARDS.....	10
3.4	DESCRIPTION OF SUPPORT UNITS	10
4	TEST TYPES AND RESULTS.....	11
4.1	CONDUCTED EMISSION MEASUREMENT	11
4.1.1	LIMITS OF CONDUCTED EMISSION MEASUREMENT	11
4.1.2	TEST INSTRUMENTS	11
4.1.3	TEST PROCEDURES	12
4.1.4	DEVIATION FROM TEST STANDARD	12
4.1.5	TEST SETUP	13
4.1.6	EUT OPERATING CONDITIONS	13
4.1.7	TEST RESULTS.....	14
4.2	RADIATED EMISSION MEASUREMENT	22
4.2.1	LIMITS OF RADIATED EMISSION MEASUREMENT	22
4.2.2	TEST INSTRUMENTS	23
4.2.3	TEST PROCEDURES	24
4.2.4	DEVIATION FROM TEST STANDARD	24
4.2.5	TEST SETUP	25
4.2.6	EUT OPERATING CONDITIONS	25
4.2.7	TEST RESULTS.....	26
4.3	6dB BANDWIDTH MEASUREMENT	35
4.3.1	LIMITS OF 6dB BANDWIDTH MEASUREMENT	35
4.3.2	TEST INSTRUMENTS	35
4.3.3	TEST PROCEDURE	36
4.3.4	DEVIATION FROM TEST STANDARD	36
4.3.5	TEST SETUP	36
4.3.6	EUT OPERATING CONDITIONS	36
4.3.7	TEST RESULTS.....	37
4.4	MAXIMUM PEAK OUTPUT POWER	45
4.4.1	LIMITS OF MAXIMUM PEAK OUTPUT POWER MEASUREMENT	45
4.4.2	TEST INSTRUMENTS	45
4.4.3	TEST PROCEDURES	46
4.4.4	DEVIATION FROM TEST STANDARD	46
4.4.5	TEST SETUP	46
4.4.6	EUT OPERATING CONDITIONS	46



4.4.7	TEST RESULTS.....	47
4.5	POWER SPECTRAL DENSITY MEASUREMENT	49
4.5.1	LIMITS OF POWER SPECTRAL DENSITY MEASUREMENT.....	49
4.5.2	TEST INSTRUMENTS.....	49
4.5.3	TEST PROCEDURE.....	50
4.5.4	DEVIATION FROM TEST STANDARD	50
4.5.5	TEST SETUP	50
4.5.6	EUT OPERATING CONDITIONS	50
4.5.7	TEST RESULTS.....	51
4.6	BAND EDGES MEASUREMENT.....	59
4.6.1	LIMITS OF BAND EDGES MEASUREMENT.....	59
4.6.2	TEST INSTRUMENTS.....	59
4.6.3	TEST PROCEDURE.....	59
4.6.4	DEVIATION FROM TEST STANDARD	59
4.6.5	EUT OPERATING CONDITION.....	59
4.6.6	TEST RESULTS.....	60
4.7	ANTENNA REQUIREMENT	72
4.7.1	STANDARD APPLICABLE.....	72
4.7.2	ANTENNA CONNECTED CONSTRUCTION.....	72
5	PHOTOGRAPHS OF THE TEST CONFIGURATION.....	73
6	INFORMATION ON THE TESTING LABORATORIES.....	75
	APPENDIX-A.....	A-1



1 CERTIFICATION

PRODUCT : OfficeConnect ADSL Wireless 108Mbps 11g Firewall Router
MODEL NO.: WL-553
BRAND: 3Com
APPLICANT : 3Com Corporation
TESTED: Apr. 28 ~ May 03, 2006
TEST SAMPLE: ENGINEERING SAMPLE
STANDARDS : FCC Part 15, Subpart C (Section 15.247),
ANSI C63.4-2003

The above equipment have been tested by **Advance Data Technology Corporation**, and found compliance with the requirement of the above standards. The test record, data evaluation & Equipment Under Test (EUT) configurations represented herein are true and accurate accounts of the measurements of the sample's EMC characteristics under the conditions specified in this report.

PREPARED BY : Andrea Hsia , **DATE:** May 19, 2006
Andrea Hsia

TECHNICAL ACCEPTANCE : Long Chen , **DATE:** May 19, 2006
Responsible for RF Long Chen

APPROVED BY : Gary Chang , **DATE:** May 19, 2006
Gary Chang / Supervisor

2 SUMMARY OF TEST RESULTS

The EUT has been tested according to the following specifications:

APPLIED STANDARD: FCC Part 15, Subpart C			
Standard Section	Test Type and Limit	Result	REMARK
15.207	AC Power Conducted Emission	PASS	Meet the requirement of limit. Minimum passing margin is -16.58dB at 0.197MHz.
15.247(a)(2)	Spectrum Bandwidth of a Direct Sequence Spread Spectrum System Limit : min. 500kHz	PASS	Meet the requirement of limit.
15.247(b)	Maximum Peak Output Power Limit: max. 30dBm	PASS	Meet the requirement of limit.
15.247(d)	Transmitter Radiated Emissions Limit: Table 15.209	PASS	Meet the requirement of limit. Minimum passing margin is -1.76dB at 2386.00MHz.
15.247(e)	Power Spectral Density Limit: max. 8dBm	PASS	Meet the requirement of limit.
15.247(d)	Band Edge Measurement Limit: 20 dB less than the peak value of fundamental frequency	PASS	Meet the requirement of limit.

2.1 MEASUREMENT UNCERTAINTY

Where relevant, the following measurement uncertainty levels have been estimated for tests performed on the EUT as specified in CISPR 16-4:

Measurement	Frequency	Uncertainty
Conducted emissions	9kHz~30MHz	2.44 dB
Radiated emissions	30MHz ~ 200MHz (Horizontal)	3.47 dB
	30MHz ~ 200MHz (Vertical)	3.64 dB
	200MHz ~1000MHz (Horizontal)	3.65 dB
	200MHz ~1000MHz (Vertical)	3.64 dB
	1GHz ~ 18GHz	2.26 dB
	18GHz ~ 40GHz	1.94 dB

This uncertainty represents an expanded uncertainty expressed at approximately the 95% confidence level using a coverage factor of k=2.



3 GENERAL INFORMATION

3.1 GENERAL DESCRIPTION OF EUT

PRODUCT	OfficeConnect ADSL Wireless 108Mbps 11g Firewall Router
MODEL NO.	WL-553
FCC ID	O9C-WL553
POWER SUPPLY	15Vdc from AC adapter
MODULATION TYPE	CCK, DQPSK, DBPSK for DSSS 64QAM, 16QAM, QPSK, BPSK for OFDM
MODULATION TECHNOLOGY	DSSS, OFDM
TRANSFER RATE	802.11b: 11/5.5/2/1Mbps 802.11g: 54/48/36/24/18/12/9/6Mbps (up to 108Mbps for turbo mode)
FREQUENCY RANGE	2412MHz ~ 2462MHz
NUMBER OF CHANNEL	11 for Normal mode / 1 for Turbo mode
MAXIMUM OUTPUT POWER	80.168mW
ANTENNA TYPE	Dipole antenna with 2.71 dBi gain Dipole antenna with 2.37 dBi gain
DATA CABLE	NA
I/O PORTS	RJ45
ASSOCIATED DEVICES	NA

NOTE:

1. The EUT was powered by the following adapter:

Brand:	3Com
Model:	DVS-150A10FUS
Input:	100-240Vac, 50/60Hz 0.7A
Output:	15Vdc, 1 A
Power Line:	DC 1.8m non-shielded cable without core

2. The EUT complies with IEEE 802.11g standards and backwards compatible with IEEE 802.11b products.
3. The EUT operates in the 2.4GHz frequency spectrum with throughput of up to 108Mbps.
4. There are two antennas for EUT. After pre-testing each antenna, the one with highest gain was chosen for the final test and recorded in the report.
5. The above EUT information was declared by manufacturer and for more detailed features description, please refer to the manufacturer's specifications or User's Manual.

3.2 DESCRIPTION OF TEST MODES

Eleven channels are provided to this EUT.

CHANNEL	FREQUENCY	CHANNEL	FREQUENCY
1	2412 MHz	7	2442 MHz
2	2417 MHz	8	2447 MHz
3	2422 MHz	9	2452 MHz
4	2427 MHz	10	2457 MHz
5	2432 MHz	11	2462 MHz
6	2437 MHz		

For 802.11g: One channel is provided to this EUT for turbo mode.

CHANNEL	FREQUENCY
6	2437 MHz

3.2.1 CONFIGURATION OF SYSTEM UNDER TEST

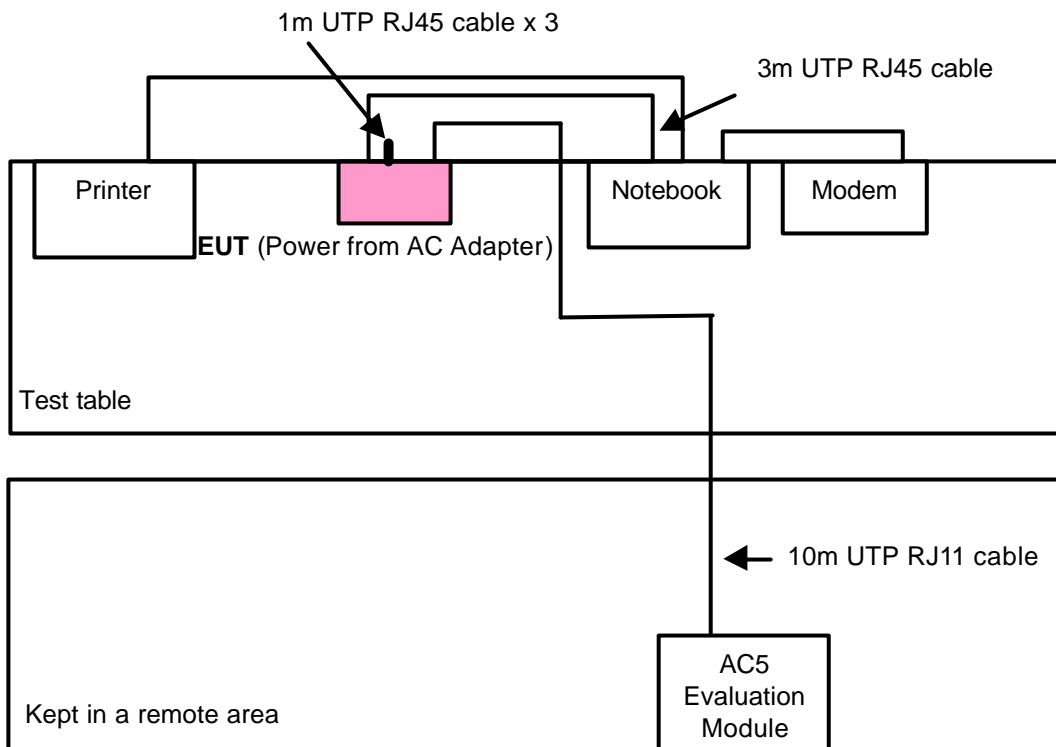

3.2.2 TEST MODE APPLICABILITY AND TESTED CHANNEL DETAIL

EUT configure mode	Applicable to				Description
	PLC	RE<1G	RE ³ 1G	APCM	
-	V	V	V	V	-

Where **PLC**: Power Line Conducted Emission **RE<1G**: Radiated Emission below 1GHz
RE³1G: Radiated Emission above 1GHz **APCM**: Antenna Port Conducted Measurement

Power Line Conducted Emission Test:

- ? Pre-Scan has been conducted to determine the worst-case mode from all possible combinations between available modulations, data rates and antenna ports (if EUT with antenna diversity architecture).
- Following channel(s) was (were) selected for the final test as listed below.

MODE	AVAILABLE CHANNEL	TESTED CHANNEL	MODULATION TECHNOLOGY	MODULATION TYPE	DATA RATE (Mbps)
802.11g	1 to 11	1, 6, 11	OFDM	BPSK	6
802.11g Turbo	6	6	OFDM	QPSK	12

Radiated Emission Test (Below 1 GHz):

- ? Pre-Scan has been conducted to determine the worst-case mode from all possible combinations between available modulations, data rates and antenna ports (if EUT with antenna diversity architecture).
- Following channel(s) was (were) selected for the final test as listed below.

MODE	AVAILABLE CHANNEL	TESTED CHANNEL	MODULATION TECHNOLOGY	MODULATION TYPE	DATA RATE (Mbps)
802.11g	1 to 11	11	OFDM	BPSK	6
802.11g Turbo	6	6	OFDM	QPSK	12

Radiated Emission Test (Above 1 GHz):

- ? Pre-Scan has been conducted to determine the worst-case mode from all possible combinations between available modulations, data rates and antenna ports (if EUT with antenna diversity architecture).
- Following channel(s) was (were) selected for the final test as listed below.

MODE	AVAILABLE CHANNEL	TESTED CHANNEL	MODULATION TECHNOLOGY	MODULATION TYPE	DATA RATE (Mbps)
802.11b	1 to 11	1, 6, 11	DSSS	DBPSK	1
802.11g	1 to 11	1, 6, 11	OFDM	BPSK	6
802.11g Turbo	6	6	OFDM	QPSK	12



Bandedge Measurement:

- ? Pre-Scan has been conducted to determine the worst-case mode from all possible combinations between available modulations, data rates and antenna ports (if EUT with antenna diversity architecture).
- Following channel(s) was (were) selected for the final test as listed below.

MODE	AVAILABLE CHANNEL	TESTED CHANNEL	MODULATION TECHNOLOGY	MODULATION TYPE	DATA RATE (Mbps)
802.11b	1 to 11	1, 11	DSSS	DBPSK	1
802.11g	1 to 11	1, 11	OFDM	BPSK	6
802.11g Turbo	6	6	OFDM	QPSK	12

Antenna Port Conducted Measurement:

- ? Pre-Scan has been conducted to determine the worst-case mode from all possible combinations between available modulations, data rates and antenna ports (if EUT with antenna diversity architecture).
- Following channel(s) was (were) selected for the final test as listed below.

MODE	AVAILABLE CHANNEL	TESTED CHANNEL	MODULATION TECHNOLOGY	MODULATION TYPE	DATA RATE (Mbps)
802.11b	1 to 11	1, 6, 11	DSSS	DBPSK	1
802.11g	1 to 11	1, 6, 11	OFDM	BPSK	6
802.11g Turbo	6	6	OFDM	QPSK	12



3.3 GENERAL DESCRIPTION OF APPLIED STANDARDS

The EUT is a RF product, according to the specifications of the manufacturer, it must comply with the requirements of the following standards:

FCC Part 15, Subpart C. (15.247)
ANSI C63.4-2003

All test items have been performed and recorded as per the above standards.

NOTE: The EUT is also considered as a kind of computer peripheral, because the connection to computer is necessary for typical use. It has been verified to comply with the requirements of FCC Part 15, Subpart B, Class B (DoC). The test report has been issued separately.

3.4 DESCRIPTION OF SUPPORT UNITS

The EUT has been tested as an independent unit together with other necessary accessories or support units. The following support units or accessories were used to form a representative test configuration during the tests.

NO.	PRODUCT	BRAND	MODEL NO.	SERIAL NO.	FCC ID
1	NOTEBOOK COMPUTER	DELL	PP05L	16484462992	E2K24CLNS
2	PRINTER	EPSON	LQ-300+	DCGY054147	FCC DoC Approved
3	MODEM	ACEEX	1414V/3	0401008269	IFAXDM1414
4	AC5 EVALUATION MODULE	TEXAS INSTRUMENTS	AC5-ANNCXA	NA	NA

NO.	SIGNAL CABLE DESCRIPTION OF THE ABOVE SUPPORT UNITS
1	NA
2	1.2m shielded cable without core.
3	1.2m shielded cable without core.
4	NA

NOTE: 1. All power cords of the above support units are non shielded (1.8m).
2. Item 4 acted as communication partners to transfer data.

4 TEST TYPES AND RESULTS

4.1 CONDUCTED EMISSION MEASUREMENT

4.1.1 LIMITS OF CONDUCTED EMISSION MEASUREMENT

FREQUENCY OF EMISSION (MHz)	CONDUCTED LIMIT (dB μ V)	
	Quasi-peak	Average
0.15-0.5	66 to 56	56 to 46
0.5-5	56	46
5-30	60	50

- NOTE:**
1. The lower limit shall apply at the transition frequencies.
 2. The limit decreases in line with the logarithm of the frequency in the range of 0.15 to 0.50 MHz.
 3. All emanations from a class A/B digital device or system, including any network of conductors and apparatus connected thereto, shall not exceed the level of field strengths specified above.

4.1.2 TEST INSTRUMENTS

DESCRIPTION & MANUFACTURER	MODEL NO.	SERIAL NO.	CALIBRATED UNTIL
Test Receiver ROHDE & SCHWARZ	ESCS30	100288	Nov. 02, 2006
RF signal cable Woken	5D-FB	Cable-HYCO3-01	Jan. 06, 2007
LISN ROHDE & SCHWARZ	ESH2-Z5	100100	Jan. 09, 2007
LISN ROHDE & SCHWARZ	ESH3-Z5	100311	Jan. 22, 2007
Software ADT	ADT_Cond_V3	NA	NA

- NOTE:**
1. The calibration interval of the above test instruments is 12 months and the calibrations are traceable to NML/ROC and NIST/USA.
 2. The test was performed in HwaYa Shielded Room 3.
 3. The VCCI Site Registration No. is C-2047.



4.1.3 TEST PROCEDURES

- a. The EUT was placed 0.4 meters from the conducting wall of the shielded room with EUT being connected to the power mains through a line impedance stabilization network (LISN). Other support units were connected to the power mains through another LISN. The two LISNs provide 50 ohm/ 50uH of coupling impedance for the measuring instrument.
- b. Both lines of the power mains connected to the EUT were checked for maximum conducted interference.
- c. The frequency range from 150kHz to 30MHz was searched. Emission levels under Limit - 20dB was not recorded.

4.1.4 DEVIATION FROM TEST STANDARD

No deviation

4.1.5 TEST SETUP

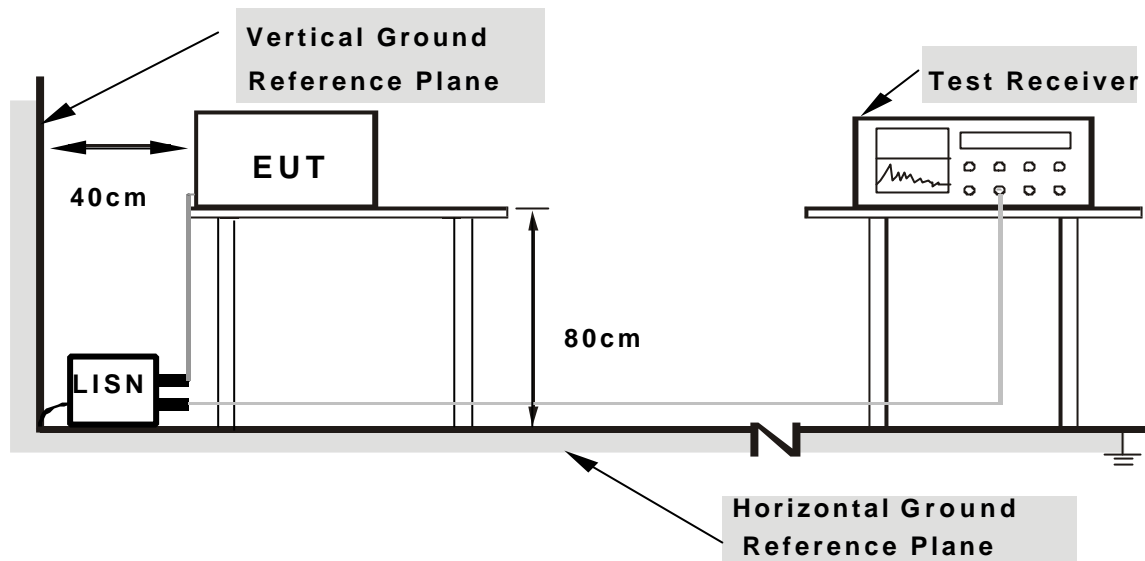

Note: 1. Support units were connected to second LISN.

2. Both of LISNs (AMN) are 80 cm from EUT and at least 80 cm from other units and other metal planes

For the actual test configuration, please refer to the related item – Photographs of the Test Configuration.

4.1.6 EUT OPERATING CONDITIONS

- a. Connected the EUT with Notebook and placed on a testing table.
- b. The Notebook system ran a test program (provided by manufacturer) to enable EUT under transmission condition continuously at specific channel frequency.
- c. The Notebook system sent "H" messages to its screen.
- d. The Notebook system sent "H" messages to modem.
- e. The Notebook system sent "H" messages to printer, and the printer printed them on paper.
- f. Steps c ~ e were repeated.

4.1.7 TEST RESULTS

CONDUCTED WORST-CASE DATA_NORMAL MODE

EUT TEST CONDITION		MEASUREMENT DETAIL	
CHANNEL	Channel 1	PHASE	Line 1
MODULATION TYPE	BPSK	6dB BANDWIDTH	9 kHz
TRANSFER RATE	6Mbps	ENVIRONMENTAL CONDITIONS	25deg. C, 65%RH, 991hPa
INPUT POWER (SYSTEM)	120Vac, 60 Hz	TESTED BY	Long Chen

No	Freq. [MHz]	Corr. Factor [dB]	Reading Value [dB (uV)]		Emission Level [dB (uV)]		Limit [dB (uV)]		Margin (dB)	
			Q.P.	AV.	Q.P.	AV.	Q.P.	AV.	Q.P.	AV.
1	0.197	0.10	45.55	-	45.65	-	63.75	53.75	-18.10	-
2	0.306	0.10	31.89	-	31.99	-	60.07	50.07	-28.08	-
3	0.607	0.10	29.91	-	30.01	-	56.00	46.00	-25.99	-
4	0.963	0.10	31.00	-	31.10	-	56.00	46.00	-24.90	-
5	1.922	0.19	27.71	-	27.90	-	56.00	46.00	-28.10	-
6	20.609	0.61	17.91	-	18.52	-	60.00	50.00	-41.48	-

- REMARKS:**
1. Q.P. and AV. are abbreviations of quasi-peak and average individually.
 2. "-": The Quasi-peak reading value also meets average limit and measurement with the average detector is unnecessary.
 3. The emission levels of other frequencies were very low against the limit.
 4. Margin value = Emission level - Limit value
 5. Correction factor = Insertion loss + Cable loss
 6. Emission Level = Correction Factor + Reading Value.

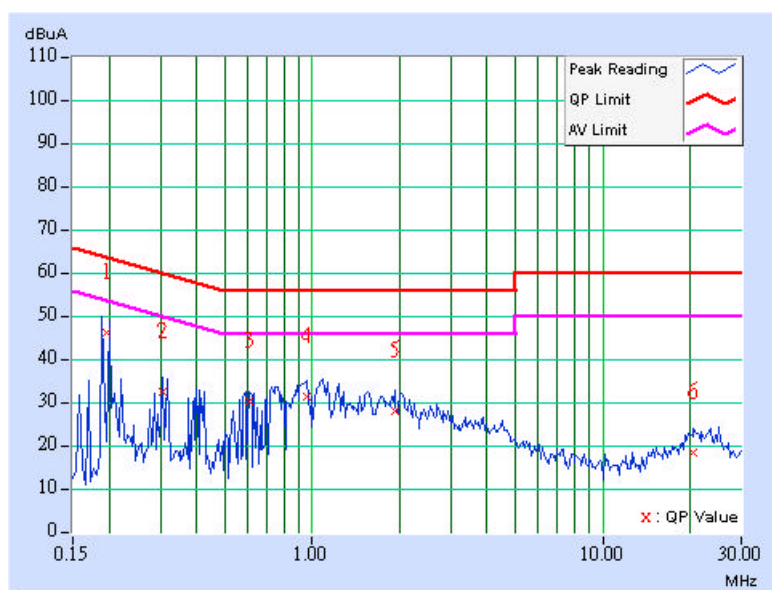

EUT TEST CONDITION		MEASUREMENT DETAIL	
CHANNEL	Channel 1	PHASE	Line 2
MODULATION TYPE	BPSK	6dB BANDWIDTH	9 kHz
TRANSFER RATE	6Mbps	ENVIRONMENTAL CONDITIONS	25deg. C, 65%RH, 991hPa
INPUT POWER (SYSTEM)	120Vac, 60 Hz	TESTED BY	Long Chen

No	Freq.	Corr.	Reading Value		Emission Level		Limit		Margin	
	[MHz]	Factor	[dB (uV)]		[dB (uV)]		[dB (uV)]		(dB)	
		(dB)	Q.P.	AV.	Q.P.	AV.	Q.P.	AV.	Q.P.	AV.
1	0.197	0.10	47.06	-	47.16	-	63.74	53.74	-16.58	-
2	0.314	0.10	32.92	-	33.02	-	59.86	49.86	-26.84	-
3	0.420	0.10	33.71	-	33.81	-	57.46	47.46	-23.64	-
4	1.074	0.20	33.85	-	34.05	-	56.00	46.00	-21.95	-
5	1.563	0.20	30.19	-	30.39	-	56.00	46.00	-25.61	-
6	2.773	0.27	27.35	-	27.62	-	56.00	46.00	-28.38	-

- REMARKS:**
1. Q.P. and AV. are abbreviations of quasi-peak and average individually.
 2. "-": The Quasi-peak reading value also meets average limit and measurement with the average detector is unnecessary.
 3. The emission levels of other frequencies were very low against the limit.
 4. Margin value = Emission level - Limit value
 5. Correction factor = Insertion loss + Cable loss
 6. Emission Level = Correction Factor + Reading Value.

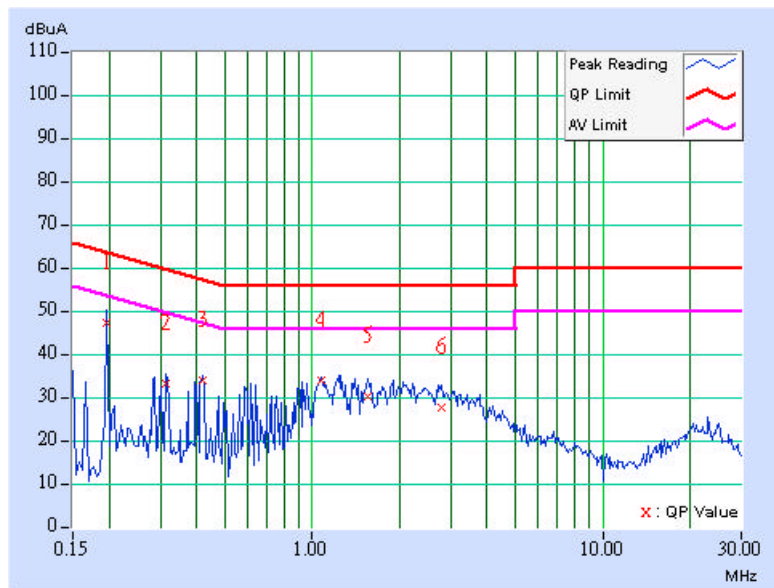

EUT TEST CONDITION		MEASUREMENT DETAIL	
CHANNEL	Channel 6	PHASE	Line 1
MODULATION TYPE	BPSK	6dB BANDWIDTH	9 kHz
TRANSFER RATE	6Mbps	ENVIRONMENTAL CONDITIONS	25deg. C, 65%RH, 991hPa
INPUT POWER (SYSTEM)	120Vac, 60 Hz	TESTED BY	Long Chen

No	Freq. [MHz]	Corr. Factor [dB]	Reading Value [dB (uV)]		Emission Level [dB (uV)]		Limit [dB (uV)]		Margin (dB)	
			Q.P.	AV.	Q.P.	AV.	Q.P.	AV.	Q.P.	AV.
1	0.209	0.10	45.03	-	45.13	-	63.26	53.26	-18.13	-
2	0.408	0.10	31.14	-	31.24	-	57.69	47.69	-26.45	-
3	0.599	0.10	30.23	-	30.33	-	56.00	46.00	-25.67	-
4	1.090	0.11	29.90	-	30.01	-	56.00	46.00	-25.99	-
5	1.922	0.19	27.67	-	27.86	-	56.00	46.00	-28.14	-
6	25.000	0.93	21.97	-	22.90	-	60.00	50.00	-37.10	-

- REMARKS:**
1. Q.P. and AV. are abbreviations of quasi-peak and average individually.
 2. "-": The Quasi-peak reading value also meets average limit and measurement with the average detector is unnecessary.
 3. The emission levels of other frequencies were very low against the limit.
 4. Margin value = Emission level - Limit value
 5. Correction factor = Insertion loss + Cable loss
 6. Emission Level = Correction Factor + Reading Value.

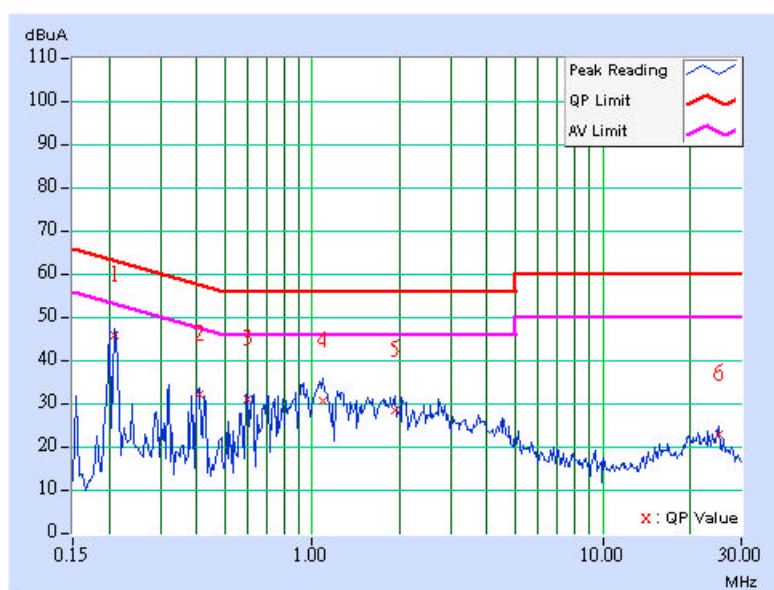

EUT TEST CONDITION		MEASUREMENT DETAIL	
CHANNEL	Channel 6	PHASE	Line 2
MODULATION TYPE	BPSK	6dB BANDWIDTH	9 kHz
TRANSFER RATE	6Mbps	ENVIRONMENTAL CONDITIONS	25deg. C, 65%RH, 991hPa
INPUT POWER (SYSTEM)	120Vac, 60 Hz	TESTED BY	Long Chen

No	Freq. [MHz]	Corr. Factor [dB]	Reading Value [dB (uV)]		Emission Level [dB (uV)]		Limit [dB (uV)]		Margin (dB)	
			Q.P.	AV.	Q.P.	AV.	Q.P.	AV.	Q.P.	AV.
1	0.205	0.10	46.36	-	46.46	-	63.42	53.42	-16.96	-
2	0.384	0.10	30.75	-	30.85	-	58.18	48.18	-27.33	-
3	0.595	0.13	31.06	-	31.19	-	56.00	46.00	-24.81	-
4	1.113	0.20	29.17	-	29.37	-	56.00	46.00	-26.63	-
5	2.035	0.20	29.78	-	29.98	-	56.00	46.00	-26.02	-
6	25.000	0.83	22.73	-	23.56	-	60.00	50.00	-36.44	-

- REMARKS:**
1. Q.P. and AV. are abbreviations of quasi-peak and average individually.
 2. "-": The Quasi-peak reading value also meets average limit and measurement with the average detector is unnecessary.
 3. The emission levels of other frequencies were very low against the limit.
 4. Margin value = Emission level - Limit value
 5. Correction factor = Insertion loss + Cable loss
 6. Emission Level = Correction Factor + Reading Value.

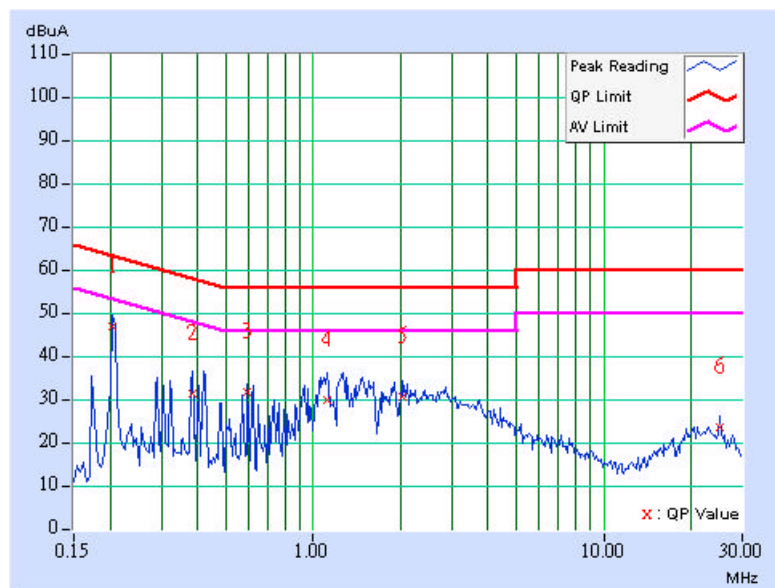

EUT TEST CONDITION		MEASUREMENT DETAIL	
CHANNEL	Channel 11	PHASE	Line 1
MODULATION TYPE	BPSK	6dB BANDWIDTH	9 kHz
TRANSFER RATE	6Mbps	ENVIRONMENTAL CONDITIONS	25deg. C, 65%RH, 991hPa
INPUT POWER (SYSTEM)	120Vac, 60 Hz	TESTED BY	Long Chen

No	Freq. [MHz]	Corr. Factor [dB]	Reading Value [dB (uV)]		Emission Level [dB (uV)]		Limit [dB (uV)]		Margin (dB)	
			Q.P.	AV.	Q.P.	AV.	Q.P.	AV.	Q.P.	AV.
1	0.194	0.10	45.39	-	45.49	-	63.86	53.86	-18.37	-
2	0.298	0.10	31.60	-	31.70	-	60.29	50.29	-28.59	-
3	0.408	0.10	30.53	-	30.63	-	57.69	47.69	-27.06	-
4	0.736	0.10	31.19	-	31.29	-	56.00	46.00	-24.71	-
5	1.090	0.11	30.10	-	30.21	-	56.00	46.00	-25.79	-
6	25.000	0.93	21.91	-	22.84	-	60.00	50.00	-37.16	-

- REMARKS:**
1. Q.P. and AV. are abbreviations of quasi-peak and average individually.
 2. "-": The Quasi-peak reading value also meets average limit and measurement with the average detector is unnecessary.
 3. The emission levels of other frequencies were very low against the limit.
 4. Margin value = Emission level - Limit value
 5. Correction factor = Insertion loss + Cable loss
 6. Emission Level = Correction Factor + Reading Value.

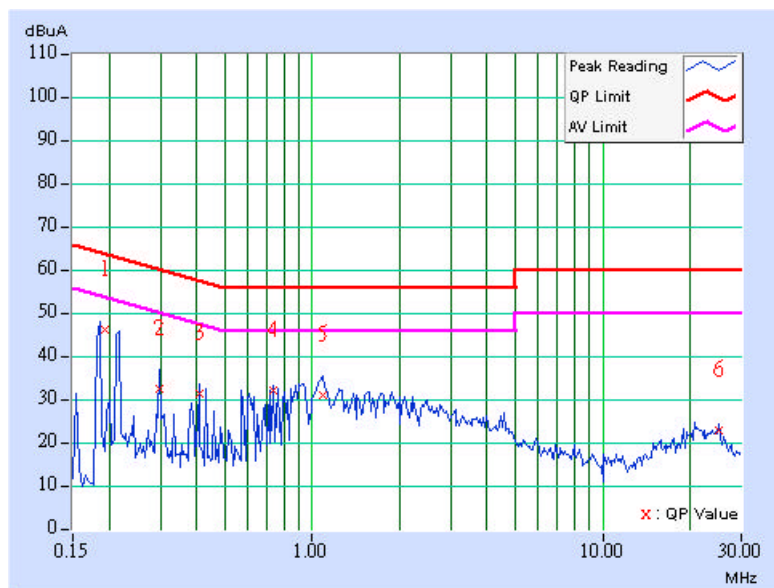

EUT TEST CONDITION		MEASUREMENT DETAIL	
CHANNEL	Channel 11	PHASE	Line 2
MODULATION TYPE	BPSK	6dB BANDWIDTH	9 kHz
TRANSFER RATE	6Mbps	ENVIRONMENTAL CONDITIONS	25deg. C, 65%RH, 991hPa
INPUT POWER (SYSTEM)	120Vac, 60 Hz	TESTED BY	Long Chen

No	Freq. [MHz]	Corr. Factor [dB]	Reading Value [dB (uV)]		Emission Level [dB (uV)]		Limit [dB (uV)]		Margin (dB)	
			Q.P.	AV.	Q.P.	AV.	Q.P.	AV.	Q.P.	AV.
1	0.197	0.10	46.04	-	46.14	-	63.74	53.74	-17.60	-
2	0.412	0.10	33.09	-	33.19	-	57.61	47.61	-24.42	-
3	0.615	0.14	31.40	-	31.54	-	56.00	46.00	-24.46	-
4	1.078	0.20	31.64	-	31.84	-	56.00	46.00	-24.16	-
5	1.902	0.20	29.26	-	29.46	-	56.00	46.00	-26.54	-
6	20.840	0.61	16.96	-	17.57	-	60.00	50.00	-42.43	-

- REMARKS:**
1. Q.P. and AV. are abbreviations of quasi-peak and average individually.
 2. "-": The Quasi-peak reading value also meets average limit and measurement with the average detector is unnecessary.
 3. The emission levels of other frequencies were very low against the limit.
 4. Margin value = Emission level - Limit value
 5. Correction factor = Insertion loss + Cable loss
 6. Emission Level = Correction Factor + Reading Value.

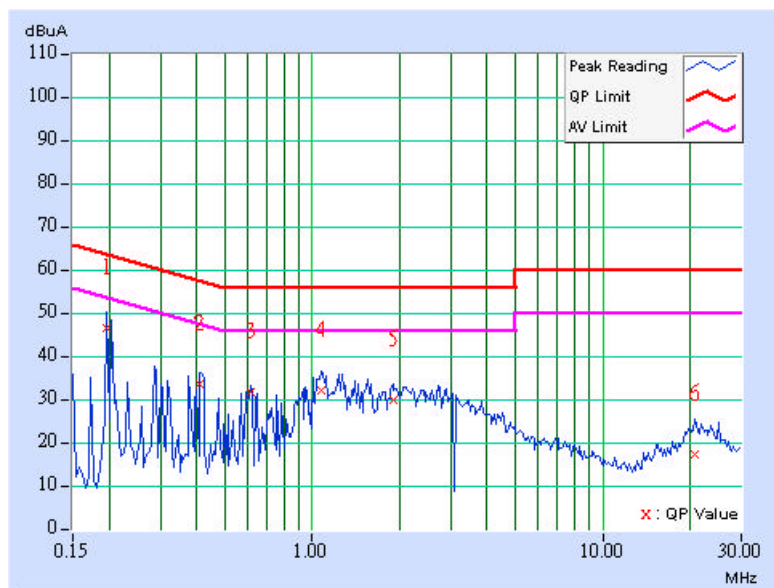

CONDUCTED WORST-CASE DATA_TURBO MODE

EUT TEST CONDITION		MEASUREMENT DETAIL	
CHANNEL	Channel 6	PHASE	Line 1
MODULATION TYPE	QPSK	6dB BANDWIDTH	9 kHz
TRANSFER RATE	12Mbps	ENVIRONMENTAL CONDITIONS	25deg. C, 65%RH, 991hPa
INPUT POWER (SYSTEM)	120Vac, 60 Hz	TESTED BY	Long Chen

No	Freq. [MHz]	Corr. Factor [dB]	Reading Value [dB (uV)]		Emission Level [dB (uV)]		Limit [dB (uV)]		Margin (dB)	
			Q.P.	AV.	Q.P.	AV.	Q.P.	AV.	Q.P.	AV.
1	0.212	0.10	44.23	-	44.33	-	63.15	53.15	-18.82	-
2	0.311	0.10	31.03	-	31.13	-	59.95	49.95	-28.82	-
3	1.094	0.11	32.47	-	32.58	-	56.00	46.00	-23.42	-
4	2.039	0.20	26.34	-	26.54	-	56.00	46.00	-29.46	-
5	2.984	0.28	22.57	-	22.85	-	56.00	46.00	-33.15	-
6	29.234	1.27	19.30	-	20.57	-	60.00	50.00	-39.43	-

- REMARKS:**
1. Q.P. and AV. are abbreviations of quasi-peak and average individually.
 2. "-": The Quasi-peak reading value also meets average limit and measurement with the average detector is unnecessary.
 3. The emission levels of other frequencies were very low against the limit.
 4. Margin value = Emission level - Limit value
 5. Correction factor = Insertion loss + Cable loss
 6. Emission Level = Correction Factor + Reading Value.

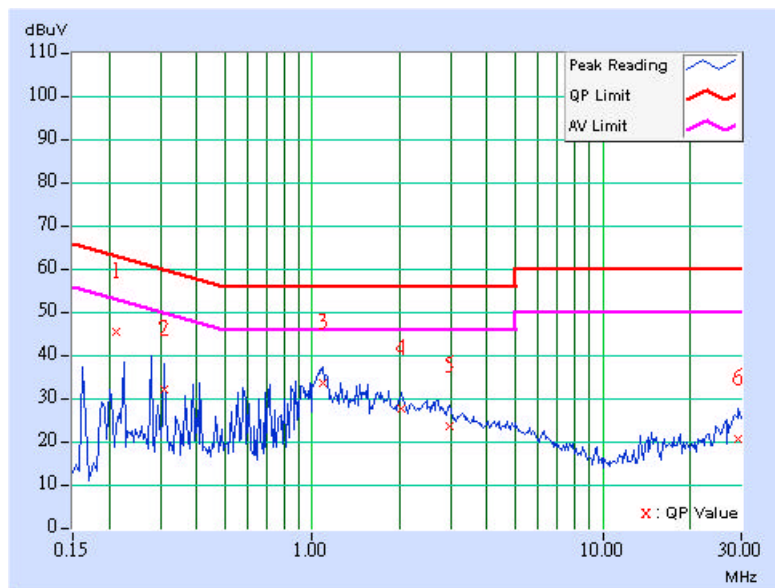

EUT TEST CONDITION		MEASUREMENT DETAIL	
CHANNEL	Channel 6	PHASE	Line 2
MODULATION TYPE	QPSK	6dB BANDWIDTH	9 kHz
TRANSFER RATE	12Mbps	ENVIRONMENTAL CONDITIONS	25deg. C, 65%RH, 991hPa
INPUT POWER (SYSTEM)	120Vac, 60 Hz	TESTED BY	Long Chen

No	Freq. [MHz]	Corr. Factor [dB]	Reading Value [dB (uV)]		Emission Level [dB (uV)]		Limit [dB (uV)]		Margin (dB)	
			Q.P.	AV.	Q.P.	AV.	Q.P.	AV.	Q.P.	AV.
1	0.197	0.10	46.16	-	46.26	-	63.75	53.75	-17.49	-
2	0.209	0.10	46.89	-	46.99	-	63.25	53.25	-16.26	-
3	0.427	0.10	34.12	-	34.22	-	57.30	47.30	-23.08	-
4	1.055	0.20	31.69	-	31.89	-	56.00	46.00	-24.11	-
5	1.922	0.20	30.14	-	30.34	-	56.00	46.00	-25.66	-
6	20.609	0.59	18.37	-	18.96	-	60.00	50.00	-41.04	-

- REMARKS:**
1. Q.P. and AV. are abbreviations of quasi-peak and average individually.
 2. "-": The Quasi-peak reading value also meets average limit and measurement with the average detector is unnecessary.
 3. The emission levels of other frequencies were very low against the limit.
 4. Margin value = Emission level - Limit value
 5. Correction factor = Insertion loss + Cable loss
 6. Emission Level = Correction Factor + Reading Value.

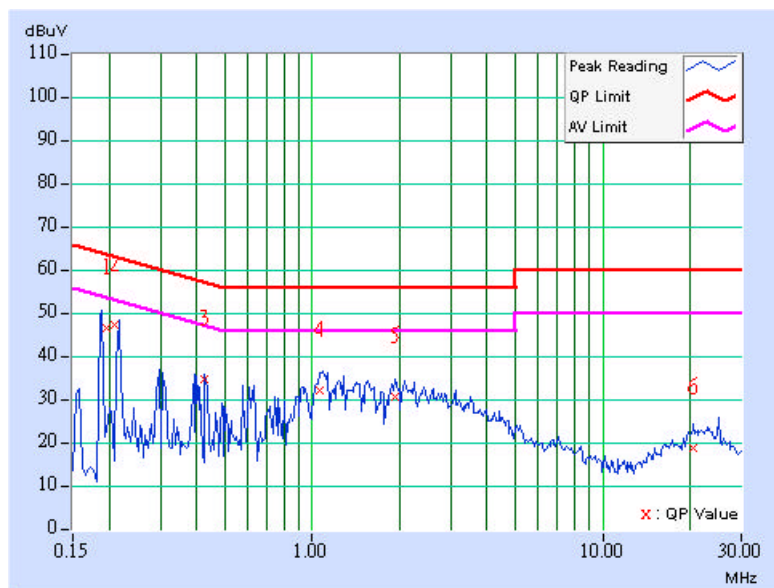



4.2 RADIATED EMISSION MEASUREMENT

4.2.1 LIMITS OF RADIATED EMISSION MEASUREMENT

Emissions radiated outside of the specified bands, shall be according to the general radiated limits in 15.209 as following:

Frequencies (MHz)	Field strength (microvolts/meter)	Measurement distance (meters)
0.009-0.490	2400/F(kHz)	300
0.490-1.705	24000/F(kHz)	30
1.705-30.0	30	30
30-88	100	3
88-216	150	3
216-960	200	3
Above 960	500	3

NOTE:

1. The lower limit shall apply at the transition frequencies.
2. Emission level (dBuV/m) = 20 log Emission level (uV/m).
3. As shown in 15.35(b), for frequencies above 1000MHz, the field strength limits are based on average detector, however, the peak field strength of any emission shall not exceed the maximum permitted average limits, specified above by more than 20dB under any condition of modulation.

4.2.2 TEST INSTRUMENTS

DESCRIPTION & MANUFACTURER	MODEL NO.	SERIAL NO.	CALIBRATED UNTIL
Test Receiver ROHDE & SCHWARZ	ESIB7	100188	Dec. 20, 2006
Spectrum Analyzer ROHDE & SCHWARZ	FSP40	100039	Nov. 27, 2006
BILOG Antenna SCHWARZBECK	VULB9168	9168-157	Jan. 15, 2007
HORN Antenna SCHWARZBECK	BBHA 9120 D	9120D-407	Jan. 22, 2007
HORN Antenna SCHWARZBECK	BBHA 9170	BBHA9170147	Jan. 26, 2007
Preamplifier Agilent	8449B	3008A01961	Oct. 23, 2006
Preamplifier Agilent	8447D	2944A10629	Oct. 27, 2006
RF signal cable HUBER+SUHNER	SUCOFLEX 104	214380/4	Jan. 16, 2007
RF signal cable HUBER+SUHNER	SUCOFLEX 104	219266/4	Jan. 16, 2007
Software ADT.	ADT_Radiated_V5.14	NA	NA
Antenna Tower ADT.	AT100	AT93021702	NA
Turn Table ADT.	TT100.	TT93021702	NA
Controller ADT.	SC100.	SC93021702	NA

- NOTE:**
1. The calibration interval of the above test instruments is 12 months and the calibrations are traceable to NML/ROC and NIST/USA.
 2. The test was performed in HwaYa Chamber 1.
 3. The horn antenna and HP preamplifier (model: 8449B) are used only for the measurement of emission frequency above 1GHz if tested.
 4. The IC Site Registration No. is IC4924-2.

4.2.3 TEST PROCEDURES

- a. The EUT was placed on the top of a rotating table 0.8 meters above the ground at a 3 meters semi-anechoic chamber. The table was rotated 360 degrees to determine the position of the highest radiation.
- b. The EUT was set 3 meters away from the interference-receiving antenna, which was mounted on the top of a variable-height antenna tower.
- c. The antenna is a broadband antenna, and its height is varied from one meter to four meters above the ground to determine the maximum value of the field strength. Both horizontal and vertical polarizations of the antenna are set to make the measurement.
- d. For each suspected emission, the EUT was arranged to its worst case and then the antenna was tuned to heights from 1 meter to 4 meters and the rotatable table was turned from 0 degrees to 360 degrees to find the maximum reading.
- e. The test-receiver system was set to Peak Detect Function and Specified Bandwidth with Maximum Hold Mode.
- f. If the emission level of the EUT in peak mode was lower than the limit specified, then testing could be stopped and the peak values of the EUT would be reported. Otherwise the emissions would be re-tested one by one using peak, quasi-peak or average method as specified and then reported in a data sheet.

NOTE:

1. The resolution bandwidth and video bandwidth of test receiver/spectrum analyzer is 120kHz for Peak detection (PK) and Quasi-peak detection (QP) at frequency below 1GHz.
2. The resolution bandwidth and video bandwidth of test receiver/spectrum analyzer is 1 MHz for Peak detection at frequency above 1GHz.
3. The resolution bandwidth of test receiver/spectrum analyzer is 1 MHz and the video bandwidth is 10Hz for Average detection (AV) at frequency above 1GHz.

4.2.4 DEVIATION FROM TEST STANDARD

No deviation

4.2.5 TEST SETUP

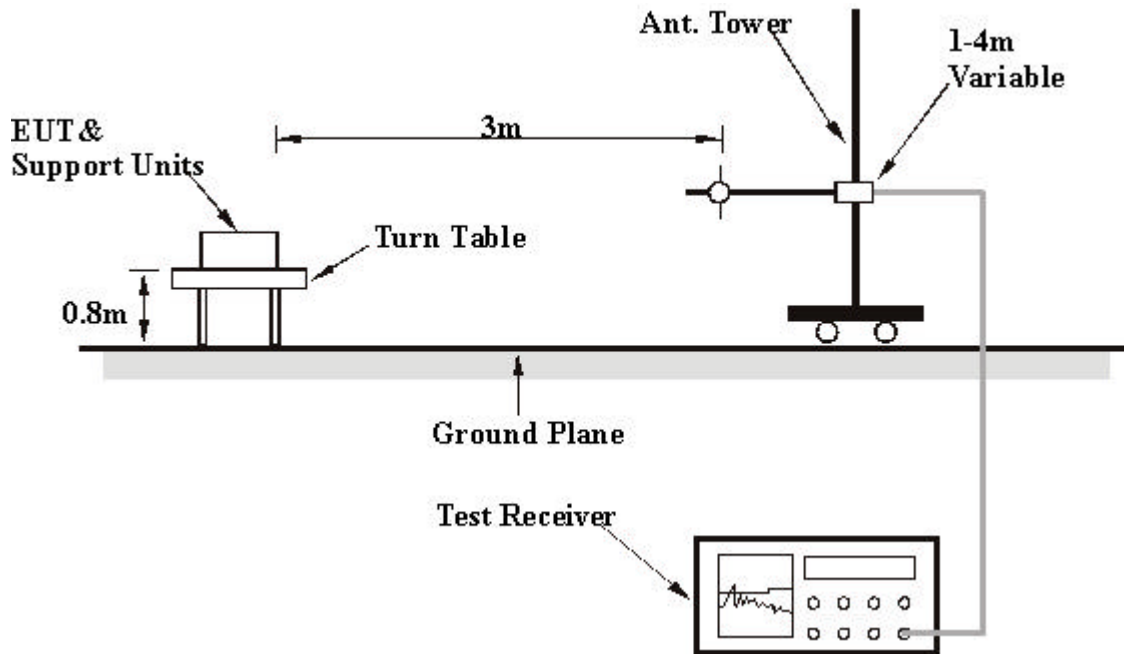

For the actual test configuration, please refer to the related item – Photographs of the Test Configuration.

4.2.6 EUT OPERATING CONDITIONS

Same as 4.1.6



4.2.7 TEST RESULTS

RADIATED WORST-CASE DATA: BELOW 1GHz_NORMAL MODE

EUT TEST CONDITION		MEASUREMENT DETAIL	
CHANNEL	Channel 11	FREQUENCY RANGE	Below 1000MHz
MODULATION TYPE	BPSK	DETECTOR FUNCTION	Quasi-Peak
TRANSFER RATE	6Mbps	ENVIRONMENTAL CONDITIONS	22deg. C, 63%RH, 991hPa
INPUT POWER (SYSTEM)	120Vac, 60 Hz	TESTED BY	Brad Wu

ANTENNA POLARITY & TEST DISTANCE: HORIZONTAL AT 3 M								
No.	Freq. (MHz)	Emission Level (dBuV/m)	Limit (dBuV/m)	Margin (dB)	Antenna Height (m)	Table Angle (Degree)	Raw Value (dBuV)	Correction Factor (dB/m)
1	255.49	37.37 QP	46.00	-8.63	1.25 H	211	24.94	12.43
2	300.20	34.27 QP	46.00	-11.73	1.00 H	184	18.83	15.43
3	383.79	37.34 QP	46.00	-8.66	1.50 H	193	20.08	17.25
4	599.56	34.46 QP	46.00	-11.54	1.50 H	220	11.93	22.54
5	799.78	37.96 QP	46.00	-8.04	1.00 H	244	11.85	26.11
6	916.41	42.41 QP	46.00	-3.59	1.00 H	148	14.19	28.22

ANTENNA POLARITY & TEST DISTANCE: VERTICAL AT 3 M								
No.	Freq. (MHz)	Emission Level (dBuV/m)	Limit (dBuV/m)	Margin (dB)	Antenna Height (m)	Table Angle (Degree)	Raw Value (dBuV)	Correction Factor (dB/m)
1	119.42	36.20 QP	43.50	-7.30	1.25 V	238	25.41	10.80
2	255.49	39.57 QP	46.00	-6.43	1.00 V	268	27.14	12.43
3	383.79	39.85 QP	46.00	-6.15	1.50 V	169	22.59	17.25
4	500.42	37.26 QP	46.00	-8.74	1.00 V	157	17.31	19.95
5	640.38	35.01 QP	46.00	-10.99	1.00 V	172	11.99	23.01
6	751.18	39.02 QP	46.00	-6.98	1.00 V	211	13.23	25.79

- REMARKS:**
1. Emission level(dBuV/m)=Raw Value(dBuV) + Correction Factor(dB/m)
 2. Correction Factor(dB/m) = Antenna Factor (dB/m) + Cable Factor (dB)
 3. The other emission levels were very low against the limit.
 4. Margin value = Emission level – Limit value.



RADIATED WORST-CASE DATA: BELOW 1GHz_TURBO MODE

EUT TEST CONDITION		MEASUREMENT DETAIL	
CHANNEL	Channel 6	FREQUENCY RANGE	Below 1000MHz
MODULATION TYPE	QPSK	DETECTOR FUNCTION	Quasi-Peak
TRANSFER RATE	12Mbps	ENVIRONMENTAL CONDITIONS	22deg. C, 63%RH, 991hPa
INPUT POWER (SYSTEM)	120Vac, 60 Hz	TESTED BY	Brad Wu

ANTENNA POLARITY & TEST DISTANCE: HORIZONTAL AT 3 M								
No.	Freq. (MHz)	Emission Level (dBuV/m)	Limit (dBuV/m)	Margin (dB)	Antenna Height (m)	Table Angle (Degree)	Raw Value (dBuV)	Correction Factor (dB/m)
1	255.76	37.82 QP	46.00	-8.18	1.25 H	134	25.39	12.43
2	300.28	34.49 QP	46.00	-11.51	1.25 H	169	19.06	15.43
3	383.66	37.54 QP	46.00	-8.46	1.50 H	206	20.29	17.25
4	599.42	34.11 QP	46.00	-11.89	1.25 H	117	11.58	22.53
5	799.72	37.85 QP	46.00	-8.15	1.00 H	222	11.74	26.11
6	916.55	42.67 QP	46.00	-3.33	1.00 H	205	14.45	28.22

ANTENNA POLARITY & TEST DISTANCE: VERTICAL AT 3 M								
No.	Freq. (MHz)	Emission Level (dBuV/m)	Limit (dBuV/m)	Margin (dB)	Antenna Height (m)	Table Angle (Degree)	Raw Value (dBuV)	Correction Factor (dB/m)
1	119.61	36.48 QP	43.50	-7.02	1.00 V	236	25.66	10.82
2	255.55	39.62 QP	46.00	-6.38	1.00 V	213	27.19	12.43
3	383.49	39.63 QP	46.00	-6.37	1.25 V	158	22.39	17.24
4	500.72	37.49 QP	46.00	-8.51	1.00 V	162	17.53	19.96
5	640.59	35.24 QP	46.00	-10.76	1.00 V	195	12.23	23.01
6	751.24	39.44 QP	46.00	-6.56	1.50 V	109	13.65	25.79

- REMARKS:**
1. Emission level(dBuV/m)=Raw Value(dBuV) + Correction Factor(dB/m)
 2. Correction Factor(dB/m) = Antenna Factor (dB/m) + Cable Factor (dB)
 3. The other emission levels were very low against the limit.
 4. Margin value = Emission level – Limit value.



802.11b DSSS MODULATION

EUT TEST CONDITION		MEASUREMENT DETAIL	
CHANNEL	Channel 1	FREQUENCY RANGE	1 ~ 25GHz
MODULATION TYPE	DBPSK	DETECTOR FUNCTION	Peak(PK) Average (AV)
TRANSFER RATE	1Mbps	ENVIRONMENTAL CONDITIONS	25deg. C, 75%RH, 991hPa
INPUT POWER (SYSTEM)	120Vac, 60 Hz	TESTED BY	Lori Chiu

ANTENNA POLARITY & TEST DISTANCE: HORIZONTAL AT 3 M								
No.	Freq. (MHz)	Emission Level (dBuV/m)	Limit (dBuV/m)	Margin (dB)	Antenna Height (m)	Table Angle (Degree)	Raw Value (dBuV)	Correction Factor (dB/m)
1	2386.00	54.11 PK	74.00	-19.89	1.13 H	163	22.74	31.37
1	2386.00	44.99 AV	54.00	-9.01	1.13 H	163	13.62	31.37
2	*2412.00	99.59 PK			1.13 H	163	68.13	31.46
2	*2412.00	96.22 AV			1.13 H	163	64.76	31.46
3	4824.00	46.60 PK	74.00	-27.40	1.13 H	20	9.47	37.13
3	4824.00	34.35 AV	54.00	-19.65	1.13 H	20	-2.78	37.13

ANTENNA POLARITY & TEST DISTANCE: VERTICAL AT 3 M								
No.	Freq. (MHz)	Emission Level (dBuV/m)	Limit (dBuV/m)	Margin (dB)	Antenna Height (m)	Table Angle (Degree)	Raw Value (dBuV)	Correction Factor (dB/m)
1	2320.00	59.26 PK	74.00	-14.74	1.00 V	169	28.11	31.15
1	2320.00	50.62 AV	54.00	-3.38	1.00 V	169	19.47	31.15
2	2386.00	60.34 PK	74.00	-13.66	1.52 V	185	28.97	31.37
2	2386.00	52.24 AV	54.00	-1.76	1.52 V	185	20.87	31.37
3	*2412.00	112.70 PK			1.19 V	341	81.24	31.46
3	*2412.00	108.20 AV			1.19 V	341	76.74	31.46
4	3216.00	49.55 PK	74.00	-24.45	1.55 V	28	16.44	33.11
4	3216.00	43.61 AV	54.00	-10.39	1.55 V	28	10.50	33.11
5	4824.00	49.57 PK	74.00	-24.43	1.21 V	135	12.44	37.13
5	4824.00	43.26 AV	54.00	-10.74	1.21 V	135	6.13	37.13

- REMARKS:**
1. Emission level(dBuV/m)=Raw Value(dBuV) + Correction Factor(dB/m)
 2. Correction Factor(dB/m) = Antenna Factor (dB/m) + Cable Factor (dB)
 3. The other emission levels were very low against the limit.
 4. Margin value = Emission level – Limit value.
 5. “ * “ : Fundamental frequency.



EUT TEST CONDITION		MEASUREMENT DETAIL	
CHANNEL	Channel 6	FREQUENCY RANGE	1 ~ 25GHz
MODULATION TYPE	DBPSK	DETECTOR FUNCTION	Peak(PK) Average (AV)
TRANSFER RATE	1Mbps	ENVIRONMENTAL CONDITIONS	25deg. C, 75%RH, 991hPa
INPUT POWER (SYSTEM)	120Vac, 60 Hz	TESTED BY	Lori Chiu

ANTENNA POLARITY & TEST DISTANCE: HORIZONTAL AT 3 M

No.	Freq. (MHz)	Emission Level (dBuV/m)	Limit (dBuV/m)	Margin (dB)	Antenna Height (m)	Table Angle (Degree)	Raw Value (dBuV)	Correction Factor (dB/m)
1	2320.00	56.20 PK	74.00	-17.80	1.20 H	322	25.05	31.15
1	2320.00	45.33 AV	54.00	-8.67	1.20 H	322	14.18	31.15
2	*2437.00	100.10 PK			1.20 H	328	68.56	31.54
2	*2437.00	96.19 AV			1.20 H	328	64.65	31.54
3	4874.00	46.82 PK	74.00	-27.18	1.14 H	211	9.53	37.29
3	4874.00	34.24 AV	54.00	-19.76	1.14 H	211	-3.05	37.29

ANTENNA POLARITY & TEST DISTANCE: VERTICAL AT 3 M

No.	Freq. (MHz)	Emission Level (dBuV/m)	Limit (dBuV/m)	Margin (dB)	Antenna Height (m)	Table Angle (Degree)	Raw Value (dBuV)	Correction Factor (dB/m)
1	2320.00	59.50 PK	74.00	-14.50	1.00 V	171	28.35	31.15
1	2320.00	51.10 AV	54.00	-2.90	1.00 V	171	19.95	31.15
2	*2437.00	112.16 PK			1.17 V	160	80.62	31.54
2	*2437.00	108.28 AV			1.17 V	160	76.74	31.54
3	3248.00	49.27 PK	74.00	-24.73	1.54 V	62	16.08	33.19
3	3248.00	43.55 AV	54.00	-10.45	1.54 V	62	10.36	33.19
4	4874.00	49.87 PK	74.00	-24.13	1.62 V	251	12.58	37.29
4	4874.00	43.51 AV	54.00	-10.49	1.62 V	251	6.22	37.29

- REMARKS:**
1. Emission level(dBuV/m)=Raw Value(dBuV) + Correction Factor(dB/m)
 2. Correction Factor(dB/m) = Antenna Factor (dB/m) + Cable Factor (dB)
 3. The other emission levels were very low against the limit.
 4. Margin value = Emission level – Limit value.
 5. " * " : Fundamental frequency.



EUT TEST CONDITION		MEASUREMENT DETAIL	
CHANNEL	Channel 11	FREQUENCY RANGE	1 ~ 25GHz
MODULATION TYPE	DBPSK	DETECTOR FUNCTION	Peak(PK) Average (AV)
TRANSFER RATE	1Mbps	ENVIRONMENTAL CONDITIONS	25deg. C, 75%RH, 991hPa
INPUT POWER (SYSTEM)	120Vac, 60 Hz	TESTED BY	Lori Chiu

ANTENNA POLARITY & TEST DISTANCE: HORIZONTAL AT 3 M								
No.	Freq. (MHz)	Emission Level (dBuV/m)	Limit (dBuV/m)	Margin (dB)	Antenna Height (m)	Table Angle (Degree)	Raw Value (dBuV)	Correction Factor (dB/m)
1	2320.00	56.18 PK	74.00	-17.82	1.00 H	161	25.03	31.15
1	2320.00	45.27 AV	54.00	-8.73	1.00 H	161	14.12	31.15
2	*2462.00	100.05 PK			1.15 H	210	68.43	31.62
2	*2462.00	96.18 AV			1.15 H	210	64.56	31.62
3	2499.00	55.24 PK	74.00	-18.76	1.16 H	212	23.49	31.75
3	2499.00	45.82 AV	54.00	-8.18	1.16 H	212	14.07	31.75

ANTENNA POLARITY & TEST DISTANCE: VERTICAL AT 3 M								
No.	Freq. (MHz)	Emission Level (dBuV/m)	Limit (dBuV/m)	Margin (dB)	Antenna Height (m)	Table Angle (Degree)	Raw Value (dBuV)	Correction Factor (dB/m)
1	2320.00	59.91 PK	74.00	-14.09	1.00 V	180	28.76	31.15
1	2320.00	51.02 AV	54.00	-2.98	1.00 V	180	19.87	31.15
2	*2462.00	112.14 PK			1.17 V	27	80.52	31.62
2	*2462.00	108.85 AV			1.17 V	27	77.23	31.62
3	2499.00	61.89 PK	74.00	-12.11	1.15 V	122	30.14	31.75
3	2499.00	52.10 AV	54.00	-1.90	1.15 V	122	20.35	31.75
4	3282.00	49.25 PK	74.00	-24.75	1.53 V	8	15.98	33.27
4	3282.00	43.84 AV	54.00	-10.16	1.53 V	8	10.57	33.27
5	4924.00	49.75 PK	74.00	-24.25	1.23 V	30	12.31	37.44
5	4924.00	43.64 AV	54.00	-10.36	1.23 V	30	6.20	37.44

- REMARKS:**
1. Emission level(dBuV/m)=Raw Value(dBuV) + Correction Factor(dB/m)
 2. Correction Factor(dB/m) = Antenna Factor (dB/m) + Cable Factor (dB)
 3. The other emission levels were very low against the limit.
 4. Margin value = Emission level – Limit value.
 5. “ * “ : Fundamental frequency.



802.11g OFDM NORMAL MODULATION

EUT TEST CONDITION		MEASUREMENT DETAIL	
CHANNEL	Channel 1	FREQUENCY RANGE	1 ~ 25GHz
MODULATION TYPE	BPSK	DETECTOR FUNCTION	Peak(PK) Average (AV)
TRANSFER RATE	6Mbps	ENVIRONMENTAL CONDITIONS	25deg. C, 75%RH, 991hPa
INPUT POWER (SYSTEM)	120Vac, 60 Hz	TESTED BY	Lori Chiu

ANTENNA POLARITY & TEST DISTANCE: HORIZONTAL AT 3 M								
No.	Freq. (MHz)	Emission Level (dBuV/m)	Limit (dBuV/m)	Margin (dB)	Antenna Height (m)	Table Angle (Degree)	Raw Value (dBuV)	Correction Factor (dB/m)
1	2320.00	55.67 PK	74.00	-18.33	1.10 H	212	24.52	31.15
1	2320.00	45.00 AV	54.00	-9.00	1.10 H	212	13.85	31.15
2	2390.00	57.01 PK	74.00	-16.99	1.09 H	211	25.62	31.39
2	2390.00	45.97 AV	54.00	-8.03	1.09 H	211	14.58	31.39
3	*2412.00	98.27 PK			1.08 H	320	66.81	31.46
3	*2412.00	88.18 AV			1.08 H	320	56.72	31.46
4	4824.00	45.15 PK	74.00	-28.85	1.37 H	215	8.02	37.13
4	4824.00	33.27 AV	54.00	-20.73	1.37 H	215	-3.86	37.13

ANTENNA POLARITY & TEST DISTANCE: VERTICAL AT 3 M								
No.	Freq. (MHz)	Emission Level (dBuV/m)	Limit (dBuV/m)	Margin (dB)	Antenna Height (m)	Table Angle (Degree)	Raw Value (dBuV)	Correction Factor (dB/m)
1	2320.00	59.28 PK	74.00	-14.72	1.02 V	169	28.13	31.15
1	2320.00	52.12 AV	54.00	-1.88	1.02 V	169	20.97	31.15
2	2390.00	65.65 PK	74.00	-8.35	1.48 V	206	34.26	31.39
2	2390.00	52.17 AV	54.00	-1.83	1.48 V	206	20.78	31.39
3	*2412.00	111.02 PK			1.17 V	121	79.56	31.46
3	*2412.00	101.62 AV			1.17 V	121	70.16	31.46
4	3216.00	49.28 PK	74.00	-24.72	1.52 V	231	16.17	33.11
4	3216.00	43.55 AV	54.00	-10.45	1.52 V	231	10.44	33.11
5	4824.00	45.37 PK	74.00	-28.63	1.02 V	155	8.24	37.13
5	4824.00	33.58 AV	54.00	-20.42	1.02 V	155	-3.55	37.13

- REMARKS:**
1. Emission level(dBuV/m)=Raw Value(dBuV) + Correction Factor(dB/m)
 2. Correction Factor(dB/m) = Antenna Factor (dB/m) + Cable Factor (dB)
 3. The other emission levels were very low against the limit.
 4. Margin value = Emission level – Limit value.
 5. “ * “ : Fundamental frequency.

EUT TEST CONDITION		MEASUREMENT DETAIL	
CHANNEL	Channel 6	FREQUENCY RANGE	1 ~ 25GHz
MODULATION TYPE	BPSK	DETECTOR FUNCTION	Peak(PK) Average (AV)
TRANSFER RATE	6Mbps	ENVIRONMENTAL CONDITIONS	25deg. C, 75%RH, 991hPa
INPUT POWER (SYSTEM)	120Vac, 60 Hz	TESTED BY	Lori Chiu

ANTENNA POLARITY & TEST DISTANCE: HORIZONTAL AT 3 M

No.	Freq. (MHz)	Emission Level (dBuV/m)	Limit (dBuV/m)	Margin (dB)	Antenna Height (m)	Table Angle (Degree)	Raw Value (dBuV)	Correction Factor (dB/m)
1	2320.00	55.87 PK	74.00	-18.13	1.11 H	224	24.72	31.15
1	2320.00	45.16 AV	54.00	-8.84	1.11 H	224	14.01	31.15
2	*2437.00	98.14 PK			1.10 H	134	66.60	31.54
2	*2437.00	88.78 AV			1.10 H	134	57.24	31.54

ANTENNA POLARITY & TEST DISTANCE: VERTICAL AT 3 M

No.	Freq. (MHz)	Emission Level (dBuV/m)	Limit (dBuV/m)	Margin (dB)	Antenna Height (m)	Table Angle (Degree)	Raw Value (dBuV)	Correction Factor (dB/m)
1	2320.00	59.47 PK	74.00	-14.53	1.18 V	210	28.32	31.15
1	2320.00	52.03 AV	54.00	-1.97	1.18 V	210	20.88	31.15
2	*2437.00	110.91 PK			1.18 V	171	79.37	31.54
2	*2437.00	101.57 AV			1.18 V	171	70.03	31.54
3	3248.00	49.52 PK	74.00	-24.48	1.08 V	225	16.33	33.19
3	3248.00	43.27 AV	54.00	-10.73	1.08 V	225	10.08	33.19
4	4874.00	45.64 PK	74.00	-28.36	1.30 V	345	8.35	37.29
4	4874.00	33.60 AV	54.00	-20.40	1.30 V	345	-3.69	37.29

- REMARKS:**
1. Emission level(dBuV/m)=Raw Value(dBuV) + Correction Factor(dB/m)
 2. Correction Factor(dB/m) = Antenna Factor (dB/m) + Cable Factor (dB)
 3. The other emission levels were very low against the limit.
 4. Margin value = Emission level – Limit value.
 5. “ * “ : Fundamental frequency.

EUT TEST CONDITION		MEASUREMENT DETAIL	
CHANNEL	Channel 11	FREQUENCY RANGE	1 ~ 25GHz
MODULATION TYPE	BPSK	DETECTOR FUNCTION	Peak(PK) Average (AV)
TRANSFER RATE	6Mbps	ENVIRONMENTAL CONDITIONS	25deg. C, 75%RH, 991hPa
INPUT POWER (SYSTEM)	120Vac, 60 Hz	TESTED BY	Lori Chiu

ANTENNA POLARITY & TEST DISTANCE: HORIZONTAL AT 3 M

No.	Freq. (MHz)	Emission Level (dBuV/m)	Limit (dBuV/m)	Margin (dB)	Antenna Height (m)	Table Angle (Degree)	Raw Value (dBuV)	Correction Factor (dB/m)
1	*2462.00	98.29 PK			1.10 H	317	66.67	31.62
1	*2462.00	88.81 AV			1.10 H	317	57.19	31.62
2	2483.50	56.46 PK	74.00	-17.54	1.08 H	318	24.76	31.70
2	2483.50	45.52 AV	54.00	-8.48	1.08 H	318	13.82	31.70
3	4924.00	45.12 PK	74.00	-28.88	1.10 H	31	7.68	37.44
3	4924.00	33.20 AV	54.00	-20.80	1.10 H	31	-4.24	37.44

ANTENNA POLARITY & TEST DISTANCE: VERTICAL AT 3 M

No.	Freq. (MHz)	Emission Level (dBuV/m)	Limit (dBuV/m)	Margin (dB)	Antenna Height (m)	Table Angle (Degree)	Raw Value (dBuV)	Correction Factor (dB/m)
1	2360.00	59.89 PK	74.00	-14.11	1.00 V	162	28.61	31.28
1	2360.00	52.04 AV	54.00	-1.96	1.00 V	162	20.76	31.28
2	*2462.00	110.97 PK			1.22 V	196	79.35	31.62
2	*2462.00	101.60 AV			1.22 V	196	69.98	31.62
3	2483.50	68.63 PK	74.00	-5.37	1.18 V	157	36.93	31.70
3	2483.50	52.13 AV	54.00	-1.87	1.18 V	157	20.43	31.70
4	3282.00	49.67 PK	74.00	-24.33	1.30 V	165	16.40	33.27
4	3282.00	43.18 AV	54.00	-10.82	1.30 V	165	9.91	33.27
5	4924.00	46.09 PK	74.00	-27.91	1.21 V	318	8.65	37.44
5	4924.00	34.24 AV	54.00	-19.76	1.21 V	318	-3.20	37.44

- REMARKS:**
1. Emission level(dBuV/m)=Raw Value(dBuV) + Correction Factor(dB/m)
 2. Correction Factor(dB/m) = Antenna Factor (dB/m) + Cable Factor (dB)
 3. The other emission levels were very low against the limit.
 4. Margin value = Emission level – Limit value.
 5. “ * “ : Fundamental frequency.



802.11g OFDM TURBO MODULATION

EUT TEST CONDITION		MEASUREMENT DETAIL	
CHANNEL	Channel 6	FREQUENCY RANGE	1 ~ 25GHz
MODULATION TYPE	QPSK	DETECTOR FUNCTION	Peak(PK) Average (AV)
TRANSFER RATE	12Mbps	ENVIRONMENTAL CONDITIONS	25deg. C, 75%RH, 991hPa
INPUT POWER (SYSTEM)	120Vac, 60 Hz	TESTED BY	Lori Chiu

ANTENNA POLARITY & TEST DISTANCE: HORIZONTAL AT 3 M								
No.	Freq. (MHz)	Emission Level (dBuV/m)	Limit (dBuV/m)	Margin (dB)	Antenna Height (m)	Table Angle (Degree)	Raw Value (dBuV)	Correction Factor (dB/m)
1	2320.00	57.06 PK	74.00	-16.94	1.02 H	214	25.91	31.15
1	2320.00	45.79 AV	54.00	-8.21	1.02 H	214	14.64	31.15
2	*2437.00	96.44 PK			2.01 H	200	64.90	31.54
2	*2437.00	87.62 AV			2.01 H	200	56.08	31.54
3	4874.00	45.34 PK	74.00	-28.66	1.25 H	328	8.05	37.29
3	4874.00	33.22 AV	54.00	-20.78	1.25 H	328	-4.07	37.29

ANTENNA POLARITY & TEST DISTANCE: VERTICAL AT 3 M								
No.	Freq. (MHz)	Emission Level (dBuV/m)	Limit (dBuV/m)	Margin (dB)	Antenna Height (m)	Table Angle (Degree)	Raw Value (dBuV)	Correction Factor (dB/m)
1	2320.00	59.68 PK	74.00	-14.32	1.00 V	156	28.53	31.15
1	2320.00	52.13 AV	54.00	-1.87	1.00 V	156	20.98	31.15
2	*2437.00	107.31 PK			1.17 V	114	75.77	31.54
2	*2437.00	97.34 AV			1.17 V	114	65.80	31.54
3	3248.00	49.55 PK	74.00	-24.45	1.10 V	213	16.36	33.19
3	3248.00	43.34 AV	54.00	-10.66	1.10 V	213	10.15	33.19
4	4874.00	47.24 PK	74.00	-26.76	1.12 V	19	9.95	37.29
4	4874.00	34.10 AV	54.00	-19.90	1.12 V	19	-3.19	37.29

- REMARKS:**
1. Emission level(dBuV/m)=Raw Value(dBuV) + Correction Factor(dB/m)
 2. Crection Factor(dB/m) = Antenna Factor (dB/m) + Cable Factor (dB)
 3. The other emission levels were very low against the limit.
 4. Margin value = Emission level – Limit value.
 5. “ * “ : Fundamental frequency.



4.3 6dB BANDWIDTH MEASUREMENT

4.3.1 LIMITS OF 6dB BANDWIDTH MEASUREMENT

The minimum of 6dB Bandwidth Measurement is 0.5 MHz.

4.3.2 TEST INSTRUMENTS

DESCRIPTION & MANUFACTURER	MODEL NO.	SERIAL NO.	CALIBRATED UNTIL
SPECTRUM ANALYZER	FSEK30	100049	Aug. 14, 2006

NOTE: The calibration interval of the above test instruments is 12 months and the calibrations are traceable to NML/ROC and NIST/USA.

4.3.3 TEST PROCEDURE

The transmitter output was connected to the spectrum analyzer through an attenuator. The bandwidth of the fundamental frequency was measured by spectrum analyzer with 100 kHz RBW and 100kHz VBW. The 6dB bandwidth is defined as the total spectrum the power of which is higher than peak power minus 6dB.

4.3.4 DEVIATION FROM TEST STANDARD

No deviation

4.3.5 TEST SETUP

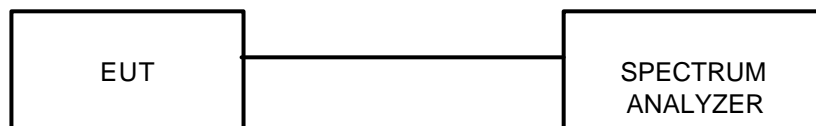

For the actual test configuration, please refer to the related Item – Photographs of the Test Configuration.

4.3.6 EUT OPERATING CONDITIONS

The software provided by client to enable the EUT under transmission condition continuously at lowest, middle and highest channel frequencies individually.



4.3.7 TEST RESULTS

802.11b DSSS MODULATION

MODULATION TYPE	BPSK	TRANSFER RATE	1Mbps
INPUT POWER (SYSTEM)	120Vac, 60 Hz	ENVIRONMENTAL CONDITIONS	22deg.C, 63%RH, 991hPa
TESTED BY	Long Chen		

CHANNEL	CHANNEL FREQUENCY (MHz)	6dB BANDWIDTH (MHz)	MINIMUM LIMIT (MHz)	PASS/FAIL
1	2412	12.60	0.5	PASS
6	2437	12.00	0.5	PASS
11	2462	12.04	0.5	PASS

CH1

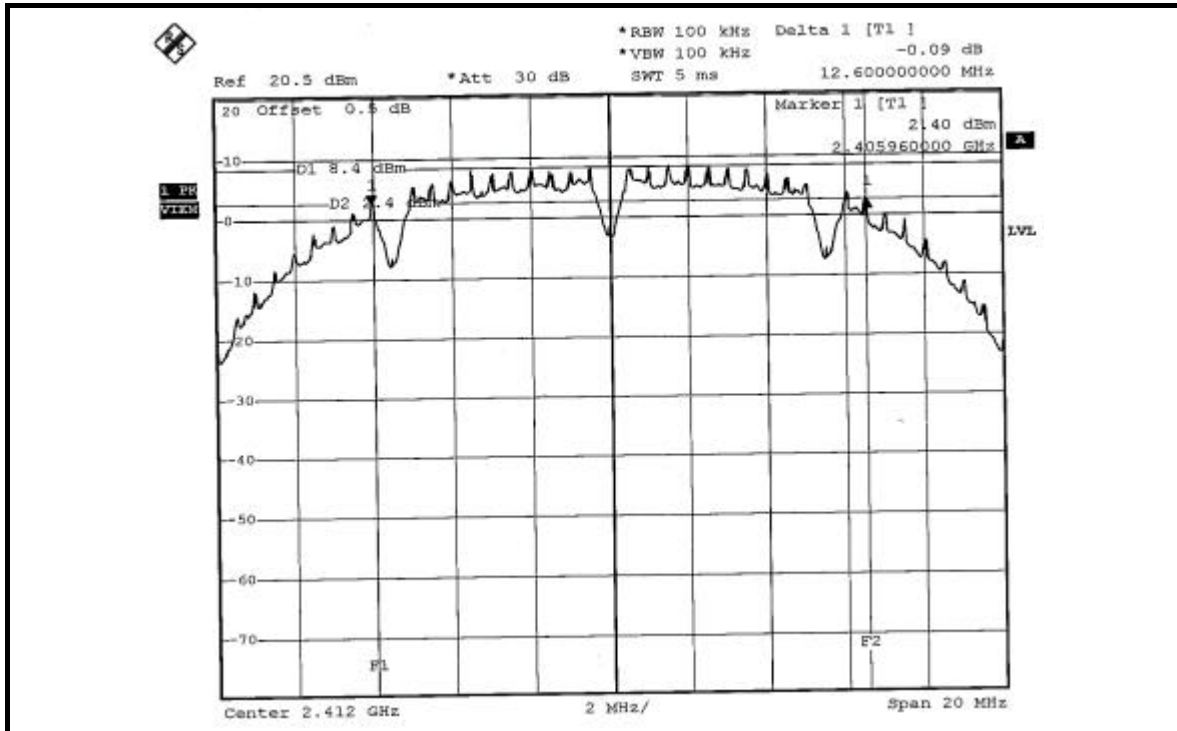

CH6

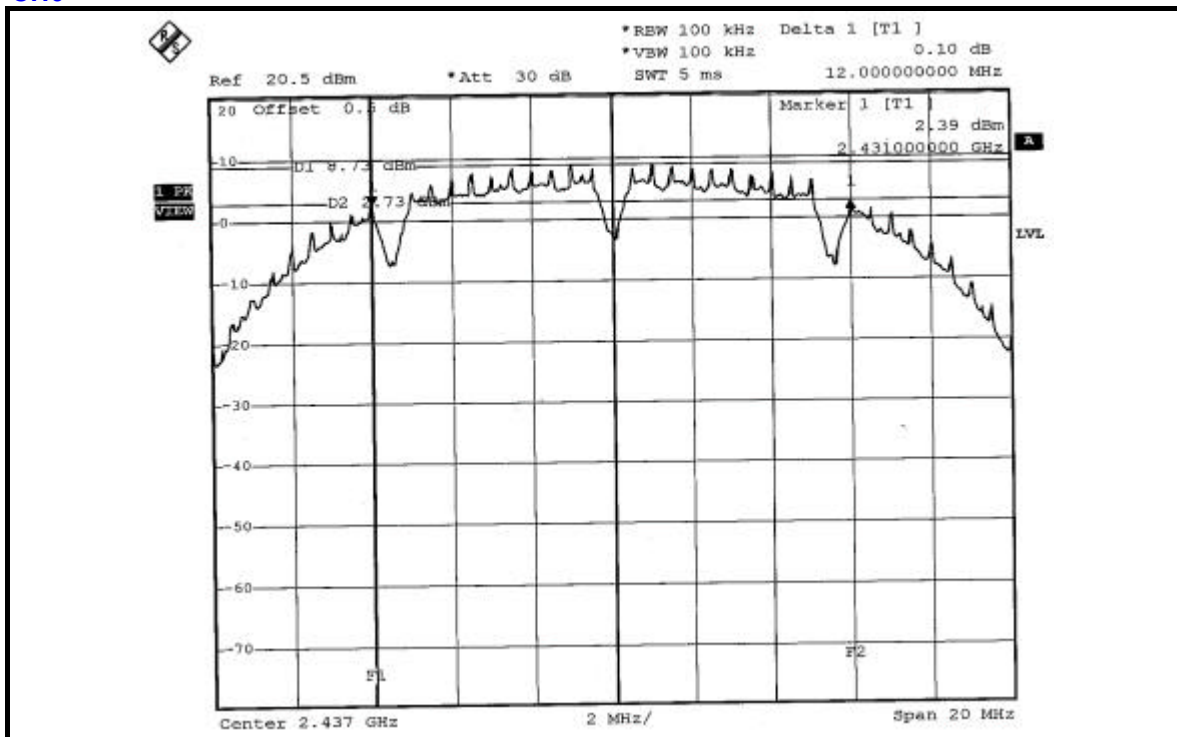

CH11

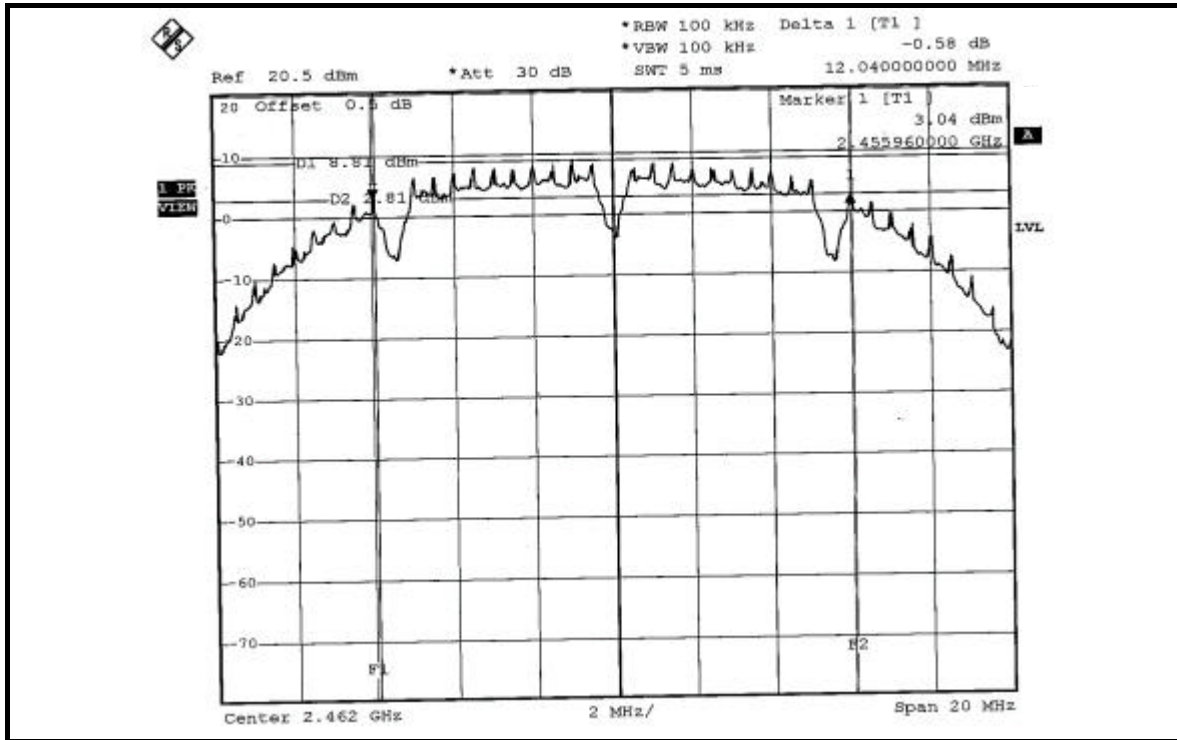



802.11g OFDM NORMAL MODULATION

MODULATION TYPE	BPSK	TRANSFER RATE	6Mbps
INPUT POWER (SYSTEM)	120Vac, 60 Hz	ENVIRONMENTAL CONDITIONS	22deg.C, 63%RH, 991hPa
TESTED BY	Long Chen		

CHANNEL	CHANNEL FREQUENCY (MHz)	6 dB BANDWIDTH (MHz)	MINIMUM LIMIT (MHz)	PASS/FAIL
1	2412	16.44	0.5	PASS
6	2437	16.40	0.5	PASS
11	2462	16.48	0.5	PASS

CH1

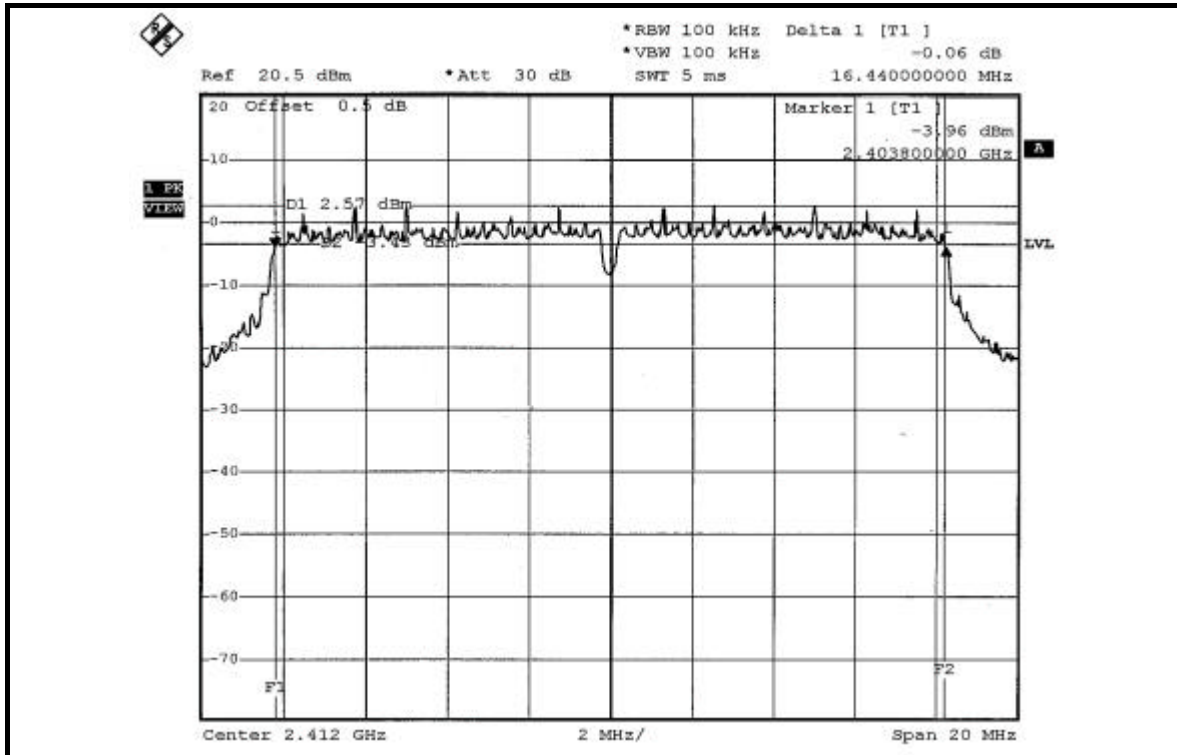

CH6

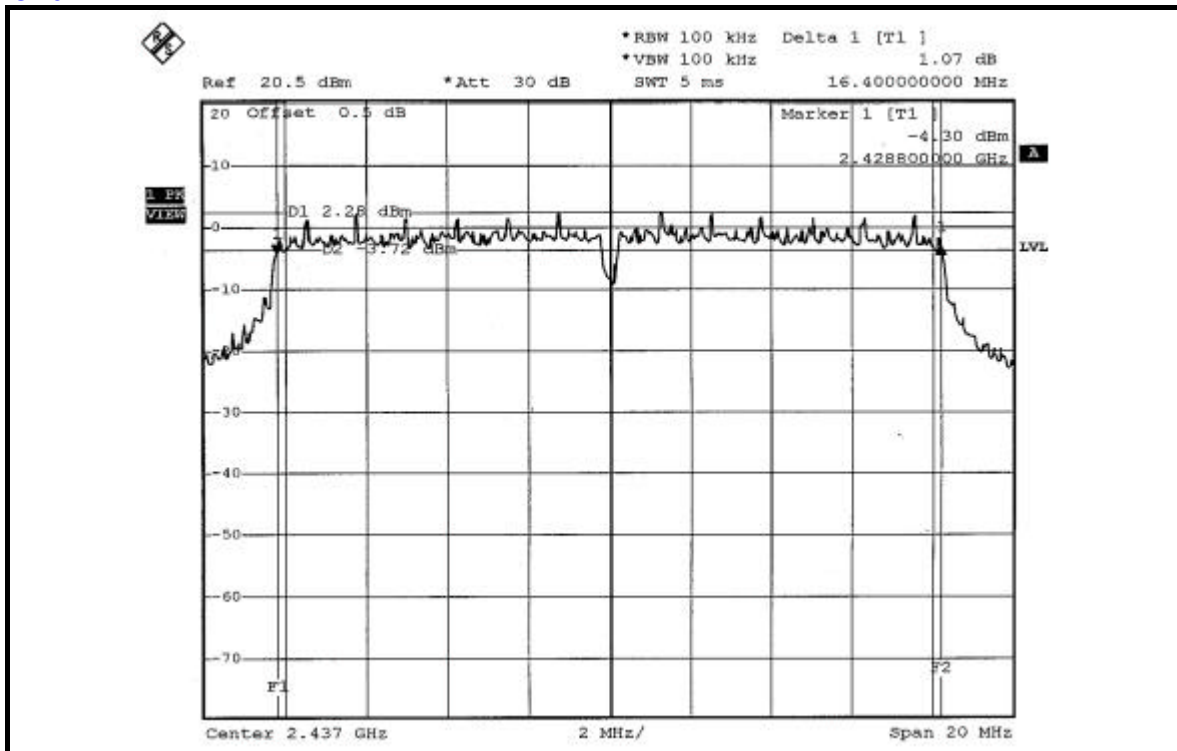

CH11

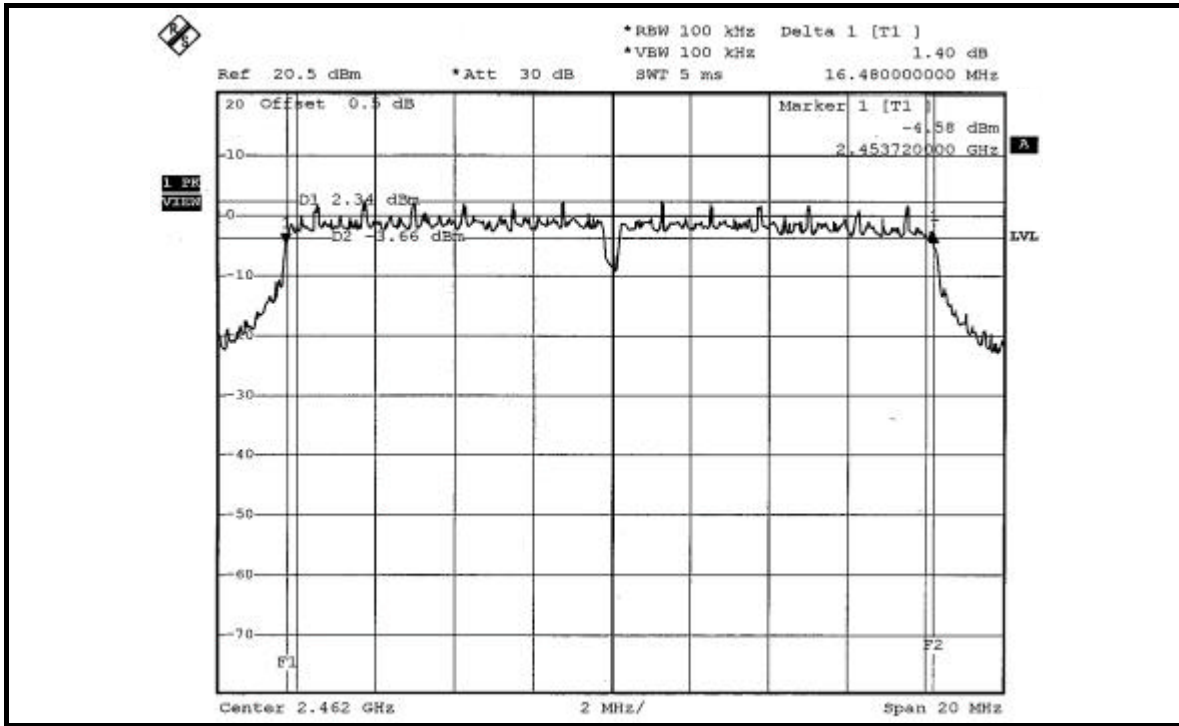



802.11g OFDM TURBO MODULATION

MODULATION TYPE	QPSK	TRANSFER RATE	12Mbps
INPUT POWER (SYSTEM)	120Vac, 60 Hz	ENVIRONMENTAL CONDITIONS	22deg.C, 63%RH, 991hPa
TESTED BY	Long Chen		

CHANNEL	CHANNEL FREQUENCY (MHz)	6 dB BANDWIDTH (MHz)	MINIMUM LIMIT (MHz)	PASS/FAIL
6	2437	32.48	0.5	PASS

CH6

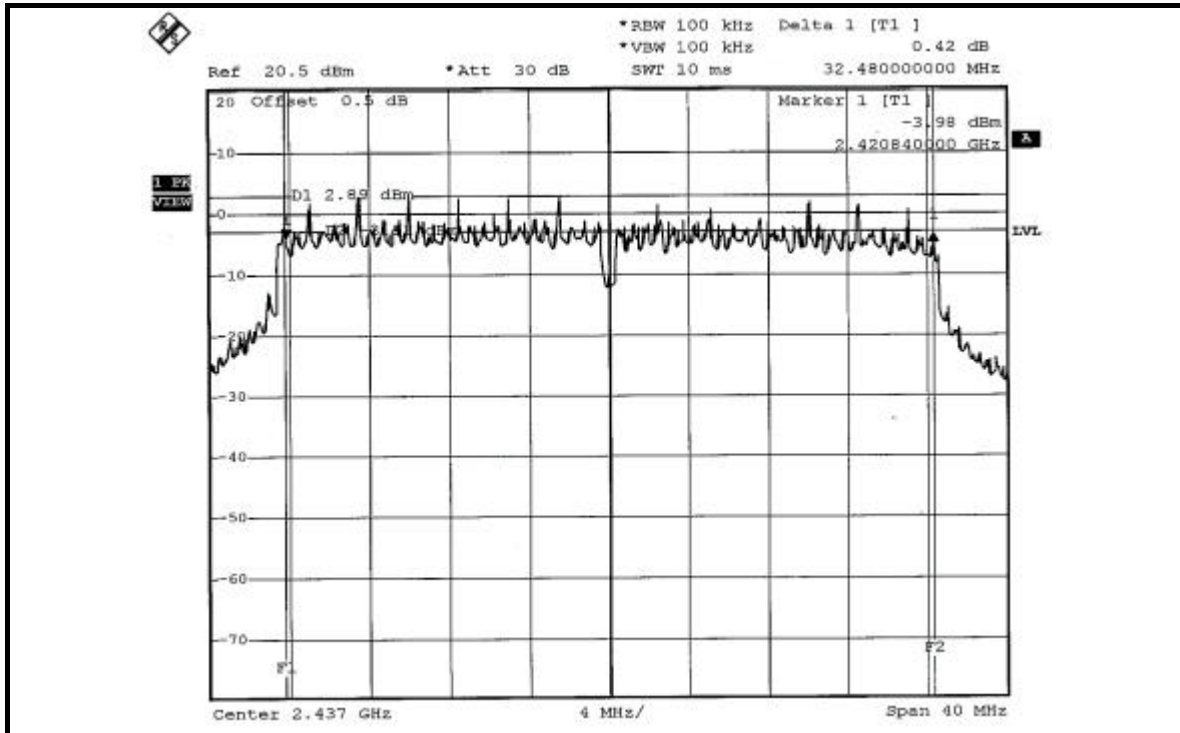



4.4 MAXIMUM PEAK OUTPUT POWER

4.4.1 LIMITS OF MAXIMUM PEAK OUTPUT POWER MEASUREMENT

The Maximum Peak Output Power Measurement is 30dBm. .

4.4.2 TEST INSTRUMENTS

DESCRIPTION & MANUFACTURER	MODEL NO.	SERIAL NO.	CALIBRATED UNTIL
R&S SPECTRUM ANALYZER	FSEK30	100049	Aug. 14, 2006
AGILENT SIGNAL GENERATOR	E8257C	MY43320668	Dec. 07, 2006
DIGITAL RT OSCILLOSCOPE	TDS1012	C037299	Nov. 28, 2006
NARDA DETECTOR	4503A	FSCM99899	NA

NOTE:

The calibration interval of the above test instruments is 12 months and the calibrations are traceable to NML/ROC and NIST/USA.

4.4.3 TEST PROCEDURES

1. A detector was used on the output port of the EUT. An oscilloscope was used to peak the response of the detector.
2. Replaced the EUT by the signal generator. The center frequency of the S.G was adjusted to the center frequency of the measured channel.
3. Adjusted the power to have the same peak reading on oscilloscope. Record the power level.

4.4.4 DEVIATION FROM TEST STANDARD

No deviation

4.4.5 TEST SETUP



4.4.6 EUT OPERATING CONDITIONS

Same as Item 4.3.6



4.4.7 TEST RESULTS

802.11b DSSS MODULATION

MODULATION TYPE	BPSK	TRANSFER RATE	1Mbps
INPUT POWER (SYSTEM)	120Vac, 60 Hz	ENVIRONMENTAL CONDITIONS	22deg.C, 63%RH, 991hPa
TESTED BY	Long Chen		

CHANNEL	CHANNEL FREQUENCY (MHz)	PEAK POWER OUTPUT (mW)	PEAK POWER OUTPUT (dBm)	PEAK POWER LIMIT (dBm)	PASS/FAIL
1	2412	79.799	19.02	30	PASS
6	2437	79.616	19.01	30	PASS
11	2462	80.168	19.04	30	PASS

802.11g OFDM NORMAL MODULATION

MODULATION TYPE	BPSK	TRANSFER RATE	6Mbps
INPUT POWER (SYSTEM)	120Vac, 60 Hz	ENVIRONMENTAL CONDITIONS	22deg.C, 63%RH, 991hPa
TESTED BY	Long Chen		

CHANNEL	CHANNEL FREQUENCY (MHz)	PEAK POWER OUTPUT (mW)	PEAK POWER OUTPUT (dBm)	PEAK POWER LIMIT (dBm)	PASS/FAIL
1	2412	63.680	18.04	30	PASS
6	2437	63.387	18.02	30	PASS
11	2462	63.680	18.04	30	PASS



802.11g OFDM TURBO MODULATION

MODULATION TYPE	QPSK	TRANSFER RATE	12Mbps
INPUT POWER (SYSTEM)	120Vac, 60 Hz	ENVIRONMENTAL CONDITIONS	22deg.C, 63%RH, 991hPa
TESTED BY	Long Chen		

CHANNEL	CHANNEL FREQUENCY (MHz)	PEAK POWER OUTPUT (mW)	PEAK POWER OUTPUT (dBm)	PEAK POWER LIMIT (dBm)	PASS/FAIL
6	2437	63.241	18.01	30	PASS



4.5 POWER SPECTRAL DENSITY MEASUREMENT

4.5.1 LIMITS OF POWER SPECTRAL DENSITY MEASUREMENT

The Maximum of Power Spectral Density Measurement is 8dBm.

4.5.2 TEST INSTRUMENTS

DESCRIPTION & MANUFACTURER	MODEL NO.	SERIAL NO.	CALIBRATED UNTIL
SPECTRUM ANALYZER	FSEK30	100049	Aug. 14, 2006

NOTE: The calibration interval of the above test instruments is 12 months and the calibrations are traceable to NML/ROC and NIST/USA.

4.5.3 TEST PROCEDURE

The transmitter output was connected to the spectrum analyzer through an attenuator, the bandwidth of the fundamental frequency was measured with the spectrum analyzer using 3kHz RBW and 30kHz VBW, set sweep time=span/3kHz. The power spectral density was measured and recorded. The sweep time is allowed to be longer than span/3kHz for a full response of the mixer in the spectrum analyzer.

4.5.4 DEVIATION FROM TEST STANDARD

No deviation

4.5.5 TEST SETUP

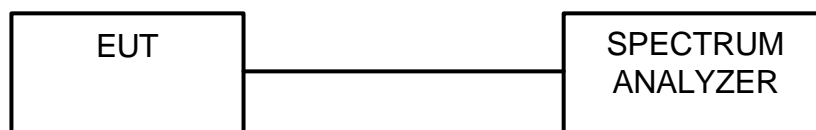

4.5.6 EUT OPERATING CONDITIONS

Same as 4.3.6