

Antenna 3 : 3CWE596  
Antenna cable A : 3CWE580

**Test Mode: 802.11n HT20 operating mode**

Channel	Measurement Freq.Band (MHz)	Detector	The Max. Field Strength in Restrict Band (dBuV/m)	Limit @ 3 m (dBuV/m)	Margin (dB)
1 (lowest)	2310-2390	PK	68.15	74	-5.85
		AV	53.15	54	-0.85
11 (highest)	2483.5-2500	PK	71.22	74	-2.78
		AV	53.43	54	-0.57

**Test Mode: 802.11n HT40 operating mode**

Channel	Measurement Freq.Band (MHz)	Detector	The Max. Field Strength in Restrict Band (dBuV/m)	Limit @ 3 m (dBuV/m)	Margin (dB)
3 (lowest)	2310-2390	PK	69.17	74	-4.83
		AV	53.58	54	-0.42
9 (highest)	2483.5-2500	PK	70.84	74	-3.16
		AV	53.31	54	-0.69

Antenna 4 : 3CWE598  
Antenna cable A : 3CWE580

**Test Mode: 802.11b operating mode**

Channel	Measurement Freq.Band (MHz)	Detector	The Max. Field Strength in Restrict Band (dBuV/m)	Limit @ 3 m (dBuV/m)	Margin (dB)
1 (lowest)	2310-2390	PK	58.86	74	-15.14
		AV	47.83	54	-6.17
11 (highest)	2483.5-2500	PK	58.26	74	-15.74
		AV	47.14	54	-6.86

**Test Mode: 802.11g operating mode**

Channel	Measurement Freq.Band (MHz)	Detector	The Max. Field Strength in Restrict Band (dBuV/m)	Limit @ 3 m (dBuV/m)	Margin (dB)
1 (lowest)	2310-2390	PK	71.06	74	-2.94
		AV	52.71	54	-1.29
11 (highest)	2483.5-2500	PK	71.02	74	-2.98
		AV	52.77	54	-1.23

Antenna 4 : 3CWE598  
Antenna cable A : 3CWE580

**Test Mode: 802.11n HT20 operating mode**

Channel	Measurement Freq.Band (MHz)	Detector	The Max. Field Strength in Restrict Band (dBuV/m)	Limit @ 3 m (dBuV/m)	Margin (dB)
1 (lowest)	2310-2390	PK	72.46	74	-1.54
		AV	52.68	54	-1.32
11 (highest)	2483.5-2500	PK	72.13	74	-1.87
		AV	52.01	54	-1.99

**Test Mode: 802.11n HT40 operating mode**

Channel	Measurement Freq.Band (MHz)	Detector	The Max. Field Strength in Restrict Band (dBuV/m)	Limit @ 3 m (dBuV/m)	Margin (dB)
3 (lowest)	2310-2390	PK	72.95	74	-1.05
		AV	52.50	54	-1.50
9 (highest)	2483.5-2500	PK	71.54	74	-2.46
		AV	49.97	54	-4.03

**Antenna 5 : MCM2458PTRPSM**

**Test Mode: 802.11b operating mode**

Channel	Measurement Freq.Band (MHz)	Detector	The Max. Field Strength in Restrict Band (dBuV/m)	Limit @ 3 m (dBuV/m)	Margin (dB)
1 (lowest)	2310-2390	PK	60.68	74	-13.32
		AV	51.07	54	-2.93
11 (highest)	2483.5-2500	PK	61.37	74	-12.63
		AV	50.33	54	-3.67

**Test Mode: 802.11g operating mode**

Channel	Measurement Freq.Band (MHz)	Detector	The Max. Field Strength in Restrict Band (dBuV/m)	Limit @ 3 m (dBuV/m)	Margin (dB)
1 (lowest)	2310-2390	PK	69.67	74	-4.33
		AV	52.26	54	-1.74
11 (highest)	2483.5-2500	PK	67.90	74	-6.10
		AV	50.55	54	-3.45

**Antenna 5 : MCM2458PTRPSM**

**Test Mode: 802.11n HT20 operating mode**

Channel	Measurement Freq.Band (MHz)	Detector	The Max. Field Strength in Restrict Band (dBuV/m)	Limit @ 3 m (dBuV/m)	Margin (dB)
1 (lowest)	2310-2390	PK	70.09	74	-3.91
		AV	52.60	54	-1.40
11 (highest)	2483.5-2500	PK	69.40	74	-4.60
		AV	51.35	54	-2.65

**Test Mode: 802.11n HT40 operating mode**

Channel	Measurement Freq.Band (MHz)	Detector	The Max. Field Strength in Restrict Band (dBuV/m)	Limit @ 3 m (dBuV/m)	Margin (dB)
3 (lowest)	2310-2390	PK	69.51	74	-4.49
		AV	51.34	54	-2.66
9 (highest)	2483.5-2500	PK	68.25	74	-5.75
		AV	51.50	54	-2.50

**Antenna 6 : TQJ-24/58MICX6**

**Test Mode: 802.11b operating mode**

Channel	Measurement Freq.Band (MHz)	Detector	The Max. Field Strength in Restrict Band (dBuV/m)	Limit @ 3 m (dBuV/m)	Margin (dB)
1 (lowest)	2310-2390	PK	61.78	74	-12.22
		AV	50.84	54	-3.16
11 (highest)	2483.5-2500	PK	61.66	74	-12.34
		AV	49.95	54	-4.05

**Test Mode: 802.11g operating mode**

Channel	Measurement Freq.Band (MHz)	Detector	The Max. Field Strength in Restrict Band (dBuV/m)	Limit @ 3 m (dBuV/m)	Margin (dB)
1 (lowest)	2310-2390	PK	67.19	74	-6.81
		AV	51.64	54	-2.36
11 (highest)	2483.5-2500	PK	65.12	74	-8.88
		AV	51.45	54	-2.55

**Antenna 6 : TQJ-24/58MICX6**

**Test Mode: 802.11n HT20 operating mode**

Channel	Measurement Freq.Band (MHz)	Detector	The Max. Field Strength in Restrict Band (dBuV/m)	Limit @ 3 m (dBuV/m)	Margin (dB)
1 (lowest)	2310-2390	PK	71.13	74	-2.87
		AV	50.80	54	-3.20
11 (highest)	2483.5-2500	PK	68.35	74	-5.65
		AV	52.16	54	-1.84

**Test Mode: 802.11n HT40 operating mode**

Channel	Measurement Freq.Band (MHz)	Detector	The Max. Field Strength in Restrict Band (dBuV/m)	Limit @ 3 m (dBuV/m)	Margin (dB)
3 (lowest)	2310-2390	PK	69.72	74	-4.28
		AV	51.85	54	-2.15
9 (highest)	2483.5-2500	PK	68.52	74	-5.48
		AV	51.71	54	-2.29

**Antenna 7 : TQJ-2458MIKX3**

**Test Mode: 802.11b operating mode**

Channel	Measurement Freq.Band (MHz)	Detector	The Max. Field Strength in Restrict Band (dBuV/m)	Limit @ 3 m (dBuV/m)	Margin (dB)
1 (lowest)	2310-2390	PK	61.54	74	-12.46
		AV	50.58	54	-3.42
11 (highest)	2483.5-2500	PK	60.78	74	-13.22
		AV	50.37	54	-3.63

**Test Mode: 802.11g operating mode**

Channel	Measurement Freq.Band (MHz)	Detector	The Max. Field Strength in Restrict Band (dBuV/m)	Limit @ 3 m (dBuV/m)	Margin (dB)
1 (lowest)	2310-2390	PK	67.97	74	-6.03
		AV	50.29	54	-3.71
11 (highest)	2483.5-2500	PK	66.92	74	-7.08
		AV	51.56	54	-2.44



**Antenna 7 : TQJ-2458MIKX3**

**Test Mode: 802.11n HT20 operating mode**

Channel	Measurement Freq.Band (MHz)	Detector	The Max. Field Strength in Restrict Band (dBuV/m)	Limit @ 3 m (dBuV/m)	Margin (dB)
1 (lowest)	2310-2390	PK	67.11	74	-6.89
		AV	51.49	54	-2.51
11 (highest)	2483.5-2500	PK	71.94	74	-2.06
		AV	52.37	54	-1.63

**Test Mode: 802.11n HT40 operating mode**

Channel	Measurement Freq.Band (MHz)	Detector	The Max. Field Strength in Restrict Band (dBuV/m)	Limit @ 3 m (dBuV/m)	Margin (dB)
3 (lowest)	2310-2390	PK	68.92	74	-5.08
		AV	51.47	54	-2.53
9 (highest)	2483.5-2500	PK	66.48	74	-7.52
		AV	51.12	54	-2.88

Please see the plot below.

**Antenna 1 : C5060-510002-A**

**Band edge @ 802.11b mode channel 1 PK**

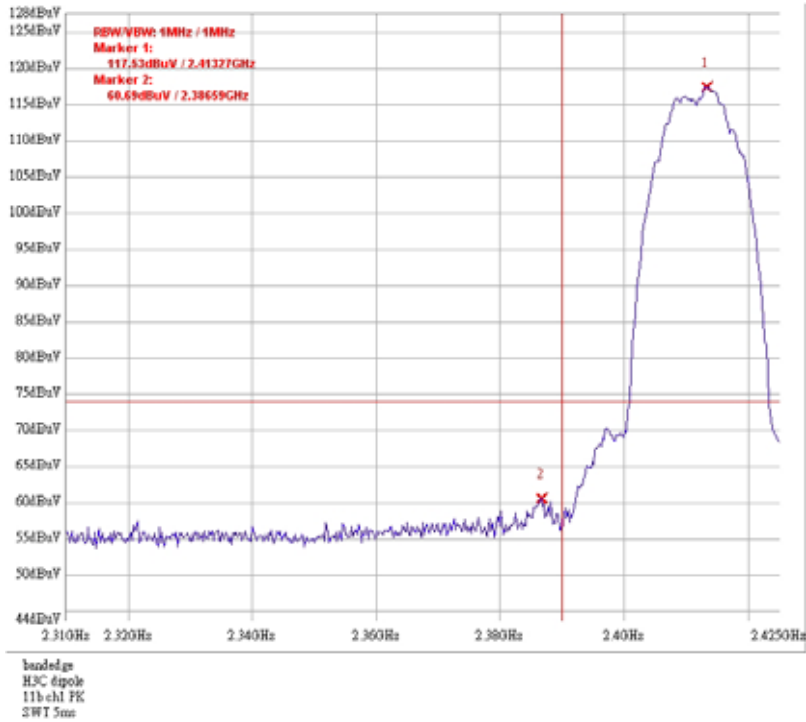

**Band edge @ 802.11b mode channel 1 AV**

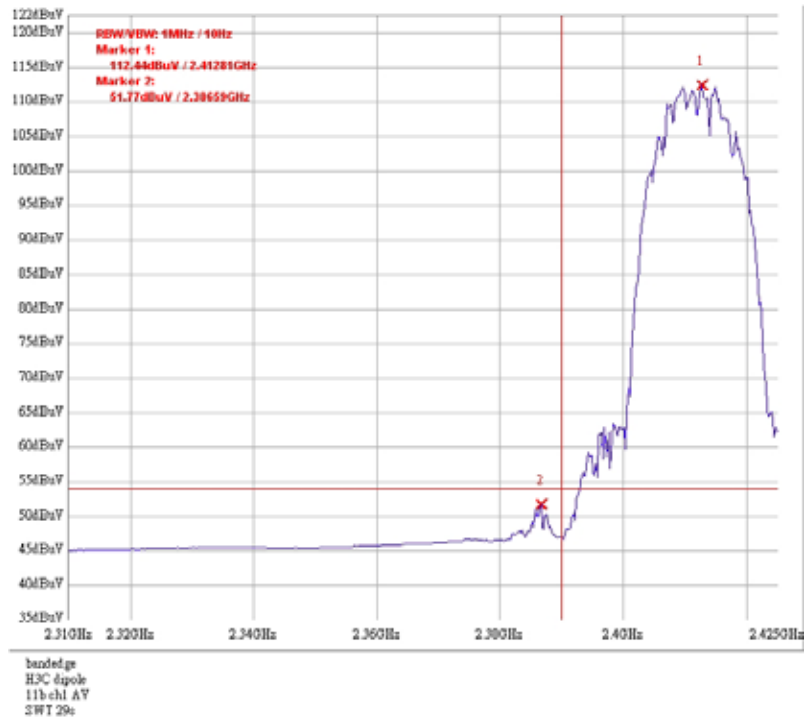

**Antenna 1 : C5060-510002-A**

**Band edge @ 802.11b mode channel 11 PK**

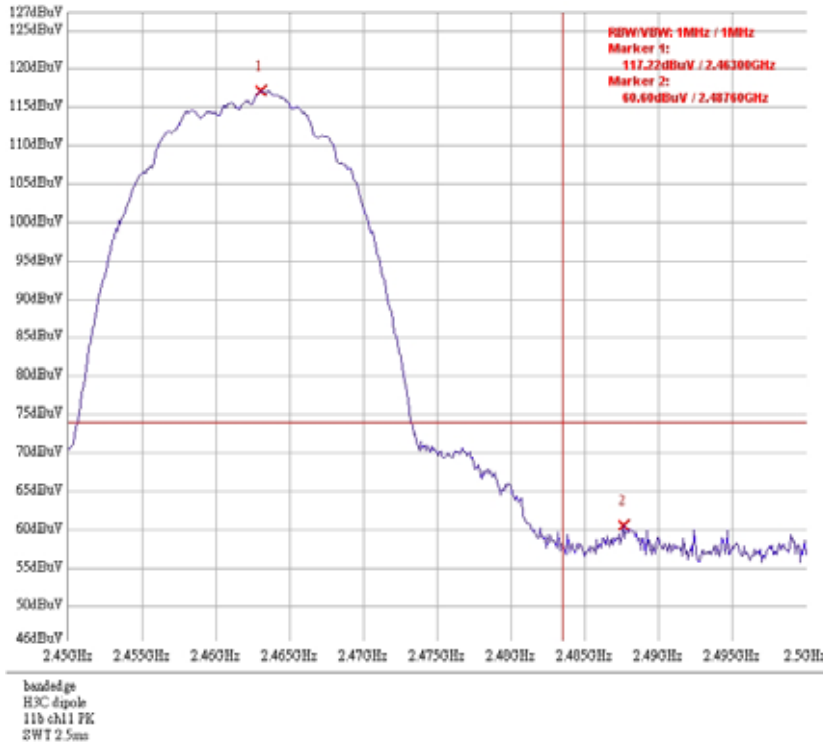

**Band edge @ 802.11b mode channel 11 AV**

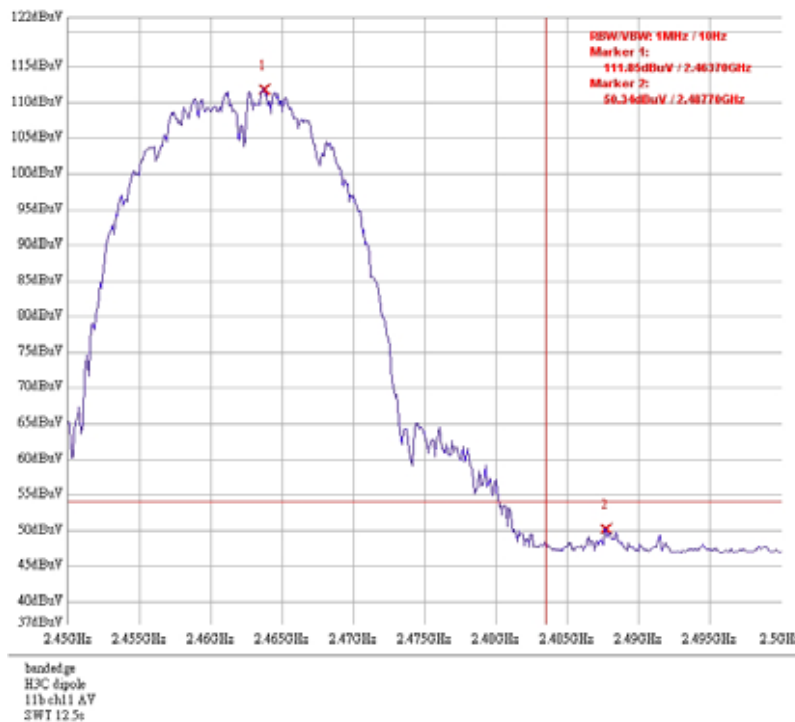

**Antenna 1 : C5060-510002-A**

**Band edge @ 802.11g mode channel 1 PK**

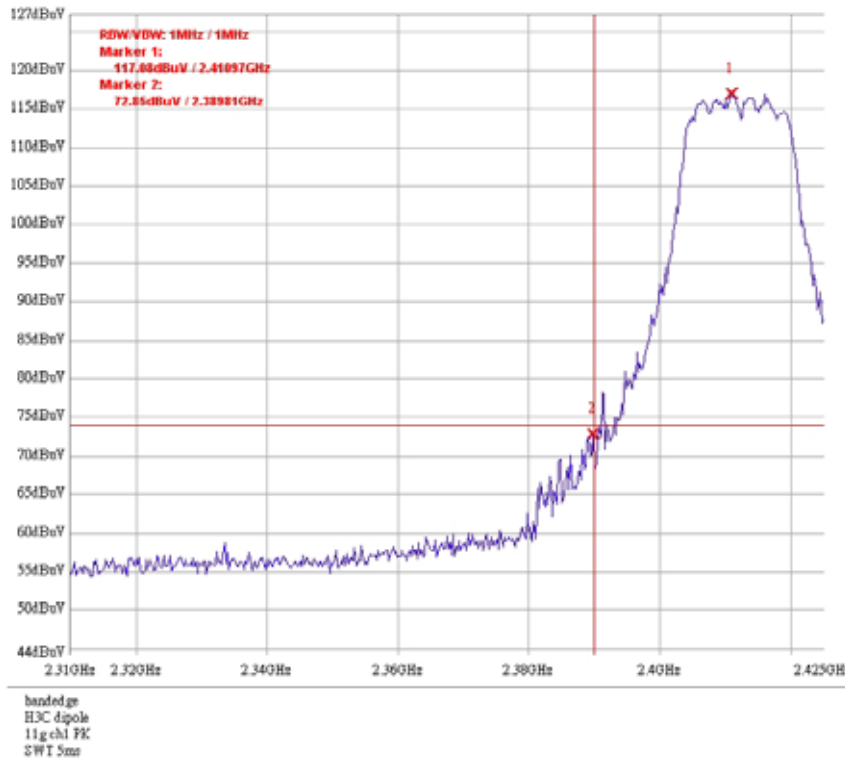

**Band edge @ 802.11g mode channel 1 AV**

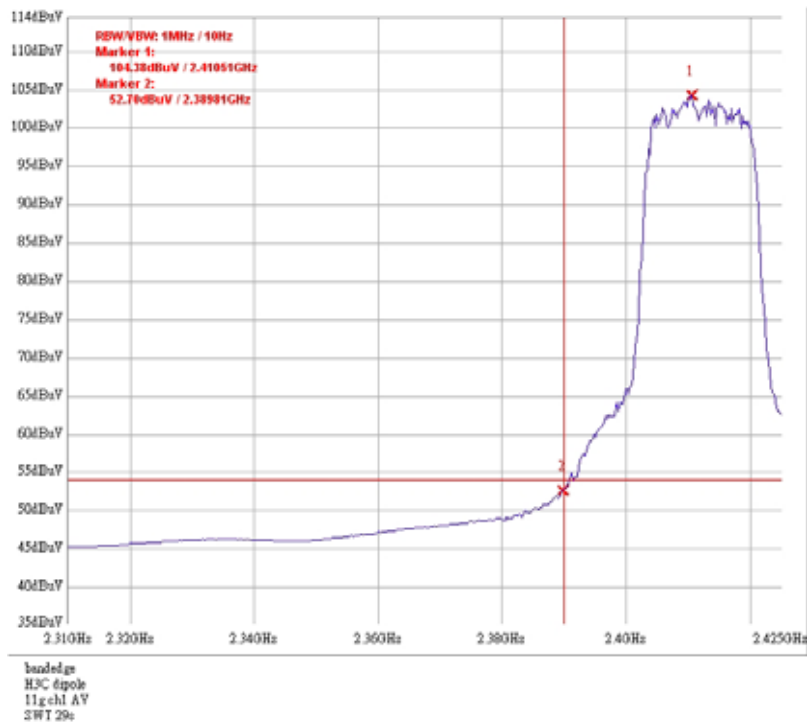

**Antenna 1 : C5060-510002-A**

**Band edge @ 802.11g mode channel 11 PK**

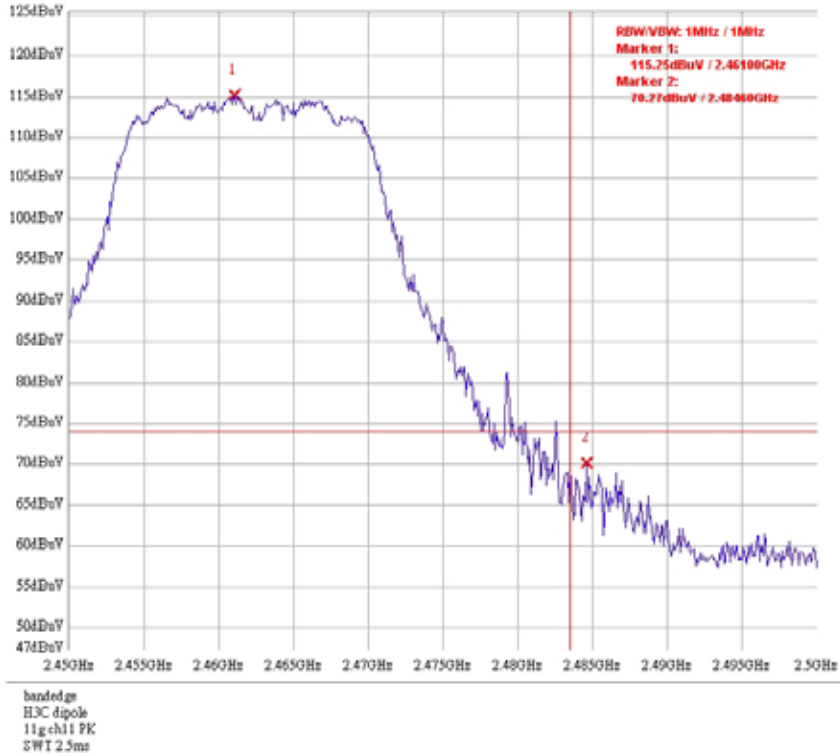

**Band edge @ 802.11g mode channel 11 AV**

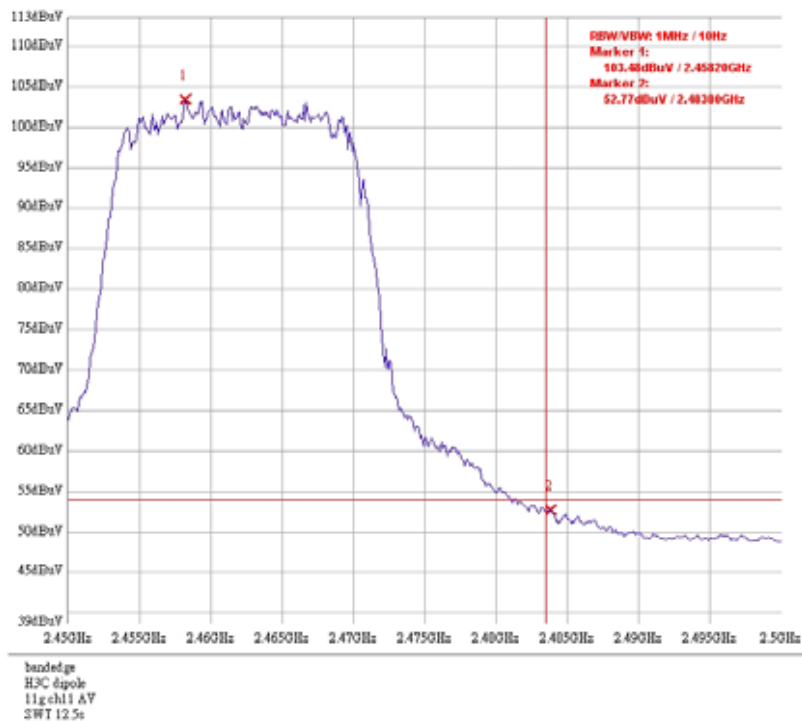

**Antenna 1 : C5060-510002-A**

**Band edge @802.11n HT20 mode channel 1 PK**

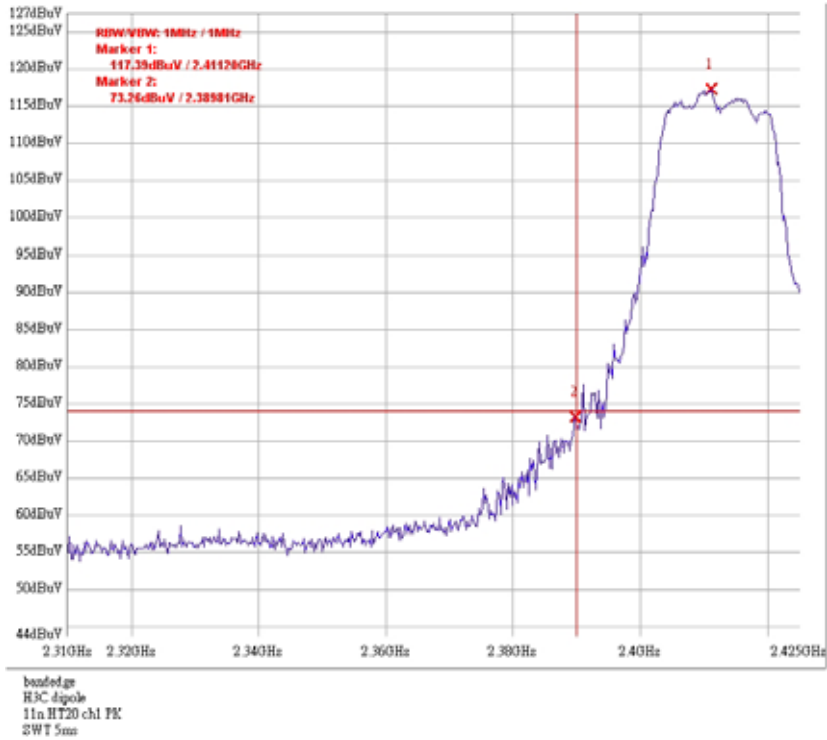

**Band edge @802.11n HT20 mode channel 1 AV**

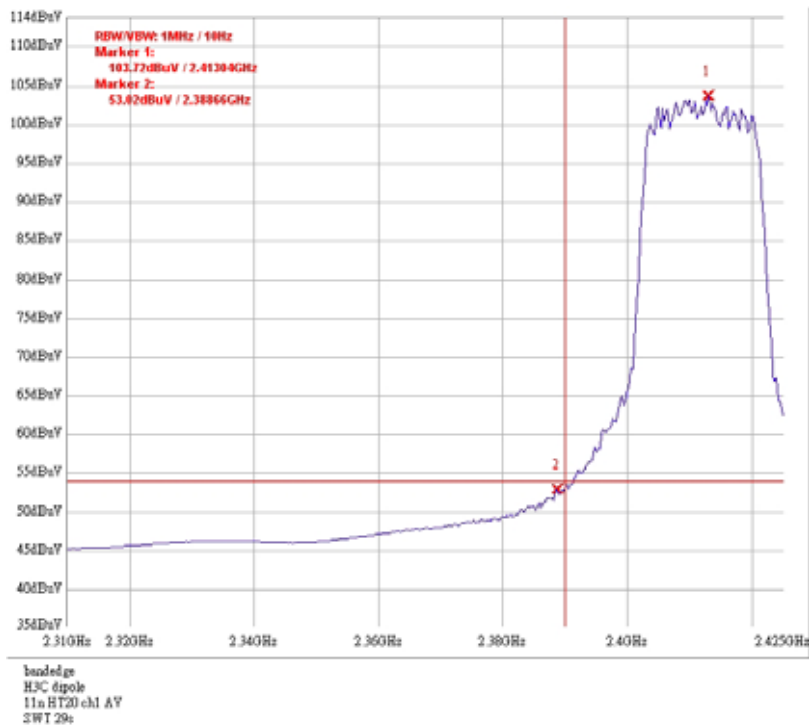

**Antenna 1 : C5060-510002-A**

**Band edge @802.11n HT20 mode channel 11 PK**

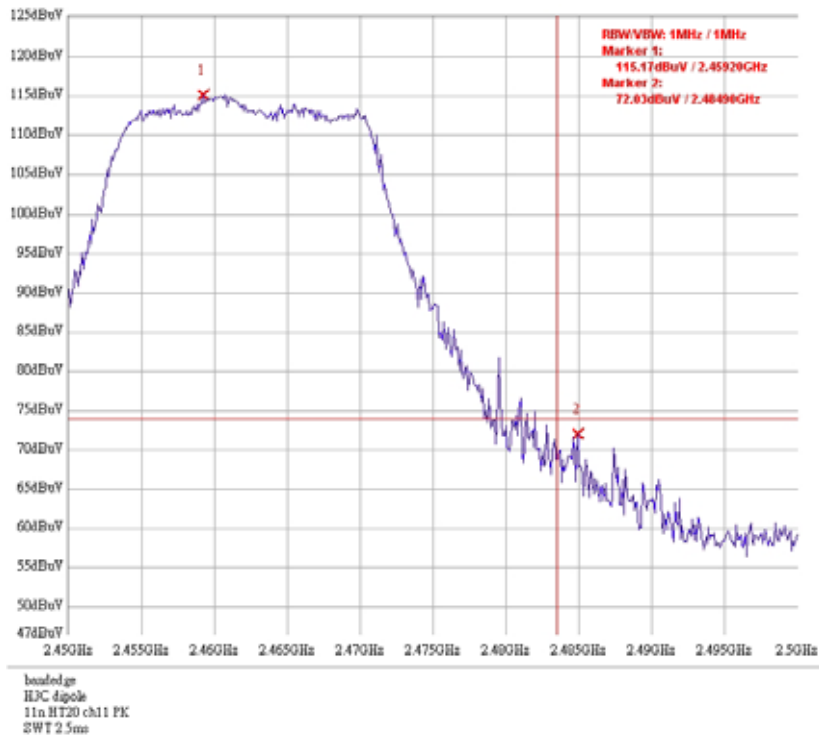

**Band edge @802.11n HT20 mode channel 11 AV**

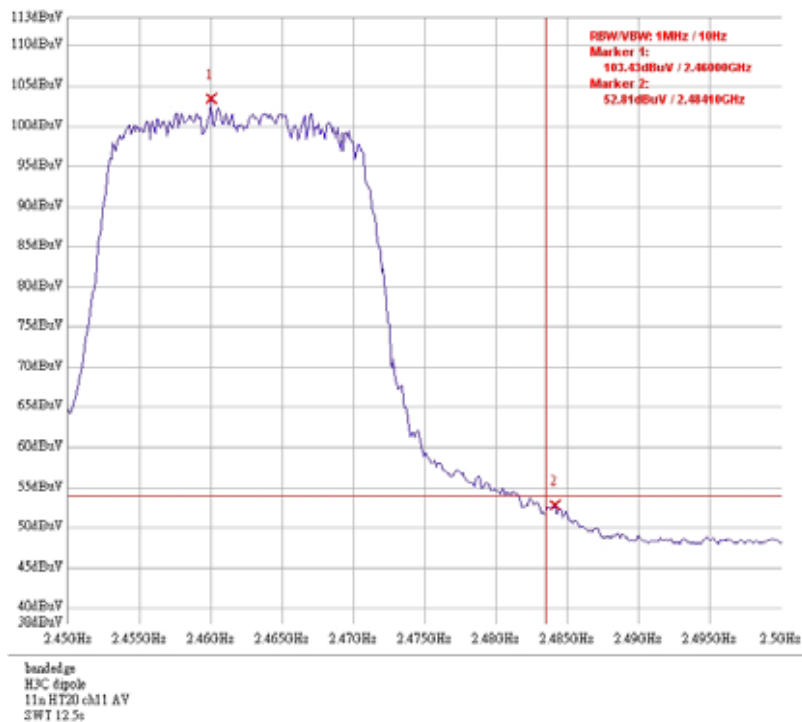

**Antenna 1 : C5060-510002-A**

**Band edge @802.11n HT40 mode channel 3 PK**

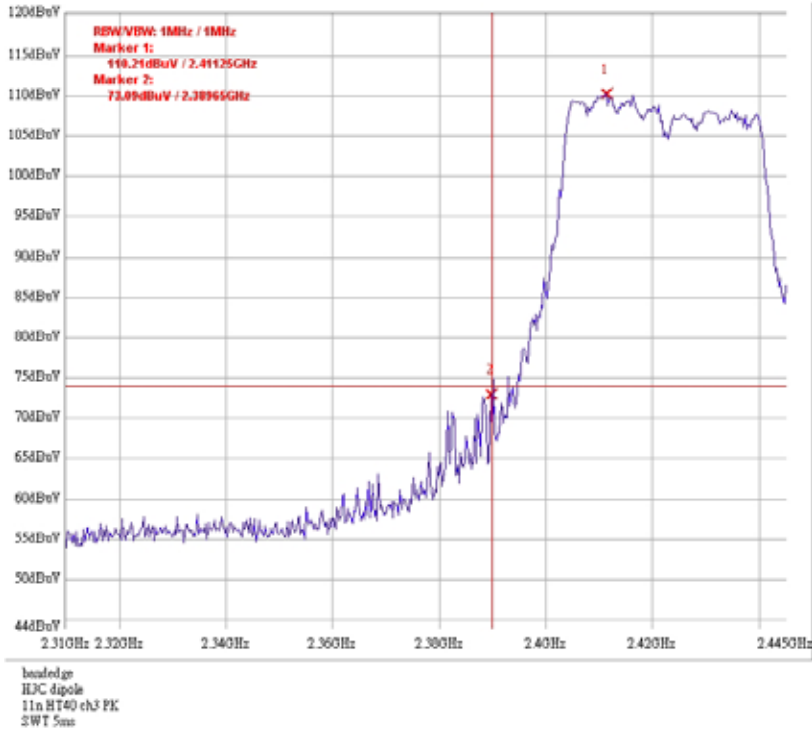

**Band edge @802.11n HT40 mode channel 3 AV**

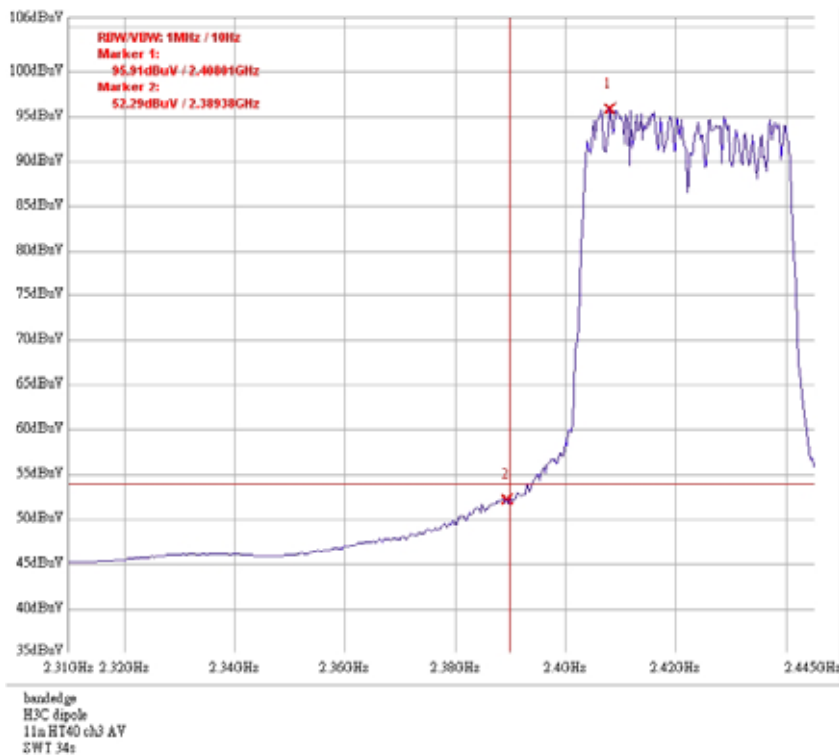



**Antenna 1 : C5060-510002-A**

Band edge @802.11n HT40 mode channel 9 PK

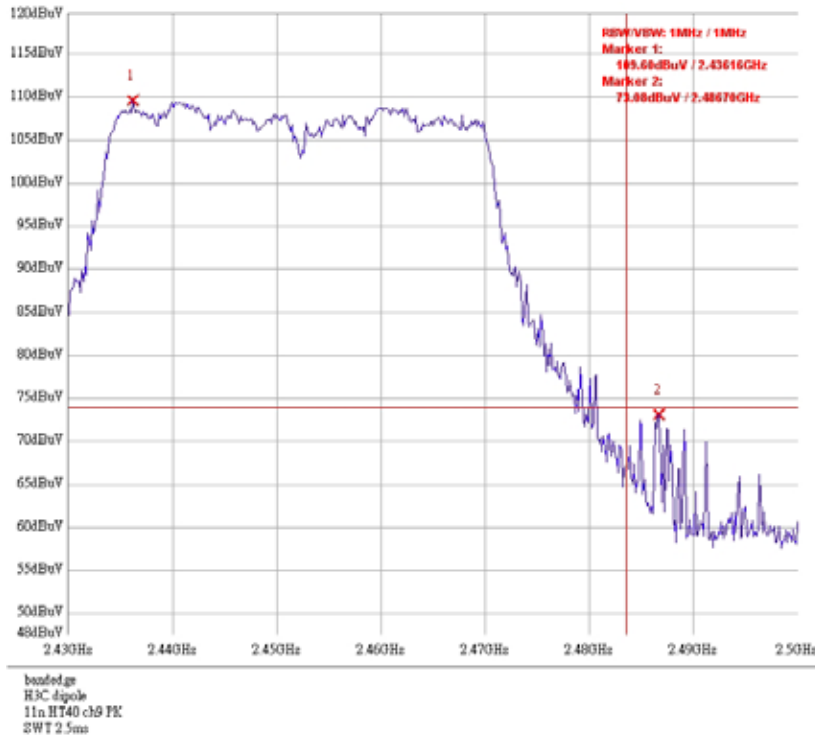

Band edge @802.11n HT40 mode channel 9 AV

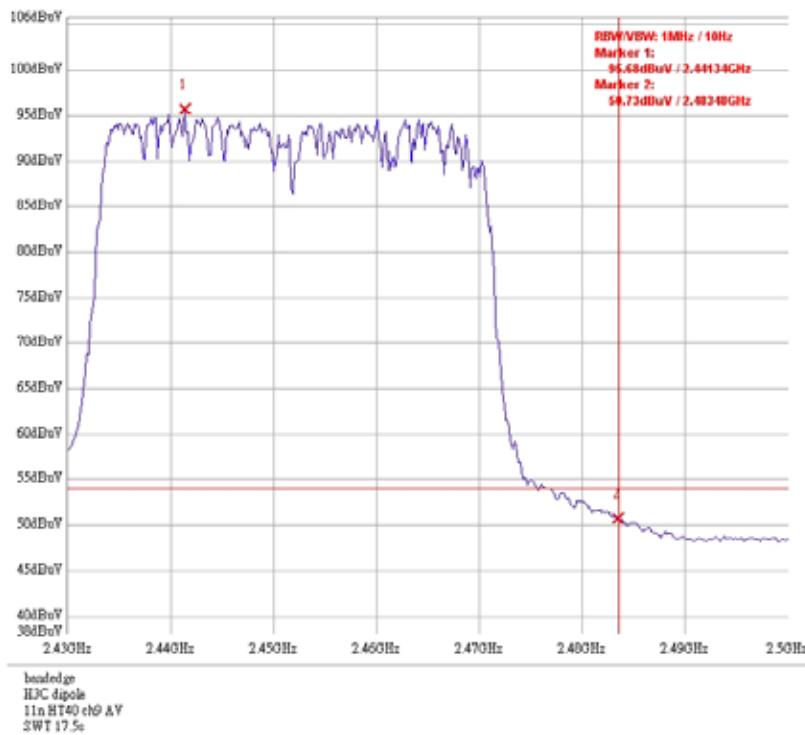

**Antenna 2 : 3CWE591**

**Antenna cable A : 3CWE580**

**Band edge @ 802.11b mode channel 1 PK**

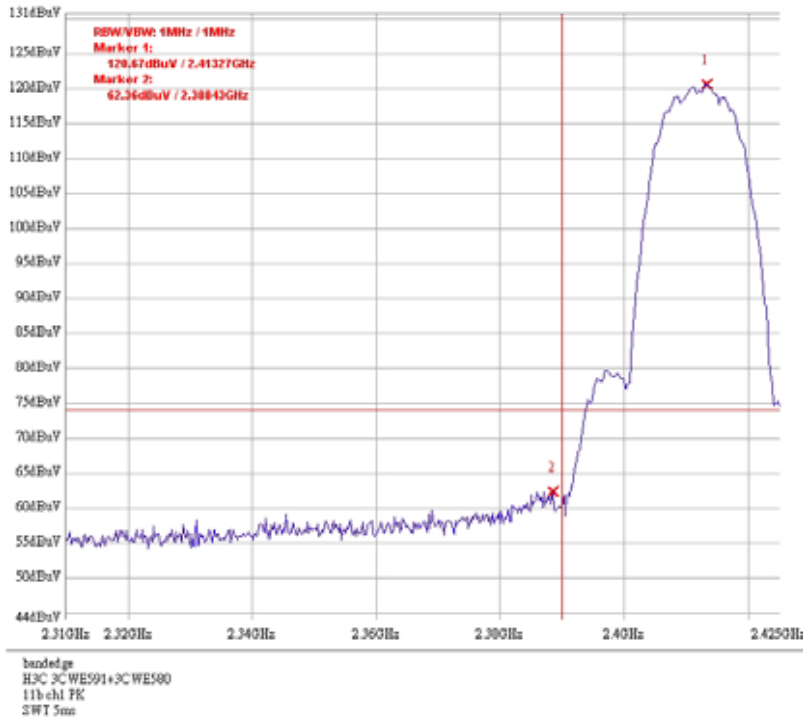

**Band edge @ 802.11b mode channel 1 AV**

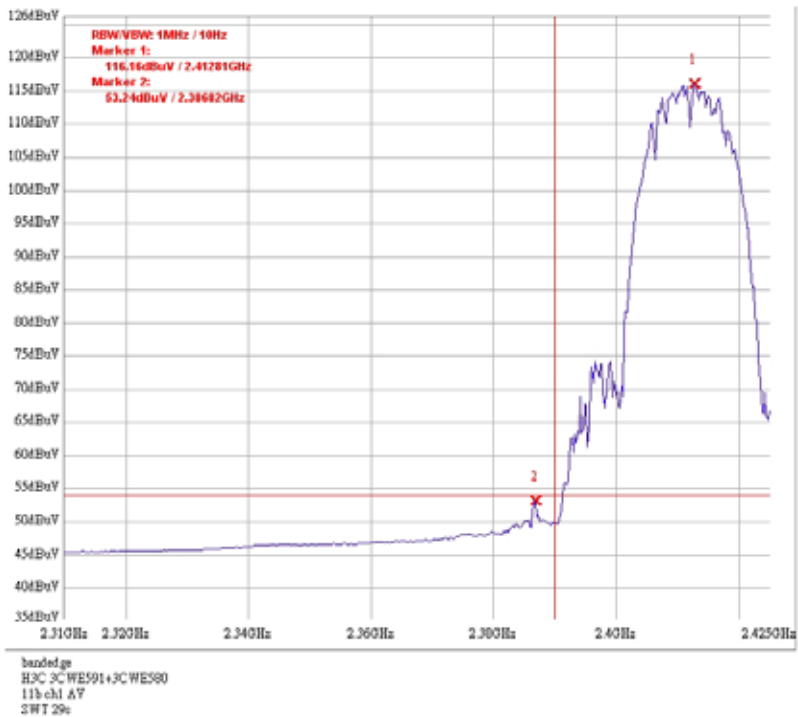

**Antenna 2 : 3CWE591**  
**Antenna cable A : 3CWE580**

**Band edge @ 802.11b mode channel 11 PK**

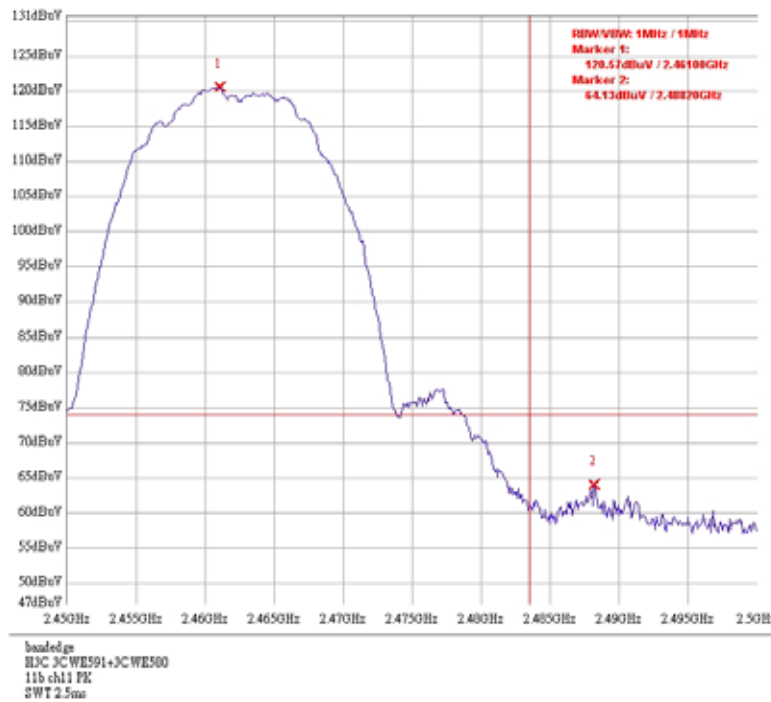

**Band edge @ 802.11b mode channel 11 AV**

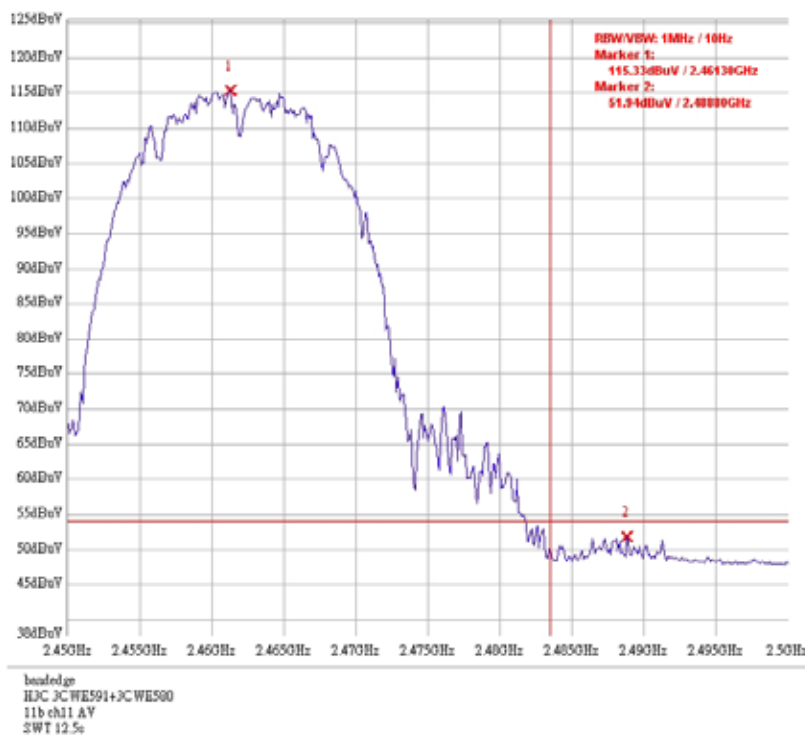

Antenna 2 : 3CWE591  
Antenna cable A : 3CWE580

Band edge @ 802.11g mode channel 1 PK

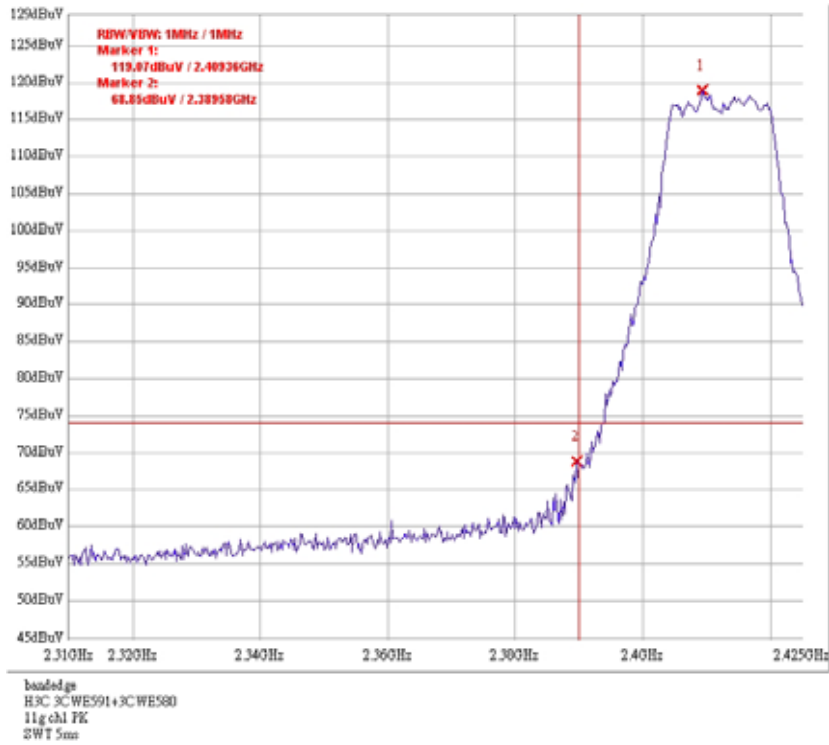

Band edge @ 802.11g mode channel 1 AV

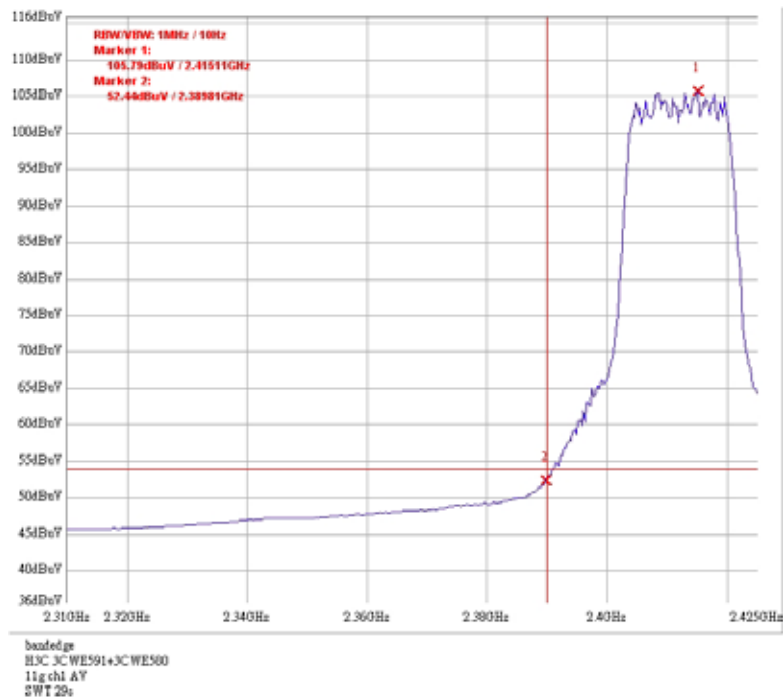

**Antenna 2 : 3CWE591**  
**Antenna cable : 3CWE580**

**Band edge @ 802.11g mode channel 11 PK**

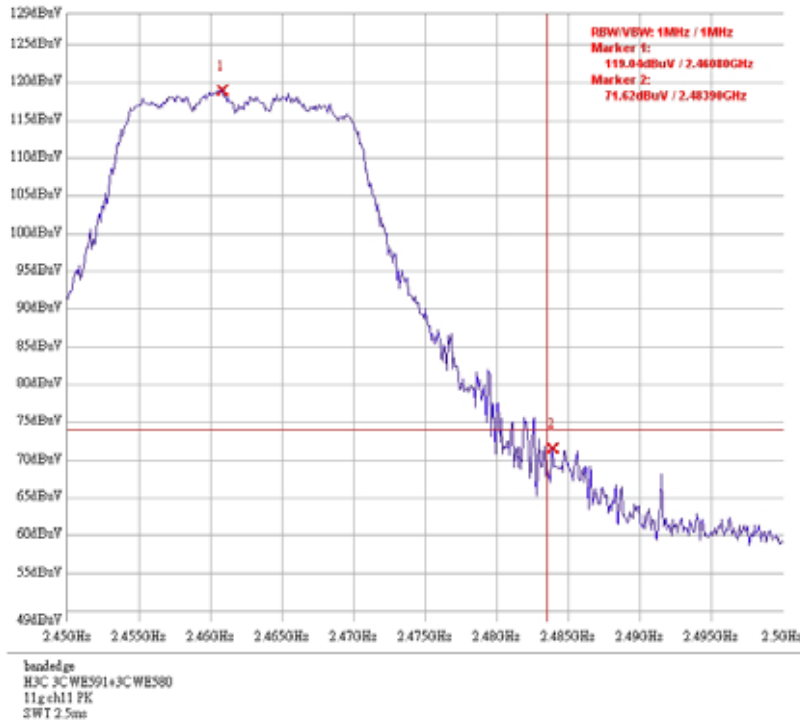

**Band edge @ 802.11g mode channel 11 AV**

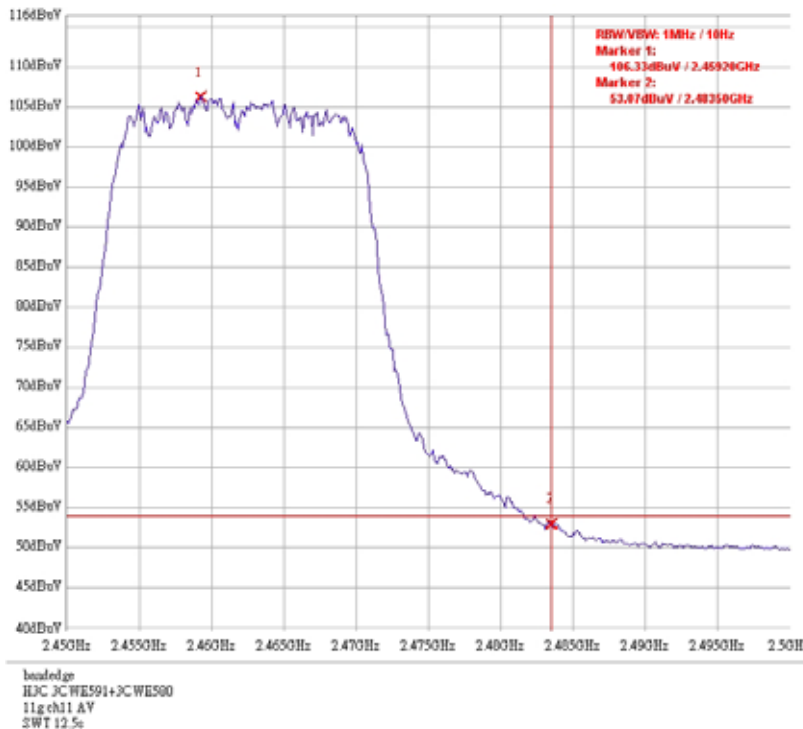

**Antenna 2 : 3CWE591**  
**Antenna cable A : 3CWE580**

Band edge @802.11n HT20 mode channel 1 PK

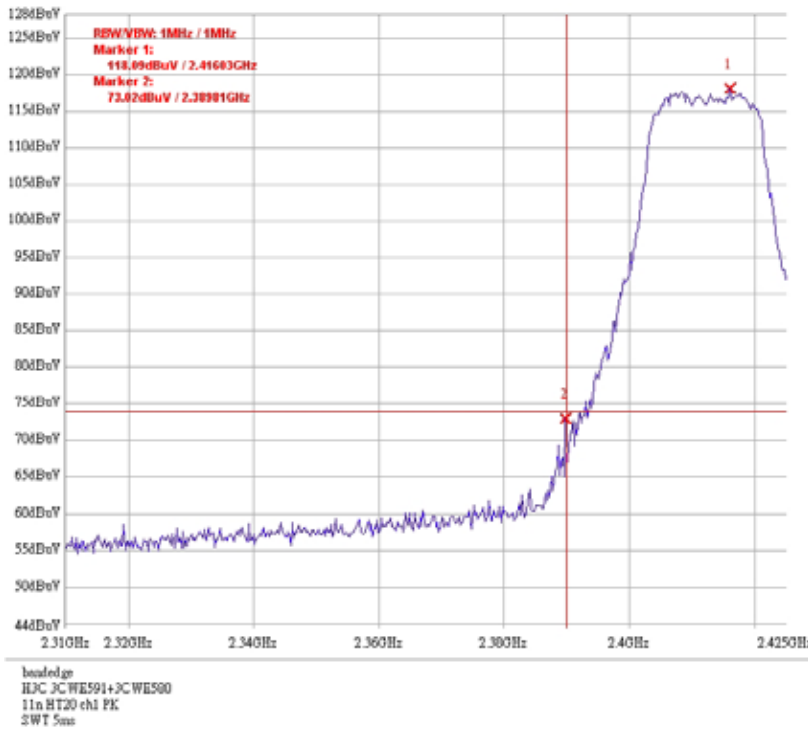

Band edge @802.11n HT20 mode channel 1 AV

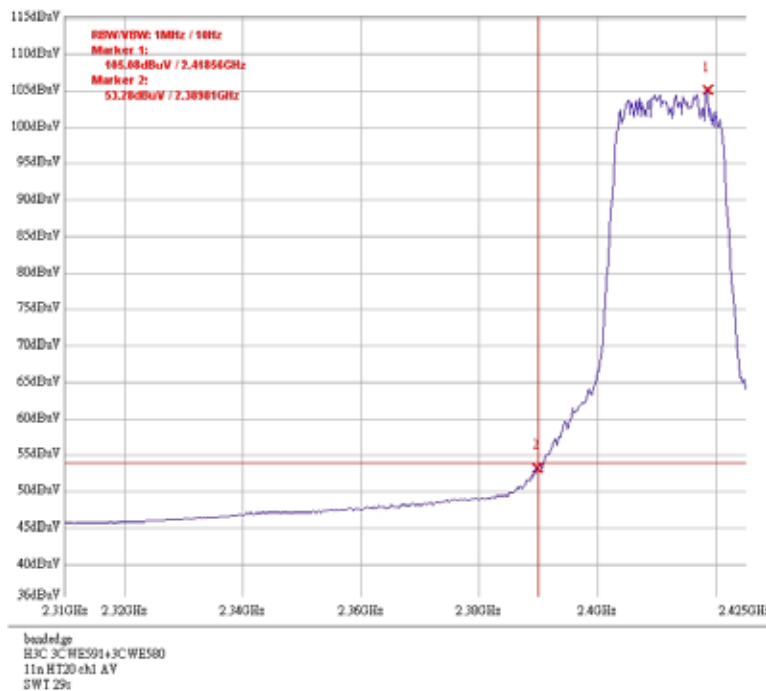

**Antenna 2 : 3CWE591**  
**Antenna cable A : 3CWE580**

**Band edge @802.11n HT20 mode channel 11 PK**

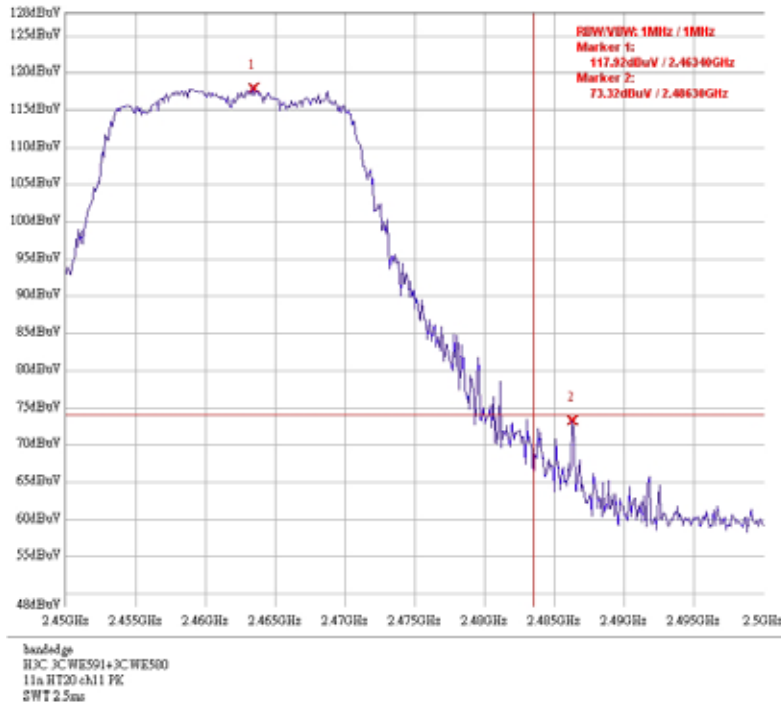

**Band edge @802.11n HT20 mode channel 11 AV**

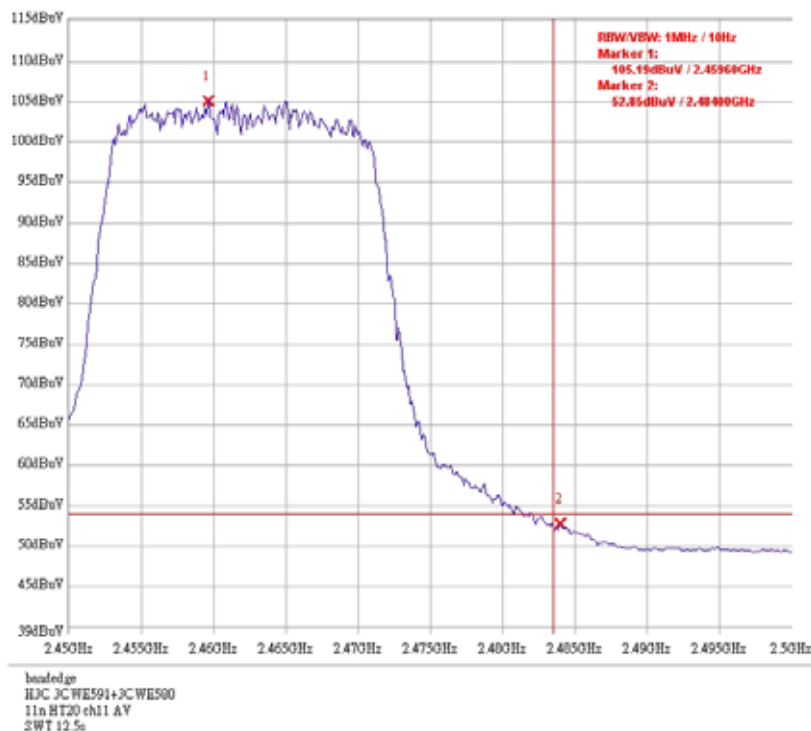

**Antenna 2 : 3CWE591**  
**Antenna cable A : 3CWE580**

Band edge @802.11n HT40 mode channel 3 PK

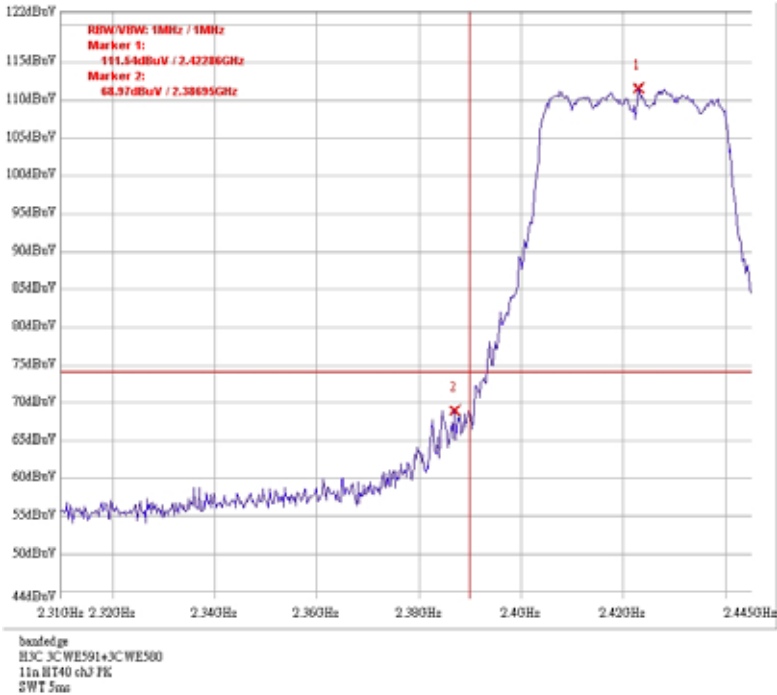

Band edge @802.11n HT40 mode channel 3 AV

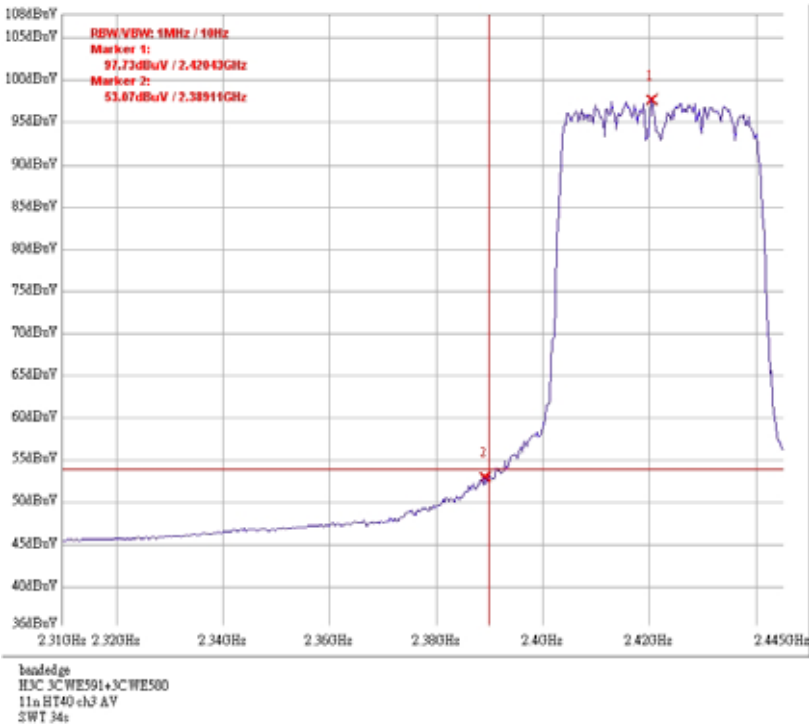



**Antenna 2 : 3CWE591**  
**Antenna cable A : 3CWE580**

Band edge @802.11n HT40 mode channel 9 PK

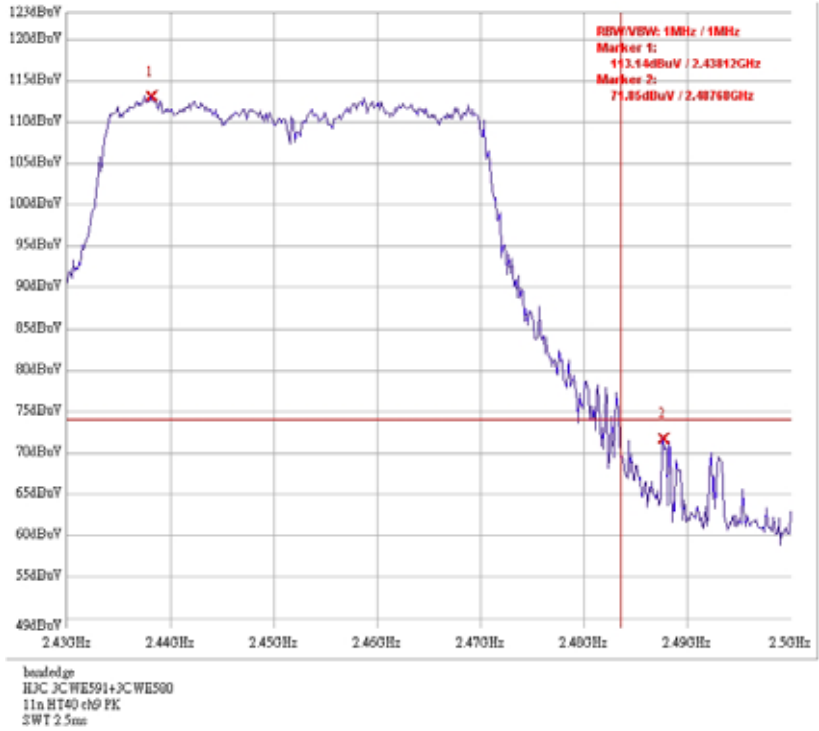

Band edge @802.11n HT40 mode channel 9 AV

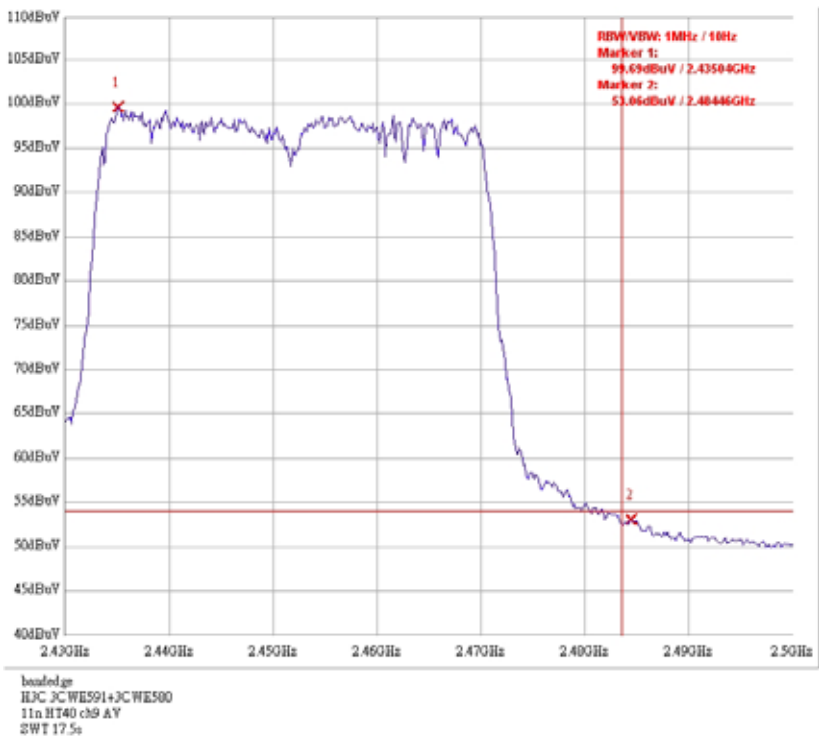

**Antenna 3 : 3CWE596**

**Antenna cable A : 3CWE580**

**Band edge @ 802.11b mode channel 1 PK**

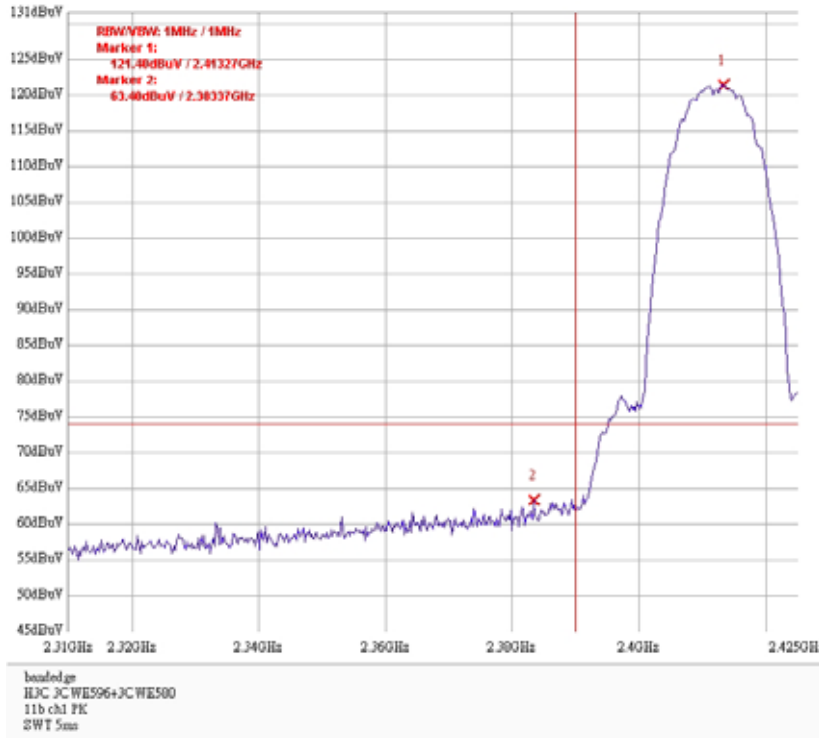

**Band edge @ 802.11b mode channel 1 AV**

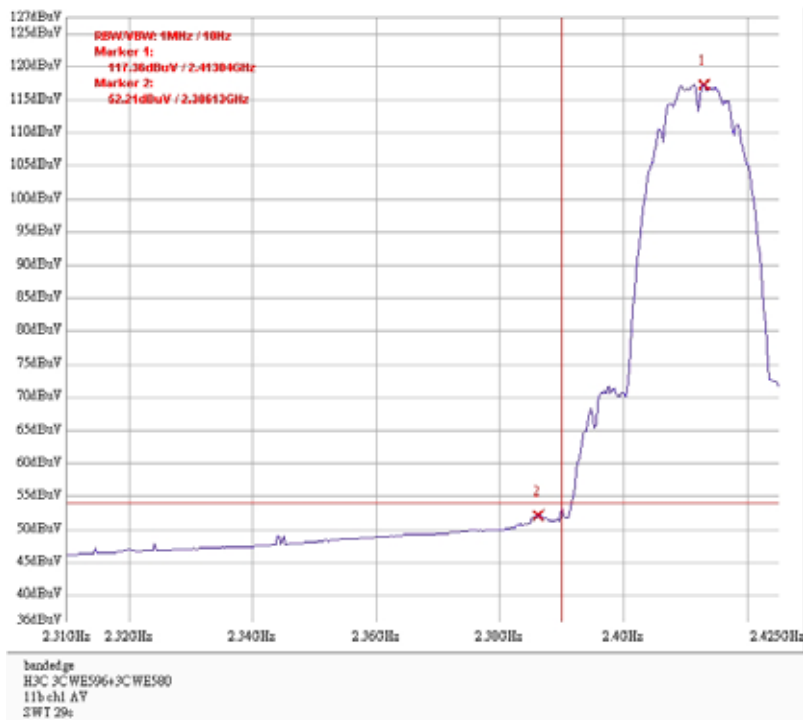

**Antenna 3 : 3CWE596**  
**Antenna cable A : 3CWE580**

Band edge @ 802.11b mode channel 11 PK

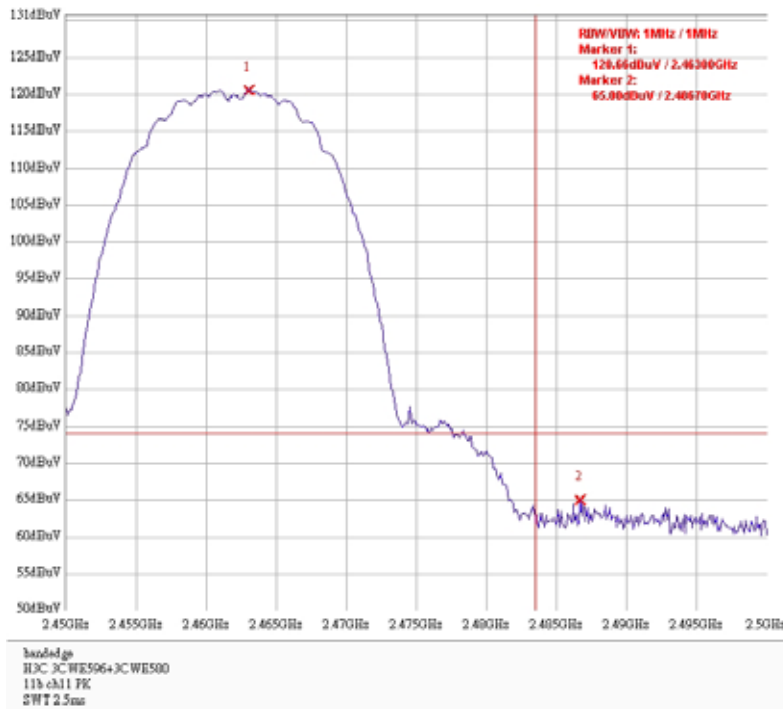

Band edge @ 802.11b mode channel 11 AV

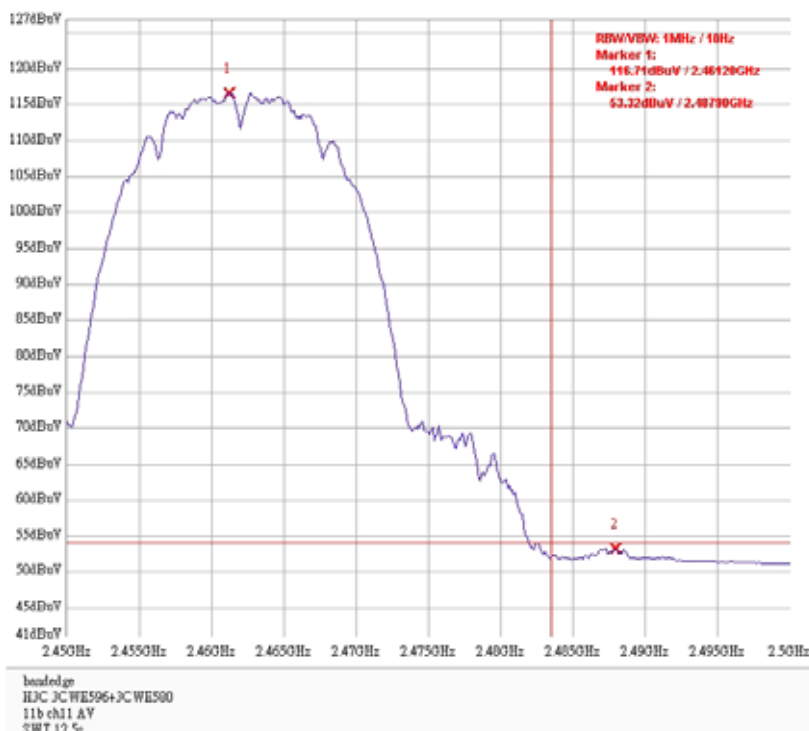

**Antenna 3 : 3CWE596**  
**Antenna cable A : 3CWE580**

Band edge @ 802.11g mode channel 1 PK

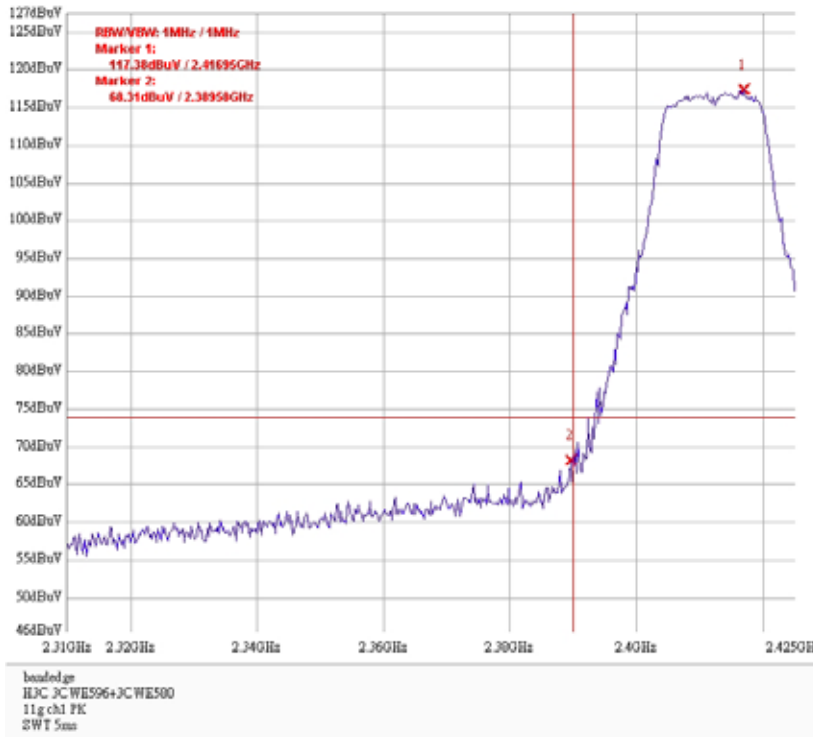

Band edge @ 802.11g mode channel 1 AV

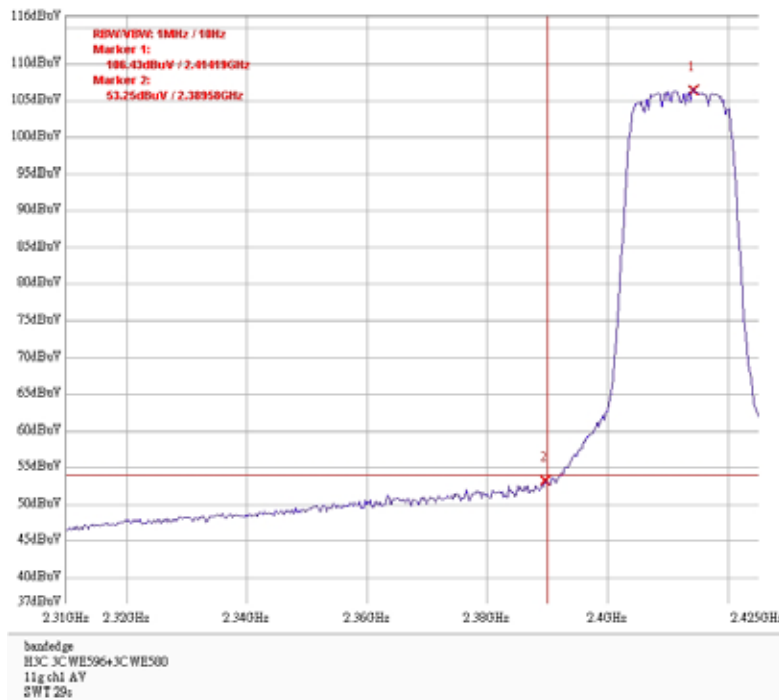

**Antenna 3 : 3CWE596**  
**Antenna cable : 3CWE580**

**Band edge @ 802.11g mode channel 11 PK**

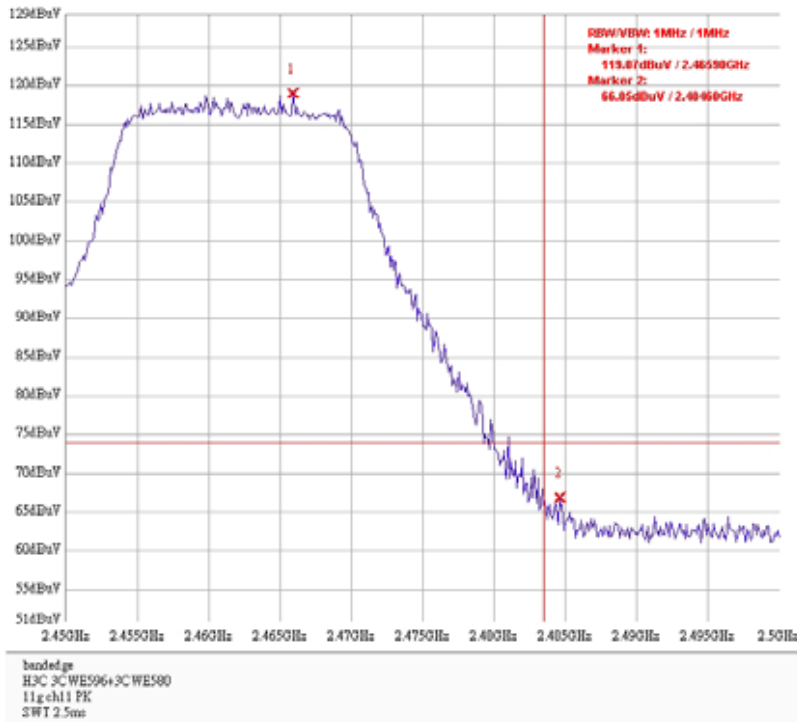

**Band edge @ 802.11g mode channel 11 AV**

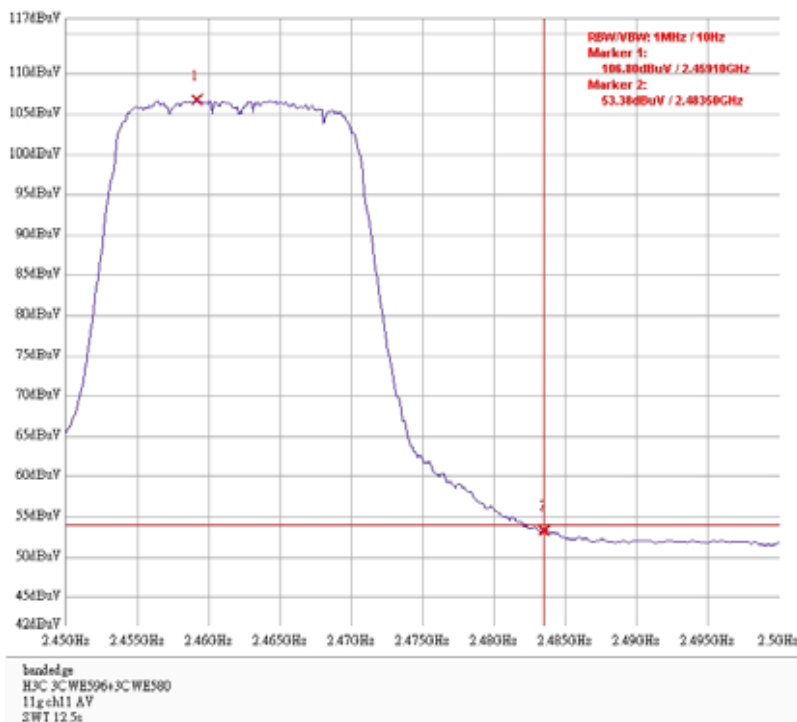

**Antenna 3 : 3CWE596**  
**Antenna cable A : 3CWE580**

Band edge @802.11n HT20 mode channel 1 PK

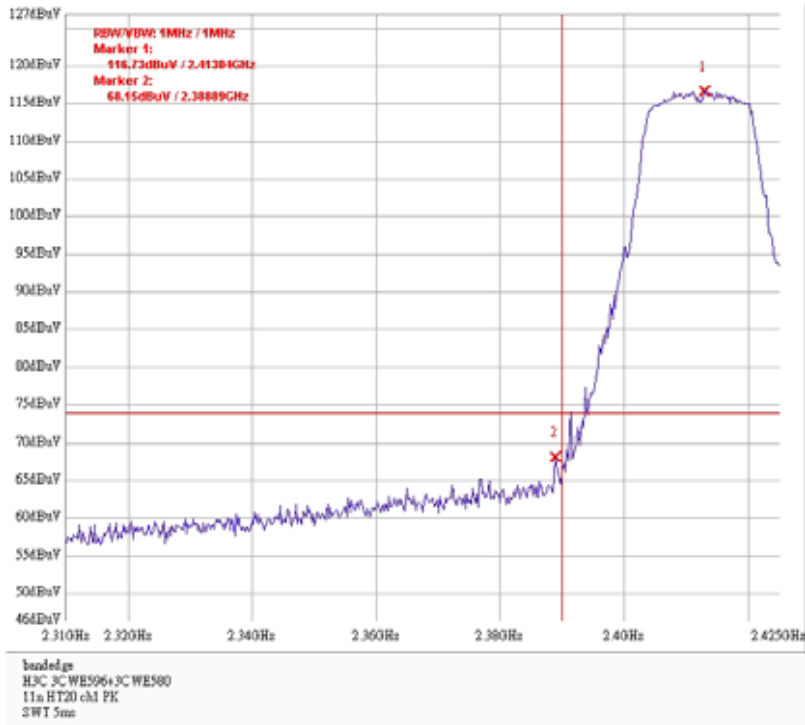

Band edge @802.11n HT20 mode channel 1 AV

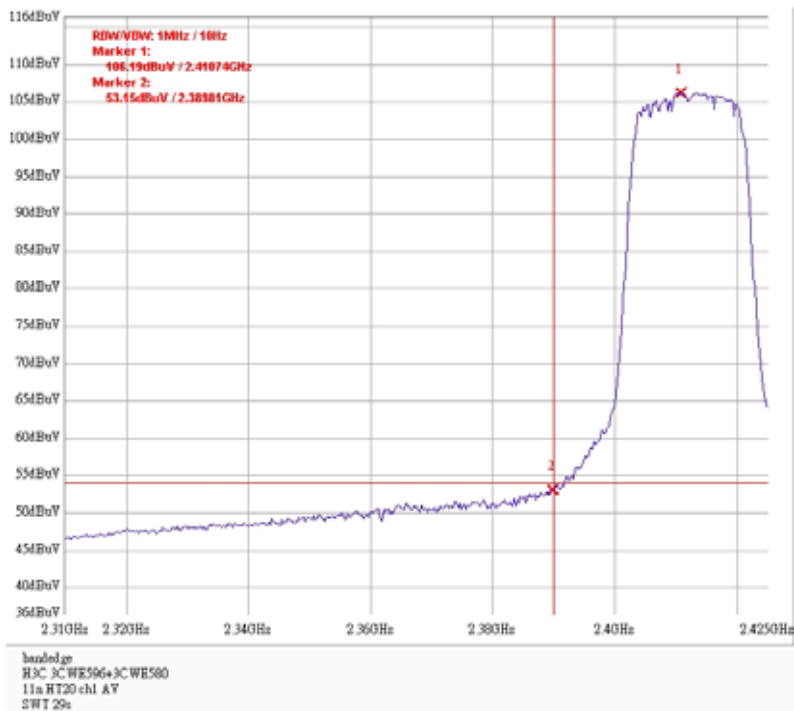

**Antenna 3 : 3CWE596**  
**Antenna cable A : 3CWE580**

Band edge @802.11n HT20 mode channel 11 PK

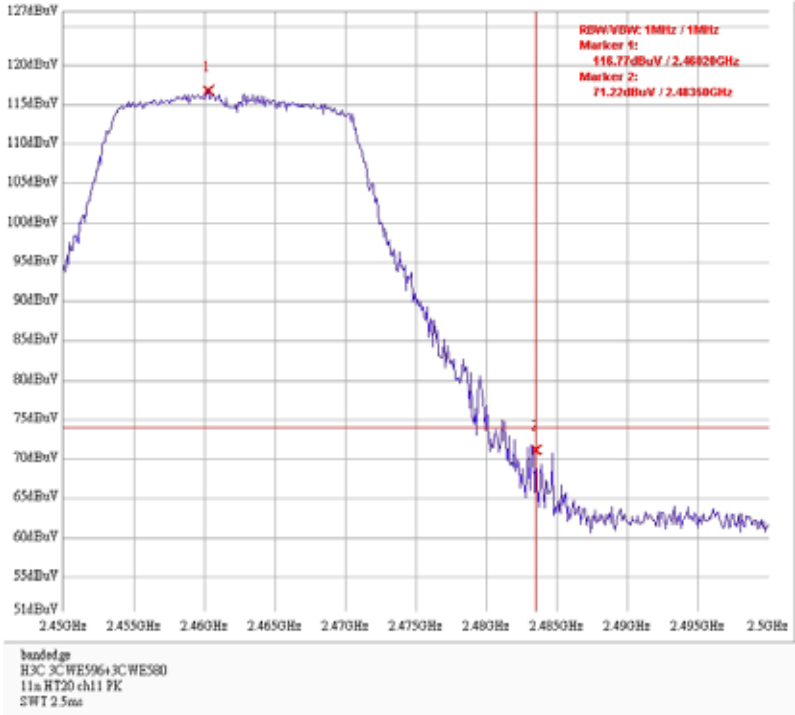

Band edge @802.11n HT20 mode channel 11 AV

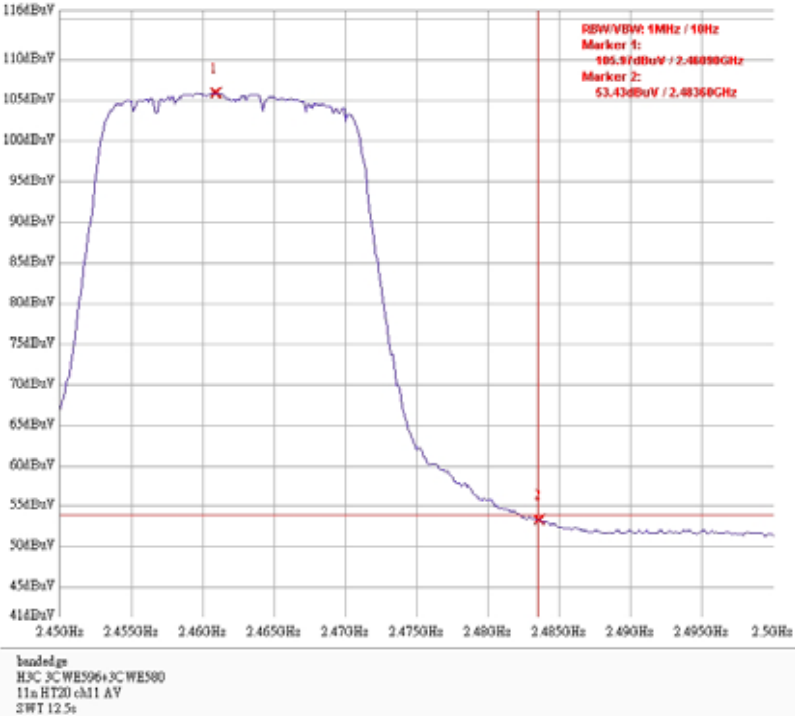

**Antenna 3 : 3CWE596**  
**Antenna cable A : 3CWE580**

**Band edge @802.11n HT40 mode channel 3 PK**

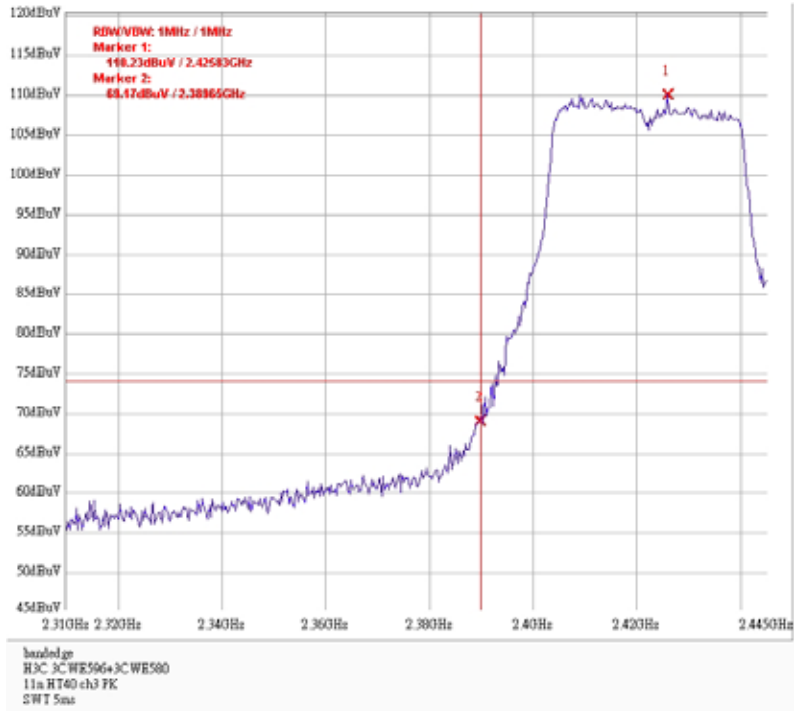

**Band edge @802.11n HT40 mode channel 3 AV**

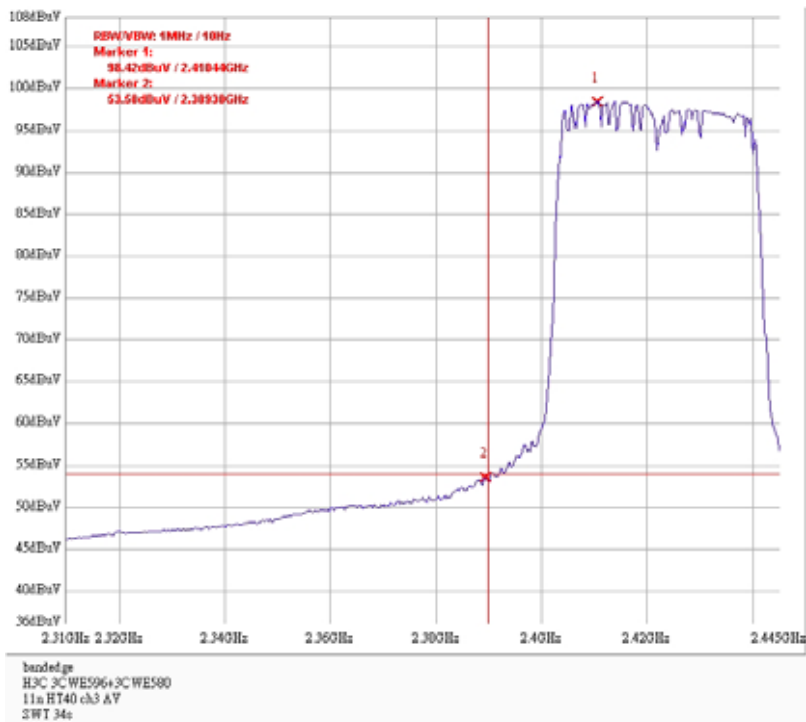



**Antenna 3 : 3CWE596**  
**Antenna cable A : 3CWE580**

Band edge @802.11n HT40 mode channel 9 PK

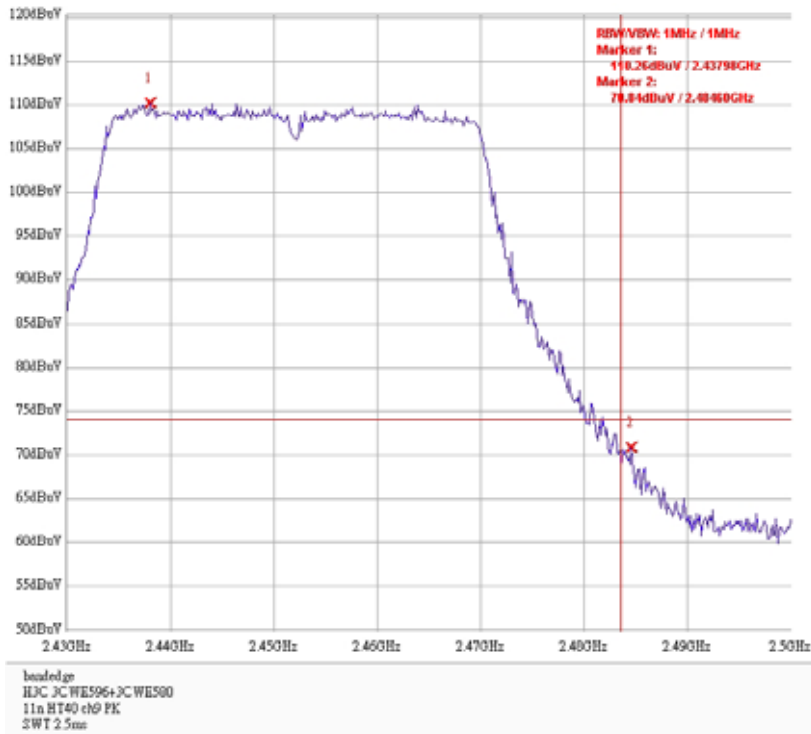

Band edge @802.11n HT40 mode channel 9 AV

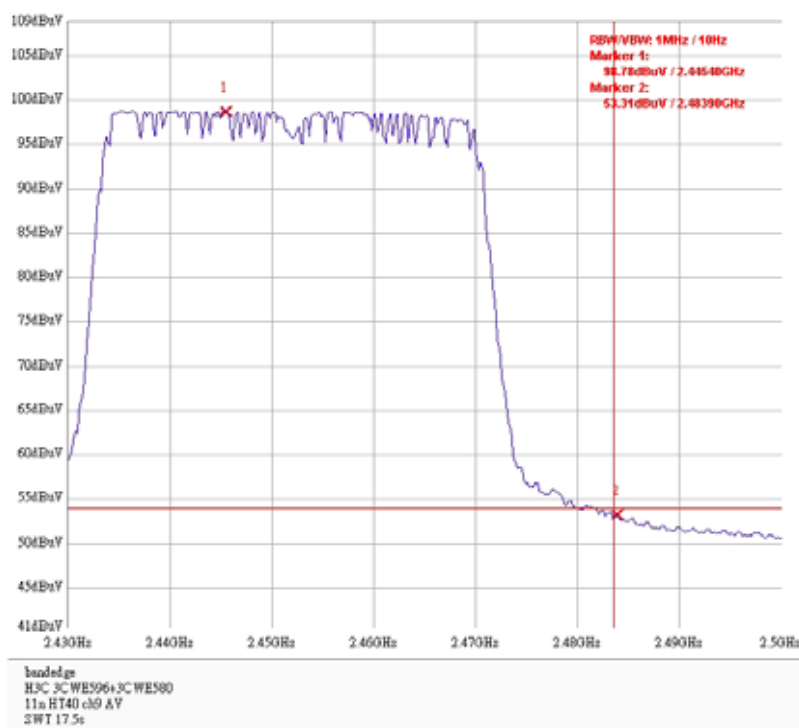

**Antenna 4 : 3CWE598**

**Antenna cable A : 3CWE580**

**Band edge @ 802.11b mode channel 1 PK**

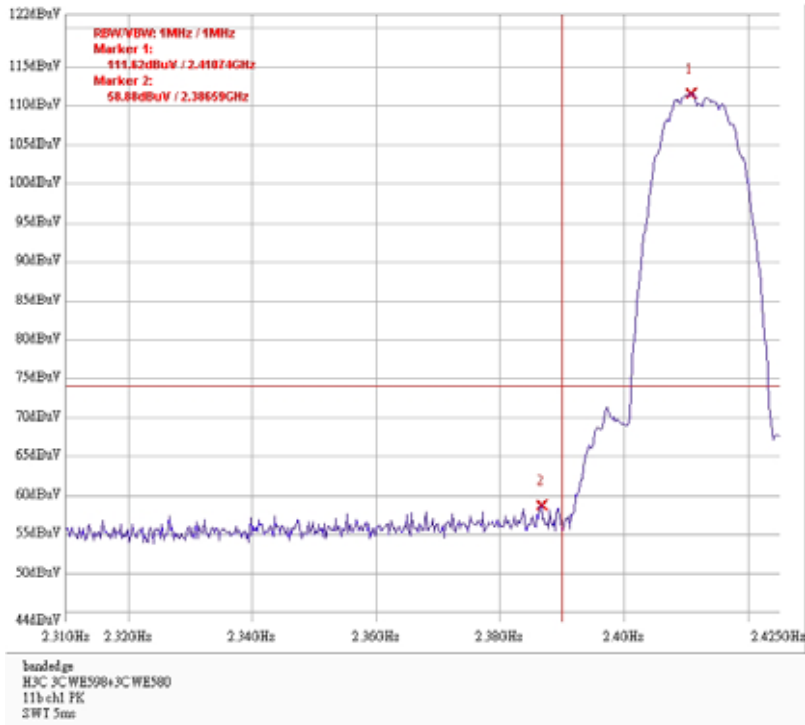

**Band edge @ 802.11b mode channel 1 AV**

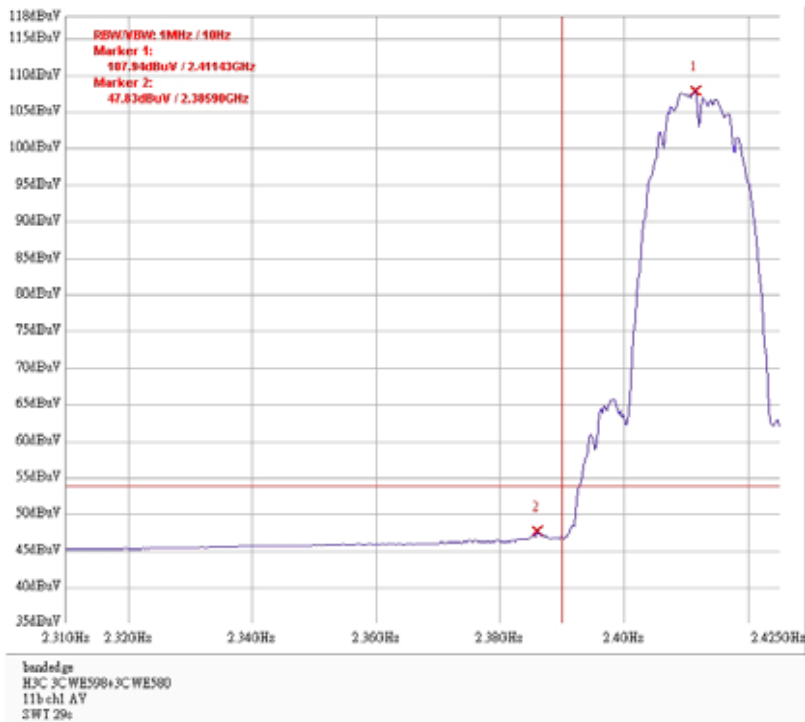

Antenna 4 : 3CWE598  
Antenna cable A : 3CWE580

Band edge @ 802.11b mode channel 11 PK

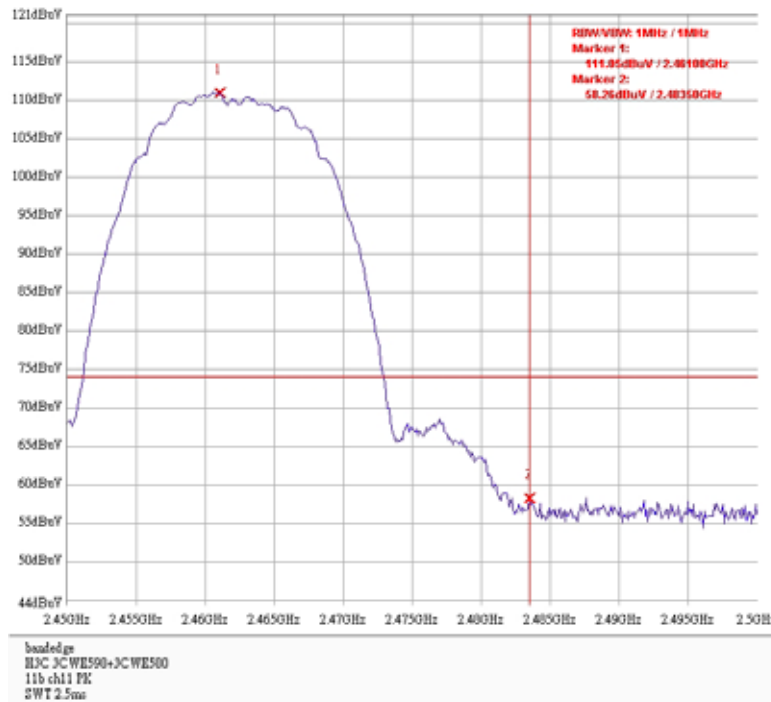

Band edge @ 802.11b mode channel 11 AV

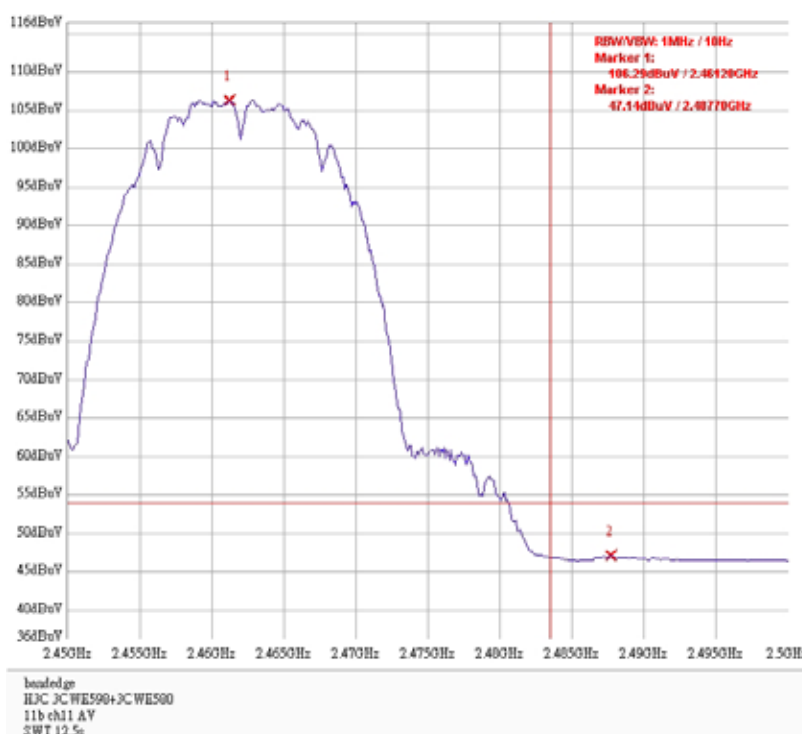

**Antenna 4 : 3CWE598**  
**Antenna cable A : 3CWE580**

Band edge @ 802.11g mode channel 1 PK

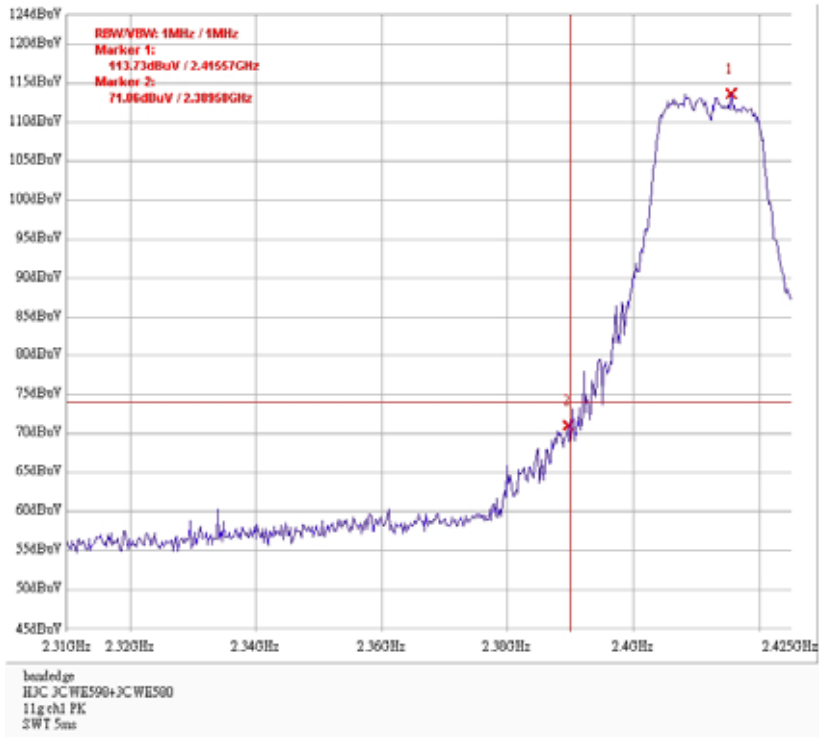

Band edge @ 802.11g mode channel 1 AV

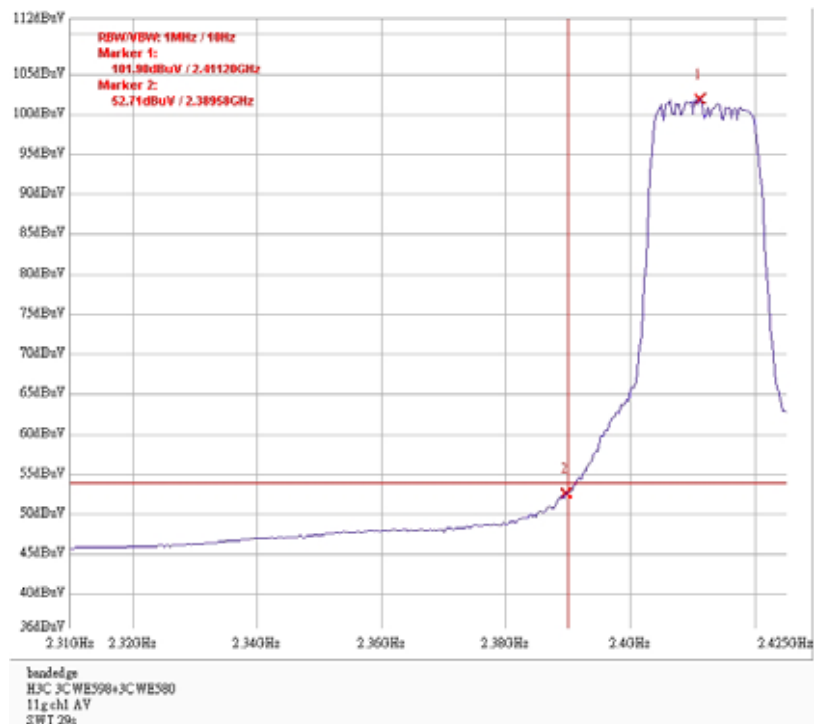

**Antenna 4 : 3CWE598**  
**Antenna cable : 3CWE580**

**Band edge @ 802.11g mode channel 11 PK**

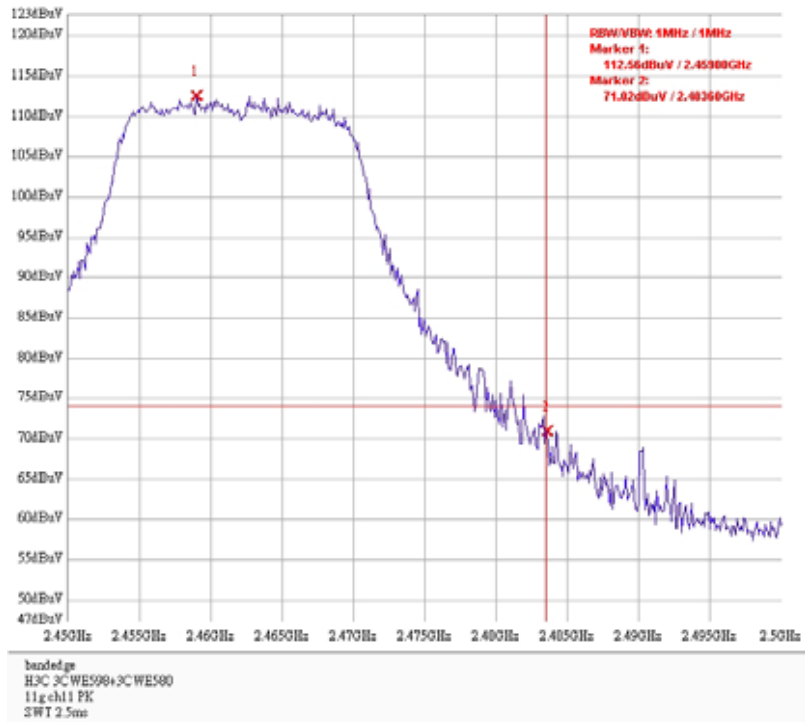

**Band edge @ 802.11g mode channel 11 AV**

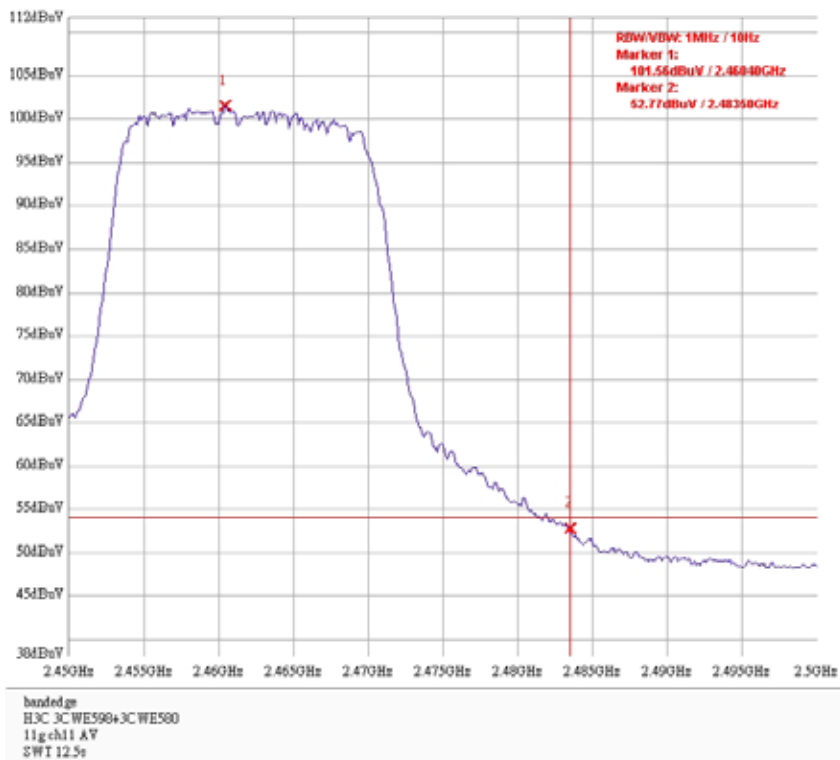

Antenna 4 : 3CWE598  
 Antenna cable A : 3CWE580

Band edge @802.11n HT20 mode channel 1 PK

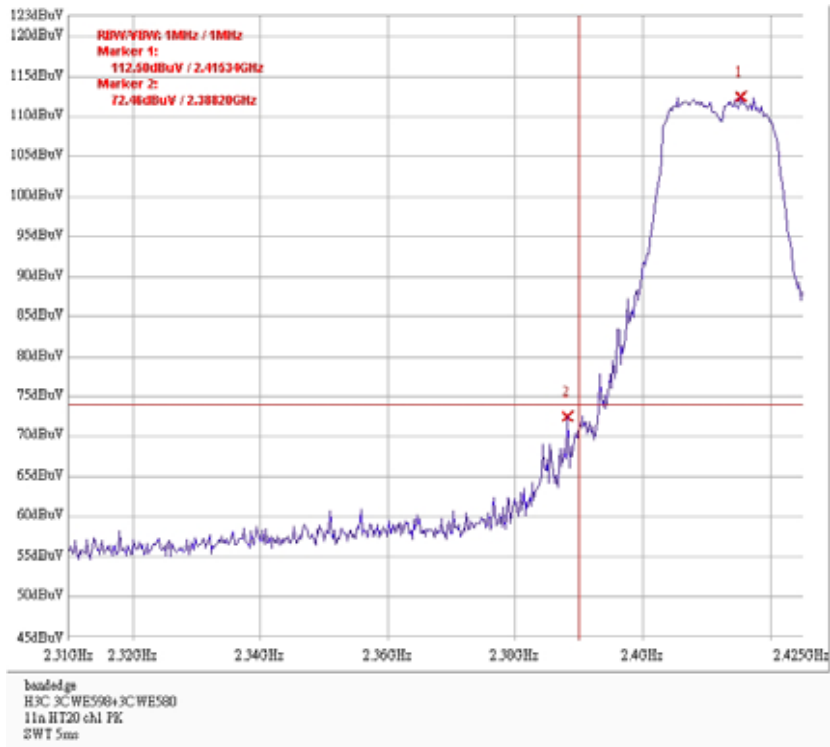

Band edge @802.11n HT20 mode channel 1 AV

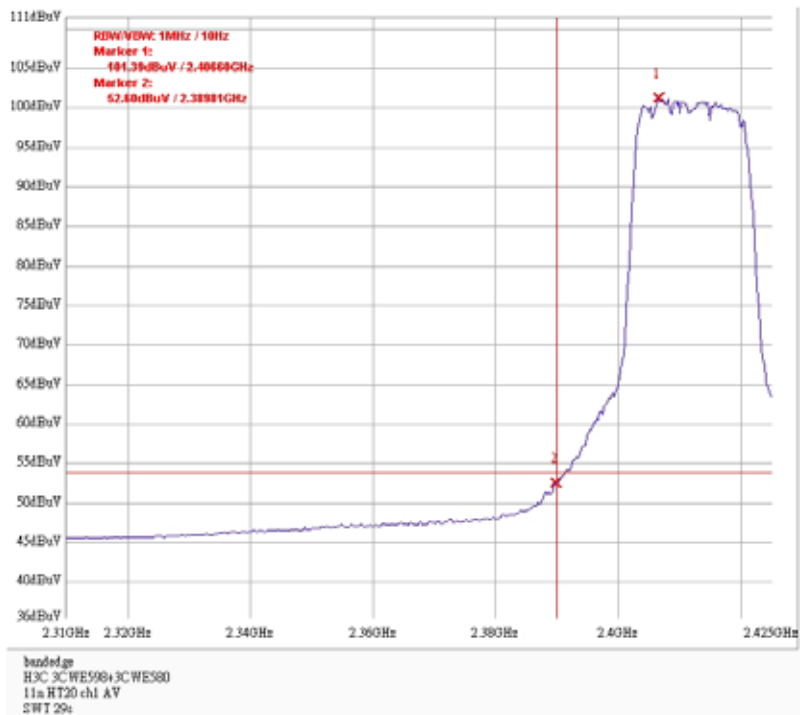

**Antenna 4 : 3CWE598**  
**Antenna cable A : 3CWE580**

Band edge @802.11n HT20 mode channel 11 PK

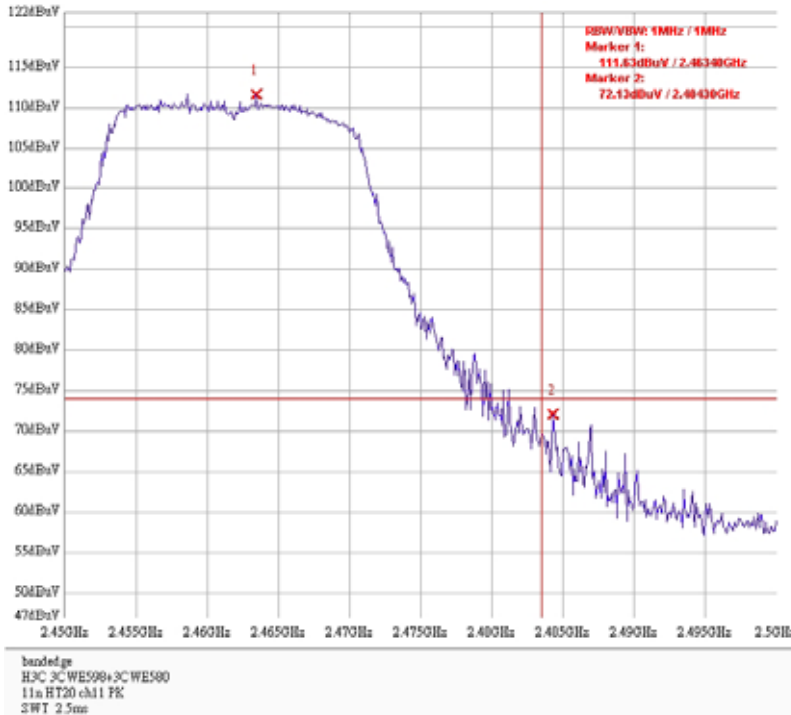

Band edge @802.11n HT20 mode channel 11 AV

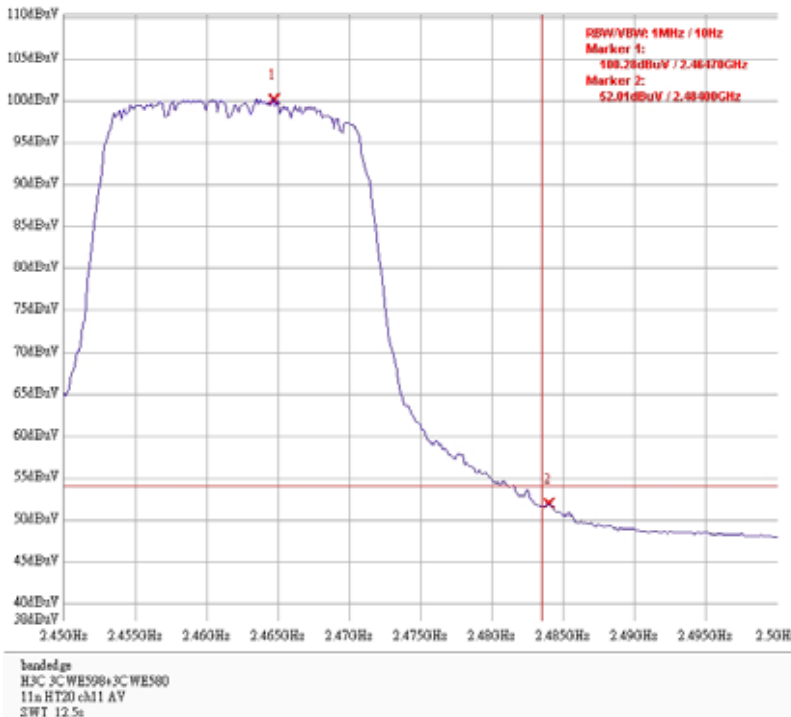

**Antenna 4 : 3CWE598**  
**Antenna cable A : 3CWE580**

Band edge @802.11n HT40 mode channel 3 PK

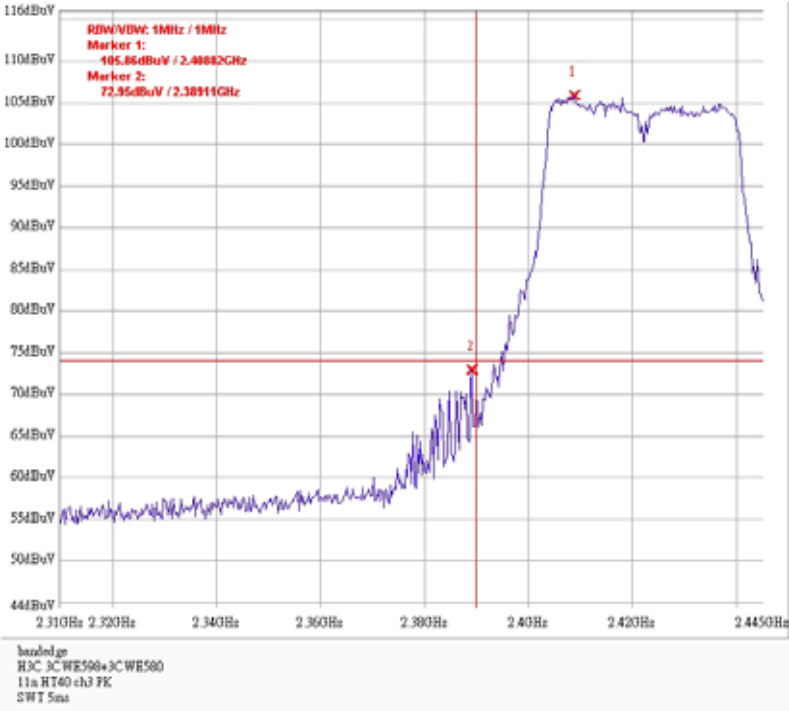

Band edge @802.11n HT40 mode channel 3 AV

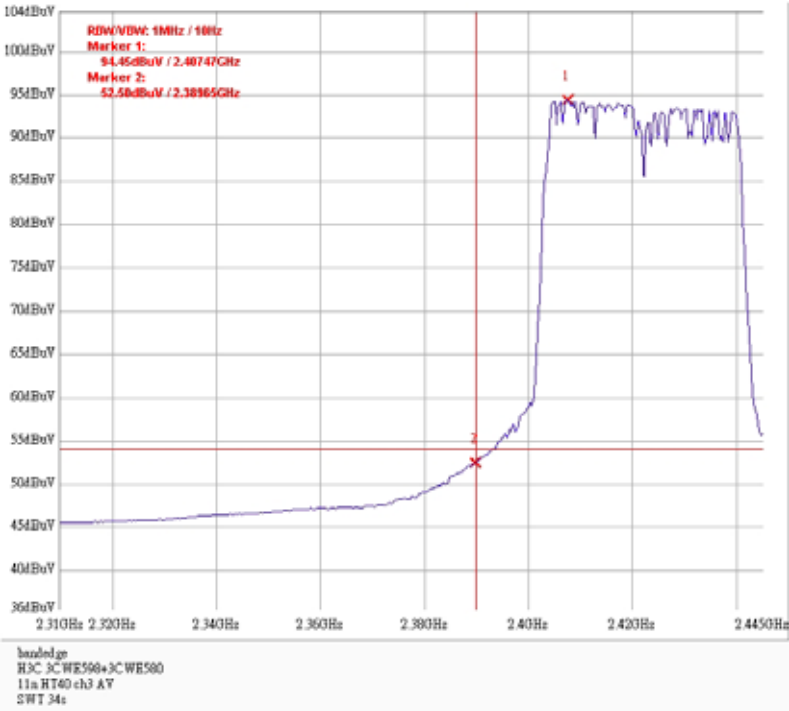



**Antenna 4 : 3CWE598**  
**Antenna cable A : 3CWE580**

Band edge @802.11n HT40 mode channel 9 PK

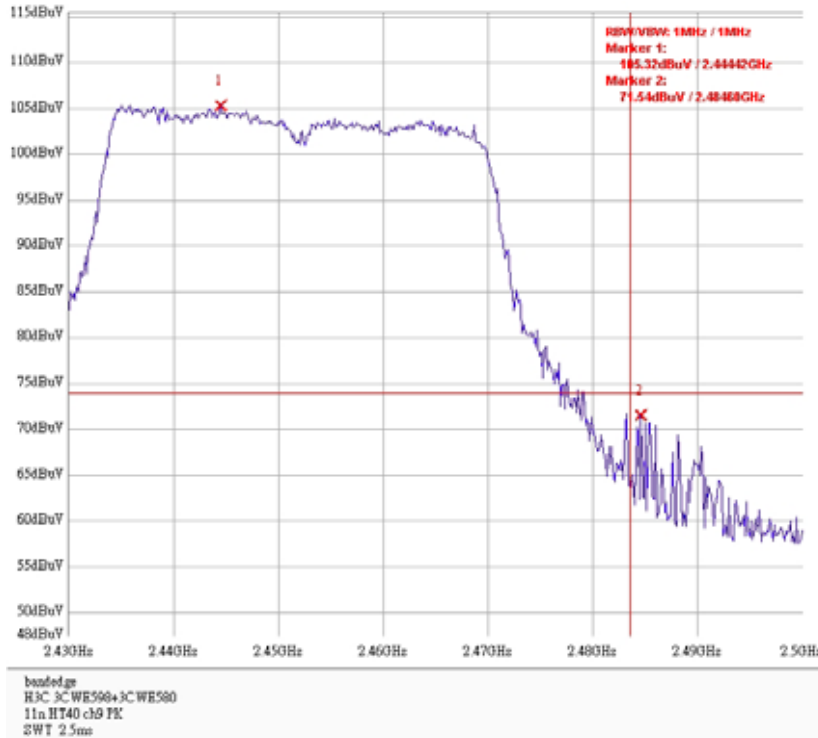

Band edge @802.11n HT40 mode channel 9 AV

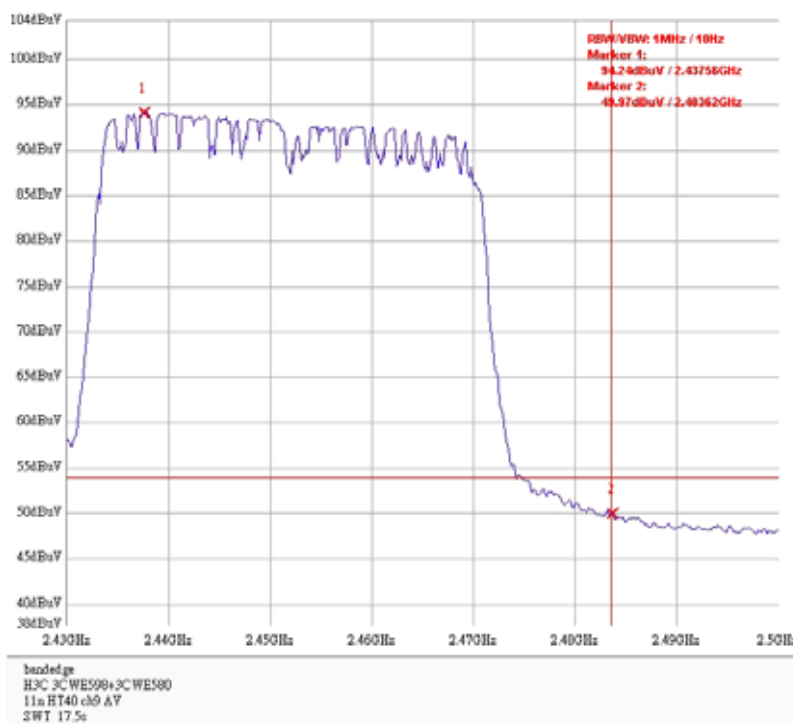

**Antenna 5 : MCM2458PTRPSM**

Band edge @ 802.11b mode channel 1 PK

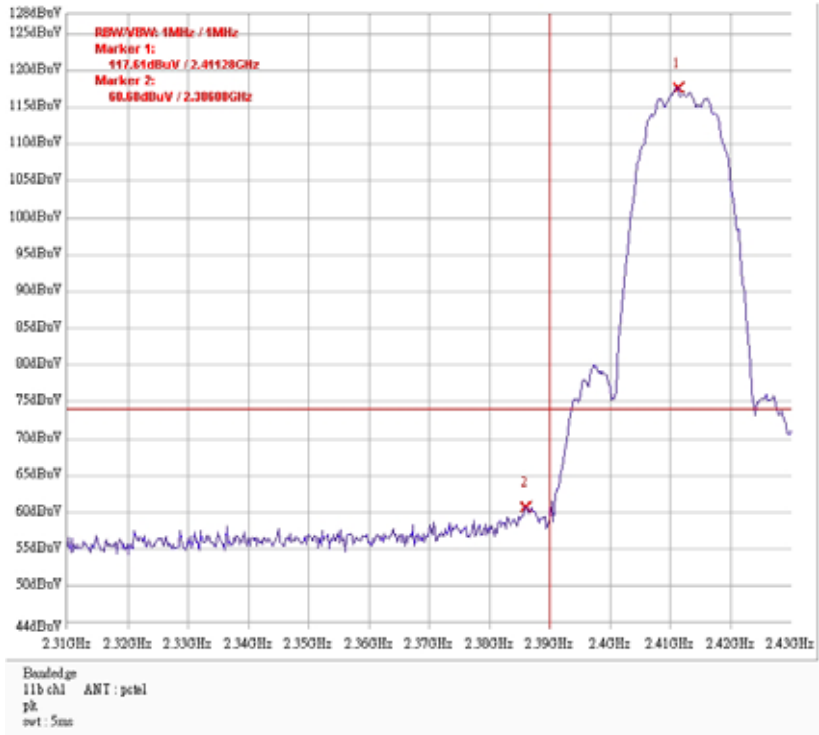

Band edge @ 802.11b mode channel 1 AV

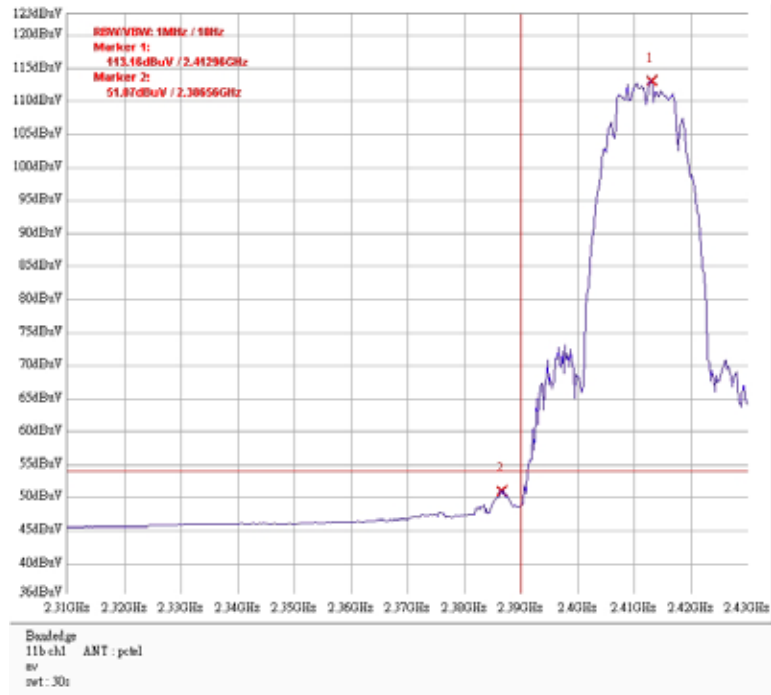

**Antenna 5 : MCM2458PTRPSM**

**Band edge @ 802.11b mode channel 11 PK**

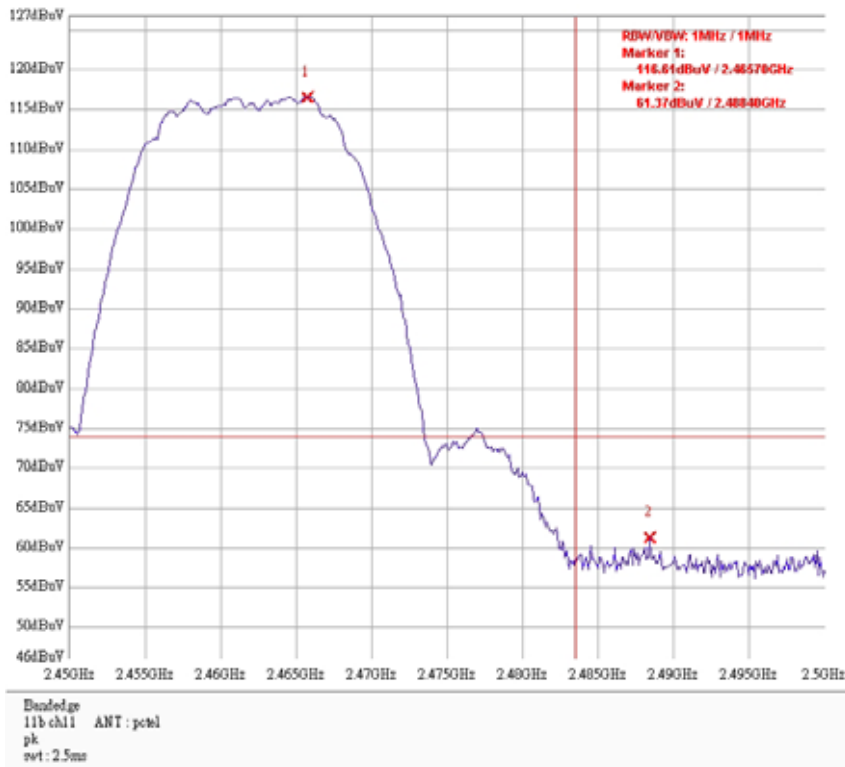

**Band edge @ 802.11b mode channel 11 AV**

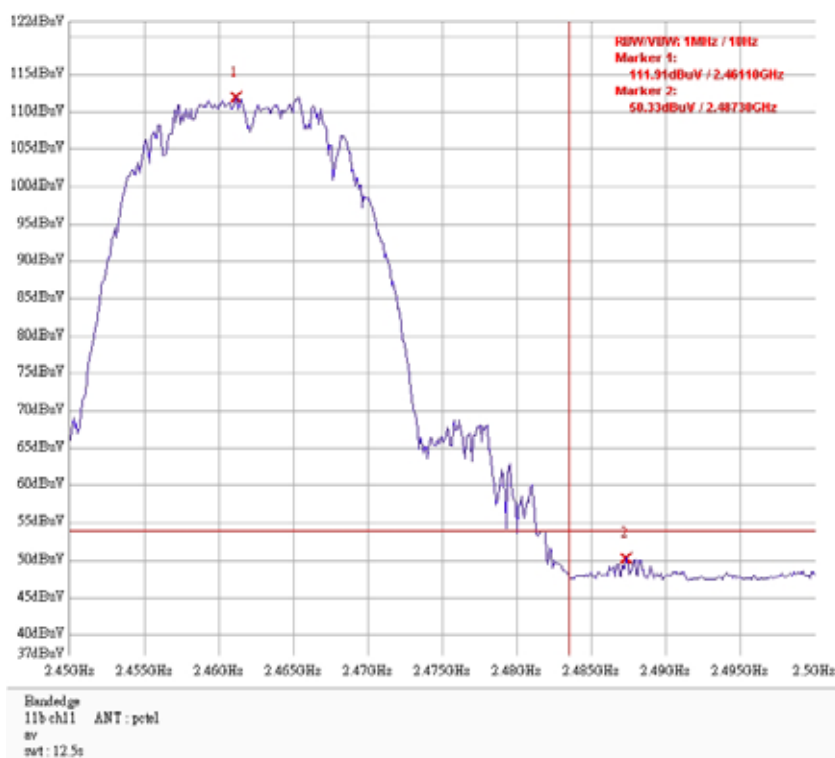

**Antenna 5 : MCM2458PTRPSM**

**Band edge @ 802.11g mode channel 1 PK**

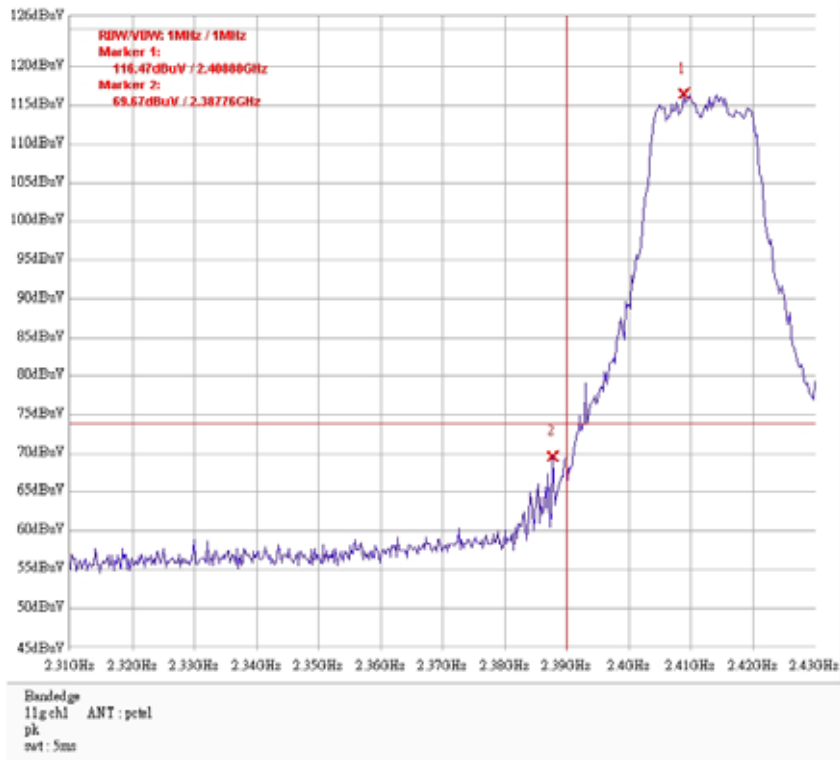

**Band edge @ 802.11g mode channel 1 AV**

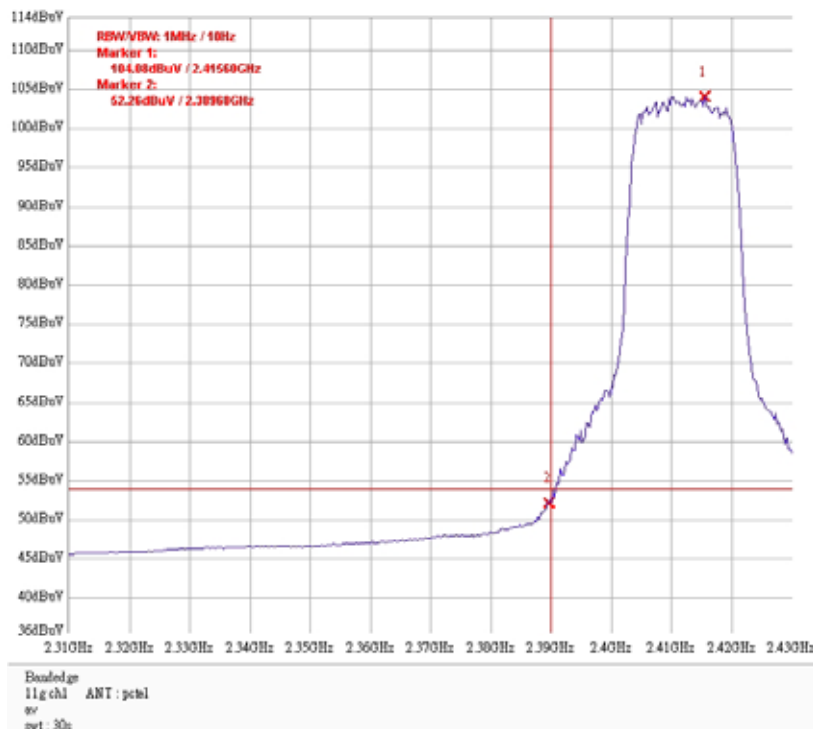

**Antenna 5 : MCM2458PTRPSM**

**Band edge @ 802.11g mode channel 11 PK**

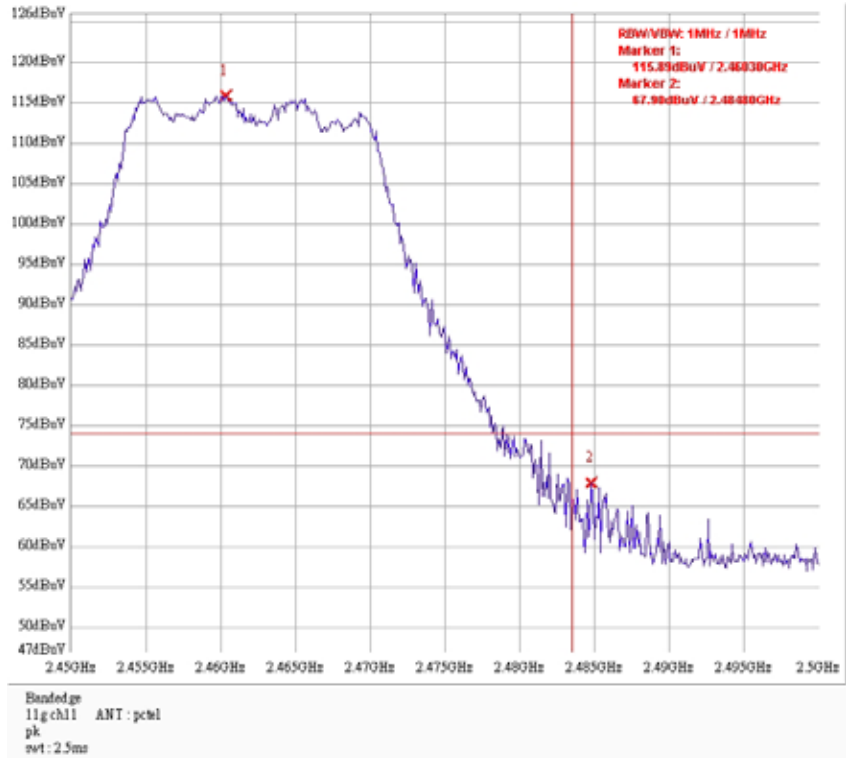

**Band edge @ 802.11g mode channel 11 AV**

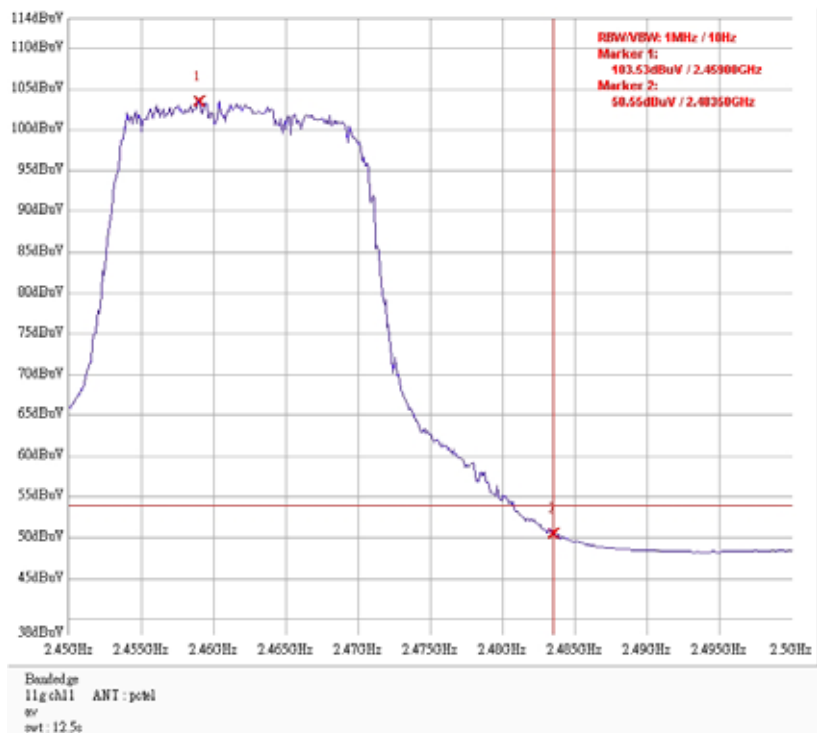

**Antenna 5 : MCM2458PTRPSM**

**Band edge @802.11n HT20 mode channel 1 PK**

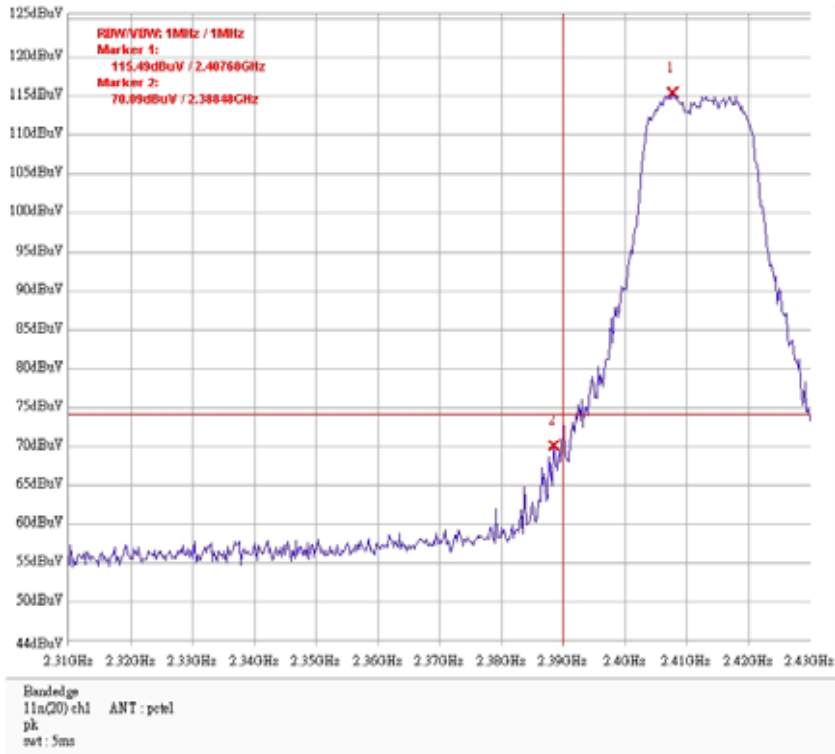

**Band edge @802.11n HT20 mode channel 1 AV**

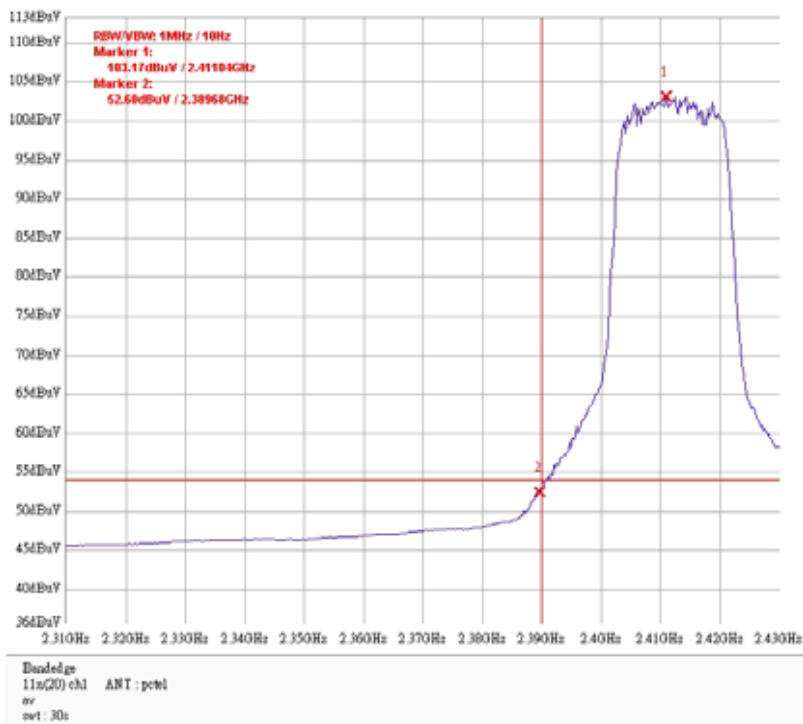

**Antenna 5 : MCM2458PTRPSM**

**Band edge @802.11n HT20 mode channel 11 PK**

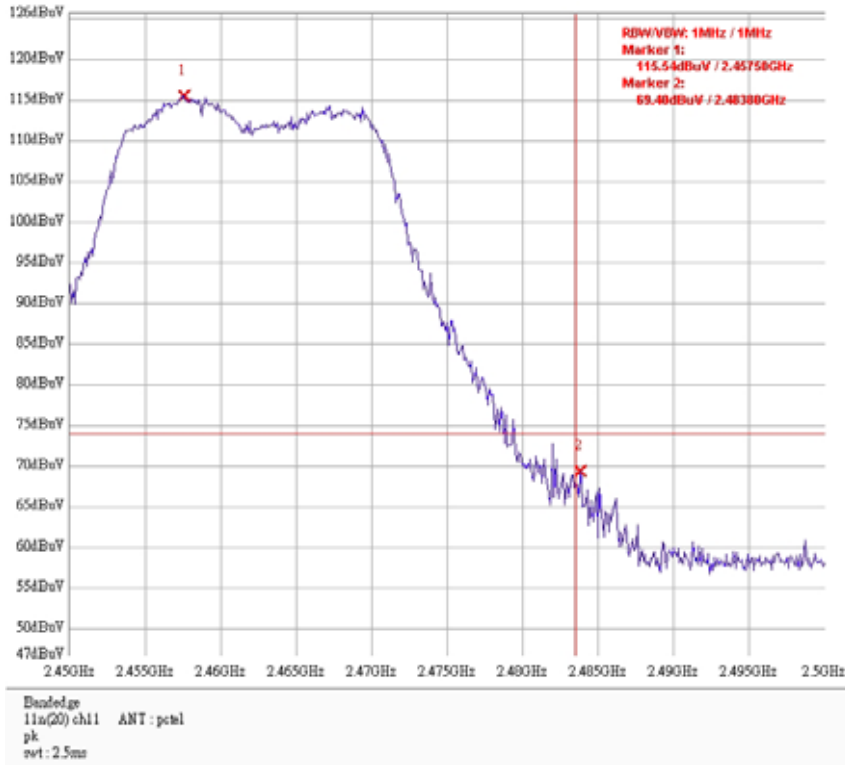

**Band edge @802.11n HT20 mode channel 11 AV**

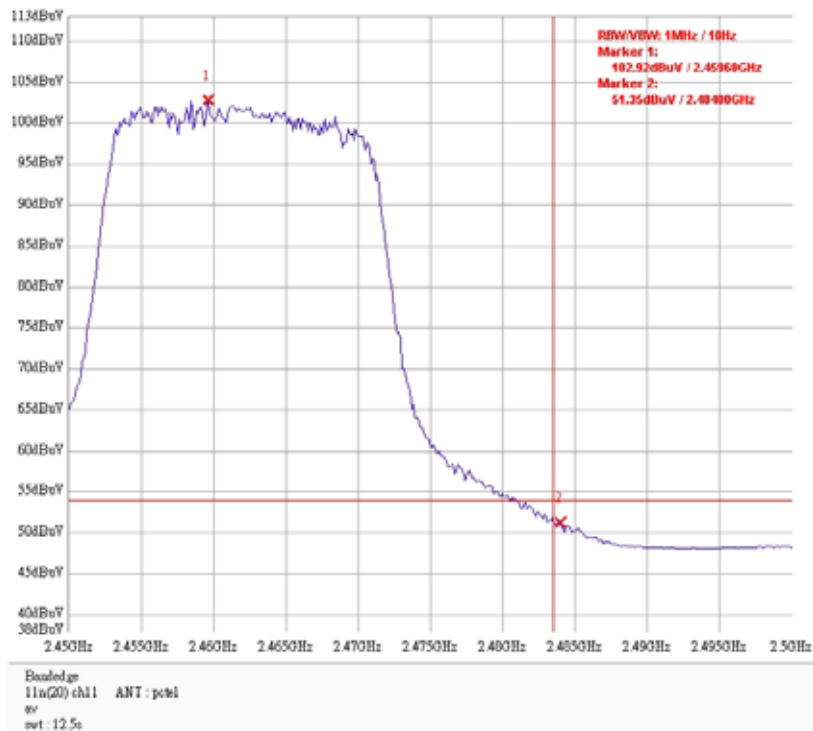

**Antenna 5 : MCM2458PTRPSM**

**Band edge @802.11n HT40 mode channel 3 PK**

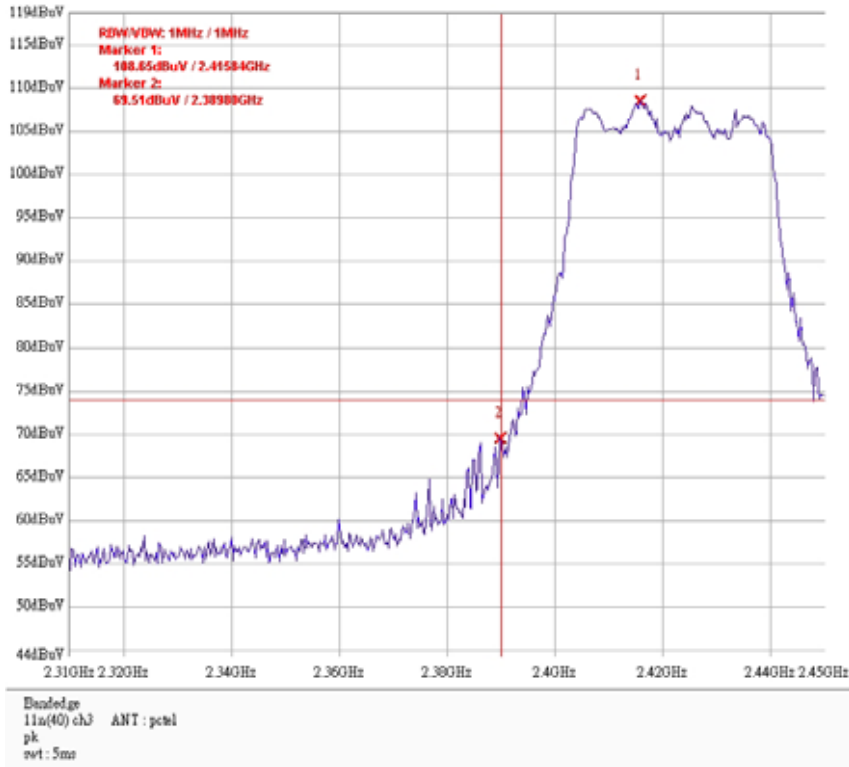

**Band edge @802.11n HT40 mode channel 3 AV**

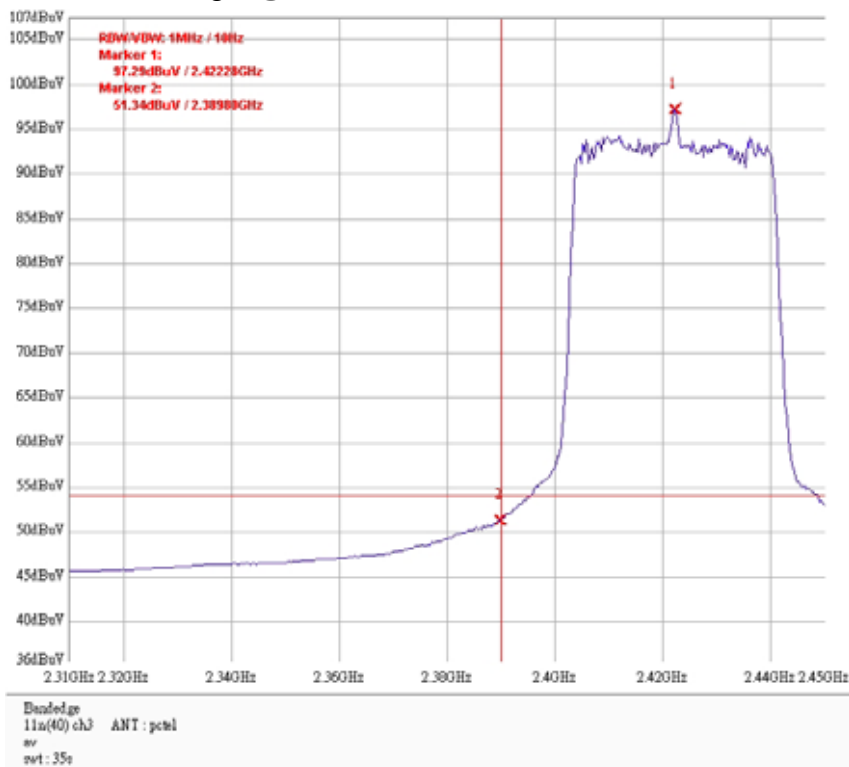



**Antenna 5 : MCM2458PTRPSM**

**Band edge @802.11n HT40 mode channel 9 PK**

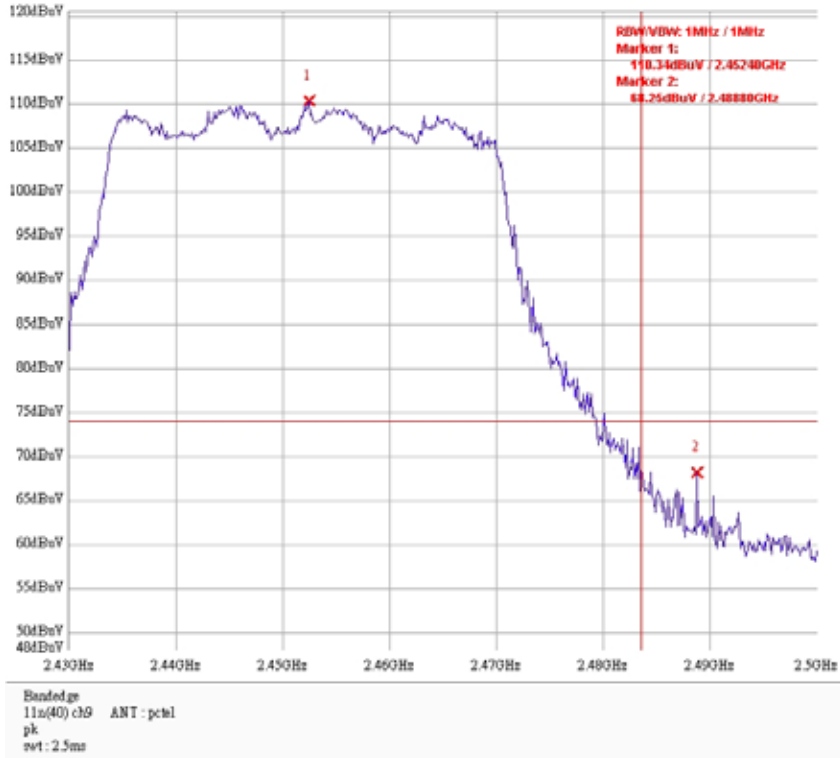

**Band edge @802.11n HT40 mode channel 9 AV**

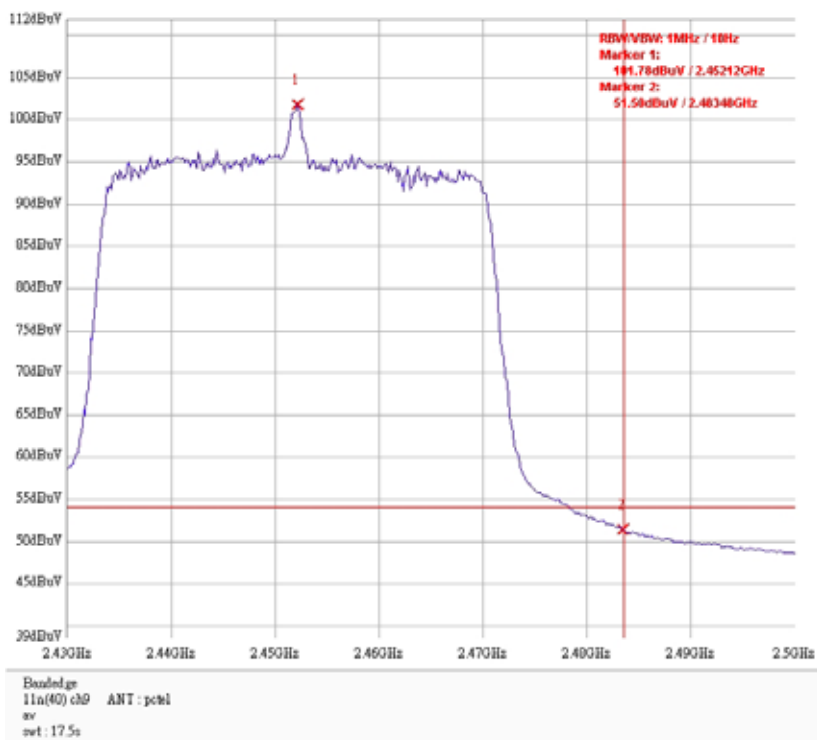

**Antenna 6 : TQJ-24/58MICX6**

**Band edge @ 802.11b mode channel 1 PK**

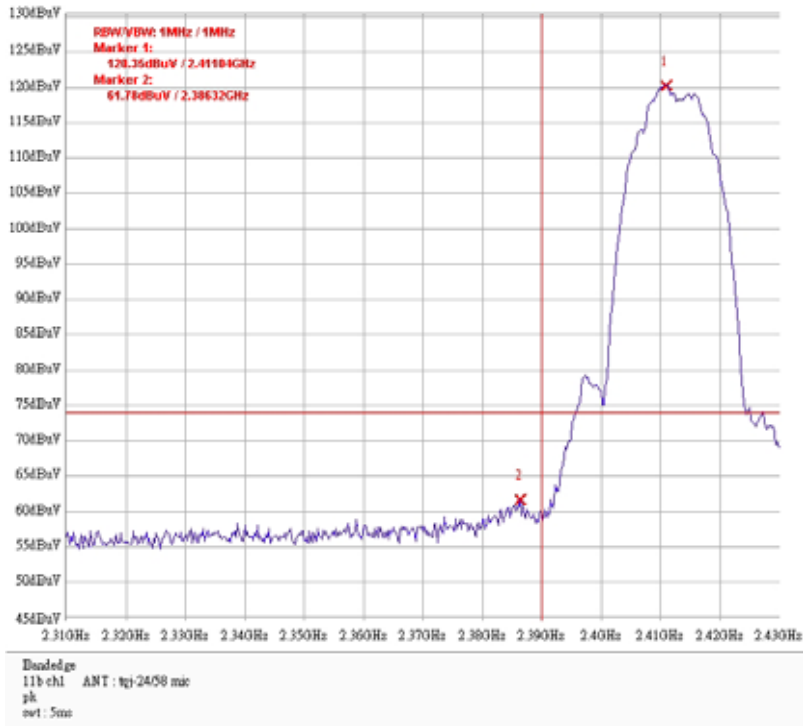

**Band edge @ 802.11b mode channel 1 AV**

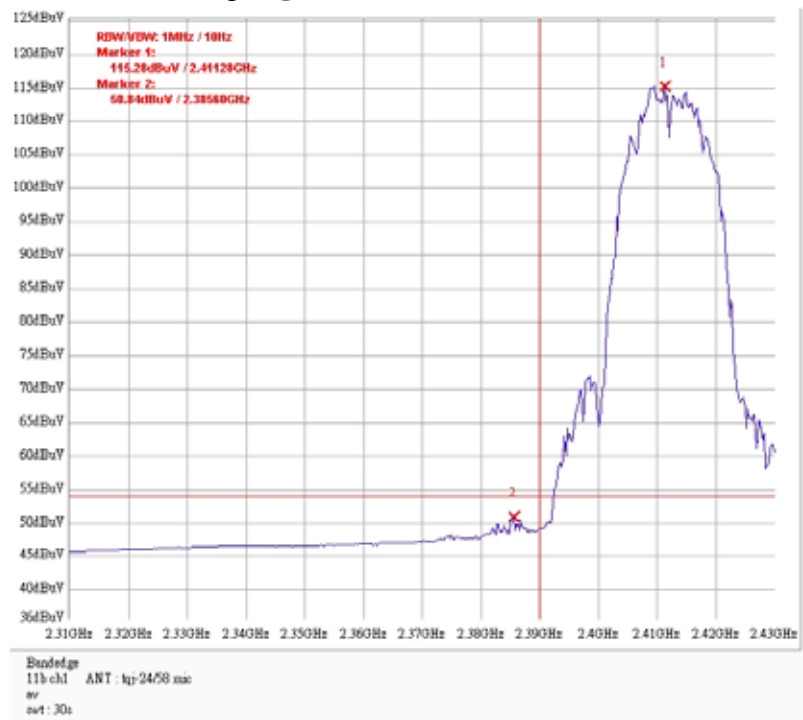

**Antenna 6 : TQJ-24/58MICX6**

**Band edge @ 802.11b mode channel 11 PK**

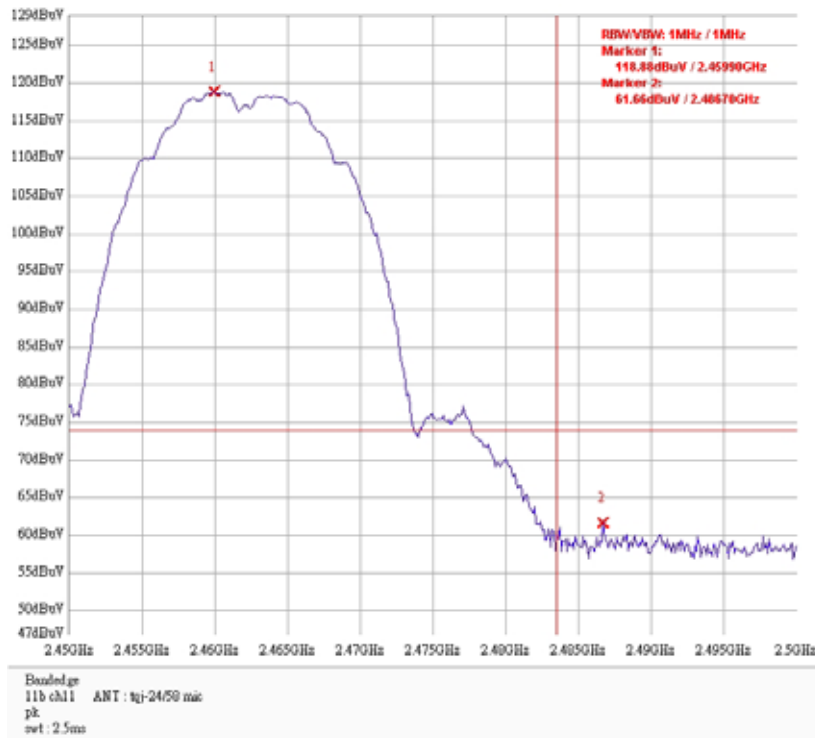

**Band edge @ 802.11b mode channel 11 AV**

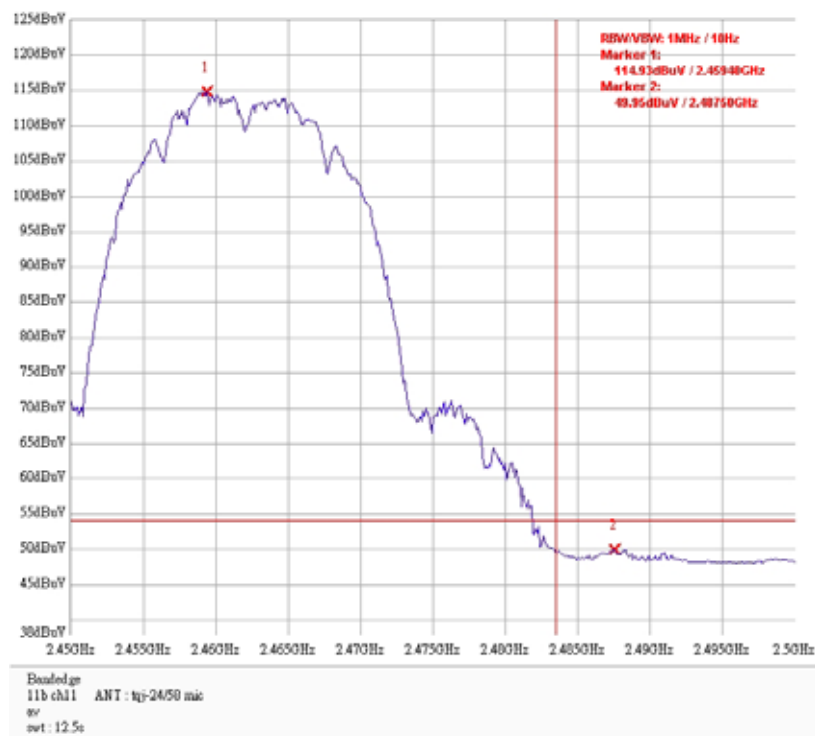

**Antenna 6 : TQJ-24/58MICX6**

**Band edge @ 802.11g mode channel 1 PK**

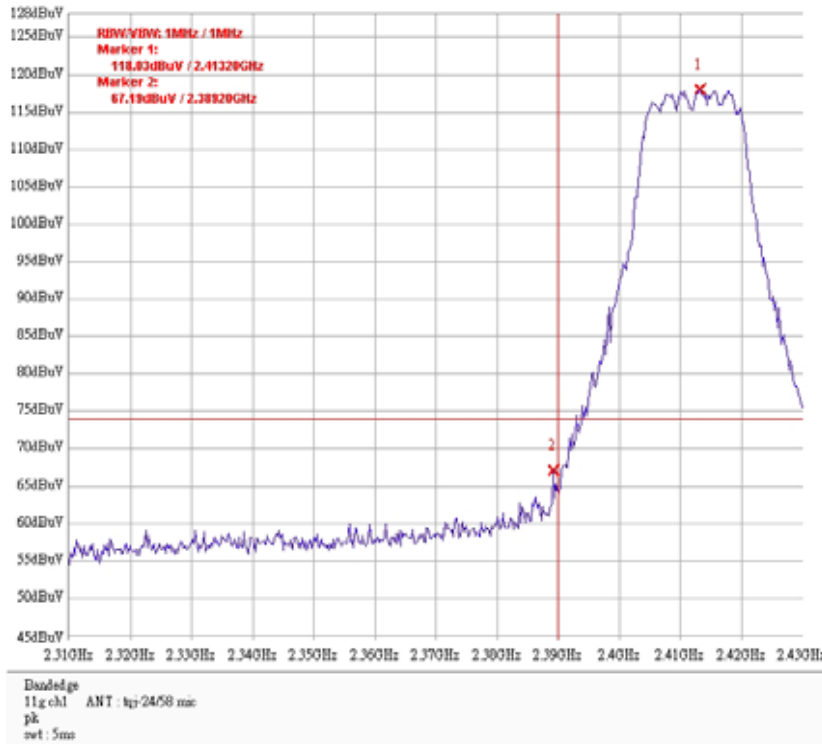

**Band edge @ 802.11g mode channel 1 AV**

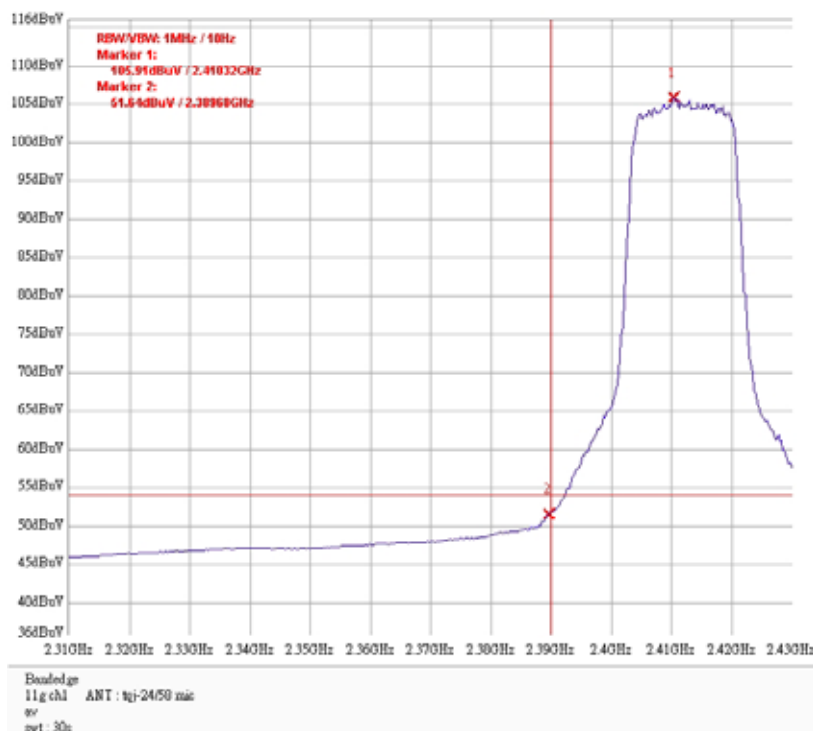

**Antenna 6 : TQJ-24/58MICX6**

**Band edge @ 802.11g mode channel 11 PK**

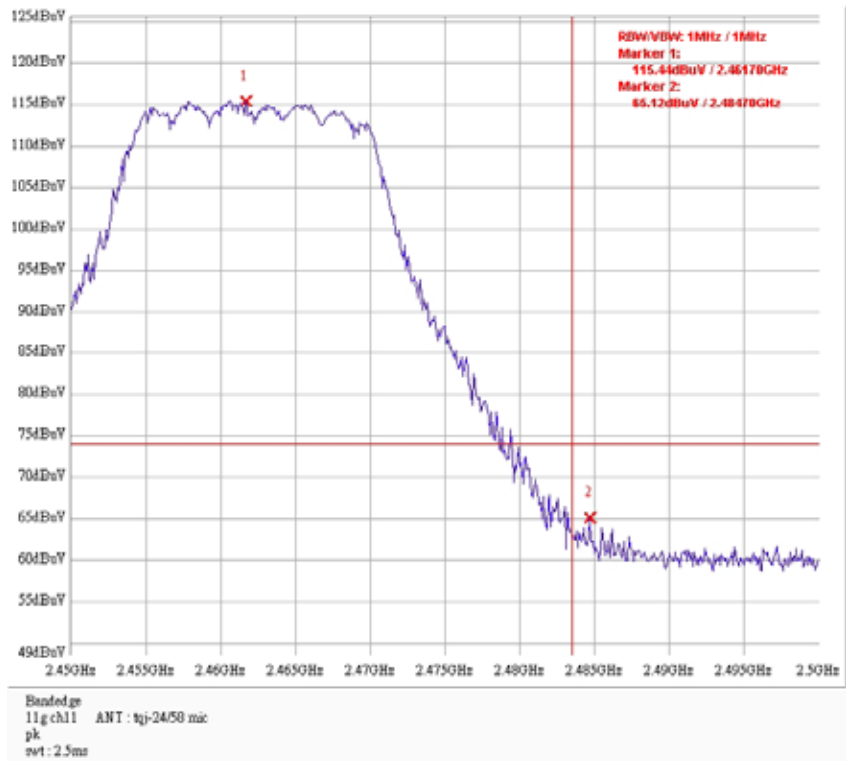

**Band edge @ 802.11g mode channel 11 AV**

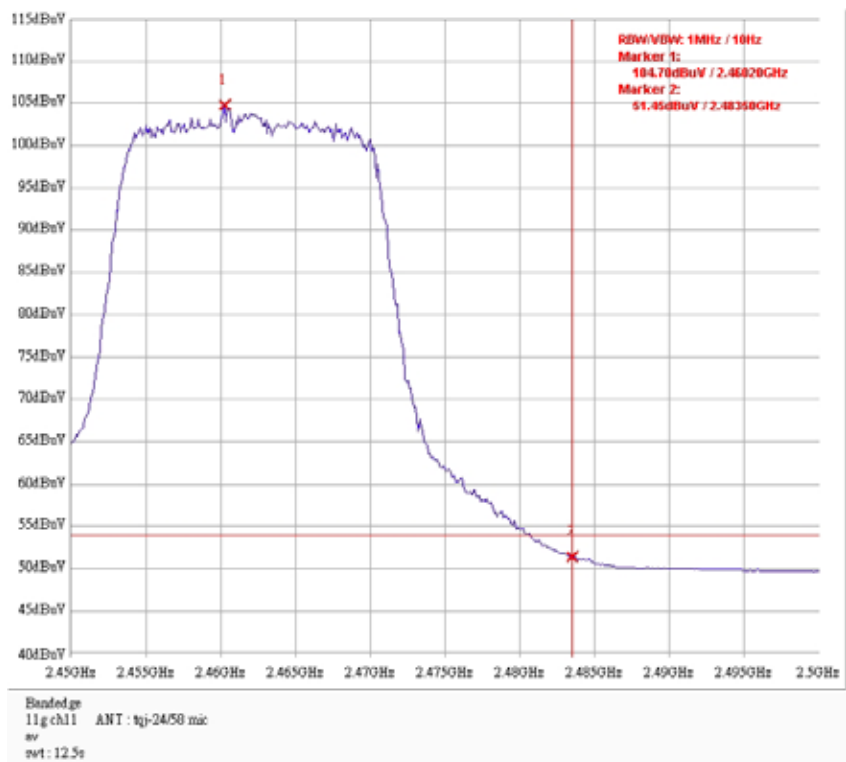

**Antenna 6 : TQJ-24/58MICX6**

**Band edge @802.11n HT20 mode channel 1 PK**

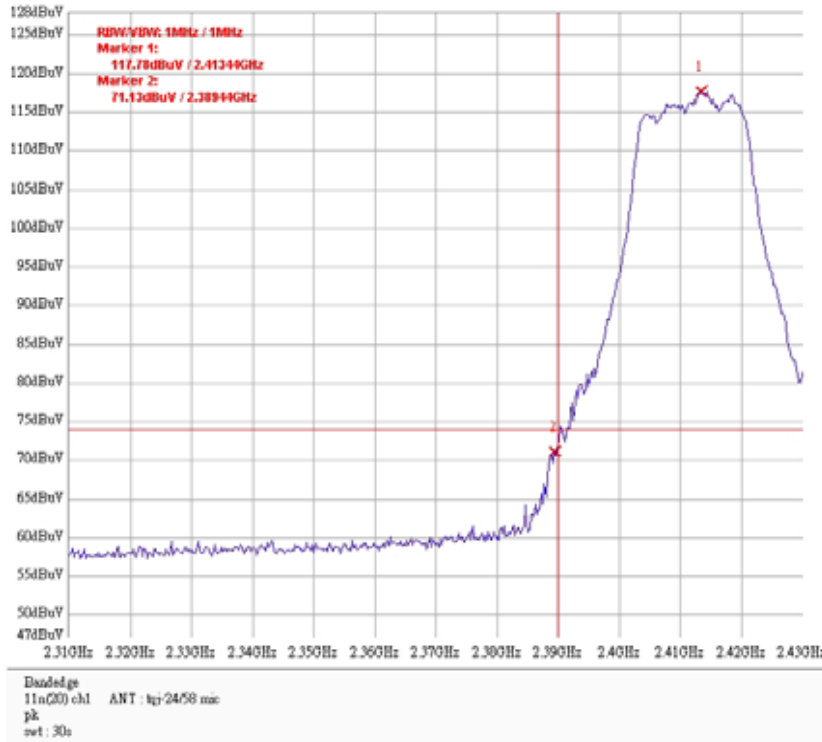

**Band edge @802.11n HT20 mode channel 1 AV**

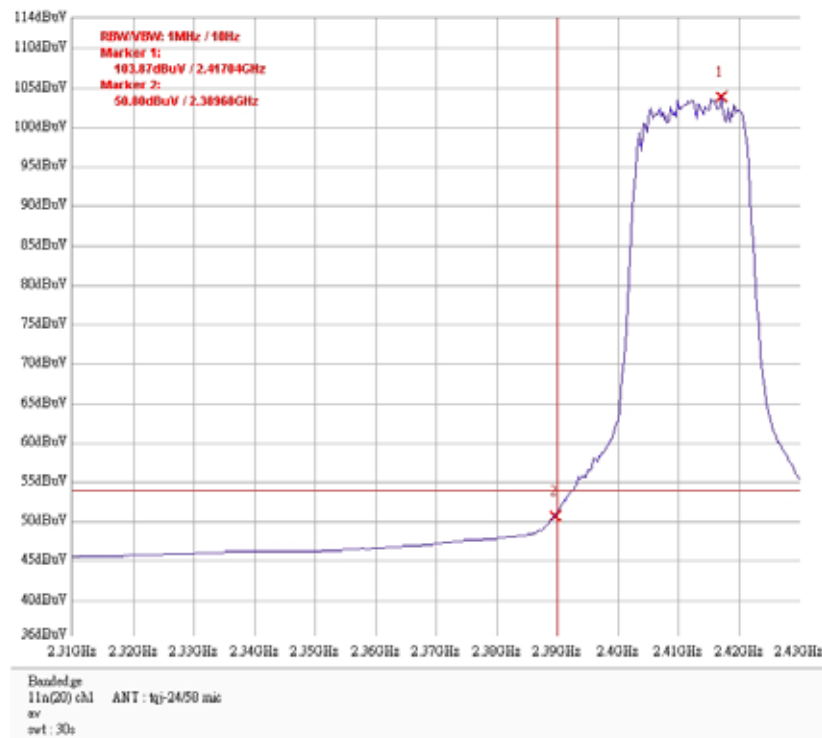

**Antenna 6 : TQJ-24/58MICX6**

**Band edge @802.11n HT20 mode channel 11 PK**

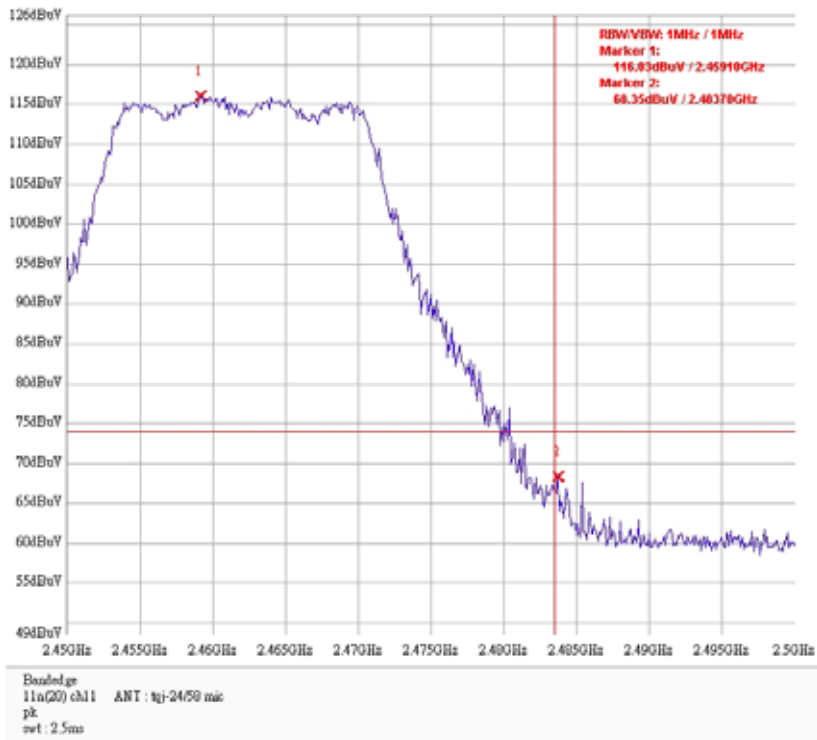

**Band edge @802.11n HT20 mode channel 11 AV**

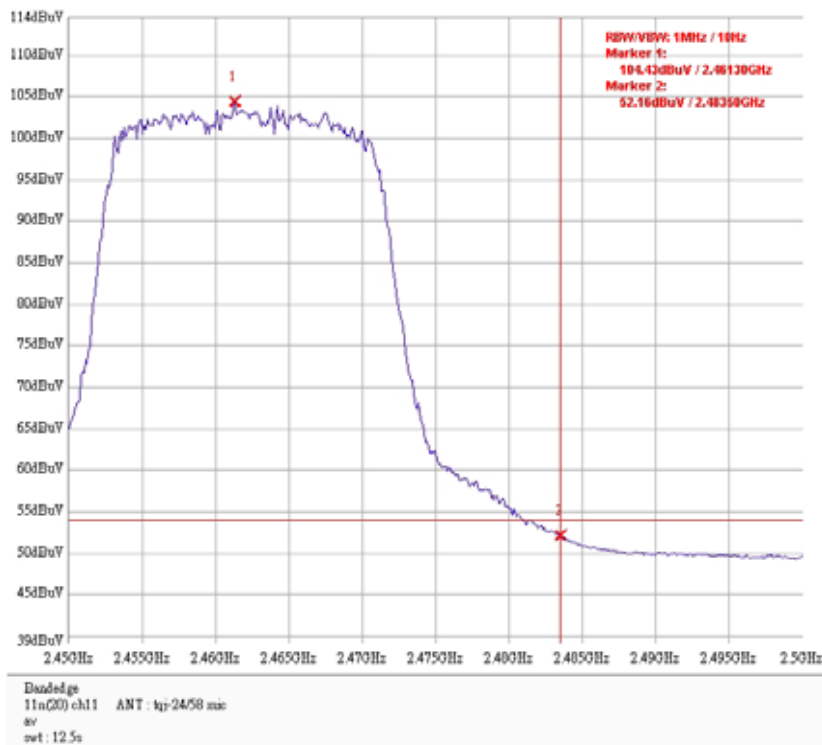

**Antenna 6 : TQJ-24/58MICX6**

**Band edge @802.11n HT40 mode channel 3 PK**

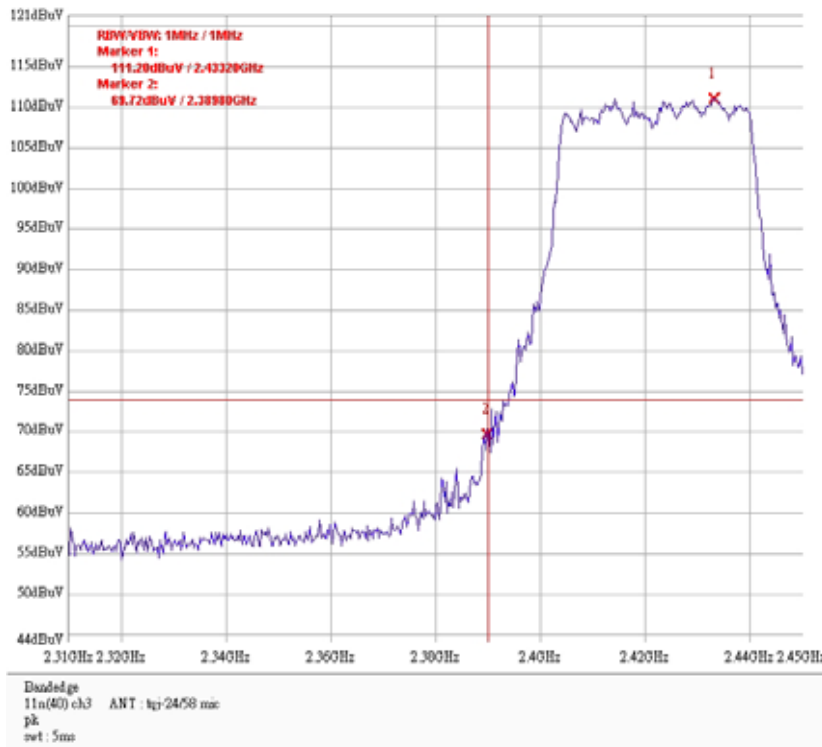

**Band edge @802.11n HT40 mode channel 3 AV**

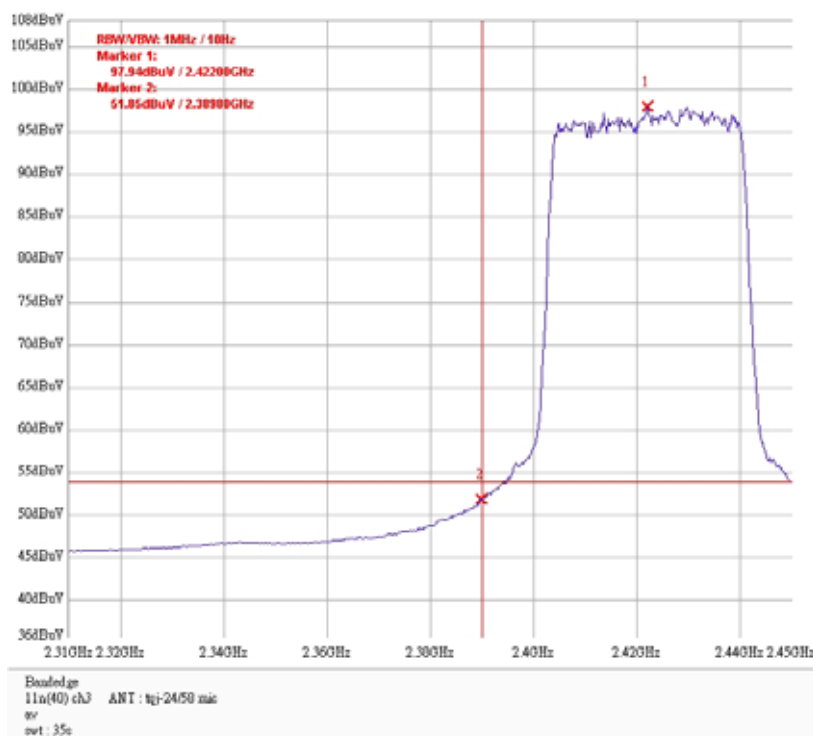



**Antenna 6 : TQJ-24/58MICX6**

**Band edge @802.11n HT40 mode channel 9 PK**

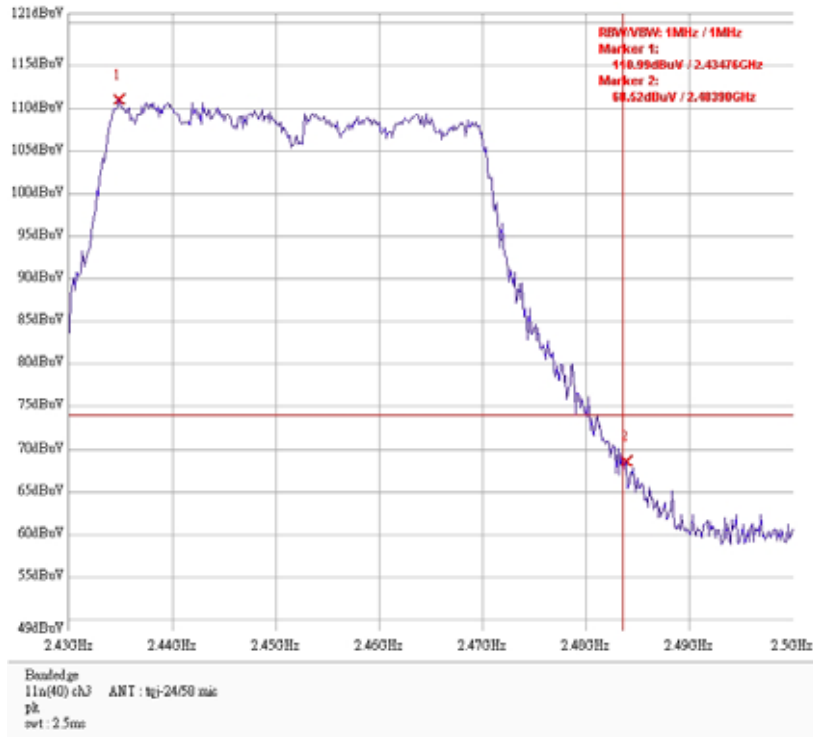

**Band edge @802.11n HT40 mode channel 9 AV**

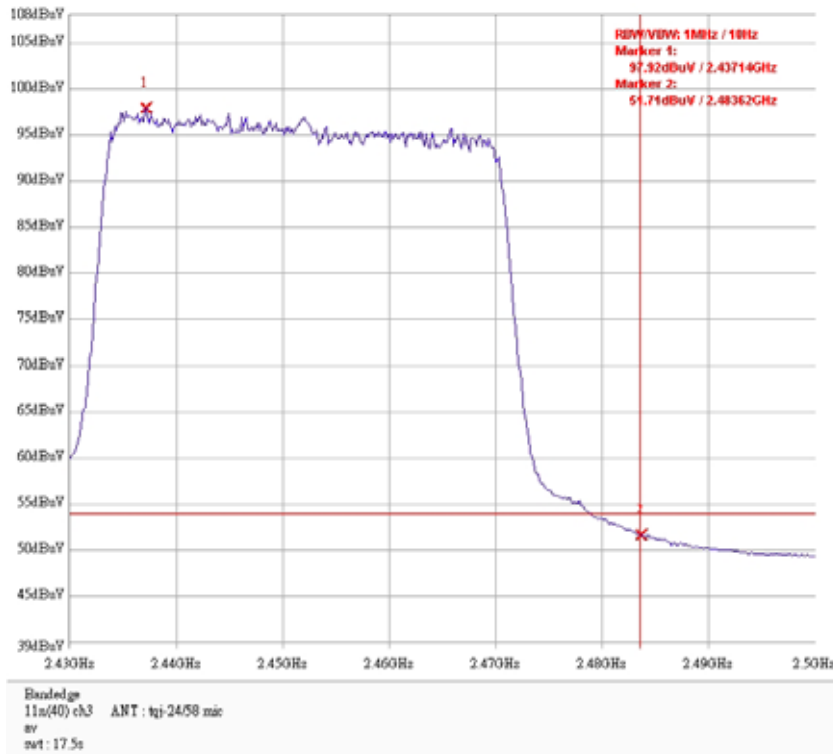

**Antenna 7 : TQJ-2458MIKX3**

**Band edge @ 802.11b mode channel 1 PK**

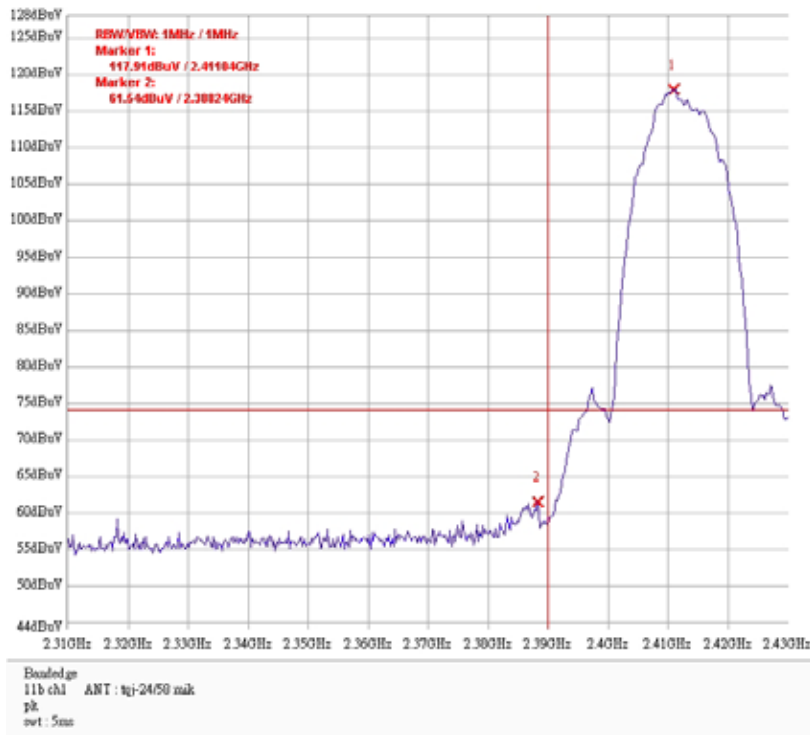

**Band edge @ 802.11b mode channel 1 AV**

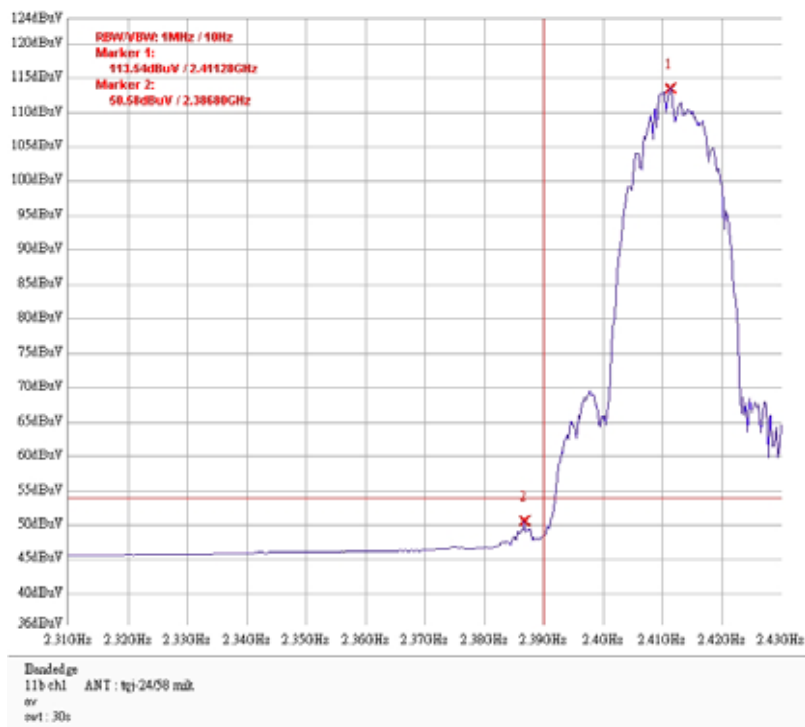

**Antenna 7 : TQJ-2458MIKX3**

**Band edge @ 802.11b mode channel 11 PK**

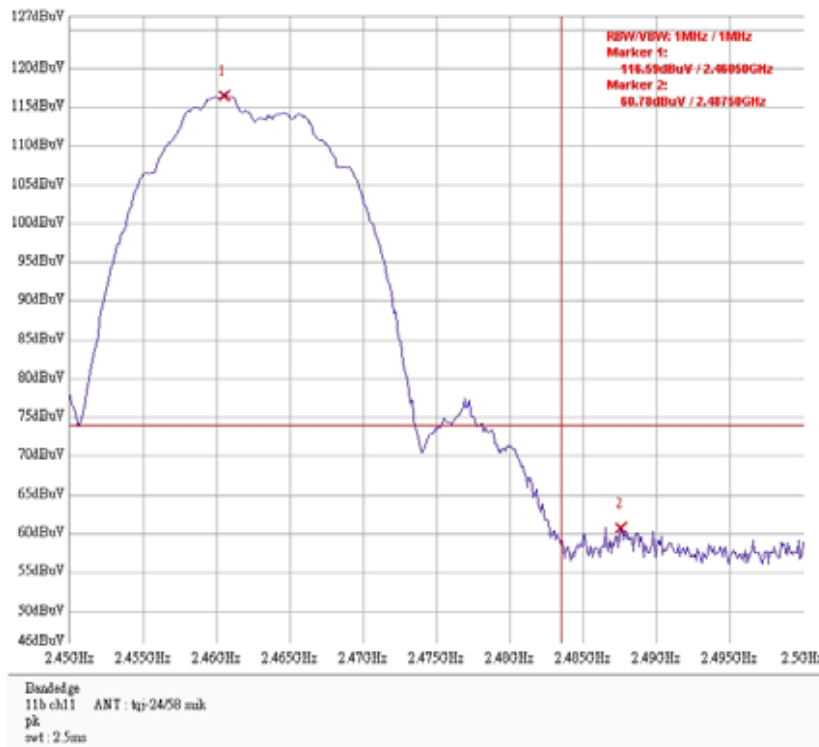

**Band edge @ 802.11b mode channel 11 AV**

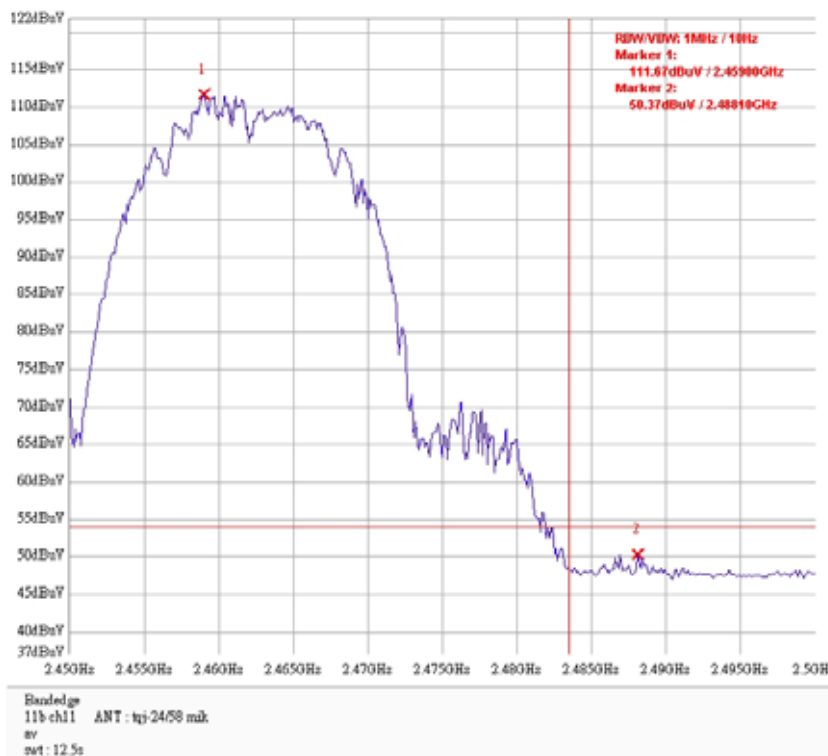

**Antenna 7 : TQJ-2458MIKX3**

**Band edge @ 802.11g mode channel 1 PK**

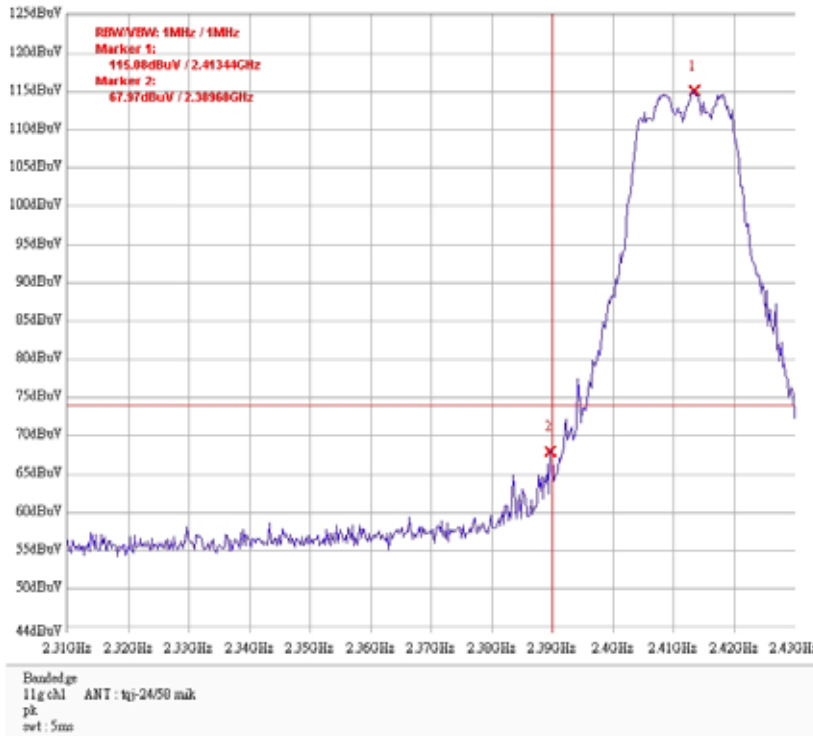

**Band edge @ 802.11g mode channel 1 AV**

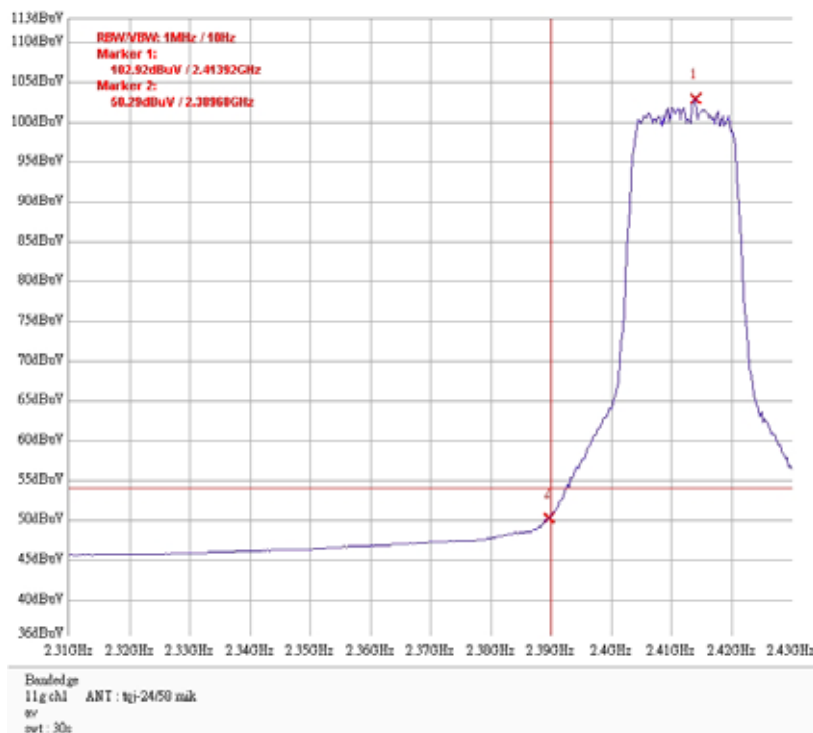

**Antenna 7 : TQJ-2458MIKX3**

**Band edge @ 802.11g mode channel 11 PK**

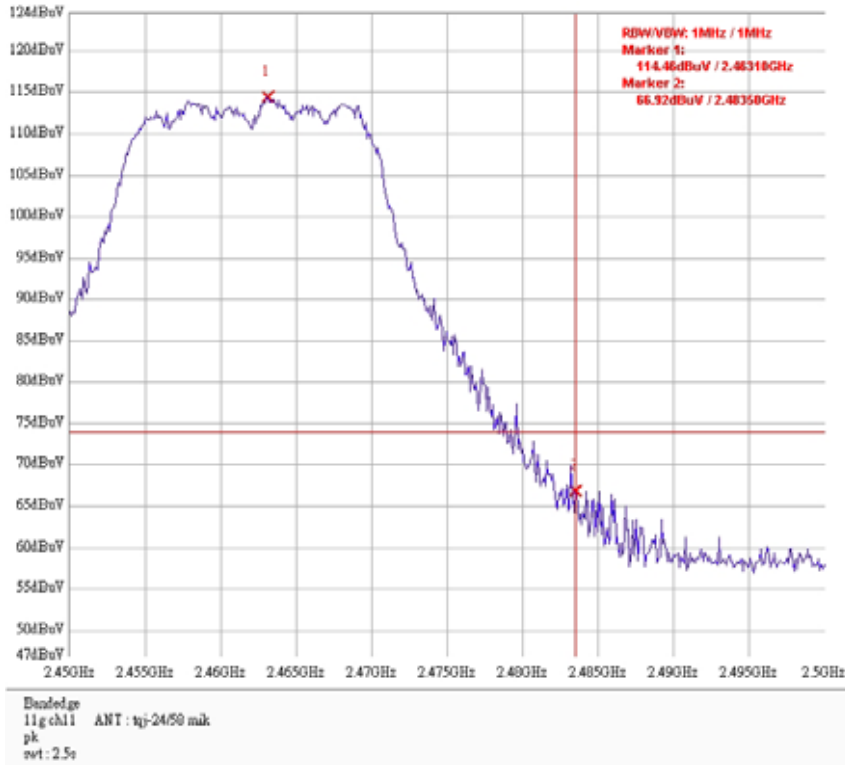

**Band edge @ 802.11g mode channel 11 AV**

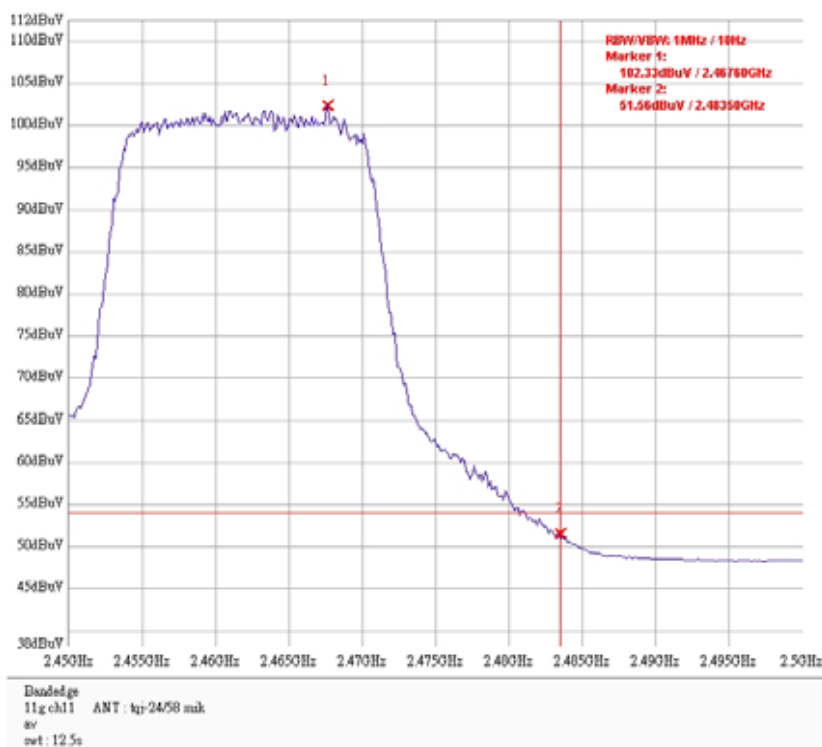

**Antenna 7 : TQJ-2458MIKX3**

**Band edge @802.11n HT20 mode channel 1 PK**

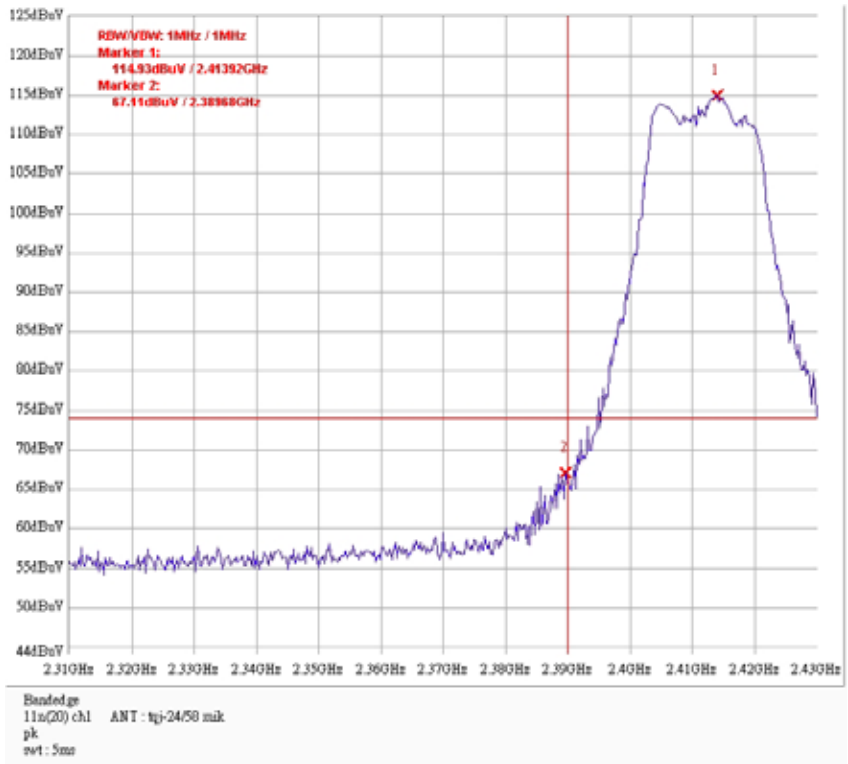

**Band edge @802.11n HT20 mode channel 1 AV**

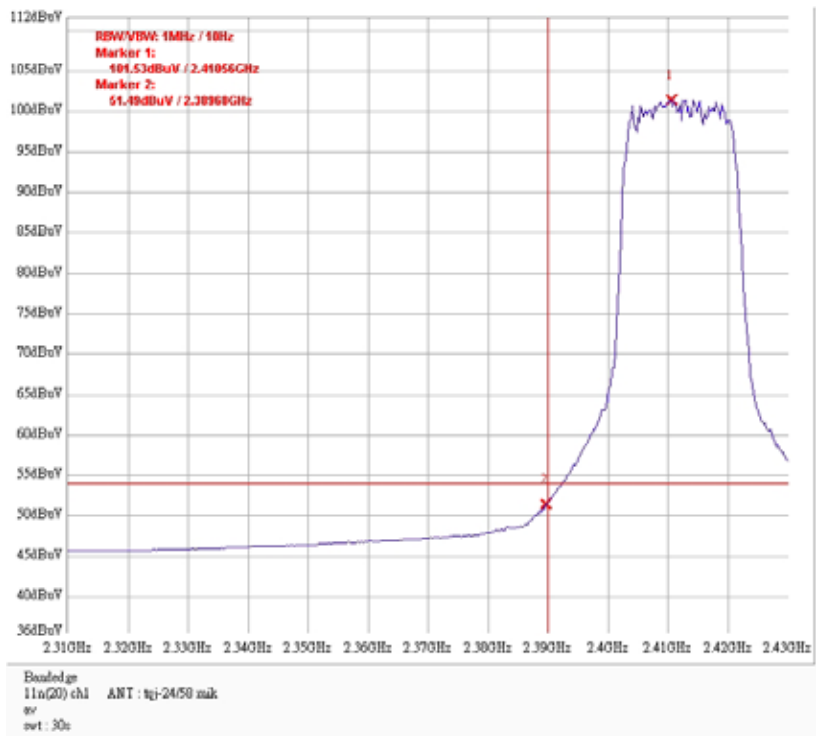

**Antenna 7 : TQJ-2458MIKX3**

**Band edge @802.11n HT20 mode channel 11 PK**

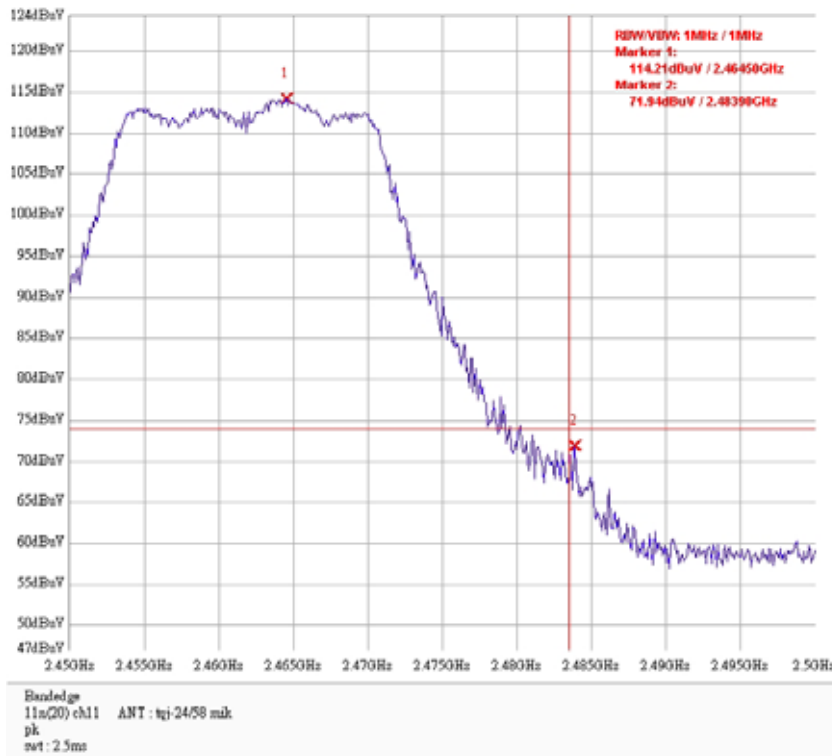

**Band edge @802.11n HT20 mode channel 11 AV**

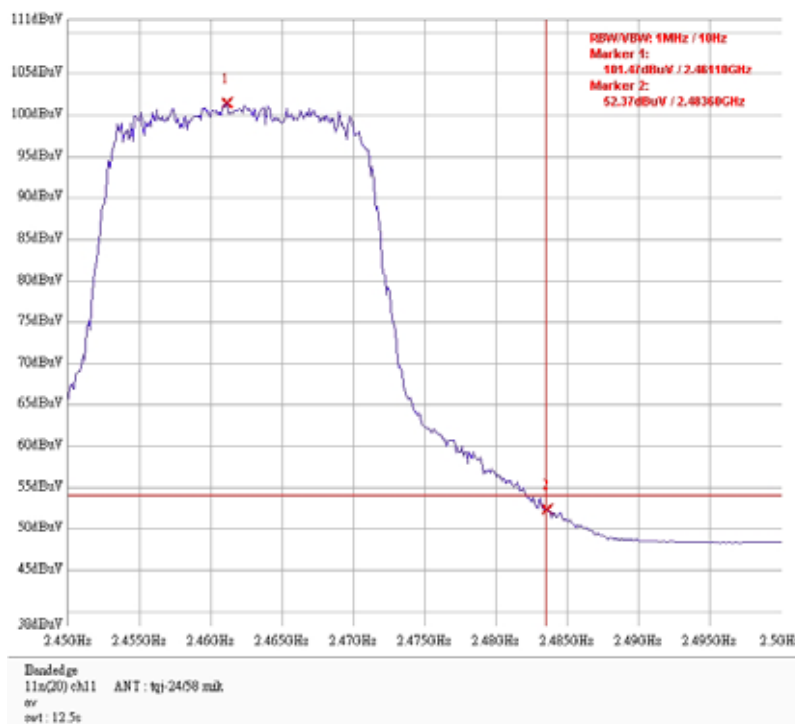

**Antenna 7 : TQJ-2458MIKX3**

**Band edge @802.11n HT40 mode channel 3 PK**

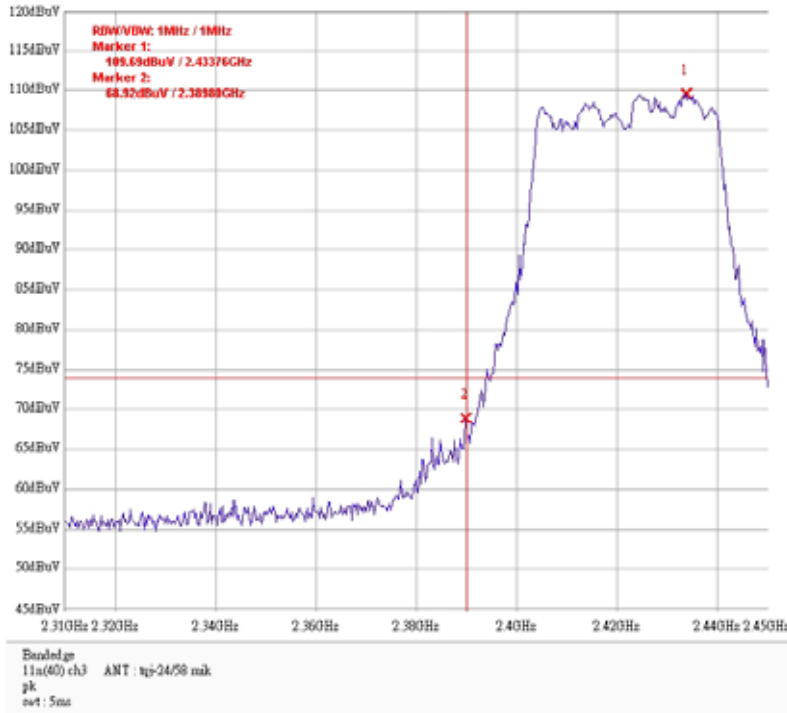

**Band edge @802.11n HT40 mode channel 3 AV**

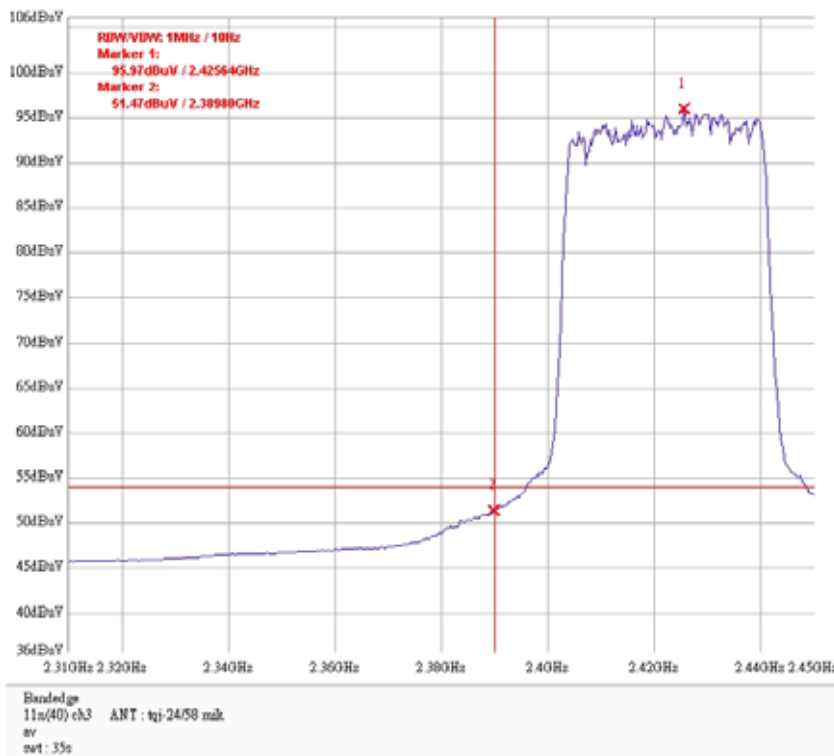



**Antenna 7 : TQJ-2458MIKX3**

**Band edge @802.11n HT40 mode channel 9 PK**

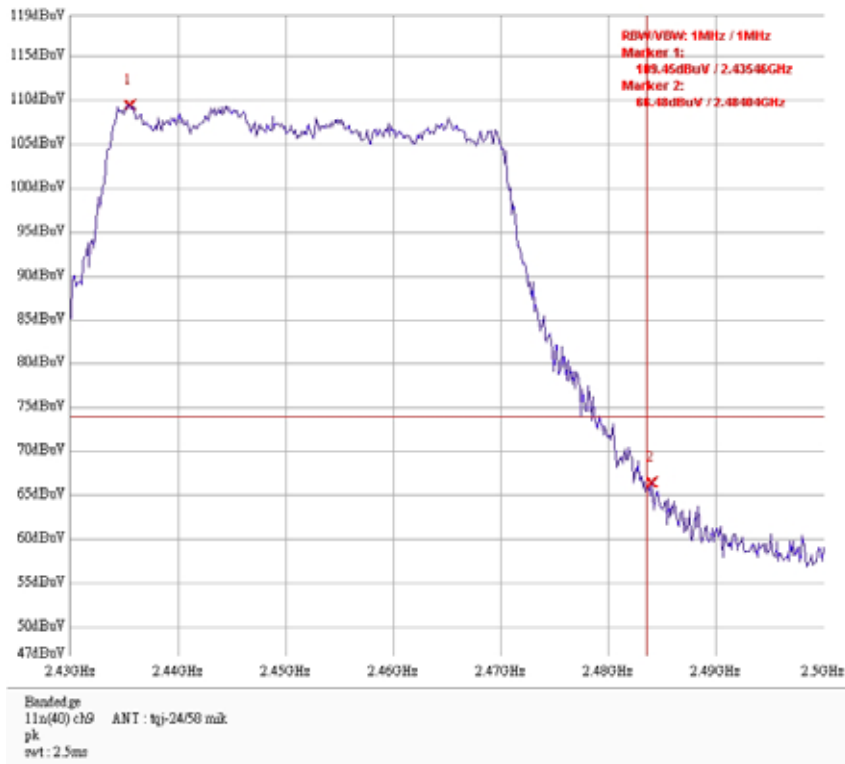

**Band edge @802.11n HT40 mode channel 9 AV**

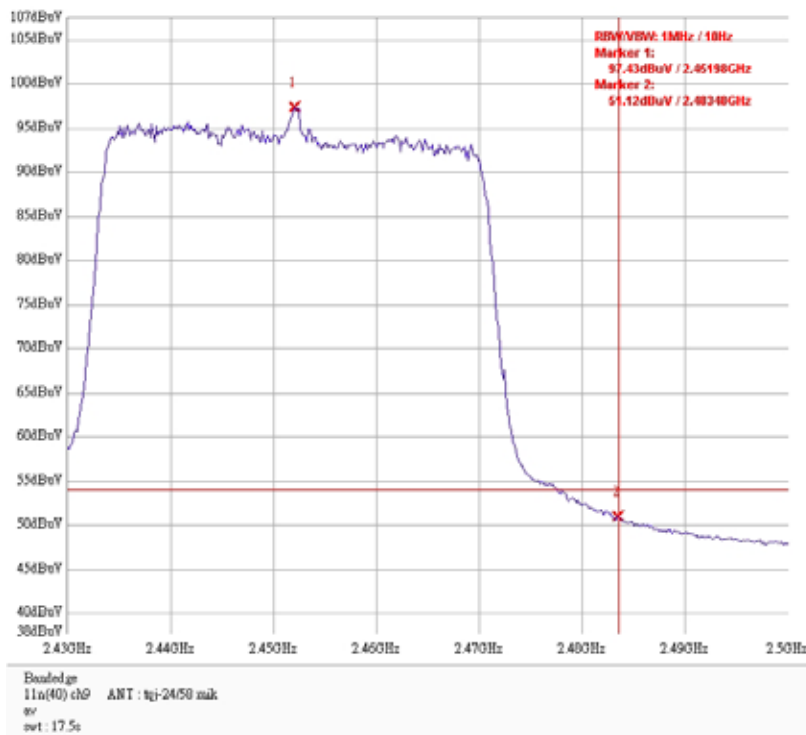

## 10. AC power line conducted emission

<b>Name of Test</b>	AC power line conducted emission
<b>Base Standard</b>	FCC 15.207

**Test Result:** Complies  
**Measurement Data:** See Tables & plots below

### Method of Measurement:

#### Reference FCC document: KDB558074, ANSI C63.4

The EUT are connected to the main power through a line impedance stabilization network (LISN). This provides a 50 ohm/50 uH coupling impedance for the measuring equipment. The peripheral devices are also connected to the main power through a LISN that provides a 50 ohm/50 uH coupling impedance with 50 ohm termination.

Both sides (Line and Neutral) of AC line are checked for maximum conducted interference. In order to find the maximum emission, the relative positions of equipment and all of the interface cables must be changed according to ANSI C63.4/2003 on conducted measurement.

The bandwidth of the field strength meter (R & S Test Receiver ESCS 30) is set at 9 kHz.

The EUT configuration please refer to the "Conducted set-up photo.pdf".

### Test Diagram:

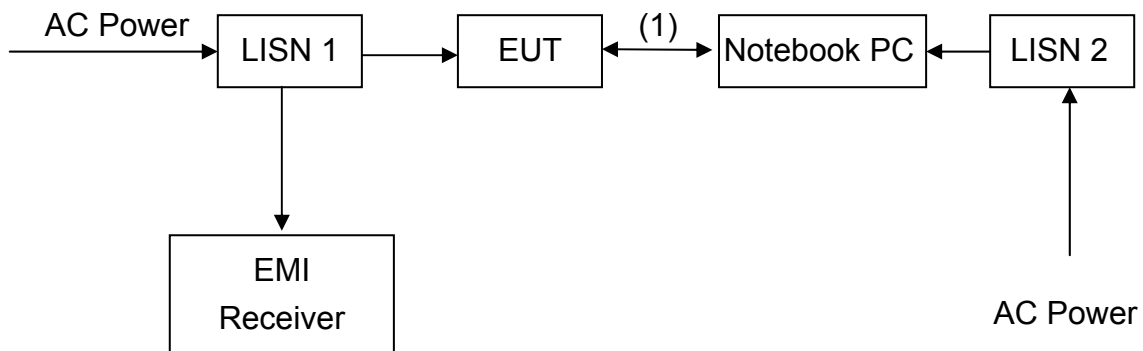

(1) RJ-45 UTP Cat.5 10 meter

**Emission Limit:**

Freq. (MHz)	Conducted Limit (dBuV)	
	Q.P.	Ave.
0.15~0.50	66 – 56*	56 – 46*
0.50~5.00	56	46
5.00~30.0	60	50

\*Decreases with the logarithm of the frequency.

**Note:** The EUT was tested while in normal communication mode.

Phase : Line  
EUT : H3C WA2620E-AGN  
Test Condition : Normal operating mode

Frequency (MHz)	Corr. Factor (dB)	Level Qp (dBuV)	Limit Qp (dBuV)	Level Av (dBuV)	Limit Av (dBuV)	Margin (dB)	
						Qp	Av
0.16	0.81	60.03	65.38	49.68	55.38	-5.36	-5.71
0.22	0.73	49.48	62.96	39.71	52.96	-13.49	-13.26
0.32	0.32	48.31	59.62	45.62	49.62	-11.30	-3.99
0.38	0.16	41.27	58.30	37.35	48.30	-17.03	-10.95
0.54	0.11	35.80	56.00	33.20	46.00	-20.20	-12.80
14.14	0.77	30.04	60.00	21.42	50.00	-29.96	-28.58

**Remark:**

1. Correction Factor (dB) = LISN Factor (dB) + Cable Loss (dB)
2. Margin (dB) = Level (dBuV) – Limit (dBuV)

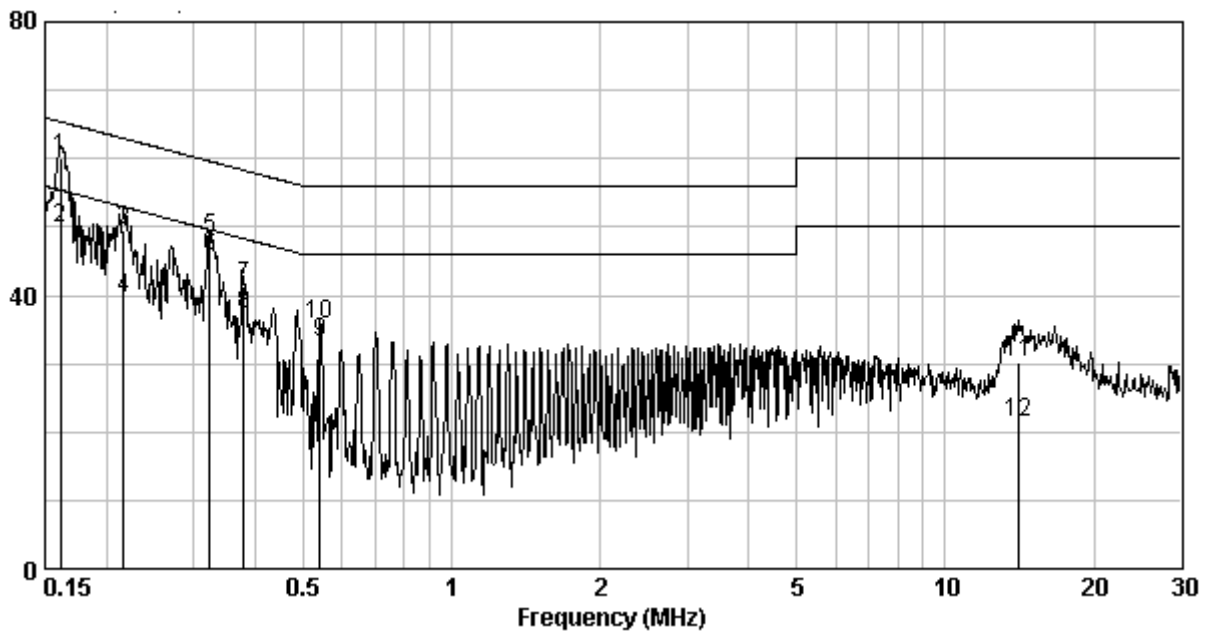

Phase : Neutral  
EUT : H3C WA2620E-AGN  
Test Condition : Normal operating mode

Frequency (MHz)	Corr. Factor (dB)	Level Qp (dBuV)	Limit Qp (dBuV)	Level Av (dBuV)	Limit Av (dBuV)	Margin (dB)	
						Qp	Av
0.16	0.11	59.31	65.30	47.13	55.30	-5.99	-8.17
0.22	0.11	48.13	62.96	38.07	52.96	-14.84	-14.90
0.27	0.11	42.60	61.07	34.24	51.07	-18.47	-16.83
0.33	0.11	48.73	59.57	40.33	49.57	-10.85	-9.25
0.54	0.11	33.29	56.00	29.85	46.00	-22.71	-16.15
14.67	0.51	29.86	60.00	20.75	50.00	-30.14	-29.25

**Remark:**

1. Correction Factor (dB)= LISN Factor (dB) + Cable Loss (dB)
2. Margin (dB) = Level (dBuV) – Limit (dBuV)

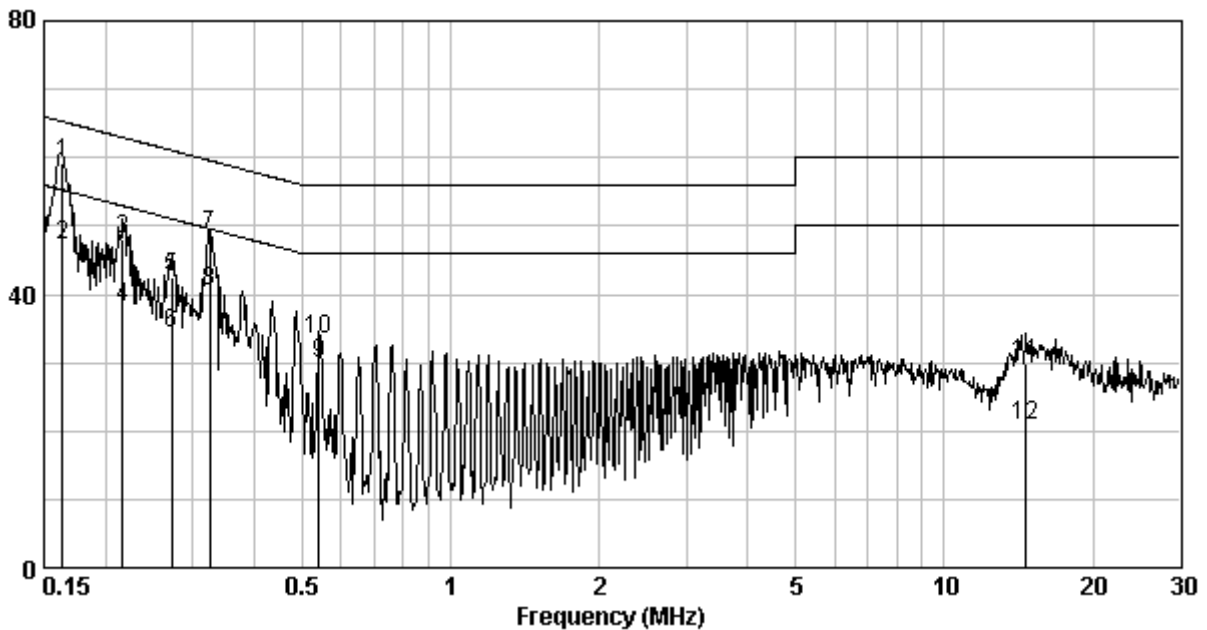

**APPENDICES**

## Appendix A: Test Equipment List

Equipment	Brand	Model No.
EMI Test Receiver	Rohde & Schwarz	ESCS 30
Spectrum Analyzer	Rohde & Schwarz	FSP 30
Spectrum Analyzer	Rohde & Schwarz	FSEK 30
Signal Generator	Rohde & Schwarz	SMR27
Horn Antenna	SCHWARZBECK	BBHA 9120 D
Horn Antenna	SCHWARZBECK	BBHA 9170
Bilog Antenna	SCHWARZBECK	VULB 9168
Pre-Amplifier	MITEQ	919981
Pre-Amplifier	MITEQ	828825
Controller	HDGmbH	CM 100
Antenna Tower	HDGmbH	MA 2400
LISN	Rohde & Schwarz	ESH3-Z5
Wideband Peak Power Meter/ Sensor	Anritsu	ML5495A/ MA2411B
Temperature Humidity Test Chamber	Juror	TR-4010

- Note: 1. The above equipments are within the valid calibration period.  
 2. The test antennas (receiving antenna) are calibration per 3 years.  
 3. The video bandwidth of the power meter and sensor can be up to 65 MHz.

### Measurement Uncertainty:

Measurement uncertainty was calculated in accordance with TR 100 028-1.

Parameter	Uncertainty
Radiated Emission	±5.056 dB
Conducted Emission	±2.786 dB

This uncertainty represents an expanded uncertainty expressed at approximately the 95 % confidence level using a coverage factor of k=2.