



243 Jubug-Ri, Yangji-Myeon, Yongin-Si, Gyeonggi-Do, Korea 449-822

Tel: +82-31-323-6008 Fax: +82-31-323-6010

<http://www.ltalab.com>

Dates of Tests: April 02~24, 2012

Test Report S/N: LR500111204H

Test Site : LTA CO., LTD.

## CERTIFICATION OF COMPLIANCE

FCC ID

**O99TJ-3400U**

APPLICANT

**TecNet International Inc.**

<b>Device Category</b>	:	<b>VHF FM Transceiver</b>
<b>Manufacturing Description</b>	:	<b>FM TRANSCEIVER</b>
<b>Manufacturer</b>	:	<b>TecNet International Inc.</b>
<b>Trade mark</b>	:	<b>TecNet</b>
<b>Model name</b>	:	<b>TJ-3400U</b>
<b>Variet Model name</b>	:	<b>TJ-3400</b>
<b>Serial number</b>	:	<b>Identical prototype</b>
<b>FCC Rule Part(s)</b>	:	<b>§2, §90</b>
<b>Frequency Range</b>	:	<b>440 ~ 470MHz</b>
<b>RF Output Power</b>	:	<b>2W</b>
<b>Channel Separation</b>	:	<b>12.5kHz</b>
<b>Emission Designators:</b>	:	<b>10K4F3E</b>
<b>Data of issue</b>	:	<b>April 25, 2012</b>

This test report is issued under the authority of:

The test was supervised by:

Kyu-Hyun Lee, Manager

Ki-Hun Cho, Test Engineer

This test result only responds to the tested sample. It is not allowed to copy this report even partly without the allowance of the test laboratory. The report must not be used by the client to claim product certification, approval, or endorsement by NVLAP, NIST, or any agency of the Federal Government.



NVLAP LAB Code.: 200723-0

---

## TABLE OF CONTENTS

1. GENERAL INFORMATION'S .....	3
2. INFORMATION'S ABOUT TEST ITEM .....	4
3. TEST REPORT .....	5
3.1 SUMMARY OF TESTS .....	5
3.2 REQUIREMENTS .....	6
3.2.1 CARRIER OUTPUT POWER (CONDUCTED) .....	6
3.2.2 UNWANTED EMISSIONS (TRANSMITTER CONDUCTED) (CONDUCTED) ----	7
3.2.3 FIELD STRENGTH OF SPURIOUS RADIATION .....	10
3.2.4 EMISSION MASKS (OCCUPIED BANDWIDTH) .....	14
3.2.5 TRANSIENT FREQUENCY BEHAVIOR .....	15
3.2.6 AUDIO FREQUENCY RESPONSE .....	16
3.2.7 MODULATION LIMITING .....	17
3.2.8 FREQUENCY STABILITY (TEMPERATURE VARIATION) .....	18
3.2.9 FREQUENCY STABILITY (VOLTAGE VARIATION) .....	19
3.2.10 NECESSARY BANDWIDTH AND EMISSION BANDWIDTH .....	20
<b>APPENDIX</b>	
APPENDIX I TEST EQUIPMENT USED FOR TESTS .....	21
APPENDIX II TEST PLOTS .....	23

## 1. General information's

### 1-1 Test Performed

Company name : LTA Co., Ltd.  
 Address : 243, Jubug-ri, Yangji-Myeon, Youngin-Si, Kyunggi-Do, Korea. 449-822  
 Web site : <http://www.ltalab.com>  
 E-mail : [chahn@ltalab.com](mailto:chahn@ltalab.com)  
 Telephone : +82-31-323-6008  
 Facsimile : +82-31-323-6010

Quality control in the testing laboratory is implemented as per ISO/IEC 17025 which is the “General requirements for the competents of calibration and testing laboratory”.

### 1-2 Accredited agencies

LTA Co., Ltd. is approved to perform EMC testing by the following agencies:

Agency	Country	Accreditation No.	Validity	Reference
NVLAP	U.S.A	200723-0	2012-09-30	ECT accredited Lab.
RRL	KOREA	KR0049	2013-04-24	EMC accredited Lab.
FCC	U.S.A	610755	2014-04-27	FCC filing
FCC	U.S.A	649054	2013-04-13	FCC CAB
VCCI	JAPAN	R2133(10m), C2307	2014-06-21	VCCI registration
VCCI	JAPAN	T-2009	2013-12-23	VCCI registration
IC	CANADA	IC5799	2012-05-14	IC filing

## 2. Information's about test item

### 2-1 Client & Manufacturer

Company name : TecNet International Inc.  
 Address : 1420 N.W. Vivion Road Suite 109 Kansas City Missouri United States  
 TEL / FAX : 816-584-8638 / 816-649-4943

### 2-2 Equipment Under Test (EUT)

Trade name : VHF FM Transceiver  
 FCC ID : O99TJ-3400U  
 Model name : TJ-3400U  
 Variet Model name : TJ-3400  
 Serial number : Identical prototype  
 Date of receipt : April 2, 2012  
 EUT condition : Pre-production, not damaged  
 Frequency Range : 440 ~ 470MHz  
 RF output power : 2W  
 Channel Separation : 12.5kHz  
 Duty cycle TX power : 5(Tx) : 5(Rx) : 90(Stand-by)  
 Speaker Impedance : 16 ohm  
 Audio Output Power : 1.0Watt across an 16-ohm load  
 Power Source : DC 3.7V by battery (Li-ion)  
 Firmware version : V1.0

### 2-3 Tested frequency

	LOW	MID	HIGH
Frequency (MHz)	440	455	470

### 2-4 Ancillary Equipment

Equipment	Model No.	Serial No.	Manufacturer
-	-	-	-

### 2-5 Model Description

Model name	Type Description
TJ-3400U	Reference Model
TJ-3400	Different Front case design. (All Same Power, RF Circuit)

### 3. Test Report

#### 3.1 Summary of tests

FCC Part Section(s)	Parameter	Status (note 1)
2.1046 (a)	Carrier Output Power (Conducted)	C
2.1051	Unwanted Emissions (Transmitter Conducted)	C
2.1053 (a)	Field Strength of Spurious Radiation	C
2.1049 (c) (1)	Emission Masks (Occupied Bandwidth)	C
90.214	Transient Frequency Behavior	C
2.1047 (a)	Audio Low Pass Filter (Voice Input)	C
2.1047 (a)	Audio Frequency Response	C
2.1047 (b)	Modulation Limiting	C
2.1055 (a) (1)	Frequency Stability (Temperature Variation)	C
2.1055 (b) (1)	Frequency Stability (Voltage Variation)	C
2.202 (g)	Necessary Bandwidth and Emission Bandwidth	C

*Note 1:* C=Complies NC=Not Complies NT=Not Tested NA=Not Applicable

*Note 2:* The data in this test report are traceable to the national or international standards.

The sample was tested according to the following specification:

\*FCC Rules and Regulations, Volume II; Part 2, Sub-part J, Sections 2.947, 2.1033(c), 2.1046, 2.1047, 2.1079, 2.1051, 2.1053, 2.1055, 2.1057 and Part 90.

\*ANSI C63.4

\*TIA/EIA 603, Edition C

## 3.2 Transmitter requirements

### 3.2.1 Carrier Output Power (Conducted)

#### Definition:

- The carrier power output for a transmitter for this service is the power available at the output terminals of the transmitter when the output terminals are connected to the standard transmitter load.

Specification : 47 CFR 2.1046 (a)  
 Test method : ANSI/TIA/EIA-603-C-2004

#### Measurement Procedure:

- The EUT was connected to a resistive coaxial attenuator of normal load impedance, and the unmodulated output power was measured by means of an R.F. Power Meter.

TEST CONDITIONS		Carrier power(W)		
Power level (W)	Channel Spacing (kHz)	440 MHz	455 MHz	470 MHz
2	12.5	1.995	1.986	1.972
Measurement uncertainty		± 0,45dB		

### 3.2.2 Unwanted Emissions (Transmitter Conducted)

**Definition:**

- Conducted spurious emissions are emissions at the antenna terminals on a frequency or frequencies which are outside a band sufficient to ensure transmission of information of required quality for the class of communication desired.

Specification	: 47 CFR 2.1051
Test method	: ANSI/TIA/EIA-603-C-2004

**Measurement Procedure:**

- The emissions were measured for the worst case as follows:
  - (1) Within a band of frequencies defined by the carrier frequency plus and minus one channel.
  - (2) From the lowest frequency generated in the EUT and to at least the 10th harmonic of the carrier frequency, or 40GHz, whichever is lower.
- The magnitude of spurious emissions that are attenuated more than 20dB below the permissible value need not be specified.

**LIMIT**

---

---

$$= 43 + 10 \log_{10} (P) \text{ dBc (or -13 dBm)}$$

---

---

**Measurement Data: 12.5KHz**

OPERATING FREQUENCY : 440 MHz  
 MEASURED OUTPUT POWER :: 33.00 dBm = 1.995 W  
 MODULATION SIGNAL : FM  
 LIMIT :  $43 + 10 \log_{10} (W) = \underline{45.99}$  dBc

Freq. (MHz)	Level (dBm)	Level (dBc)	Freq. (MHz)	Level (dBm)	Level (dBc)
879.99	-35.20	68.20			
2640.00	-32.85	65.85			
3080.00	-30.27	63.27			

Remarks

No other emissions were detected at a level greater than 20dB below limit.

**Measurement Data:**

OPERATING FREQUENCY : 455 MHz  
 MEASURED OUTPUT POWER : 32.98 dBm = 1.986 W  
 MODULATION SIGNAL : FM  
 LIMIT :  $43 + 10 \log_{10} (W) = \underline{45.97}$  dBc

Freq. (MHz)	Level (dBm)	Level (dBc)	Freq. (MHz)	Level (dBm)	Level (dBc)
1365.00	-30.25	63.23			
2730.00	-30.93	63.91			
3185.00	-30.46	63.44			

Remarks

No other emissions were detected at a level greater than 20dB below limit.



**Measurement Data: 12.5KHz**

OPERATING FREQUENCY : 470 MHz  
 MEASURED OUTPUT POWER : 32.95 dBm = 1.972 W  
 MODULATION SIGNAL : FM  
 LIMIT :  $43 + 10 \log_{10} (W) =$  45.94 dBc

Freq. (MHz)	Level (dBm)	Level (dBc)	Freq. (MHz)	Level (dBm)	Level (dBc)
2820.00	-31.88	64.83			
3280.00	-31.69	64.64			

Remarks

No other emissions were detected at a level greater than 20dB below limit.

### 3.2.3 Field Strength of Spurious Radiation- Transmitter

#### Definition:

- Radiated spurious emissions are emissions from the equipment when transmitting into a non-radiating load on a frequency or frequencies which are outside an occupied band sufficient to ensure transmission of information of required quality for the class of communications desired.

Specification	: 47 CFR 2.1053(a)
Test method	: ANSI/TIA/EIA-603-C-2004

#### Test Setup Diagram:

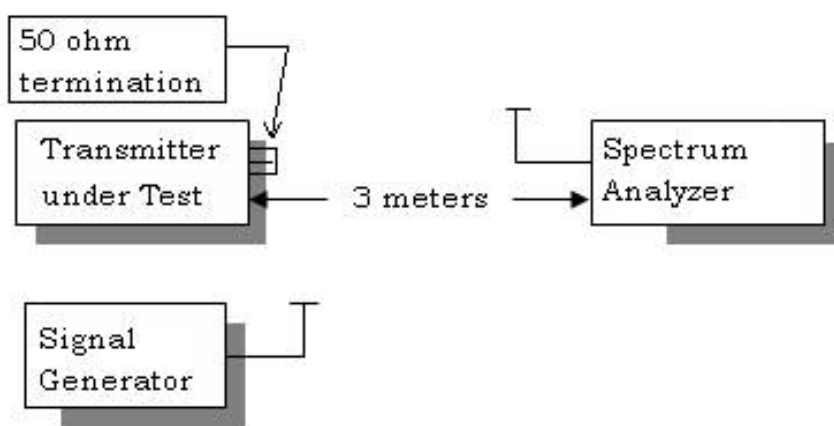

#### Measurement Procedure:

1. Preliminary radiated measurements were performed to determine the frequencies where the significant emissions might be found. With the EUT at one set position and the measurement antenna at a set height (i.e. without maximizing), the radiated emissions were measured using a peak detector and automatically plotted. The broadband measuring antenna was positioned at a 3 meter distance from the EUT. This data was then automatically plotted.
2. All significant broadband and narrowband signals found in the preliminary sweeps were then measured using a peak detector at a test distance of 3 meters. The measurements were made with a bilog antenna over the frequency range of 30MHz to 1GHz, and a double ridged waveguide antenna was used for frequencies above 1GHz.
3. To ensure that maximum emission levels were measured, the following steps were taken:
  - a. The EUT was rotated using wooden turn table so that all of its sides were exposed to the receiving antenna.
  - b. Since the measuring antennas are linearly polarized, both horizontal and vertical field components were measured.
  - c. The measuring antenna was raised and lowered from 1 to 4 meters for each antenna polarization to maximize the readings.

The equivalent power was determined from the field intensity levels measured at 3 meters using the substitution method. To determine the emission power, another antenna was set in place of the EUT and connected to a calibrated signal generator. (A tuned dipole was used for all measurements below 1GHz and a double ridged waveguide antenna was used for all measurements above 1GHz.)

The output of the signal generator was adjusted to match the received level at the spectrum analyzer.

The signal level was recorded. The reading was corrected to compensate for cable loss, as required, and for frequencies above 1GHz, increased by the gain of the waveguide.

## LIMIT

---

$$= 43 + 10 \log_{10} (P) \text{ dBc (or -13 dBm)}$$

---

**Measurement Data: Attached for Worst Case**

**Measurement Data:**

OPERATING FREQUENCY : 455 MHz  
 MEASURED OUTPUT POWER : 32.98 dBm = 1.986 W  
 MODULATION SIGNAL : FM  
 LIMIT :  $43 + 10 \log_{10} (W) =$  45.97 dBc

Freq. (MHz)	Pol. (H/V)	Reading (dBm/m)	C.F (dBm/m)	Level (dBm/m)	Level (dBc)
1365.0	H	-57.51	5.09	-52.42	85.40

Remarks

No emissions were detected at a level greater than 20dB below limit.

**Radiated Emissions – Wireless mode**



243 Jubug-ri, yangi-Myeon, Youngin-si,  
Gyeonggi-do 449-822 Korea  
Tel :+82-31-3236008,9  
Fax:+82-31-3236010

EUT/Model No.: TJ-3400U TEST MODE: Wireless mode  
Temp Humi : 13 / 30 Tested by: PARK.H.W

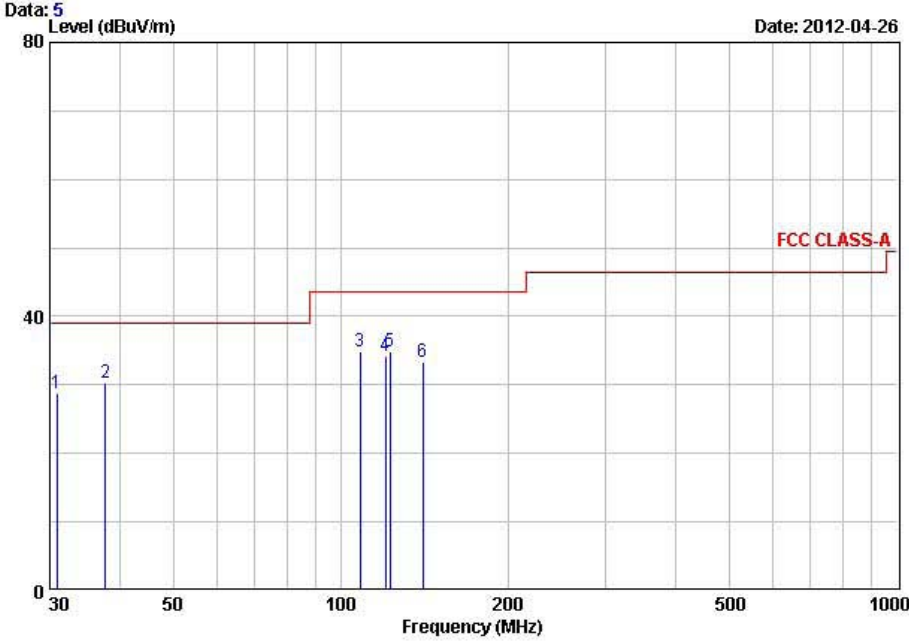

Freq	Reading	C.F	Result	Limit	Margin	Height	Angle	Polarity
MHz	dBuV/m	dB/m	dBuV/m	QP	dB	cm	deg	
1	30.88	44.50	-15.66	28.84	40.00	11.16	100	87 VERTICAL
2	37.76	45.20	-14.96	30.24	40.00	9.76	100	214 VERTICAL
3	108.32	50.00	-15.08	34.92	43.50	8.58	125	25 HORIZONTAL
4	120.62	48.30	-14.00	34.30	43.50	9.20	235	245 HORIZONTAL
5	122.72	48.70	-13.79	34.91	43.50	8.59	261	362 HORIZONTAL
6	140.45	45.50	-12.21	33.29	43.50	10.21	100	287 VERTICAL

Remarks: C.F (Correction Factor) = Antenna factor + Cable loss - Preamp gain

Note. No other emissions were detected at a level greater than 20dB below limit include from 9KHz to 30MHz.

### 3.2.4 Emission Masks (Occupied Bandwidth)

**Definition:**

- The term transmitter Sideband Spectrum denotes the sideband energy produced at a discrete frequency separation from the carrier up to the test bandwidth due to all sources of unwanted noise within the transmitter in a modulated condition.

Specification	: 47 CFR 2.1049(c)(1)
Test method	: ANSI/TIA/EIA-603-C-2004

**Measurement Procedure:**

- The EUT and test equipment were set up as shown on the following page, with the Spectrum Analyzer connected.
- For EUTs supporting audio modulation, the audio signal generator was adjusted to the frequency of maximum response and with output level set for  $\pm 2.5 / \pm 1.25$  kHz deviation (or 50% modulation). With level constant, the signal level was increased 16dB.
- For EUTs supporting digital modulation, the digital modulation mode was operated to its maximum extent.
- The Occupied Bandwidth was measured with the Spectrum Analyzer controls set as shown on the test results.

**Measurement Data:**

- Refer to the Appendix II.

### 3.2.5 Transient Frequency Behavior

**Definition:**

- The transient frequency behavior is a measure of the difference, as a function in time, of the actual transmitter frequency to the assigned transmitter frequency when the transmitted RF output power is switched on or off.

Specification	: 47 CFR 90.214
Test method	: ANSI/TIA/EIA-603-C-2004

**Measurement Procedure:**

- The EUT was set up as shown on the attached page, following TIA/EIA-603 steps a, b, and c as a guide.
- The transmitter was turned on.
- Sufficient attenuation was provided so that the transmitter carrier level measured at the output of the combiner was 40 dB below the maximum input level of the test receiver. This level was recorded as step f.
- The transmitter was turned off.
- An RF signal generator (1) modulated with a 1 kHz tone at either 25, 12.5, or 6.25 kHz deviation, and set to the same frequency as the assigned transmitter frequency, (2) was adjusted to a level -20 dB below the level recorded for step f, as measured at the output of the combiner. This level was then fixed for the remainder of the test and is recorded at step h.
- The oscilloscope was set up using TIA/EIA-603 steps j and k as a guide, and to either 10 ms/div (UHF) or 5ms/div (VHF).
- The 30 dB attenuator was removed, the transmitter was turned on, and the level of the carrier at the output of the combiner was recorded as step l.
- The carrier on-time as referenced in TIA/EIA-603 steps m, n, and o was captured and plotted. The carrier off-time as referenced in TIA/EIA-603 steps p, q, r, and s was captured and plotted.
- For EUTs supporting audio modulation, the audio signal generator was adjusted to the frequency of maximum response and with output level set for  $\pm 2.5 / \pm 1.25$  kHz deviation (or 50% modulation). With level constant, the signal level was increased 16dB.
- For EUTs supporting digital modulation, the digital modulation mode was operated to its maximum extent.
- The Occupied Bandwidth was measured with the Spectrum Analyzer controls set as shown on the test results.

**Measurement Data:**

- Refer to the Appendix II.

### 3.2.6 Audio Low Pass Filter (Voice Input)

**Definition:**

- The Audio Low Pass Filter Response is the frequency response of the post limiter low pass filter circuit above 3000Hz.

Specification	:	47 CFR 2.1047(a)
Test method	:	ANSI/TIA/EIA-603-C-2004

**Measurement Procedure:**

- The EUT and test equipment were set up such that the audio input was connected at the input to the modulation limiter, and the modulated stage.
- The audio output was connected at the output to the modulated stage.

**Measurement Data:**

- Refer to the Appendix II.



### 3.2.7 Audio Frequency Response

**Definition:**

- The audio frequency response is the degree of closeness to which the frequency deviation of the transmitter follows a prescribed characteristic.

Specification	: 47 CFR 2.1047(a)
Test method	: ANSI/TIA/EIA-603-C-2004

**Measurement Procedure:**

- The audio signal input was adjusted to obtain 20% modulation at 1kHz, and this point was taken as the 0dB reference level.
- With input levels held constant and below limiting at all frequencies, the audio signal generator was varied from 300 Hz to 30 kHz.
- The response in dB relative to 1 kHz was then measured, using the HP 8901A Modulation Analyzer.

**Measurement Data:**

- Refer to the Appendix II.

### 3.2.8 Modulation Limiting

**Definition:**

- Modulation limiting refers to the transmitter circuits ability to limit the transmitter from producing deviations due to modulation in excess of a rated system deviation.

Specification	:	47 CFR 2.1047(b)
Test method	:	ANSI/TIA/EIA-603-C-2004

**Measurement Procedure:**

- The signal generator was connected to the input of the EUT as for "Frequency Response of the Modulating Circuit."
- The modulation response was measured for each of three frequencies (one of which was the frequency of maximum response), and the input voltage was varied and was observed on an HP 8901A Modulation Analyzer.
- The input level was varied from 30% modulation ( $\pm 1.5$  kHz deviation) to at least 20 dB higher than the saturation point.

**Measurement Data:**

- Refer to the Appendix II.

### 3.2.9 Frequency Stability

#### Definition:

- Modulation limiting refers to the transmitter circuits ability to limit the transmitter from producing deviations due to modulation in excess of a rated system deviation.

Specification	: 47 CFR 2.1055
Test method	: ANSI/TIA/EIA-603-C-2004

#### Measurement Procedure:

The frequency stability of the transmitter is measured by:

- Temperature: The temperature is varied from  $-30^{\circ}\text{C}$  to  $+60^{\circ}\text{C}$  using an environmental chamber.
- Primary Supply Voltage: The primary supply voltage is varied from 85% to 115% of the voltage normally at the input to the device or at the power supply terminals if cables are not normally supplied.

Specification- The frequency stability shall be sufficient to ensure that the fundamental emission stays within the authorized frequency block. The frequency stability of the transmitter shall be maintained within  $\pm 0.00025(\pm 2.5\text{ppm})$  of the center frequency.

Time Period and Procedure:

- The carrier frequency of the transmitter and the individual oscillators is measured at room temperature ( $25^{\circ}\text{C}$  to  $27^{\circ}\text{C}$  to provide a reference).
- The equipment is subjected to an overnight "soak" at  $-30^{\circ}\text{C}$  without power applied.
- After the overnight "soak" at  $30^{\circ}\text{C}$  (usually 14-16 hours), the equipment is turned on in a "standby" condition for one minute before applying power to the transmitter. Measurement of the carrier frequency of the transmitter and the individual oscillators is made within a three minute interval after applying power to the transmitter.
- Frequency measurements are made at  $10^{\circ}\text{C}$  interval up to room temperature. At least a period of one and one half-hour is provided to allow stabilization of the equipment at each temperature level.
- Again the transmitter carrier frequency and the individual oscillators is measured at room temperature to begin measurement of the upper temperature levels.
- Frequency measurements are at 10 intervals starting at  $-30^{\circ}\text{C}$  up to  $+60^{\circ}\text{C}$  allowing at least two hours at each temperature for stabilization. In all measurements the frequency is measured within three minutes after re-applying power to the transmitter.
- The artificial load is mounted external to the temperature chamber.

NOTE: The EUT is tested down to the battery endpoint.

#### Measurement Data:

- Refer to the Appendix II.

**3.2.10 Necessary Bandwidth and Emission Bandwidth**

Specification : 47 CFR 2.202 (g)

MODULATION = 10K4F3E

NECESSARY BANDWIDTH CALCULATION:

MAXIMUM MODULATION (M), kHz	= 3
MAXIMUM DEVIATION (D), kHz	= 2.2
CONSTANT FACTOR (K)	= 1
NECESSARY BANDWIDTH (BN), kHz	= (2 * M) + (2 * D * K)
	= 10.4

## APPENDIX I

### TEST EQUIPMENT USED FOR TESTS

	Description	Model No.	Serial No.	Manufacturer	Interval	Last Cal. Date
1	Spectrum Analyzer (~30GHz)	FSV-30	100757	R&S	1 year	2012-01-10
2	Signal Generator (~3.2GHz)	8648C	3623A02597	HP	1 year	2012-03-26
3	Signal Generator (1~20GHz)	83711B	US34490456	HP	1 year	2012-03-26
4	Attenuator (3dB)	8491A	37822	HP	2 year	2010-10-08
5	Attenuator (10dB)	8491A	63196	HP	2 year	2010-10-08
6	Attenuator (30dB)	8498A	3318A10929	HP	2 year	2011-01-05
7	Test Receiver (~30MHz)	ESHS10	828404/009	R&S	1 year	2012-03-26
8	EMI Test Receiver (~1GHz)	ESCI7	100722	R&S	1 year	2011-10-07
9	RF Amplifier (~1.3GHz)	8447D	2439A09058	HP	2 year	2010-10-08
10	RF Amplifier (1~18GHz)	8449B	3008A02126	HP	2 year	2012-03-26
11	Horn Antenna (1~18GHz)	BBHA 9120D	9120D122	SCHWARZBECK	2 year	2010-12-24
12	Horn Antenna (18 ~ 40GHz)	SAS-574	154	Schwarzbeck	2 year	2010-11-25
13	Horn Antenna (18 ~ 40GHz)	SAS-574	155	Schwarzbeck	2 year	2010-11-25
14	TRILOG Antenna	VULB 9160	9160-3172	SCHWARZBECK	2 year	2010-10-07
15	Dipole Antenna	VHA9103	2116	SCHWARZBECK	2 year	2010-11-25
16	Dipole Antenna	VHA9103	2117	SCHWARZBECK	2 year	2010-11-25
17	Dipole Antenna	VHA9105	2261	SCHWARZBECK	2 year	2010-11-25
18	Dipole Antenna	VHA9105	2262	SCHWARZBECK	2 year	2010-11-25
19	Hygro-Thermograph	THB-36	0041557-01	ISUZU	2 year	2013-04-26
20	Splitter (SMA)	ZFSC-2-2500	SF617800326	Mini-Circuits	-	-
21	Power Divider	11636A	6243	HP	2 year	2010-10-08
22	DC Power Supply	6622A	3448A03079	HP	-	-
23	Frequency Counter	5342A	2826A12411	HP	1 year	2012-03-26
24	Power Meter	EPM-441A	GB32481702	HP	1 year	2012-03-26
25	Power Sensor	8481A	US41030291	HP	1 year	2011-10-07
26	Audio Analyzer	8903B	3729A18901	HP	1 year	2011-10-07
27	Modulation Analyzer	8901B	3749A05878	HP	1 year	2011-10-07
28	TEMP & HUMIDITY Chamber	YJ-500	LTAS06041	JinYoung Tech	1 year	2011-10-07
29	Stop Watch	HS-3	601Q09R	CASIO	2 year	2012-03-26
30	LISN	ENV216	100408	R&S	1 year	2011-10-07
31	UNIVERSAL RADIO COMMUNICATION TESTER	CMU200	106243	R&S	2 year	2010-05-13
32	Highpass Filter	WHKX1.5/15G-10SS	74	Wainwright Instruments	-	-
33	Highpass Filter	WHKX3.0/18G-10SS	118	Wainwright Instruments	-	-
34	Loop Antenna	FMZB 1516	151602/94	SCHWARZBECK	2 year	2011-04-05

## APPENDIX II

### TEST PLOTS

Emission Masks Measurement Data:

OPERATING FREQUENCY : 470 MHz

MODULATION : None

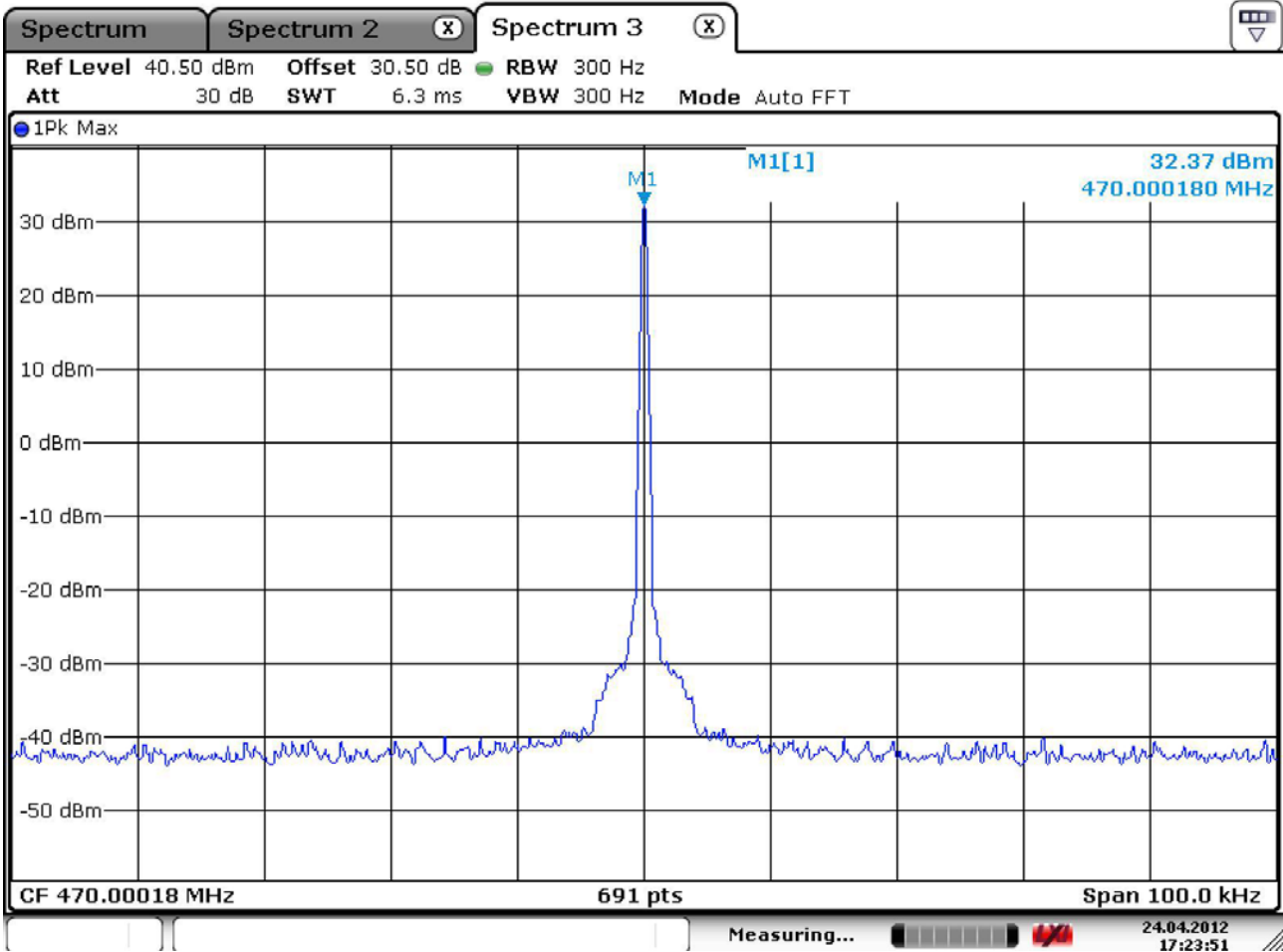



OPERATING FREQUENCY : 470 MHz  
MODULATION : Voice: 2500 Hz, Sine Wave  
MASK: D, VHF/UHF 12.5 kHz BW

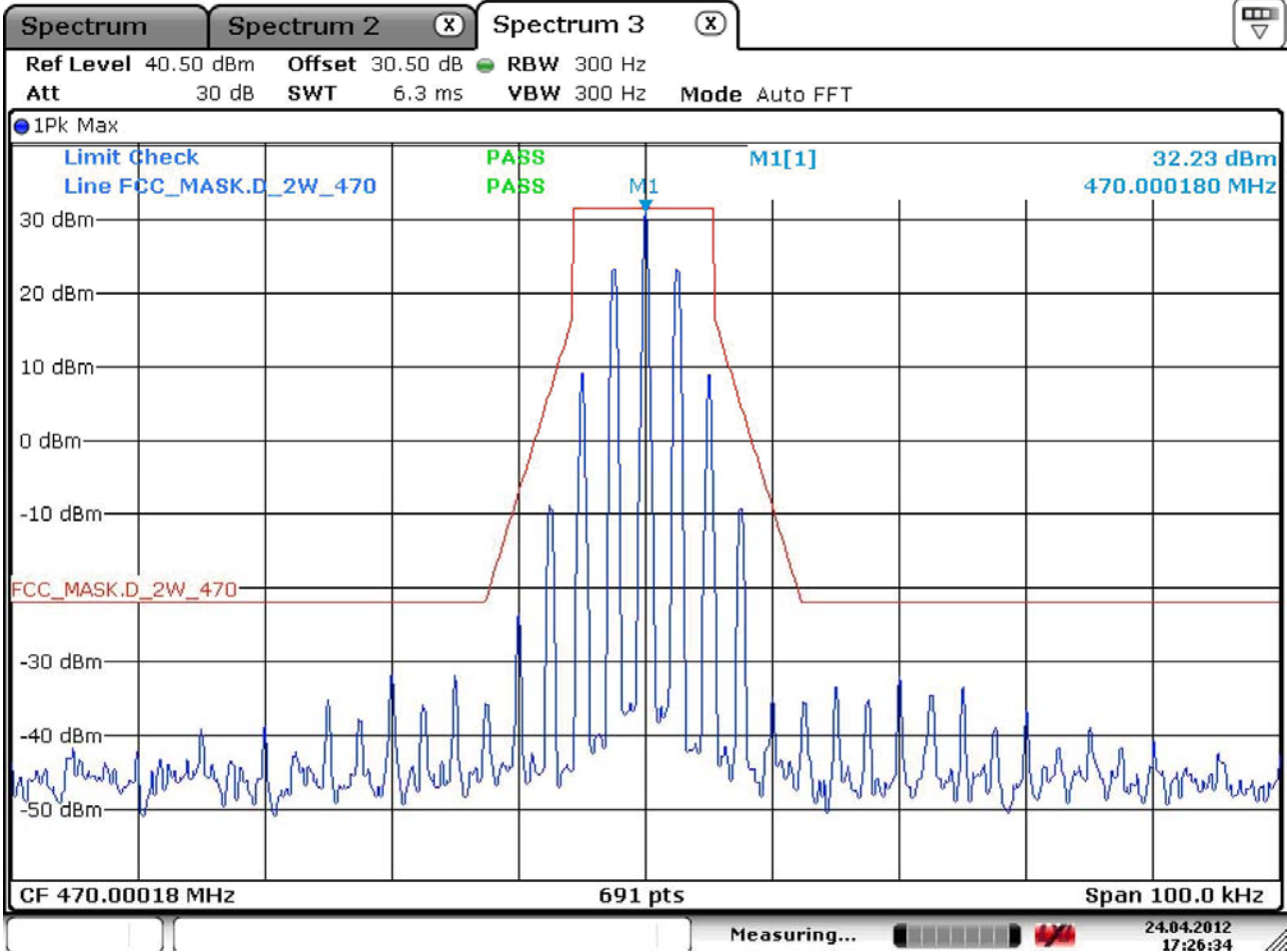

440MHz -12.5KHz

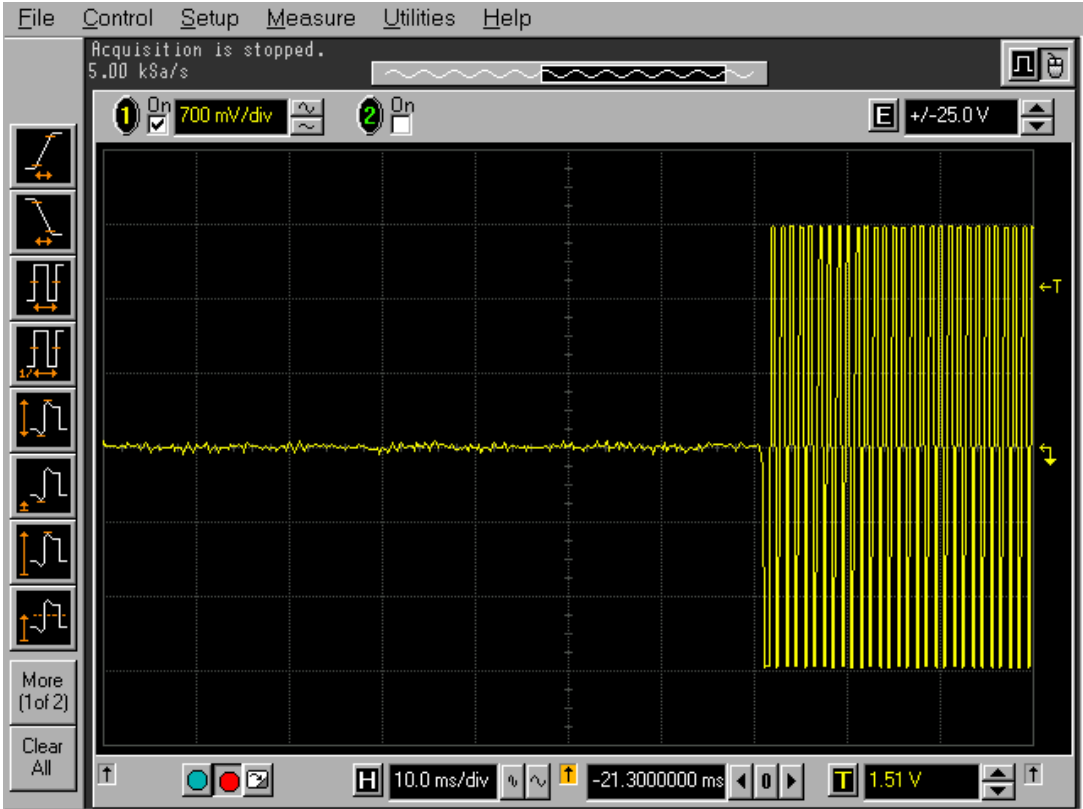
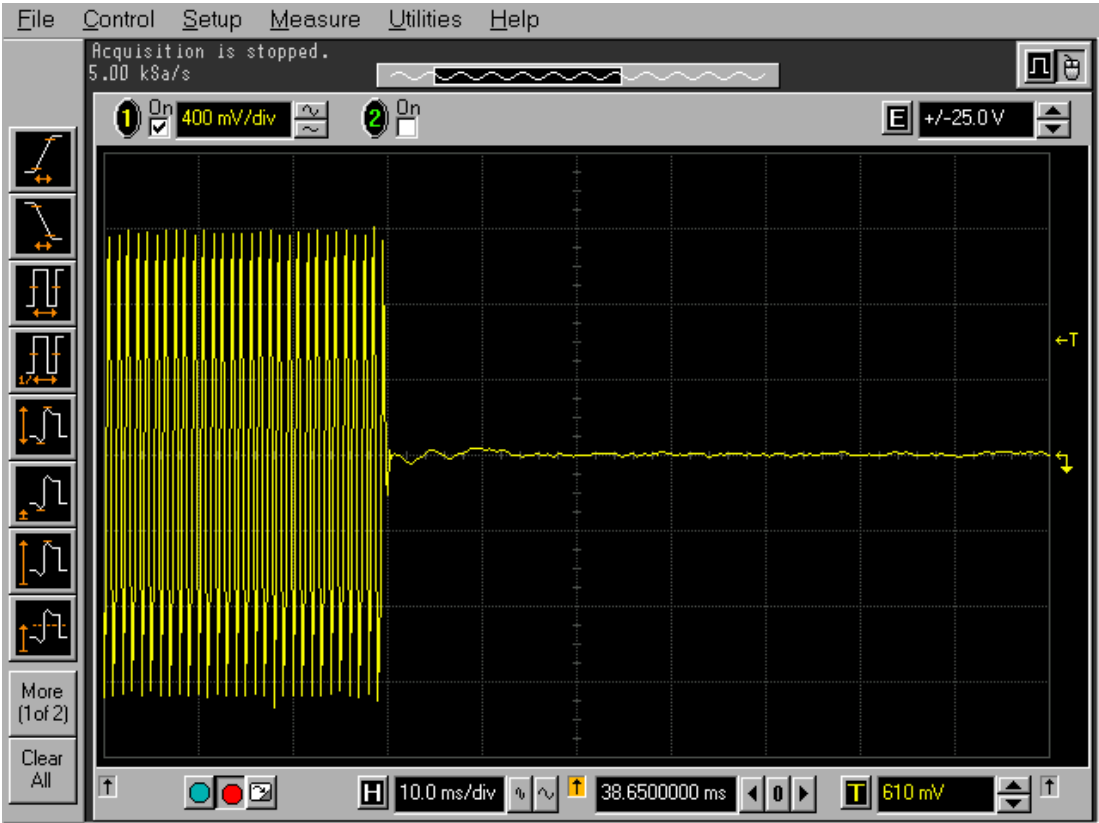

455MHz – 12.5KHz

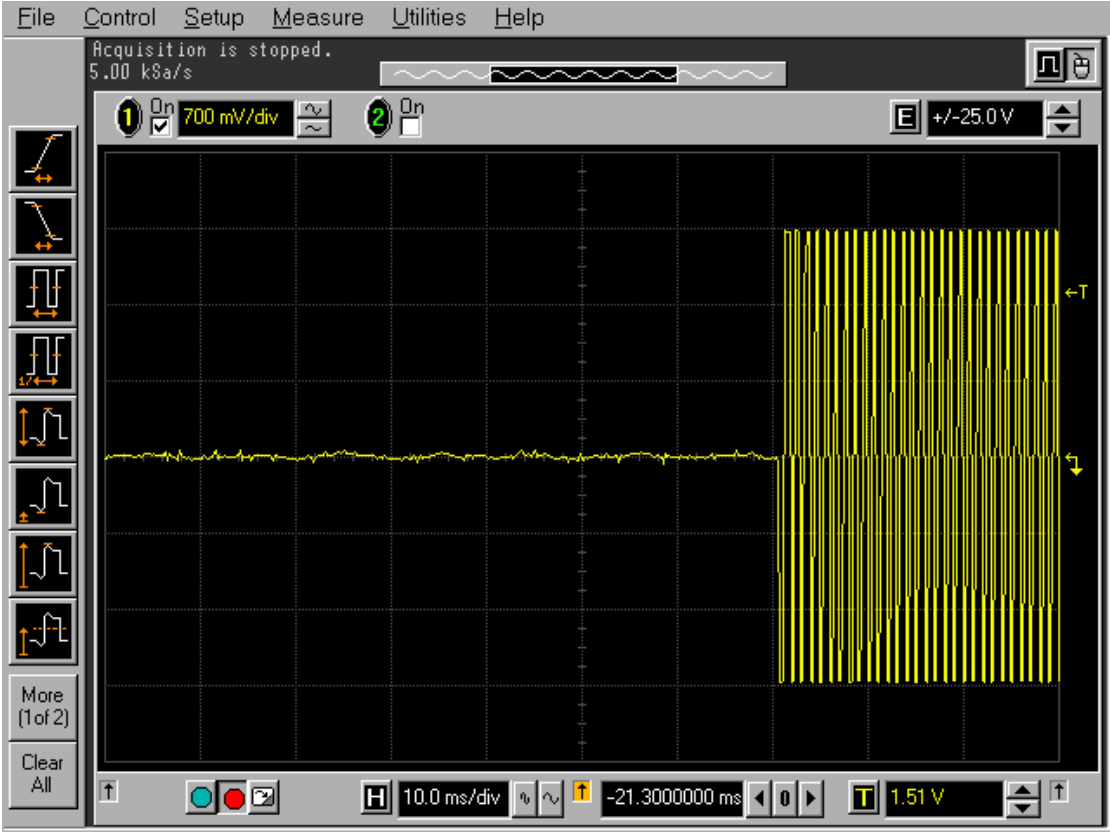
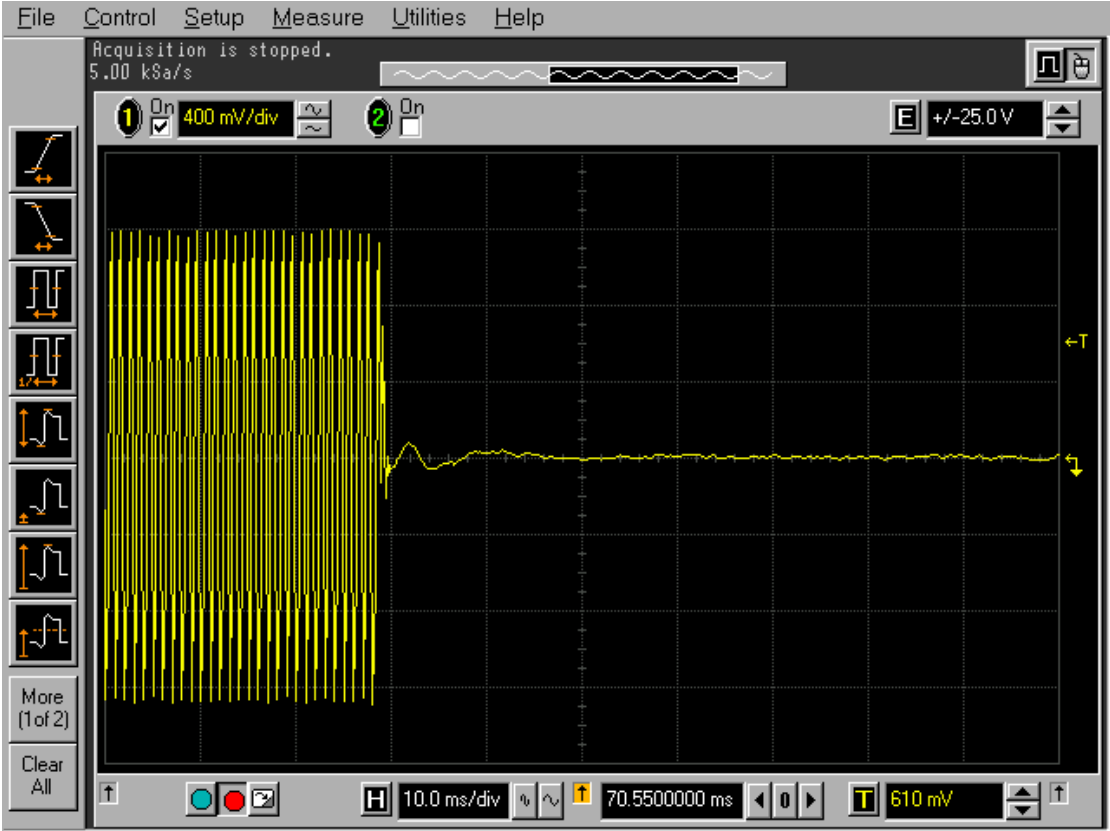

470MHz – 12.5KHz

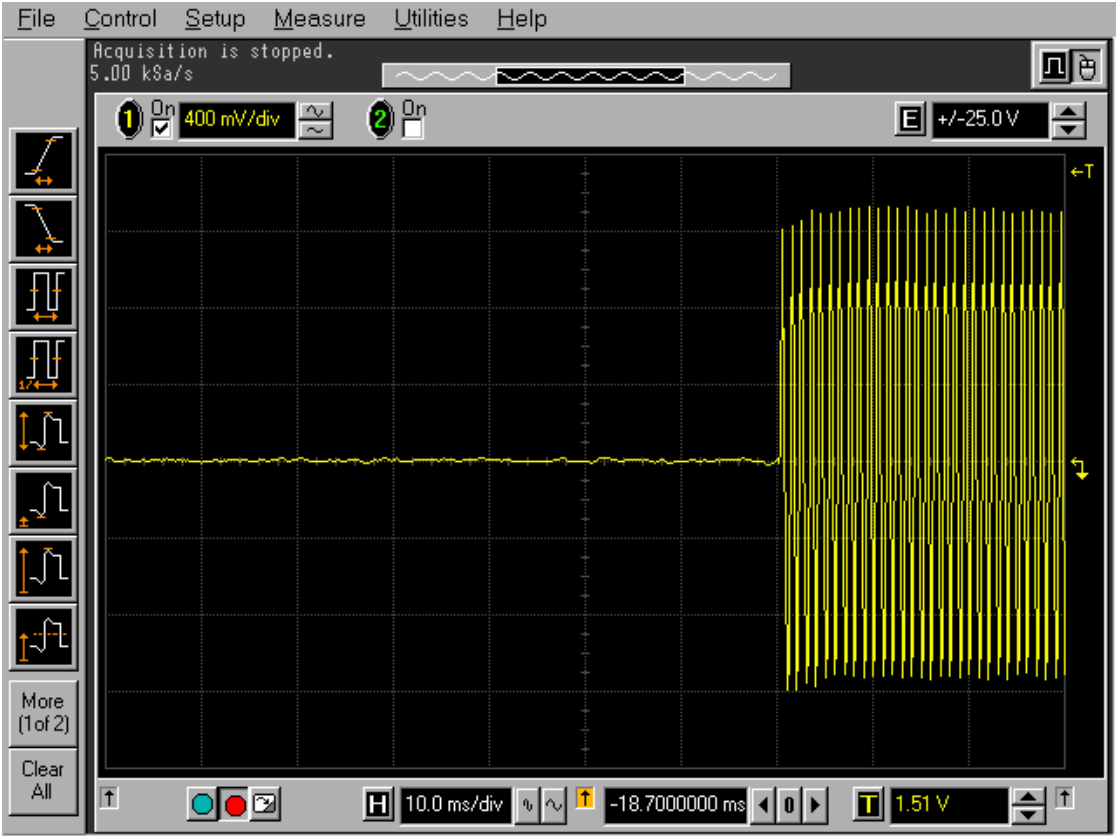
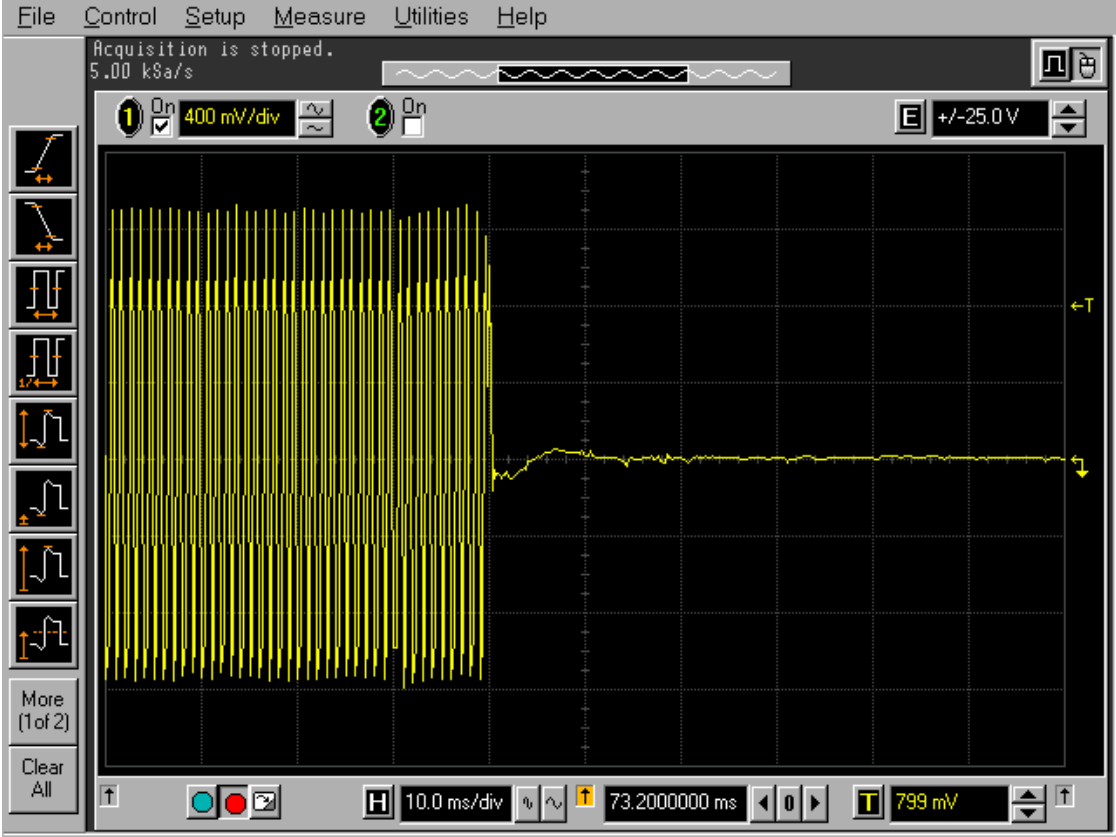

**Audio Frequency Response Measurement Data:**

OPERATING FREQUENCY : 470 MHz

REFERENCE LEVEL : 0dB @ 1kHz

Audio Frequency Response					
Freq., kHz	Level, dB	Freq., kHz	Level, dB	Freq., kHz	Level, dB
0.3	-3.11	2.8	4.70	5.5	-36.51
0.4	-2.48	3.0	4.72	6.0	-37.94
0.5	-1.62	3.3	-6.06	6.5	-35.25
0.6	-1.02	3.4	-7.24	7.0	-36.30
0.7	-0.83	3.5	-12.89	7.5	-37.59
0.8	-0.16	3.6	-15.23	8.0	-38.44
1.0	0.20	3.7	-17.22	9.0	-36.20
1.2	0.75	3.8	-21.15	10.0	-35.82
1.5	1.05	3.9	-22.35	15.0	-37.66
1.7	1.44	4.0	-26.72	20.0	-37.22
2.0	2.21	4.1	-30.50	30.0	-37.30
2.3	3.45	4.2	-32.69		
2.6	4.66	4.8	-34.45		

Audio Frequency Response

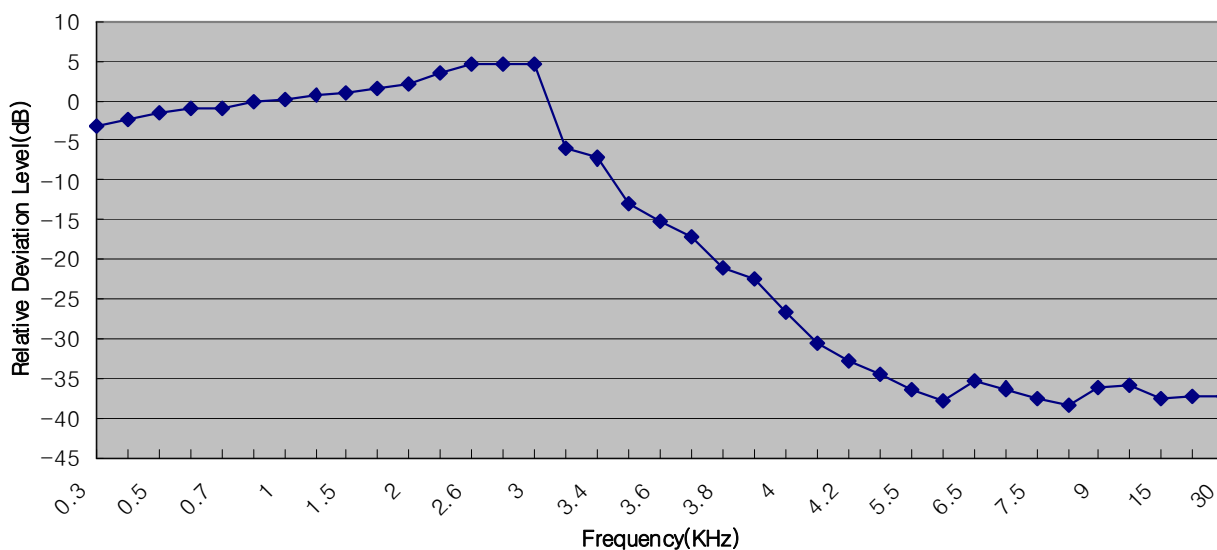

**Modulation Limiting Measurement Data:**

OPERATING FREQUENCY : 470 MHz

CHANNEL SPACING : 12.5 kHz

Input Level (mV)	FM Deviation in kHz at Indicated Modulating Frequency			
	300Hz	1KHz	2.5KHz	3KHz
2	0.076	0.233	0.545	0.492
5	0.109	0.583	1.383	1.178
7	0.145	0.752	1.562	1.389
10	0.197	1.045	1.606	1.466
15	0.259	1.566	1.624	1.547
20	0.336	1.985	1.662	1.572
30	0.491	2.022	1.671	1.605
40	0.655	2.116	1.675	1.598
50	0.856	2.125	1.673	1.574
100	1.295	2.134	1.668	1.566
120	1.784	2.150	1.665	1.558
150	2.110	2.155	1.669	1.552
200	2.121	2.159	1.671	1.543
250	2.106	2.162	1.670	1.541
300	2.111	2.157	1.668	1.538

Deviation Limiting

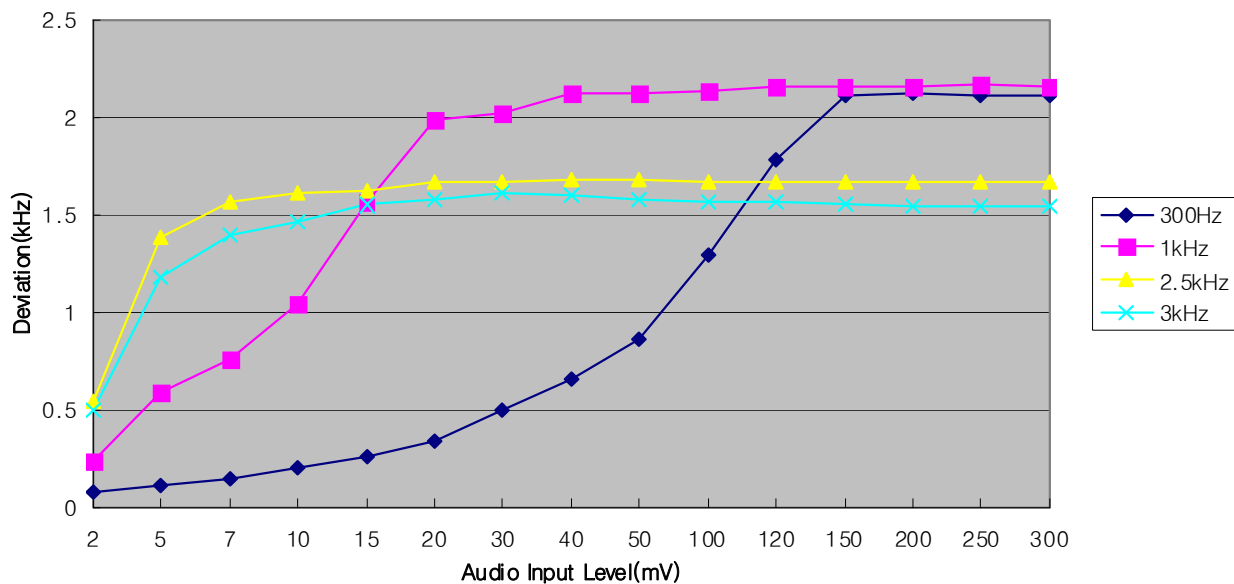

**Frequency Stability Measurement Data:**

OPERATING FREQUENCY : 470 MHz  
 REFERENCE VOLTAGE: 3.7 VDC CHANNEL SPACING: 12.5 kHz  
 DEVIATION LIMIT: ± 0.00025 % or 2.5ppm

VOLTAGE (%)	POWER (VDC)	TEMP (dB)	FREQ (Hz)	Deviation (%)
100%	3.7	+20(Ref)	470,000,000	0.000000
100%		-30	470,000,025	-0.000005
100%		-20	470,000,032	-0.000007
100%		-10	470,000,025	-0.000005
100%		0	470,000,021	-0.000004
100%		+10	470,000,006	-0.000001
100%		+20	469,999,992	0.000002
100%		+25	469,999,983	0.000004
100%		+30	469,999,979	0.000004
100%		+40	469,999,978	0.000005
100%		+50	469,999,982	0.000004
100%		+60	469,999,995	0.000001
85%	3.145	+20	470,000,011	-0.000002
115%	4.255	+20	470,000,016	-0.000003
BATT.ENDPOINT	3.100	+20	470,000,020	-0.000004

