

SERVICE MANUAL

VHF Transceiver

TJ-3100V

UHF Transceiver

TJ-3400U



* This Service manual is subject to change according to improvement of TJ-3100V/3400U Portable Radio without notice.

* Version #1 (2012-03-21)

==== CONTENTS ====

1. TJ-3100V/3400U Features	-----	3
2. Components of TJ-3100V/3400U Radio	-----	5
3. Appearance of TJ-3100V/3400U Radio	-----	6
4. Basic Operation of TJ-3100V/3400U	-----	7
5. Operating TJ-3100V/3400U RADIO	-----	9
6. Operating Instructions of TJ-3100V/3400U	-----	12
7. Precautions	-----	18
8. Safety Notes	-----	20
9. Specification	-----	23

1. TJ-3100V/3400U Features

The features of TJ-3100V/3400U are various as below. TJ-3100V/3400U can used under tough industrial environments as well as public places.

TJ-3100V/3400U series have following functions:

- 128 channels and 16 groups are selectable
- Call guard squelch of standardized CTCSS(52) / DCS(104), Invert DCS(104)
- Dual Tone Modulation Frequency (DTMF)
- Normal scanning / Priority scanning
- VOX(Voice Operated Transmit)
- BCL(Busy Channel Lock)/BCLO(Busy Channel Lock Out)
- Time-Out Timer (TOT)
- Built-in Weather Channel
- Channel Spacing Only 12.5KHz
- Selectable Squelch Level(0~4)
- Monitor
- Signal Strength Meter(RSSI)
- Battery Status Indicator
- High-Quality Audio Output
- PLL synthesizer method
- DC+3.7V 1,800mAH rechargeable Li-ion employment quantity battery use
- Advanced Speaker Protection technology
- Various Parameters and PC downloading methods
- PC Tuning
- Flash Memory Advantage

2. Components of TJ-3100V/3400U Radio

* Components could be changed by buyer request.



Figure 2-1) standard components of TJ-3100V/3400U Radio

Replacement Parts

TJA-1800LI	Battery - 1800 mAH Lithium ion
TJA-341	Antenna - VHF
TJA-342	Antenna - UHF
TJA-300L	Charger - Rapid Rate
TJA-30BC	Belt Clip

Optional Accessories

ACC-600TJ3	Vehicular Charger - Single Unit
ACC-6110TJ3	Charger - 6 Unit Gang Charger
TA-836X	Speaker Microphone - Standard
TA-850X	Speaker Microphone - Heavy Duty
TA-818X	Ear Speaker (Discreet Audio Cord) w/Lapel Mic/PTT
TA-819X	Ear Speaker ("D" Hook) w/Lapel Mic/PTT

3. Appearance of TJ-3100V/3400U Radio

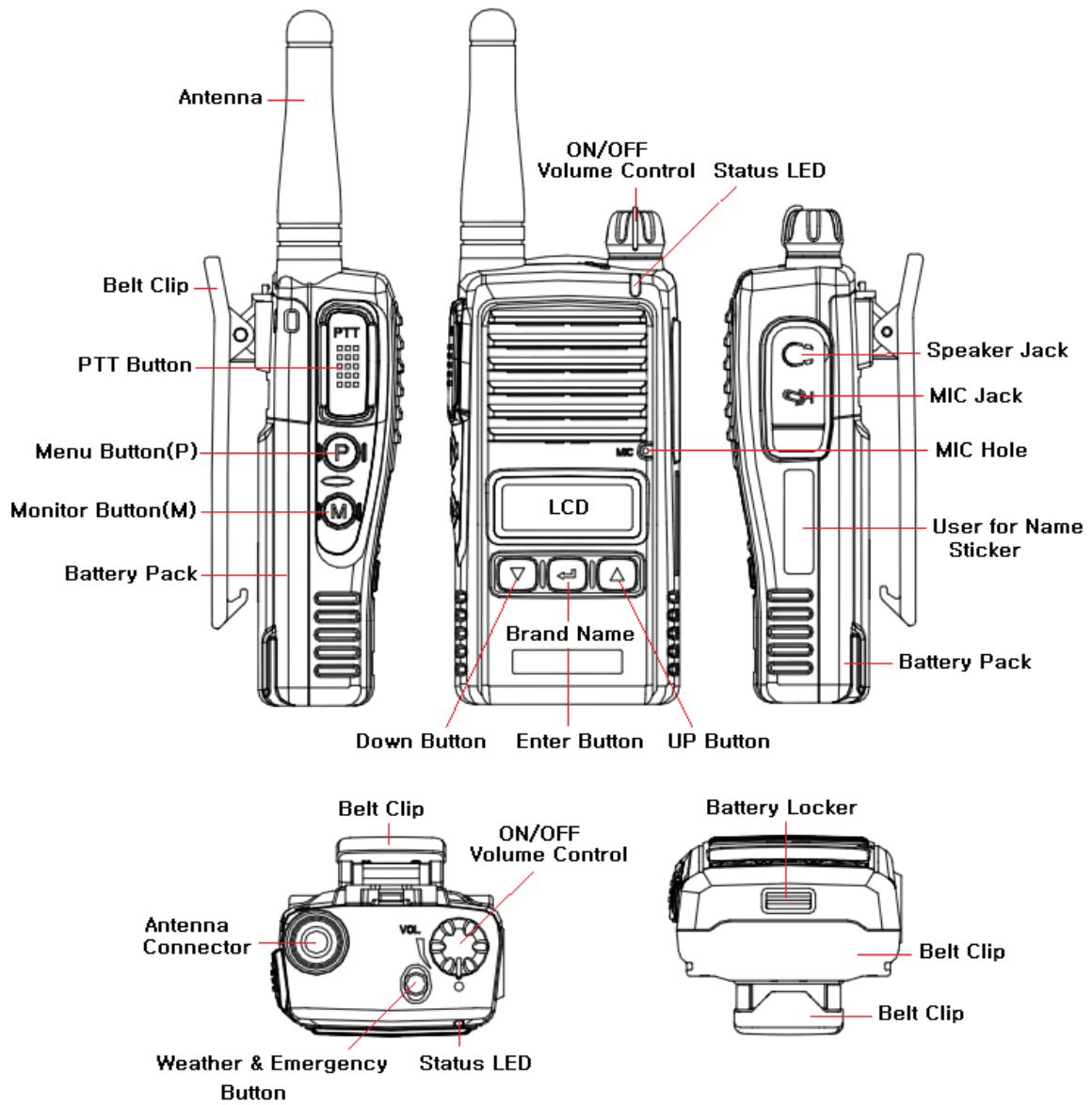

Figure 3-1) Appearance of TJ-3100V/3400U Radio

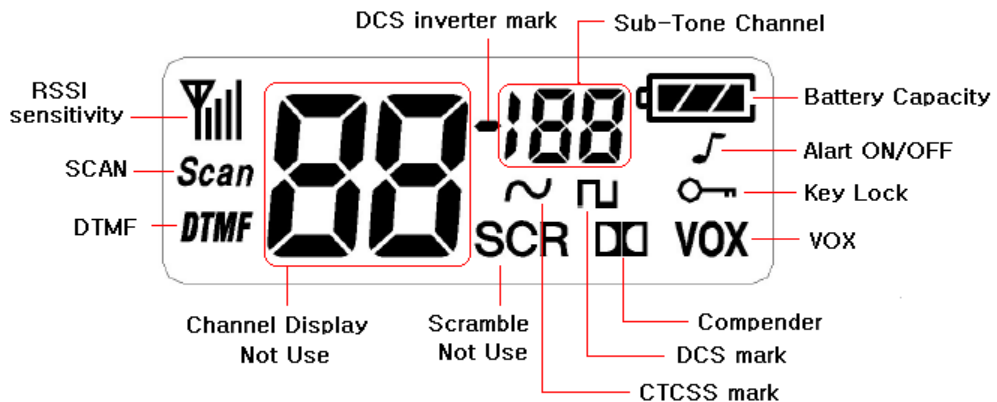

Figure 3-2) TJ-3100V/3400U LCD Indication

4. Basic Operation of TJ-3100V/3400U

Please read this manual carefully before using TJ-3100V/3400U series Radio.

This manual contains important information about using Radio.

4.1 Installation and Removing the Antenna

To install the antenna, insert the antenna into antenna connector and screw the antenna clockwise.

To remove the antenna, screw the antenna counter clockwise.

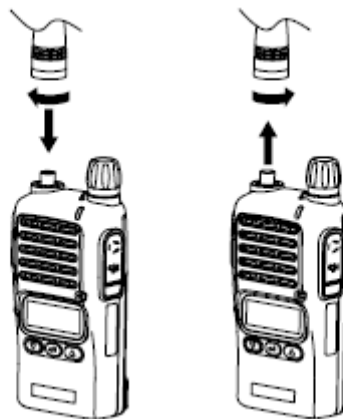



Figure 4-1) Installation and Removing the Antenna

 <p>Caution</p>	<p>When installation of the antenna, giving a strong pressure to the Radio or pulling the antenna with a strong power from the Radio can make a damage on the antenna connector, which may cause the Radio to have a critical problem.</p>
--	--

4.2 Installation and Removing the Battery

4.2.1 Installation of the battery

To install battery, slide up the battery towards the top of the radio until battery latch is locked.

4.2.2 Removing the Battery

- Slide the battery latch located on the bottom of radio to the open position as shown in Figure 4-2.
- The battery is removed by pressing it against and sliding it towards the bottom of the radio

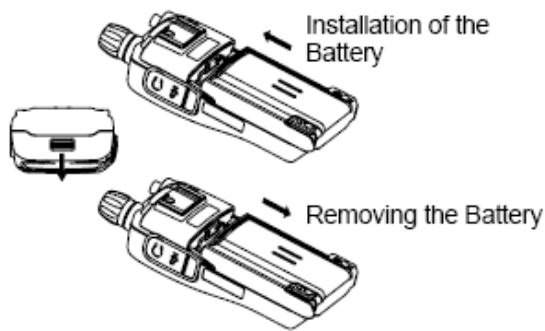

Figure 4-2) Installation and Removing the Battery

4.3 Installation and Removing the Belt Clip

- To attach belt clip to radio, align belt clip rails with the grooves in radio and slide the belt clip onto the mounting rails until it latches into place.
- To remove belt clip from radio, push up on tab of belt clip with flat bladed screwdriver and at the same time, slide the belt clip towards the top of Radio (Figure4-3).

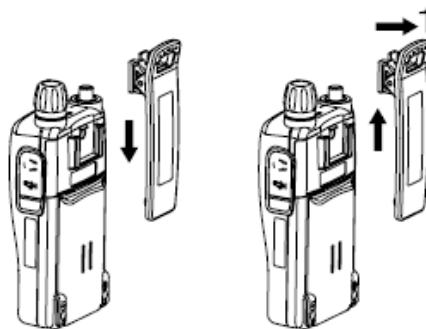

Figure 4-3) Installation and Removing the Belt Clip

4.4 Accessory connector

Accessory connector is used to connect external speaker/Mic, and headset, etc.

Please close the cover when nothing is connected.



Figure 4-4) Accessory connector

5. Charging the Battery

5.1 Safety Notes

1) The radio of TJ-3100V/3400U series receives power from high-performance Li-ion battery (TJA-1800LI). TJA-1800LI Battery is safe of high performance and highly reliable, and could be charged very fast.

TJA-1800LI Battery has been designed suitably only for the charger of TecNet.

 <p>Caution</p>	The charging of the enclosed Radio on the other maker's charger will cause a damage on the battery and also, will cause a trouble on the Radio.
--	---

2) Please charge the battery before using the radio for best performance and safety.

3) When you charge the battery that is installed in the Radio, please turn off the radio first to charge the battery.

 <p>Caution</p>	The continuous rapid discharge (for example, when making a short circuit on the '+' terminal of battery by a metal substance) may make a fatal defect and the battery can be exploded. Also, it can cause a fire.
---	---

4) Using the correct battery will improve the efficiency and safety.

5.2 The Time of Charging

Low battery voltage will make the radio less coverage and also make the performance worse.

Please charge the battery in case of following:

- ① When you think performance of the radio becomes lower
- ② When the red lamp on RX/TX Led blinks (every 0.5 second) during transmission or reception
- ③ When the battery icon blinks
- ④ When "beep" sound is generated while the radio is in use.

5.3 How to Charge

- 1) Plug the TJA-300L charger into the electricity power outlet.
- 2) When charging the Radio with the battery installed, please turn off the power of the Radio and place the Radio on the charger (The charger has a slide slot.).
- 3) After completion of the charging, the green LED on the charger will light. However, please continue the charging for 30 more minutes for the complete full charge.

status	LED indication	status	LED indication
During charging	Red LED lights.	Detecting error	Red LED is off.
After charging	Green LED lights.	When charging	Green LED lights

5.4 Charger (TJA-300L)

The TJA-300L charger is designed to charge only the Li-ion battery enclosed in this Radio.



Figure 5-2) TJA-300L Charger for TJ-3100V/3400U Radio

Specifications of TJA-300L Charger :

- Input Voltage : DC85 ~ 250V
- Battery : TJA-1800LI
- Quick Changing Time : In 4Hours and half
- Operation Temperature : 0℃~+50℃
- Size : 75(W)x84.5(D)x36(H)m/m
- Charging Current : 750mA(Fast charging)

6. Operating TJ-3100V/3400URADIO

6.1 On/Off/Volume Control

Turn the knob of Volume Switch clockwise to turn the Radio on and if turning the Switch to the opposite direction, the Radio is turned off. The audio volume level can be adjusted by turning the Volume Switch and when adjusting the volume, please refer to the index mark indicated nearby the Volume knob.

Turns the radio on and off and adjusts audio volume level.

6.2 PTT Button(Push-To-Talk Button)

If pressing the PTT button, the status indication LED lights in red color and the Radio is converted to transmission mode. If releasing the PTT button, the Radio is converted to reception mode or standby mode. It is recommended to talk about 5~7cm away from the microphone for using in better sound quality and for better voice communication

6.3 Menu Button(P, Program Menu Button)

Enter into Menu mode by pressing the Menu button (P) for 2 seconds.

The sequence of menu mode is as follows.

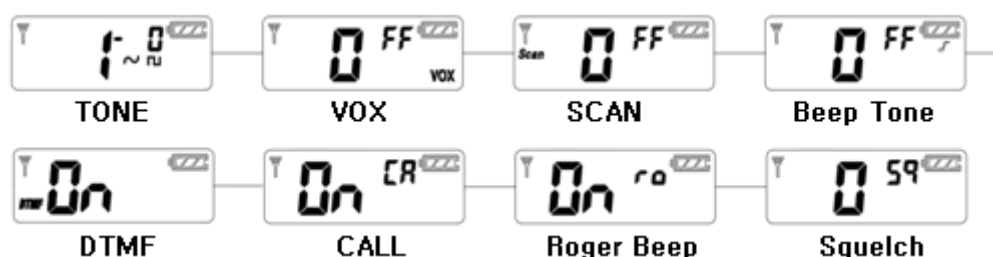

6.4 Monitor Button(M)

The monitor mode is enabled and disabled by pressing the Monitor button (M) on the side.

Normal Mode : During pressing the (M) button for about 2 seconds, it is possible to check the receiving status.

Continuous Mode : During pressing the (M) button for more than 2 seconds, the Radio will make a "Beep" tone, which means the monitor function is maintained and if you press the (M) button again, the monitor function will be released.

6.5 Emergency Button

In case of emergency situation, if you press the Emergency button, a siren sound will be heard through the speaker in the Radio and the Radio will transmit the emergency signal to the party through the emergency channel.

6.6 Channel Buttons(▼,▲)

Channel Buttons(▼,▲) have 3 functions as shown in following.

- ① Channel buttons(▼,▲) are to change channels.
- ② Channel buttons(▼,▲) are to select menu at menu mode.
- ③ Menu(p) + Channel up(▲) are to Channel Lock, Menu(p) + Channel down(▼) are to Channel unlock

6.7 Accessory Connector

The Accessory Connector is used when using an external speaker microphone or doing PC programming or making the Cloning or using as a Repeater.

6.8 LED Status

The LED indicates various status' of the radio.

- (1) RX - Green color
- (2) TX - Red color during PTT
- (3) CTCSS, DCS Error - Green color blinking
- (4) Low Battery - Red color blinking with beep tone

6.7 Function Operation

Enter into Menu mode by pressing the Menu button (P) for 2 seconds.

The sequence of menu mode is as follows.

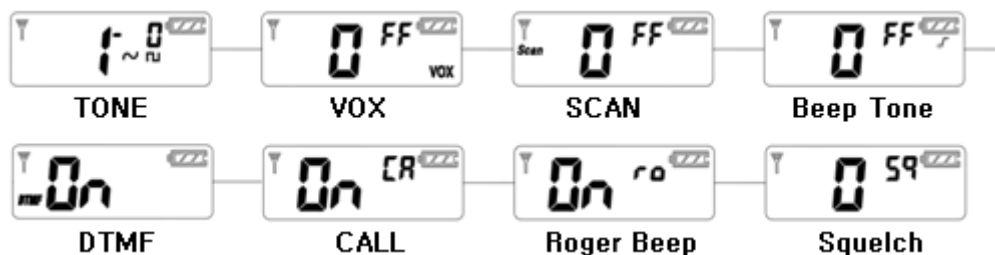

6.8 CTCSS/DCS/DCS Inverter sub-tone channel selection:

Press Menu (P) button for more than 1 second and the radio will go into function setting mode.

Press UP (▲) or DOWN (▼) button to select Type of Sub-Channel.

CTCSS Sub-Channel : (∩)

DCS Sub-Channel : (□)

DCS Inverter Sub-Channel : (—)

No setting Sub-Channel : (0)

To select CTCSS tone sub-channel, select () by pressing UP (▲) or DOWN (▼) button, and press Enter (↵) button.

Sub-Tone channel LCD digit will be blinking

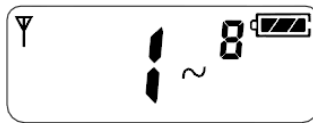

Press Up or DOWN to select your desired channel (1~38), and press Enter () button to confirm it.

To exit from menu, press M button or PTT switch.

Use same method to set up DCS () or DCS Invertor () Sub-Tone Channels

6.8.1 VOX Function On/Off selection:

Press Menu (P) button for more than 1 second and the radio will enter into function setting mode. Press Menu (P) button again. Then VOX setting Icons will be blinking.

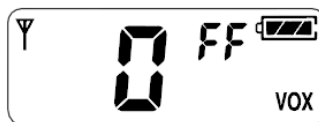

By pressing UP (▲) or DOWN (▼) button, you can select on or off. To exit from menu, press M button or PTT switch.

6.8.2 Scan On/Off selection:

Press Menu (P) button for more than 1 second and the radio will enter into function setting mode. Press Menu (P) button 2 times. Radio will go to Scan setting menu mode.



By pressing UP (▲) or DOWN (▼) button, you can select On or Off.

Select on and press Enter () button to confirm Scan On. To exit from menu, Press M button or PTT switch

If you want to enable Scan function, Press Menu (P) + Enter () at the same time.

Then radio will begin scan. To stop Scan, press Menu (P) button.

(With programming software, a more selective type of scan method can be chosen.)

6.8.3 Beep Tone On/Off selection:

Press Menu (P) button for more than 1 second and the radio will enter into function setting mode. Press Menu (P) button 3 times. Radio will go to Beep tone on/off setup mode.



By Pressing UP (▲) or DOWN (▼) button, set Beep tone on or off. To exit from menu, press M button or PTT button.

6.8.4 DTMF tone selection:

Press Menu (P) button for more than 1 second and the radio will enter into function setting mode.



Press Menu (P) button 4 times. Radio will go to DTMF setting mode. By pressing UP (▲) or DOWN (▼) button, and pressing Enter() button, you can select 12 different DTMF tones.

To exit from menu, press M button or PTT button.

6.8.5 Call tone selection (10 different call tones):

Press Menu (P) button for more than 1 second and the radio will enter into function setting mode.



Press Menu (P) button 5 times. Radio will go to Call tone selection mode. By pressing UP (▲) or DOWN (▼) button, and pressing Enter () button, you can select On or Off.

If you select On and press Enter () button, you can select 10 different Call tones by pressing UP (▲) or DOWN (▼) button. To confirm your setting, please Enter (Icon) button. To exit from menu, Press M button or PTT button. To enable Call, press Call/Enter() button.

Reminder : To receive Call tone, the receiving radio needs to be on the same channel and tone settings.

6.8.6 Roger Beep On/Off selection:

Press Menu (P) button for more than 1 second and the radio will enter into function setting mode.



Press Menu (P) button 6 times. Radio will go into Roger beep on/off setting mode.

By pressing UP (▲) or DOWN (▼) button will select on or off. To confirm your selection, press Enter () button.

To exit from menu, press M button or PTT switch.

6.8.7 Squelch level selection:

Press Menu (P) button for more than 1 second and the radio will enter into function setting mode.

Press Menu (P) button 7 times. Radio will goes into Squelch level selection mode.



By pressing UP (▲) or DOWN (▼), and Enter () button, select your desired Squelch level from 0 to 4. (0 means the strongest level and 4 means the weakest level) To exit from menu, press M button or PTT switch)

6.8.8 Weather On/Off selection:

To enable weather (WX) mode, do a quick press of red button on top of radio.

LCD will display WX mode. Press UP (▲) or DOWN (▼) button to move through WX channels.

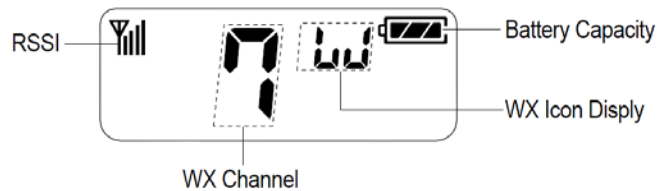

To exit from WX mode, press red button again.

** Reminder : When WX mode is enabled, the radio will not transmit or receive talk transmissions.

When WX is disabled, the radio will revert to it's previous channel and mode of operation.

6.8.9 EMG (Emergency Alert Tone):

This function allows you to send out distress/locator signals in emergency situation. To activate the emergency alert tone, press "Red Button" for more than 2 seconds.

The radio will send out a loud alert tone continuously. To deactivate the EMG function, press any button on the radio.

** Reminder : To receive emergency alert tone, the receiving radio needs to be on the same channel and tone settings.

7. For Safe Operation



Don't transmit with antenna detached from the radio or don't damage or change antenna type. Strong electronic waves are emitted from the radio and damages or changes to the antenna may effect the performance of the radio, and it may cause the radio to be defective and not covered under warranty.



Don't use other manufacturers accessories. Unknown or unauthorized accessories may cause the radio to be defective and not covered under warranty.



Don't disassemble the radio. Disassembly of the radio may cause a serious defect or malfunction and not be covered under warranty.



Don't give an excessive shock to the radio.
Don't place the radio where the direct sunlight or high temperature occurs.
Don't make a damage to the battery pack by sharp substance or an excessive shock.



Turn off the radio before boarding on an airplane.
Don't use the radio in the hospital without any pre-approval.
Don't use the radio at the place of where computer or other electronic devices are being used.



- Please keep the radio at least 1 inch away from the human body.
- Don't give any damage to antenna.
- When using earphone, please reduce the volume to a low level. If not, unexpected high sound may have harmful effect to your ear.
- Don't touch the conductive metal of the battery radio with wet hands. It may cause damage on your hands.
- Please be careful when putting the battery in a pocket or a bag.

• FCC RF EXPOSURE COMPLIANCE REQUIREMENTS FOR OCCUPATIONAL USE ONLY

The Federal Communications Commission (FCC), with its action in General Docket 93-62, November 7, 1997, has adopted a safety standard for human exposure to Radio Frequency (RF) electromagnetic energy emitted by FCC regulated equipment. Proper operation of this radio will result in user exposure far below the Occupational Safety and Health Act (OSHA) and Federal Communications Commission limits.

- **DO NOT** transmit for more than 50% of total radio use time (50% duty cycle). Transmitting more than 50% of the time can cause FCC RF exposure compliance requirements to be exceeded.
- This radio is NOT approved for use by the general population in an uncontrolled environment. This radio is restricted to occupational use, work related operations only where radio operator must have the knowledge to control the user's exposure conditions for satisfying the higher exposure limit allowed for occupational use.
- When transmitting, hold the radio in a vertical position with its microphone 1 inches (2.5 cm) away from your mouth.
- The radio is transmitting when the red LED on the front of the radio is illuminated. You can cause the radio to transmit by pressing the PTT bar on the radio.
- These are required operating configurations for meeting FCC RF exposure compliance. Failure to observe these restrictions mean violation.

FCC Notice

This device complies with part 15 of the FCC rules. Operation is subject to the following two conditions: (1) This devices may not cause harmful interference, and (2) This device must accept any interference received, including interference that may cause undesired operation.

RADIO FREQUENCY ENERGY SAFETY INFORMATION

Your radio generates RF electromagnetic energy during transmit mode. This radio is designed for and classified as “Occupational Use Only”, meaning it must be used only during the course of employment by individuals aware of the hazards, and the ways to minimize such hazards. This radio is NOT intended for use by the “General Population” in an uncontrolled environment.

This radio has been tested and complies with the FCC RF exposure limits for “Occupational Use Only”. In addition, your XRADIO radio complies with the following Standards and Guidelines with regard to RF energy and electromagnetic energy levels and evaluation of such levels for exposure to humans:

- FCC OET Bulletin 65 Edition 97-01 Supplement C, Evaluating Compliance with FCC Guidelines for Human Exposure to Radio Frequency Electromagnetic Fields.

- American National Standards Institute (C95.1-1992), IEEE Standard for Safety Levels with Respect to Human Exposure to Radio Frequency Electromagnetic Fields, 3 kHz to 300 GHz.

- American National Standards Institute (C95.3-1992), IEEE Recommended Practice for the Measurement of Potentially Hazardous Electromagnetic Fields– RF and Microwave.

- The following accessories are authorized for use with this product. Use of accessories other than those (listed in the instruction) specified may result in RF exposure levels exceeding the FCC requirements for wireless RF exposure. To ensure that your exposure to RF electromagnetic energy is within the FCC allowable limits for occupational use, always adhere to the following guidelines:

- DO NOT operate the radio without a proper antenna attached, as this may damage the radio and may also cause you to exceed FCC RF exposure limits. A proper antenna is the antenna supplied with this radio by the manufacturer or antenna specifically authorized by the manufacturer for use with this radio.

- DO NOT transmit for more than 50% of total radio use time (“50% duty cycle”). Transmitting more than 50% of the time can cause FCC RF exposure compliance requirements to be exceeded. The radio is transmitting when the “TX indicator” lights red. You can cause the radio to transmit by pressing the “PTT” switch.

- ALWAYS keep the antenna at least 4 cm away from the body when transmitting and only use the Xradio belt-clip which is listed in instructions when attaching the radio to your belt, etc., to ensure FCC RF exposure compliance requirements are not exceeded. To provide the recipients of your transmission the best sound quality, hold the antenna at least 4 cm from your mouth, and slightly off to one side. The information listed above provides the user with the information needed to make him or her aware of RF exposure, and what to do to assure that this radio operates with the FCC RF exposure limits of this radio. Electromagnetic Interference/Compatibility During transmissions, your XRADIO radio generates RF energy that can possibly cause interference with other devices or systems. To avoid such interference, turn off the radio in areas where signs are posted to do so. DO NOT operate the transmitter in areas that are sensitive to electromagnetic radiation such as hospitals, aircraft, and blasting sites.

Occupational/Controlled Use The radio transmitter is used in situations in which persons are exposed as consequence of their employment provided those persons are fully aware of the potential for exposure and can exercise control over their exposure. OPERATING NOTES

■ When transmitting with a mobile radio, hold the radio in a vertical position with its microphone 90 cm away from your mouth. Keep the antenna at least 4 cm from your head and body.

■ If you wear a mobile two-way radio on your body, ensure that the antenna is at least 4 centimeters from your body when transmitting. PRECAUTIONS WARNING! NEVER hold the transceiver so that the antenna is very close to, or touching exposed parts of the body, especially the face or eyes, while transmitting. The transceiver will perform best if the microphone is 90 cm away from the lips and the transceiver is vertical. WARNING! NEVER operate the transceiver with a headset or other audio accessories at high volume levels. CAUTION! NEVER short the terminals of the battery pack. NEVER connect the transceiver to a power source other than the Battery listed below Such a connection will ruin the transceiver. DO NOT push the PTT when not actually desiring to transmit

AVOID using or placing the transceiver in direct sunlight or in areas with temperatures below -30°C (-22°F) or above $+60^{\circ}\text{C}$ ($+140^{\circ}\text{F}$). DO NOT modify the transceiver for any reason. MAKE SURE the flexible antenna and battery pack are securely attached to the transceiver, and that the antenna and battery pack are dry before attachment. Exposing the inside of the transceiver to water will result in serious damage to the transceiver. BE CAREFUL! The series transceivers employ waterproof construction, which corresponds to IPX7 of the international standard IEC 60529 (2001), 1 m depth for 30 minutes. However, once the transceiver has been dropped, waterproofing cannot be guaranteed due to the fact that the transceiver may be cracked, or the waterproof seal damaged, etc. The use of non-XRADIO battery packs/chargers may impair transceiver performance and invalidate the warranty.

FCC Notice Cautions. Changes or Modifications not expressly approved by the party responsible for compliance could void the user's authority to operate the equipment.

8. Specification

8.1 TJ-3400U Specification

General

Frequency Range	UHF: 440 ~ 470 MHz
Frequency Stability	±2.5PPM (-30 to +60°C)
Programmable Channels	128 Channels/16 Group
Channel Spacing	Dual Channel Spacing 12.5 KHz
Dimensions	97.5mm (H)×49.5mm (W)×25.5mm (D)
Weight	150g (with Battery pack & Antenna)
Power Source	DC +3.7V rechargeable Li-ion 1800mAh battery pack
Current Drain (maximum)	Receive mode, rated audio out - 2800mA (Audio Max) Transmit mode – 1500mA Standby mode - 50mA
Duty Cycle(5/5/90)	15 Hours(High) / 20 Hours(Low)

Receiver

Sensitivity	.282uV 12 dB SINAD
Squelch Sensitivity	.25uV 10dB SINAD
Selectivity	60dB
Spurious and Harmonic Rejection	70dB
Inter-modulation	60dB
FM Hum and Noise	40Db
Audio Output Power	Watt across an 8-ohm load
Audio Distortion	Less than 5% at rated output
Audio Response	+1, -3 dB from 6dB per octave de-emphasis Characteristic from 300 ~ 3000Hz
Speaker Impedance	8 ohms

Transmitter

RF Power Output	2Watt
Spurious and Harmonic	60dB
FM Hum and Noise	40dB
Audio Distortion	5% maximum with 1KHz modulation
Audio Frequency Response	+1, -3dB from 6dB per octave pre-emphasis Characteristic from 300 ~ 3000Hz
Output Impedance	50 ohms