



SPORTON International Inc.

No. 52, Hwa Ya 1st Rd., Kwei-Shan Hsiang, TaoYuan Hsien, Taiwan, R.O.C.
Ph: 886-3-327-3456 / FAX: 886-3-327-0973 / www.sporton.com.tw

FCC RADIO TEST REPORT

Applicant's company	Realtek Semiconductor Corp.
Applicant Address	No. 2, Innovation Road II, Hsinchu Science Park, Hsinchu 300, Taiwan
FCC ID	TX2-RTL8723BE
Manufacturer's company	Realtek Semiconductor Corp.
Manufacturer Address	No. 2, Innovation Road II, Hsinchu Science Park, Hsinchu 300, Taiwan

Product Name	802.11b/g/n RTL8723BE Combo module
Brand Name	REALTEK
Model No.	RTL8723BE
Test Rule	47 CFR FCC Part 15 Subpart C § 15.247
Test Freq. Range	2400 ~ 2483.5MHz
Received Date	Feb. 08, 2013
Final Test Date	Apr. 13, 2013
Submission Type	Original Equipment

Statement

Test result included in this report is for the IEEE 802.11n and IEEE 802.11b/g part of the product.

The test result in this report refers exclusively to the presented test model / sample.

Without written approval of SPORTON International Inc., the test report shall not be reproduced except in full.

The measurements and test results shown in this test report were made in accordance with the procedures and found in compliance with the limit given in **ANSI C63.10-2009**,

47 CFR FCC Part 15 Subpart C, KDB 558074 D01 v02 and **KDB 662911 D01 v01r02**.

The test equipment used to perform the test is calibrated and traceable to NML/ROC.





Table of Contents

- 1. CERTIFICATE OF COMPLIANCE..... 1**
- 2. SUMMARY OF THE TEST RESULT 2**
- 3. GENERAL INFORMATION..... 3**
 - 3.1. Product Details3
 - 3.2. Accessories4
 - 3.3. Table for Filed Antenna5
 - 3.4. Table for Carrier Frequencies7
 - 3.5. Table for Test Modes7
 - 3.6. Table for Testing Locations.....9
 - 3.7. Table for Supporting Units10
 - 3.8. Table for Parameters of Test Software Setting10
 - 3.9. Duty Cycle.....11
 - 3.10. Test Configurations.....13
- 4. TEST RESULT..... 16**
 - 4.1. AC Power Line Conducted Emissions Measurement16
 - 4.2. Maximum Conducted Output Power Measurement.....20
 - 4.3. Power Spectral Density Measurement.....23
 - 4.4. 6dB Spectrum Bandwidth Measurement29
 - 4.5. Radiated Emissions Measurement.....34
 - 4.6. Emissions Measurement.....64
 - 4.7. Antenna Requirements86
- 5. LIST OF MEASURING EQUIPMENTS 87**
- 6. TEST LOCATION..... 89**
- APPENDIX A. TEST PHOTOS..... A1 ~ A8**
- APPENDIX B. MAXIMUM PERMISSIBLE EXPOSURE B1 ~ B3**
- APPENDIX C. CO-LOCATION REPORTC1 ~ C5**
- APPENDIX D. ANTENNA LIST**

History of This Test Report

REPORT NO.	VERSION	DESCRIPTION	ISSUED DATE
FR322105AA	Rev. 01	Initial issue of report	Apr. 25, 2013

1. CERTIFICATE OF COMPLIANCE

Product Name : 802.11b/g/n RTL8723BE Combo module
Brand Name : REALTEK
Model No. : RTL8723BE
Applicant : Realtek Semiconductor Corp.
Test Rule Part(s) : 47 CFR FCC Part 15 Subpart C § 15.247

Sporton International as requested by the applicant to evaluate the EMC performance of the product sample received on Feb. 08, 2013 would like to declare that the tested sample has been evaluated and found to be in compliance with the tested rule parts. The data recorded as well as the test configuration specified is true and accurate for showing the sample's EMC nature.

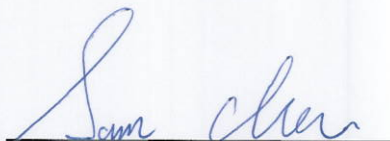

Sam Chen

SPORTON INTERNATIONAL INC.

2. SUMMARY OF THE TEST RESULT

Applied Standard: 47 CFR FCC Part 15 Subpart C				
Part	Rule Section	Description of Test	Result	Under Limit
4.1	15.207	AC Power Line Conducted Emissions	Complies	10.04 dB
4.2	15.247(b)(3)	Maximum Conducted Output Power	Complies	13.22 dB
4.3	15.247(e)	Power Spectral Density	Complies	20.44 dB
4.4	15.247(a)(2)	6dB Spectrum Bandwidth	Complies	-
4.5	15.247(d)	Radiated Emissions	Complies	3.14 dB
4.6	15.247(d)	Band Edge Emissions	Complies	0.43 dB
4.7	15.203	Antenna Requirements	Complies	-

Test Items	Uncertainty	Remark
AC Power Line Conducted Emissions	±2.3dB	Confidence levels of 95%
Maximum Conducted Output Power	±0.8dB	Confidence levels of 95%
Power Spectral Density	±0.5dB	Confidence levels of 95%
6dB Spectrum Bandwidth	±8.5×10 ⁻⁸	Confidence levels of 95%
Radiated Emissions (9kHz~30MHz)	±0.8dB	Confidence levels of 95%
Radiated Emissions (30MHz~1000MHz)	±1.9dB	Confidence levels of 95%
Radiated / Band Edge Emissions (1GHz~18GHz)	±1.9dB	Confidence levels of 95%
Radiated Emissions (18GHz~40GHz)	±1.9dB	Confidence levels of 95%
Temperature	±0.7°C	Confidence levels of 95%
Humidity	±3.2%	Confidence levels of 95%
DC / AC Power Source	±1.4%	Confidence levels of 95%

3. GENERAL INFORMATION

3.1. Product Details

IEEE 802.11n

Items	Description
Product Type	WLAN (1TX, 1RX)
Radio Type	Intentional Transceiver
Power Type	From Host System
Modulation	see the below table for IEEE 802.11n
Data Modulation	OFDM (BPSK / QPSK / 16QAM / 64QAM)
Data Rate (Mbps)	see the below table for IEEE 802.11n
Frequency Range	2400 ~ 2483.5MHz
Channel Number	11 for 20MHz bandwidth ; 7 for 40MHz bandwidth
Channel Band Width (99%)	MCS0 (20MHz): 16.40 MHz ; MCS0 (40MHz): 36.36 MHz
Maximum Conducted Output Power	MCS0 (20MHz): 16.05 dBm ; MCS0 (40MHz): 16.12 dBm
Carrier Frequencies	Please refer to section 3.4
Antenna	Please refer to section 3.3

IEEE 802.11b/g

Items	Description
Product Type	802.11b :WLAN (1TX, 1RX) 802.11g :WLAN (1TX, 1RX)
Radio Type	Intentional Transceiver
Power Type	From Host System
Modulation	DSSS for IEEE 802.11b ; OFDM for IEEE 802.11g
Data Modulation	DSSS (BPSK / QPSK / CCK) ; OFDM (BPSK / QPSK / 16QAM / 64QAM)
Data Rate (Mbps)	DSSS (1/ 2/ 5.5/11) ; OFDM (6/9/12/18/24/36/48/54)
Frequency Range	2400 ~ 2483.5MHz
Channel Number	11
Channel Band Width (99%)	11b: 15.12 MHz ; 11g: 16.64 MHz
Maximum Conducted Output Power	11b: 16.78 dBm ; 11g: 16.14 dBm
Carrier Frequencies	Please refer to section 3.4
Antenna	Please refer to section 3.3

Antenna & Band width

Antenna	Single (TX)	
Band width Mode	20 MHz	40 MHz
IEEE 802.11b	V	X
IEEE 802.11g	V	X
IEEE 802.11n	V	V

IEEE 11n Spec.

Protocol	Number of Transmit Chains (NTX)	Data Rate / MCS
802.11n (HT20)	1	MCS 0-7
802.11n (HT40)	1	MCS 0-7

Note 1: IEEE Std. 802.11n modulation consists of HT20 and HT40 (HT: High Throughput). Then EUT support HT20 and HT40.

Note 2: Modulation modes consist of below configuration:
HT20/HT40: IEEE 802.11n

3.2. Accessories

N/A

3.3. Table for Filed Antenna

Ant.	Brand	Model Name	Antenna Type	Connector	Gain (dBi)	Remark
1	LYNwave	ALA110-222050-300011	PIFA Antenna	I-PEX MHF4	3.5	For NGFF Board
2	LYNwave	ALA110-222050-300010	PIFA Antenna	I-PEX	3.5	For HMC Board
3	JOYMAX	TWF-614XMPXX-500	Dipole Antenna	I-PEX	3	For HMC Board

There are six configurations of EUT. The more information is listed as below table.

Configuration	Type	Power Type	Antenna Variety	Type of Antenna
1	HMC	PCI-E (WLAN)	Diversity	PIFA with I-PEX connector
		USB (Bluetooth)		Dipole with I-PEX connector
2	HMC	PCI-E (WLAN)	Fixed	PIFA with I-PEX connector
		USB (Bluetooth)		Dipole with I-PEX connector
3	NGFF	PCI-E (WLAN)	Diversity	PIFA with I-PEX MHF4 connector
		USB (Bluetooth)		
4	NGFF	PCI-E (WLAN)	Fixed	PIFA with I-PEX MHF4 connector
		USB (Bluetooth)		
5	NGFF	SDIO (WLAN)	Diversity	PIFA with I-PEX MHF4 connector
		UART (Bluetooth)		
6	NGFF	SDIO (WLAN)	Fixed	PIFA with I-PEX MHF4 connector
		UART (Bluetooth)		

Note: The more detail information of diversity type and fixed type is listed as below.

For diversity type: (Both of those two antenna connectors can be used.)

The EUT supports the antenna with TX/RX diversity function for WLAN and Bluetooth.

For WLAN 802.11b/g/n (1TX, 1RX) mode:

Both of Chain 1 and Chain 2 can be used as transmitting/receiving antennas, but only one antenna can be used as transmitting/receiving antenna at the same time. Chain 1 generated the worst case than Chain 2, so it is tested and recorded in the report.

For Bluetooth mode:

Base on WLAN's operation mode to select the other antenna to work.

(Ex. Assume Main port was selected to conduct transmitting function in WIFI, so AUX port was selected in Bluetooth Mode. Vice versa.)

Chain 1 generated the worst case than Chain 2, so it is tested and recorded in the report.

For fixed type: (Chain 1 is designated for WLAN function, Chain 2 is designated for Bluetooth function.)

For WLAN 802.11b/g/n (1TX, 1RX) mode:

Chain 1 can be used as transmitting/receiving antenna.

For Bluetooth mode:

Chain 2 can be used as transmitting/receiving antenna.

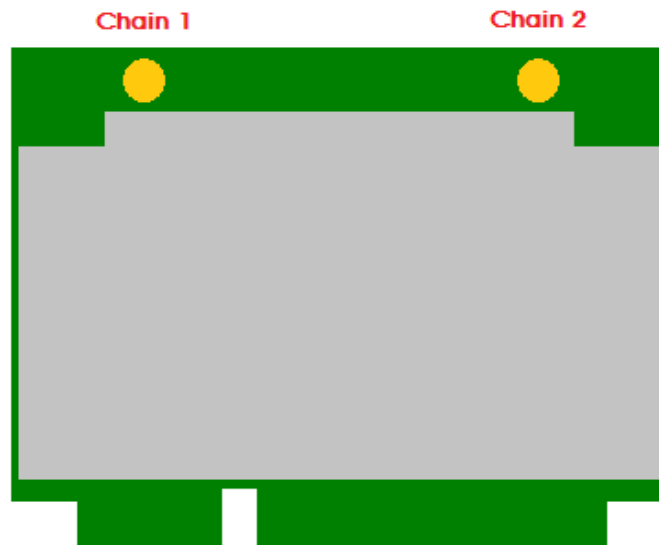

3.4. Table for Carrier Frequencies

For IEEE 802.11b/g, use Channel 1~Channel 11.

There are two bandwidth systems for IEEE 802.11n.

For both 20MHz bandwidth systems, use Channel 1~Channel 11.

For both 40MHz bandwidth systems, use Channel 3~Channel 9.

Frequency Band	Channel No.	Frequency	Channel No.	Frequency
2400~2483.5MHz	1	2412 MHz	7	2442 MHz
	2	2417 MHz	8	2447 MHz
	3	2422 MHz	9	2452 MHz
	4	2427 MHz	10	2457 MHz
	5	2432 MHz	11	2462 MHz
	6	2437 MHz	-	-

3.5. Table for Test Modes

Preliminary tests were performed in different data rate to find the worst radiated emission. The data rate shown in the table below is the worst-case rate with respect to the specific test item. Investigation has been done on all the possible configurations for searching the worst cases. The following table is a list of the test modes shown in this test report.

Test Items	Mode	Data Rate	Channel	Chain
AC Power Line Conducted Emissions	Normal Link	-	-	-
Maximum Conducted Output Power	802.11n 20MHz	MCS0	1/6/11	1
	802.11n 40MHz	MCS0	3/6/9	1
	11b/BPSK	1 Mbps	1/6/11	1
	11g/BPSK	6 Mbps	1/6/11	1
Power Spectral Density	802.11n 20MHz	MCS0	1/6/11	1
	802.11n 40MHz	MCS0	3/6/9	1
	11b/BPSK	1 Mbps	1/6/11	1
	11g/BPSK	6 Mbps	1/6/11	1
6dB Spectrum Bandwidth	802.11n 20MHz	MCS0	1/6/11	1
	802.11n 40MHz	MCS0	3/6/9	1
	11b/BPSK	1 Mbps	1/6/11	1
	11g/BPSK	6 Mbps	1/6/11	1

Radiated Emissions 9kHz~1GHz	Normal Link	-	-	-
Radiated Emissions 1GHz~10 th Harmonic	802.11n 20MHz	MCS0	1/6/11	1
	802.11n 40MHz	MCS0	3/6/9	1
	11b/BPSK	1 Mbps	1/6/11	1
	11g/BPSK	6 Mbps	1/6/11	1
Band Edge Emissions	802.11n 20MHz	MCS0	1/6/11	1
	802.11n 40MHz	MCS0	3/6/9	1
	11b/BPSK	1 Mbps	1/6/11	1
	11g/BPSK	6 Mbps	1/6/11	1

The following test modes were performed for all tests:

For Conducted Emission test:

Mode 1 has been evaluated to be the worst case for Radiated emission below 1GHz test. Consequently, measurement for Conducted emission test will follow this same test mode.

Mode 1. HMC+ PCI-E + Diversity + PIFA with I-PEX connector

Mode 2. NGFF+ PCI-E + Diversity + PIFA with I-PEX connector

Mode 3. NGFF+ SDIO + Diversity + PIFA with I-PEX connector

Mode 2 generated the worst test result, so it was recorded in this report.

For Radiated Emission test below 1GHz:

Mode 1. HMC+ PCI-E + Diversity + PIFA with I-PEX connector

Mode 2. HMC+ PCI-E + Fixed + PIFA with I-PEX connector

Mode 1 has been evaluated to be the worst case among Mode 1~2, thus measurement for Mode 3~5 will follow this same test mode.

Mode 3. HMC+ PCI-E + Diversity + Dipole with I-PEX connector

Mode 4. NGFF+ PCI-E + Diversity + PIFA with I-PEX MHF4 connector

Mode 5. NGFF+ SDIO + Diversity + PIFA with I-PEX MHF4 connector

Mode 1 generated the worst test result, so it was recorded in this report.

For Radiated Emission test above 1GHz:

Mode 1. HMC+ Diversity + PIFA with I-PEX connector

Mode 2. HMC+ Fixed + PIFA with I-PEX connector

Mode 3. NGFF+ Diversity + PIFA with I-PEX MHF4 connector

Mode 4. NGFF+ Fixed + PIFA with I-PEX MHF4 connector

Mode 1 and Mode 2 has been evaluated to be the worst case among Mode 1~4, thus measurement for Mode 5~6 will follow this same test mode.

Mode 5. HMC+ Diversity + Dipole with I-PEX connector

Mode 6. HMC+ Fixed + Dipole with I-PEX connector

Mode 1 and Mode 5 generated the worst test result, so they were recorded in the report.

For Co-location Test:

Mode 1. HMC+ Diversity + PIFA with I-PEX connector

Mode 2. HMC+ Fixed + PIFA with I-PEX connector

Mode 3. NGFF+ Diversity + PIFA with I-PEX MHF4 connector

Mode 4. NGFF+ Fixed + PIFA with I-PEX MHF4 connector

Mode 1 and Mode 2 has been evaluated to be the worst case among Mode 1~4, thus measurement for Mode 5~6 will follow this same test mode.

Mode 5. HMC+ Diversity + Dipole with I-PEX connector

Mode 6. HMC+ Fixed + Dipole with I-PEX connector

Mode 1 and Mode 5 generated the worst test result, so they were recorded in the report.

For MPE and Co-location Test:

The EUT could be applied with 2.4GHz WLAN and Bluetooth function; therefore Maximum Permissible Exposure (Please refer to Appendix B) and Co-location (please refer to Appendix C) tests are added for simultaneously transmit between 2.4GHz WLAN and Bluetooth function.

3.6. Table for Testing Locations

Test Site No.	Site Category	Location	FCC Reg. No.	IC File No.
03CH01-CB	SAC	Hsin Chu	262045	IC 4086D
CO01-CB	Conduction	Hsin Chu	262045	IC 4086D
TH01-CB	OVEN Room	Hsin Chu	-	-

Open Area Test Site (OATS); Semi Anechoic Chamber (SAC).

Please refer section 6 for Test Site Address.

3.7. Table for Supporting Units

For Test Site No : 03CH01-CB / CO01-CB

Support Unit	Brand	Model	FCC ID
Notebook	DELL	E6220	QDS-BRCM1049LE
Notebook	DELL	E6430	QDS-BRCM1049LE
Mouse	Logitech	M-U0026	DoC
Earphone	SHYARO CHI	MIC-04	N/A
Wireless AP	Planex	GW-AP54SGX	N/A
802.11b/g/n RTL8723BE Combo module	REALTEK	RTL8723BE	TX2-RTL8723BE
The test fixture	Realtek	PCIE Adapter	N/A

For Test Site No : TH01-CB

Support Unit	Brand	Model	FCC ID
Notebook	DELL	M1330	E2KWM3945ABG
The test fixture	Realtek	PCIE Adapter	N/A

3.8. Table for Parameters of Test Software Setting

During testing, Channel & Power Controlling Software provided by the customer was used to control the operating channel as well as the output power level. The RF output power selection is for the setting of RF output power expected by the customer and is going to be fixed on the firmware of the final end product.

Power Parameters of IEEE 802.11n

Test Software Version	Realtek Realtek 11n 8723B PCIE WLAN MP Diagnostic Program 0.0014.20130205		
Frequency	2412 MHz	2437 MHz	2462 MHz
MCS0 20MHz	44	49	42
Frequency	2422 MHz	2437 MHz	2452 MHz
MCS0 40MHz	45	52	44

Power Parameters of IEEE 802.11b/g

Test Software Version	Realtek Realtek 11n 8723B PCIE WLAN MP Diagnostic Program 0.0014.20130205		
Frequency	2412 MHz	2437 MHz	2462 MHz
IEEE 802.11b	40	40	40
IEEE 802.11g	45	49	45

3.9. Duty Cycle

IEEE 802.11n MCS0 20MHz

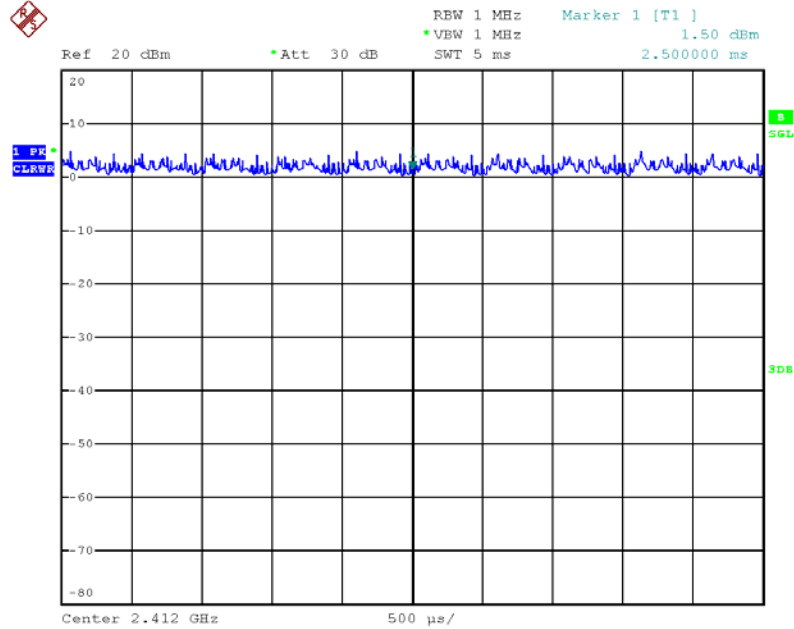

Date: 26.MAR.2013 17:55:43

IEEE 802.11n MCS0 40MHz

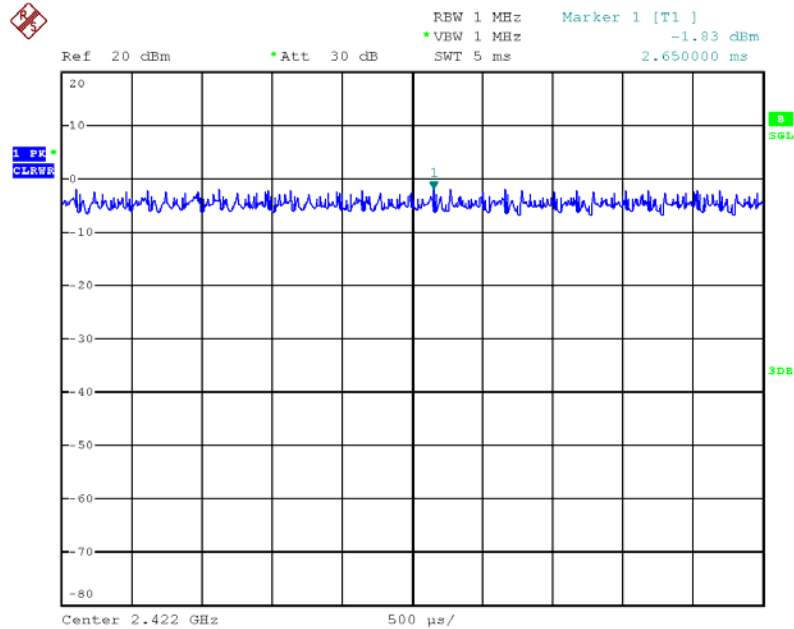

Date: 26.MAR.2013 17:56:22

IEEE 802.11b

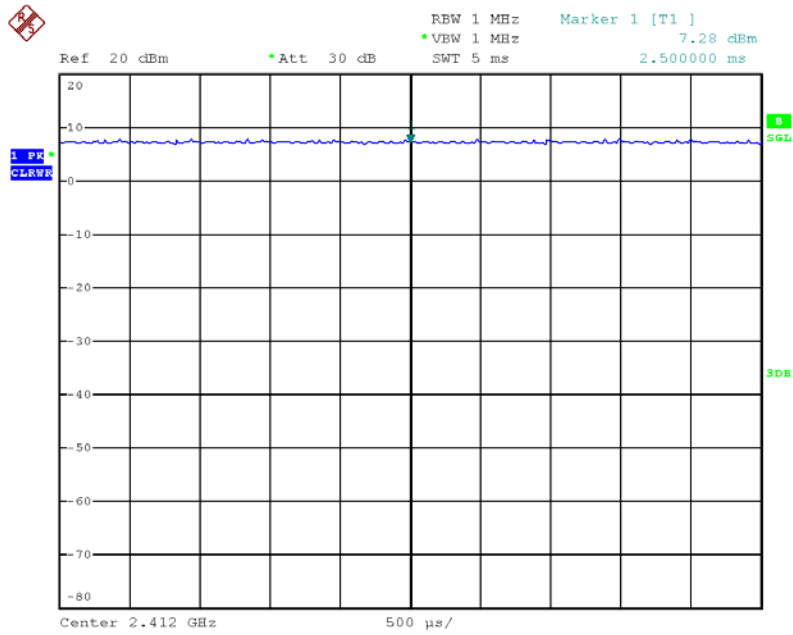

Date: 26.MAR.2013 17:54:05

IEEE 802.11g

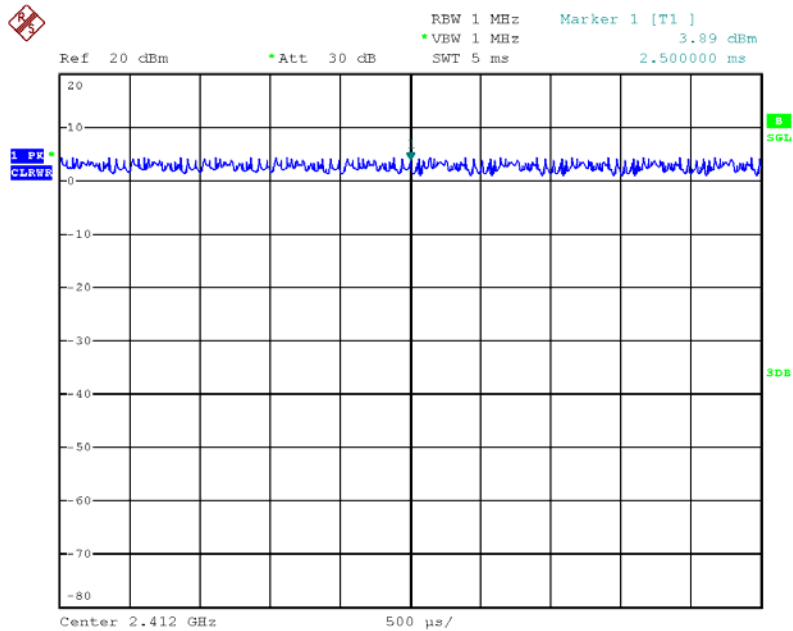

Date: 26.MAR.2013 17:55:01

3.10. Test Configurations

3.10.1. AC Power Line Conduction Emissions Test Configuration

Test Mode : Mode 2

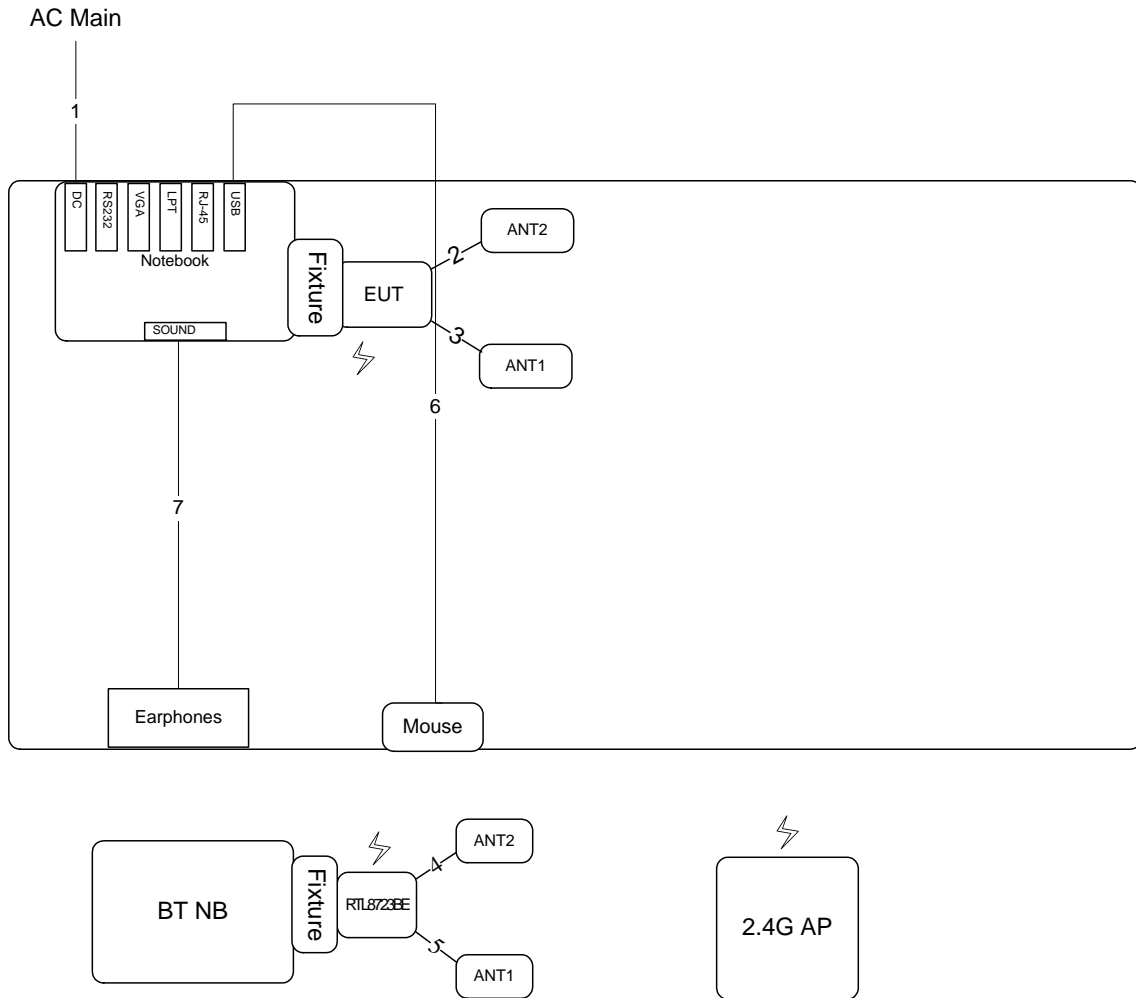

Item	Connection	Shield	Length
1	Power cable	No	2.6m
2	ANT cable	Yes	0.2m
3	ANT cable	Yes	0.2m
4	ANT cable	Yes	0.2m
5	ANT cable	Yes	0.2m
6	USB cable	No	1.8m
7	Audio cable	No	1.1m

3.10.2. Radiation Emissions Test Configuration

Test Configuration: 30MHz~1GHz

Test Mode : Mode 1

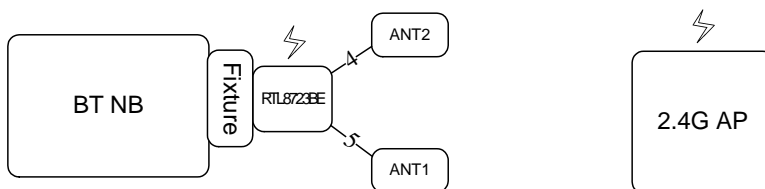
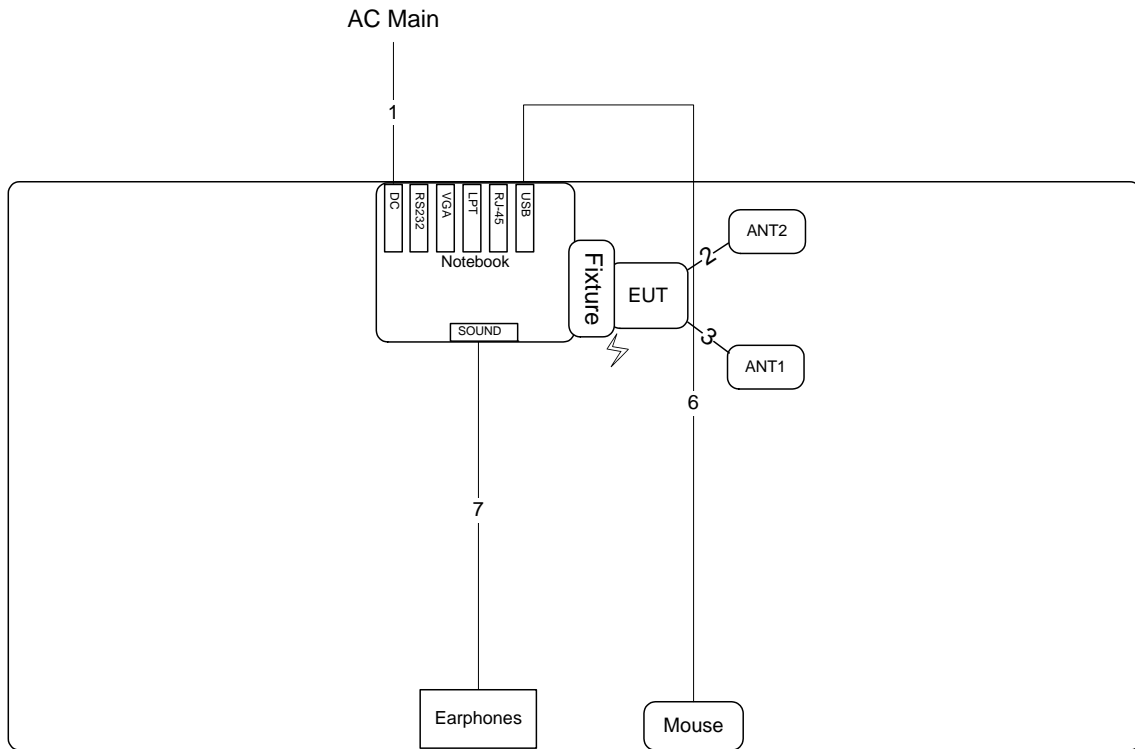

Item	Connection	Shield	Length
1	Power cable	No	2.6m
2	ANT cable	Yes	0.2m
3	ANT cable	Yes	0.2m
4	ANT cable	Yes	0.2m
5	ANT cable	Yes	0.2m
6	USB cable	No	1.8m
7	Audio cable	No	1.1m

Test Configuration: above 1GHz

Test Mode : Mode 1 and Mode 5

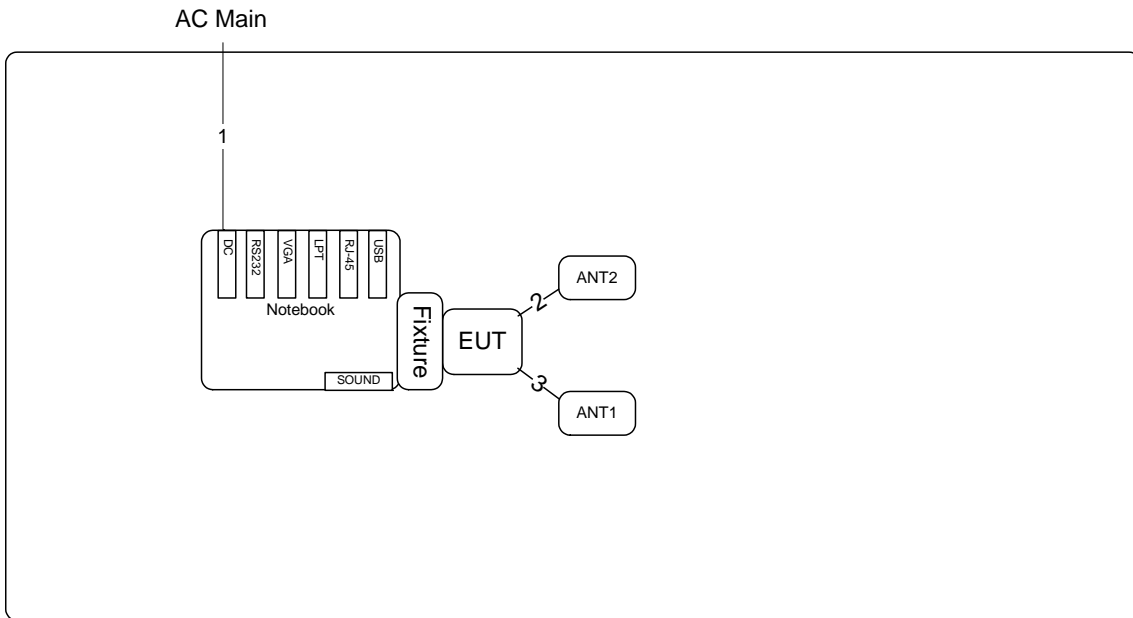

Item	Connection	Shield	Length
1	Power cable	No	2.6m
2	ANT cable	Yes	0.2m
3	ANT cable	Yes	0.2m

4. TEST RESULT

4.1. AC Power Line Conducted Emissions Measurement

4.1.1. Limit

For this product which is designed to be connected to the AC power line, the radio frequency voltage that is conducted back onto the AC power line on any frequency or frequencies within the band 150 kHz to 30 MHz shall not exceed below limits table.

Frequency (MHz)	QP Limit (dBuV)	AV Limit (dBuV)
0.15~0.5	66~56	56~46
0.5~5	56	46
5~30	60	50

4.1.2. Measuring Instruments and Setting

Please refer to section 5 of equipments list in this report. The following table is the setting of the receiver.

Receiver Parameters	Setting
Attenuation	10 dB
Start Frequency	0.15 MHz
Stop Frequency	30 MHz
IF Bandwidth	9 KHz

4.1.3. Test Procedures

1. Configure the EUT according to ANSI C63.10. The EUT or host of EUT has to be placed 0.4 meter far from the conducting wall of the shielding room and at least 80 centimeters from any other grounded conducting surface.
2. Connect EUT or host of EUT to the power mains through a line impedance stabilization network (LISN).
3. All the support units are connected to the other LISNs. The LISN should provide 50uH/50ohms coupling impedance.
4. The frequency range from 150 KHz to 30 MHz was searched.
5. Set the test-receiver system to Peak Detect Function and Specified Bandwidth with Maximum Hold Mode.
6. The measurement has to be done between each power line and ground at the power terminal.

4.1.4. Test Setup Layout

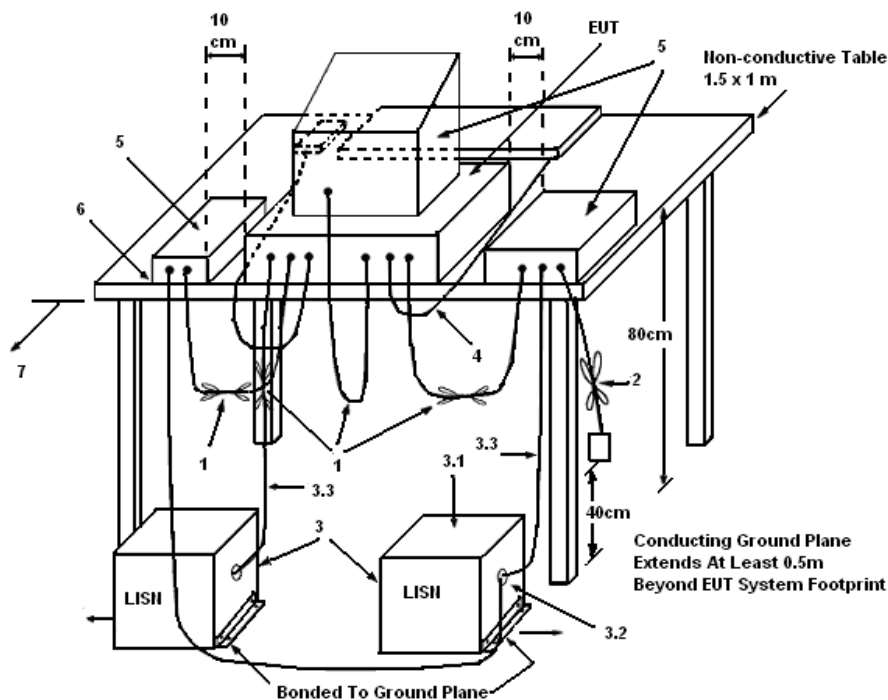

LEGEND:

- (1) Interconnecting cables that hang closer than 40 cm to the ground plane shall be folded back and forth in the center forming a bundle 30 to 40 cm long.
- (2) I/O cables that are not connected to a peripheral shall be bundled in the center. The end of the cable may be terminated, if required, using the correct terminating impedance. The overall length shall not exceed 1 m.
- (3) EUT connected to one LISN. Unused LISN measuring port connectors shall be terminated in 50 Ω . LISN can be placed on top of, or immediately beneath, reference ground plane.
 - (3.1) All other equipment powered from additional LISN(s).
 - (3.2) Multiple outlet strip can be used for multiple power cords of non-EUT equipment.
 - (3.3) LISN at least 80 cm from nearest part of EUT chassis.
- (4) Cables of hand-operated devices, such as keyboards, mice, etc., shall be placed as for normal use.
- (5) Non-EUT components of EUT system being tested.
- (6) Rear of EUT, including peripherals, shall all be aligned and flush with rear of tabletop.
- (7) Rear of tabletop shall be 40 cm removed from a vertical conducting plane that is bonded to the ground plane.

4.1.5. Test Deviation

There is no deviation with the original standard.

4.1.6. EUT Operation during Test

The EUT was placed on the test table and programmed in normal function.

4.1.7. Results of AC Power Line Conducted Emissions Measurement

Temperature	25°C	Humidity	60%
Test Engineer	Kane Liu	Phase	Line
Configuration	Normal Link / Mode 2		

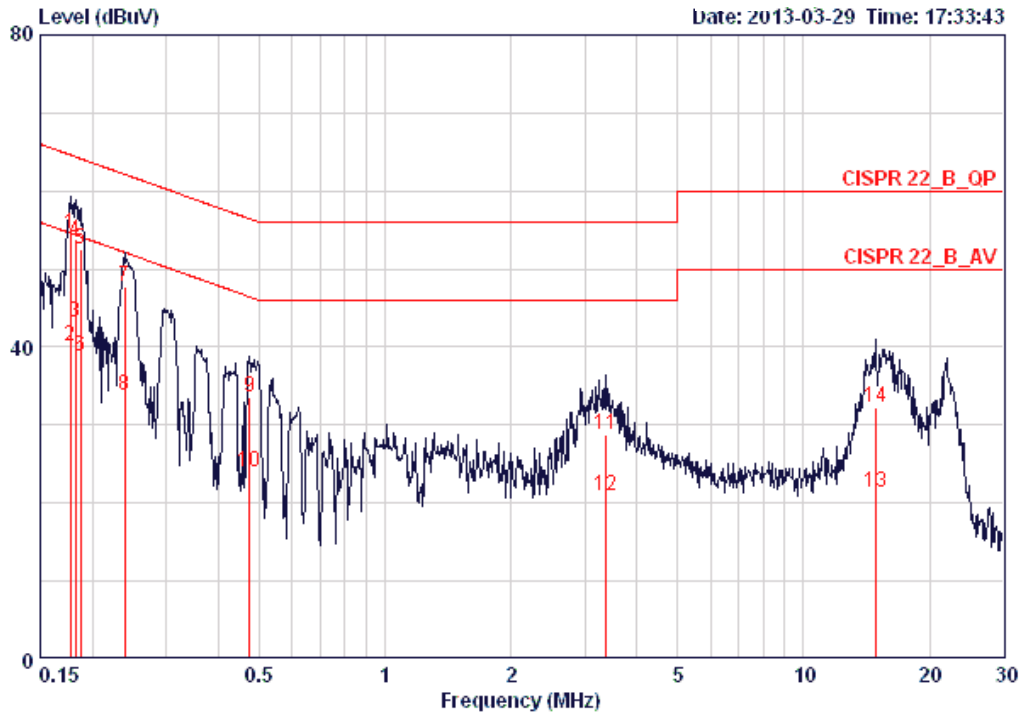

	Freq	Level	Over Limit	Limit Line	Read Level	LISN Factor	Cable Loss	Remark
	MHz	dBuV	dB	dBuV	dBuV	dB	dB	
1	0.17678	54.59	-10.04	64.64	54.25	0.15	0.19	QP
2	0.17678	40.16	-14.47	54.64	39.82	0.15	0.19	AVERAGE
3	0.18249	43.11	-11.26	54.37	42.77	0.15	0.19	AVERAGE
4	0.18249	53.64	-10.73	64.37	53.30	0.15	0.19	QP
5	0.18739	52.45	-11.71	64.15	52.10	0.15	0.20	QP
6	0.18739	38.84	-15.32	54.15	38.49	0.15	0.20	AVERAGE
7	0.23910	47.74	-14.39	62.13	47.39	0.15	0.20	QP
8	0.23910	33.73	-18.40	52.13	33.38	0.15	0.20	AVERAGE
9	0.47360	33.64	-22.81	56.45	33.29	0.15	0.20	QP
10	0.47360	23.90	-22.55	46.45	23.55	0.15	0.20	AVERAGE
11	3.381	28.81	-27.19	56.00	28.33	0.21	0.27	QP
12	3.381	20.82	-25.18	46.00	20.34	0.21	0.27	AVERAGE
13	14.828	21.47	-28.53	50.00	20.65	0.41	0.41	AVERAGE
14	14.828	32.34	-27.66	60.00	31.52	0.41	0.41	QP

Temperature	25°C	Humidity	60%
Test Engineer	Kane Liu	Phase	Neutral
Configuration	Normal Link / Mode 2		

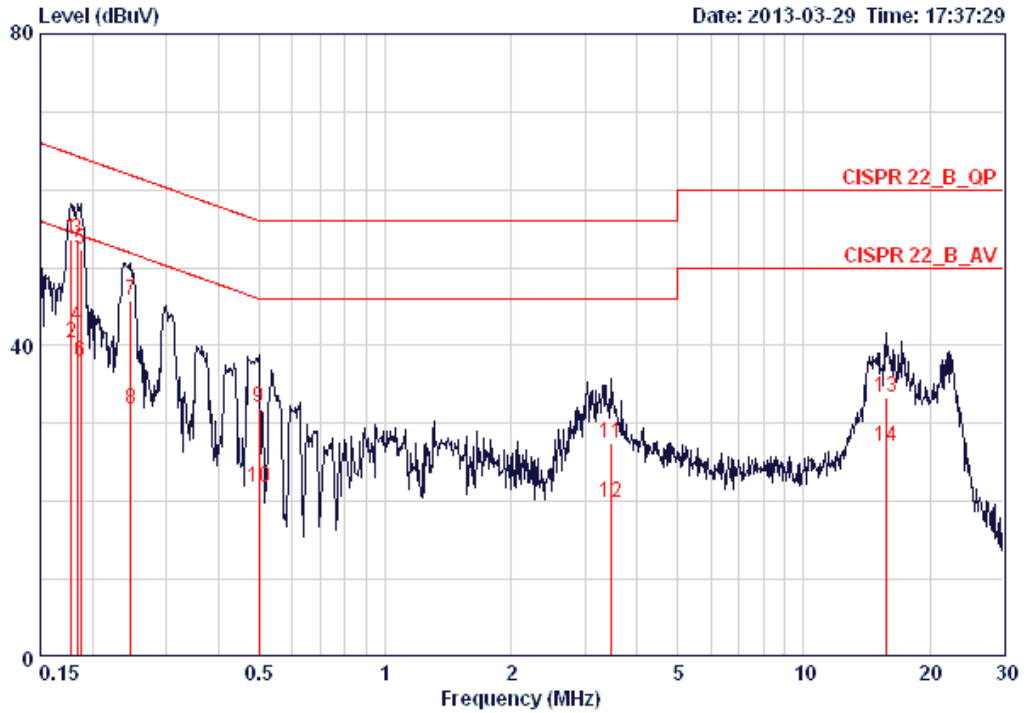

	Freq	Level	Over Limit	Limit Line	Read Level	LISN Factor	Cable Loss	Remark
	MHz	dBuV	dB	dBuV	dBuV	dB	dB	
1	0.17772	53.64	-10.95	64.59	53.37	0.08	0.19	QP
2	0.17772	40.29	-14.30	54.59	40.02	0.08	0.19	AVERAGE
3	0.18346	53.59	-10.73	64.33	53.32	0.08	0.19	QP
4	0.18346	42.45	-11.87	54.33	42.18	0.08	0.19	AVERAGE
5	0.18739	52.33	-11.83	64.15	52.05	0.08	0.20	QP
6	0.18739	37.90	-16.26	54.15	37.62	0.08	0.20	AVERAGE
7	0.24682	45.80	-16.06	61.86	45.52	0.08	0.20	QP
8	0.24682	31.88	-19.98	51.86	31.60	0.08	0.20	AVERAGE
9	0.49937	32.02	-23.99	56.01	31.74	0.08	0.20	QP
10	0.49937	21.79	-24.22	46.01	21.51	0.08	0.20	AVERAGE
11	3.472	27.43	-28.57	56.00	27.03	0.12	0.28	QP
12	3.472	19.86	-26.14	46.00	19.46	0.12	0.28	AVERAGE
13	15.718	33.27	-26.73	60.00	32.54	0.33	0.40	QP
14	15.718	26.97	-23.03	50.00	26.24	0.33	0.40	AVERAGE

Note:

Level = Read Level + LISN Factor + Cable Loss.

4.2. Maximum Conducted Output Power Measurement

4.2.1. Limit

For systems using digital modulation in the 2400-2483.5MHz, the limit for output power is 30dBm. The limited has to be reduced by the amount in dB that the gain of the antenna exceed 6dBi. In case of point-to-point operation, the limit has to be reduced by 1dB for every 3dB that the directional gain of the antenna exceeds 6dBi.

4.2.2. Measuring Instruments and Setting

Please refer to section 5 of equipments list in this report. The following table is the setting of the power meter.

Power Meter Parameter	Setting
Bandwidth	50MHz bandwidth is greater than the EUT emission bandwidth
Detector	Average

4.2.3. Test Procedures

1. Test procedures refer KDB558074 v01 r02 section 8.2.3 option 3.
2. This procedure provides an alternative for determining the RMS output power using a broadband RF average power meter with a thermocouple detector.

4.2.4. Test Setup Layout

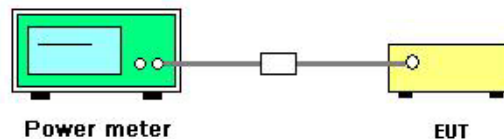

4.2.5. Test Deviation

There is no deviation with the original standard.

4.2.6. EUT Operation during Test

The EUT was programmed to be in continuously transmitting mode.

4.2.7. Test Result of Maximum Conducted Output Power

Temperature	25°C	Humidity	56%
Test Engineer	Denis Su	Configurations	IEEE 802.11n
Test Date	Mar. 26, 2013		

Configuration IEEE 802.11n MCS0 20MHz / Chain 1

Channel	Frequency	Conducted Power (dBm)	Max. Limit (dBm)	Result
1	2412 MHz	13.68	30.00	Complies
6	2437 MHz	16.05	30.00	Complies
11	2462 MHz	13.57	30.00	Complies

Configuration IEEE 802.11n MCS0 40MHz / Chain 1

Channel	Frequency	Conducted Power (dBm)	Max. Limit (dBm)	Result
3	2422 MHz	13.46	30.00	Complies
6	2437 MHz	16.12	30.00	Complies
9	2452 MHz	13.31	30.00	Complies

Temperature	25°C	Humidity	56%
Test Engineer	Denis Su	Configurations	IEEE 802.11b/g
Test Date	Mar. 26, 2013		

Configuration IEEE 802.11b / Chain 1

Channel	Frequency	Conducted Power (dBm)	Max. Limit (dBm)	Result
1	2412 MHz	16.45	30.00	Complies
6	2437 MHz	16.59	30.00	Complies
11	2462 MHz	16.78	30.00	Complies

Configuration IEEE 802.11g / Chain 1

Channel	Frequency	Conducted Power (dBm)	Max. Limit (dBm)	Result
1	2412 MHz	14.25	30.00	Complies
6	2437 MHz	16.14	30.00	Complies
11	2462 MHz	14.74	30.00	Complies

4.3. Power Spectral Density Measurement

4.3.1. Limit

For digitally modulated systems, the power spectral density conducted from the intentional radiator to the antenna shall not be greater than 8 dBm in any 3 kHz band during any time interval of continuous transmission.

4.3.2. Measuring Instruments and Setting

Please refer to section 5 of equipments list in this report. The following table is the setting of the spectrum analyzer.

Spectrum Parameter	Setting
Attenuation	Auto
Span Frequency	Set the span to 1.5 times the DTS channel bandwidth.
RB	≥ 3 kHz
VB	$\geq 3 \times$ RBW
Detector	Peak
Trace	Max Hold
Sweep Time	Auto couple

4.3.3. Test Procedures

1. Test procedures refer KDB 558074 v01 r02 section 9.1 option 1 & KDB662911 D01 Multiple Transmitter Output v01r02 section In-Band Power Spectral Density (PSD) Measurements option (2) Measure and add $10 \log(NANT)$ dB.
2. Use this procedure when the maximum conducted output power in the fundamental emission is used to demonstrate compliance. The EUT must be configured to transmit continuously at full power over the measurement duration.
3. Ensure that the number of measurement points in the sweep $\geq 2 \times$ span/RBW (use of a greater number of measurement points than this minimum requirement is recommended).
4. Use the peak marker function to determine the maximum level in any 3 kHz band segment within the fundamental EBW.
5. The resulting PSD level must be ≤ 8 dBm.

4.3.4. Test Setup Layout

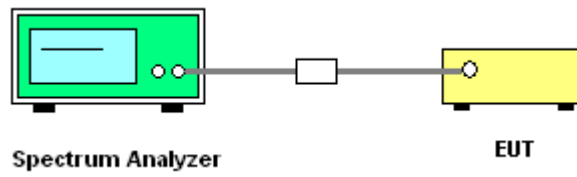

4.3.5. Test Deviation

There is no deviation with the original standard.

4.3.6. EUT Operation during Test

The EUT was programmed to be in continuously transmitting mode.

4.3.7. Test Result of Power Spectral Density

Temperature	25°C	Humidity	56%
Test Engineer	Denis Su	Configurations	IEEE 802.11n

Configuration IEEE 802.11n MCS0 20MHz / Chain 1

Channel	Frequency	Power Density (dBm/3kHz)	Single Port Limit (dBm/3kHz)	Result
1	2412 MHz	-15.27	8	Complies
6	2437 MHz	-12.89	8	Complies
11	2462 MHz	-15.71	8	Complies

Configuration IEEE 802.11n MCS0 40MHz / Chain 1

Channel	Frequency	Power Density (dBm/3kHz)	Single Port Limit (dBm/3kHz)	Result
3	2422 MHz	-15.58	8	Complies
6	2437 MHz	-12.44	8	Complies
9	2452 MHz	-16.91	8	Complies

Temperature	25°C	Humidity	56%
Test Engineer	Denis Su	Configurations	IEEE 802.11b/g

Configuration IEEE 802.11b / Chain 1

Channel	Frequency	Power Density (dBm/3kHz)	Single Port Limit (dBm/3kHz)	Result
1	2412 MHz	-13.96	8.00	Complies
6	2437 MHz	-14.36	8.00	Complies
11	2462 MHz	-14.13	8.00	Complies

Configuration IEEE 802.11g / Chain 1

Channel	Frequency	Power Density (dBm/3kHz)	Single Port Limit (dBm/3kHz)	Result
1	2412 MHz	-14.98	8.00	Complies
6	2437 MHz	-13.00	8.00	Complies
11	2462 MHz	-15.37	8.00	Complies

Note: All the test values were listed in the report.

For plots, only the channel with maximum results was shown.

Power Density Plot on Configuration IEEE 802.11n MCS0 20MHz / Chain 1 / 2437 MHz

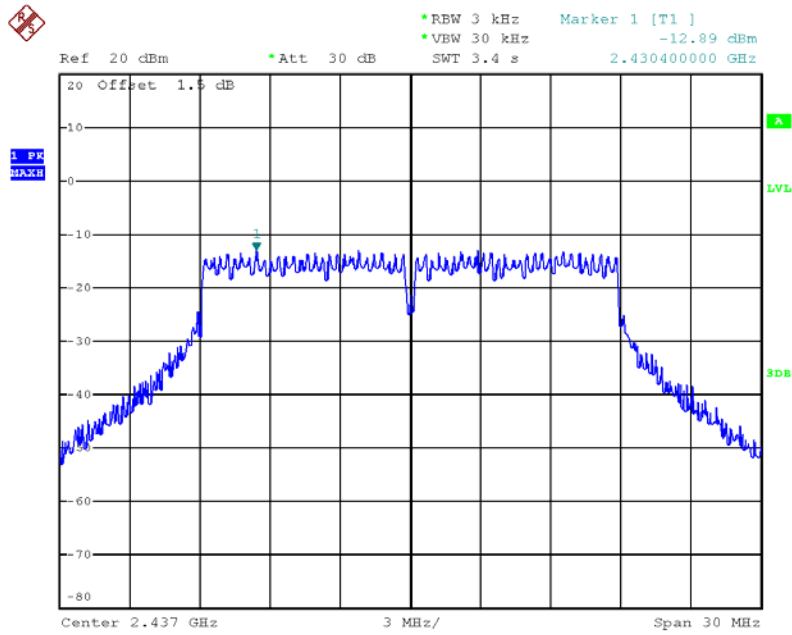

Date: 26.MAR.2013 02:34:36

Power Density Plot on Configuration IEEE 802.11n MCS0 40MHz / Chain 1 / 2437 MHz

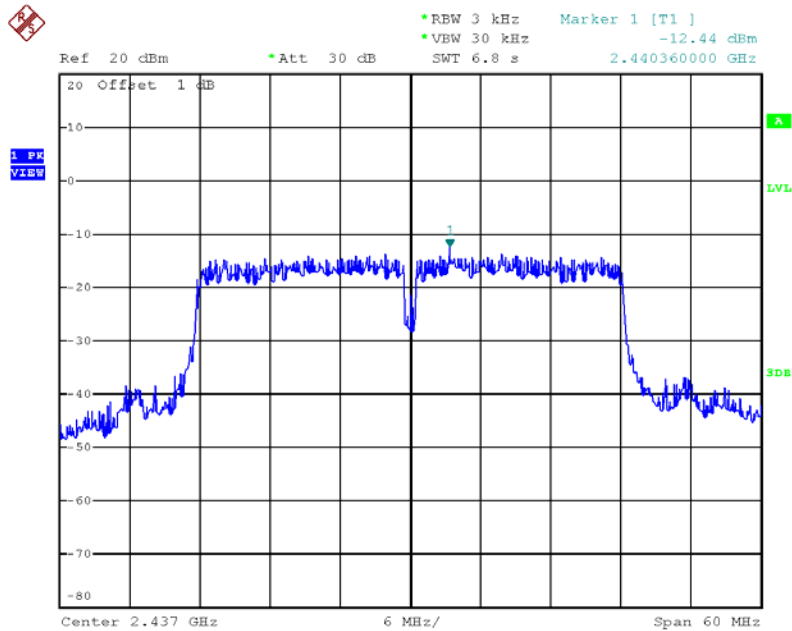

Date: 6.APR.2013 20:23:29

4.4. 6dB Spectrum Bandwidth Measurement

4.4.1. Limit

For digital modulation systems, the minimum 6 dB bandwidth shall be at least 500 kHz.

4.4.2. Measuring Instruments and Setting

Please refer to section 5 of equipments list in this report. The following table is the setting of the Spectrum Analyzer.

Spectrum Parameters	Setting
Attenuation	Auto
Span Frequency	> 6dB Bandwidth
RB	1-5 % or DTS BW, not exceed 100KHz
VB	$\geq 3 \times \text{RBW}$
Detector	Peak
Trace	Max Hold
Sweep Time	Auto

4.4.3. Test Procedures

1. The transmitter output (antenna port) was connected to the spectrum analyzer in peak hold mode.
2. Test was performed in accordance with KDB 558074 Guidance for Performing Compliance Measurements on Digital Transmission Systems (DTS) Operating Under §15.247 section 5.1.1 EBW Measurement Procedure
3. Multiple antenna system was performed in accordance with KDB 662911 Emissions Testing of Transmitters with Multiple Outputs in the Same Band.
4. Measured the spectrum width with power higher than 6dB below carrier.

4.4.4. Test Setup Layout

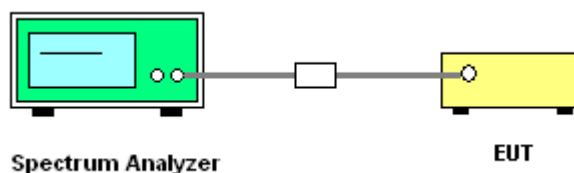

4.4.5. Test Deviation

There is no deviation with the original standard.

4.4.6. EUT Operation during Test

The EUT was programmed to be in continuously transmitting mode.

4.4.7. Test Result of 6dB Spectrum Bandwidth

Temperature	25°C	Humidity	56%
Test Engineer	Denis Su	Configurations	IEEE 802.11n

Configuration IEEE 802.11n MCS0 20MHz / Chain 1

Channel	Frequency	6dB Bandwidth (MHz)	99% Occupied Bandwidth (MHz)	Min. Limit (kHz)	Test Result
1	2412 MHz	16.40	16.40	500	Complies
6	2437 MHz	16.40	16.32	500	Complies
11	2462 MHz	16.40	16.40	500	Complies

Configuration IEEE 802.11n MCS0 40MHz / Chain 1

Channel	Frequency	6dB Bandwidth (MHz)	99% Occupied Bandwidth (MHz)	Min. Limit (kHz)	Test Result
3	2422 MHz	36.48	36.36	500	Complies
6	2437 MHz	36.48	36.36	500	Complies
9	2452 MHz	36.48	36.36	500	Complies

Temperature	25°C	Humidity	56%
Test Engineer	Denis Su	Configurations	IEEE 802.11b/g

Configuration IEEE 802.11b / Chain 1

Channel	Frequency	6dB Bandwidth (MHz)	99% Occupied Bandwidth (MHz)	Min. Limit (kHz)	Test Result
1	2412 MHz	10.08	15.12	500	Complies
6	2437 MHz	10.08	15.12	500	Complies
11	2462 MHz	10.08	15.12	500	Complies

Configuration IEEE 802.11g / Chain 1

Channel	Frequency	6dB Bandwidth (MHz)	99% Occupied Bandwidth (MHz)	Min. Limit (kHz)	Test Result
1	2412 MHz	16.40	16.40	500	Complies
6	2437 MHz	16.40	16.40	500	Complies
11	2462 MHz	16.56	16.64	500	Complies

Note: All the test values were listed in the report.

For plots, only the channel with maximum results was shown.

6 dB Bandwidth Plot on Configuration IEEE 802.11n MCS0 20MHz / Chain 1 / 2412 MHz

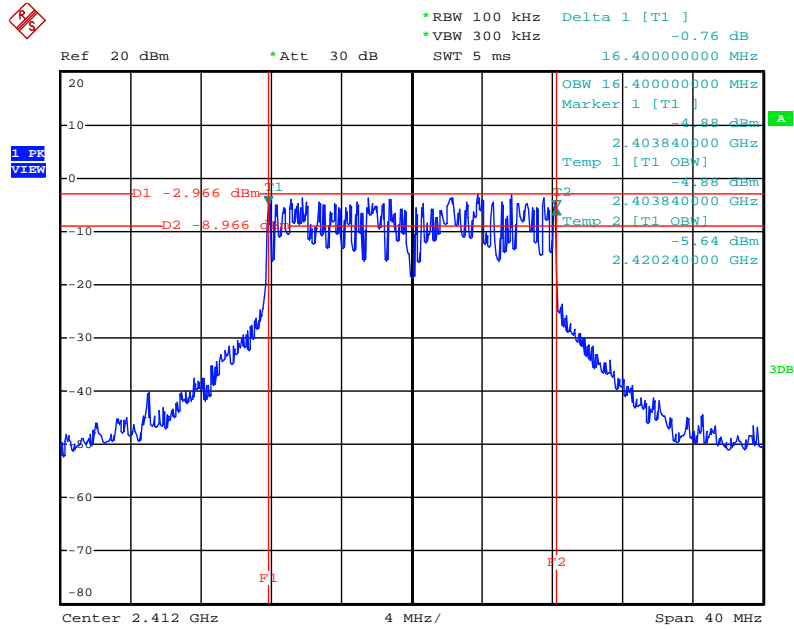

Date: 26.MAR.2013 02:00:38

6 dB Bandwidth Plot on Configuration IEEE 802.11n MCS0 40MHz / Chain 1 / 2437 MHz

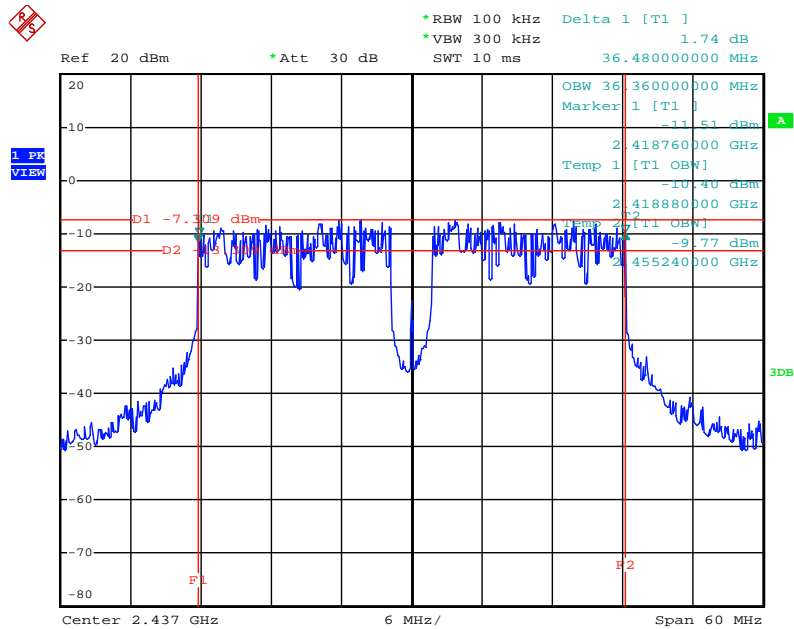

Date: 26.MAR.2013 02:04:04

6 dB Bandwidth Plot on Configuration IEEE 802.11b / Chain 1 / 2437 MHz

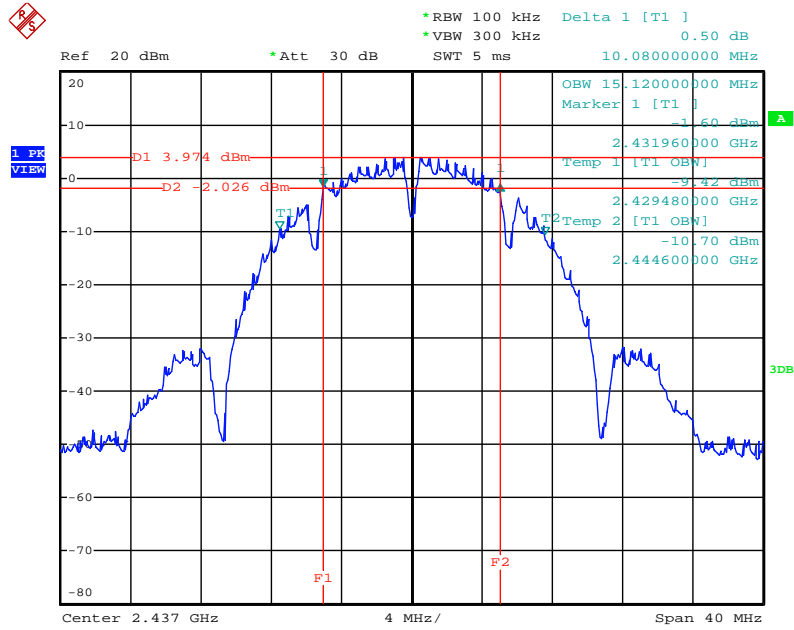

Date: 26.MAR.2013 01:56:20

6 dB Bandwidth Plot on Configuration IEEE 802.11g / Chain 1 / 2437 MHz

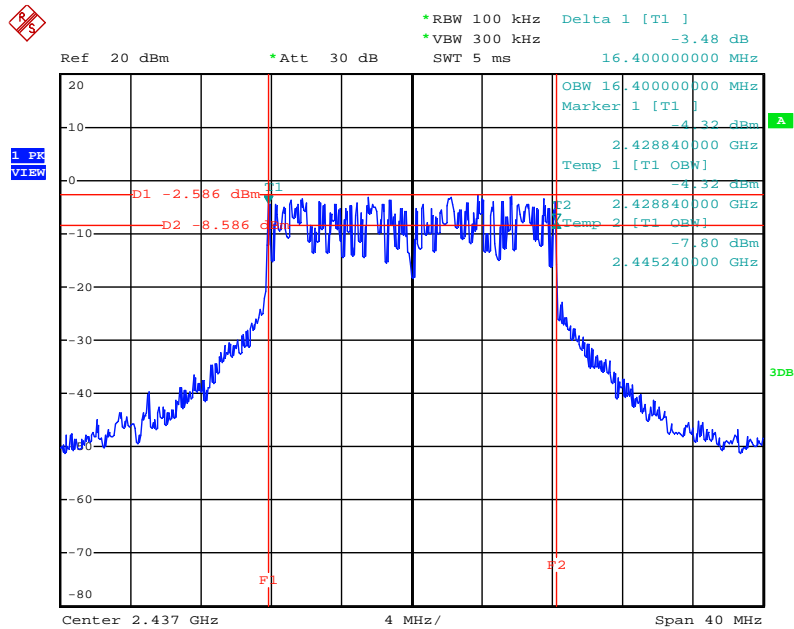

Date: 26.MAR.2013 01:58:39

4.5. Radiated Emissions Measurement

4.5.1. Limit

30dBc in any 100 kHz bandwidth outside the operating frequency band. In case the emission fall within the restricted band specified on 15.205(a), then the 15.209(a) limit in the table below has to be followed.

Frequencies (MHz)	Field Strength (micorvolts/meter)	Measurement Distance (meters)
0.009~0.490	2400/F(KHz)	300
0.490~1.705	24000/F(KHz)	30
1.705~30.0	30	30
30~88	100	3
88~216	150	3
216~960	200	3
Above 960	500	3

4.5.2. Measuring Instruments and Setting

Please refer to section 5 of equipments list in this report. The following table is the setting of spectrum analyzer and receiver.

Spectrum Parameter	Setting
Attenuation	Auto
Start Frequency	1000 MHz
Stop Frequency	10th carrier harmonic
RB / VB (Emission in restricted band)	1MHz / 3MHz for Peak, 1 MHz / 10Hz for Average
RB / VB (Emission in non-restricted band)	100kHz / 300kHz for peak

Receiver Parameter	Setting
Attenuation	Auto
Start ~ Stop Frequency	9kHz~150kHz / RB 200Hz for QP
Start ~ Stop Frequency	150kHz~30MHz / RB 9kHz for QP
Start ~ Stop Frequency	30MHz~1000MHz / RB 120kHz for QP

4.5.3. Test Procedures

1. Configure the EUT according to ANSI C63.10. The EUT was placed on the top of the turntable 0.8 meter above ground. The phase center of the receiving antenna mounted on the top of a height-variable antenna tower was placed 3 meters far away from the turntable.
2. Power on the EUT and all the supporting units. The turntable was rotated by 360 degrees to determine the position of the highest radiation.
3. The height of the broadband receiving antenna was varied between one meter and four meters above ground to find the maximum emissions field strength of both horizontal and vertical polarization.
4. For each suspected emissions, the antenna tower was scan (from 1 m to 4 m) and then the turntable was rotated (from 0 degree to 360 degrees) to find the maximum reading.
5. Set the test-receiver system to Peak or CISPR quasi-peak Detect Function with specified bandwidth under Maximum Hold Mode.
6. For emissions above 1GHz, use 1MHz VBW and 3MHz RBW for peak reading. Then 1MHz RBW and 10Hz VBW for average reading in spectrum analyzer.
7. When the radiated emissions limits are expressed in terms of the average value of the emissions, and pulsed operation is employed, the measurement field strength shall be determined by averaging over one complete pulse train, including blanking intervals, as long as the pulse train does not exceed 0.1 seconds. As an alternative (provided the transmitter operates for longer than 0.1 seconds) or in cases where the pulse train exceeds 0.1 seconds, the measured field strength shall be determined from the average absolute voltage during a 0.1 second interval during which the field strength is at its maximum value.
8. If the emissions level of the EUT in peak mode was 3 dB lower than the average limit specified, then testing will be stopped and peak values of EUT will be reported, otherwise, the emissions which do not have 3 dB margin will be repeated one by one using the quasi-peak method for below 1GHz.
9. For testing above 1GHz, the emissions level of the EUT in peak mode was lower than average limit (that means the emissions level in peak mode also complies with the limit in average mode), then testing will be stopped and peak values of EUT will be reported, otherwise, the emissions will be measured in average mode again and reported.
10. In case the emission is lower than 30MHz, loop antenna has to be used for measurement and the recorded data should be QP measured by receiver. High – Low scan is not required in this case.

4.5.4. Test Setup Layout

For Radiated Emissions below 1GHz

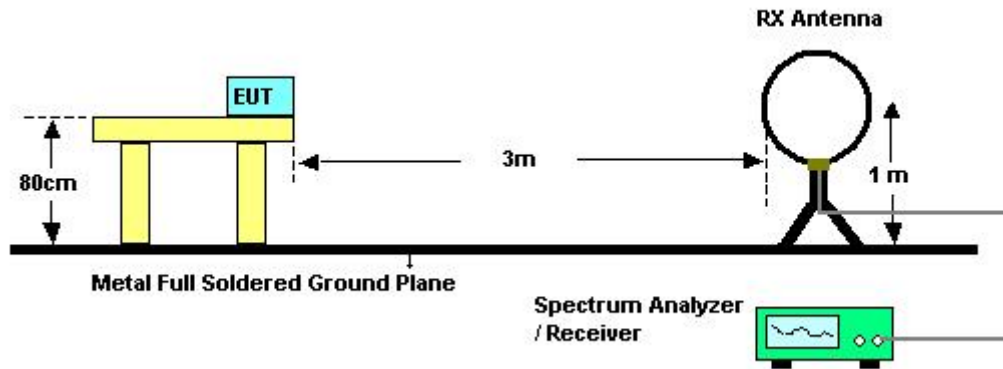

For Radiated Emissions above 1GHz

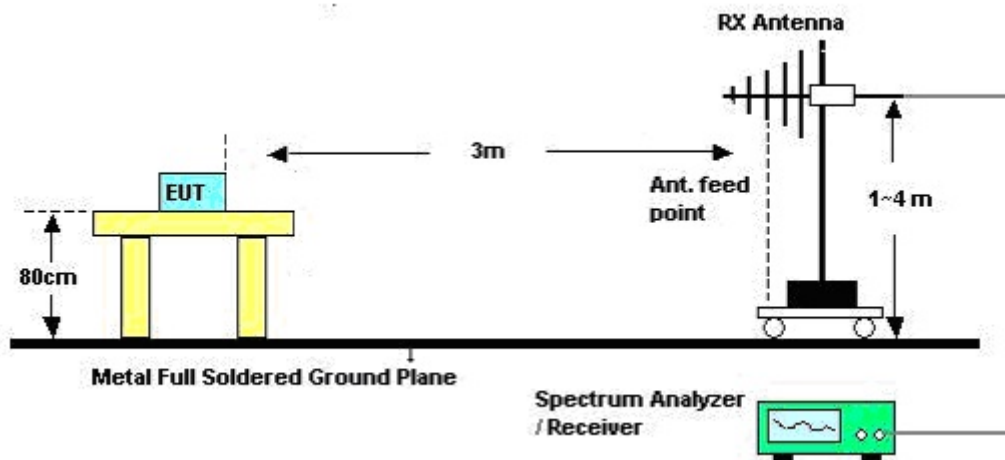

4.5.5. Test Deviation

There is no deviation with the original standard.

4.5.6. Results of Radiated Emissions (9kHz~30MHz)

Temperature	24.5°C	Humidity	60%
Test Engineer	David Tseng	Configurations	Normal Link
Test Date	Mar. 29, 2013		

Freq. (MHz)	Level (dBuV)	Over Limit (dB)	Limit Line (dBuV)	Remark
-	-	-	-	See Note

Note:

The amplitude of spurious emissions which are attenuated by more than 20 dB below the permissible value has no need to be reported.

Distance extrapolation factor = $40 \log (\text{specific distance} / \text{test distance})$ (dB);

Limit line = specific limits (dBuV) + distance extrapolation factor.

4.5.7. Results of Radiated Emissions (30MHz~1GHz)

Temperature	24.5°C	Humidity	60%
Test Engineer	David Tseng	Configurations	Normal Link / Mode 1

Horizontal

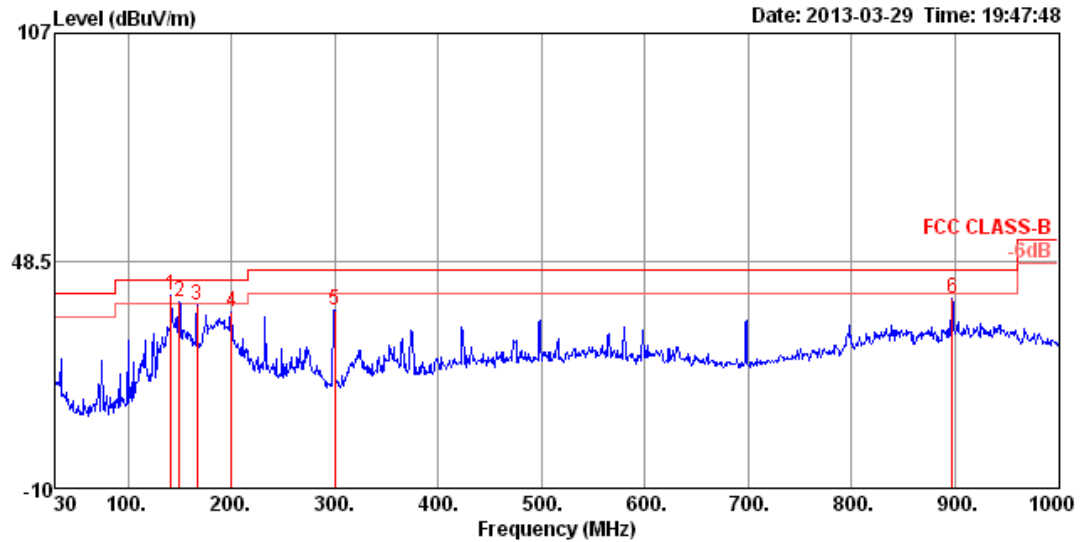

	Freq	Level	Limit	Over	Read	CableAntenna	Preamp	A/Pos	T/Pos	Pol/Phase	Remark
	MHz	dBuV/m	dBuV/m	dB	dBuV	dB	dB/m	dB	cm	deg	
1	pp	141.55	39.63	43.50	-3.87	59.01	1.41	10.74	31.53	125	0 HORIZONTAL Peak
2	!	149.31	38.08	43.50	-5.42	58.13	1.47	10.04	31.56	125	356 HORIZONTAL Peak
3		166.77	37.16	43.50	-6.34	57.81	1.57	9.32	31.54	200	355 HORIZONTAL Peak
4		199.75	35.46	43.50	-8.04	56.52	1.70	8.75	31.51	125	0 HORIZONTAL Peak
5		299.66	35.78	46.00	-10.22	52.05	2.13	13.02	31.42	125	47 HORIZONTAL Peak
6		897.18	38.77	46.00	-7.23	45.38	3.97	20.62	31.20	100	102 HORIZONTAL Peak

Vertical

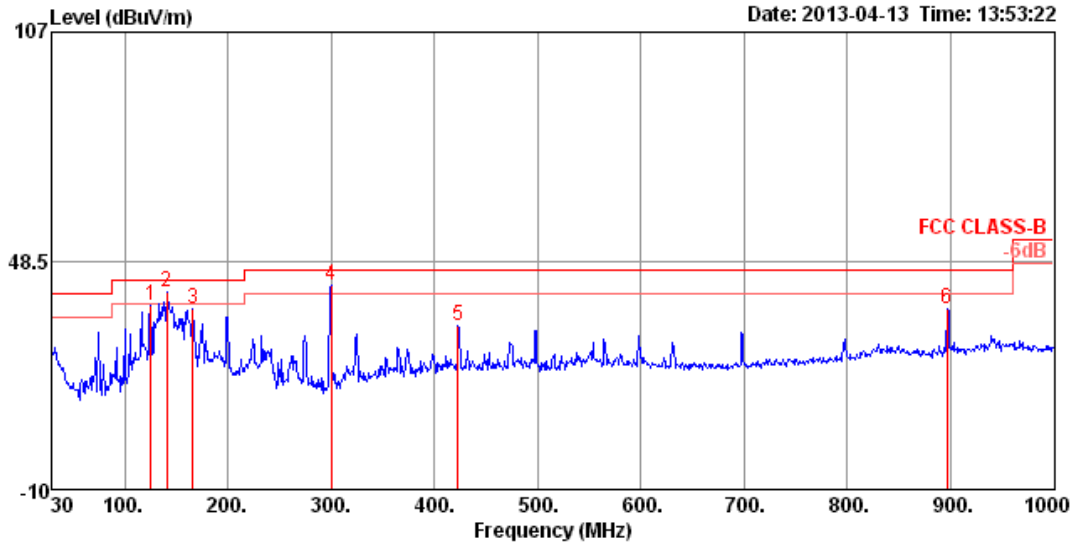

	Freq	Level	Limit	Over	Read	CableAntenna	Preamp	A/Pos	T/Pos	Pol/Phase	Remark
	MHz	dBuV/m	dBuV/m	dB	dBuV	dB	dB/m	dB	cm	deg	
1	125.06	37.22	43.50	-6.28	55.73	1.33	11.73	31.57	100	31	VERTICAL Peak
2	140.58	40.36	43.50	-3.14	59.66	1.40	10.82	31.52	100	283	VERTICAL Peak
3	165.80	36.22	43.50	-7.28	56.82	1.56	9.38	31.54	100	152	VERTICAL Peak
4	299.66	42.17	46.00	-3.83	58.44	2.13	13.02	31.42	200	22	VERTICAL Peak
5	422.85	32.09	46.00	-13.91	44.36	2.57	16.39	31.23	200	354	VERTICAL Peak
6	896.21	35.99	46.00	-10.01	42.60	3.97	20.61	31.19	100	102	VERTICAL Peak

Note:

The amplitude of spurious emissions which are attenuated by more than 20 dB below the permissible value has no need to be reported.

Emission level (dBuV/m) = 20 log Emission level (uV/m).

Corrected Reading: Antenna Factor + Cable Loss + Read Level - Preamp Factor = Level.

4.5.8. Results for Radiated Emissions (1GHz~10th Harmonic)

Temperature	25.6°C	Humidity	56%
Test Engineer	Denis Su	Configurations	IEEE 802.11n MCS0 20MHz Ch 1 / Chain 1 / Mode 1
Test Date	Feb. 23, 2013		

Horizontal

	Freq	Level	Limit Line	Over Limit	Read Level	CableAntenna Loss	Antenna Factor	Preamp Factor	Remark	A/Pos	T/Pos	Pol/Phase
	MHz	dBuV/m	dBuV/m	dB	dBuV	dB	dB/m	dB		cm	deg	
1	4821.83	41.92	74.00	-32.08	40.58	3.31	33.06	35.03	Peak	100	33	HORIZONTAL
2	4823.98	33.63	54.00	-20.37	32.29	3.31	33.06	35.03	Average	100	33	HORIZONTAL

Vertical

	Freq	Level	Limit Line	Over Limit	Read Level	CableAntenna Loss	Antenna Factor	Preamp Factor	Remark	A/Pos	T/Pos	Pol/Phase
	MHz	dBuV/m	dBuV/m	dB	dBuV	dB	dB/m	dB		cm	deg	
1	4823.86	45.71	74.00	-28.29	44.37	3.31	33.06	35.03	Peak	109	93	VERTICAL
2	4823.99	35.41	54.00	-18.59	34.07	3.31	33.06	35.03	Average	109	93	VERTICAL

Temperature	25.6°C	Humidity	56%
Test Engineer	Denis Su	Configurations	IEEE 802.11n MCS0 20MHz Ch 6 / Chain 1 / Mode 1
Test Date	Feb. 23, 2013		

Horizontal

	Freq	Level	Limit	Over	Read	CableAntenna	Preamp	Remark	A/Pos	T/Pos	Pol/Phase
	MHz	dBuV/m	dBuV/m	dB	dBuV	dB	dB/m	dB	cm	deg	
1	4874.06	34.84	54.00	-19.16	33.38	3.33	33.16	35.03	Average	116	299 HORIZONTAL
2	4874.67	47.74	74.00	-26.26	46.28	3.33	33.16	35.03	Peak	116	299 HORIZONTAL
3	7311.92	35.03	54.00	-18.97	30.41	4.06	35.96	35.40	Average	100	360 HORIZONTAL
4	7313.49	43.59	74.00	-30.41	38.97	4.06	35.96	35.40	Peak	100	360 HORIZONTAL

Vertical

	Freq	Level	Limit	Over	Read	CableAntenna	Preamp	Remark	A/Pos	T/Pos	Pol/Phase
	MHz	dBuV/m	dBuV/m	dB	dBuV	dB	dB/m	dB	cm	deg	
1	4873.94	35.30	54.00	-18.70	33.84	3.33	33.16	35.03	Average	114	90 VERTICAL
2	4874.29	47.48	74.00	-26.52	46.02	3.33	33.16	35.03	Peak	114	90 VERTICAL
3	7309.61	55.72	74.00	-18.28	51.10	4.06	35.96	35.40	Peak	100	77 VERTICAL
4	7311.51	38.26	54.00	-15.74	33.64	4.06	35.96	35.40	Average	100	77 VERTICAL

Temperature	25.6°C	Humidity	56%
Test Engineer	Denis Su	Configurations	IEEE 802.11n MCS0 20MHz Ch11 / Chain 1 / Mode 1
Test Date	Feb. 23, 2013		

Horizontal

	Freq	Level	Limit Line	Over Limit	Read Level	CableAntenna Loss	Antenna Factor	Preamp Factor	Remark	A/Pos	T/Pos	Pol/Phase
	MHz	dBuV/m	dBuV/m	dB	dBuV	dB	dB/m	dB		cm	deg	
1	4923.97	36.86	54.00	-17.14	35.26	3.35	33.26	35.01	Average	100	300	HORIZONTAL
2	4924.13	46.76	74.00	-27.24	45.16	3.35	33.26	35.01	Peak	100	300	HORIZONTAL
3	7386.26	34.65	54.00	-19.35	29.90	4.06	36.09	35.40	Average	100	18	HORIZONTAL
4	7386.58	48.12	74.00	-25.88	43.37	4.06	36.09	35.40	Peak	100	18	HORIZONTAL

Vertical

	Freq	Level	Limit Line	Over Limit	Read Level	CableAntenna Loss	Antenna Factor	Preamp Factor	Remark	A/Pos	T/Pos	Pol/Phase
	MHz	dBuV/m	dBuV/m	dB	dBuV	dB	dB/m	dB		cm	deg	
1	4923.87	46.37	74.00	-27.63	44.77	3.35	33.26	35.01	Peak	113	88	VERTICAL
2	4923.90	36.14	54.00	-17.86	34.54	3.35	33.26	35.01	Average	113	88	VERTICAL
3	7384.47	51.06	74.00	-22.94	46.31	4.06	36.09	35.40	Peak	100	66	VERTICAL
4	7386.61	35.81	54.00	-18.19	31.06	4.06	36.09	35.40	Average	100	66	VERTICAL

Temperature	25.6°C	Humidity	56%
Test Engineer	Denis Su	Configurations	IEEE 802.11n MCS0 40MHz Ch 3 / Chain 1 / Mode 1
Test Date	Feb. 23, 2013		

Horizontal

	Freq	Level	Limit Line	Over Limit	Read Level	CableAntenna Loss	Antenna Factor	Preamp Factor	Remark	A/Pos	T/Pos	Pol/Phase
	MHz	dBuV/m	dBuV/m	dB	dBuV	dB	dB/m	dB		cm	deg	
1	4843.90	32.77	54.00	-21.23	31.39	3.32	33.09	35.03	Average	100	243	HORIZONTAL
2	4843.90	45.46	74.00	-28.54	44.08	3.32	33.09	35.03	Peak	100	243	HORIZONTAL

Vertical

	Freq	Level	Limit Line	Over Limit	Read Level	CableAntenna Loss	Antenna Factor	Preamp Factor	Remark	A/Pos	T/Pos	Pol/Phase
	MHz	dBuV/m	dBuV/m	dB	dBuV	dB	dB/m	dB		cm	deg	
1	4844.03	35.68	54.00	-18.32	34.30	3.32	33.09	35.03	Average	109	96	VERTICAL
2	4844.29	46.42	74.00	-27.58	45.04	3.32	33.09	35.03	Peak	109	96	VERTICAL

Temperature	25.6°C	Humidity	56%
Test Engineer	Denis Su	Configurations	IEEE 802.11n MCS0 40MHz Ch 6 / Chain 1 / Mode 1
Test Date	Feb. 23, 2013		

Horizontal

	Freq	Level	Limit Line	Over Limit	Read Level	Cable Loss	Antenna Factor	Preamp Factor	Remark	A/Pos	T/Pos	PoI/Phase
	MHz	dBuV/m	dBuV/m	dB	dBuV	dB	dB/m	dB		cm	deg	
1	4873.99	45.44	74.00	-28.56	43.98	3.33	33.16	35.03	Peak	100	79	HORIZONTAL
2	4874.00	32.24	54.00	-21.76	30.78	3.33	33.16	35.03	Average	100	79	HORIZONTAL
3	7308.74	48.56	74.00	-25.44	43.94	4.06	35.96	35.40	Peak	100	354	HORIZONTAL
4	7312.99	34.04	54.00	-19.96	29.42	4.06	35.96	35.40	Average	100	354	HORIZONTAL

Vertical

	Freq	Level	Limit Line	Over Limit	Read Level	Cable Loss	Antenna Factor	Preamp Factor	Remark	A/Pos	T/Pos	PoI/Phase
	MHz	dBuV/m	dBuV/m	dB	dBuV	dB	dB/m	dB		cm	deg	
1	4873.88	46.39	74.00	-27.61	44.93	3.33	33.16	35.03	Peak	109	94	VERTICAL
2	4874.01	36.33	54.00	-17.67	34.87	3.33	33.16	35.03	Average	109	94	VERTICAL
3	7309.14	47.92	74.00	-26.08	43.30	4.06	35.96	35.40	Peak	100	4	VERTICAL
4	7312.10	35.05	54.00	-18.95	30.43	4.06	35.96	35.40	Average	100	4	VERTICAL

Temperature	25.6°C	Humidity	56%
Test Engineer	Denis Su	Configurations	IEEE 802.11n MCS0 40MHz Ch 9 / Chain 1 / Mode 1
Test Date	Feb. 23, 2013		

Horizontal

	Freq	Level	Limit Line	Over Limit	Read Level	CableAntenna Loss	Antenna Factor	Preamp Factor	Remark	A/Pos	T/Pos	Pol/Phase
	MHz	dBuV/m	dBuV/m	dB	dBuV	dB	dB/m	dB		cm	deg	
1	4903.91	45.73	74.00	-28.27	44.22	3.34	33.19	35.02	Peak	115	240	HORIZONTAL
2	4903.93	34.00	54.00	-20.00	32.49	3.34	33.19	35.02	Average	115	240	HORIZONTAL
3	7353.98	34.50	54.00	-19.50	29.82	4.06	36.02	35.40	Average	100	86	HORIZONTAL
4	7354.74	48.29	74.00	-25.71	43.61	4.06	36.02	35.40	Peak	100	86	HORIZONTAL

Vertical

	Freq	Level	Limit Line	Over Limit	Read Level	CableAntenna Loss	Antenna Factor	Preamp Factor	Remark	A/Pos	T/Pos	Pol/Phase
	MHz	dBuV/m	dBuV/m	dB	dBuV	dB	dB/m	dB		cm	deg	
1	4903.86	45.86	74.00	-28.14	44.35	3.34	33.19	35.02	Peak	120	93	VERTICAL
2	4903.90	36.25	54.00	-17.75	34.74	3.34	33.19	35.02	Average	120	93	VERTICAL
3	7353.92	34.27	54.00	-19.73	29.59	4.06	36.02	35.40	Average	100	295	VERTICAL
4	7354.36	48.13	74.00	-25.87	43.45	4.06	36.02	35.40	Peak	100	295	VERTICAL

Note:

The amplitude of spurious emissions which are attenuated by more than 20 dB below the permissible value has no need to be reported.

Emission level (dBuV/m) = 20 log Emission level (uV/m).

Corrected Reading: Antenna Factor + Cable Loss + Read Level - Preamp Factor = Level.

Temperature	25.6°C	Humidity	56%
Test Engineer	Denis Su	Configurations	IEEE 802.11b CH 1 / Chain 1 / Mode 1
Test Date	Feb. 23, 2013		

Horizontal

	Freq	Level	Limit	Over	Read	CableAntenna	Preamp		A/Pos	T/Pos	PoI/Phase	
	MHz	dBuV/m	dBuV/m	dB	dBuV	Loss	Factor	Factor	Remark	cm	deg	
1	4824.00	44.81	54.00	-9.19	43.47	3.31	33.06	35.03	Average	130	116	HORIZONTAL
2	4824.06	49.94	74.00	-24.06	48.60	3.31	33.06	35.03	Peak	130	116	HORIZONTAL

Vertical

	Freq	Level	Limit	Over	Read	CableAntenna	Preamp		A/Pos	T/Pos	PoI/Phase	
	MHz	dBuV/m	dBuV/m	dB	dBuV	Loss	Factor	Factor	Remark	cm	deg	
1	4823.92	49.82	74.00	-24.18	48.48	3.31	33.06	35.03	Peak	104	273	VERTICAL
2	4823.95	45.87	54.00	-8.13	44.53	3.31	33.06	35.03	Average	104	273	VERTICAL

Temperature	25.6°C	Humidity	56%
Test Engineer	Denis Su	Configurations	IEEE 802.11b CH 6 / Chain 1 / Mode 1
Test Date	Feb. 23, 2013		

Horizontal

	Freq	Level	Limit	Over	Read	CableAntenna	Preamp	Remark	A/Pos	T/Pos	PoI/Phase
	MHz	dBuV/m	dBuV/m	dB	dBuV	dB	dB/m	dB	cm	deg	
1	4873.90	48.91	74.00	-25.09	47.45	3.33	33.16	35.03	Peak	100	121 HORIZONTAL
2	4873.98	44.33	54.00	-9.67	42.87	3.33	33.16	35.03	Average	100	121 HORIZONTAL
3	7310.12	47.51	74.00	-26.49	42.89	4.06	35.96	35.40	Peak	100	209 HORIZONTAL
4	7310.18	35.86	54.00	-18.14	31.24	4.06	35.96	35.40	Average	100	209 HORIZONTAL

Vertical

	Freq	Level	Limit	Over	Read	CableAntenna	Preamp	Remark	A/Pos	T/Pos	PoI/Phase
	MHz	dBuV/m	dBuV/m	dB	dBuV	dB	dB/m	dB	cm	deg	
1	4873.97	50.46	74.00	-23.54	49.00	3.33	33.16	35.03	Peak	100	164 VERTICAL
2	4873.99	46.25	54.00	-7.75	44.79	3.33	33.16	35.03	Average	100	164 VERTICAL
3	7312.03	50.06	74.00	-23.94	45.44	4.06	35.96	35.40	Peak	100	321 VERTICAL
4	7312.76	41.57	54.00	-12.43	36.95	4.06	35.96	35.40	Average	100	321 VERTICAL

Temperature	25.6°C	Humidity	56%
Test Engineer	Denis Su	Configurations	IEEE 802.11b CH 11 / Chain 1 / Mode 1
Test Date	Feb. 23, 2013		

Horizontal

	Freq	Level	Limit Line	Over Limit	Read Level	CableAntenna Loss	Antenna Factor	Preamp Factor	Remark	A/Pos	T/Pos	Pol/Phase
	MHz	dBuV/m	dBuV/m	dB	dBuV	dB	dB/m	dB		cm	deg	
1	4924.00	43.44	54.00	-10.56	41.84	3.35	33.26	35.01	Average	100	331	HORIZONTAL
2	4924.06	48.12	74.00	-25.88	46.52	3.35	33.26	35.01	Peak	100	331	HORIZONTAL
3	7386.76	37.16	54.00	-16.84	32.41	4.06	36.09	35.40	Average	100	112	HORIZONTAL
4	7387.07	49.04	74.00	-24.96	44.29	4.06	36.09	35.40	Peak	100	112	HORIZONTAL

Vertical

	Freq	Level	Limit Line	Over Limit	Read Level	CableAntenna Loss	Antenna Factor	Preamp Factor	Remark	A/Pos	T/Pos	Pol/Phase
	MHz	dBuV/m	dBuV/m	dB	dBuV	dB	dB/m	dB		cm	deg	
1	4923.84	49.42	74.00	-24.58	47.82	3.35	33.26	35.01	Peak	115	272	VERTICAL
2	4923.99	45.71	54.00	-8.29	44.11	3.35	33.26	35.01	Average	115	272	VERTICAL
3	7385.25	44.09	54.00	-9.91	39.34	4.06	36.09	35.40	Average	150	323	VERTICAL
4	7385.46	52.05	74.00	-21.95	47.30	4.06	36.09	35.40	Peak	150	323	VERTICAL

Temperature	25.6°C	Humidity	56%
Test Engineer	Denis Su	Configurations	IEEE 802.11g CH 1 / Chain 1 / Mode 1
Test Date	Feb. 23, 2013		

Horizontal

	Freq	Level	Limit Line	Over Limit	Read Level	Cable Loss	Antenna Factor	Preamp Factor	Remark	A/Pos	T/Pos	Pol/Phase
	MHz	dBuV/m	dBuV/m	dB	dBuV	dB	dB/m	dB		cm	deg	
1	4823.96	33.35	54.00	-20.65	32.01	3.31	33.06	35.03	Average	101	34	HORIZONTAL
2	4824.62	41.09	74.00	-32.91	39.75	3.31	33.06	35.03	Peak	101	34	HORIZONTAL

Vertical

	Freq	Level	Limit Line	Over Limit	Read Level	Cable Loss	Antenna Factor	Preamp Factor	Remark	A/Pos	T/Pos	Pol/Phase
	MHz	dBuV/m	dBuV/m	dB	dBuV	dB	dB/m	dB		cm	deg	
1	4823.98	35.11	54.00	-18.89	33.77	3.31	33.06	35.03	Average	109	259	VERTICAL
2	4824.41	43.12	74.00	-30.88	41.78	3.31	33.06	35.03	Peak	109	259	VERTICAL

Temperature	25.6°C	Humidity	56%
Test Engineer	Denis Su	Configurations	IEEE 802.11g CH 6 / Chain 1 / Mode 1
Test Date	Feb. 23, 2013		

Horizontal

	Freq	Level	Limit Line	Over Limit	Read Level	CableAntenna Loss	Antenna Factor	Preamp Factor	Remark	A/Pos	T/Pos	Pol/Phase
	MHz	dBuV/m	dBuV/m	dB	dBuV	dB	dB/m	dB		cm	deg	
1	4873.07	47.48	74.00	-26.52	46.02	3.33	33.16	35.03	Peak	124	296	HORIZONTAL
2	4873.91	34.75	54.00	-19.25	33.29	3.33	33.16	35.03	Average	124	296	HORIZONTAL
3	7310.09	35.21	54.00	-18.79	30.59	4.06	35.96	35.40	Average	100	89	HORIZONTAL
4	7312.57	48.52	74.00	-25.48	43.90	4.06	35.96	35.40	Peak	100	89	HORIZONTAL

Vertical

	Freq	Level	Limit Line	Over Limit	Read Level	CableAntenna Loss	Antenna Factor	Preamp Factor	Remark	A/Pos	T/Pos	Pol/Phase
	MHz	dBuV/m	dBuV/m	dB	dBuV	dB	dB/m	dB		cm	deg	
1	4873.53	47.92	74.00	-26.08	46.46	3.33	33.16	35.03	Peak	124	94	VERTICAL
2	4873.98	35.83	54.00	-18.17	34.37	3.33	33.16	35.03	Average	124	94	VERTICAL
3	7310.18	39.31	54.00	-14.69	34.69	4.06	35.96	35.40	Average	100	63	VERTICAL
4	7311.42	53.70	74.00	-20.30	49.08	4.06	35.96	35.40	Peak	100	63	VERTICAL

Temperature	25.6°C	Humidity	56%
Test Engineer	Denis Su	Configurations	IEEE 802.11g CH 11 / Chain 1 / Mode 1
Test Date	Feb. 23, 2013		

Horizontal

	Freq	Level	Limit Line	Over Limit	Read Level	CableAntenna Loss	Antenna Factor	Preamp Factor	Remark	A/Pos	T/Pos	Pol/Phase
	MHz	dBuV/m	dBuV/m	dB	dBuV	dB	dB/m	dB		cm	deg	
1	4923.66	47.20	74.00	-26.80	45.60	3.35	33.26	35.01	Peak	101	298	HORIZONTAL
2	4923.97	36.94	54.00	-17.06	35.34	3.35	33.26	35.01	Average	101	298	HORIZONTAL
3	7384.21	34.88	54.00	-19.12	30.13	4.06	36.09	35.40	Average	101	332	HORIZONTAL
4	7388.40	48.25	74.00	-25.75	43.50	4.06	36.09	35.40	Peak	101	332	HORIZONTAL

Vertical

	Freq	Level	Limit Line	Over Limit	Read Level	CableAntenna Loss	Antenna Factor	Preamp Factor	Remark	A/Pos	T/Pos	Pol/Phase
	MHz	dBuV/m	dBuV/m	dB	dBuV	dB	dB/m	dB		cm	deg	
1	4923.94	47.63	74.00	-26.37	46.03	3.35	33.26	35.01	Peak	123	92	VERTICAL
2	4924.07	37.26	54.00	-16.74	35.66	3.35	33.26	35.01	Average	123	92	VERTICAL
3	7383.91	36.91	54.00	-17.09	32.16	4.06	36.09	35.40	Average	101	76	VERTICAL
4	7385.57	52.65	74.00	-21.35	47.90	4.06	36.09	35.40	Peak	101	76	VERTICAL

Note:

The amplitude of spurious emissions that are attenuated by more than 20dB below the permissible value has no need to be reported.

Emission level (dBuV/m) = 20 log Emission level (uV/m).

Corrected Reading: Antenna Factor + Cable Loss + Read Level - Preamp Factor = Level.



Temperature	25.6°C	Humidity	56%
Test Engineer	Kenneth Huang	Configurations	IEEE 802.11n MCS0 20MHz Ch 1 / Chain 1 / Mode 5
Test Date	Mar. 15, 2013		

Horizontal

	Freq	Level	Limit	Over	Read	CableAntenna	Preamp	Remark	A/Pos	T/Pos	Pol/Phase
	MHz	dBuV/m	dBuV/m	dB	dBuV	dB	dB/m	dB	cm	deg	
1	4823.98	29.78	54.00	-24.22	28.44	3.31	33.06	35.03	100	343	HORIZONTAL
2	4825.46	43.65	74.00	-30.35	42.31	3.31	33.06	35.03	100	343	HORIZONTAL

Vertical

	Freq	Level	Limit	Over	Read	CableAntenna	Preamp	Remark	A/Pos	T/Pos	Pol/Phase
	MHz	dBuV/m	dBuV/m	dB	dBuV	dB	dB/m	dB	cm	deg	
1	4823.98	37.55	54.00	-16.45	36.21	3.31	33.06	35.03	100	94	VERTICAL
2	4824.00	45.90	74.00	-28.10	44.56	3.31	33.06	35.03	100	94	VERTICAL

Temperature	25.6°C	Humidity	56%
Test Engineer	Kenneth Huang	Configurations	IEEE 802.11n MCS0 20MHz Ch 6 / Chain 1 / Mode 5
Test Date	Mar. 15, 2013		

Horizontal

	Freq	Level	Limit	Over	Read	CableAntenna	Preamp	Remark	A/Pos	T/Pos	PoI/Phase
	MHz	dBuV/m	dBuV/m	dB	dBuV	dB	dB/m	dB	cm	deg	
1	4873.90	30.20	54.00	-23.80	28.74	3.33	33.16	35.03	100	140	HORIZONTAL
2	4876.44	42.74	74.00	-31.26	41.28	3.33	33.16	35.03	100	140	HORIZONTAL
3	7311.60	46.27	74.00	-27.73	41.65	4.06	35.96	35.40	100	321	HORIZONTAL
4	7311.70	32.78	54.00	-21.22	28.16	4.06	35.96	35.40	100	321	HORIZONTAL

Vertical

	Freq	Level	Limit	Over	Read	CableAntenna	Preamp	Remark	A/Pos	T/Pos	PoI/Phase
	MHz	dBuV/m	dBuV/m	dB	dBuV	dB	dB/m	dB	cm	deg	
1	4873.88	47.09	74.00	-26.91	45.63	3.33	33.16	35.03	100	93	VERTICAL
2	4873.97	38.78	54.00	-15.22	37.32	3.33	33.16	35.03	100	93	VERTICAL
3	7311.70	47.52	74.00	-26.48	42.90	4.06	35.96	35.40	100	274	VERTICAL
4	7311.77	33.07	54.00	-20.93	28.45	4.06	35.96	35.40	100	274	VERTICAL

Temperature	25.6°C	Humidity	56%
Test Engineer	Kenneth Huang	Configurations	IEEE 802.11n MCS0 20MHz Ch11 / Chain 1 / Mode 5
Test Date	Mar. 15, 2013		

Horizontal

	Freq	Level	Limit Line	Over Limit	Read Level	CableAntenna Loss	Antenna Factor	Preamp Factor	Remark	A/Pos	T/Pos	Pol/Phase
	MHz	dBuV/m	dBuV/m	dB	dBuV	dB	dB/m	dB		cm	deg	
1	4924.01	30.99	54.00	-23.01	29.39	3.35	33.26	35.01	Average	100	138	HORIZONTAL
2	4925.88	43.03	74.00	-30.97	41.43	3.35	33.26	35.01	Peak	100	138	HORIZONTAL
3	7387.55	32.78	54.00	-21.22	28.03	4.06	36.09	35.40	Average	100	191	HORIZONTAL
4	7387.94	45.88	74.00	-28.12	41.13	4.06	36.09	35.40	Peak	100	191	HORIZONTAL

Vertical

	Freq	Level	Limit Line	Over Limit	Read Level	CableAntenna Loss	Antenna Factor	Preamp Factor	Remark	A/Pos	T/Pos	Pol/Phase
	MHz	dBuV/m	dBuV/m	dB	dBuV	dB	dB/m	dB		cm	deg	
1	4924.01	39.44	54.00	-14.56	37.84	3.35	33.26	35.01	Average	100	21	VERTICAL
2	4924.05	46.04	74.00	-27.96	44.44	3.35	33.26	35.01	Peak	100	21	VERTICAL
3	7384.00	32.82	54.00	-21.18	28.07	4.06	36.09	35.40	Average	100	327	VERTICAL
4	7388.08	45.81	74.00	-28.19	41.06	4.06	36.09	35.40	Peak	100	327	VERTICAL

Temperature	25.6°C	Humidity	56%
Test Engineer	Kenneth Huang	Configurations	IEEE 802.11n MCS0 40MHz Ch 3 / Chain 1 / Mode 5
Test Date	Mar. 15, 2013		

Horizontal

	Freq	Level	Limit	Over	Read	Cable	Antenna	Preamp	Remark	A/Pos	T/Pos	Pol/Phase
	MHz	dBuV/m	dBuV/m	dB	dBuV	dB	dB/m	dB		cm	deg	
1	4844.04	29.20	54.00	-24.80	27.82	3.32	33.09	35.03	Average	100	172	HORIZONTAL
2	4845.91	42.26	74.00	-31.74	40.88	3.32	33.09	35.03	Peak	100	172	HORIZONTAL

Vertical

	Freq	Level	Limit	Over	Read	Cable	Antenna	Preamp	Remark	A/Pos	T/Pos	Pol/Phase
	MHz	dBuV/m	dBuV/m	dB	dBuV	dB	dB/m	dB		cm	deg	
1	4843.99	38.03	54.00	-15.97	36.65	3.32	33.09	35.03	Average	100	93	VERTICAL
2	4844.02	45.80	74.00	-28.20	44.42	3.32	33.09	35.03	Peak	100	93	VERTICAL

Temperature	25.6°C	Humidity	56%
Test Engineer	Kenneth Huang	Configurations	IEEE 802.11n MCS0 40MHz Ch 6 / Chain 1 / Mode 5
Test Date	Mar. 15, 2013		

Horizontal

	Freq	Level	Limit	Over	Read	Cable	Preamp	Antenna	Remark	T/Pos	A/Pos	Pol/Phase
	MHz	dBuV/m	dBuV/m	dB	dBuV	dB	dB	dB/m		deg	cm	
1 a	4873.95	32.18	54.00	-21.82	29.97	4.22	34.67	32.66	Average	141	100	HORIZONTAL
2 p	4874.04	44.46	74.00	-29.54	42.25	4.22	34.67	32.66	Peak	141	100	HORIZONTAL

Vertical

	Freq	Level	Limit	Over	Read	Cable	Preamp	Antenna	Remark	T/Pos	A/Pos	Pol/Phase
	MHz	dBuV/m	dBuV/m	dB	dBuV	dB	dB	dB/m		deg	cm	
1 a	4873.97	39.03	54.00	-14.97	36.82	4.22	34.67	32.66	Average	195	100	VERTICAL
2 p	4874.09	49.03	74.00	-24.97	46.82	4.22	34.67	32.66	Peak	195	100	VERTICAL

Temperature	25.6°C	Humidity	56%
Test Engineer	Kenneth Huang	Configurations	IEEE 802.11n MCS0 40MHz Ch 9 / Chain 1 / Mode 5
Test Date	Mar. 15, 2013		

Horizontal

	Freq	Level	Limit Line	Over Limit	Read Level	CableAntenna Loss	Antenna Factor	Preamp Factor	Remark	A/Pos	T/Pos	PoI/Phase
	MHz	dBuV/m	dBuV/m	dB	dBuV	dB	dB/m	dB		cm	deg	
1	4903.85	29.89	54.00	-24.11	28.38	3.34	33.19	35.02	Average	100	170	HORIZONTAL
2	4904.06	42.90	74.00	-31.10	41.39	3.34	33.19	35.02	Peak	100	170	HORIZONTAL
3	7353.74	32.91	54.00	-21.09	28.23	4.06	36.02	35.40	Average	100	303	HORIZONTAL
4	7354.85	46.46	74.00	-27.54	41.78	4.06	36.02	35.40	Peak	100	303	HORIZONTAL

Vertical

	Freq	Level	Limit Line	Over Limit	Read Level	CableAntenna Loss	Antenna Factor	Preamp Factor	Remark	A/Pos	T/Pos	PoI/Phase
	MHz	dBuV/m	dBuV/m	dB	dBuV	dB	dB/m	dB		cm	deg	
1	4903.97	39.09	54.00	-14.91	37.58	3.34	33.19	35.02	Average	100	93	VERTICAL
2	4903.98	46.25	74.00	-27.75	44.74	3.34	33.19	35.02	Peak	100	93	VERTICAL
3	7356.35	46.00	74.00	-28.00	41.32	4.06	36.02	35.40	Peak	100	296	VERTICAL
4	7358.10	32.94	54.00	-21.06	28.26	4.06	36.02	35.40	Average	100	296	VERTICAL

Note:

The amplitude of spurious emissions which are attenuated by more than 20 dB below the permissible value has no need to be reported.

Emission level (dBuV/m) = 20 log Emission level (uV/m).

Corrected Reading: Antenna Factor + Cable Loss + Read Level - Preamp Factor = Level.

Temperature	25.6°C	Humidity	56%
Test Engineer	Kenneth Huang	Configurations	IEEE 802.11b CH 1 / Chain 1 / Mode 5
Test Date	Mar. 15, 2013		

Horizontal

	Freq	Level	Limit Line	Over Limit	Read Level	CableAntenna Loss	Antenna Factor	Preamp Factor	Remark	A/Pos	T/Pos	Pol/Phase
	MHz	dBuV/m	dBuV/m	dB	dBuV	dB	dB/m	dB		cm	deg	
1	4823.94	38.24	54.00	-15.76	36.90	3.31	33.06	35.03	Average	145	161	HORIZONTAL
2	4824.03	47.13	74.00	-26.87	45.79	3.31	33.06	35.03	Peak	145	161	HORIZONTAL

Vertical

	Freq	Level	Limit Line	Over Limit	Read Level	CableAntenna Loss	Antenna Factor	Preamp Factor	Remark	A/Pos	T/Pos	Pol/Phase
	MHz	dBuV/m	dBuV/m	dB	dBuV	dB	dB/m	dB		cm	deg	
1	4824.00	45.69	54.00	-8.31	44.35	3.31	33.06	35.03	Average	100	94	VERTICAL
2	4824.04	50.63	74.00	-23.37	49.29	3.31	33.06	35.03	Peak	100	94	VERTICAL

Temperature	25.6°C	Humidity	56%
Test Engineer	Kenneth Huang	Configurations	IEEE 802.11b CH 6 / Chain 1 / Mode 5
Test Date	Mar. 15, 2013		

Horizontal

	Freq	Level	Limit	Over	Read	CableAntenna	Preamp	Remark	A/Pos	T/Pos	PoI/Phase
	MHz	dBuV/m	dBuV/m	dB	dBuV	dB	dB/m	dB	cm	deg	
1	4873.73	46.80	74.00	-27.20	45.34	3.33	33.16	35.03	Peak	145	144 HORIZONTAL
2	4874.02	38.48	54.00	-15.52	37.02	3.33	33.16	35.03	Average	145	144 HORIZONTAL
3	7309.64	45.96	74.00	-28.04	41.34	4.06	35.96	35.40	Peak	101	305 HORIZONTAL
4	7311.82	31.89	54.00	-22.11	27.27	4.06	35.96	35.40	Average	101	305 HORIZONTAL

Vertical

	Freq	Level	Limit	Over	Read	CableAntenna	Preamp	Remark	A/Pos	T/Pos	PoI/Phase
	MHz	dBuV/m	dBuV/m	dB	dBuV	dB	dB/m	dB	cm	deg	
1	4874.00	48.00	54.00	-6.00	46.54	3.33	33.16	35.03	Average	117	328 VERTICAL
2	4874.01	51.75	74.00	-22.25	50.29	3.33	33.16	35.03	Peak	117	328 VERTICAL
3	7309.44	50.12	74.00	-23.88	45.50	4.06	35.96	35.40	Peak	106	24 VERTICAL
4	7309.74	37.11	54.00	-16.89	32.49	4.06	35.96	35.40	Average	106	24 VERTICAL

Temperature	25.6°C	Humidity	56%
Test Engineer	Kenneth Huang	Configurations	IEEE 802.11b CH 11 / Chain 1 / Mode 5
Test Date	Mar. 15, 2013		

Horizontal

	Freq	Level	Limit Line	Over Limit	Read Level	CableAntenna Loss	Antenna Factor	Preamp Factor	Remark	A/Pos	T/Pos	Pol/Phase
	MHz	dBuV/m	dBuV/m	dB	dBuV	dB	dB/m	dB		cm	deg	
1	4923.92	41.35	54.00	-12.65	39.75	3.35	33.26	35.01	Average	146	143	HORIZONTAL
2	4924.09	48.53	74.00	-25.47	46.93	3.35	33.26	35.01	Peak	146	143	HORIZONTAL
3	7387.04	33.84	54.00	-20.16	29.09	4.06	36.09	35.40	Average	100	298	HORIZONTAL
4	7388.08	48.06	74.00	-25.94	43.31	4.06	36.09	35.40	Peak	100	298	HORIZONTAL

Vertical

	Freq	Level	Limit Line	Over Limit	Read Level	CableAntenna Loss	Antenna Factor	Preamp Factor	Remark	A/Pos	T/Pos	Pol/Phase
	MHz	dBuV/m	dBuV/m	dB	dBuV	dB	dB/m	dB		cm	deg	
1	4923.98	49.11	54.00	-4.89	47.51	3.35	33.26	35.01	Average	100	329	VERTICAL
2	4923.99	52.88	74.00	-21.12	51.28	3.35	33.26	35.01	Peak	100	329	VERTICAL
3	7386.68	37.42	54.00	-16.58	32.67	4.06	36.09	35.40	Average	122	25	VERTICAL
4	7387.31	49.86	74.00	-24.14	45.11	4.06	36.09	35.40	Peak	122	25	VERTICAL

Temperature	25.6°C	Humidity	56%
Test Engineer	Kenneth Huang	Configurations	IEEE 802.11g CH 1 / Chain 1 / Mode 5
Test Date	F Mar. 15, 2013		

Horizontal

	Freq	Level	Limit	Over	Read	CableAntenna	Preamp	Remark	A/Pos	T/Pos	Pol/Phase
	MHz	dBuV/m	dBuV/m	dB	dBuV	dB	dB/m	dB	cm	deg	
1	4823.63	42.71	74.00	-31.29	41.37	3.31	33.06	35.03	Peak	100	240 HORIZONTAL
2	4824.14	29.57	54.00	-24.43	28.23	3.31	33.06	35.03	Average	100	240 HORIZONTAL

Vertical

	Freq	Level	Limit	Over	Read	CableAntenna	Preamp	Remark	A/Pos	T/Pos	Pol/Phase
	MHz	dBuV/m	dBuV/m	dB	dBuV	dB	dB/m	dB	cm	deg	
1	4824.02	37.56	54.00	-16.44	36.22	3.31	33.06	35.03	Average	111	95 VERTICAL
2	4824.08	45.50	74.00	-28.50	44.16	3.31	33.06	35.03	Peak	111	95 VERTICAL

Temperature	25.6°C	Humidity	56%
Test Engineer	Kenneth Huang	Configurations	IEEE 802.11g CH 6 / Chain 1 / Mode 5
Test Date	Mar. 15, 2013		

Horizontal

	Freq	Level	Limit	Over	Read	CableAntenna	Preamp	Remark	A/Pos	T/Pos	Pol/Phase
	MHz	dBuV/m	dBuV/m	dB	dBuV	dB	dB/m	dB	cm	deg	
1	4874.06	30.03	54.00	-23.97	28.57	3.33	33.16	35.03	Average	100	119 HORIZONTAL
2	4874.18	42.53	74.00	-31.47	41.07	3.33	33.16	35.03	Peak	100	119 HORIZONTAL
3	7309.73	46.03	74.00	-27.97	41.41	4.06	35.96	35.40	Peak	100	180 HORIZONTAL
4	7312.81	32.69	54.00	-21.31	28.07	4.06	35.96	35.40	Average	100	180 HORIZONTAL

Vertical

	Freq	Level	Limit	Over	Read	CableAntenna	Preamp	Remark	A/Pos	T/Pos	Pol/Phase
	MHz	dBuV/m	dBuV/m	dB	dBuV	dB	dB/m	dB	cm	deg	
1	4874.04	36.26	54.00	-17.74	34.80	3.33	33.16	35.03	Average	100	214 VERTICAL
2	4874.10	45.70	74.00	-28.30	44.24	3.33	33.16	35.03	Peak	100	214 VERTICAL
3	7310.44	33.29	54.00	-20.71	28.67	4.06	35.96	35.40	Average	100	311 VERTICAL
4	7312.08	46.60	74.00	-27.40	41.98	4.06	35.96	35.40	Peak	100	311 VERTICAL

Temperature	25.6°C	Humidity	56%
Test Engineer	Kenneth Huang	Configurations	IEEE 802.11g CH 11 / Chain 1 / Mode 5
Test Date	Mar. 15, 2013		

Horizontal

	Freq	Level	Limit Line	Over Limit	Read Level	Cable Loss	Antenna Factor	Preamp Factor	Remark	A/Pos	T/Pos	PoI/Phase
	MHz	dBuV/m	dBuV/m	dB	dBuV	dB	dB/m	dB		cm	deg	
1	4923.97	30.57	54.00	-23.43	28.97	3.35	33.26	35.01	Average	100	162	HORIZONTAL
2	4925.45	42.98	74.00	-31.02	41.38	3.35	33.26	35.01	Peak	100	162	HORIZONTAL
3	7384.97	45.79	74.00	-28.21	41.04	4.06	36.09	35.40	Peak	100	63	HORIZONTAL
4	7386.38	32.76	54.00	-21.24	28.01	4.06	36.09	35.40	Average	100	63	HORIZONTAL

Vertical

	Freq	Level	Limit Line	Over Limit	Read Level	Cable Loss	Antenna Factor	Preamp Factor	Remark	A/Pos	T/Pos	PoI/Phase
	MHz	dBuV/m	dBuV/m	dB	dBuV	dB	dB/m	dB		cm	deg	
1	4923.99	39.31	54.00	-14.69	37.71	3.35	33.26	35.01	Average	100	328	VERTICAL
2	4923.99	48.38	74.00	-25.62	46.78	3.35	33.26	35.01	Peak	100	328	VERTICAL
3	7383.60	45.70	74.00	-28.30	40.95	4.06	36.09	35.40	Peak	100	301	VERTICAL
4	7385.33	32.89	54.00	-21.11	28.14	4.06	36.09	35.40	Average	100	301	VERTICAL

Note:

The amplitude of spurious emissions that are attenuated by more than 20dB below the permissible value has no need to be reported.

Emission level (dBuV/m) = 20 log Emission level (uV/m).

Corrected Reading: Antenna Factor + Cable Loss + Read Level - Preamp Factor = Level.

4.6. Emissions Measurement

4.6.1. Limit

30dBc in any 100 kHz bandwidth outside the operating frequency band. In case the emission fall within the restricted band specified on 15.205(a), then the 15.209(a) limit in the table below has to be followed.

Frequencies (MHz)	Field Strength (micorvolts/meter)	Measurement Distance (meters)
0.009~0.490	2400/F(KHz)	300
0.490~1.705	24000/F(KHz)	30
1.705~30.0	30	30
30~88	100	3
88~216	150	3
216~960	200	3
Above 960	500	3

4.6.2. Measuring Instruments and Setting

Please refer to section 5 of equipments list in this report. The following table is the setting of the spectrum analyzer.

Spectrum Parameter	Setting
Attenuation	Auto
Span Frequency	100 MHz
RB / VB (Emission in restricted band)	1 MHz / 3MHz for Peak, 1 MHz / 10Hz for Average
RB / VB (Emission in non-restricted band)	100 kHz / 300 kHz for Peak

4.6.3. Test Procedures

For Radiated band edges Measurement:

1. The test procedure is the same as section 4.5.3, only the frequency range investigated is limited to 100MHz around band edges.

For Conducted Out of Band Emission Measurement:

1. Test was performed in accordance with KDB 558074 v02 Guidance for Performing Compliance Measurements on Digital Transmission Systems (DTS) Operating Under §15.247 section 10.1 Unwanted Emissions into Non-Restricted Frequency Bands Measurement Procedure
2. The conducted emission test is performed on each TX port of operating mode without summing or adding $10\log(N)$ since the limit is relative emission limit. Only worst data of each operating mode is presented.

4.6.4. Test Setup Layout

For Radiated band edges Measurement:

This test setup layout is the same as that shown in section 4.5.4.

For Conducted Out of Band Emission Measurement:

This test setup layout is the same as that shown in section 4.4.4.

4.6.5. Test Deviation

There is no deviation with the original standard.

4.6.6. Test Result of Band Edge and Fundamental Emissions

Temperature	25.6°C	Humidity	56%
Test Engineer	Denis Su	Configurations	IEEE 802.11n MCS0 20MHz Ch 1, 6, 11 / Chain 1 / Mode 1
Test Date	Feb. 23, 2013		

Channel 1

	Freq	Level	Limit Line	Over Limit	Read Level	CableAntenna Loss	Antenna Factor	Preamp Factor	Remark	A/Pos	T/Pos	PoI/Phase
	MHz	dBuV/m	dBuV/m	dB	dBuV	dB	dB/m	dB		cm	deg	
1	2389.84	70.02	74.00	-3.98	39.63	2.22	28.17	0.00	Peak	154	151	HORIZONTAL
2	2390.00	49.07	54.00	-4.93	18.68	2.22	28.17	0.00	Average	154	151	HORIZONTAL
3	2409.76	97.66			67.23	2.22	28.21	0.00	Average	154	151	HORIZONTAL
4	2409.76	107.65			77.22	2.22	28.21	0.00	Peak	154	151	HORIZONTAL

Item 3, 4 are the fundamental frequency at 2412 MHz.

Channel 6

	Freq	Level	Limit Line	Over Limit	Read Level	CableAntenna Loss	Antenna Factor	Preamp Factor	Remark	A/Pos	T/Pos	PoI/Phase
	MHz	dBuV/m	dBuV/m	dB	dBuV	dB	dB/m	dB		cm	deg	
1	2388.72	58.48	74.00	-15.52	28.10	2.21	28.17	0.00	Peak	180	156	HORIZONTAL
2	2390.00	45.81	54.00	-8.19	15.42	2.22	28.17	0.00	Average	180	156	HORIZONTAL
3	2431.71	100.32			69.84	2.23	28.25	0.00	Average	180	156	HORIZONTAL
4	2433.96	110.42			79.94	2.23	28.25	0.00	Peak	180	156	HORIZONTAL
5	2483.50	46.34	54.00	-7.66	15.70	2.26	28.38	0.00	Average	180	156	HORIZONTAL
6	2485.58	59.46	74.00	-14.54	28.78	2.26	28.42	0.00	Peak	180	156	HORIZONTAL

Item 3, 4 are the fundamental frequency at 2437MHz.

Channel 11

	Freq	Level	Limit Line	Over Limit	Read Level	CableAntenna Loss	Antenna Factor	Preamp Factor	Remark	A/Pos	T/Pos	PoI/Phase
	MHz	dBuV/m	dBuV/m	dB	dBuV	dB	dB/m	dB		cm	deg	
1	2458.96	106.13			75.56	2.24	28.33	0.00	Peak	183	163	HORIZONTAL
2	2465.05	95.71			65.14	2.24	28.33	0.00	Average	183	163	HORIZONTAL
3	2483.50	47.14	54.00	-6.86	16.50	2.26	28.38	0.00	Average	183	163	HORIZONTAL
4	2483.98	61.56	74.00	-12.44	30.92	2.26	28.38	0.00	Peak	183	163	HORIZONTAL

Item 1, 2 are the fundamental frequency at 2462 MHz.

Temperature	25.6°C	Humidity	56%
Test Engineer	Denis Su	Configurations	IEEE 802.11n MCS0 40MHz Ch 3, 6, 9 / Chain 1 / Mode 1
Test Date	Feb. 23, 2013		

Channel 3

	Freq	Level	Limit Line	Over Limit	Read Level	Cable Loss	Antenna Factor	Preamp Factor	Remark	A/Pos	T/Pos	Pol/Phase
	MHz	dBuV/m	dBuV/m	dB	dBuV	dB	dB/m	dB		cm	deg	
1	2385.83	68.42	74.00	-5.58	38.04	2.21	28.17	0.00	Peak	184	157	HORIZONTAL
2	2390.00	50.35	54.00	-3.65	19.96	2.22	28.17	0.00	Average	184	157	HORIZONTAL
3	2431.30	95.29			64.81	2.23	28.25	0.00	Average	184	157	HORIZONTAL
4	2432.58	105.08			74.60	2.23	28.25	0.00	Peak	184	157	HORIZONTAL

Item 3, 4 are the fundamental frequency at 2422 MHz.

Channel 6

	Freq	Level	Limit Line	Over Limit	Read Level	Cable Loss	Preamp Factor	Antenna Factor	Remark	T/Pos	A/Pos	Pol/Phase
	MHz	dBuV/m	dBuV/m	dB	dBuV	dB	dB	dB/m		deg	cm	
1	2390.00	65.89	74.00	-8.11	35.11	2.91	0.00	27.87	Peak	261	151	HORIZONTAL
2 !	2390.00	52.30	54.00	-1.70	21.52	2.91	0.00	27.87	Average	261	151	HORIZONTAL
3 p	2428.20	107.75			77.01	2.93	0.00	27.81	Peak	261	151	HORIZONTAL
4 a	2428.60	98.24			67.50	2.93	0.00	27.81	Average	261	151	HORIZONTAL
5 !	2483.50	68.43	74.00	-5.57	37.74	2.96	0.00	27.73	Peak	261	151	HORIZONTAL
6 !	2483.50	53.57	54.00	-0.43	22.88	2.96	0.00	27.73	Average	261	151	HORIZONTAL

Item 3, 4 are the fundamental frequency at 2437MHz.

Channel 9

	Freq	Level	Limit Line	Over Limit	Read Level	Cable Loss	Antenna Factor	Preamp Factor	Remark	A/Pos	T/Pos	Pol/Phase
	MHz	dBuV/m	dBuV/m	dB	dBuV	dB	dB/m	dB		cm	deg	
1	2444.31	104.57			74.04	2.24	28.29	0.00	Peak	178	162	HORIZONTAL
2	2446.23	94.41			63.88	2.24	28.29	0.00	Average	178	162	HORIZONTAL
3	2484.14	50.96	54.00	-3.04	20.32	2.26	28.38	0.00	Average	178	162	HORIZONTAL
4	2484.78	67.04	74.00	-6.96	36.40	2.26	28.38	0.00	Peak	178	162	HORIZONTAL

Item 1, 2 are the fundamental frequency at 2452 MHz.

Note:

Emission level (dBuV/m) = 20 log Emission level (uV/m).

Corrected Reading: Antenna Factor + Cable Loss + Read Level - Preamp Factor = Level.

Temperature	25.6°C	Humidity	56%
Test Engineer	Denis Su	Configurations	IEEE 802.11b CH 1, 6, 11 / Mode 1
Test Date	Feb. 23, 2013		

Channel 1

	Freq	Level	Limit Line	Over Limit	Read Level	Cable Loss	Antenna Factor	Preamp Factor	Remark	A/Pos	T/Pos	Pol/Phase
	MHz	dBuV/m	dBuV/m	dB	dBuV	dB	dB/m	dB		cm	deg	
1	2385.83	58.33	74.00	-15.67	27.95	2.21	28.17	0.00	Peak	154	150	HORIZONTAL
2	2385.99	46.42	54.00	-7.58	16.04	2.21	28.17	0.00	Average	154	150	HORIZONTAL
3	2411.04	109.83			79.40	2.22	28.21	0.00	Peak	154	150	HORIZONTAL
4	2411.20	106.04			75.61	2.22	28.21	0.00	Average	154	150	HORIZONTAL

Item 3, 4 are the fundamental frequency at 2412 MHz.

Channel 6

	Freq	Level	Limit Line	Over Limit	Read Level	Cable Loss	Antenna Factor	Preamp Factor	Remark	A/Pos	T/Pos	Pol/Phase
	MHz	dBuV/m	dBuV/m	dB	dBuV	dB	dB/m	dB		cm	deg	
1	2388.56	57.24	74.00	-16.76	26.86	2.21	28.17	0.00	Peak	182	161	HORIZONTAL
2	2390.00	45.68	54.00	-8.32	15.29	2.22	28.17	0.00	Average	182	161	HORIZONTAL
3	2436.04	109.84			79.32	2.23	28.29	0.00	Peak	182	161	HORIZONTAL
4	2436.20	106.11			75.59	2.23	28.29	0.00	Average	182	161	HORIZONTAL
5	2483.50	45.89	54.00	-8.11	15.25	2.26	28.38	0.00	Average	182	161	HORIZONTAL
6	2486.06	56.96	74.00	-17.04	26.28	2.26	28.42	0.00	Peak	182	161	HORIZONTAL

Item 3, 4 are the fundamental frequency at 2437MHz.

Channel 11

	Freq	Level	Limit Line	Over Limit	Read Level	Cable Loss	Antenna Factor	Preamp Factor	Remark	A/Pos	T/Pos	Pol/Phase
	MHz	dBuV/m	dBuV/m	dB	dBuV	dB	dB/m	dB		cm	deg	
1	2461.20	105.11			74.54	2.24	28.33	0.00	Average	178	135	HORIZONTAL
2	2462.96	108.88			78.31	2.24	28.33	0.00	Peak	178	135	HORIZONTAL
3	2485.90	58.54	74.00	-15.46	27.86	2.26	28.42	0.00	Peak	178	135	HORIZONTAL
4	2487.83	47.28	54.00	-6.72	16.60	2.26	28.42	0.00	Average	178	135	HORIZONTAL

Item 1, 2 are the fundamental frequency at 2462 MHz.

Temperature	25.6°C	Humidity	56%
Test Engineer	Denis Su	Configurations	IEEE 802.11g CH 1, 6, 11 / Mode 1
Test Date	Feb. 23, 2013		

Channel 1

	Freq	Level	Limit Line	Over Limit	Read Level	Cable Loss	Antenna Factor	Preamp Factor	Remark	A/Pos	T/Pos	PoI/Phase
	MHz	dBuV/m	dBuV/m	dB	dBuV	dB	dB/m	dB		cm	deg	
1	2389.68	65.03	74.00	-8.97	34.65	2.21	28.17	0.00	Peak	155	150	HORIZONTAL
2	2390.00	49.53	54.00	-4.47	19.14	2.22	28.17	0.00	Average	155	150	HORIZONTAL
3	2409.44	98.94			68.51	2.22	28.21	0.00	Average	155	150	HORIZONTAL
4	2409.44	107.99			77.56	2.22	28.21	0.00	Peak	155	150	HORIZONTAL

Item 3, 4 are the fundamental frequency at 2412 MHz.

Channel 6

	Freq	Level	Limit Line	Over Limit	Read Level	Cable Loss	Antenna Factor	Preamp Factor	Remark	A/Pos	T/Pos	PoI/Phase
	MHz	dBuV/m	dBuV/m	dB	dBuV	dB	dB/m	dB		cm	deg	
1	2389.20	58.10	74.00	-15.90	27.72	2.21	28.17	0.00	Peak	183	154	HORIZONTAL
2	2390.00	45.80	54.00	-8.20	15.41	2.22	28.17	0.00	Average	183	154	HORIZONTAL
3	2432.35	100.87			70.39	2.23	28.25	0.00	Average	183	154	HORIZONTAL
4	2433.15	110.48			80.00	2.23	28.25	0.00	Peak	183	154	HORIZONTAL
5	2484.62	46.37	54.00	-7.63	15.73	2.26	28.38	0.00	Average	183	154	HORIZONTAL
6	2485.90	58.23	74.00	-15.77	27.55	2.26	28.42	0.00	Peak	183	154	HORIZONTAL

Item 3, 4 are the fundamental frequency at 2437 MHz.

Channel 11

	Freq	Level	Limit Line	Over Limit	Read Level	Cable Loss	Antenna Factor	Preamp Factor	Remark	A/Pos	T/Pos	PoI/Phase
	MHz	dBuV/m	dBuV/m	dB	dBuV	dB	dB/m	dB		cm	deg	
1	2463.44	107.35			76.78	2.24	28.33	0.00	Peak	179	134	HORIZONTAL
2	2464.08	97.81			67.24	2.24	28.33	0.00	Average	179	134	HORIZONTAL
3	2483.50	49.38	54.00	-4.62	18.75	2.26	28.37	0.00	Average	179	134	HORIZONTAL
4	2483.50	64.59	74.00	-9.41	33.96	2.26	28.37	0.00	Peak	179	134	HORIZONTAL

Item 1, 2 are the fundamental frequency at 2462 MHz.

Note:

Emission level (dBuV/m) = 20 log Emission level (uV/m).

Corrected Reading: Antenna Factor + Cable Loss + Read Level - Preamp Factor = Level.

Temperature	25.6°C	Humidity	56%
Test Engineer	Kenneth Huang	Configurations	IEEE 802.11n MCS0 20MHz Ch 1, 6, 11 / Chain 1 / Mode 5
Test Date	Mar. 15, 2013		

Channel 1

	Freq	Level	Limit Line	Over Limit	Read Level	CableAntenna Loss	Antenna Factor	Preamp Factor	Remark	A/Pos	T/Pos	PoI/Phase
	MHz	dBuV/m	dBuV/m	dB	dBuV	dB	dB/m	dB		cm	deg	
1	2389.52	58.19	74.00	-15.81	27.81	2.21	28.17	0.00	Peak	100	223	VERTICAL
2	2390.00	45.65	54.00	-8.35	15.26	2.22	28.17	0.00	Average	100	223	VERTICAL
3	2407.19	104.57			74.14	2.22	28.21	0.00	Peak	100	223	VERTICAL
4	2409.44	94.93			64.50	2.22	28.21	0.00	Average	100	223	VERTICAL

Item 3, 4 are the fundamental frequency at 2412 MHz.

Channel 6

	Freq	Level	Limit Line	Over Limit	Read Level	CableAntenna Loss	Antenna Factor	Preamp Factor	Remark	A/Pos	T/Pos	PoI/Phase
	MHz	dBuV/m	dBuV/m	dB	dBuV	dB	dB/m	dB		cm	deg	
1	2387.12	57.16	74.00	-16.84	26.78	2.21	28.17	0.00	Peak	100	224	VERTICAL
2	2390.00	45.23	54.00	-8.77	14.84	2.22	28.17	0.00	Average	100	224	VERTICAL
3	2428.67	96.03			65.55	2.23	28.25	0.00	Average	100	224	VERTICAL
4	2428.99	105.64			75.16	2.23	28.25	0.00	Peak	100	224	VERTICAL
5	2483.50	45.75	54.00	-8.25	15.12	2.26	28.37	0.00	Average	100	224	VERTICAL
6	2492.15	59.01	74.00	-14.99	28.33	2.27	28.41	0.00	Peak	100	224	VERTICAL

Item 3, 4 are the fundamental frequency at 2437MHz.

Channel 11

	Freq	Level	Limit Line	Over Limit	Read Level	CableAntenna Loss	Antenna Factor	Preamp Factor	Remark	A/Pos	T/Pos	PoI/Phase
	MHz	dBuV/m	dBuV/m	dB	dBuV	dB	dB/m	dB		cm	deg	
1	2453.83	93.09			62.52	2.24	28.33	0.00	Average	100	141	VERTICAL
2	2456.71	102.84			72.27	2.24	28.33	0.00	Peak	100	141	VERTICAL
3	2483.50	45.71	54.00	-8.29	15.08	2.26	28.37	0.00	Average	100	141	VERTICAL
4	2483.50	57.67	74.00	-16.33	27.04	2.26	28.37	0.00	Peak	100	141	VERTICAL

Item 1, 2 are the fundamental frequency at 2462 MHz.

Temperature	25.6°C	Humidity	56%
Test Engineer	Kenneth Huang	Configurations	IEEE 802.11n MCS0 40MHz Ch 3, 6, 9 / Chain 1 / Mode 5
Test Date	Mar. 15, 2013		

Channel 3

	Freq	Level	Limit Line	Over Limit	Read Level	Cable Loss	Antenna Factor	Preamp Factor	Remark	A/Pos	T/Pos	Pol/Phase
	MHz	dBuV/m	dBuV/m	dB	dBuV	dB	dB/m	dB		cm	deg	
1	2380.06	57.15	74.00	-16.85	26.81	2.21	28.13	0.00	Peak	100	223	VERTICAL
2	2390.00	45.80	54.00	-8.20	15.41	2.22	28.17	0.00	Average	100	223	VERTICAL
3	2411.74	100.71			70.28	2.22	28.21	0.00	Peak	100	223	VERTICAL
4	2425.21	91.46			60.98	2.23	28.25	0.00	Average	100	223	VERTICAL

Item 3, 4 are the fundamental frequency at 2422 MHz.

Channel 6

	Freq	Level	Limit Line	Over Limit	Read Level	Cable Loss	Preamp Factor	Antenna Factor	Remark	T/Pos	A/Pos	Pol/Phase
	MHz	dBuV/m	dBuV/m	dB	dBuV	dB	dB	dB/m		deg	cm	
1	2390.00	61.31	74.00	-12.69	30.53	2.91	0.00	27.87	Peak	148	100	VERTICAL
2	2390.00	47.34	54.00	-6.66	16.56	2.91	0.00	27.87	Average	148	100	VERTICAL
3 a	2427.40	94.88			64.14	2.93	0.00	27.81	Average	148	100	VERTICAL
4 p	2429.00	105.00			74.26	2.93	0.00	27.81	Peak	148	100	VERTICAL
5	2483.50	63.00	74.00	-11.00	32.31	2.96	0.00	27.73	Peak	148	100	VERTICAL
6 !	2483.50	48.79	54.00	-5.21	18.10	2.96	0.00	27.73	Average	148	100	VERTICAL

Item 3, 4 are the fundamental frequency at 2437MHz.

Channel 9

	Freq	Level	Limit Line	Over Limit	Read Level	Cable Loss	Antenna Factor	Preamp Factor	Remark	A/Pos	T/Pos	Pol/Phase
	MHz	dBuV/m	dBuV/m	dB	dBuV	dB	dB/m	dB		cm	deg	
1	2461.30	92.44			61.87	2.24	28.33	0.00	Average	117	223	VERTICAL
2	2466.10	101.29			70.72	2.24	28.33	0.00	Peak	117	223	VERTICAL
3	2483.50	46.58	54.00	-7.42	15.95	2.26	28.37	0.00	Average	117	223	VERTICAL
4	2483.50	57.33	74.00	-16.67	26.70	2.26	28.37	0.00	Peak	117	223	VERTICAL

Item 1, 2 are the fundamental frequency at 2452 MHz.

Note:

Emission level (dBuV/m) = 20 log Emission level (uV/m).

Corrected Reading: Antenna Factor + Cable Loss + Read Level - Preamp Factor = Level.

Temperature	25.6°C	Humidity	56%
Test Engineer	Kenneth Huang	Configurations	IEEE 802.11b CH 1, 6, 11 / Mode 5
Test Date	Mar. 15, 2013		

Channel 1

	Freq	Level	Limit Line	Over Limit	Read Level	Cable Loss	Antenna Factor	Preamp Factor	Remark	A/Pos	T/Pos	Pol/Phase
	MHz	dBuV/m	dBuV/m	dB	dBuV	dB	dB/m	dB		cm	deg	
1	2388.08	45.30	54.00	-8.70	14.92	2.21	28.17	0.00	Average	100	224	VERTICAL
2	2388.24	56.84	74.00	-17.16	26.46	2.21	28.17	0.00	Peak	100	224	VERTICAL
3	2411.04	106.99			76.56	2.22	28.21	0.00	Peak	100	224	VERTICAL
4	2411.20	103.27			72.84	2.22	28.21	0.00	Average	100	224	VERTICAL

Item 3, 4 are the fundamental frequency at 2412 MHz.

Channel 6

	Freq	Level	Limit Line	Over Limit	Read Level	Cable Loss	Antenna Factor	Preamp Factor	Remark	A/Pos	T/Pos	Pol/Phase
	MHz	dBuV/m	dBuV/m	dB	dBuV	dB	dB/m	dB		cm	deg	
1	2390.00	45.33	54.00	-8.67	14.94	2.22	28.17	0.00	Average	104	102	VERTICAL
2	2390.00	55.43	74.00	-18.57	25.04	2.22	28.17	0.00	Peak	104	102	VERTICAL
3	2436.04	106.37			75.85	2.23	28.29	0.00	Peak	104	102	VERTICAL
4	2436.36	102.68			72.16	2.23	28.29	0.00	Average	104	102	VERTICAL
5	2483.50	45.71	54.00	-8.29	15.08	2.26	28.37	0.00	Average	104	102	VERTICAL
6	2483.50	56.86	74.00	-17.14	26.23	2.26	28.37	0.00	Peak	104	102	VERTICAL

Item 3, 4 are the fundamental frequency at 2437MHz.

Channel 11

	Freq	Level	Limit Line	Over Limit	Read Level	Cable Loss	Antenna Factor	Preamp Factor	Remark	A/Pos	T/Pos	Pol/Phase
	MHz	dBuV/m	dBuV/m	dB	dBuV	dB	dB/m	dB		cm	deg	
1	2461.20	100.67			70.10	2.24	28.33	0.00	Average	101	98	VERTICAL
2	2462.96	104.38			73.81	2.24	28.33	0.00	Peak	101	98	VERTICAL
3	2483.50	57.50	74.00	-16.50	26.87	2.26	28.37	0.00	Peak	101	98	VERTICAL
4	2488.15	46.54	54.00	-7.46	15.87	2.26	28.41	0.00	Average	101	98	VERTICAL

Item 1, 2 are the fundamental frequency at 2462 MHz.

Temperature	25.6°C	Humidity	56%
Test Engineer	Kenneth Huang	Configurations	IEEE 802.11g CH 1, 6, 11 / Mode 5
Test Date	Mar. 15, 2013		

Channel 1

	Freq	Level	Limit Line	Over Limit	Read Level	Cable Loss	Antenna Factor	Preamp Factor	Remark	A/Pos	T/Pos	Pol/Phase
	MHz	dBuV/m	dBuV/m	dB	dBuV	dB	dB/m	dB		cm	deg	
1	2389.20	58.15	74.00	-15.85	27.77	2.21	28.17	0.00	Peak	100	223	VERTICAL
2	2390.00	45.51	54.00	-8.49	15.12	2.22	28.17	0.00	Average	100	223	VERTICAL
3	2407.99	105.16			74.73	2.22	28.21	0.00	Peak	100	223	VERTICAL
4	2409.44	95.89			65.46	2.22	28.21	0.00	Average	100	223	VERTICAL

Item 3, 4 are the fundamental frequency at 2412 MHz.

Channel 6

	Freq	Level	Limit Line	Over Limit	Read Level	Cable Loss	Antenna Factor	Preamp Factor	Remark	A/Pos	T/Pos	Pol/Phase
	MHz	dBuV/m	dBuV/m	dB	dBuV	dB	dB/m	dB		cm	deg	
1	2388.72	56.90	74.00	-17.10	26.52	2.21	28.17	0.00	Peak	100	225	VERTICAL
2	2390.00	45.19	54.00	-8.81	14.80	2.22	28.17	0.00	Average	100	225	VERTICAL
3	2429.63	96.35			65.87	2.23	28.25	0.00	Average	100	225	VERTICAL
4	2430.59	106.03			75.55	2.23	28.25	0.00	Peak	100	225	VERTICAL
5	2483.50	45.70	54.00	-8.30	15.07	2.26	28.37	0.00	Average	100	225	VERTICAL
6	2483.50	56.47	74.00	-17.53	25.84	2.26	28.37	0.00	Peak	100	225	VERTICAL

Item 3, 4 are the fundamental frequency at 2437 MHz.

Channel 11

	Freq	Level	Limit Line	Over Limit	Read Level	Cable Loss	Antenna Factor	Preamp Factor	Remark	A/Pos	T/Pos	Pol/Phase
	MHz	dBuV/m	dBuV/m	dB	dBuV	dB	dB/m	dB		cm	deg	
1	2454.79	94.59			64.02	2.24	28.33	0.00	Average	100	141	VERTICAL
2	2455.75	104.08			73.51	2.24	28.33	0.00	Peak	100	141	VERTICAL
3	2483.50	45.90	54.00	-8.10	15.27	2.26	28.37	0.00	Average	100	141	VERTICAL
4	2487.83	58.07	74.00	-15.93	27.40	2.26	28.41	0.00	Peak	100	141	VERTICAL

Item 1, 2 are the fundamental frequency at 2462 MHz.

Note:

Emission level (dBuV/m) = 20 log Emission level (uV/m).

Corrected Reading: Antenna Factor + Cable Loss + Read Level - Preamp Factor = Level.

For Emission not in Restricted Band

Plot on Configuration IEEE 802.11n MCS0 20MHz / Reference Level

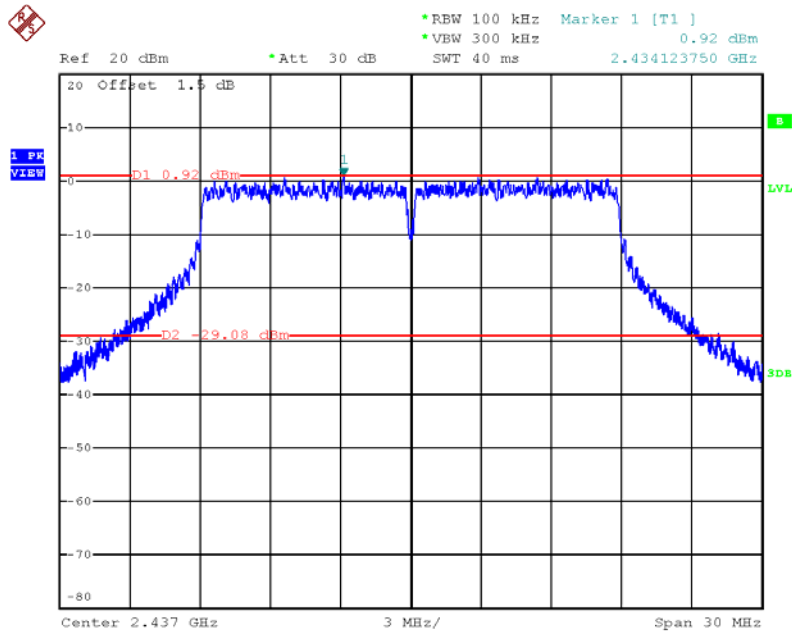

Date: 26.MAR.2013 17:26:48

Plot on Configuration IEEE 802.11n MCS0 20MHz / CH 1 / 30MHz~2400MHz (down 30dBc)

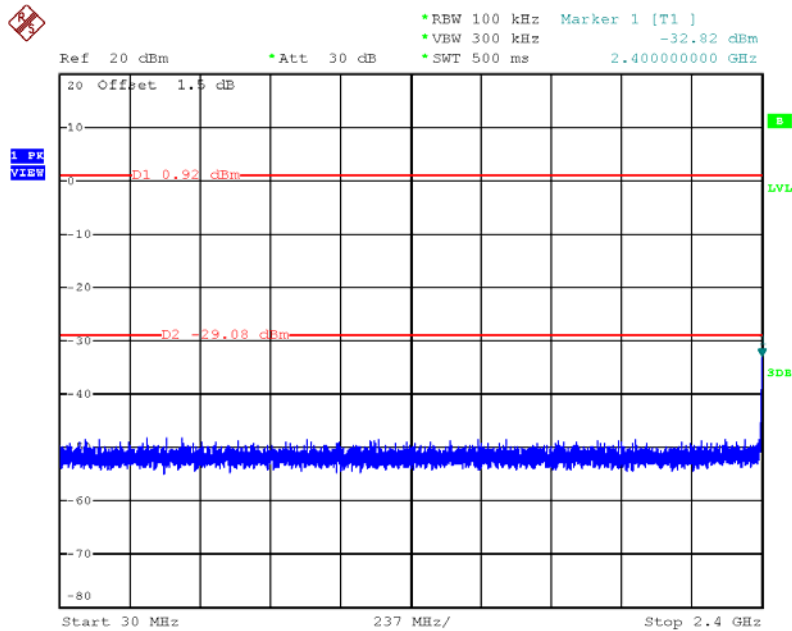

Date: 26.MAR.2013 17:27:43

Plot on Configuration IEEE 802.11n MCS0 20MHz / CH 11 / 2500MHz~26500MHz (down 30dBc)

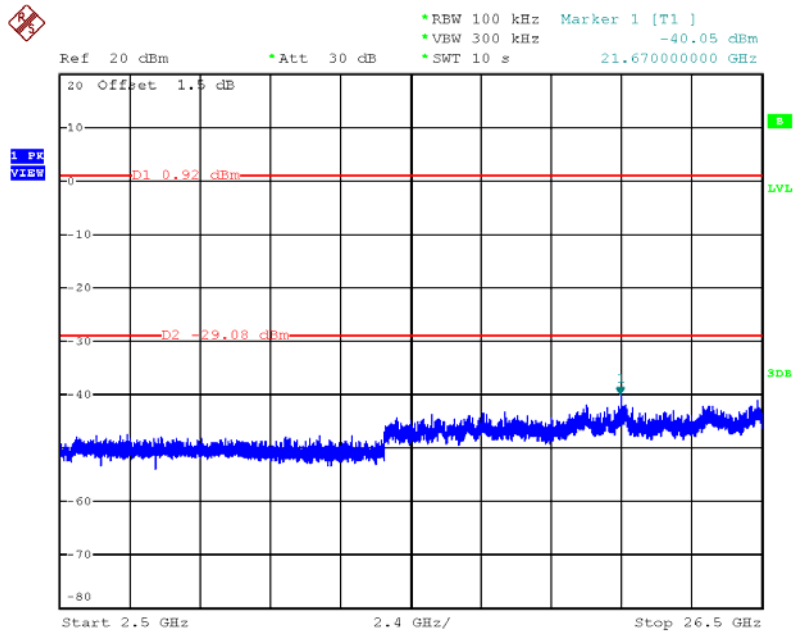

Date: 26.MAR.2013 17:29:48

Plot on Configuration IEEE 802.11n MCS0 40MHz / Reference Level

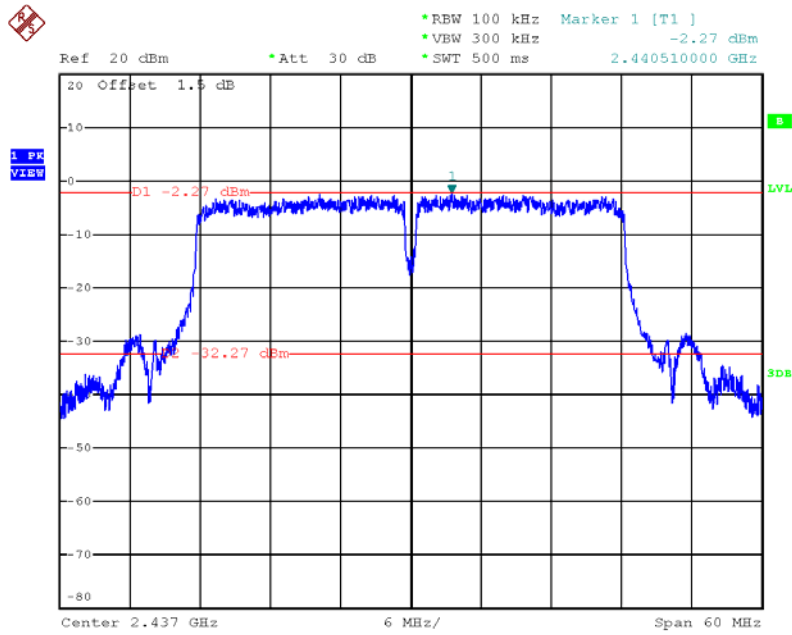

Date: 26.MAR.2013 18:23:18

Plot on Configuration IEEE 802.11n MCS0 40MHz / CH 3 / 30MHz~2400MHz (down 30dBc)

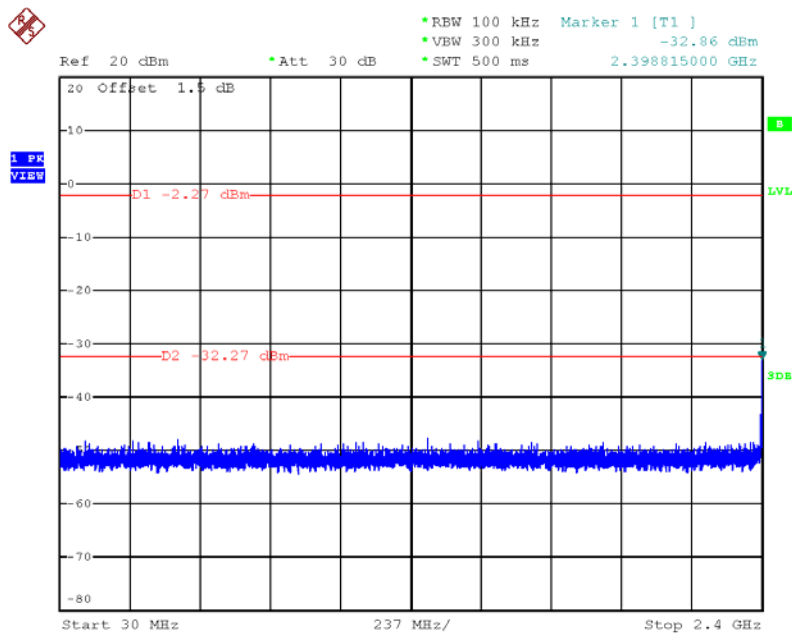

Date: 26.MAR.2013 18:24:25

Plot on Configuration IEEE 802.11n MCS0 40MHz / CH 9 / 2500MHz~26500MHz (down 30dBc)

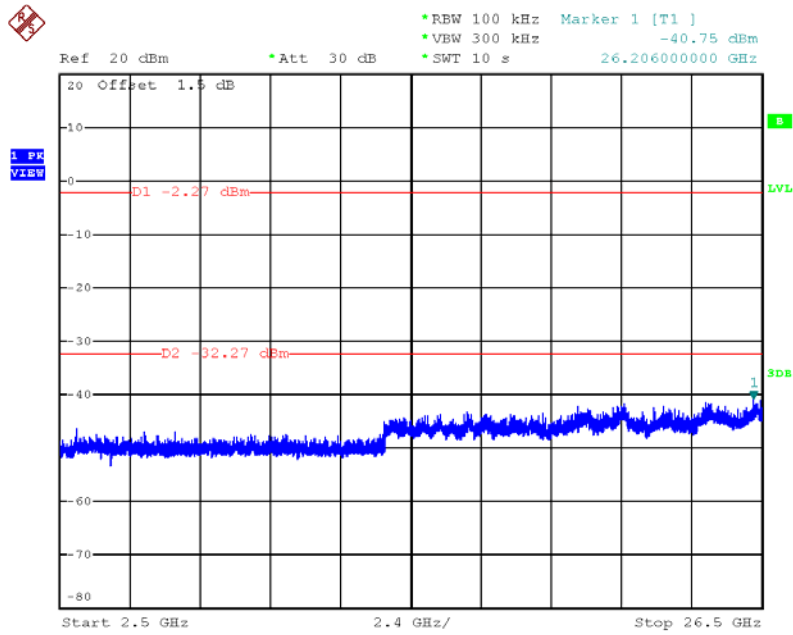

Date: 26.MAR.2013 18:26:21

Plot on Configuration IEEE 802.11b / Reference Level

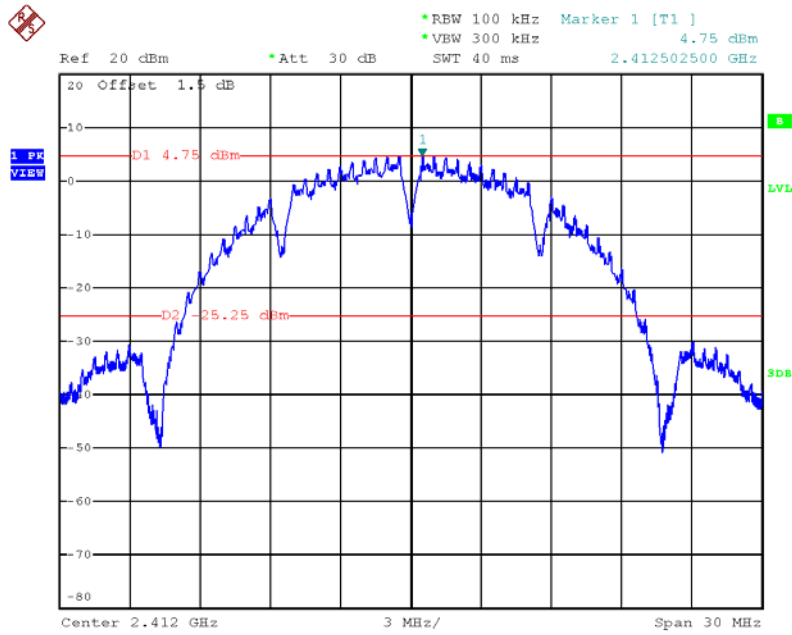

Date: 26.MAR.2013 17:06:58

Plot on Configuration IEEE 802.11b / CH 1 / 30MHz~2400MHz (down 30dBc)

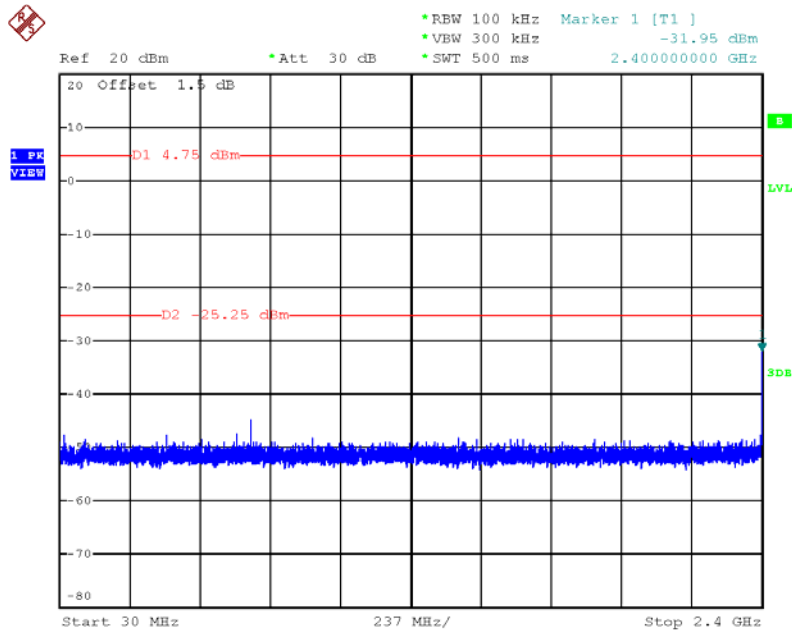

Date: 26.MAR.2013 17:07:53

Plot on Configuration IEEE 802.11b / CH 1 / 2500MHz~26500MHz (down 30dBc)

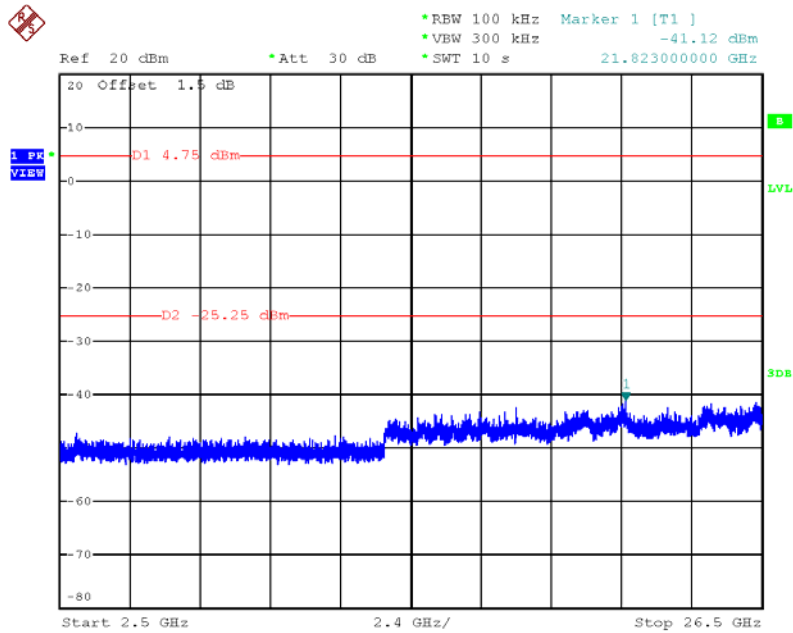

Date: 26.MAR.2013 17:09:16

Plot on Configuration IEEE 802.11b / CH 11 / 30MHz~2400MHz (down 30dBc)

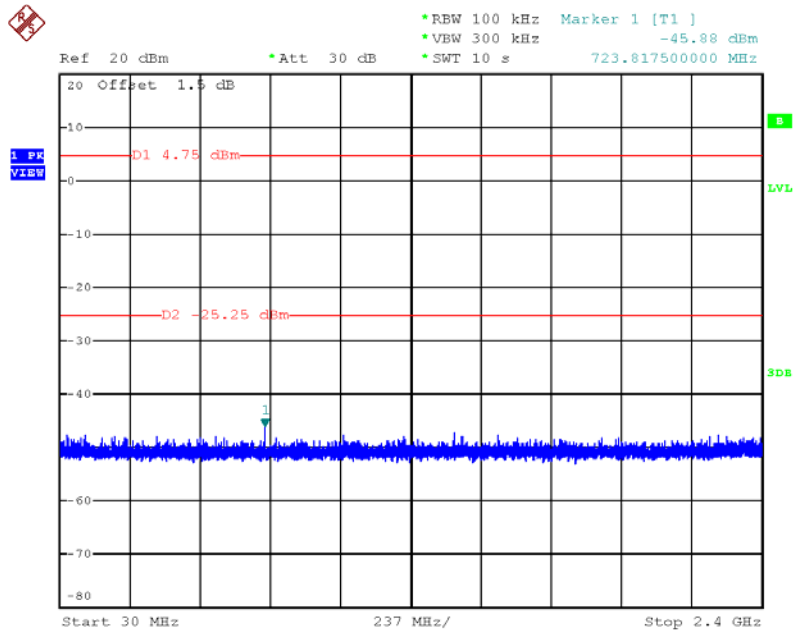

Date: 26.MAR.2013 17:11:30

Plot on Configuration IEEE 802.11b / CH 11 / 2500MHz~26500MHz (down 30dBc)

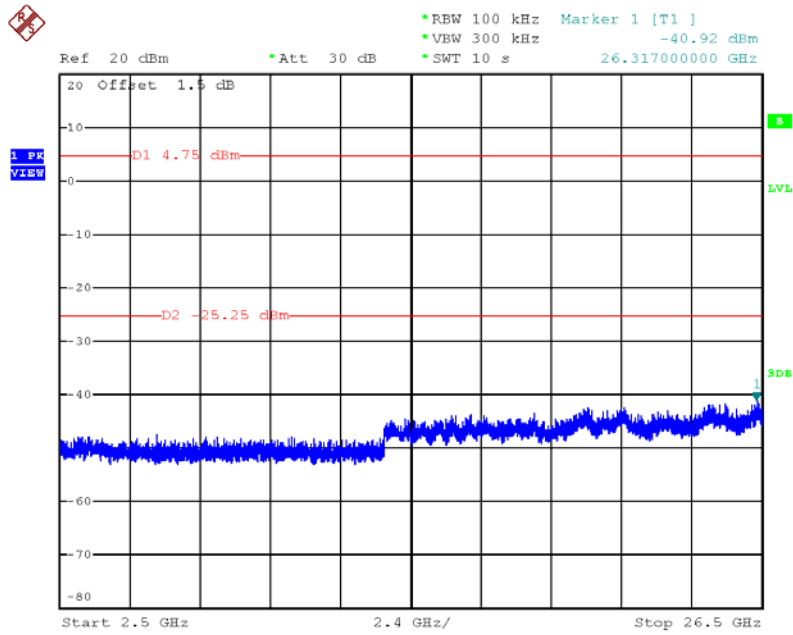

Date: 26.MAR.2013 17:10:41

Plot on Configuration IEEE 802.11g / Reference Level

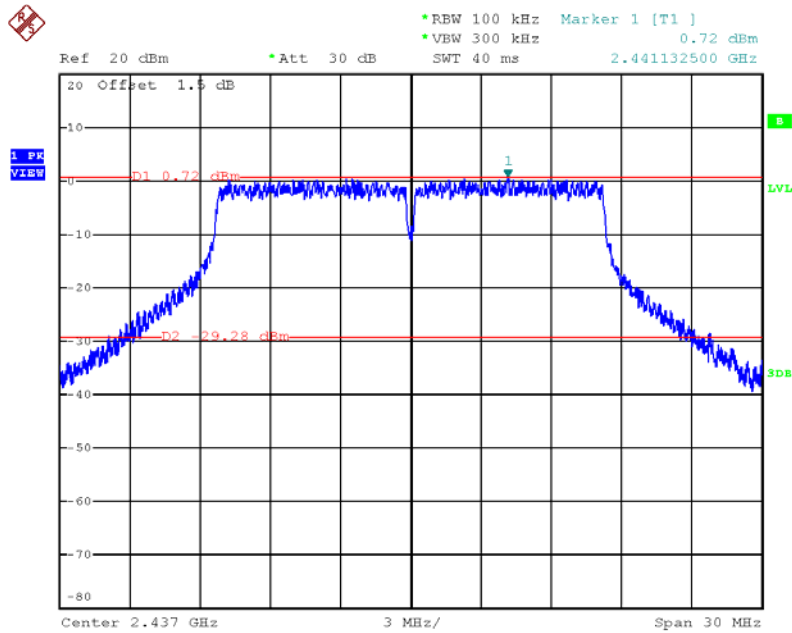

Date: 26.MAR.2013 17:13:43

Plot on Configuration IEEE 802.11g / CH 1 / 30MHz~2400MHz (down 30dBc)

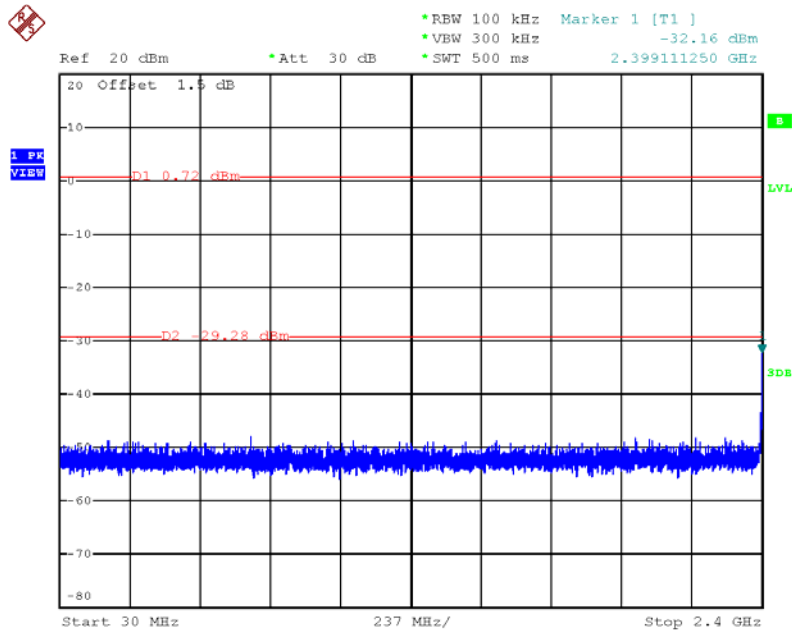

Date: 26.MAR.2013 17:16:22

Plot on Configuration IEEE 802.11g / CH 1 / 2500MHz~26500MHz (down 30dBc)

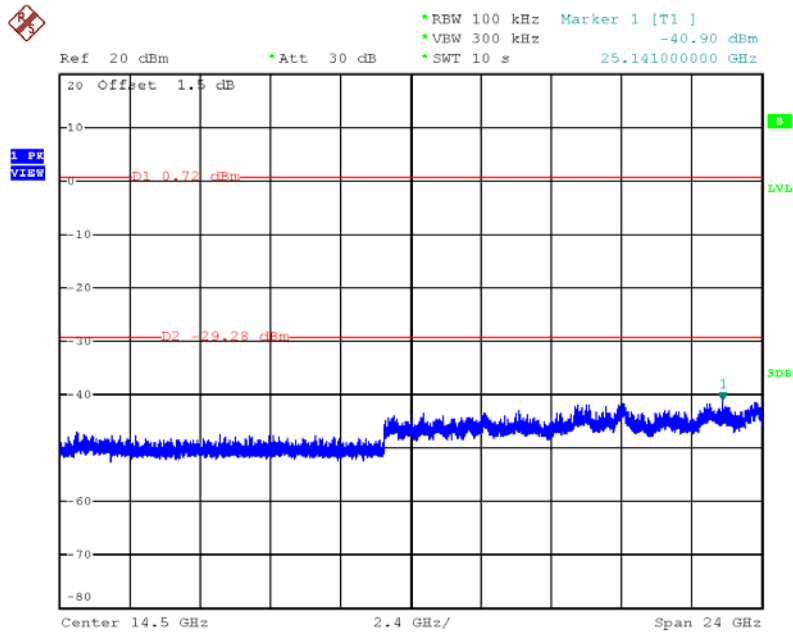

Date: 26.MAR.2013 17:17:49

Plot on Configuration IEEE 802.11g / CH 11 / 30MHz~2400MHz (down 30dBc)

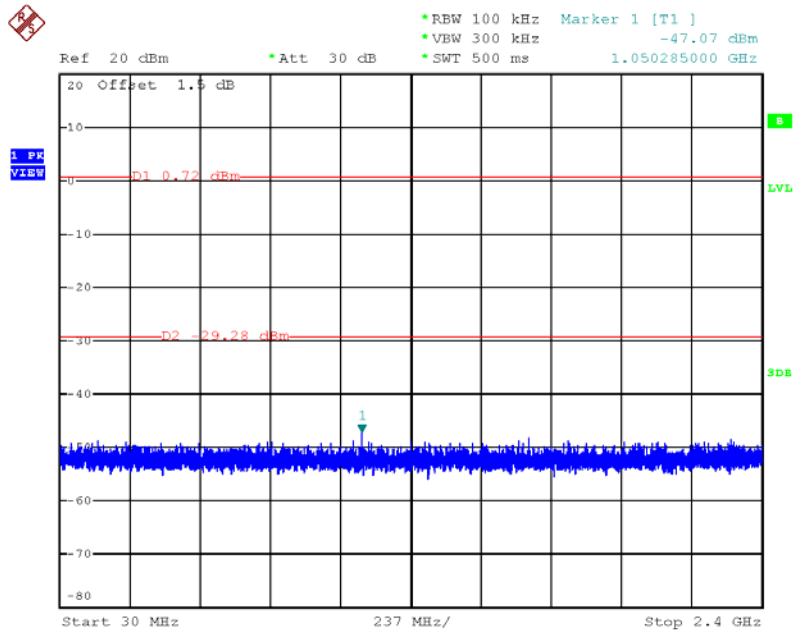

Date: 26.MAR.2013 17:19:23

Plot on Configuration IEEE 802.11g / CH 11 / 2500MHz~26500MHz (down 30dBc)

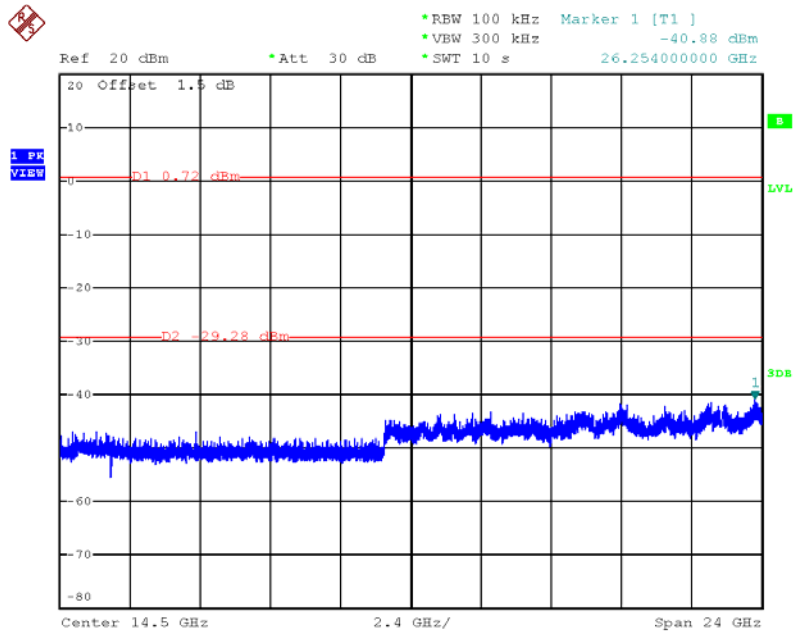

Date: 26.MAR.2013 17:18:35

4.7. Antenna Requirements

4.7.1. Limit

Except for special regulations, the Low-power Radio-frequency Devices must not be equipped with any jacket for installing an antenna with extension cable. An intentional radiator shall be designed to ensure that no antenna other than that furnished by the responsible party shall be used with the device. The use of a permanently attached antenna or of an antenna that uses a unique coupling to the intentional radiator shall be considered sufficient to comply with the provisions of this Section. The manufacturer may design the unit so that the user can replace a broken antenna, but the use of a standard antenna jack or electrical connector is prohibited. Further, this requirement does not apply to intentional radiators that must be professionally installed.

4.7.2. Antenna Connector Construction

Please refer to section 3.3 in this test report; antenna connector complied with the requirements.

5. LIST OF MEASURING EQUIPMENTS

Instrument	Manufacturer	Model No.	Serial No.	Characteristics	Calibration Date	Remark
EMI Test Receiver	R&S	ESCS 30	100377	9kHz ~ 2.75GHz	Oct. 23, 2012	Conduction (CO01-CB)
LISN	F.C.C.	FCC-LISN-50-16-2	04083	150kHz ~ 100MHz	Nov.26, 2012	Conduction (CO01-CB)
V- LISN	Schwarzbeck	NSLK 8127	8127-478	9kHz ~ 30MHz	Jun. 22, 2012	Conduction (CO01-CB)
Impulsbegrenzer Pulse Limiter	Rohde&Schwarz	ESH3-Z2	100430	9kHz~30MHz	Feb. 03, 2013	Conduction (CO01-CB)
COND Cable	Woken	Cable	01	0.15MHz~30MHz	Dec. 04, 2012	Conduction (CO01-CB)
Software	Audix	E3	5.410e	-	-	Conduction (CO01-CB)
BILOG ANTENNA	Schaffner	CBL6112D	22021	20MHz ~ 2GHz	Jan. 11, 2013	Radiation (03CH01-CB)
Loop Antenna	Teseq	HLA 6120	24155	9 kHz - 30 MHz	Nov. 05, 2012*	Radiation (03CH01-CB)
Horn Antenna	EMCO	3115	00075790	750MHz~18GHz	Nov. 27, 2012	Radiation (03CH01-CB)
Horn Antenna	SCHWARZBEAK	BBHA 9170	BBHA9170252	15GHz ~ 40GHz	Nov. 23, 2012	Radiation (03CH01-CB)
Pre-Amplifier	Agilent	8447D	2944A10991	0.1MHz ~ 1.3GHz	Nov. 27, 2012	Radiation (03CH01-CB)
Pre-Amplifier	Agilent	8449B	3008A02310	1GHz ~ 26.5GHz	Nov. 23, 2012	Radiation (03CH01-CB)
Pre-Amplifier	WM	TF-130N-R1	923365	26.5GHz ~ 40GHz	Jul. 31, 2012	Radiation (03CH01-CB)
Spectrum analyzer	R&S	FSP40	100056	9KHz~40GHz	Nov. 16, 2012	Radiation (03CH01-CB)
EMI Test Receiver	R&S	ESCS 30	100355	9KHz ~ 2.75GHz	Mar. 20, 2013	Radiation (03CH01-CB)
Turn Table	INN CO	CO 2000	N/A	0 ~ 360 degree	N.C.R	Radiation (03CH01-CB)
Antenna Mast	INN CO	CO2000	N/A	1 m - 4 m	N.C.R	Radiation (03CH01-CB)
RF Cable-low	Woken	Low Cable-1	N/A	30 MHz - 1 GHz	Nov. 18, 2012	Radiation (03CH01-CB)
RF Cable-high	Woken	High Cable-1	N/A	1 GHz – 26.5 GHz	Nov. 18, 2012	Radiation (03CH01-CB)
RF Cable-high	Woken	High Cable-2	N/A	1 GHz – 26.5 GHz	Nov. 18, 2012	Radiation (03CH01-CB)
RF Cable-high	Woken	High Cable-3	N/A	1 GHz - 40 GHz	Nov. 18, 2012	Radiation (03CH01-CB)
RF Cable-high	Woken	High Cable-4	N/A	1 GHz - 40 GHz	Nov. 18, 2012	Radiation (03CH01-CB)
Signal analyzer	R&S	FSV40	100979	9KHz~40GHz	Oct. 08, 2012	Conducted (TH01-CB)
RF Cable-high	Woken	High Cable-7	-	1 GHz – 26.5 GHz	Nov. 19, 2012	Conducted (TH01-CB)
RF Cable-high	Woken	High Cable-8	-	1 GHz – 26.5 GHz	Nov. 19, 2012	Conducted (TH01-CB)
RF Cable-high	Woken	High Cable-9	-	1 GHz – 26.5 GHz	Nov. 19, 2012	Conducted (TH01-CB)

Instrument	Manufacturer	Model No.	Serial No.	Characteristics	Calibration Date	Remark
RF Cable-high	Woken	High Cable-10	-	1 GHz – 26.5 GHz	Nov. 19, 2012	Conducted (TH01-CB)
RF Cable-high	Woken	High Cable-11	-	1 GHz – 26.5 GHz	Nov. 19, 2012	Conducted (TH01-CB)
Power Sensor	Anritsu	MA2411B	0917223	300MHz~40GHz	Nov. 28, 2012	Conducted (TH01-CB)
Power Meter	Anritsu	ML2495A	1035008	300MHz~40GHz	Nov. 27, 2012	Conducted (TH01-CB)

Note: Calibration Interval of instruments listed above is one year.

“*” Calibration Interval of instruments listed above is two years.

N.C.R. means Non-Calibration required.

6. TEST LOCATION

SHIJR	ADD : 6Fl., No. 106, Sec. 1, Shintai 5th Rd., Shijr City, Taipei, Taiwan 221, R.O.C. TEL : 886-2-2696-2468 FAX : 886-2-2696-2255
HWA YA	ADD : No. 52, Hwa Ya 1st Rd., Kwei-Shan Hsiang, Tao Yuan Hsien, Taiwan, R.O.C. TEL : 886-3-327-3456 FAX : 886-3-318-0055
LINKOU	ADD : No. 30-2, Dingfu Tsuen, Linkou Shiang, Taipei, Taiwan 244, R.O.C TEL : 886-2-2601-1640 FAX : 886-2-2601-1695
DUNGHU	ADD : No. 3, Lane 238, Kangle St., Neihu Chiu, Taipei, Taiwan 114, R.O.C. TEL : 886-2-2631-4739 FAX : 886-2-2631-9740
JUNGHE	ADD : 7Fl., No. 758, Jungjeng Rd., Junghe City, Taipei, Taiwan 235, R.O.C. TEL : 886-2-8227-2020 FAX : 886-2-8227-2626
NEIHU	ADD : 4Fl., No. 339, Hsin Hu 2 nd Rd., Taipei 114, Taiwan, R.O.C. TEL : 886-2-2794-8886 FAX : 886-2-2794-9777
JHUBEI	ADD : No.8, Lane 724, Bo-ai St., Jhubei City, HsinChu County 302, Taiwan, R.O.C. TEL : 886-3-656-9065 FAX : 886-3-656-9085