

FCC SAR EVALUATION REPORT

In accordance with the requirements of
FCC 47 CFR Part 2(2.1093), ANSI/IEEE C95.1-1992 and
IEEE Std 1528-2013

Product Name : Handheld

Trademark : N/A

Model Name : xTablet A680

Serial Model : N/A

Report No. : S18121802903001

FCC ID : O86A680

Prepared for

MobileDemand, LC

1501 Boyson Square Drive Suite 101 Hiawatha, Iowa United States 52233

Prepared by

Shenzhen NTEK Testing Technology Co., Ltd.

1/F, Building E, Fenda Science Park, Sanwei Community, Xixiang Street,

Bao'an District, Shenzhen 518126 P.R.China.

Tel.: +86-755-6115 6588 Fax.: +86-755-6115 6599

Website: <http://www.ntek.org.cn>

TEST RESULT CERTIFICATION

Applicant's name.....: MobileDemand, LC
 Address.....: 1501 Boyson Square Drive Suite 101 Hiawatha, Iowa United States
 52233

Manufacturer's Name.....: MobileDemand, LC
 Address.....: 1501 Boyson Square Drive Suite 101 Hiawatha, Iowa United States
 52233

Product description

Product name.....: Handheld
 Trademark: N/A
 Model and/or type reference : xTablet A680
 Serial Model: N/A
 FCC 47 CFR Part 2(2.1093)

Standards.....: ANSI/IEEE C95.1-1992
 IEEE Std 1528-2013
 Published RF exposure KDB procedures

This device described above has been tested by Shenzhen NTEK. In accordance with the measurement methods and procedures specified in IEEE Std 1528-2013 and KDB 865664 D01. Testing has shown that this device is capable of compliance with localized specific absorption rate (SAR) specified in FCC 47 CFR Part 2(2.1093) and ANSI/IEEE C95.1-1992. The test results in this report apply only to the tested sample of the stated device/equipment. Other similar device/equipment will not necessarily produce the same results due to production tolerance and measurement uncertainties.

This report shall not be reproduced except in full, without the written approval of Shenzhen NTEK, this document may be altered or revised by Shenzhen NTEK, personal only, and shall be noted in the revision of the document.

Date of Test

Date (s) of performance of tests..... : Dec. 20, 2018 ~ Jan. 03, 2019
 Date of Issue : Jan. 15, 2019
 Test Result : **Pass**

Prepared By : Cheng Jiawen
 (Test Engineer) :
 (Cheng Jiawen)

Approved By : Sam. Chen
 (Lab Manager) :
 (Sam Chen)

※ ※ Revision History ※ ※

REV.	DESCRIPTION	ISSUED DATE	REMARK
Rev.1.0	Initial Test Report Release	Jan. 15, 2019	Cheng Jiawen

TABLE OF CONTENTS

1. General Information	6
1.1. RF exposure limits.....	6
1.2. Statement of Compliance	7
1.3. EUT Description	8
1.4. Test specification(s)	8
1.5. Ambient Condition.....	8
2. SAR Measurement System	9
2.1. SATIMO SAR Measurement Set-up Diagram	9
2.2. Robot	10
2.3. E-Field Probe.....	11
2.3.1. E-Field Probe Calibration	11
2.4. SAM phantoms	12
2.4.1. Technical Data	13
2.5. Device Holder	14
2.6. Test Equipment List	15
3. SAR Measurement Procedures	17
3.1. Power Reference	17
3.2. Area scan & Zoom scan.....	17
3.3. Description of interpolation/extrapolation scheme	19
3.4. Volumetric Scan	19
3.5. Power Drift	19
4. System Verification Procedure	20
4.1. Tissue Verification	20
4.1.1. Tissue Dielectric Parameter Check Results	20
4.2. System Verification Procedure	21
4.2.1. System Verification Results.....	22
5. SAR Measurement variability and uncertainty	23
5.1. SAR measurement variability.....	23
5.2. SAR measurement uncertainty	23
6. RF Exposure Positions.....	24
6.1. Tablet host platform exposure conditions.....	24
7. RF Output Power	25
7.1. Maximum Tune-up Limit.....	25
7.2. WLAN Output Power.....	25
7.3. Bluetooth Output Power.....	26
8. Antenna Location.....	27
9. Stand-alone SAR test exclusion.....	30
10. SAR Results	31
10.1. SAR measurement results	31

10.1.1.	SAR measurement Result of WLAN 2.4G	31
10.1.2.	SAR measurement Result of WLAN 5.2G	31
10.1.3.	SAR measurement Result of WLAN 5.8G	32
11.	Appendix A. Photo documentation	33
12.	Appendix B. System Check Plots	34
13.	Appendix C. Plots of High SAR Measurement	47
14.	Appendix D. Calibration Certificate	60

1. General Information

1.1. RF exposure limits

(A).Limits for Occupational/Controlled Exposure (W/kg)

Whole-Body	Partial-Body	Hands, Wrists, Feet and Ankles
0.4	8.0	20.0

(B).Limits for General Population/Uncontrolled Exposure (W/kg)

Whole-Body	Partial-Body	Hands, Wrists, Feet and Ankles
0.08	1.6	4.0

NOTE: **Whole-Body SAR** is averaged over the entire body, **partial-body SAR** is averaged over any 1 gram of tissue defined as a tissue volume in the shape of a cube. **SAR for hands, wrists, feet and ankles** is averaged over any 10 grams of tissue defined as a tissue volume in the shape of a cube.

Occupational/Controlled Environments:

Are defined as locations where there is exposure that may be incurred by people who are aware of the potential for exposure, (i.e. as a result of employment or occupation).

General Population/Uncontrolled Environments:

Are defined as locations where there is the exposure of individuals who have no knowledge or control of their exposure.

NOTE
 HEAD AND TRUNK LIMIT
 1.6 W/kg
 APPLIED TO THIS EUT

1.2. Statement of Compliance

The maximum results of Specific Absorption Rate (SAR) found during testing for xTablet A680 are as follows.

Band	Max Reported SAR Value(W/kg)	
	1-g Head	1-g Body (Separation distance of 0mm)
WLAN 2.4G	0.196	1.003
WLAN 5.2G	0.127	0.861
WLAN 5.8G	0.347	1.311

NOTE: This device is in compliance with Specific Absorption Rate (SAR) for general population / uncontrolled exposure limits (1.6 W/kg) specified in FCC 47 CFR Part 2(2.1093) and ANSI/IEEE C95.1-1992, and had been tested in accordance with the measurement methods and procedures specified in IEEE Std 1528-2013 & Published RF exposure KDB procedures.

1.3. EUT Description

Device Information			
Product Name	Handheld		
Trademark	N/A		
Model Name	xTablet A680		
Serial Model	N/A		
FCC ID	O86A680		
Device Phase	Identical Prototype		
Exposure Category	General population / Uncontrolled environment		
Antenna Type	FPCB Antenna		
Battery Information	DC 3.7V, 5000mAh		
Device Operating Configurations			
Supporting Mode(s)	WLAN 2.4G/5.2G/5.8G, Bluetooth		
Test Modulation	WLAN(DSSS/OFDM), Bluetooth(GFSK, $\pi/4$ -DQPSK, 8DPSK)		
Operating Frequency Range(s)	Band	Tx (MHz)	Rx (MHz)
	WLAN 2.4G	2412-2462	
	WLAN 5.2G	5180-5240	
	WLAN 5.8G	5745-5825	
	Bluetooth	2402-2480	
Test Channels (low-mid-high)	1-3-6-9-11(WLAN 2.4G)		
	36-38-40-42-46-48(WLAN 5.2G)		
	149-151-155-157-159-165(WLAN 5.8G)		

1.4. Test specification(s)

FCC 47 CFR Part 2(2.1093)
ANSI/IEEE C95.1-1992
IEEE Std 1528-2013
KDB 865664 D01 SAR measurement 100 MHz to 6 GHz
KDB 865664 D02 RF Exposure Reporting
KDB 447498 D01 General RF Exposure Guidance
KDB 248227 D01 802.11 Wi-Fi SAR
KDB 616217 D04 SAR for laptop and tablets

1.5. Ambient Condition

Ambient temperature	20°C – 24°C
Relative Humidity	30% – 70%

2. SAR Measurement System

2.1. SATIMO SAR Measurement Set-up Diagram

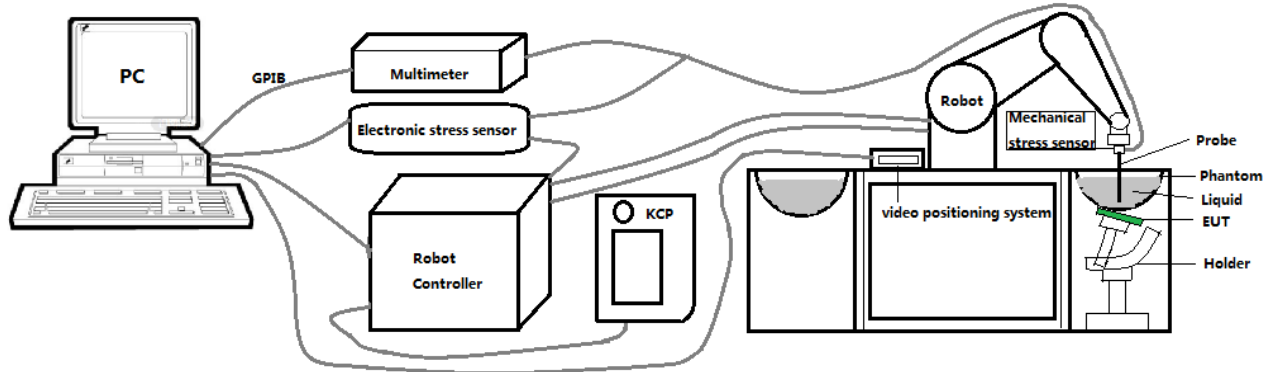

These measurements were performed with the automated near-field scanning system OPENSAR from SATIMO. The system is based on a high precision robot (working range: 901 mm), which positions the probes with a positional repeatability of better than ± 0.03 mm. The SAR measurements were conducted with dosimetric probe (manufactured by SATIMO), designed in the classical triangular configuration and optimized for dosimetric evaluation.

The first step of the field measurement is the evaluation of the voltages induced on the probe by the device under test. Probe diode detectors are nonlinear. Below the diode compression point, the output voltage is proportional to the square of the applied E-field; above the diode compression point, it is linear to the applied E-field. The compression point depends on the diode, and a calibration procedure is necessary for each sensor of the probe.

The Keithley multimeter reads the voltage of each sensor and send these three values to the PC. The corresponding E field value is calculated using the probe calibration factors, which are stored in the working directory. This evaluation includes linearization of the diode characteristics. The field calculation is done separately for each sensor. Each component of the E field is displayed on the "Dipole Area Scan Interface" and the total E field is displayed on the "3D Interface"

2.2. Robot

The SATIMO SAR system uses the high precision robots from KUKA. For the 6-axis controller system, the robot controller version (KUKA) from KUKA is used. The KUKA robot series have many features that are important for our application:



- High precision (repeatability ± 0.03 mm)
- High reliability (industrial design)
- Jerk-free straight movements
- Low ELF interference (the closed metallic construction shields against motor control fields)

2.3. E-Field Probe

This E-field detection probe is composed of three orthogonal dipoles linked to special Schottky diodes with low detection thresholds. The probe allows the measurement of electric fields in liquids such as the one defined in the IEEE and CENELEC standards.

For the measurements the Specific Dosimetric E-Field Probe SN 08/16 EPGO287 with following specifications is used



- Dynamic range: 0.01-100 W/kg
 - Tip Diameter: 2.5 mm
 - Distance between probe tip and sensor center: 1 mm
 - Distance between sensor center and the inner phantom surface: 2 mm (repeatability better than ± 1 mm).
 - Probe linearity: ± 0.08 dB
 - Axial isotropy: 0.06 dB
 - Hemispherical Isotropy: 0.08 dB
 - Calibration range: 650MHz to 5900MHz for head & body simulating liquid.
 - Lower detection limit: 7mW/kg
- Angle between probe axis (evaluation axis) and surface normal line: less than 30° .

2.3.1. E-Field Probe Calibration

Each probe needs to be calibrated according to a dosimetric assessment procedure with accuracy better than $\pm 10\%$. The spherical isotropy shall be evaluated and within ± 0.25 dB. The sensitivity parameters (Norm X, Norm Y, and Norm Z), the diode compression parameter (DCP) and the conversion factor (Conv F) of the probe are tested. The calibration data can be referred to appendix D of this report.

2.4. SAM phantoms

Photo of SAM phantom SN 16/15 SAM119



The SAM phantom is used to measure the SAR relative to people exposed to electro-magnetic field radiated by mobile phones.

2.4.1. Technical Data

Serial Number	Shell thickness	Filling volume	Dimensions	Positionner Material	Permittivity	Loss Tangent
SN 16/15 SAM119	2 mm ±0.2 mm	27 liters	Length:1000 mm Width:500 mm Height:200 mm	Gelcoat with fiberglass	3.4	0.02

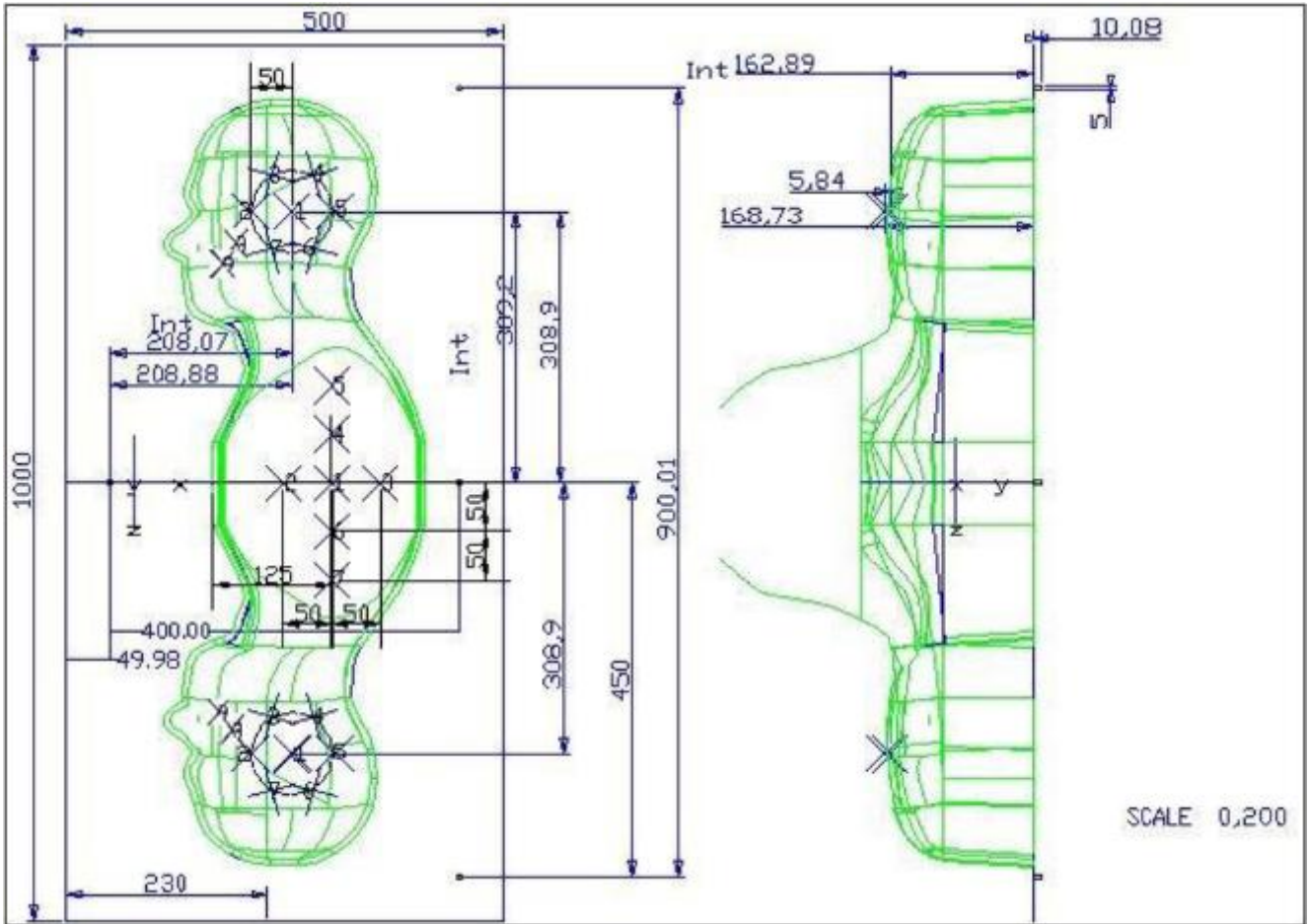

Serial Number	Left Head(mm)		Right Head(mm)		Flat Part(mm)	
	1	2	1	2	1	2
SN 16/15 SAM119	2	2.02	2	2.08	1	2.09
	3	2.05	3	2.06	2	2.06
	4	2.07	4	2.07	3	2.08
	5	2.08	5	2.08	4	2.10
	6	2.05	6	2.07	5	2.10
	7	2.05	7	2.05	6	2.07
	8	2.07	8	2.06	7	2.07
	9	2.08	9	2.06	-	-

The test, based on ultrasonic system, allows measuring the thickness with an accuracy of 10 µm.

2.5. Device Holder

The positioning system allows obtaining cheek and tilting position with a very good accuracy. In compliance with CENELEC, the tilt angle uncertainty is lower than 1 degree.

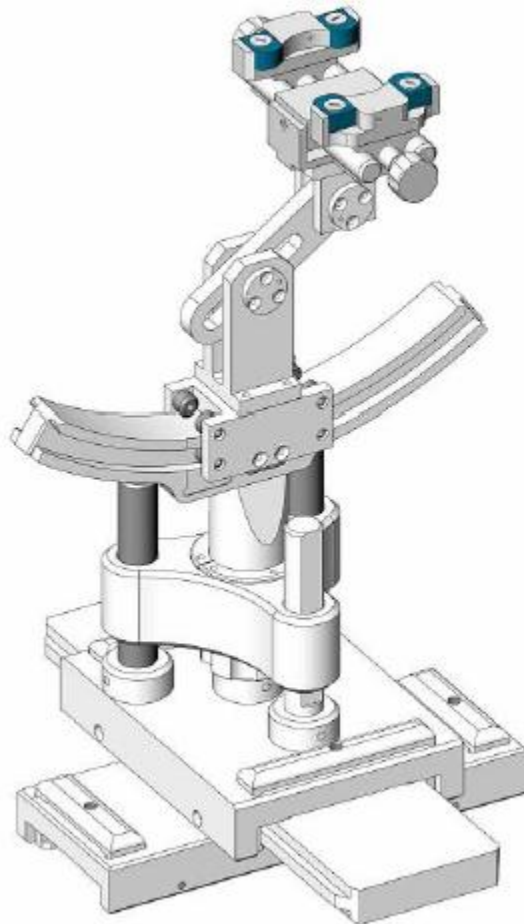

Serial Number	Holder Material	Permittivity	Loss Tangent
SN 16/15 MSH100	Delrin	3.7	0.005

2.6. Test Equipment List

This table gives a complete overview of the SAR measurement equipment.

Devices used during the test described are marked

	Manufacturer	Name of Equipment	Type/Model	Serial Number	Calibration	
					Last Cal.	Due Date
<input checked="" type="checkbox"/>	MVG	E FIELD PROBE	SSE2	SN 08/16 EPGO287	Sep. 17, 2018	Sep. 16, 2019
<input type="checkbox"/>	MVG	750 MHz Dipole	SID750	SN 03/15 DIP 0G750-355	Apr. 19, 2018	Apr. 18, 2021
<input type="checkbox"/>	MVG	835 MHz Dipole	SID835	SN 03/15 DIP 0G835-347	Apr. 19, 2018	Apr. 18, 2021
<input type="checkbox"/>	MVG	900 MHz Dipole	SID900	SN 03/15 DIP 0G900-348	Apr. 19, 2018	Apr. 18, 2021
<input type="checkbox"/>	MVG	1800 MHz Dipole	SID1800	SN 03/15 DIP 1G800-349	Apr. 19, 2018	Apr. 18, 2021
<input type="checkbox"/>	MVG	1900 MHz Dipole	SID1900	SN 03/15 DIP 1G900-350	Apr. 19, 2018	Apr. 18, 2021
<input type="checkbox"/>	MVG	2000 MHz Dipole	SID2000	SN 03/15 DIP 2G000-351	Apr. 19, 2018	Apr. 18, 2021
<input checked="" type="checkbox"/>	MVG	2450 MHz Dipole	SID2450	SN 03/15 DIP 2G450-352	Apr. 19, 2018	Apr. 18, 2021
<input type="checkbox"/>	MVG	2600 MHz Dipole	SID2600	SN 03/15 DIP 2G600-356	Apr. 19, 2018	Apr. 18, 2021
<input checked="" type="checkbox"/>	MVG	5000 MHz Dipole	SWG5500	SN 13/14 WGA 33	Apr. 19, 2018	Apr. 18, 2021
<input checked="" type="checkbox"/>	MVG	Liquid measurement Kit	SCLMP	SN 21/15 OCPG 72	NCR	NCR
<input checked="" type="checkbox"/>	MVG	Power Amplifier	N.A	AMPLISAR_28/14_003	NCR	NCR
<input checked="" type="checkbox"/>	KEITHLEY	Millivoltmeter	2000	4072790	NCR	NCR
<input type="checkbox"/>	R&S	Universal radio communication tester	CMU200	117858	Aug. 05, 2018	Aug. 04, 2019
<input type="checkbox"/>	R&S	Wideband radio communication tester	CMW500	103917	Oct. 08, 2018	Oct. 07, 2019
<input checked="" type="checkbox"/>	HP	Network Analyzer	8753D	3410J01136	Aug. 05, 2018	Aug. 04, 2019
<input checked="" type="checkbox"/>	Agilent	PSG Analog Signal Generator	E8257D	MY51110112	Aug. 05, 2018	Aug. 04, 2019

<input checked="" type="checkbox"/>	Agilent	Power meter	E4419B	MY45102538	Aug. 05, 2018	Aug. 04, 2019
<input checked="" type="checkbox"/>	Agilent	Power sensor	E9301A	MY41495644	Aug. 05, 2018	Aug. 04, 2019
<input checked="" type="checkbox"/>	Agilent	Power sensor	E9301A	US39212148	Aug. 05, 2018	Aug. 04, 2019
<input checked="" type="checkbox"/>	MCLI/USA	Directional Coupler	CB11-20	0D2L51502	Aug. 05, 2018	Aug. 04, 2019

3. SAR Measurement Procedures

The measurement procedures are as follows:

<Conducted power measurement>

- (a) For WWAN power measurement, use base station simulator to configure EUT WWAN transmission in conducted connection with RF cable, at maximum power in each supported wireless interface and frequency band.
- (b) Read the WWAN RF power level from the base station simulator.
- (c) For WLAN/Bluetooth power measurement, use engineering software to configure EUT WLAN/Bluetooth continuously transmission, at maximum RF power in each supported wireless interface and frequency band.
- (d) Connect EUT RF port through RF cable to the power meter, and measure WLAN/Bluetooth output power.

<SAR measurement>

- (a) Use base station simulator to configure EUT WWAN transmission in radiated connection, and engineering software to configure EUT WLAN/Bluetooth continuously transmission, at maximum RF power, in the highest power channel.
- (b) Place the EUT in the positions as Appendix A demonstrates.
- (c) Set scan area, grid size and other setting on the OPENSAR software.
- (d) Measure SAR results for the highest power channel on each testing position.
- (e) Find out the largest SAR result on these testing positions of each band.
- (f) Measure SAR results for other channels in worst SAR testing position if the reported SAR of highest power channel is larger than 0.8 W/kg.

According to the test standard, the recommended procedure for assessing the peak spatial-average SAR value consists of the following steps:

- (a) Power reference measurement
- (b) Area scan
- (c) Zoom scan
- (d) Power drift measurement

3.1. Power Reference

The Power Reference Measurement and Power Drift Measurements are for monitoring the power drift of the device under test in the batch process. The minimum distance of probe sensors to surface determines the closest measurement point to phantom surface. This distance cannot be smaller than the distance of sensor calibration points to probe tip as defined in the probe properties.

3.2. Area scan & Zoom scan

The area scan is a 2D scan to find the hot spot location on the DUT. The zoom scan is a 3D scan above the hot spot to calculate the 1g and 10g SAR value.

Measurement of the SAR distribution with a grid of 8 to 16 mm * 8 to 16 mm and a constant distance to the inner surface of the phantom. Since the sensors cannot directly measure at the inner phantom surface, the values between the sensors and the inner phantom surface are extrapolated. With these values the area of the maximum SAR is calculated by an interpolation scheme. Around this point, a cube of 30 * 30 * 30 mm or 32 * 32 * 32 mm is assessed by measuring 5 or 8 * 5 or 8 * 4 or 5 mm. With these data, the peak spatial-average SAR value can be calculated.

From the scanned SAR distribution, identify the position of the maximum SAR value, in addition identify the positions of any local maxima with SAR values within 2 dB of the maximum value that will not be within the zoom scan of other peaks; additional peaks shall be measured only when the primary peak is within 2 dB of the SAR compliance limit (e.g., 1 W/kg for 1,6 W/kg 1 g limit, or 1,26 W/kg for 2 W/kg, 10 g limit).

Area scan & Zoom scan scan parameters extracted from FCC KDB 865664 D01 SAR measurement 100 MHz to 6 GHz.

		≤ 3 GHz	> 3 GHz	
Maximum distance from closest measurement point (geometric center of probe sensors) to phantom surface		5 ± 1 mm	½·δ·ln(2) ± 0.5 mm	
Maximum probe angle from probe axis to phantom surface normal at the measurement location		30° ± 1°	20° ± 1°	
Maximum area scan spatial resolution: Δx _{Area} , Δy _{Area}		≤ 2 GHz: ≤ 15 mm 2 – 3 GHz: ≤ 12 mm	3 – 4 GHz: ≤ 12 mm 4 – 6 GHz: ≤ 10 mm	
		When the x or y dimension of the test device, in the measurement plane orientation, is smaller than the above, the measurement resolution must be ≤ the corresponding x or y dimension of the test device with at least one measurement point on the test device.		
Maximum zoom scan spatial resolution: Δx _{Zoom} , Δy _{Zoom}		≤ 2 GHz: ≤ 8 mm 2 – 3 GHz: ≤ 5 mm*	3 – 4 GHz: ≤ 5 mm* 4 – 6 GHz: ≤ 4 mm*	
Maximum zoom scan spatial resolution, normal to phantom surface	uniform grid: Δz _{Zoom} (n)	≤ 5 mm	3 – 4 GHz: ≤ 4 mm 4 – 5 GHz: ≤ 3 mm 5 – 6 GHz: ≤ 2 mm	
	graded grid	Δz _{Zoom} (1): between 1 st two points closest to phantom surface	≤ 4 mm	3 – 4 GHz: ≤ 3 mm 4 – 5 GHz: ≤ 2.5 mm 5 – 6 GHz: ≤ 2 mm
		Δz _{Zoom} (n>1): between subsequent points	≤ 1.5·Δz _{Zoom} (n-1)	
Minimum zoom scan volume	x, y, z	≥ 30 mm	3 – 4 GHz: ≥ 28 mm 4 – 5 GHz: ≥ 25 mm 5 – 6 GHz: ≥ 22 mm	

Note: δ is the penetration depth of a plane-wave at normal incidence to the tissue medium; see draft standard IEEE P1528-2011 for details.

* When zoom scan is required and the *reported* SAR from the *area scan based 1-g SAR estimation* procedures of KDB 447498 is ≤ 1.4 W/kg, ≤ 8 mm, ≤ 7 mm and ≤ 5 mm zoom scan resolution may be applied, respectively, for 2 GHz to 3 GHz, 3 GHz to 4 GHz and 4 GHz to 6 GHz.

3.3. Description of interpolation/extrapolation scheme

The local SAR inside the phantom is measured using small dipole sensing elements inside a probe body. The probe tip must not be in contact with the phantom surface in order to minimise measurements errors, but the highest local SAR will occur at the surface of the phantom.

An extrapolation is using to determinate this highest local SAR values. The extrapolation is based on a fourth-order least-square polynomial fit of measured data. The local SAR value is then extrapolated from the liquid surface with a 1 mm step.

The measurements have to be performed over a limited time (due to the duration of the battery) so the step of measurement is high. It could vary between 5 and 8 mm. To obtain an accurate assessment of the maximum SAR averaged over 10 grams and 1 gram requires a very fine resolution in the three dimensional scanned data array.

3.4. Volumetric Scan

The volumetric scan consists to a full 3D scan over a specific area. This 3D scan is useful form multi Tx SAR measurement. Indeed, it is possible with OpenSAR to add, point by point, several volumetric scan to calculate the SAR value of the combined measurement as it is define in the standard IEEE1528 and IEC62209.

3.5. Power Drift

All SAR testing is under the EUT install full charged battery and transmit maximum output power. In OpenSAR measurement software, the power reference measurement and power drift measurement procedures are used for monitoring the power drift of EUT during SAR test. Both these procedures measure the field at a specified reference position before and after the SAR testing. The software will calculate the field difference in V/m. If the power drifts more than $\pm 5\%$, the SAR will be retested.

4. System Verification Procedure

4.1. Tissue Verification

The following tissue formulations are provided for reference only as some of the parameters have not been thoroughly verified. The composition of ingredients may be modified accordingly to achieve the desired target tissue parameters required for routine SAR evaluation.

Ingredients (% of weight)	Head Tissue									
	750	835	900	1800	1900	2000	2450	2600	5200	5800
Frequency Band (MHz)										
Water	34.40	34.40	34.40	55.36	55.36	57.87	57.87	57.87	65.53	65.53
NaCl	0.79	0.79	0.79	0.35	0.35	0.16	0.16	0.16	0.00	0.00
1,2-Propanediol	64.81	64.81	64.81	0.00	0.00	0.00	0.00	0.00	0.00	0.00
Triton X-100	0.00	0.00	0.00	30.45	30.45	19.97	19.97	19.97	24.24	24.24
DGBE	0.00	0.00	0.00	13.84	13.84	22.00	22.00	22.00	10.23	10.23
Ingredients (% of weight)	Body Tissue									
	750	835	900	1800	1900	2000	2450	2600	5200	5800
Frequency Band (MHz)										
Water	50.30	50.30	50.30	69.91	69.91	71.88	71.88	71.88	79.54	79.54
NaCl	0.60	0.60	0.60	0.13	0.13	0.16	0.16	0.16	0.00	0.00
1,2-Propanediol	49.10	49.10	49.10	0.00	0.00	0.00	0.00	0.00	0.00	0.00
Triton X-100	0.00	0.00	0.00	9.99	9.99	19.97	19.97	19.97	11.24	11.24
DGBE	0.00	0.00	0.00	19.97	19.97	7.99	7.99	7.99	9.22	9.22

4.1.1. Tissue Dielectric Parameter Check Results

The simulating liquids should be checked at the beginning of a series of SAR measurements to determine if the dielectric parameters are within the tolerances of the specified target values. The measured conductivity and relative permittivity should be within $\pm 5\%$ of the target values.

Tissue Type	Measured Frequency (MHz)	Target Tissue		Measured Tissue		Liquid Temp.	Test Date
		ϵ_r ($\pm 5\%$)	σ (S/m) ($\pm 5\%$)	ϵ_r	σ (S/m)		
Head 2450	2450	39.20 (37.24~41.16)	1.80 (1.71~1.89)	40.04	1.78	21.5 °C	Dec. 20, 2018
Body 2450	2450	52.70 (50.07~55.33)	1.95 (1.85~2.04)	52.73	1.98	21.7 °C	Dec. 20, 2018
Head 5000	5200	36.00 (34.20~37.80)	4.66 (4.43~4.89)	35.97	4.62	21.3 °C	Jan. 03, 2019

Body 5000	5200	49.00 (46.55~51.45)	5.30 (5.04~5.57)	49.91	5.27	21.5 °C	Dec. 26, 2018
Head 5000	5800	35.30 (33.54~37.07)	5.27 (5.01~5.53)	34.84	5.19	21.7 °C	Jan. 03, 2019
Body 5000	5800	48.20 (45.79~50.61)	6.00 (5.70~6.30)	48.59	6.03	21.2 °C	Dec. 26, 2018

NOTE: The dielectric parameters of the tissue-equivalent liquid should be measured under similar ambient conditions and within 2 °C of the conditions expected during the SAR evaluation to satisfy protocol requirements.

4.2. System Verification Procedure

The system verification is performed for verifying the accuracy of the complete measurement system and performance of the software. The dipole is connected to the signal source consisting of signal generator and amplifier via a directional coupler, N-connector cable and adaption to SMA. It is fed with a power of 100mW (below 5GHz) or 100mW (above 5GHz). To adjust this power a power meter is used. The power sensor is connected to the cable before the system verification to measure the power at this point and do adjustments at the signal generator. At the outputs of the directional coupler both return loss as well as forward power are controlled during the system verification to make sure that emitted power at the dipole is kept constant. This can also be checked by the power drift measurement after the test (result on plot).

The system verification is shown as below picture:

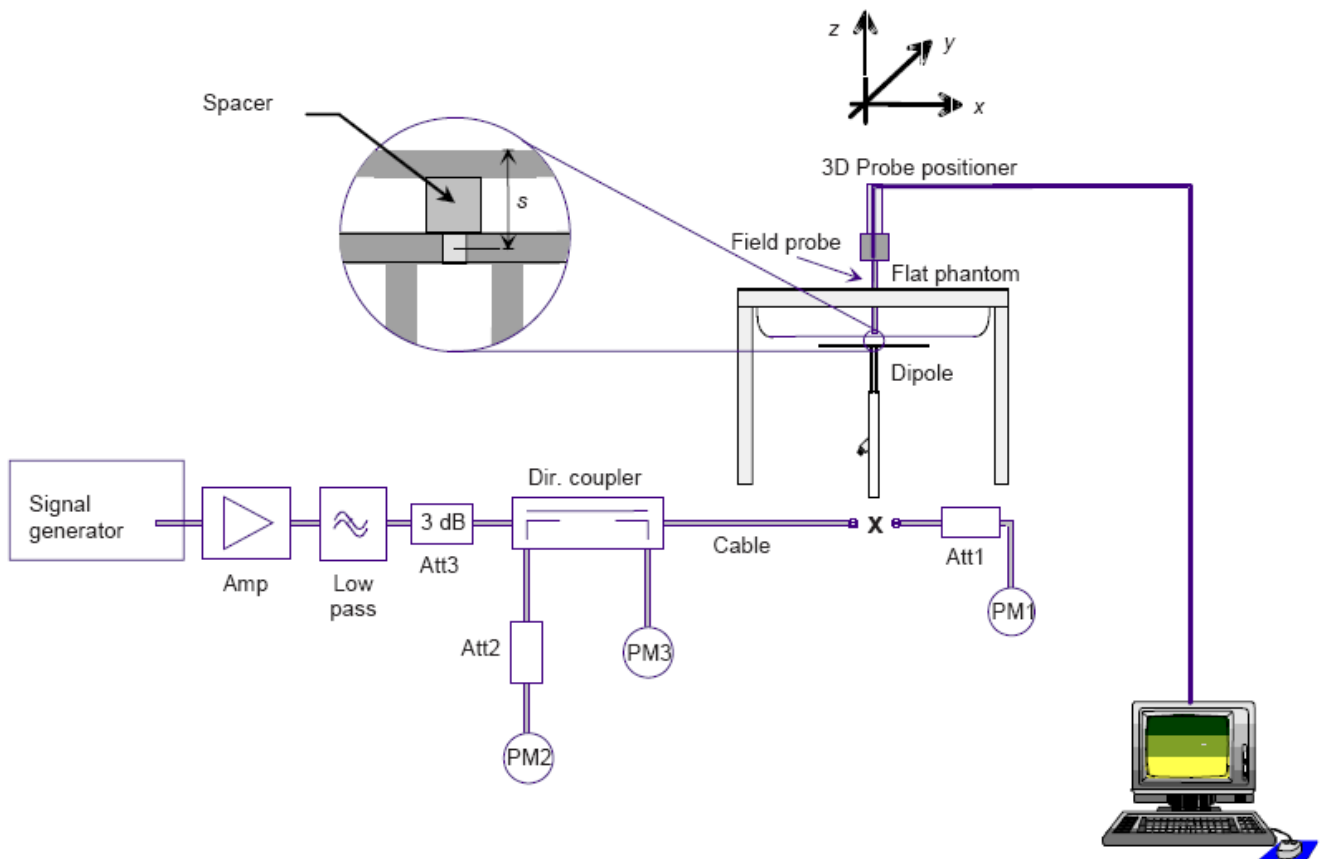

4.2.1. System Verification Results

Comparing to the original SAR value provided by SATIMO, the verification data should be within its specification of $\pm 10\%$. Below table shows the target SAR and measured SAR after normalized to 1W input power. The table below indicates the system performance verification can meet the variation criterion and the plots can be referred to Appendix B of this report.

System Verification	Target SAR (1W) ($\pm 10\%$)		Measured SAR (Normalized to 1W)		Liquid Temp.	Test Date
	1-g (W/Kg)	10-g (W/Kg)	1-g (W/Kg)	10-g (W/Kg)		
2450MHz Head	52.40 (47.16~57.64)	24.00 (21.60~26.40)	54.31	23.83	21.5 °C	Dec. 20, 2018
2450MHz Body	49.32 (44.39~54.25)	22.89 (20.60~25.17)	51.99	23.01	21.7 °C	Dec. 20, 2018
5200MHz Head	159.00 (143.10~174.90)	56.90 (51.21~62.59)	152.34	54.24	21.3 °C	Jan. 03, 2019
5200MHz Body	156.85 (141.17~172.54)	55.20 (49.68~60.72)	159.12	57.13	21.5 °C	Dec. 26, 2018
5800MHz Head	181.20 (163.08~199.32)	61.50 (55.35~67.65)	179.37	61.32	21.7 °C	Jan. 03, 2019
5800MHz Body	169.30 (152.37~186.23)	58.49 (52.64~64.34)	158.14	55.17	21.2 °C	Dec. 26, 2018

5. SAR Measurement variability and uncertainty

5.1. SAR measurement variability

Per KDB865664 D01 SAR measurement 100 MHz to 6 GHz, SAR measurement variability must be assessed for each frequency band, which is determined by the SAR probe calibration point and tissue-equivalent medium used for the device measurements. The additional measurements are repeated after the completion of all measurements requiring the same head or body tissue-equivalent medium in a frequency band. The test device should be returned to ambient conditions (normal room temperature) with the battery fully charged before it is re-mounted on the device holder for the repeated measurement(s) to minimize any unexpected variations in the repeated results.

- 1) Repeated measurement is not required when the original highest measured SAR is < 0.80 W/kg; steps 2) through 4) do not apply.
- 2) When the original highest measured SAR is ≥ 0.80 W/kg, repeat that measurement once.
- 3) Perform a second repeated measurement only if the ratio of largest to smallest SAR for the original and first repeated measurements is > 1.20 or when the original or repeated measurement is ≥ 1.45 W/kg (~ 10% from the 1-g SAR limit).
- 4) Perform a third repeated measurement only if the original, first or second repeated measurement is ≥ 1.5 W/kg and the ratio of largest to smallest SAR for the original, first and second repeated measurements is > 1.20 .

5.2. SAR measurement uncertainty

Per KDB865664 D01 SAR Measurement 100 MHz to 6 GHz, when the highest measured 1-g SAR within a frequency band is < 1.5 W/kg, the extensive SAR measurement uncertainty analysis described in IEEE Std 1528-2013 is not required in SAR reports submitted for equipment approval. The equivalent ratio (1.5/1.6) is applied to extremity and occupational exposure conditions.

6. RF Exposure Positions

6.1. Tablet host platform exposure conditions

Refer to KDB616217 D04, when the modular approach is used, transmitters and modules must be initially tested for standalone operations in generic host conditions according to the following minimum test separation distance and antenna installation requirements for incorporation in the tablet platform. The separation distance required for incorporation in qualified hosts is described in KDB 447498; item 5) of section 4.1 and item 1) of section 5.2.2 etc.

- ≤ 5 mm between the antenna and user for both back surface and edge exposure conditions
- the antennas used by the host must have been tested for equipment approval or qualify for SAR test exclusion
- the antenna polarization, physical orientation, rotation and installation configurations used by the host must have been tested for compliance or qualify for test exclusion
- when the *SAR Test Exclusion Threshold* in KDB 447498 applies, a *test separation distance* of 5 mm is required to determine test exclusion for the tablet platform

The antennas embedded in tablets are typically ≤ 5 mm from the outer housing. The required antenna to user test separation distance is a “not to exceed test” distance required to apply the modular approach. Instead of the typical zero gap tablet edge test requirement between the edge of a tablet and the user, when an antenna has been tested at ≤ 5 mm according to the modular approach it can be incorporated into tablets with at least twice the tested distance from the outer housing of the tablet edge; otherwise, the tablet edge zero gap test requirement applies. When the dedicated host approach is applied, the back surface and edges of the tablet should be tested for SAR compliance with the tablet touching the phantom.

7. RF Output Power

7.1. Maximum Tune-up Limit

Band	Mode	The Tune-up Maximum Power (Customer Declared)(dBm)	Range	Measured Maximum Output Power(dBm)
WLAN 2.4G	802.11b	13±1	12~14	13.9
	802.11g	11±1	10~12	11.5
	802.11n(HT20)	11±1	10~12	11.2
	802.11n(HT40)	10±1	9~11	10.9
WLAN 5.2G	802.11a	10±1	9~11	10.7
	802.11n(HT20)	10±1	9~11	10.5
	802.11n(HT40)	10±1	9~11	10.7
	802.11ac(VHT20)	9±1	8~10	9.5
	802.11ac(VHT40)	10±1	9~11	10.3
WLAN 5.8G	802.11a	10.5±1	9.5~11.5	11.1
	802.11n(HT20)	10.5±1	9.5~11.5	11.0
	802.11n(HT40)	10.5±1	9.5~11.5	10.6
	802.11ac(VHT20)	10.5±1	9.5~11.5	11.2
	802.11ac(VHT40)	10.5±1	9.5~11.5	10.5
Bluetooth	BR	4±1	3~5	4.13
	EDR	3±1	2~4	3.51
	BLE	4±1	3~5	4.14

7.2. WLAN Output Power

Mode	Channel	Frequency (MHz)	Tune-up	Output Power (dBm)
802.11b	1	2412	14.0	13.1
	6	2437	14.0	13.9
	11	2462	14.0	13.9
802.11g	1	2412	12.0	11.5
	6	2437	12.0	11.1
	11	2462	12.0	11.3
802.11n (HT20)	1	2412	12.0	10.9
	6	2437	12.0	11.1
	11	2462	12.0	11.2
802.11n (HT40)	3	2422	11.0	10.8
	6	2437	11.0	10.7
	9	2452	11.0	10.9
802.11a	36	5180	11.0	9.3

	40	5200	11.0	10.1
	48	5240	11.0	10.7
	149	5745	11.5	11.1
	157	5785	11.5	10.9
	165	5825	11.5	10.9
802.11n (HT20)	36	5180	11.0	9.7
	40	5200	11.0	10.0
	48	5240	11.0	10.5
	149	5745	11.5	10.4
	157	5785	11.5	10.9
	165	5825	11.5	11.0
802.11n (HT40)	38	5190	11.0	9.7
	46	5230	11.0	10.7
	151	5755	11.5	10.6
	159	5795	11.5	10.5
802.11n (VHT20)	36	5180	10.0	8.8
	40	5200	10.0	9.1
	48	5240	10.0	9.5
	149	5745	11.5	10.9
	157	5785	11.5	11.2
	165	5825	11.5	11.1
802.11n (VHT40)	38	5190	11.0	9.5
	46	5230	11.0	10.3
	151	5755	11.5	9.8
	159	5795	11.5	10.5

7.3. Bluetooth Output Power

BR+EDR	Data Rates	Output Power (dBm)			
		Tune-up	Channel		
			0	39	78
	1M	5.00	3.53	4.13	3.97
	2M	4.00	2.37	3.04	3.22
	3M	4.00	2.76	3.41	3.51

BLE	Channel	Tune-up	Output Power (dBm)
	0	5.00	3.41
	19	5.00	4.14
	39	5.00	4.07

8. Antenna Location

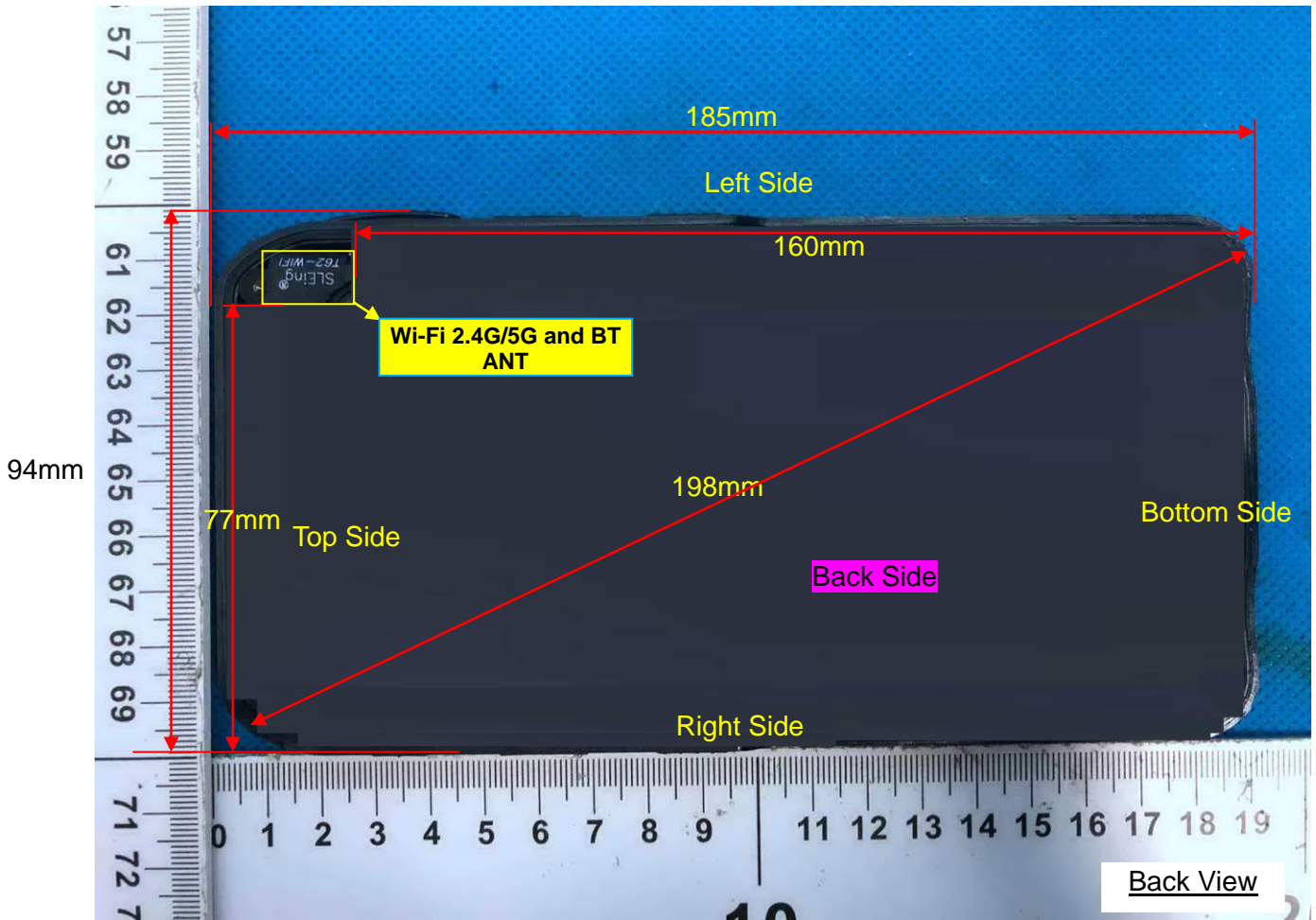

Distance of the Antenna to the EUT surface/edge						
Antennas	Front Side	Back Side	Left Side	Right Side	Top Side	Bottom Side
Bluetooth & WLAN ANT	10mm	5mm	5mm	77mm	12mm	160mm

Positions for SAR tests		
Test separation distances ≤ 50 mm		
Exposure Positions	Tune-up Maximum power of WLAN 2.4G	
	14dBm	
Front Side	Antenna to user(mm)	10
	SAR exclusion threshold	3.9
	SAR testing required?	YES
Back Side	Antenna to user(mm)	5
	SAR exclusion threshold	7.9
	SAR testing required?	YES
Left Side	Antenna to user(mm)	5
	SAR exclusion threshold	7.9
	SAR testing required?	YES
Top Side	Antenna to user(mm)	12
	SAR exclusion threshold	3.3
	SAR testing required?	YES
Exposure Positions	Tune-up Maximum power of WLAN 5.2G	
	11dBm	
Front Side	Antenna to user(mm)	10
	SAR exclusion threshold	2.9
	SAR testing required?	NO
Back Side	Antenna to user(mm)	5
	SAR exclusion threshold	5.8
	SAR testing required?	YES
Left Side	Antenna to user(mm)	5
	SAR exclusion threshold	5.8
	SAR testing required?	YES
Top Side	Antenna to user(mm)	12
	SAR exclusion threshold	2.4
	SAR testing required?	NO
Exposure Positions	Tune-up Maximum power of WLAN 5.8G	
	11.5dBm	
Front Side	Antenna to user(mm)	10
	SAR exclusion threshold	3.4
	SAR testing required?	YES
Back Side	Antenna to user(mm)	5
	SAR exclusion threshold	6.8
	SAR testing required?	YES

Left Side	Antenna to user(mm)	5
	SAR exclusion threshold	6.8
	SAR testing required?	YES
Top Side	Antenna to user(mm)	12
	SAR exclusion threshold	2.8
	SAR testing required?	NO

NOTE: Refer to section 4.3.1 of KDB 447498 D01.

Positions for SAR tests		
Test separation distances > 50 mm		
Exposure Positions	Tune-up Maximum power of WLAN 2.4G	
	14dBm	25mW
Right Side	Antenna to user(mm)	77
	SAR exclusion threshold(mW)	366
	SAR testing required?	NO
Bottom Side	Antenna to user(mm)	160
	SAR exclusion threshold(mW)	1196
	SAR testing required?	NO
Exposure Positions	Tune-up Maximum power of WLAN 5.2G	
	11dBm	13mW
Right Side	Antenna to user(mm)	77
	SAR exclusion threshold(mW)	335
	SAR testing required?	NO
Bottom Side	Antenna to user(mm)	160
	SAR exclusion threshold(mW)	1165
	SAR testing required?	NO
Exposure Positions	Tune-up Maximum power of WLAN 5.8G	
	11.5dBm	14mW
Right Side	Antenna to user(mm)	77
	SAR exclusion threshold(mW)	332
	SAR testing required?	NO
Bottom Side	Antenna to user(mm)	160
	SAR exclusion threshold(mW)	1162
	SAR testing required?	NO

NOTE: Refer to section 4.3.1 of KDB 447498 D01.

9. Stand-alone SAR test exclusion

Refer to FCC KDB 447498D01, the 1-g SAR and 10-g SAR test exclusion thresholds for 100 MHz to 6 GHz at test separation distances ≤ 50 mm are determined by:

$[(\text{max. power of channel, including tune-up tolerance, mW}) / (\text{min. test separation distance, mm})] \cdot [\sqrt{f_{\text{(GHz)}}}] \leq 3.0$ for 1-g SAR and ≤ 7.5 for 10-g extremity SAR, where:

- $f_{\text{(GHz)}}$ is the RF channel transmit frequency in GHz
- Power and distance are rounded to the nearest mW and mm before calculation
- The result is rounded to one decimal place for comparison

When the minimum test separation distance is < 5 mm, a distance of 5 mm is applied to determine SAR test exclusion.

Mode	P_{max} (dBm)	P_{max} (mW)	Distance (mm)	f (GHz)	Calculation Result	SAR Exclusion threshold	SAR test exclusion
Bluetooth	5.00	3.16	5	2.480	1.0	3.0	Yes

NOTE: Standalone SAR test exclusion for Bluetooth

When standalone SAR test exclusion applies to an antenna that transmits simultaneously with other antennas, the standalone SAR must be estimated according to following to determine simultaneous transmission SAR test exclusion:

$[(\text{max. power of channel, including tune-up tolerance, mW}) / (\text{min. test separation distance, mm})] \cdot [\sqrt{f_{\text{(GHz)}}/x}] \text{ W/kg}$ for test separation distances ≤ 50 mm, where $x = 7.5$ for 1-g SAR and $x = 18.75$ for 10-g SAR.

When the minimum test separation distance is < 5 mm, a distance of 5 mm is applied to determine SAR test exclusion.

Mode	Position	P_{max} (dBm)	P_{max} (mW)	Distance (mm)	f (GHz)	x	Estimated SAR (W/Kg)
Bluetooth	Head	5.00	3.16	5	2.480	7.5	0.133
Bluetooth	Body	5.00	3.16	5	2.480	7.5	0.133

NOTE: Estimated SAR calculation for Bluetooth

10. SAR Results

10.1. SAR measurement results

10.1.1. SAR measurement Result of WLAN 2.4G

Test Position of Head	Test channel /Freq.	Test Mode	SAR Value (W/kg)		Power Drift ($\pm 5\%$)	Conducted power (dBm)	Tune-up power (dBm)	Scaled SAR 1g (W/Kg)
			1g	10g				
Left Cheek	6/2437	802.11 b	0.192	0.122	-1.76	13.90	14.00	0.196
Left Tilt 15 Degree	6/2437	802.11 b	0.112	0.073	3.21	13.90	14.00	0.115
Right Cheek	6/2437	802.11 b	0.184	0.115	1.57	13.90	14.00	0.188
Right Tilt 15 Degree	6/2437	802.11 b	0.107	0.069	0.21	13.90	14.00	0.109

NOTE: Head SAR test results of WLAN 2.4G

Test Position of Body with 0mm	Test channel /Freq.	Test Mode	SAR Value (W/kg)		Power Drift ($\pm 5\%$)	Conducted power (dBm)	Tune-up power (dBm)	Scaled SAR 1g (W/Kg)
			1g	10g				
Front Side	6/2437	802.11b	0.556	0.287	-3.33	13.90	14.00	0.569
Back Side	6/2437	802.11b	0.241	0.141	-3.15	13.90	14.00	0.247
Left Side	6/2437	802.11b	0.861	0.385	-0.87	13.90	14.00	0.881
Top Side	6/2437	802.11b	0.342	0.175	-0.55	13.90	14.00	0.350
Left Side	1/2412	802.11b	0.815	0.373	0.70	13.10	14.00	1.003
Left Side	11/2462	802.11b	0.942	0.426	-0.79	13.90	14.00	0.964
Left Side - Repeated	11/2462	802.11b	0.931	0.418	2.10	13.90	14.00	0.953

NOTE: Body SAR test results of WLAN 2.4G

10.1.2. SAR measurement Result of WLAN 5.2G

Test Position of Head	Test channel /Freq.	Test Mode	SAR Value (W/kg)		Power Drift ($\pm 5\%$)	Conducted power (dBm)	Tune-up power (dBm)	Scaled SAR 1g (W/Kg)
			1g	10g				
Left Cheek	40/5200	802.11 a	0.103	0.063	-4.44	10.10	11.00	0.127
Left Tilt 15 Degree	40/5200	802.11 a	0.054	0.023	3.21	10.10	11.00	0.066
Right Cheek	40/5200	802.11 a	0.100	0.058	0.25	10.10	11.00	0.123

Right Tilt 15 Degree	40/5200	802.11 a	0.051	0.022	1.47	10.10	11.00	0.063
----------------------	---------	----------	-------	-------	------	-------	-------	-------

NOTE: Head SAR test results of WLAN 5.2G

Test Position of Body with 0mm	Test channel /Freq.	Test Mode	SAR Value (W/kg)		Power Drift (±5%)	Conducted power (dBm)	Tune-up power (dBm)	Scaled SAR 1g (W/Kg)
			1g	10g				
Back Side	40/5200	802.11a	0.264	0.137	-0.61	10.10	11.00	0.325
Left Side	40/5200	802.11a	0.692	0.262	-1.72	10.10	11.00	0.851
Left Side	36/5180	802.11a	0.582	0.135	-1.72	9.30	11.00	0.861
Left Side	48/5240	802.11a	0.613	0.219	0.24	10.70	11.00	0.657

NOTE: Body SAR test results of WLAN 5.2G

10.1.3. SAR measurement Result of WLAN 5.8G

Test Position of Head	Test channel /Freq.	Test Mode	SAR Value (W/kg)		Power Drift (±5%)	Conducted power (dBm)	Tune-up power (dBm)	Scaled SAR 1g (W/Kg)
			1g	10g				
Left Cheek	157/5785	802.11 a	0.302	0.140	-1.01	10.90	11.50	0.347
Left Tilt 15 Degree	157/5785	802.11 a	0.084	0.036	3.61	10.90	11.50	0.096
Right Cheek	157/5785	802.11 a	0.294	0.135	0.54	10.90	11.50	0.338
Right Tilt 15 Degree	157/5785	802.11 a	0.081	0.033	1.52	10.90	11.50	0.093

NOTE: Head SAR test results of WLAN 5.8G

Test Position of Body with 0mm	Test channel /Freq.	Test Mode	SAR Value (W/kg)		Power Drift (±5%)	Conducted power (dBm)	Tune-up power (dBm)	Scaled SAR 1g (W/Kg)
			1g	10g				
Front Side	157/5785	802.11a	0.053	0.021	0.27	10.90	11.50	0.061
Back Side	157/5785	802.11a	0.058	0.024	0.64	10.90	11.50	0.067
Left Side	157/5785	802.11a	1.142	0.409	4.34	10.90	11.50	1.311
Left Side - Repeated	157/5785	802.11a	1.132	0.395	3.24	10.90	11.50	1.300
Left Side	149/5745	802.11a	1.113	0.386	0.61	11.10	11.50	1.220
Left Side	165/5825	802.11a	1.017	0.365	2.82	10.90	11.50	1.168

NOTE: Body SAR test results of WLAN 5.8G

11. Appendix A. Photo documentation

Refer to appendix Test Setup photo---SAR

12. Appendix B. System Check Plots

Table of contents
MEASUREMENT 1 System Performance Check - SID2450 - Head
MEASUREMENT 2 System Performance Check - SID2450 - Body
MEASUREMENT 3 System Performance Check - SID5200 - Head
MEASUREMENT 4 System Performance Check - SID5200 - Body
MEASUREMENT 5 System Performance Check - SID5800 - Head
MEASUREMENT 6 System Performance Check - SID5800 - Body

MEASUREMENT 1

A. Experimental conditions.

Area Scan	<u>dx=12mm dy=12mm, h= 5.00 mm</u>
ZoomScan	<u>7x7x7, dx=5mm dy=5mm dz=5mm</u>
Phantom	<u>Validation plane</u>
Device Position	<u>Dipole</u>
Band	<u>CW2450</u>
Channels	<u>Middle</u>
Signal	<u>CW (Crest factor: 1.0)</u>

B. SAR Measurement Results

Frequency (MHz)	2450.000000
Relative permittivity (real part)	40.044097
Relative permittivity (imaginary part)	13.061200
Conductivity (S/m)	1.781738
Variation (%)	0.080000

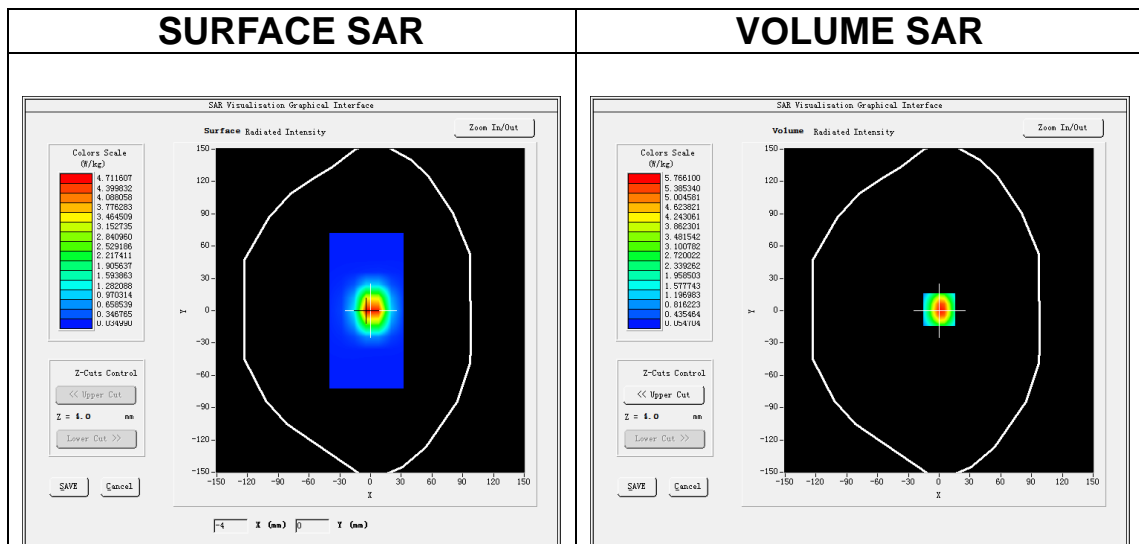

Maximum location: X=0.00, Y=1.00

SAR Peak: 10.26 W/kg

SAR 10g (W/Kg)	2.383467
SAR 1g (W/Kg)	5.430825

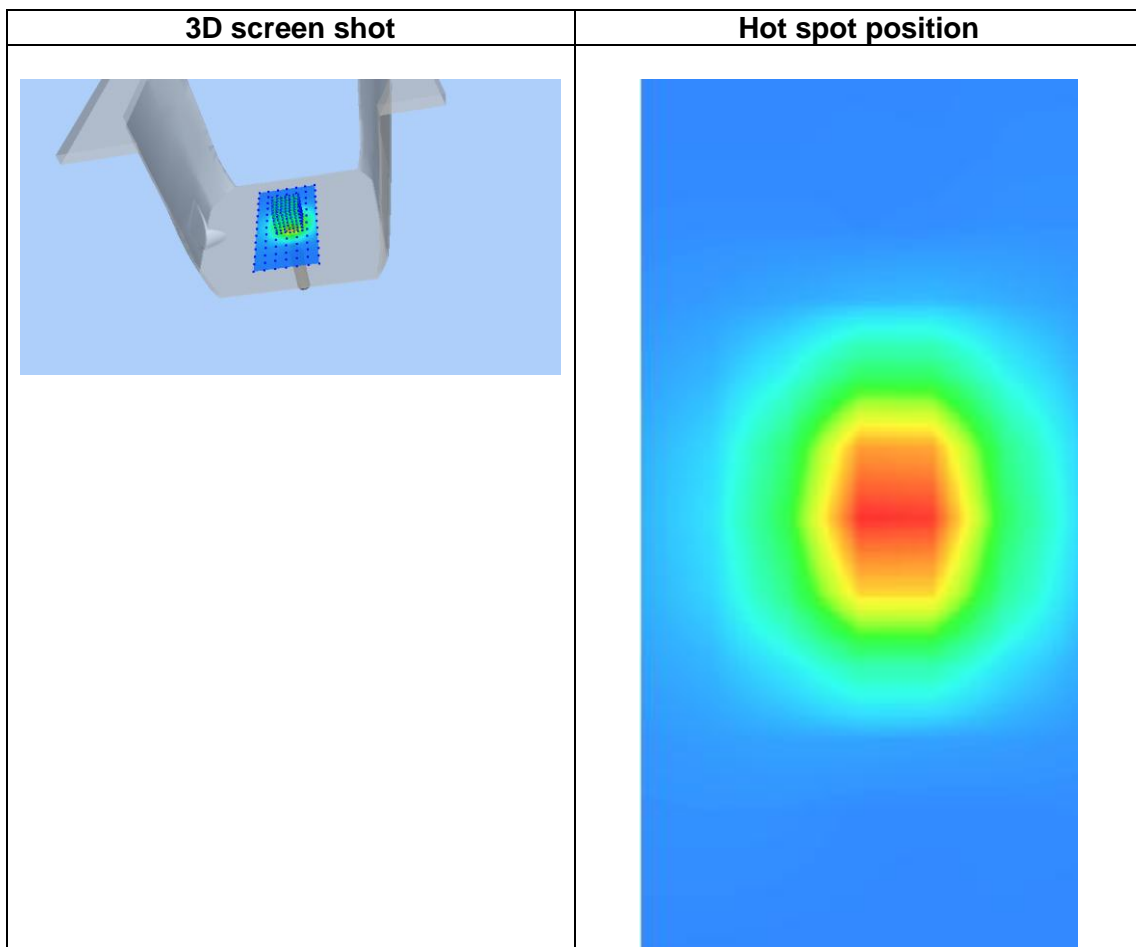
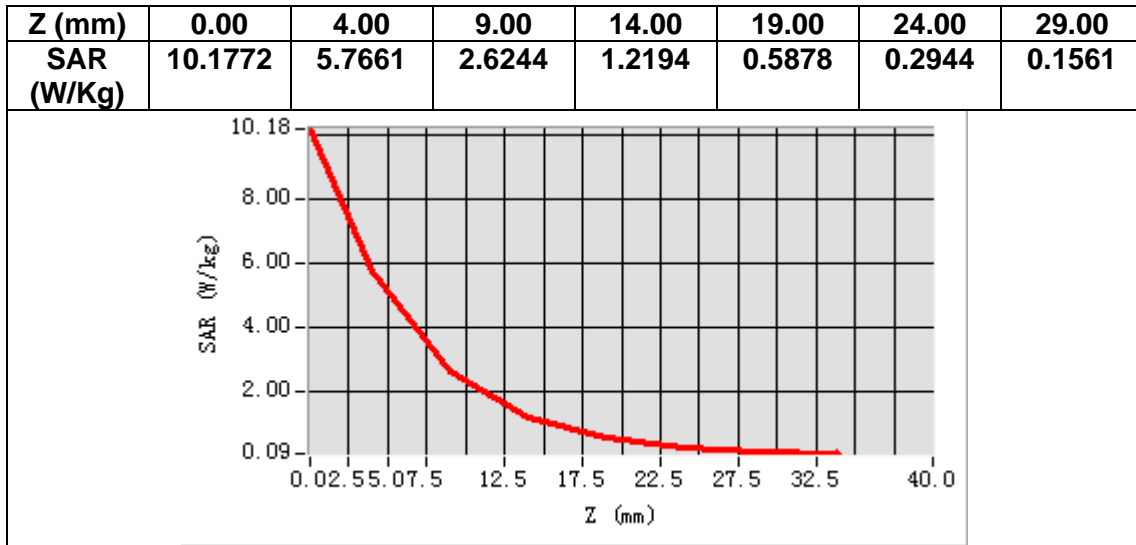

MEASUREMENT 2

A. Experimental conditions.

Area Scan	<u>dx=12mm dy=12mm, h= 5.00 mm</u>
ZoomScan	<u>7x7x7, dx=5mm dy=5mm dz=5mm</u>
Phantom	<u>Validation plane</u>
Device Position	<u>Dipole</u>
Band	<u>CW2450</u>
Channels	<u>Middle</u>
Signal	<u>CW (Crest factor: 1.0)</u>

B. SAR Measurement Results

Frequency (MHz)	2450.000000
Relative permittivity (real part)	52.734097
Relative permittivity (imaginary part)	14.531352
Conductivity (S/m)	1.976738
Variation (%)	-0.300000

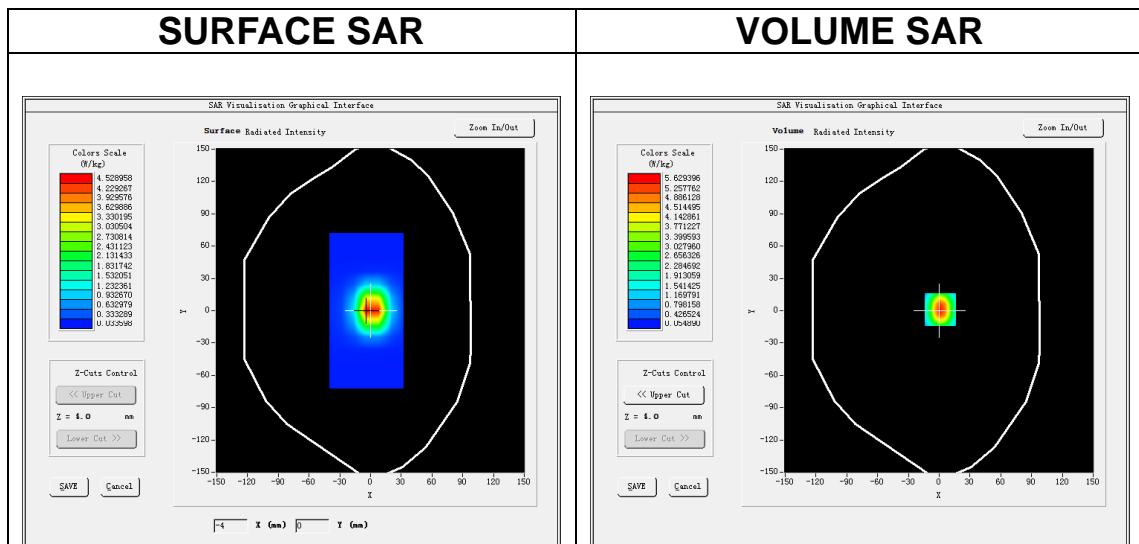

Maximum location: X=1.00, Y=1.00

SAR Peak: 9.81 W/kg

SAR 10g (W/Kg)	2.300919
SAR 1g (W/Kg)	5.198616

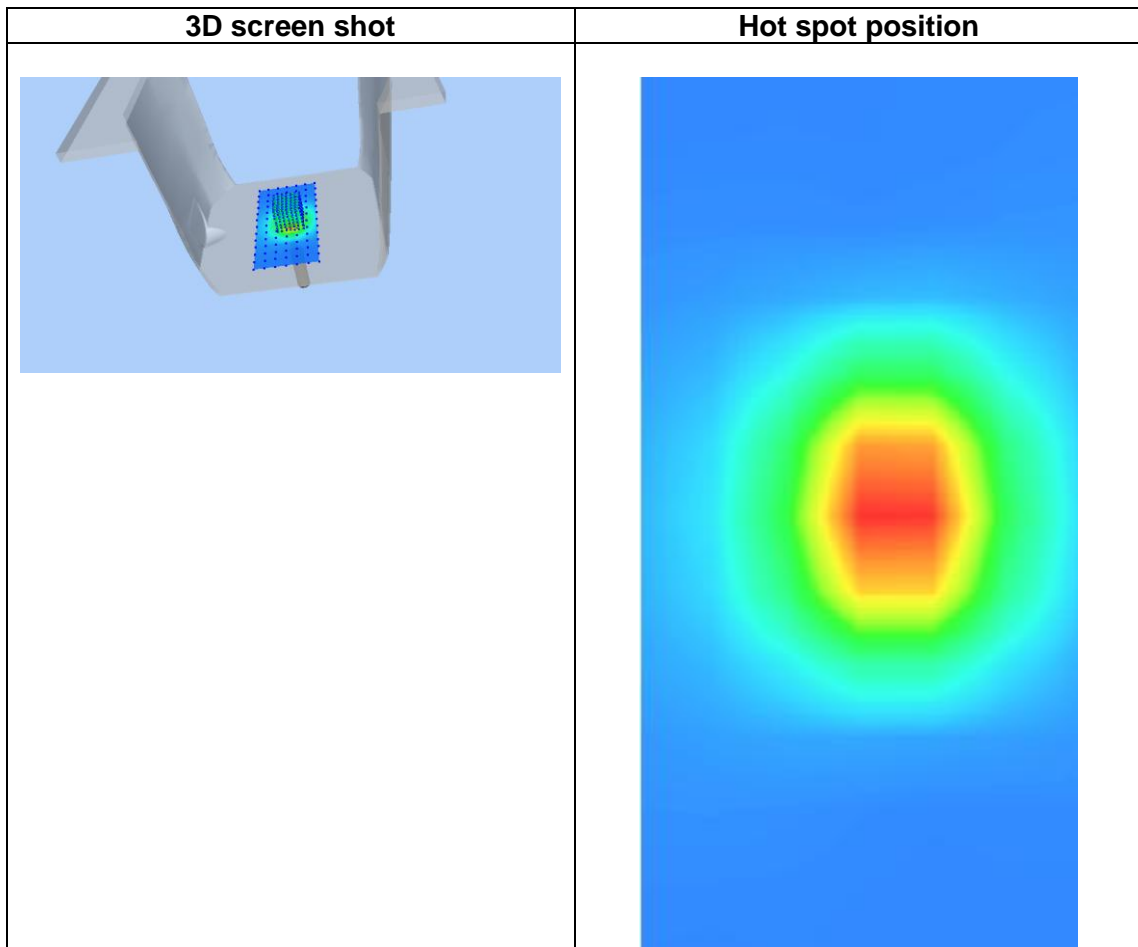
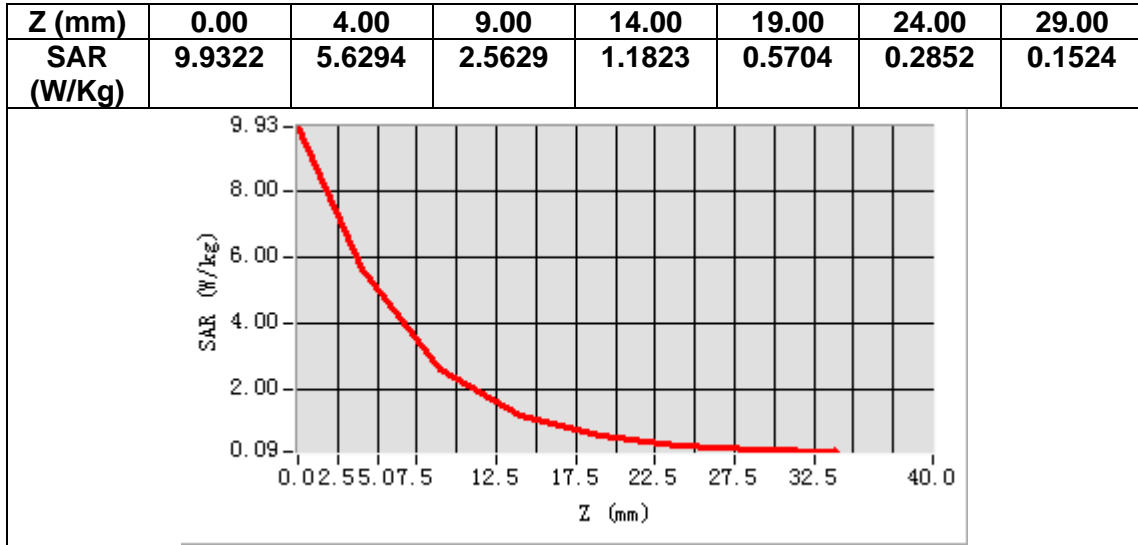

MEASUREMENT 3

A. Experimental conditions.

Area Scan	<u>dx=10mm dy=10mm, h= 2.00 mm</u>
ZoomScan	<u>7x7x12,dx=4mm dy=4mm dz=2mm</u>
Phantom	<u>Validation plane</u>
Device Position	<u>Dipole</u>
Band	<u>CW5200</u>
Channels	<u>Middle</u>
Signal	<u>CW (Crest factor: 1.0)</u>

B. SAR Measurement Results

Frequency (MHz)	5200.000000
Relative permittivity (real part)	35.971227
Relative permittivity (imaginary part)	15.980219
Conductivity (S/m)	4.621470
Variation (%)	-0.770000

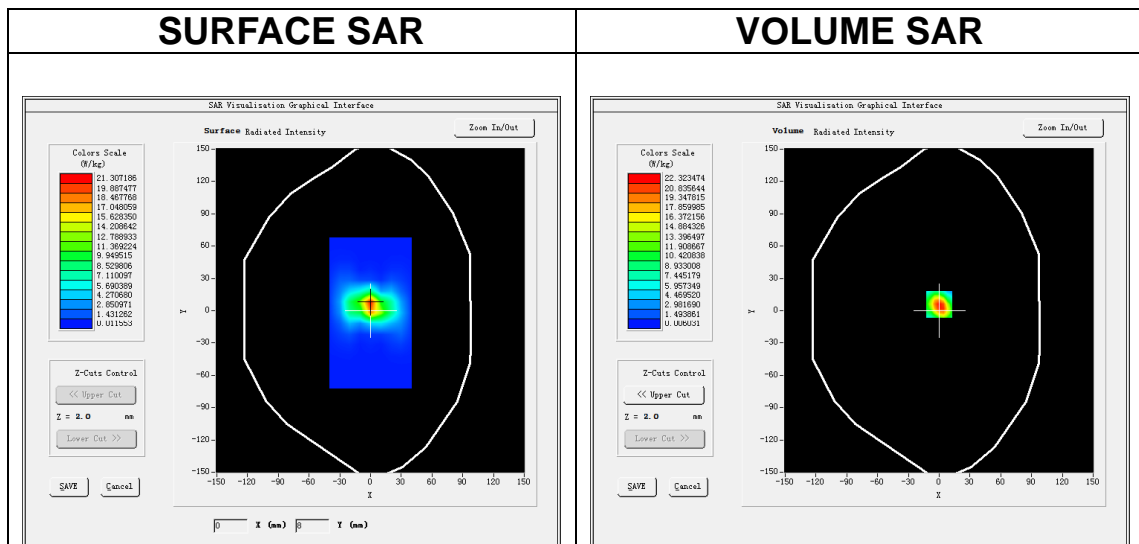

Maximum location: X=0.00, Y=6.00

SAR Peak: 40.06 W/kg

SAR 10g (W/Kg)	5.423511
SAR 1g (W/Kg)	15.233527

Z (m)	0.00	2.00	4.00	6.00	8.00	10.00	12.00	14.00	16.00	18.00	20.00	22.00
SAR (W/Kg)	37.8365	22.3232	11.3793	5.6683	2.8232	1.4096	0.7129	0.3648	0.1856	0.1003	0.0541	0.0320

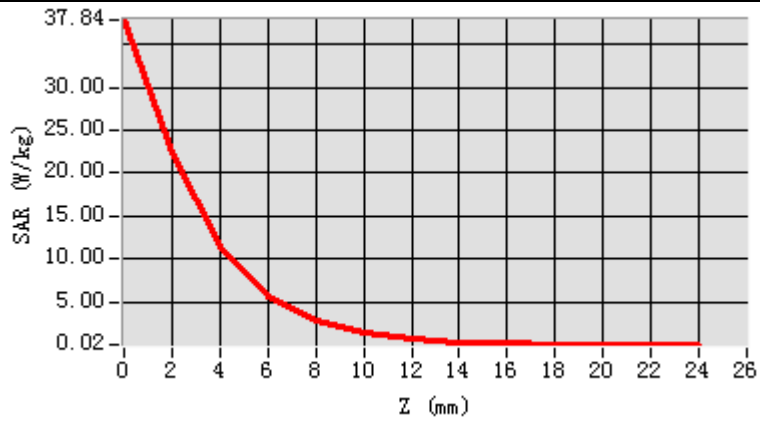

3D screen shot

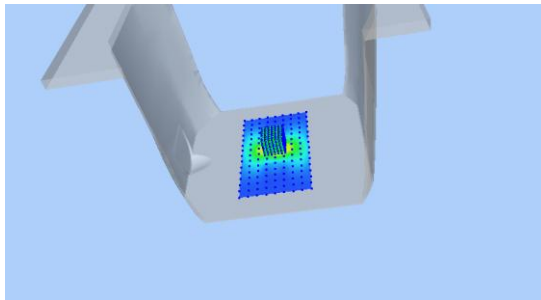

Hot spot position

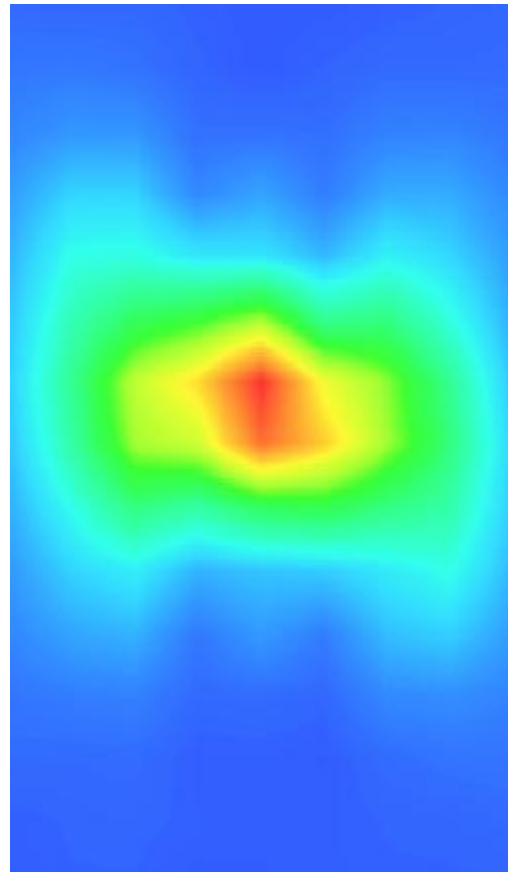

MEASUREMENT 4

A. Experimental conditions.

Area Scan	<u>dx=10mm dy=10mm, h= 2.00 mm</u>
ZoomScan	<u>7x7x12,dx=4mm dy=4mm dz=2mm</u>
Phantom	<u>Validation plane</u>
Device Position	<u>Dipole</u>
Band	<u>CW5200</u>
Channels	<u>Middle</u>
Signal	<u>CW (Crest factor: 1.0)</u>

B. SAR Measurement Results

Frequency (MHz)	5200.000000
Relative permittivity (real part)	49.915247
Relative permittivity (imaginary part)	18.231720
Conductivity (S/m)	5.274270
Variation (%)	-0.880000

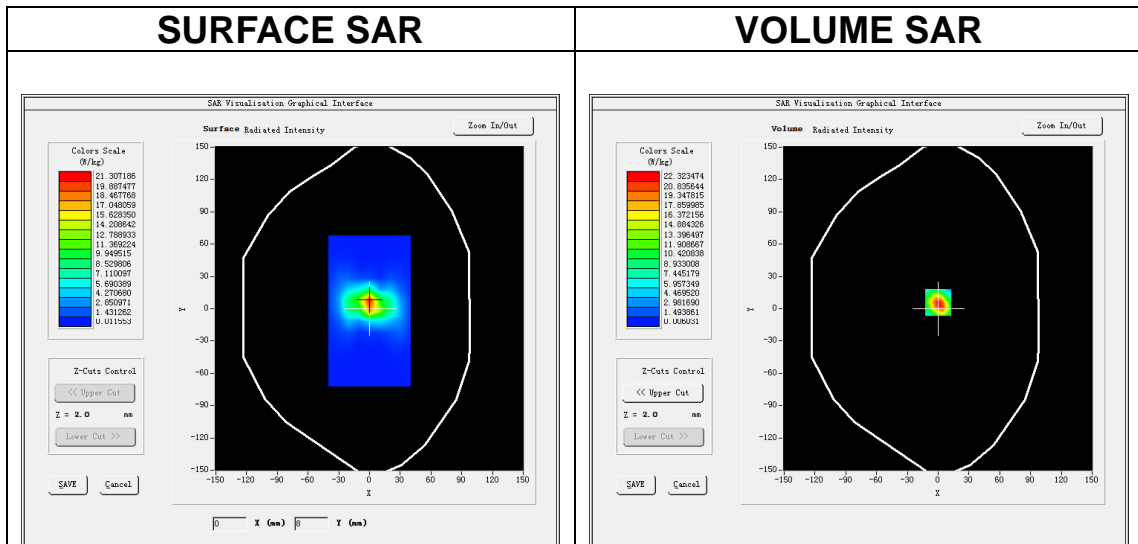

Maximum location: X=0.00, Y=6.00

SAR Peak: 40.06 W/kg

SAR 10g (W/Kg)	5.712868
SAR 1g (W/Kg)	15.912320

Z (m m)	0.00	2.00	4.00	6.00	8.00	10.0 0	12.0 0	14.0 0	16.0 0	18.0 0	20.0 0	22.0 0
SAR R (W/ Kg)	37.8 359	22.3 235	11.3 794	5.66 83	2.82 31	1.40 96	0.71 33	0.36 50	0.18 59	0.10 11	0.05 42	0.03 17

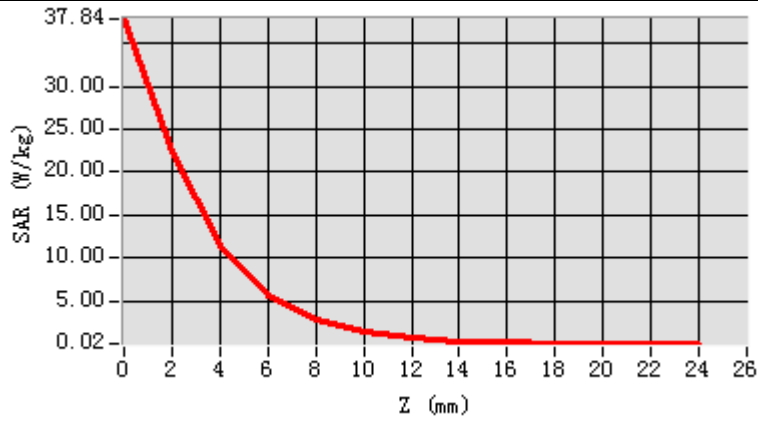

3D screen shot

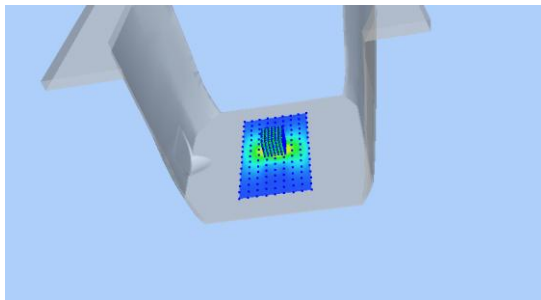

Hot spot position

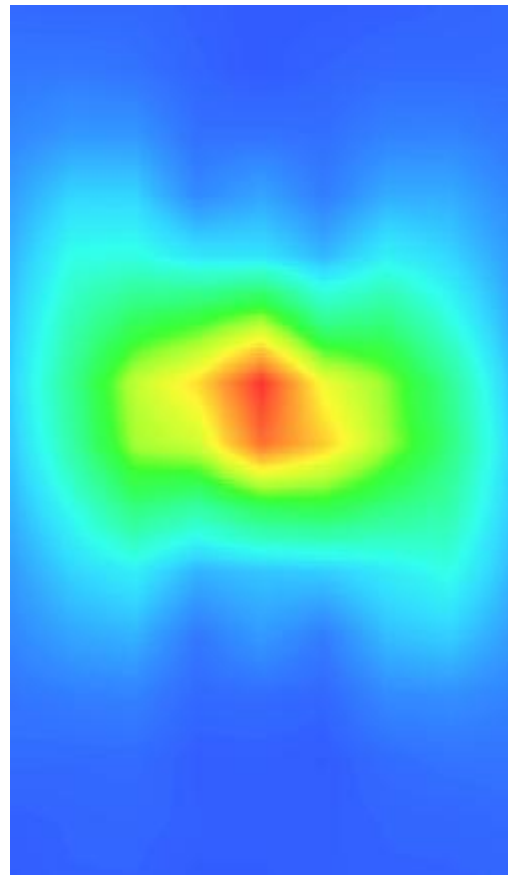

MEASUREMENT 5

A. Experimental conditions.

Area Scan	<u>dx=10mm dy=10mm, h= 2.00 mm</u>
ZoomScan	<u>7x7x12,dx=4mm dy=4mm dz=2mm</u>
Phantom	<u>Validation plane</u>
Device Position	<u>Dipole</u>
Band	<u>CW5800</u>
Channels	<u>Middle</u>
Signal	<u>CW (Crest factor: 1.0)</u>

B. SAR Measurement Results

Frequency (MHz)	5800.000000
Relative permittivity (real part)	34.840237
Relative permittivity (imaginary part)	16.110702
Conductivity (S/m)	5.194270
Variation (%)	-0.500000

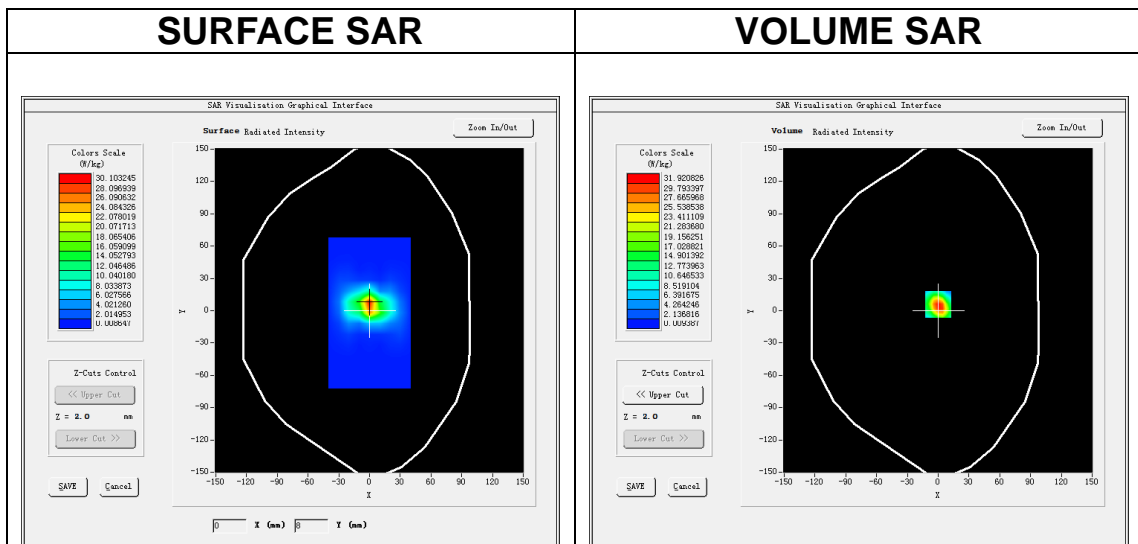

Maximum location: X=0.00, Y=6.00

SAR Peak: 57.37 W/kg

SAR 10g (W/Kg)	6.132474
SAR 1g (W/Kg)	17.936772

Z (m m)	0.00	2.00	4.00	6.00	8.00	10.00	12.00	14.00	16.00	18.00	20.00	22.00
SAR (W/Kg)	54.0379	31.9209	16.1705	8.1718	4.0859	2.0546	1.0342	0.5168	0.2765	0.1561	0.0790	0.0457

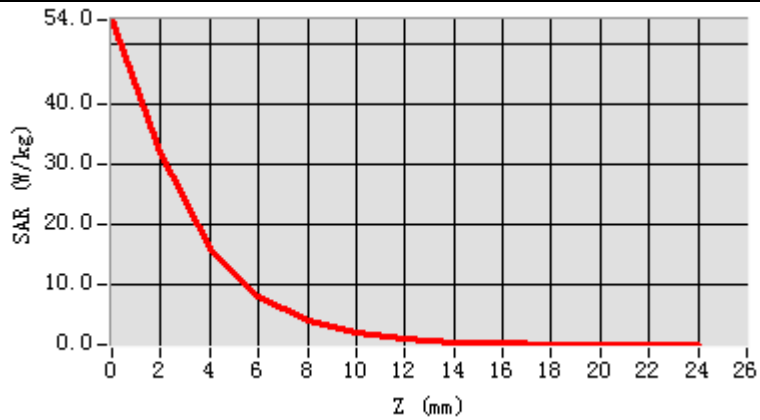

3D screen shot

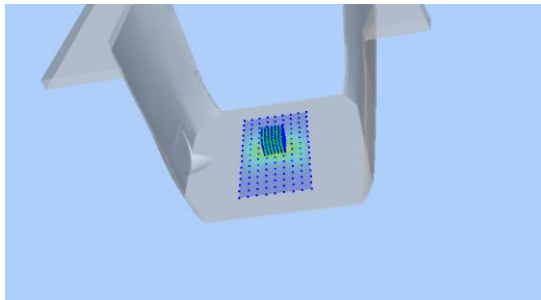

Hot spot position

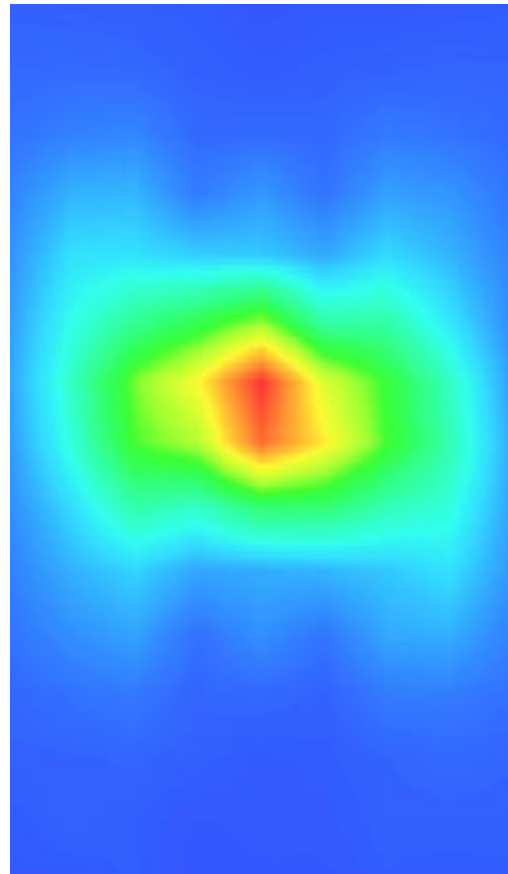

MEASUREMENT 6

A. Experimental conditions.

Area Scan	<u>dx=10mm dy=10mm, h= 2.00 mm</u>
ZoomScan	<u>7x7x12,dx=4mm dy=4mm dz=2mm</u>
Phantom	<u>Validation plane</u>
Device Position	<u>Dipole</u>
Band	<u>CW5800</u>
Channels	<u>Middle</u>
Signal	<u>CW (Crest factor: 1.0)</u>

B. SAR Measurement Results

Frequency (MHz)	5800.000000
Relative permittivity (real part)	48.592237
Relative permittivity (imaginary part)	18.721700
Conductivity (S/m)	6.034251
Variation (%)	-0.590000

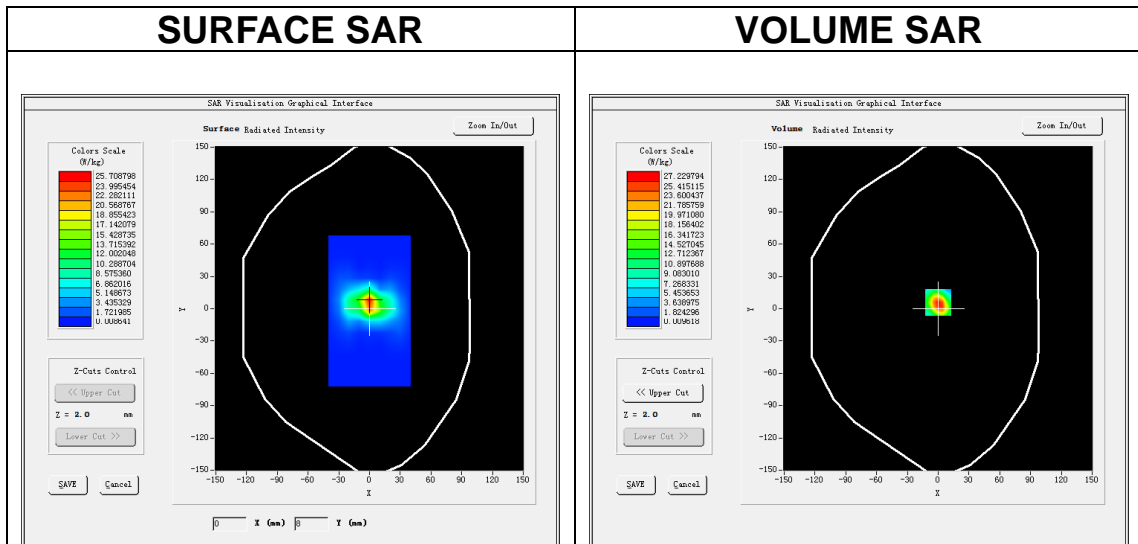

Maximum location: X=0.00, Y=6.00

SAR Peak: 48.83 W/kg

SAR 10g (W/Kg)	5.517260
SAR 1g (W/Kg)	15.813721

Z (m m)	0.00	2.00	4.00	6.00	8.00	10.0 0	12.0 0	14.0 0	16.0 0	18.0 0	20.0 0	22.0 0
SAR (W/ Kg)	45.9 893	27.2 298	13.8 530	7.02 92	3.56 34	1.78 59	0.90 65	0.45 70	0.24 66	0.13 26	0.06 93	0.05 01

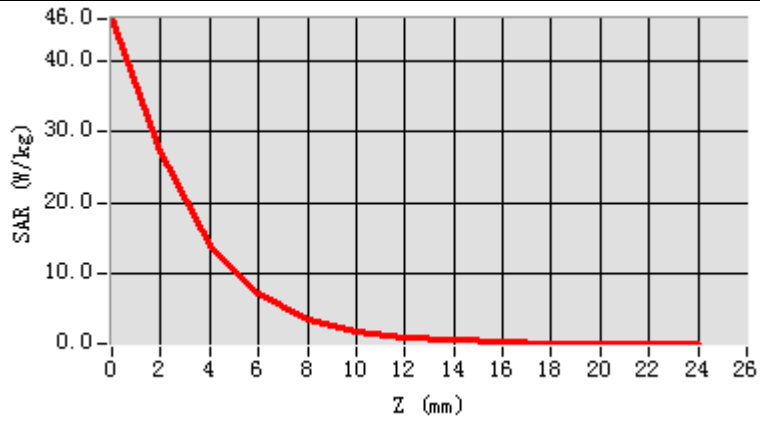

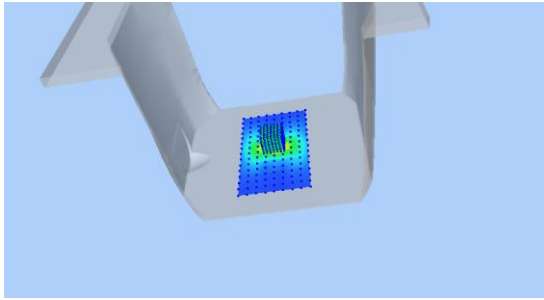
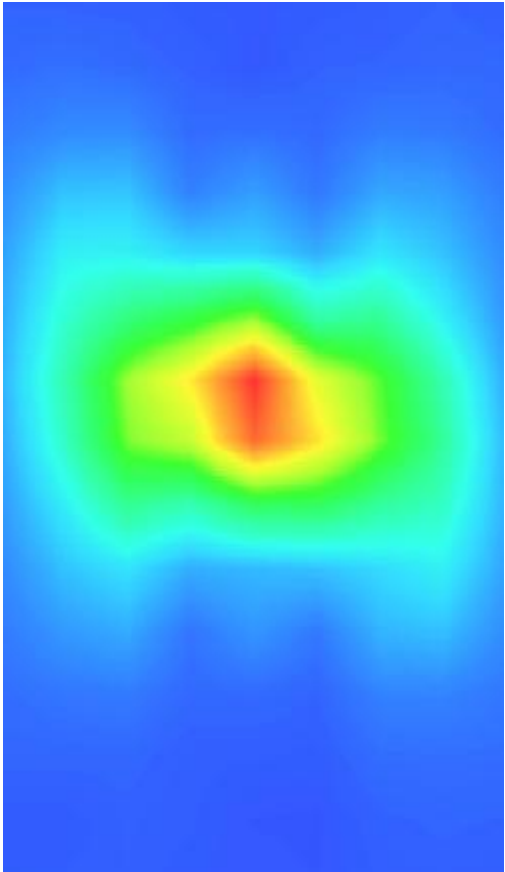
3D screen shot	Hot spot position
	

13. Appendix C. Plots of High SAR Measurement

Table of contents
MEASUREMENT 1 WLAN 5.2G Head
MEASUREMENT 2 WLAN 5.8G Head
MEASUREMENT 3 WLAN 5.2G Body
MEASUREMENT 4 WLAN 5.8G Body
MEASUREMENT 5 WLAN 2.4G Head
MEASUREMENT 6 WLAN 2.4G Body

MEASUREMENT 1

A. Experimental conditions.

Area Scan	<u>dx=10mm dy=10mm, h= 2.00 mm</u>
ZoomScan	<u>7x7x12,dx=4mm dy=4mm dz=2mm</u>
Phantom	<u>Left head</u>
Device Position	<u>Cheek</u>
Band	<u>IEEE 802.11a U-NII</u>
Channels	<u>Middle</u>
Signal	<u>IEEE802.11a (Crest factor: 1.0)</u>

B. SAR Measurement Results

Frequency (MHz)	5200.000000
Relative permittivity (real part)	35.972980
Relative permittivity (imaginary part)	15.981619
Conductivity (S/m)	4.616912
Variation (%)	-4.440000

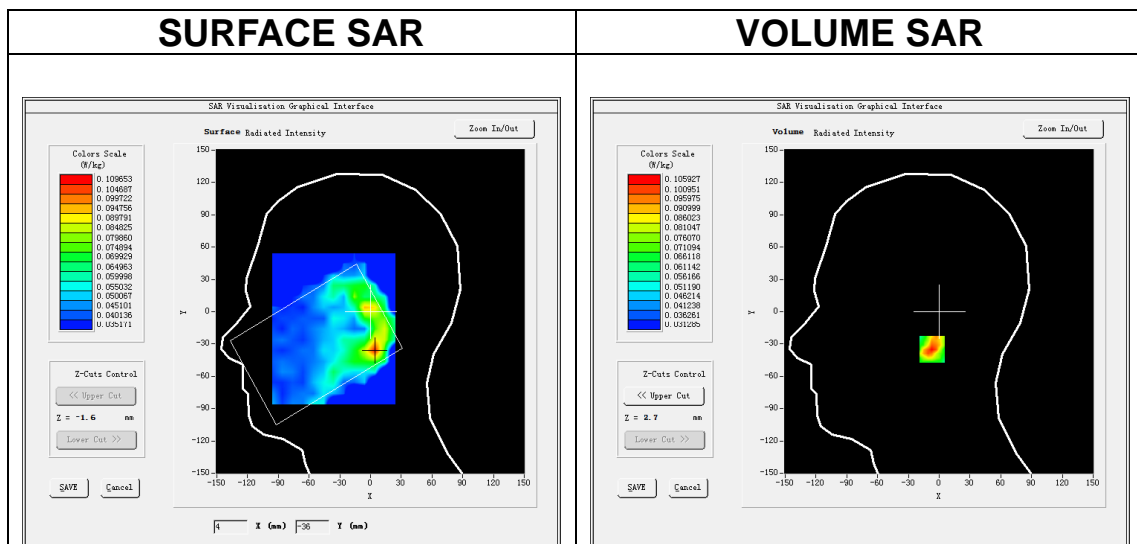

Maximum location: X=5.00, Y=-35.00

SAR Peak: 0.23 W/kg

SAR 10g (W/Kg)	0.063203
SAR 1g (W/Kg)	0.102987

Z (m m)	0.00	2.00	4.00	6.00	8.00	10.0	12.0	14.0	16.0	18.0	20.0	22.0
SAR (W/ Kg)	0.15 68	0.10 59	0.06 71	0.05 30	0.05 19	0.04 46	0.04 39	0.04 09	0.04 31	0.04 29	0.04 11	0.04 24

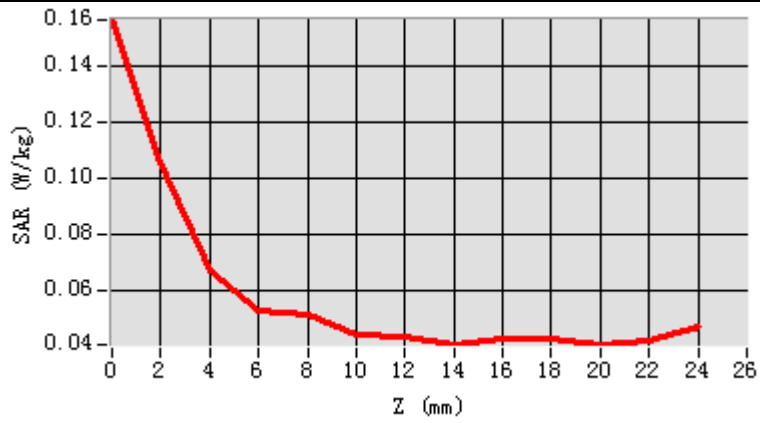

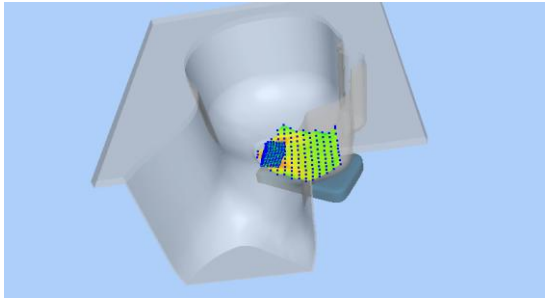
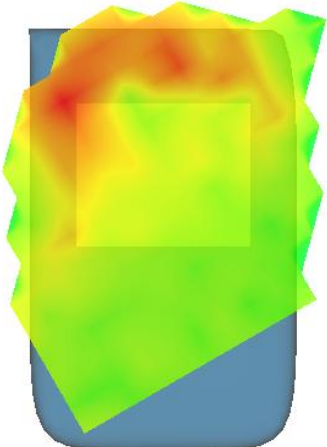
3D screen shot	Hot spot position
	

MEASUREMENT 2

A. Experimental conditions.

Area Scan	<u>dx=10mm dy=10mm, h= 2.00 mm</u>
ZoomScan	<u>7x7x12,dx=4mm dy=4mm dz=2mm</u>
Phantom	<u>Left head</u>
Device Position	<u>Cheek</u>
Band	<u>IEEE 802.11a U-NII</u>
Channels	<u>Middle</u>
Signal	<u>IEEE802.11a (Crest factor: 1.0)</u>

B. SAR Measurement Results

Frequency (MHz)	5785.000000
Relative permittivity (real part)	34.914787
Relative permittivity (imaginary part)	15.985266
Conductivity (S/m)	5.137487
Variation (%)	-1.010000

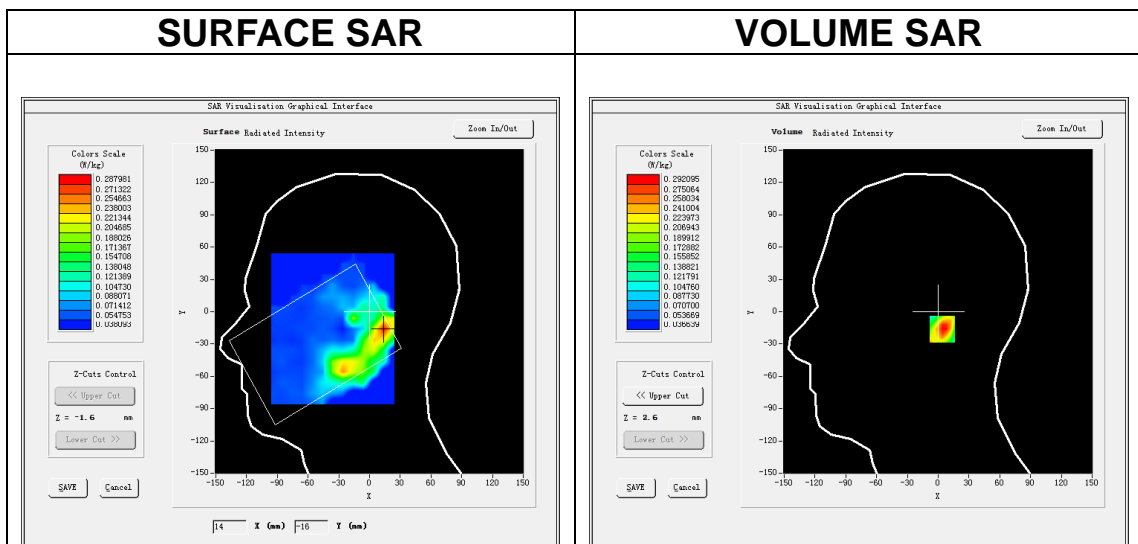

Maximum location: X=14.00, Y=-16.00

SAR Peak: 0.77 W/kg

SAR 10g (W/Kg)	0.139503
SAR 1g (W/Kg)	0.302341

Z (m m)	0.00	2.00	4.00	6.00	8.00	10.00	12.00	14.00	16.00	18.00	20.00	22.00
SAR (W/Kg)	0.4842	0.2921	0.1535	0.0947	0.0690	0.0546	0.0518	0.0500	0.0495	0.0445	0.0464	0.0477

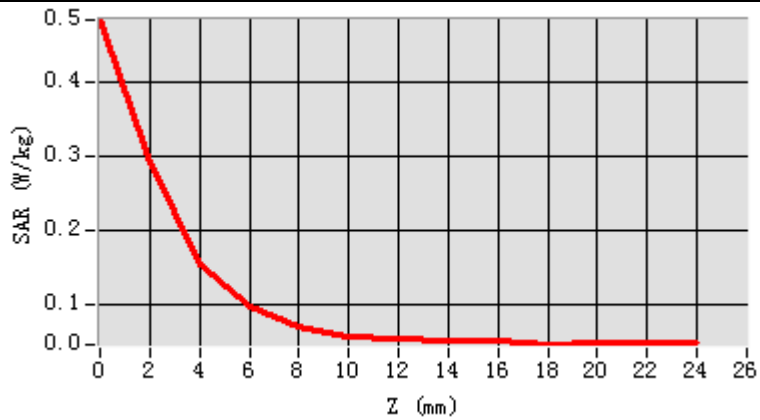

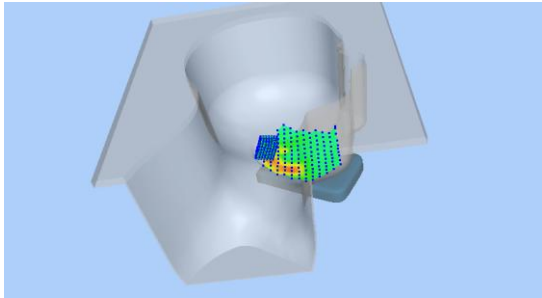
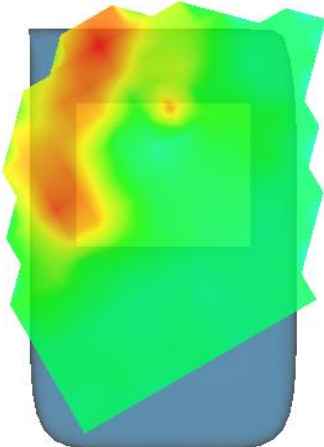
3D screen shot	Hot spot position
	

MEASUREMENT 3

A. Experimental conditions.

Area Scan	<u>dx=10mm dy=10mm, h= 2.00 mm</u>
ZoomScan	<u>7x7x12,dx=4mm dy=4mm dz=2mm</u>
Phantom	<u>Validation plane</u>
Device Position	<u>Body</u>
Band	<u>IEEE 802.11a U-NII</u>
Channels	<u>Middle</u>
Signal	<u>IEEE802.11a (Crest factor: 1.0)</u>

B. SAR Measurement Results

Frequency (MHz)	5200.000000
Relative permittivity (real part)	49.909538
Relative permittivity (imaginary part)	18.225510
Conductivity (S/m)	5.265147
Variation (%)	-1.720000

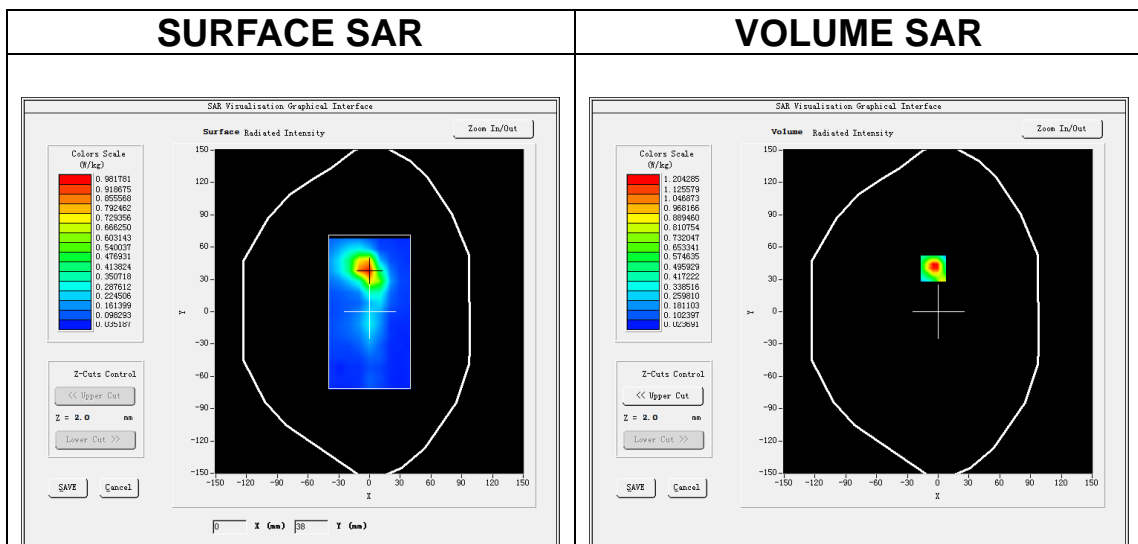

Maximum location: X=-5.00, Y=40.00

SAR Peak: 2.21 W/kg

SAR 10g (W/Kg)	0.262267
SAR 1g (W/Kg)	0.691542

Z (m m)	0.00	2.00	4.00	6.00	8.00	10.00	12.00	14.00	16.00	18.00	20.00	22.00
SAR (W/Kg)	2.0287	1.2043	0.5254	0.3489	0.1833	0.1227	0.0822	0.0695	0.0561	0.0571	0.0546	0.0458

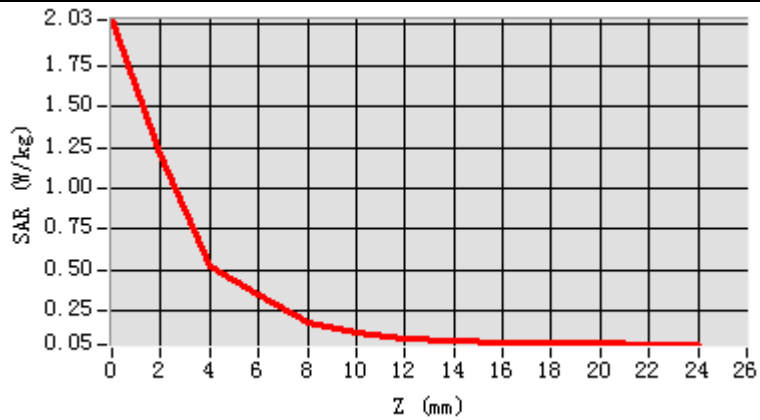

3D screen shot

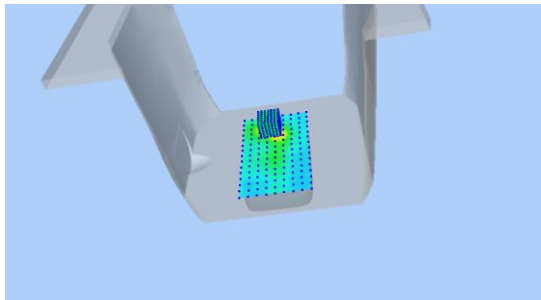

Hot spot position

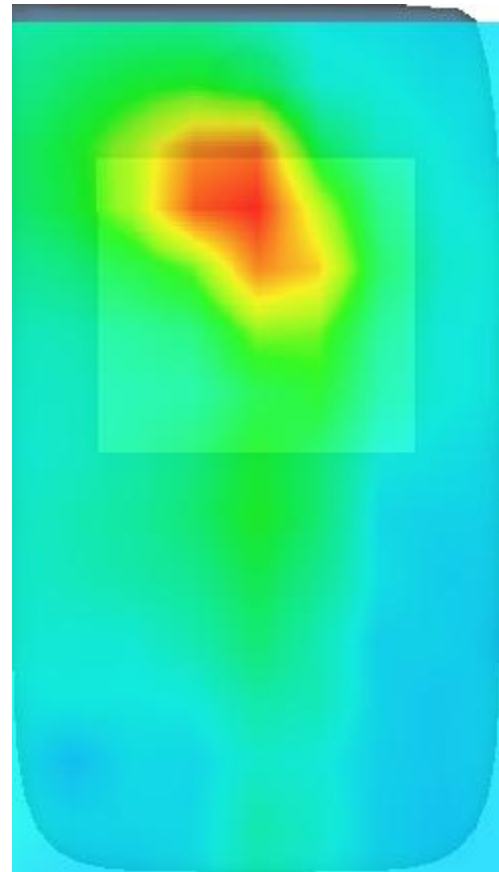

MEASUREMENT 4

A. Experimental conditions.

Area Scan	<u>dx=10mm dy=10mm, h= 2.00 mm</u>
ZoomScan	<u>7x7x12,dx=4mm dy=4mm dz=2mm</u>
Phantom	<u>Validation plane</u>
Device Position	<u>Body</u>
Band	<u>IEEE 802.11a U-NII</u>
Channels	<u>Middle</u>
Signal	<u>IEEE802.11a (Crest factor: 1.0)</u>

B. SAR Measurement Results

Frequency (MHz)	5785.000000
Relative permittivity (real part)	48.658905
Relative permittivity (imaginary part)	18.733259
Conductivity (S/m)	6.015458
Variation (%)	4.340000

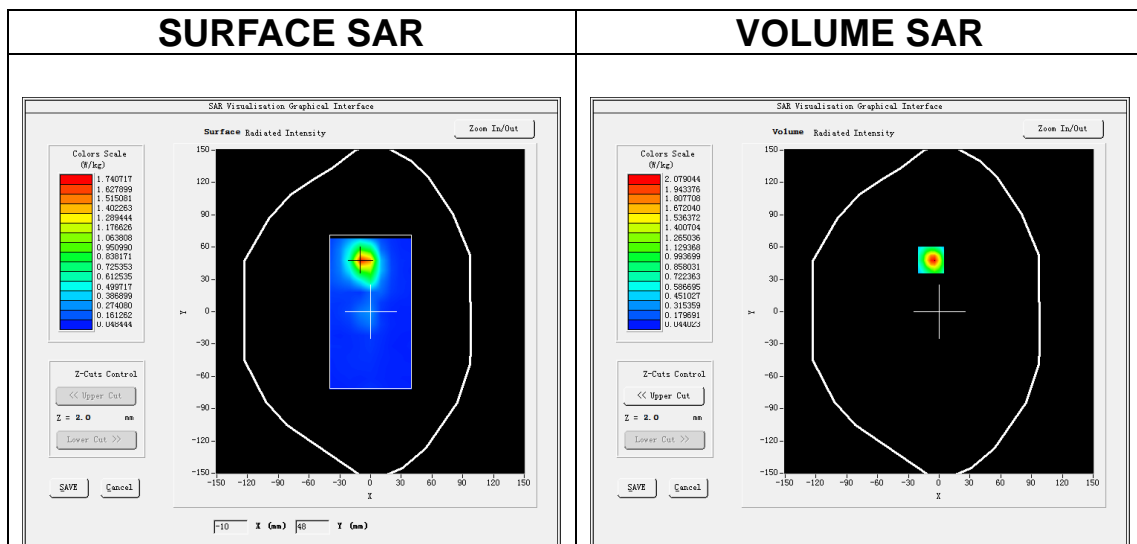

Maximum location: X=-8.00, Y=48.00

SAR Peak: 3.86 W/kg

SAR 10g (W/Kg)	0.408935
SAR 1g (W/Kg)	1.141597

Z (m m)	0.00	2.00	4.00	6.00	8.00	10.00	12.00	14.00	16.00	18.00	20.00	22.00
SAR (W/Kg)	3.6997	2.0790	0.7386	0.4591	0.2054	0.1422	0.0936	0.0701	0.0637	0.0610	0.0515	0.0613

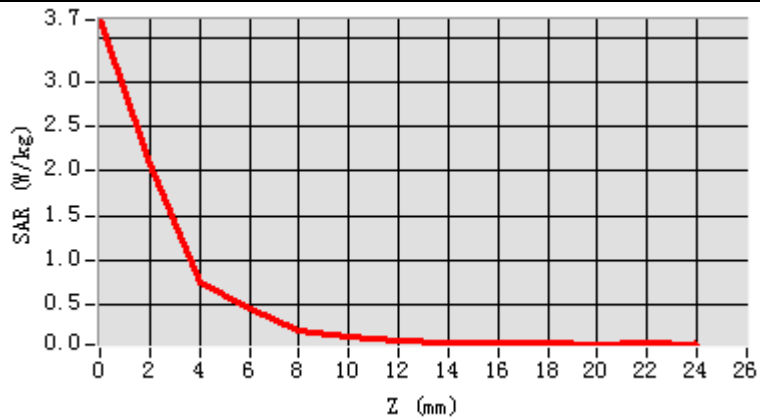

3D screen shot

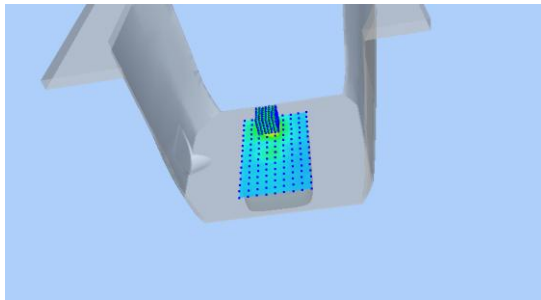

Hot spot position

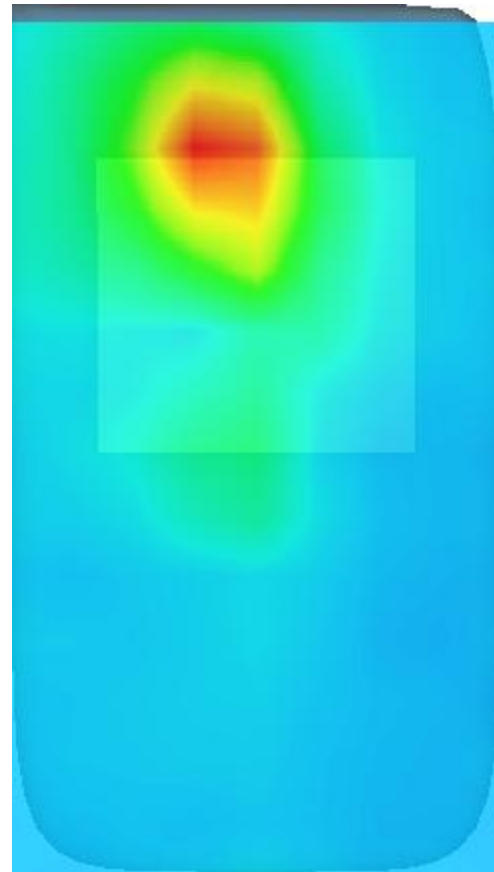

MEASUREMENT 5

A. Experimental conditions.

Area Scan	<u>dx=12mm dy=12mm, h= 5.00 mm</u>
ZoomScan	<u>7x7x7,dx=5mm dy=5mm dz=5mm</u>
Phantom	<u>Left head</u>
Device Position	<u>Cheek</u>
Band	<u>IEEE 802.11b ISM</u>
Channels	<u>Middle</u>
Signal	<u>IEEE802.11b (Crest factor: 1.0)</u>

B. SAR Measurement Results

Frequency (MHz)	2437.000000
Relative permittivity (real part)	40.091000
Relative permittivity (imaginary part)	13.020300
Conductivity (S/m)	1.762804
Variation (%)	-1.760000

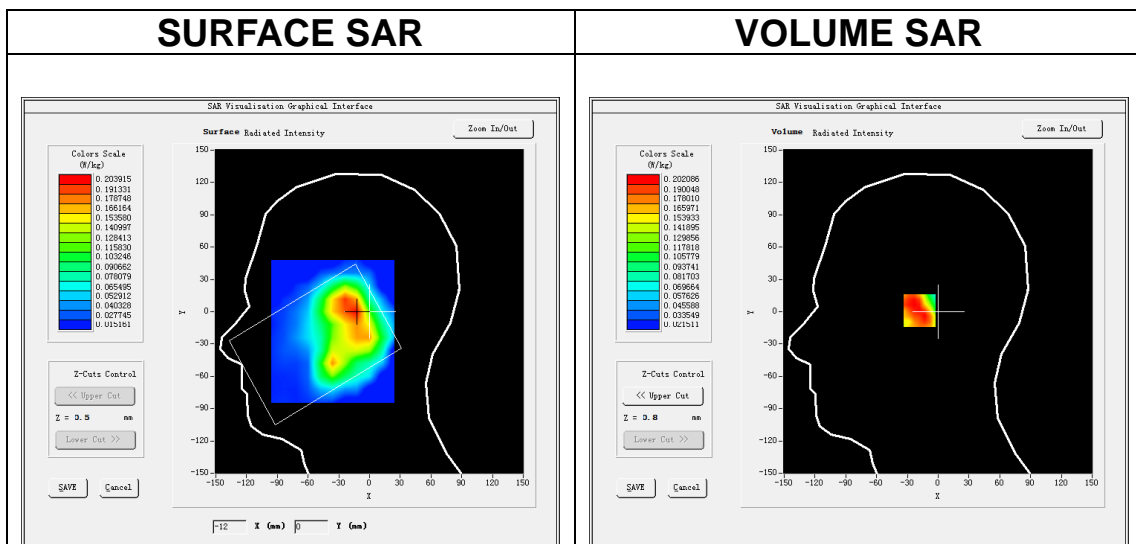

Maximum location: X=-15.00, Y=1.00

SAR Peak: 0.30 W/kg

SAR 10g (W/Kg)	0.122257
SAR 1g (W/Kg)	0.191869

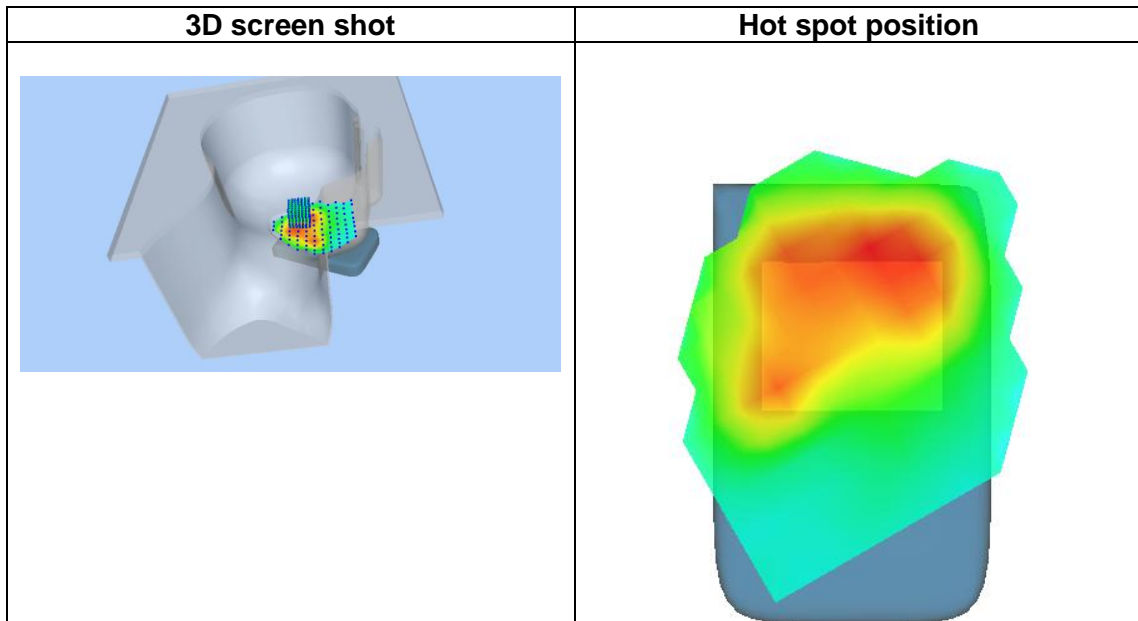
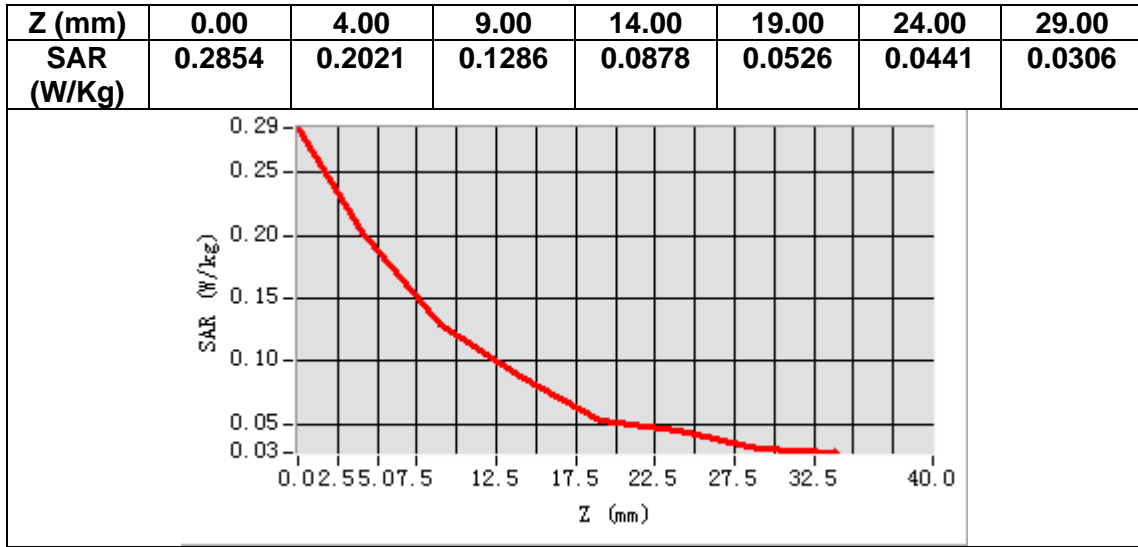

MEASUREMENT 6

A. Experimental conditions.

Area Scan	<u>dx=12mm dy=12mm, h= 5.00 mm</u>
ZoomScan	<u>7x7x7,dx=5mm dy=5mm dz=5mm</u>
Phantom	<u>Validation plane</u>
Device Position	<u>Body</u>
Band	<u>IEEE 802.11b ISM</u>
Channels	<u>High</u>
Signal	<u>IEEE802.11b (Crest factor: 1.0)</u>

B. SAR Measurement Results

Frequency (MHz)	2462.000000
Relative permittivity (real part)	52.646599
Relative permittivity (imaginary part)	14.590920
Conductivity (S/m)	1.995714
Variation (%)	-0.790000

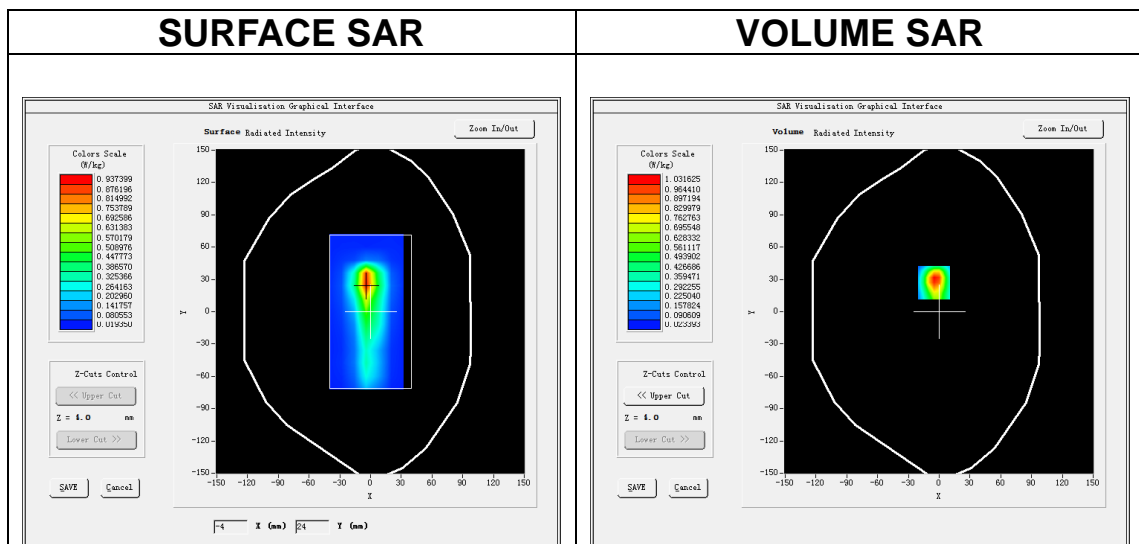

Maximum location: X=-5.00, Y=27.00

SAR Peak: 1.74 W/kg

SAR 10g (W/Kg)	0.426290
SAR 1g (W/Kg)	0.941575

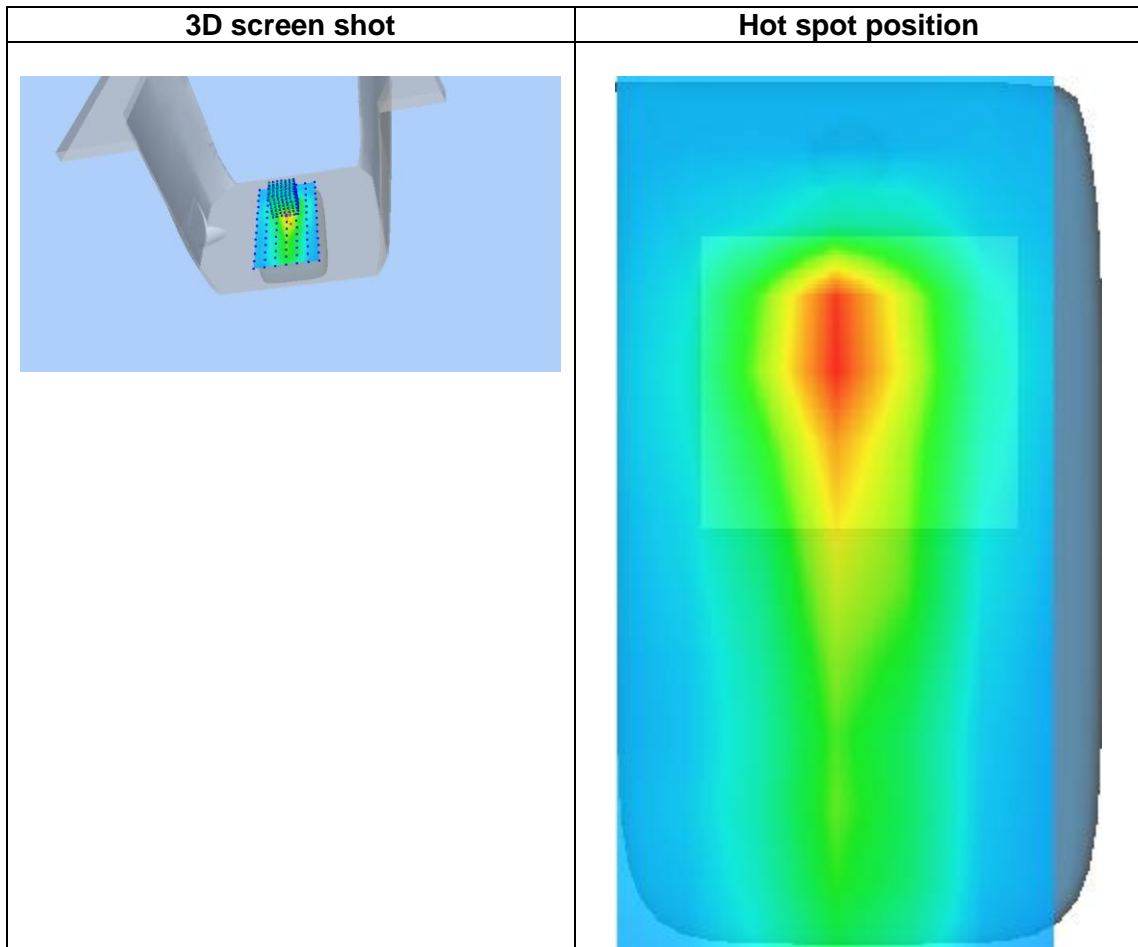
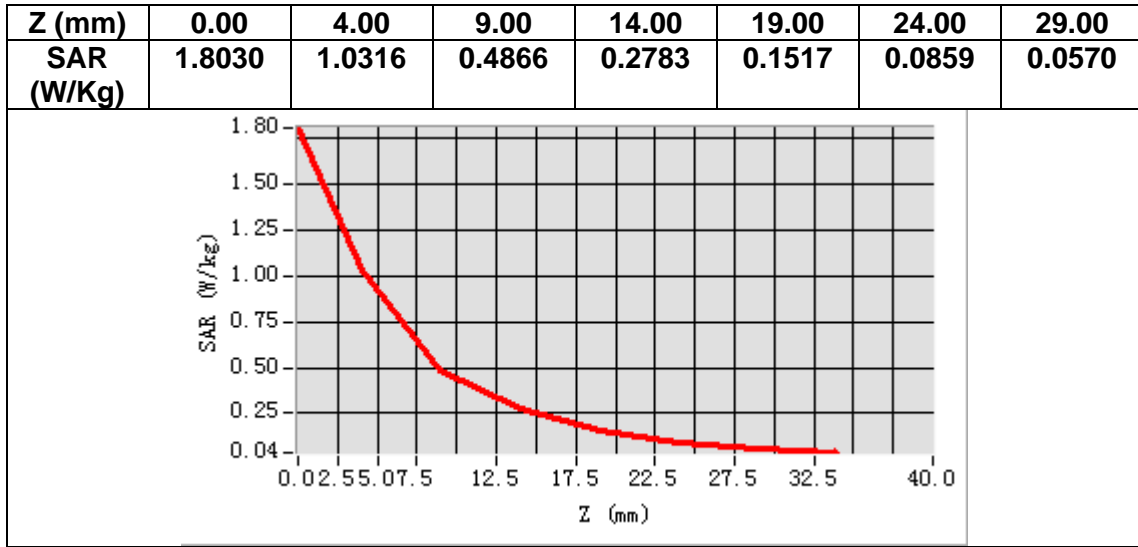

14. Appendix D. Calibration Certificate

Table of contents
E Field Probe - SN 08/16 EPGO287
2450 MHz Dipole - SN 03/15 DIP 2G450-352
5000-6000 MHz Dipole - SN 13/14 WGA 33