

FCC

CERTIFICATION TEST REPORT

For

Tablet PC

MODEL No.: xTablet A1150

FCC ID: O86A1150

Trademark: MobileDemand

REPORT NO.: ES180507073W08

ISSUE DATE: July 18, 2018

Prepared for

MobileDemand, L.C.

1501 Boyson Sq Dr, Ste 101 Hiawatha, Iowa, 52233, United States

Prepared by

EMTEK (SHENZHEN) CO., LTD.

Bldg 69, Majialong Industry Zone, Nanshan District, Shenzhen,

Guangdong, China

TEL: 86-755-26954280

FAX: 86-755-26954282

Table of Contents

1	TEST RESULT CERTIFICATION	3
2	EUT TECHNICAL DESCRIPTION.....	4
3	SUMMARY OF TEST RESULT	5
4	TEST METHODOLOGY	6
4.1	GENERAL DESCRIPTION OF APPLIED STANDARDS	6
4.2	MEASUREMENT EQUIPMENT USED.....	6
4.3	DESCRIPTION OF TEST MODES	7
5	FACILITIES AND ACCREDITATIONS	11
5.1	FACILITIES.....	11
5.2	LABORATORY ACCREDITATIONS AND LISTINGS.....	11
6	TEST SYSTEM UNCERTAINTY	12
7	SETUP OF EQUIPMENT UNDER TEST	13
7.1	RADIO FREQUENCY TEST SETUP 1	13
7.2	RADIO FREQUENCY TEST SETUP 2	13
7.3	SUPPORT EQUIPMENT	15
8	TEST REQUIREMENTS.....	16
8.1	RF POWER OUTPUT	16
8.2	EFFECTIVE (ISOTROPIC) RADIATED POWER	17
8.3	MODULATION CHARACTERISTICS	19
8.4	OCCUPIED BANDWIDTH.....	20
8.5	BAND EDGE EMISSION	22
8.6	OUT OF BAND EMISSIONS AT ANTENNA TERMINALS	23
8.7	FIELD STRENGTH OF SPURIOUS RADIATION	24
8.8	FREQUENCY STABILITY	26
8.9	PEAK TO AVERAGE RATIO.....	27
	APPENDIX A: TEST DATA FOR RF POWER OUTPUT.....	28
	APPENDIX B: TEST DATA FOR EFFECTIVE (ISOTROPIC) RADIATED POWER.....	29
	APPENDIX C: TEST DATA FOR OCCUPIED BANDWIDTH.....	30
	APPENDIX D: TEST DATA FOR BAND EDGE EMISSION.....	37
	APPENDIX E: TEST DATA FOR OUT OF BAND EMISSIONS AT ANTENNA TERMINALS.....	40
	APPENDIX F: TEST DATA FOR FIELD STRENGTH OF SPURIOUS RADIATION.....	46
	APPENDIX G: TEST DATA FOR FREQUENCY STABILITY	49
	APPENDIX H: TEST DATA FOR PEAK TO AVERAGE RATIO.....	51

1 TEST RESULT CERTIFICATION

Applicant:	MobileDemand, L.C. 1501 Boyson Sq Dr, Ste 101 Hiawatha, Iowa, 52233, United States
Manufacturer:	MobileDemand, L.C. No.88 East Qianjin Road, Kunshan city, Jiangsu province, China
Product Description:	Tablet PC
Trademark:	MobileDemand
Model Number:	xTablet A1150
File Number:	ES180507073W08

Measurement Procedure Used:

APPLICABLE STANDARDS	
STANDARD	TEST RESULT
FCC 47 CFR Part 2, Subpart J FCC 47 CFR Part 22, Subpart H FCC 47 CFR Part 24, Subpart E FCC 47 CFR Part 27	PASS

The above equipment was tested by EMTEK (SHENZHEN) CO., LTD. The test data, data evaluation, test procedures, and equipment configurations shown in this report were made in accordance with the procedures given in ANSI C63.26 (2015) and the energy emitted by the sample EUT tested as described in this report is in compliance with the requirements of FCC Rules Part 2, 22(H), 24(E), 27.

The test results of this report relate only to the tested sample identified in this report

Date of Test : June 01, 2018 to July 18, 2018

Prepared by : 
Sevin Li/Editor

Reviewer : 
Joe Xia/Supervisor

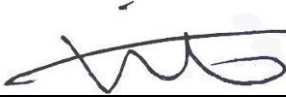
Approve & Authorized Signer : 
Lisa Wang/Manager



2 EUT TECHNICAL DESCRIPTION

Characteristics	Description
Device Type	UMTS
Operation Band:	WCDMA850(Band V), WCDMA1700(Band IV), WCDMA1900(Band II)
Supported Type:	WCDMA/HSUPA/HSDPA for WCDMA850, WCDMA1700, WCDMA1900
Modulation:	QPSK for WCDMA/HSUPA/HSDPA
Operating Frequency Range(s):	TX 824 to 849MHz /RX 869 to 894MHz for WCDMA850(Band V) TX 1710 to 1755MHz /RX 2110 to 2155MHz for WCDMA1700(Band IV) TX 1850 to 1910MHz /RX 1930 to 1990MHz for WCDMA1900(Band II)
Supported Channel Bandwidth:	5 MHz
Transmit Power Max:	23.54 dBm for WCDMA850 24.31 dBm for WCDMA1700 24.14 dBm for WCDMA1900
TX and RX Antenna:	Ant1 (Main Antenna)-Support Transmit and Receive Ant2 (Slave Antenna)-Only Support Receive Remark: Ant2 cannot work independently, it only assists receiving function with the main antenna
Antenna Type:	FPC antenna
Antenna Gain:	WCDMA850:3.7dBi WCDMA1700:4.7dBi WCDMA1900:4.8dBi
Power supply:	<input checked="" type="checkbox"/> DC 3.7V internal rechargeable lithium battery <input checked="" type="checkbox"/> DC 19V from Adapter
	<input checked="" type="checkbox"/> Adapter: Model: ADP-65JH HB INPUT: 100-240V~ 1.5A 50-60Hz OUTPUT: DC 19V, 3.42A
Battery information:	Rating: DC 3.7V, 10800mAh, 39.96Wh

Note: for more details, please refer to the User's manual of the EUT.

3 SUMMARY OF TEST RESULT

FCC Rule	Test Parameter	Verdict	Remark
2.1046	RF Power Output	PASS	
22.913, 24.232, 27.50	Equivalent (Isotropic) Radiated Power	PASS	
2.1047	Modulation Characteristics	PASS	
2.1049	Occupied Bandwidth	PASS	
2.1051, 22.917, 24.238, 27.53	Out of Band Emissions at Antenna Terminals	PASS	
	Band Edge Emission	PASS	
2.1053, 22.917, 24.238, 27.53	Field Strength of Spurious Radiation	PASS	
2.1055, 22.355, 24.235, 27.54	Frequency Stability versus Temperature	PASS	
	Frequency Stability versus Voltage	PASS	
24.232, 27.50	Peak to Average Ratio	PASS	

RELATED SUBMITTAL(S) / GRANT(S):

This submittal(s) (test report) is intended for FCC ID: O86A1150 filing to comply with FCC 47 CFR Part 2, 22(H), 24(E), 27

The system is compliance with Subpart B is authorized under a DOC procedure

4 TEST METHODOLOGY

4.1 GENERAL DESCRIPTION OF APPLIED STANDARDS

According to its specifications, the EUT must comply with the requirements of the following standards:

FCC 47 CFR Part 2, Subpart J
 FCC 47 CFR Part 22, Subpart H
 FCC 47 CFR Part 24, Subpart E
 FCC 47 CFR Part 27
 KDB971168 D01: v02r02
 ANSI/TIA-603-D-2010
 ANSI C63.26:2015

4.2 MEASUREMENT EQUIPMENT USED

4.2.1 Radiated Emission Test Equipment

EQUIPMENT TYPE	MFR	MODEL NUMBER	SERIAL NUMBER	LAST CAL.
EMI Test Receiver	R & S	ESU	1302.6005.26	May 20, 2018
Pre-Amplifier	HP	8447D	2944A07999	May 19, 2018
Bilog Antenna	Schwarzbeck	VULB9163	142	May 19, 2018
Bilog Antenna	Schwarzbeck	VULB9163	141	May 19, 2018
Loop Antenna	ARA	PLA-1030/B	1029	May 19, 2018
Horn Antenna	Schwarzbeck	BBHA 9170	BBHA9170399	May 20, 2018
Horn Antenna	Schwarzbeck	BBHA 9120	D143	May 19, 2018
Cable	Schwarzbeck	AK9513	ACRX1	May 20, 2018
Cable	Rosenberger	N/A	FP2RX2	May 20, 2018
Cable	Schwarzbeck	AK9513	CRPX1	May 20, 2018
Cable	Schwarzbeck	AK9513	CRRX2	May 20, 2018
Cable	H+B	0.5M SF104-26.5	289147/4	May 20, 2018
Cable	H+B	3M SF104-26.5	295838/4	May 20, 2018
Cable	H+B	6M SF104-26.5	295840/4	May 20, 2018

4.2.2 Radio Frequency Test Equipment

EQUIPMENT TYPE	MFR	MODEL NUMBER	SERIAL NUMBER	LAST CAL.
Spectrum Analyzer	Agilent	E4407B	88156318	May 20, 2018
Power meter	Anritsu	ML2495A	0824006	May 20, 2018
Power sensor	Anritsu	MA2411B	0738172	May 20, 2018
Spectrum Analyzer	Agilent	N9010A	My53470879	May 20, 2018
Spectrum Analyzer	R & S	FSV30	103040	May 20, 2018
Spectrum Analyzer	R & S	FSV40	132.1-3008K39-100967-AP	May 20, 2018
Universal Radio Communication	R&S	CMW500	1201.0002K50-140822zk	May 20, 2018
Universal Radio Communication	R&S	CMU200	111226	May 20, 2018
Power Splitter	MInI-CIrcuits	ZFRSC-183-S +	S F808201417	May 20, 2018
Attenuator	Weinschel Associates	WA14	18-10-12	May 20, 2018
Temp. / Humidity Chamber	Kingson	THS-M1	242	May 20, 2018

Remark: Each piece of equipment is scheduled for calibration once a year.

4.3 DESCRIPTION OF TEST MODES

The EUT has been tested under its typical operating condition. The CMU200 and CMW500 used to control the EUT staying in continuous transmitting and receiving mode for testing.

The EUT configuration for testing is installed on RF field strength measurement to meet the Commissions requirement and operating in a manner which intends to maximize its emission characteristics in a continuous normal application.

During all testing, EUT is in link mode with base station emulator at maximum power level.

The Transmitter was operated in the normal operating mode. The TX frequency was fixed which was for the purpose of the measurements.

Test of channel included the lowest and middle and highest frequency to perform the test, then record on this report.

Pre-defined engineering program for regulatory testing used to control the EUT for staying in continuous transmitting and receiving mode is programmed.

■ Test Mode and system config

UMTS REL99 Config

Transmitting performance test of the EUT is implemented during communicating with the SS via air interface. The procedure is using normal call protocol until the UE is communicating on traffic channel basically. On the traffic channel, the UE provides special function for testing that is called Logical Test Interface and the UE is tested using this function. (Refer to T TS 134.109 and TS 134.121).

Transmitting or receiving bit/symbol rate for test channel is shown in the following table .

Bit / Symbol rate for Test Channel

Type of User Information	User Bit Rate	DL DPCH Symbol Rate	UL DPCH Bit Rate	Remarks
12.2 kbps reference measurement channel	12.2 kbps	30 kbps	60 kbps	Standard Test

Transmitter Physical channel configuration

Mode	Rel99
Loopback mode	Test mode1
Rel99 RMC	12.2 kbps RMC
HSDPA FRC	Not applicable
HSUPA Test	Not applicable
Power control algorithm	Algorithm2
β_c	Not applicable
β_d	Not applicable
β_{ec}	Not applicable
B_c/β_d	8/15
β_{hs}	Not applicable
β_{ed}	Not applicable

UMTS HSDPA Rel6 Config

Transmitting performance test of the EUT is implemented during communicating with the SS via air interface. The procedure is using normal call protocol until the UE is communicating on traffic channel basically. On the traffic channel, the UE provides special function for testing that is called Logical Test Interface and the UE is tested using this function. (Refer to TS 134.109 and TS 134.121).

Transmitting or receiving bit/symbol rate for test channel is shown in the following table .

Bit / Symbol rate for Test Channel

Type of User Information	User Bit Rate	DL DPCH Symbol Rate	UL DPCH Bit Rate	Remarks
--------------------------	---------------	---------------------	------------------	---------

12.2 kbps reference measurement channel	12.2 kbps	30 kbps	60 kbps	Standard Test
---	-----------	---------	---------	---------------

Transmitter Physical channel configuration

Mode	HSDPA Rel6			
subtest	1	2	3	4
Loopback mode	Test mode1			
Rel99 RMC	12.2 kbps RMC			
HSDPA FRC	H-Set1			
HSUPA Test	Not applicable			
Power control algorithm	Algorithm2			
β_c	2/15	12/15	15/15	15/15
β_d	15/15	15/15	8/15	4/15
Bd(SF)	64			
Bc/ β_d	2/15	12/15	15/8	15/4
β_{hs}	4/15	24/15	30/15	30/15
MPR(s\dB)	0	0	0.5	0.5
DACK	8			
DNAK	8			
DCQI	8			
Ack-Nack Repetition Factor	3			
CQI feedback	4ms			
CQI repetition factor	2			
A _{hs} = β_{hs}/β_c	30/15			

UMTS HSUPA Rel6 Config

Transmitting performance test of the EUT is implemented during communicating with the SS via air interface. The procedure is using normal call protocol until the UE is communicating on traffic channel basically. On the traffic channel, the UE provides special function for testing that is called Logical Test Interface and the UE is tested using this function. (Refer to TS 134.109 and TS 134.121).

Transmitting or receiving bit/symbol rate for test channel is shown in the following table .

Bit / Symbol rate for Test Channel

Type of User Information	User Bit Rate	DL DPCH Symbol Rate	UL DPCH Bit Rate	Remarks
12.2 kbps reference measurement channel	12.2 kbps	30 kbps	60 kbps	Standard Test

Transmitter Physical channel configuration

Mode	HSUPA Rel6				
subtest	1	2	3	4	5
Loopback mode	Test mode1				
Rel99 RMC	12.2 kbps RMC				
HSDPA FRC	H-Set1				
HSUPA Test	HSUPA loopback				
Power control algorithm	Algorithm2				
β_c	11/15	6/15	15/15	2/15	15/15
β_d	15/15	15/15	9/15	15/15	0
β_{ec}	209/225	12/15	30/15	2/15	5/15
β_{ed}	1309/225	94/75	47/15	56/75	47/15
β_c/β_d	11/15	6/15	15/9	2/15	-
β_{hs}	22/15	12/15	30/15	4/15	5/15
D E-DPCCH	6	8	8	5	7
DHARQ	0	0	0	0	0
AG index	20	12	15	17	12
ETFCI	75	67	92	71	67

Associated Max UL data rate kbps	242.1	174.9	482.8	205.8	308.9
Reference E_TFCIs	E_TFCI 11 E_TFCI PO4 E_TFCI 67 E_TFCI PO18 E_TFCI 71 E_TFCI PO23 E_TFCI 75 E_TFCI PO 26 E_TFCI 81 E_TFCI PO 27		E_TFCI 11 E_TFCI PO4 E_TFCI 92 E_TFCI PO18		E_TFCI 11 E_TFCI PO4 E_TFCI 67 E_TFCI PO18 E_TFCI 71 E_TFCI PO23 E_TFCI 75 E_TFCI PO 26 E_TFCI 81 E_TFCI PO 27

■ Test Environment

Environment Parameter	Selected Values During Tests	
Relative Humidity	Ambient	
Temperature	TN	Ambient
Ambient	VL	2.97V
	VN	3.30V
	VH	3.63V
NOTE: VL= Lower Extreme Test Voltage VN= Nominal Voltage VH= Upper Extreme Test Voltage TN= Normal Temperature		

■ Test Channel and Frequency

Test Mode	TX / RX	RF Channel		
		Low (L)	Middle (M)	High (H)
WCDMA850	TX	Channel 4132	Channel 4182	Channel 4233
		826.4MHz	836.4MHz	846.6MHz
	RX	Channel 4357	Channel 4407	Channel 4458
		871.4MHz	881.4MHz	891.6MHz
WCDMA1900	TX	Channel 9262	Channel 9400	Channel 9538
		1852.4MHz	1880.0MHz	1907.6MHz
	RX	Channel 9662	Channel 9800	Channel 9938
		1932.4 MHz	1960.0 MHz	1987.6 MHz
WCDMA1700	TX	Channel 1312	Channel 1413	Channel 1513
		1712.4MHz	1732.6MHz	1752.6MHz
	RX	Channel 1537	Channel 1638	Channel 1738
		2112.4 MHz	2132.6 MHz	2152.6 MHz

5 FACILITIES AND ACCREDITATIONS

5.1 FACILITIES

All measurement facilities used to collect the measurement data are located at

Bldg 69, Majialong Industry Zone District, Nanshan District, Shenzhen, China

The sites are constructed in conformance with the requirements of ANSI C63.7, ANSI C63.26 and CISPR Publication 22.

5.2 LABORATORY ACCREDITATIONS AND LISTINGS

Site Description

EMC Lab.

: Accredited by CNAS, 2016.10.24

The certificate is valid until 2022.10.28

The Laboratory has been assessed and proved to be in compliance with CNAS-CL01: 2006(identical to ISO/IEC17025: 2005)

The Certificate Registration Number is L2291

Accredited by TUV Rheinland Shenzhen 2015.4

The Laboratory has been assessed according to the requirements ISO/IEC 17025.

Accredited by FCC, August 03, 2017

Designation Number: CN1204

Test Firm Registration Number: 882943

Accredited by A2LA, July 31, 2017

The Certificate Registration Number is 4321.01.

Accredited by Industry Canada, November 24, 2015

The Certificate Registration Number is 4480A

Name of Firm

: EMTEK (SHENZHEN) CO., LTD.

Site Location

: Bldg 69, Majialong Industry Zone,

Nanshan District, Shenzhen, Guangdong, China

6 TEST SYSTEM UNCERTAINTY

The following measurement uncertainty levels have been estimated for tests performed on the apparatus:

Parameter	Uncertainty
Radio Frequency	$\pm 1 \times 10^{-5}$
RF Power Output	$\pm 1.0\text{dB}$
Radiated Emission Test	$\pm 2.0\text{dB}$
Occupied Bandwidth Test	$\pm 1.0\text{dB}$
Band Edge Test	$\pm 3\text{dB}$
All emission, radiated	$\pm 3\text{dB}$
Antenna Port Emission	$\pm 3\text{dB}$
Temperature	$\pm 0.5^{\circ}\text{C}$
Humidity	$\pm 3\%$

Measurement Uncertainty for a level of Confidence of 95%

7 SETUP OF EQUIPMENT UNDER TEST

7.1 RADIO FREQUENCY TEST SETUP 1

The component's antenna ports(s) of the EUT are connected to the measurement instrument per an appropriate attenuator. The EUT is controlled by PC/software to emit the specified signals for the purpose of measurements.

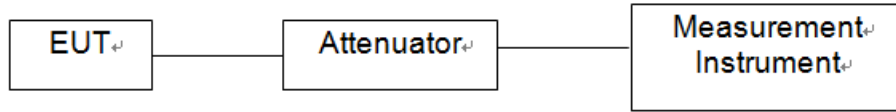

7.2 RADIO FREQUENCY TEST SETUP 2

The test site semi-anechoic chamber has met the requirement of NSA tolerance 4 dB according to the standards: ANSI C63.10. The test distance is 3m. The setup is according to the requirements in Section 13.1.4.1 of ANSI C63.26-2015 and CAN/CSA-CEI/IEC CISPR 22.

Below 30MHz:

The EUT is placed on a turntable 0.8 meters above the ground in the chamber, 3 meter away from the antenna (loop antenna). The Antenna should be positioned with its plane vertical at the specified distance from the EUT and rotated about its vertical axis for maximum response at each azimuth about the EUT. The center of the loop shall be 1 m above the ground. For certain applications, the loop antenna plane may also need to be positioned horizontally at the specified distance from the EUT.

Above 30MHz:

The EUT is placed on a turntable 0.8 meters above the ground in the chamber, 3 meter away from the antenna. The maximal emission value is acquired by adjusting the antenna height, polarisation and turntable azimuth. Normally, the height range of antenna is 1 m to 4 m, the azimuth range of turntable is 0° to 360°, and the receive antenna has two polarizations Vertical (V) and Horizontal (H).

Above 1GHz:

(Note: the FCC's permission to use 1.5m as an alternative per TCBC Conf call of Dec. 2, 2014.)

The EUT is placed on a turntable 1.5 meters above the ground in the chamber, 3 meter away from the antenna. The maximal emission value is acquired by adjusting the antenna height, polarisation and turntable azimuth. Normally, the height range of antenna is 1 m to 4 m, the azimuth range of turntable is 0° to 360°, and the receive antenna has two polarizations Vertical (V) and Horizontal (H).

(a) Radiated Emission Test Set-Up, Frequency Below 30MHz

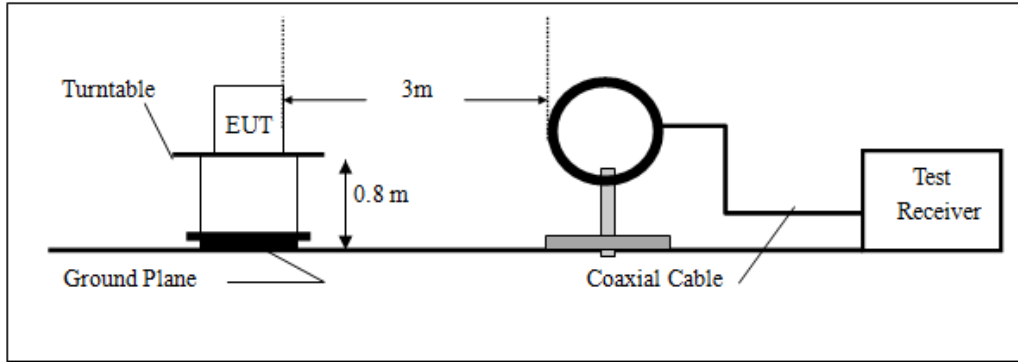

(b) Radiated Emission Test Set-Up, Frequency Below 1000MHz

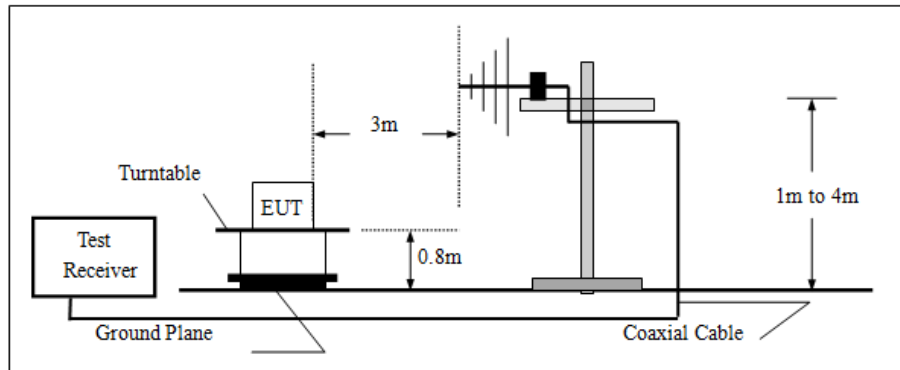

(c) Radiated Emission Test Set-Up, Frequency above 1000MHz

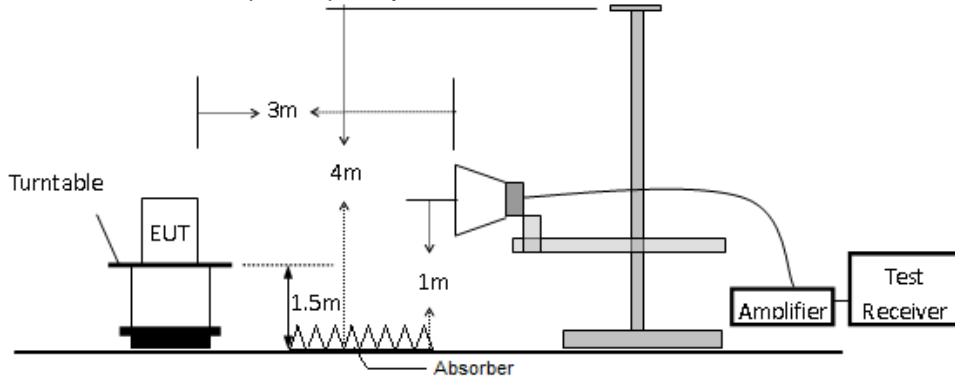

7.3 SUPPORT EQUIPMENT

Item	Equipment	Mfr/Brand	Model/Type No.	FCC ID	Note
N/A	N/A	N/A	N/A	N/A	N/A

Notes:

1. *All the equipment/cables were placed in the worst-case configuration to maximize the emission during the test.*
2. *Grounding was established in accordance with the manufacturer's requirements and conditions for the intended use.*

8 TEST REQUIREMENTS

8.1 RF POWER OUTPUT

8.1.1 Conformance Limit

No limit requirement.

8.1.2 Test Configuration

Test according to clause 7.1 radio frequency test setup 1

8.1.3 Test Procedure

Connect the EUT to Universal Radio Communication Tester CMU200 or CMU500 via the antenna connector. A call is set up by the SS according to the generic call set up procedure on a channel with ARFCN in the ARFCN range, power control level set to Max power. The frequency band is set as selected frequency,

The RF output of the transmitter was connected to base station simulator.

Set EUT at maximum average power by base station simulator.

Set RBW = 1-5% of the OBW, not to exceed 1 MHz.

Set VBW $\geq 3 \times$ RBW.

Number of points in sweep $\geq 2 \times$ span / RBW. (This gives bin-to-bin spacing \leq RBW/2, so that narrowband signals are not lost between frequency bins.)

Sweep time = auto.

Detector = RMS (power averaging).

Set sweep trigger to "free run".

Trace average at least 100 traces in power averaging (i.e., RMS) mode; however, the number of traces to be averaged shall be increased above 100 as needed such that the average accurately represents the true average over the on and off periods of the transmitter.

Compute power by integrating the spectrum across the OBW of the signal using the instrument's band power measurement function with band limits set equal to the OBW band edges. If the instrument does not have a band power function, sum the spectrum levels (in power units) at intervals equal to the RBW extending across the entire OBW of the spectrum.

Add $10 \log(1/x)$, where x is the duty cycle, to the measured power in order to compute the average power during the actual transmission times (because the measurement represents an average over both the on and off times of the transmission). For example, add $10 \log(1/0.25) = 6$ dB if the duty cycle is a constant 25%.

Measure lowest, middle, and highest channels for each bandwidth and different modulation.

Measure and record the results in the test report.

8.1.4 Test Results

Pass

Note: The details please see Appendix A.

8.2 EFFECTIVE (ISOTROPIC) RADIATED POWER

8.2.1 Conformance Limit

For FCC Part 22.913

Extend coverage on a secondary basis into cellular unserved areas, as those areas are defined in §22.949, the ERP of base transmitters and cellular repeaters of such systems must not exceed 1000 Watts. The ERP of mobile transmitters and auxiliary test transmitters must not exceed 7 Watts.

For FCC Part 24.232

Mobile and portable stations are limited to 2 watts EIRP and the equipment must employ a means for limiting power to the minimum necessary for successful communications.

For FCC Part 27.50

Fixed, mobile, and portable (hand-held) stations operating in the 1710-1755 MHz band and mobile and portable stations operating in the 1695-1710 MHz and 1755-1780 MHz bands are limited to 1 watt EIRP. Fixed stations operating in the 1710-1755 MHz band are limited to a maximum antenna height of 10 meters above ground. Mobile and portable stations operating in these bands must employ a means for limiting power to the minimum necessary for successful communications.

8.2.2 Test Configuration

Test according to clause 7.3 radio frequency test setup 3

8.2.3 Test Procedure

Connect the EUT to Universal Radio Communication Tester CMU200 or CMU500 via the antenna connector. A call is set up by the SS according to the generic call set up procedure on a channel with ARFCN in the Mid ARFCN range, power control level set to Max power. MS TXPWR_MAX_CCH is set to the maximum value supported by the Power Class of the Mobile under test

The instrument must have an available measurement/resolution bandwidth that is equal to or exceeds the OBW. If this capability is available, then the following procedure can be used to determine the total peak output power.

- a) Set the RBW \geq OBW.
- b) Set VBW $\geq 3 \times$ RBW.
- c) Set span $\geq 2 \times$ RBW
- d) Sweep time = auto couple.
- e) Detector = peak.
- f) Ensure that the number of measurement points \geq span/RBW.
- g) Trace mode = max hold.
- h) Allow trace to fully stabilize.
- i) Use the peak marker function to determine the peak amplitude level.

The EUT was placed on a turn table which is 0.8m above ground plane. Maximum procedure was performed on the six highest emissions to ensure EUT compliance. And also, each emission was to be maximized by changing the polarization of receiving antenna both horizontal and vertical. Repeat above procedures until all frequency measured was complete.

A receiving antenna was placed on the antenna mast 3 meters from the EUT for emission measurements. The height of receiving antenna is 1.5m. The test setup refers to figure below. Detected emissions were maximized at each frequency by rotating the EUT through 360° and adjusting the receiving antenna polarization. The radiated emission measurements of all transmit frequencies in three channels (High, Middle, Low) were measured with peak detector.

The EUT is then put into continuously transmitting mode at its maximum power level during the test. And the maximum value of the receiver should be recorded as (Pr).

The EUT shall be replaced by a substitution antenna. The test setup refers to figure below. In the chamber, an substitution antenna for the frequency band of interest is placed at the reference point of the chamber. An RF Signal source for the frequency band of interest is connected to the substitution antenna with a cable that has been constructed to not interfere with the radiation pattern of the antenna. A power (PMea) is applied to the input of the substitution antenna, and adjust the level of the signal generator output until the value of the receiver reach the previously recorded (Pr). The power of signal source (PMea) is recorded. The test should be performed by rotating the test item and adjusting the receiving antenna polarization.

A amplifier should be connected to the Signal Source output port. And the cable should be connect between the Amplifier and the Substitution Antenna.

The cable loss (Pcl) ,the Substitution Antenna Gain (Ga) and the Amplifier Gain (PAg) should be recorded after test.

The measurement results are obtained as described below:

Power(EIRP)=PMea- PAg - Pcl - Ga

This value is EIRP since the measurement is calibrated using an antenna of known gain (2.15 dBi) and known input power.

ERP can be calculated from EIRP by subtracting the gain of the dipole,

ERP = EIRP -2.15dBi.

8.2.4 Test Results

Pass

Note: The details please see Appendix B.

8.3 MODULATION CHARACTERISTICS

8.3.1 Conformance Limit

No specific modulation characteristics requirement limits.

8.3.2 Test Configuration

Test according to clause 7.1 radio frequency test setup 1

8.3.3 Test Procedure

Connect the EUT to Universal Radio Communication Tester CMU200 or CMU500 via the antenna connector. A call is set up by the SS according to the generic call set up procedure on a channel with ARFCN in the Mid ARFCN range, power control level set to Max power. MS TXPWR_MAX_CCH is set to the maximum value supported by the Power Class of the Mobile under test, The frequency band is set as selected frequency, test method was according to 3GPP TS 51.010 and 3GPP TS 34.121. and 3GPP2 C.S0011/TIA-98-E for 1XRTT. and 3GPP2 C.S0033-0/tia-866 for Rel.0 and 3GPP2 C.S0033-A for Rev.A The waveform quality and constellation of the was tested.

8.3.4 Test Results

Pass

8.4 OCCUPIED BANDWIDTH

8.4.1 Conformance Limit

No specific modulation characteristics requirement limits.

8.4.2 Test Configuration

Test according to clause 7.1 radio frequency test setup 1

8.4.3 Test Procedure

Connect the EUT to Universal Radio Communication Tester CMU200 or CMU500 via the antenna connector. A call is set up by the SS according to the generic call set up procedure on a channel with ARFCN in the Mid ARFCN range, power control level set to Max power. MS TXPWR_MAX_CCH is set to the maximum value supported by the Power Class of the Mobile under test,

■ 99% Occupied bandwidth

The following procedure shall be used for measuring (99 %) power bandwidth

- a) The spectrum analyzer center frequency is set to the nominal EUT channel center frequency. The frequency span for the spectrum analyzer shall be set wide enough to capture all modulation products including the emission skirts (i.e., two to five times the OBW).
- b) The nominal IF filter bandwidth (3 dB RBW) shall be in the range of 1 to 5 % of the anticipated OBW, and the VBW shall be at least 3 times the RBW.
- c) Set the reference level of the instrument as required to keep the signal from exceeding the maximum input mixer level for linear operation. In general, the peak of the spectral envelope must be at least $10\log(\text{OBW} / \text{RBW})$ below the reference level.
- d) NOTE—Steps a) through c) may require iteration to adjust within the specified tolerances.
- e) Set the detection mode to peak, and the trace mode to max hold..
- f) Use the 99 % power bandwidth function of the spectrum analyzer (if available) and report the measured bandwidth.
- g) If the instrument does not have a 99 % power bandwidth function, the trace data points are to be recovered and directly summed in linear power terms. The recovered amplitude data points, beginning at the lowest frequency, are placed in a running sum until 0.5 % of the total is reached; that frequency is recorded as the lower frequency. The process is repeated until 99.5 % of the total is reached; that frequency is recorded as the upper frequency. The 99 % power bandwidth is the difference between these two frequencies.
- h) The OBW shall be reported by providing plot(s) of the measuring instrument display. The frequency and amplitude axes and scale shall be clearly labeled. Tabular data may be reported in addition to the plot(s).

■ 26 dB Occupied bandwidth

The reference value is the highest level of the spectral envelope of the modulated signal.

- a) The spectrum analyzer center frequency is set to the nominal EUT channel center frequency. The span range for the spectrum analyzer shall be between two and five times the anticipated OBW.
- b) The nominal resolution bandwidth (RBW) shall be in the range of 1 to 5 % of the anticipated OBW, and the VBW shall be at least 3 times the RBW.
- c) Set the reference level of the instrument as required to prevent the signal from exceeding the maximum input mixer level for linear operation. In general, the peak of the spectral envelope must be at least $10\log(\text{OBW} / \text{RBW})$ below the reference level.
- d) NOTE—Steps a) through c) may require iteration to adjust within the specified tolerances.
- e) The dynamic range of the spectrum analyzer at the selected RBW shall be at least 10 dB below the target “-X dB down” requirement (i.e., if the requirement calls for measuring the -26 dB OBW, the spectrum analyzer noise floor at the selected RBW shall be at least 36 dB below the reference value).
- f) Set the detection mode to peak, and the trace mode to max hold.
- g) Determine the reference value: Set the EUT to transmit a modulated signal. Allow the trace to stabilize. Set the spectrum analyzer marker to the highest level of the displayed trace (this is the reference value).
- h) Determine the “-X dB down amplitude” as equal to (Reference Value – X). Alternatively, this calculation can be performed by the analyzer by using the marker-delta function.

i) Place two markers, one at the lowest and the other at the highest frequency of the envelope of the spectral display such that each marker is at or slightly below the “-X dB down amplitude” determined in step g). If a marker is below this “-X dB down amplitude” value it shall be placed as close as possible to this value. The OBW is the positive frequency difference between the two markers.

j) The occupied bandwidth shall be reported by providing plot(s) of the measuring instrument display. The frequency and amplitude axes and scale shall be clearly labeled. Tabular data may be reported in addition to the plot(s)

8.4.4 Test Results

Pass

Note: The details please see Appendix C.

8.5 BAND EDGE EMISSION

8.5.1 Conformance Limit

For FCC Part 22.917

≤ -13 dBm/1%*EBW, in 1 MHz bands immediately outside and adjacent to the frequency block.

For FCC Part 24.238

≤ -13 dBm/1%*EBW, in 1 MHz bands immediately outside and adjacent to the frequency block.

For FCC Part 27.53

≤ -13 dBm/1%*EBW, in 1 MHz bands immediately outside and adjacent to the frequency block.

8.5.2 Test Configuration

Test according to clause 7.1 radio frequency test setup 1

8.5.3 Test Procedure

Connect the EUT to Universal Radio Communication Tester CMU200 or CMU500 via the antenna connector. A call is set up by the SS according to the generic call set up procedure on a channel with ARFCN in the Mid ARFCN range, power control level set to Max power. MS TXPWR_MAX_CCH is set to the maximum value supported by the Power Class of the Mobile under test,

Spectrum Analyzer is set as below:

SET RBW \geq 1% of Emission BW.

SET VBW about three times of RBW

Detector: RMS

Trace mode= max hold.

Span= 2MHz

8.5.4 Test Results

Pass

Note: The details please see Appendix D.

8.6 OUT OF BAND EMISSIONS AT ANTENNA TERMINALS

8.6.1 Conformance Limit

For FCC Part 22.917

Out of band emissions. The power of any emission outside of the authorized operating frequency ranges must be attenuated below the transmitting power (P) by a factor of at least $43 + 10 \log(P)$ dB.

For FCC Part 24.238

Out of band emissions. The power of any emission outside of the authorized operating frequency ranges must be attenuated below the transmitting power (P) by a factor of at least $43 + 10 \log(P)$ dB.

For FCC Part 27.53

Out of band emissions. The power of any emission outside of the authorized operating frequency ranges must be attenuated below the transmitting power (P) by a factor of at least $43 + 10 \log(P)$ dB.

The specification that emissions shall be attenuated below the transmitter power (P) by at least $43 + 10 \log(P)$ dB, translates in the relevant power range (1 to 0.001 W) to -13 dBm. At 1 W the specified minimum attenuation becomes 43 dB and relative to a 30 dBm (1 W) carrier becomes a limit of -13 dBm. At 0.001 W (0 dBm) the minimum attenuation is 13 dB, which again yields a limit of -13 dBm. In this way a translation of the specification from relative to absolute terms is carried out.

8.6.2 Test Configuration

Test according to clause 7.1 radio frequency test setup 1

8.6.3 Test Procedure

The transmitter output (antenna port) was connected to the spectrum analyzer. Connect the EUT to Universal Radio Communication Tester CMU200 or CMU500 via the antenna connector. A call is set up by the SS according to the generic call set up procedure on a channel with ARFCN in the Mid ARFCN range, power control level set to Max power. MS TXPWR_MAX_CCH is set to the maximum value supported by the Power Class of the Mobile under test,

Spectrum Analyzer is set as below:

9kHz~150kHz, RBW = 1KHz, VBW $\geq 3 \times$ RBW,

150kHz~30MHz, RBW = 10KHz, VBW $\geq 3 \times$ RBW,

30MHz~1GHz, RBW = 100 kHz, VBW = 300 kHz. Above 1GHz, RBW = 1 MHz, VBW = 3 MHz.

Detector: Peak

Trace mode= max hold.

8.6.4 Test Results

Pass

Note: The details please see Appendix E.

8.7 FIELD STRENGTH OF SPURIOUS RADIATION

8.7.1 Conformance Limit

For FCC Part 22.917

Out of band emissions. The power of any emission outside of the authorized operating frequency ranges must be attenuated below the transmitting power (P) by a factor of at least $43 + 10 \log(P)$ dB.

For FCC Part 24.238

Out of band emissions. The power of any emission outside of the authorized operating frequency ranges must be attenuated below the transmitting power (P) by a factor of at least $43 + 10 \log(P)$ dB.

For FCC Part 27.53

Out of band emissions. The power of any emission outside of the authorized operating frequency ranges must be attenuated below the transmitting power (P) by a factor of at least $43 + 10 \log(P)$ dB.

The specification that emissions shall be attenuated below the transmitter power (P) by at least $43 + 10 \log(P)$ dB, translates in the relevant power range (1 to 0.001 W) to -13 dBm. At 1 W the specified minimum attenuation becomes 43 dB and relative to a 30 dBm (1 W) carrier becomes a limit of -13 dBm. At 0.001 W (0 dBm) the minimum attenuation is 13 dB, which again yields a limit of -13 dBm. In this way a translation of the specification from relative to absolute terms is carried out.

8.7.2 Test Configuration

Test according to clause 7.3 radio frequency test setup 3

8.7.3 Test Procedure

Connect the EUT to Universal Radio Communication Tester CMU200 or CMU500 via the antenna connector. A call is set up by the SS according to the generic call set up procedure on a channel with ARFCN in the Mid ARFCN range, power control level set to Max power. MS TXPWR_MAX_CCH is set to the maximum value supported by the Power Class of the Mobile under test.

Compliance with these rules is based on the use of measurement instrumentation employing a resolution bandwidth of 100 kHz or greater. In the 1 MHz bands immediately outside and adjacent to the frequency block a resolution bandwidth of at least one percent of the emission bandwidth of the fundamental emission of the transmitter may be employed. A narrower resolution bandwidth is permitted in all cases to improve measurement accuracy provided the measured power is integrated over the full required measurement bandwidth (i.e. 100 kHz or 1 percent of emission bandwidth, as specified). The emission bandwidth is defined as the width of the signal between two points, one below the carrier center frequency and one above the carrier center frequency, outside of which all emissions are attenuated at least 26 dB below the transmitter power.

then the following procedure can be used to determine spurious emission

- a) RBW = 1 MHz for $f \geq 1$ GHz(1GHz to 25GHz), 100 kHz for $f < 1$ GHz(30MHz to 1GHz), 200Hz for $f < 150$ KHz(9KHz to 150KHz), 9KHz for $f < 30$ MHz(150KHz to 30KHz)
- b) Set VBW $\geq 3 \times$ RBW.
- c) Set span wide enough to fully capture the emission being measured
- d) Sweep time = auto couple.
- e) Detector = peak.
- f) Ensure that the number of measurement points \geq span/RBW.
- g) Trace mode = max hold.
- h) Allow trace to fully stabilize.
- i) Use the peak marker function to determine the peak amplitude level.

Step1. The EUT was placed on a rotatable wooden table with 0.8 meter above ground.

Step2. The EUT was set 3 meters from the receiving antenna, which was mounted on the antenna tower.

Step3. The table was rotated 360 degrees to determine the position of the highest spurious emission.

Step4. The height of the receiving antenna is varied between one meter and four meters to search the maximum spurious emission for both horizontal and vertical polarizations.

Step5. Make the measurement with the spectrum analyzer's RBW , VBW , taking the record of

maximum spurious emission.

Step6. A horn antenna was substituted in place of the EUT and was driven by a signal generator.

Step7. Tune the output power of signal generator to the same emission level with EUT maximum spurious emission.

Step8. Taking the record of output power at antenna port.

Step9. Repeat step 7 to step 8 for another polarization.

Step10. Emission level (dBm) = output power + substitution Gain. Test Results

8.7.4 Test Results

Pass

Note: The details please see Appendix F.

8.8 FREQUENCY STABILITY

8.8.1 Conformance Limit

The frequency stability shall be measured by variation of ambient temperature and variation of primary supply voltage to ensure that the fundamental emission stays within the authorized frequency block. The frequency stability of the transmitter shall be maintained within $\pm 0.00025\%$ ($\pm 2.5\text{ppm}$) of the center frequency.

8.8.2 Test Configuration

Test according to clause 7.2 conducted emission test setup2.

8.8.3 Test Procedure

Connect the EUT to Universal Radio Communication Tester CMU200 or CMU500 via the antenna connector. A call is set up by the SS according to the generic call set up procedure on a channel with ARFCN in the ARFCN range, power control level set to Max power. MS TXPWR_MAX_CCH is set to the maximum value supported by the Power Class of the Mobile under test.

EUT was placed at temperature chamber and connected to an external power supply.

Temperature and voltage condition shall be tested to confirm frequency stability.

(a) Frequency measurements shall be made at the extremes of the specified temperature range and at intervals of not more than 10° centigrade through the range. A period of time sufficient to stabilize all of the components of the oscillator circuit at each temperature level shall be allowed prior to frequency measurement. The short-term transient effects on the frequency of the transmitter due to keying (except for broadcast transmitters) and any heating element cycling normally occurring at each ambient temperature level also shall be shown. Only the portion or portions of the transmitter containing the frequency determining and stabilizing circuitry need be subjected to the temperature variation test.

(b) The frequency stability shall be measured with variation of primary supply voltage as follows:

(1) Vary primary supply voltage from 95 to 105 percent of the nominal value for other than hand carried battery equipment.

(2) For hand carried, battery powered equipment, reduce primary supply voltage to the battery operating end point, which shall be specified by the manufacturer.

8.8.4 Test Results

Pass

Note: The details please see Appendix G.

8.9 PEAK TO AVERAGE RATIO

8.9.1 Conformance Limit

For FCC Part 24.232

Power measurements for transmissions by stations authorized under this section may be made either in accordance with a Commission-approved average power technique or in compliance with paragraph (e) of this section. In both instances, equipment employed must be authorized in accordance with the provisions of §24.51. In measuring transmissions in this band using an average power technique, the peak-to-average ratio (PAR) of the transmission may not exceed 13 dB.

For FCC Part 27.50

Equipment employed must be authorized in accordance with the provisions of §24.51. Power measurements for transmissions by stations authorized under this section may be made either in accordance with a Commission-approved average power technique or in compliance with paragraph (d)(6) of this section. In measuring transmissions in this band using an average power technique, the peak-to-average ratio (PAR) of the transmission may not exceed 13 dB.

8.9.2 Test Configuration

Test according to clause 7.1 conducted emission test setup1.

8.9.3 Test Procedure

The EUT was connected to Spectrum Analyzer and Base Station via power divider.

The RF output of EUT was connected to the spectrum analyzer by RF cable and attenuator. The path loss was compensated to the results for each measurement.

Set the number of counts to a value that stabilizes the measured CCDF curve.

Set the measurement interval to 1 ms.

Record the maximum PAPR level associated with a probability of 0.1%.

- a) Refer to instrument's analyzer instruction manual for details on how to use the power statistics/CCDF function;
- b) Set resolution/measurement bandwidth \geq signal's occupied bandwidth;
- c) Set the number of counts to a value that stabilizes the measured CCDF curve;
- d) Set the measurement interval as follows:
 - 1) for continuous transmissions, set to 1 ms,
 - 2) for burst transmissions, employ an external trigger that is synchronized with the EUT burst timing sequence, or use the internal burst trigger with a trigger level that allows the burst to stabilize and set the measurement interval to a time that is less than or equal to the burst duration.
- e) Record the maximum PAPR level associated with a probability of 0.1%.

8.9.4 Test Results

Pass

Note: The details please see Appendix H.

APPENDIX A: TEST DATA FOR RF POWER OUTPUT

Operation Mode	Modulation	Channel Number	Channel Frequency (MHz)	Average Result (dBm)	Limit (dBm)	Verdict
WCDMA850	QPSK	4132	826.4	22.81	N/A	Pass
		4182	836.4	22.72	N/A	Pass
		4233	846.6	22.68	N/A	Pass
WCDMA1700	QPSK	1312	1712.4	22.63	N/A	Pass
		1413	1732.6	22.82	N/A	Pass
		1513	1752.6	22.75	N/A	Pass
WCDMA1900	QPSK	9262	1852.4	22.72	N/A	Pass
		9400	1880.0	22.82	N/A	Pass
		9538	1907.6	22.84	N/A	Pass

APPENDIX B: TEST DATA FOR EFFECTIVE (ISOTROPIC) RADIATED POWER

Operation Mode	Modulation	Channel Number	Channel Frequency (MHz)	ERP/EIRP Result (dBm)	Limit (dBm)	Verdict
WCDMA850	QPSK	4132	826.4	23.97	38.5	Pass
		4182	836.4	23.91	38.5	Pass
		4233	846.6	23.81	38.5	Pass
WCDMA1700	QPSK	1312	1712.4	22.67	30	Pass
		1413	1732.6	22.89	30	Pass
		1513	1752.6	22.75	30	Pass
WCDMA1900	QPSK	9262	1852.4	23.61	33	Pass
		9400	1880.0	23.98	33	Pass
		9538	1907.6	23.73	33	Pass

APPENDIX C: TEST DATA FOR OCCUPIED BANDWIDTH

Operation Mode	Modulation	Channel Number	Channel Frequency (MHz)	Occupied Bandwidth (KHz)	Emission Bandwidth (KHz)	Verdict
WCDMA850	QPSK	4132	826.4	4146	4695	Pass
		4182	836.4	4136	4710	Pass
		4233	846.6	4136	4705	Pass
WCDMA1700	QPSK	1312	1712.4	4136	4685	Pass
		1413	1732.6	4146	4715	Pass
		1513	1752.6	4146	4695	Pass
WCDMA1900	QPSK	9262	1852.4	4136	4725	Pass
		9400	1880.0	4156	4715	Pass
		9538	1907.6	4156	4715	Pass

Test plots as follow:

Test Model	Bandwidth	QPSK Modulation	Frequency(MHz)	826.4
	WCDMA850 Test Channel			

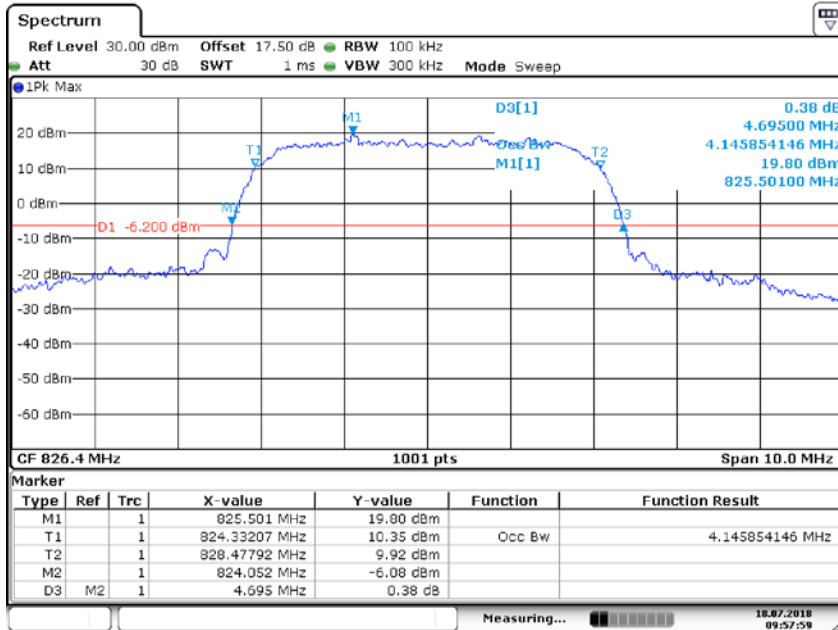

Date: 18.JUL.2018 09:57:59

Test Model	Bandwidth	QPSK Modulation	Frequency(MHz)	836.4
	WCDMA850 Test Channel			

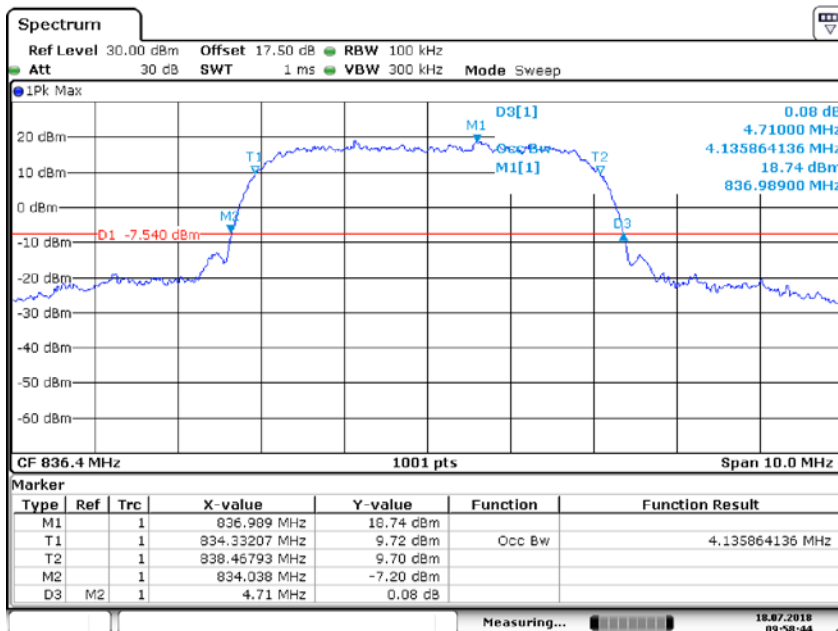

Date: 18.JUL.2018 09:58:43

Test Model	Bandwidth WCDMA850 Test Channel	QPSK Modulation 4233	Frequency(MHz)	846.6
------------	--	-------------------------	----------------	-------

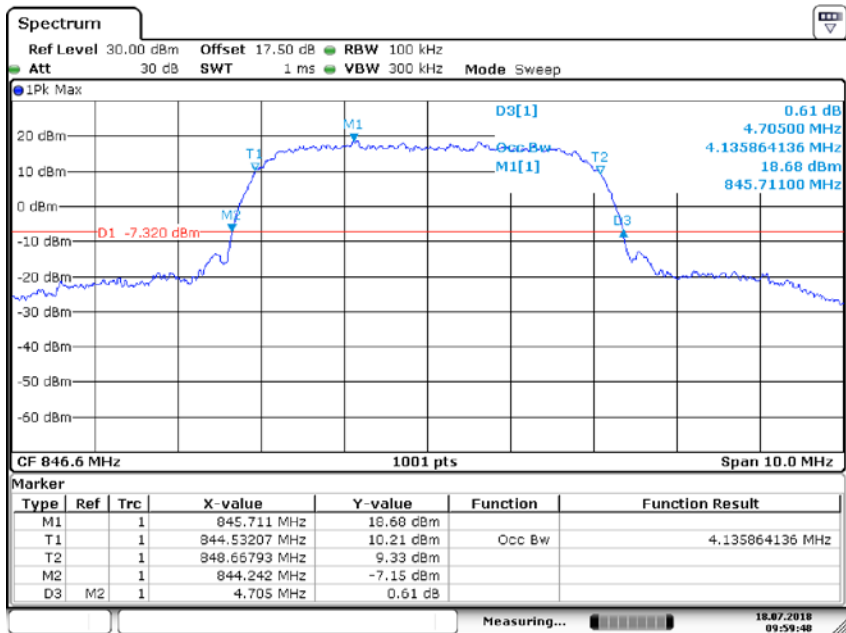

Date: 18 JUL 2018 09:59:48

Test Model	Bandwidth	QPSK Modulation	Frequency(MHz)	1712.4
	WCDMA1700 Test Channel			

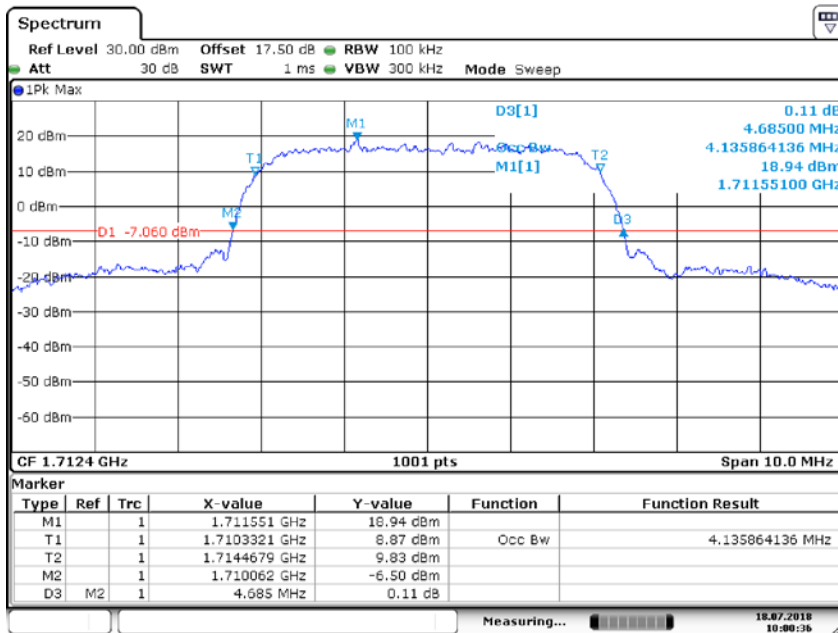

Date: 18.JUL.2018 10:00:36

Test Model	Bandwidth	QPSK Modulation	Frequency(MHz)	1732.6
	WCDMA1700 Test Channel			

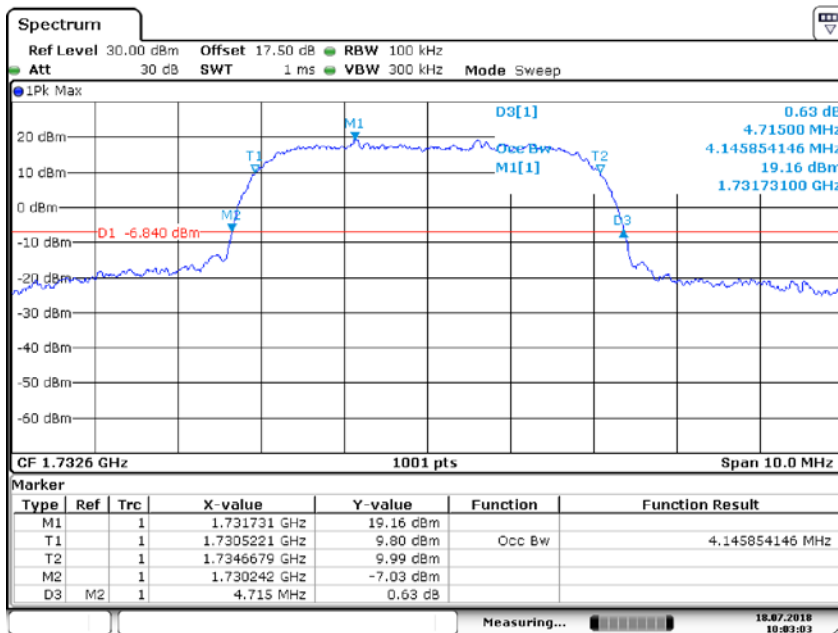

Date: 18.JUL.2018 10:03:03

Test Model	Bandwidth	QPSK Modulation	Frequency(MHz)	1752.6
	WCDMA1700 Test Channel			

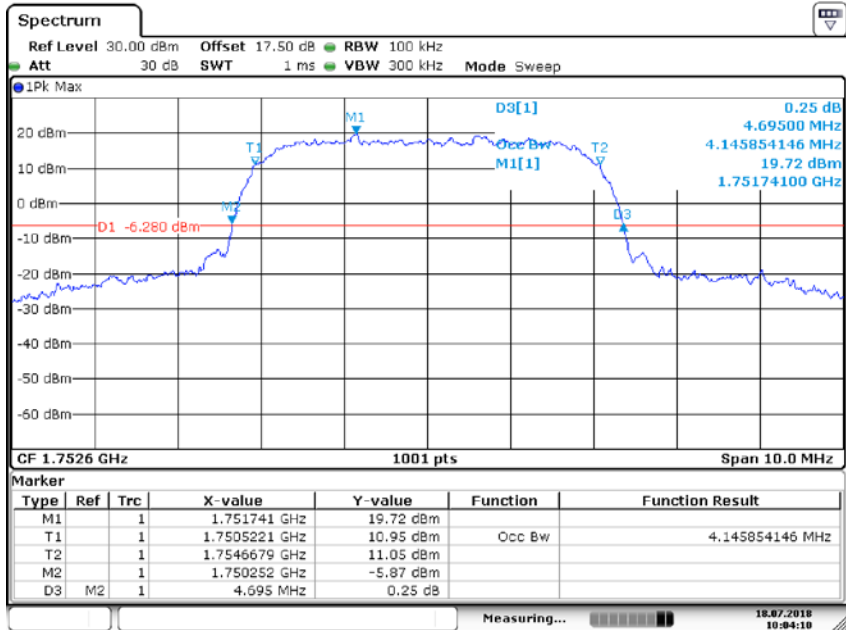

Date: 18.JUL.2018 10:04:10

Test Model	Bandwidth	QPSK Modulation	Frequency(MHz)	1852.4
	WCDMA1900 Test Channel			

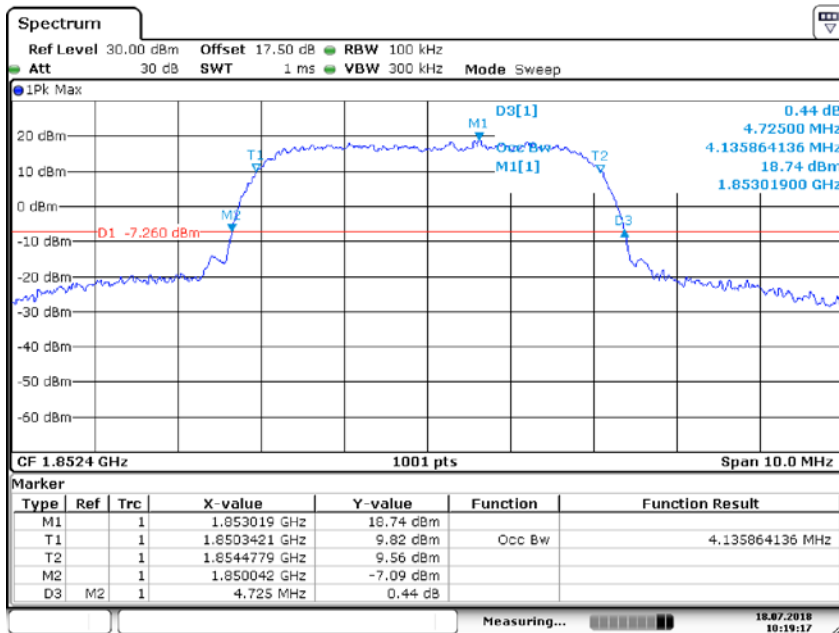

Date: 18.JUL.2018 10:19:17

Test Model	Bandwidth	QPSK Modulation	Frequency(MHz)	1880.0
	WCDMA1900 Test Channel			

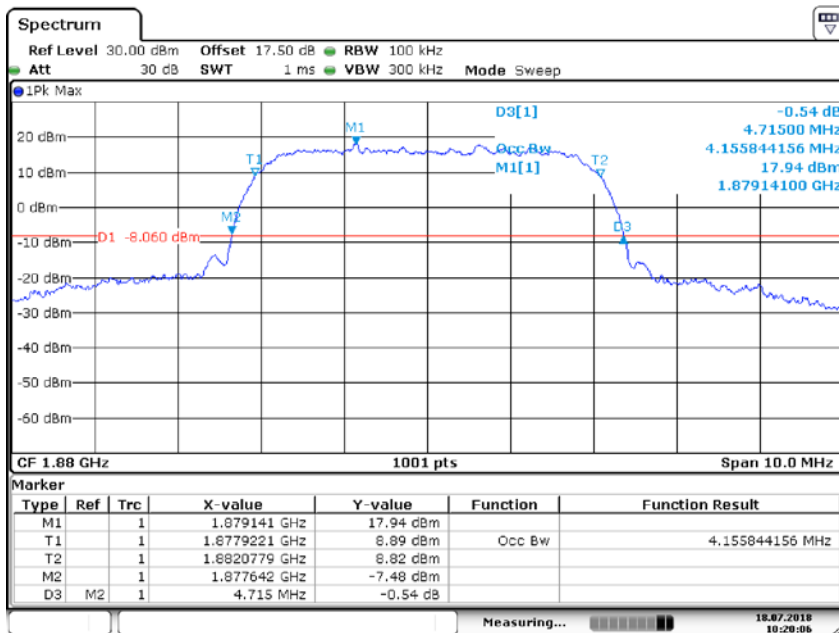

Date: 18.JUL.2018 10:20:07

Test Model	Bandwidth	QPSK Modulation	Frequency(MHz)	1907.6
	WCDMA1900 Test Channel			

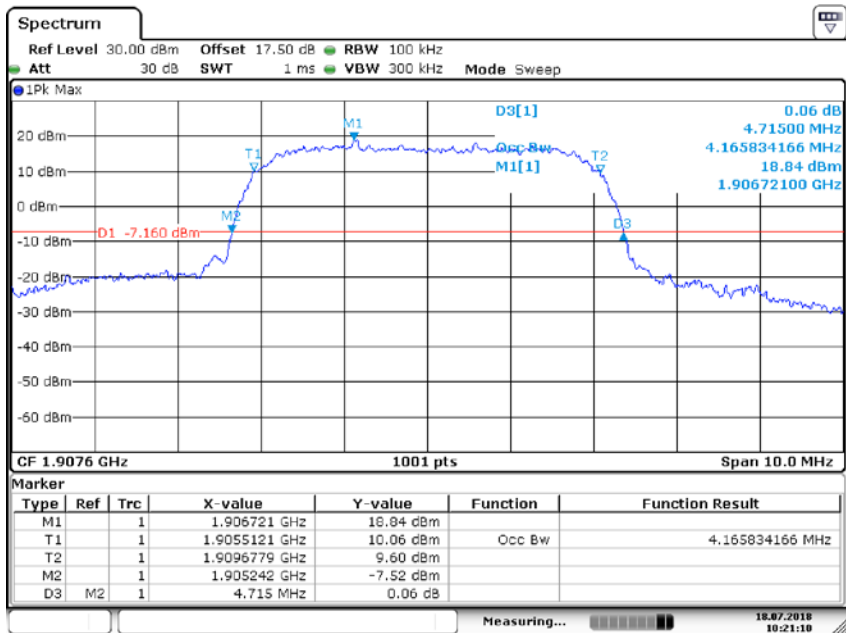

Date: 18.JUL.2018 10:21:10

APPENDIX D: TEST DATA FOR BAND EDGE EMISSION

Test plots as follow:

BAND EDGE EMISSION				
Test Model	WCDMA850	QPSK Modulation	Frequency(MHz)	826.4
	Test Channel	4132		

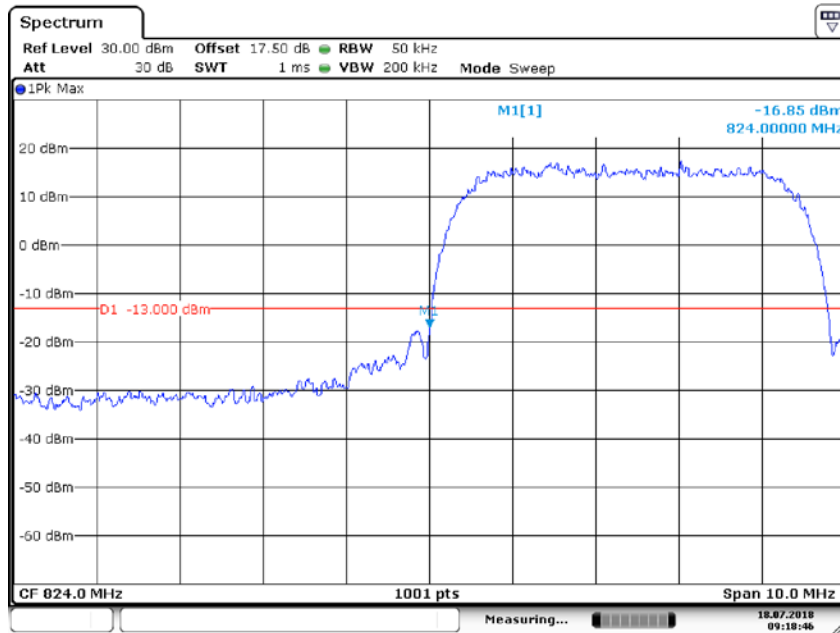

Date: 18 JUL 2018 09:18:45

BAND EDGE EMISSION				
Test Model	WCDMA850	QPSK Modulation	Frequency(MHz)	846.6
	Test Channel	4233		

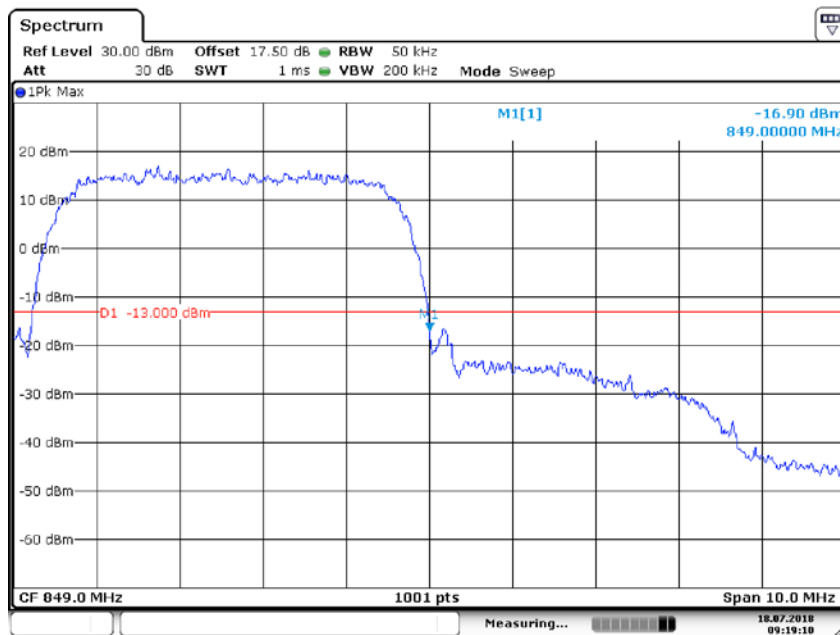

Date: 18 JUL 2018 09:19:10

BAND EDGE EMISSION				
Test Model	WCDMA1700	QPSK Modulation	Frequency(MHz)	1712.4
	Test Channel	1312		

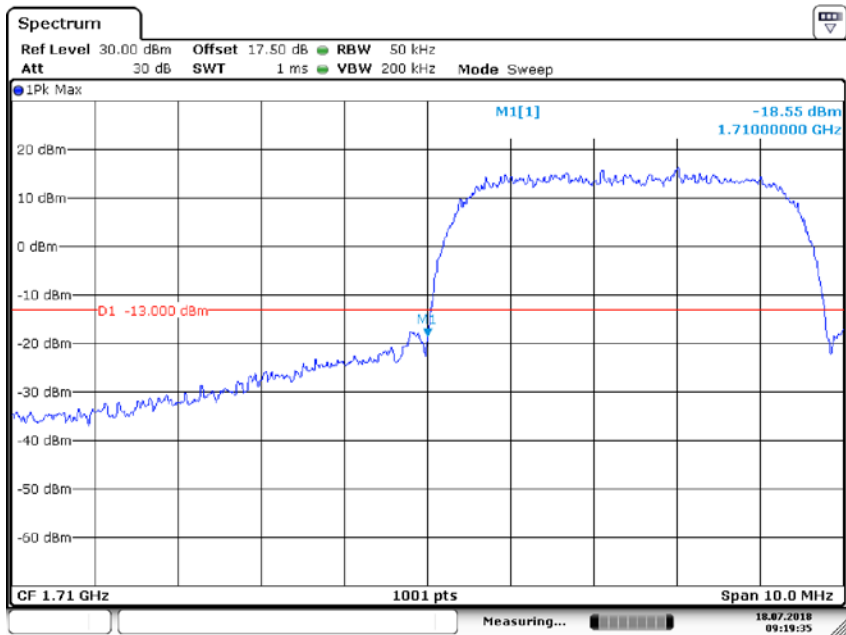

Date: 18 JUL 2018 09:19:35

BAND EDGE EMISSION				
Test Model	WCDMA1700	QPSK Modulation	Frequency(MHz)	1752.6
	Test Channel	1513		

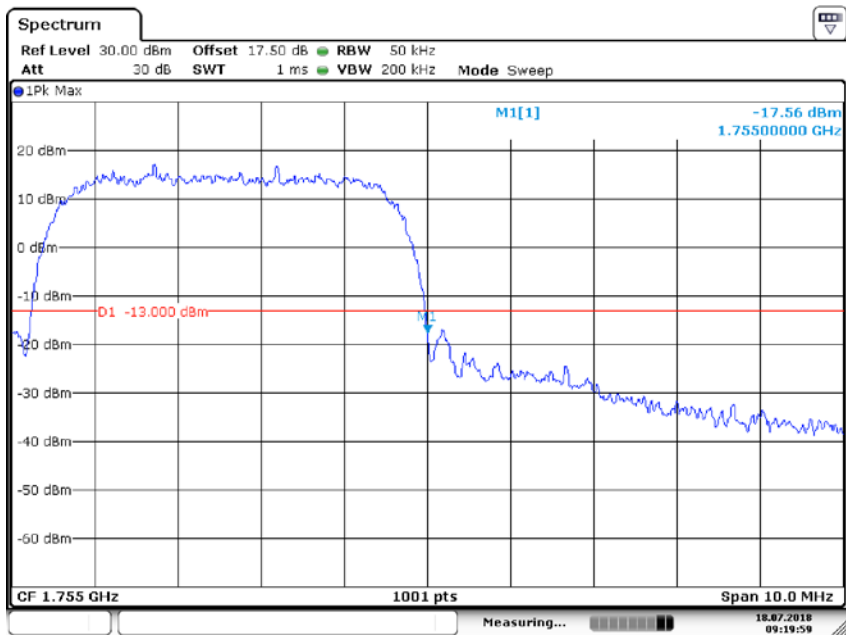

Date: 18 JUL 2018 09:19:58

BAND EDGE EMISSION				
Test Model	WCDMA1900	QPSK Modulation	Frequency(MHz)	1852.4
	Test Channel	9262		

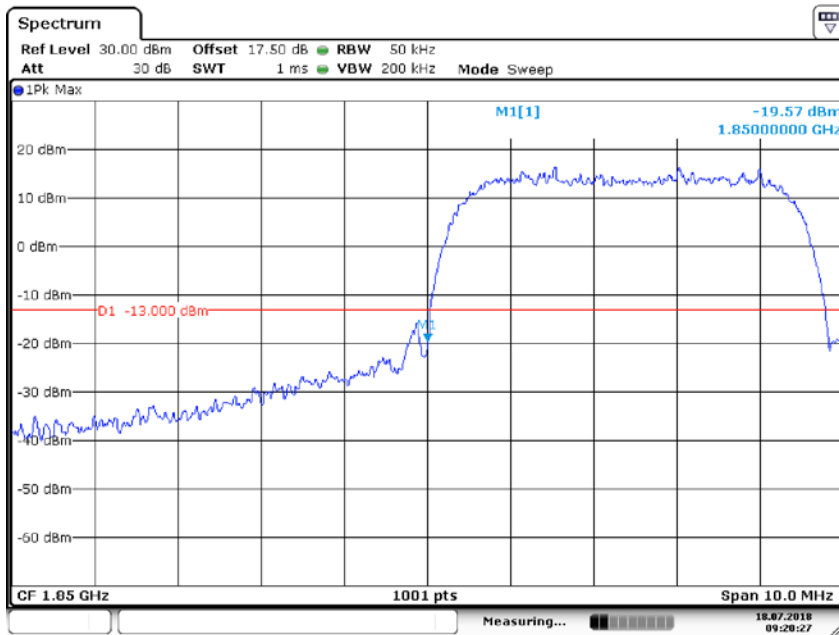

Date: 18 JUL 2018 09:20:27

BAND EDGE EMISSION				
Test Model	WCDMA1900	QPSK Modulation	Frequency(MHz)	1907.6
	Test Channel	9538		

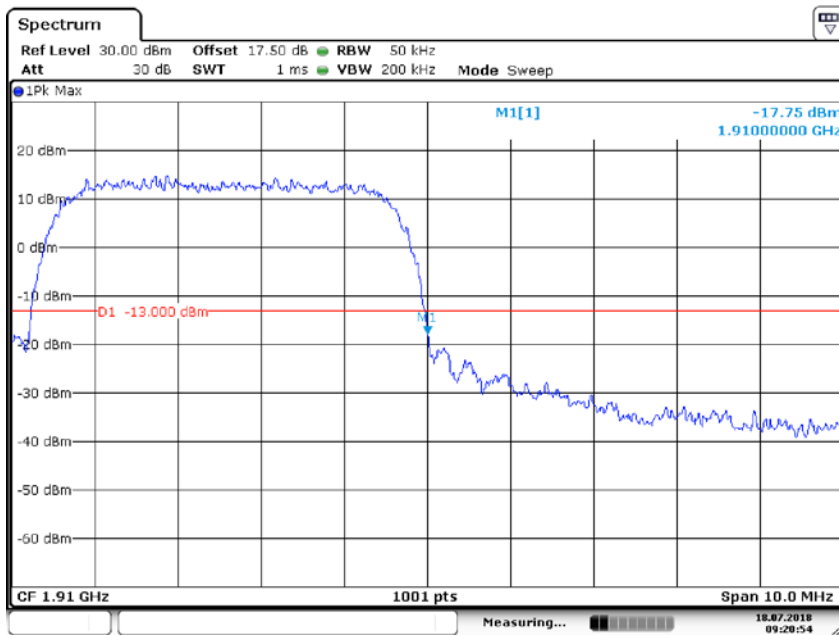

Date: 18 JUL 2018 09:20:54

APPENDIX E: TEST DATA FOR OUT OF BAND EMISSIONS AT ANTENNA TERMINALS

Test plots as follow:

OUT OF BAND EMISSIONS AT ANTENNA TERMINALS				
Test Model	WCDMA850	QPSK Modulation	Frequency(MHz)	826.4
	Test Channel	4132		

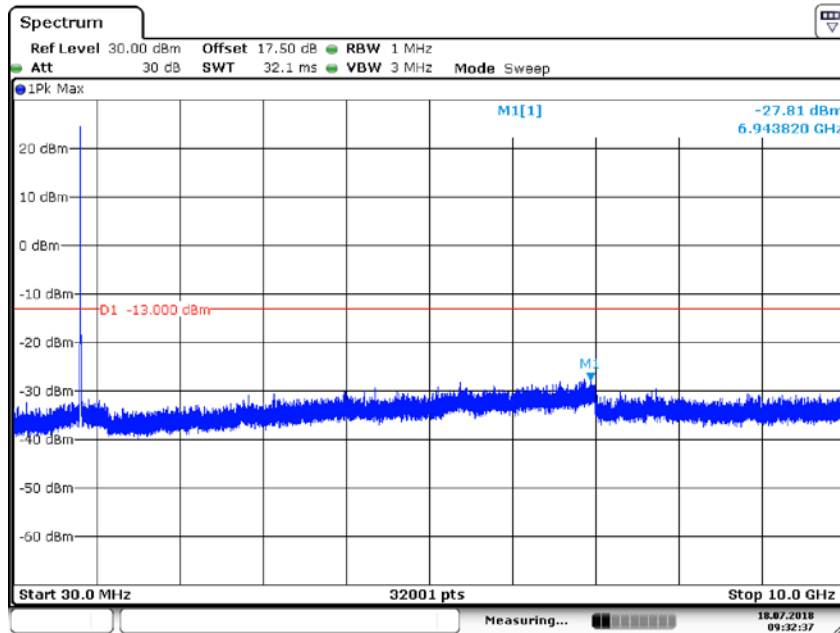

Date: 18 JUL 2018 09:32:37

OUT OF BAND EMISSIONS AT ANTENNA TERMINALS				
Test Model	WCDMA850	QPSK Modulation	Frequency(MHz)	836.4
	Test Channel	4182		

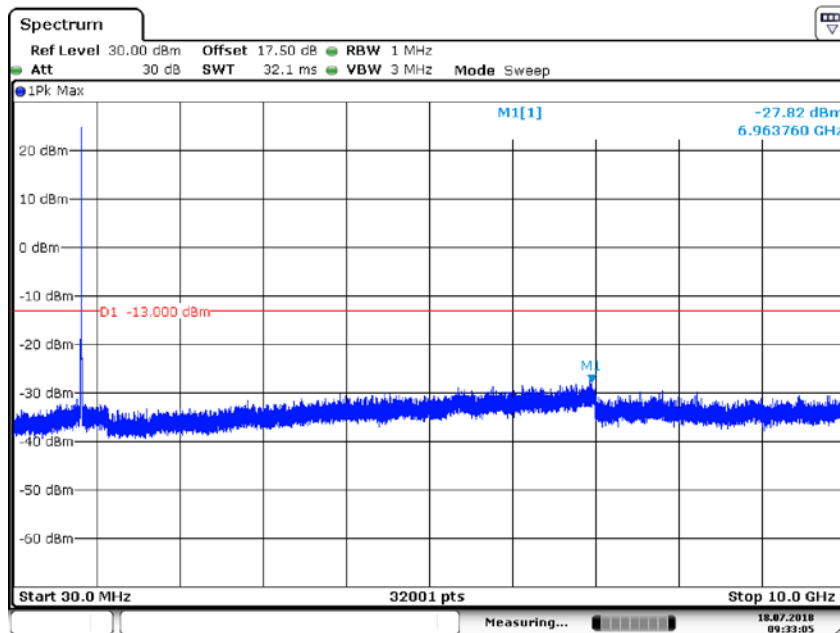

Date: 18 JUL 2018 09:33:05

OUT OF BAND EMISSIONS AT ANTENNA TERMINALS

Test Model	WCDMA850	QPSK Modulation	Frequency(MHz)	846.6
	Test Channel	4233		

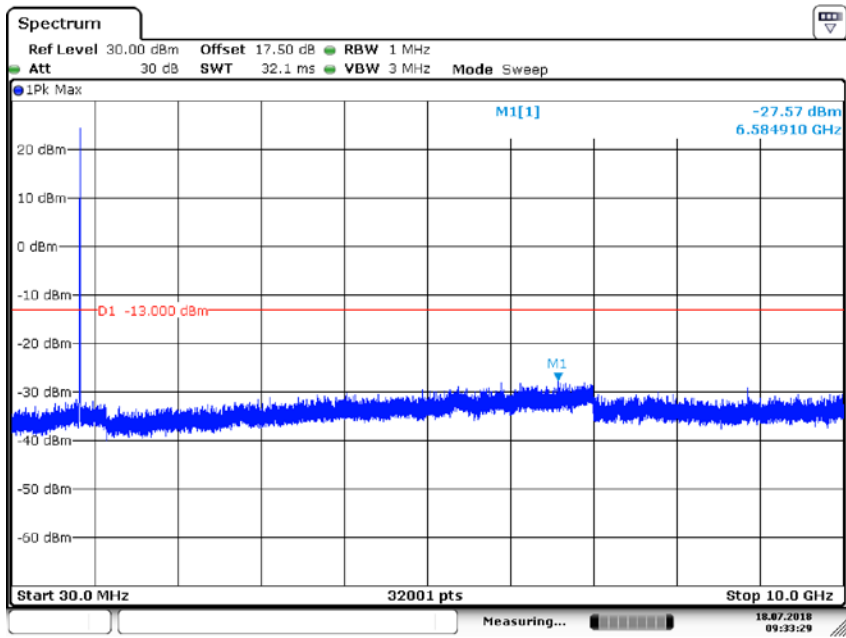

Date: 18 JUL 2018 09:33:29

OUT OF BAND EMISSIONS AT ANTENNA TERMINALS

Test Model	WCDMA1700	QPSK Modulation	
	Test Channel	1312	Frequency(MHz) 1712.4

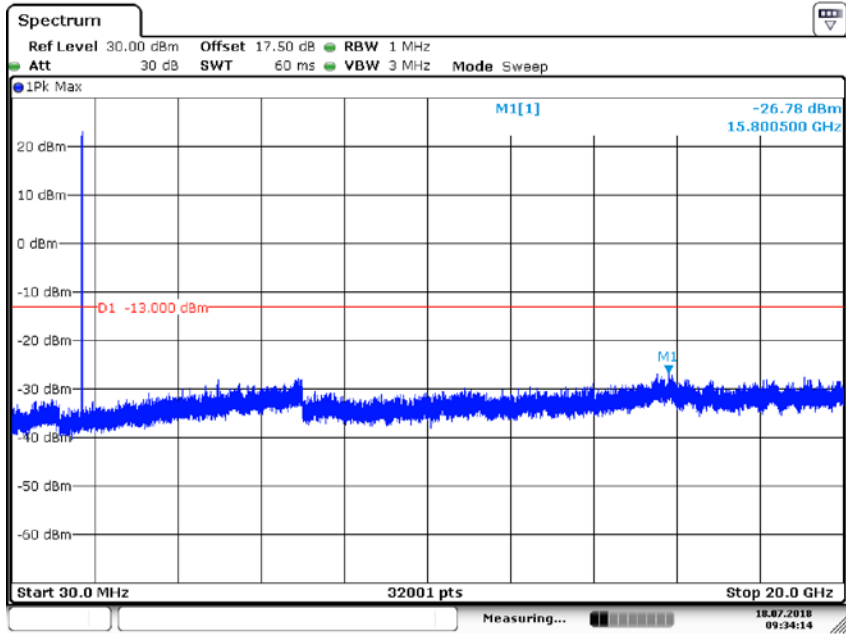

Date: 18 JUL 2018 09:34:15

OUT OF BAND EMISSIONS AT ANTENNA TERMINALS

Test Model	WCDMA1700	QPSK Modulation	
	Test Channel	1413	Frequency(MHz) 1732.6

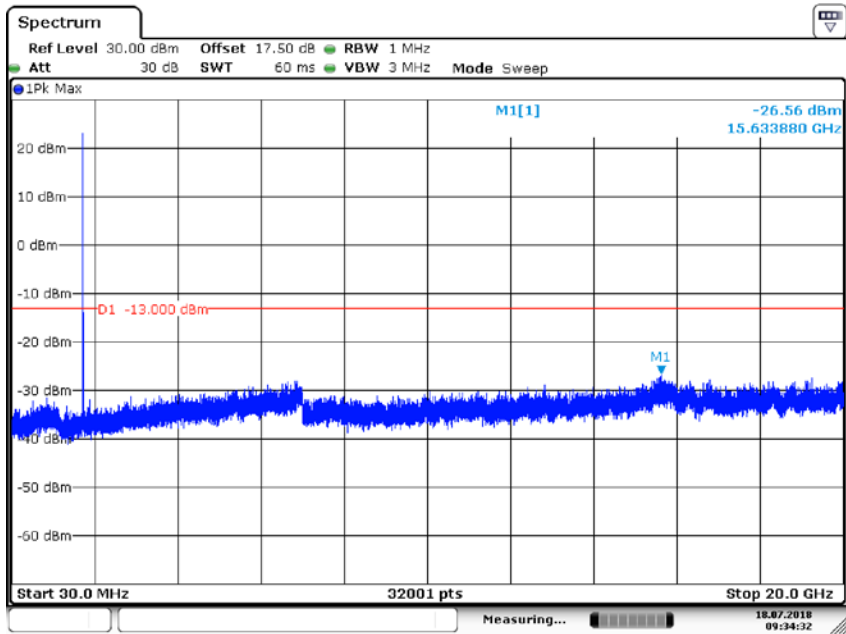

Date: 18 JUL 2018 09:34:31

OUT OF BAND EMISSIONS AT ANTENNA TERMINALS

Test Model	WCDMA1700	QPSK Modulation	Frequency(MHz)	1752.6
	Test Channel	1513		

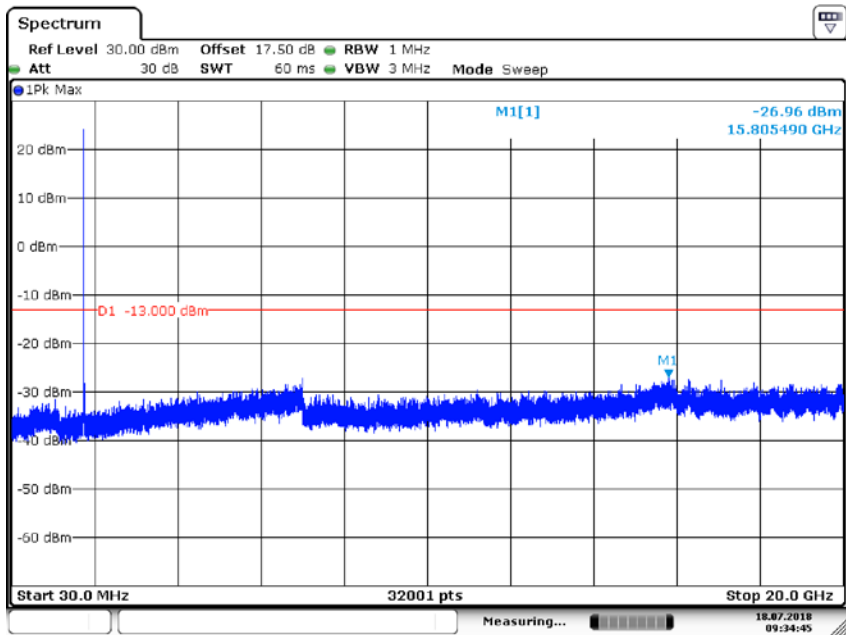

Date: 18 JUL 2018 09:34:45

OUT OF BAND EMISSIONS AT ANTENNA TERMINALS				
Test Model	WCDMA1900	QPSK Modulation	Frequency(MHz)	1852.4
	Test Channel	9262		

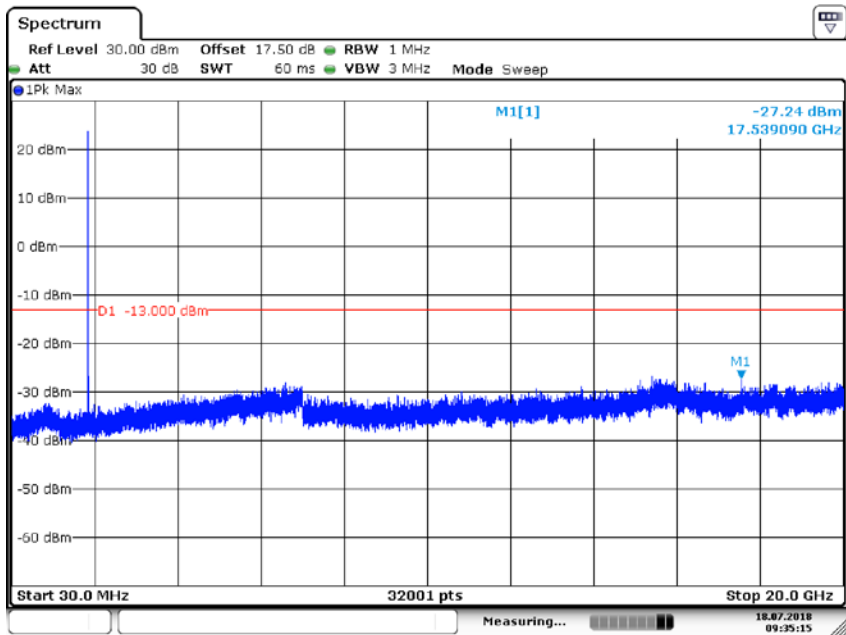

Date: 18 JUL 2018 09:35:15

OUT OF BAND EMISSIONS AT ANTENNA TERMINALS				
Test Model	WCDMA1900	QPSK Modulation	Frequency(MHz)	1880.0
	Test Channel	9400		

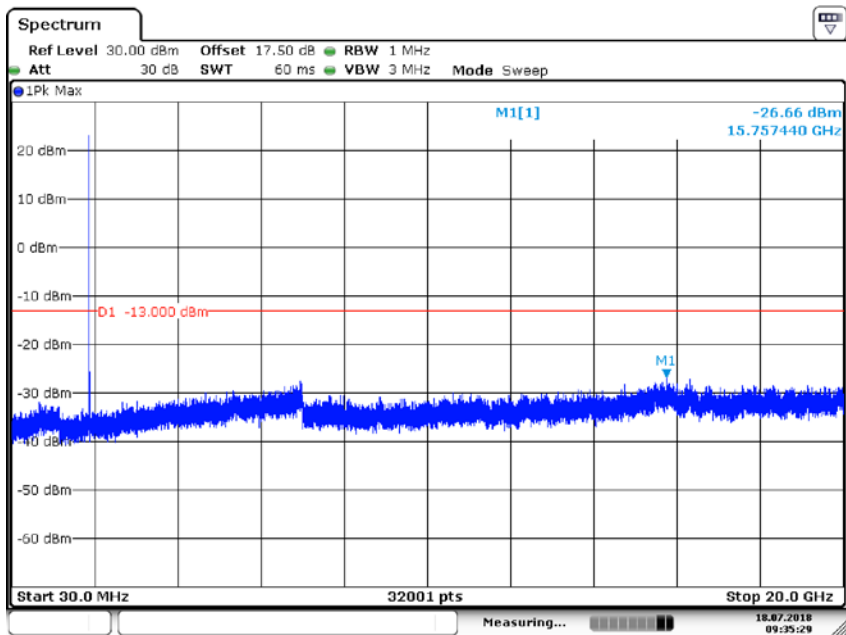

Date: 18 JUL 2018 09:35:29

OUT OF BAND EMISSIONS AT ANTENNA TERMINALS

Test Model	WCDMA1900	QPSK Modulation	Frequency(MHz)	1907.6
	Test Channel	9538		

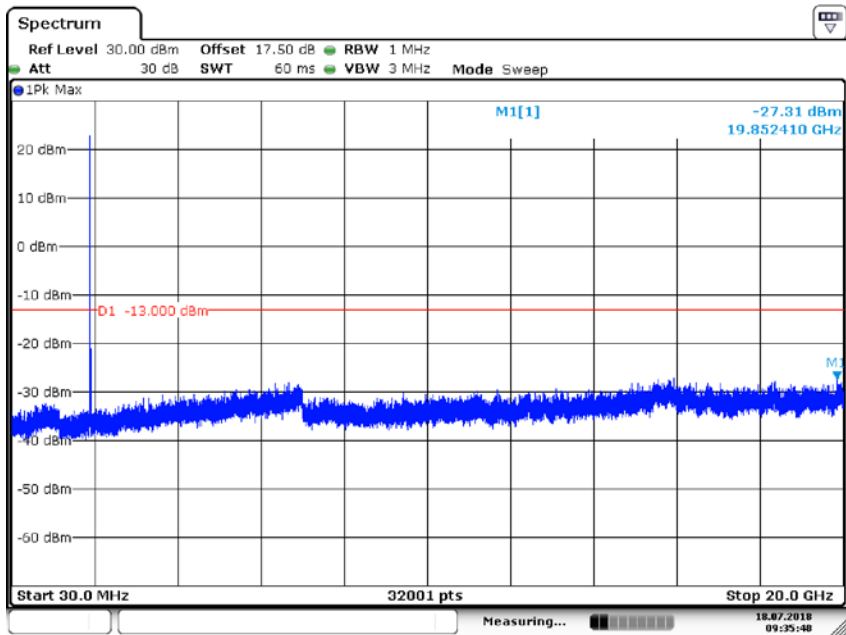

Date: 18 JUL 2018 09:35:48

APPENDIX F: TEST DATA FOR FIELD STRENGTH OF SPURIOUS RADIATION

All modes have been tested, and the worst result recorded was report as below

For WCDMA850 link

- Spurious Emission below 30MHz (9KHz to 30MHz)

Temperature:	24°C	Test By:	KK
Humidity:	53 %		
Test mode:	TX Mode		

Freq. (MHz)	Ant.Pol. H/V	Emission Level(dBuV/m) PK	Limit 3m(dBuV/m) PK	Over(dB) PK
--	--	--	--	--

Note: the amplitude of spurious emission that is attenuated by more than 20dB below the permissible limit has no need to be reported.

- Spurious Emission Above 30MHz (30MHz to 10th harmonics)

Freq. (MHz)	Ant.Pol. H/V	Emission Level (dBm)	Limit (dBm)	Verdict
2479.20	H	-37.17	-13.00	PASS
12100.43	H	-34.80	-13.00	PASS
--	--	--	--	--
2479.20	V	-38.85	-13.00	PASS
12159.93	V	-35.06	-13.00	PASS
--	--	--	--	--

Note: (1) Emission Level= Reading Level+ Correct Factor +Cable Loss.

(2) Correct Factor= Ant_F + Cab_L - Preamp

(3) Data of measurement within this frequency range shown “ -- ” in the table above means the reading of emissions are attenuated more than 20dB below the permissible limits or the field strength is too small to be measured.

For WCDMA1700 link

■ Spurious Emission below 30MHz (9KHz to 30MHz)

Temperature:	24°C	Test By:	KK
Humidity:	53 %		
Test mode:	TX Mode		

Freq. (MHz)	Ant.Pol. H/V	Emission Level(dBuV/m) PK	Limit 3m(dBuV/m) PK	Over(dB) PK
--	--	--	--	--

Note: the amplitude of spurious emission that is attenuated by more than 20dB below the permissible limit has no need to be reported.

■ Spurious Emission Above 30MHz (30MHz to 10th harmonics)

Freq. (MHz)	Ant.Pol. H/V	Emission Level (dBm)	Limit (dBm)	Verdict
5197.80	H	-41.38	-13.00	PASS
13936.09	H	-34.50	-13.00	PASS
--	--	--	--	--
5197.80	V	-42.90	-13.00	PASS
12657.47	V	-35.38	-13.00	PASS
--	--	--	--	--

Note: (1) Emission Level= Reading Level+ Correct Factor +Cable Loss.

(2) Correct Factor= Ant_F + Cab_L - Preamp

(3) Data of measurement within this frequency range shown “ -- ” in the table above means the reading of emissions are attenuated more than 20dB below the permissible limits or the field strength is too small to be measured.

For WCDMA1900 link

■ Spurious Emission below 30MHz (9KHz to 30MHz)

Temperature:	24°C	Test By:	KK
Humidity:	53 %		
Test mode:	TX Mode		

Freq. (MHz)	Ant.Pol. H/V	Emission Level(dBuV/m) PK	Limit 3m(dBuV/m) PK	Over(dB) PK
--	--	--	--	--

Note: the amplitude of spurious emission that is attenuated by more than 20dB below the permissible limit has no need to be reported.

■ Spurious Emission Above 30MHz (30MHz to 10th harmonics)

Freq. (MHz)	Ant.Pol. H/V	Emission Level (dBm)	Limit (dBm)	Verdict
5640.00	H	-41.86	-13.00	PASS
13109.89	H	-34.99	-13.00	PASS
--	--	--	--	--
5640.00	V	-42.55	-13.00	PASS
13985.54	V	-34.58	-13.00	PASS
--	--	--	--	--

Note: (1) Emission Level= Reading Level+ Correct Factor +Cable Loss.

(2) Correct Factor= Ant_F + Cab_L - Preamp

(3) Data of measurement within this frequency range shown “ -- ” in the table above means the reading of emissions are attenuated more than 20dB below the permissible limits or the field strength is too small to be measured.

APPENDIX G: TEST DATA FOR FREQUENCY STABILITY

All modes have been tested, and the worst result recorded was report as below

Temperature:	24°C	Test By:	KK
Humidity:	53 %		

Operation Mode	Channel Number	Test Condition		Channel Frequency (MHz)	Freq.Dev. (Hz)	Deviation (ppm)	Limit (ppm)
		Voltage (V)	Temp (°C)				
WCDMA850	4132	VN	-20	13.62	13.62	0.0165	2.5
			-10	15.99	15.99	0.0193	2.5
			0	18.40	18.40	0.0223	2.5
			10	16.57	16.57	0.0201	2.5
			20	5.97	17.05	0.0206	2.5
			30	16.92	16.92	0.0205	2.5
			40	16.70	16.70	0.0202	2.5
			50	14.31	14.31	0.0173	2.5
		VL	20	17.05	17.05	0.0206	2.5
		VH	20	15.86	15.86	0.0192	2.5
VERDICT				PASS			

Operation Mode	Channel Number	Test Condition		Channel Frequency (MHz)	Freq.Dev. (Hz)	Deviation (ppm)	Limit (ppm)
		Voltage (V)	Temp (°C)				
WCDMA1700	1312	VN	-20	1712.40	13.93	0.0081	2.5
			-10	1712.40	16.23	0.0095	2.5
			0	1712.40	17.78	0.0104	2.5
			10	1712.40	17.40	0.0102	2.5
			20	1712.40	16.50	0.0096	2.5
			30	1712.40	16.69	0.0097	2.5
			40	1712.40	16.90	0.0099	2.5
			50	1712.40	15.27	0.0089	2.5
		VL	20	1712.40	16.50	0.0096	2.5
		VH	20	1712.40	16.00	0.0093	2.5
VERDICT				PASS			

Operation Mode	Channel Number	Test Condition		Channel Frequency (MHz)	Freq.Dev. (Hz)	Deviation (ppm)	Limit (ppm)
		Voltage (V)	Temp (°C)				
WCDMA1900	9262	VN	-20	1852.40	14.85	0.0080	2.5
			-10	1852.40	18.80	0.0101	2.5
			0	1852.40	19.08	0.0103	2.5
			10	1852.40	14.73	0.0080	2.5
			20	1852.40	16.11	0.0087	2.5
			30	1852.40	16.60	0.0090	2.5
			40	1852.40	16.11	0.0087	2.5
			50	1852.40	14.98	0.0081	2.5
		VL	20	1852.40	16.84	0.0091	2.5
		VH	20	1852.40	16.92	0.0091	2.5
VERDICT				PASS			

APPENDIX H: TEST DATA FOR PEAK TO AVERAGE RATIO

Temperature:	24°C	Test By:	KK
Humidity:	53 %		

Operation Mode	Modulation	Channel Number	Channel Frequency (MHz)	P. A .R (dB)	Limit (dB)	Verdict
WCDMA1700	QPSK	1312	1712.4	3.77	13	Pass
		1413	1732.6	2.39	13	Pass
		1513	1752.6	3.68	13	Pass
WCDMA1900	QPSK	9262	1852.4	3.33	13	Pass
		9400	1880.0	3.36	13	Pass
		9538	1907.6	3.35	13	Pass

Detail of factor for radiated emission

Frequency(MHz)	Ant_F(dB)	Cab_L(dB)	Preamp(dB)	Correct Factor(dB)
0.009	20.6	0.03	\	20.63
0.15	20.7	0.1	\	20.8
1	20.9	0.15	\	21.05
10	20.1	0.28	\	20.38
30	18.8	0.45	\	19.25
30	11.7	0.62	27.9	-15.58
100	12.5	1.02	27.8	-14.28
300	12.9	1.91	27.5	-12.69
600	19.2	2.92	27	-4.88
800	21.1	3.54	26.6	-1.96
1000	22.3	4.17	26.2	0.27
1000	25.6	1.76	41.4	-14.04
3000	28.9	3.27	43.2	-11.03
5000	31.1	4.2	44.6	-9.3
8000	36.2	5.95	44.7	-2.55
10000	38.4	6.3	43.9	0.8
12000	38.5	7.14	42.3	3.34
15000	40.2	8.15	41.4	6.95
18000	45.4	9.02	41.3	13.12
18000	37.9	1.81	47.9	-8.19
21000	37.9	1.95	48.7	-8.85
25000	39.3	2.01	42.8	-1.49
28000	39.6	2.16	46.0	-4.24
31000	41.2	2.24	44.5	-1.06
34000	41.5	2.29	46.6	-2.81
37000	43.8	2.30	46.4	-0.3
40000	43.2	2.50	42.2	3.5

END OF REPORT