

FCC

CERTIFICATION TEST REPORT

For

Tablet PC

MODEL No.: xTablet A1150

FCC ID: O86A1150

Trademark: MobileDemand

REPORT NO.: ES180507073W07

ISSUE DATE: July 18, 2018

Prepared for

MobileDemand, L.C.

1501 Boyson Sq Dr, Ste 101 Hiawatha, Iowa, 52233, United States

Prepared by

EMTEK (SHENZHEN) CO., LTD.

Bldg 69, Majialong Industry Zone, Nanshan District, Shenzhen,

Guangdong, China

TEL: 86-755-26954280

FAX: 86-755-26954282

Table of Contents

1	TEST RESULT CERTIFICATION	3
2	EUT TECHNICAL DESCRIPTION	4
3	SUMMARY OF TEST RESULT	6
3.1	TEST ITEM	6
3.2	OUTLINE OF EUT	6
4	TEST METHODOLOGY	7
4.1	GENERAL DESCRIPTION OF APPLIED STANDARDS	7
4.2	MEASUREMENT EQUIPMENT USED	7
4.3	DESCRIPTION OF TEST MODES	8
5	FACILITIES AND ACCREDITATIONS	13
5.1	FACILITIES	13
5.2	LABORATORY ACCREDITATIONS AND LISTINGS	13
6	TEST SYSTEM UNCERTAINTY	14
7	SETUP OF EQUIPMENT UNDER TEST	15
7.1	RADIO FREQUENCY TEST SETUP 1	15
7.2	RADIO FREQUENCY TEST SETUP 2	15
7.3	SUPPORT EQUIPMENT	17
8	TEST REQUIREMENTS	18
8.1	RF POWER OUTPUT	18
8.2	EFFECTIVE (ISOTROPIC) RADIATED POWER	19
8.3	MODULATION CHARACTERISTICS	21
8.4	OCCUPIED BANDWIDTH	22
8.5	BAND EDGE EMISSION	24
8.6	OUT OF BAND EMISSIONS AT ANTENNA TERMINALS	26
8.7	FIELD STRENGTH OF SPURIOUS RADIATION	28
8.8	FREQUENCY STABILITY	30
8.9	PEAK TO AVERAGE RATIO	31
APPENDIX A: TEST DATA FOR RF POWER OUTPUT		32
APPENDIX B: TEST DATA FOR EFFECTIVE (ISOTROPIC) RADIATED POWER		54
APPENDIX C: TEST DATA FOR OCCUPIED BANDWIDTH		76
APPENDIX D: TEST DATA FOR BAND EDGE EMISSION		99
APPENDIX E: TEST DATA FOR OUT OF BAND EMISSIONS AT ANTENNA TERMINALS		165
APPENDIX F: TEST DATA FOR FIELD STRENGTH OF SPURIOUS RADIATION		182
APPENDIX G: TEST DATA FOR FREQUENCY STABILITY		196
APPENDIX H: TEST DATA FOR PEAK TO AVERAGE RATIO		229

1 TEST RESULT CERTIFICATION

Applicant:	MobileDemand, L.C. 1501 Boyson Sq Dr, Ste 101 Hiawatha, Iowa, 52233, United States
Manufacturer:	MobileDemand, L.C. No.88 East Qianjin Road, Kunshan city, Jiangsu province, China
Product Description:	Tablet PC
Trademark:	MobileDemand
Model Number:	xTablet A1150

Measurement Procedure Used:

APPLICABLE STANDARDS	
STANDARD	TEST RESULT
FCC 47 CFR Part 2, Subpart J FCC 47 CFR Part 22, Subpart H FCC 47 CFR Part 24, Subpart E FCC 47 CFR Part 27	PASS

The above equipment was tested by EMTEK (SHENZHEN) CO., LTD. The test data, data evaluation, test procedures, and equipment configurations shown in this report were made in accordance with the procedures given in ANSI C63.25 (2015) and the energy emitted by the sample EUT tested as described in this report is in compliance with the requirements of FCC Rules Part 2, 22(H), 24(E), 27.

The test results of this report relate only to the tested sample identified in this report

Date of Test : June 01, 2018 to July 18, 2018

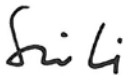
Prepared by : 
Sevin Li/Editor

Reviewer : 
Joe Xia/Supervisor

Approve & Authorized Signer : 
Lisa Wang/Manager



2 EUT TECHNICAL DESCRIPTION

Characteristics	Description	
Device Type	Potable Equipment For LTE	
Operation Band:	LTE BAND2, LTE BAND4, LTE BAND5, LTE BAND7, LTE BAND12, LTE BAND13, LTE BAND25, LTE BAND26, LTE BAND30, LTE BAND41,	
Modulation:	QPSK, 16QAM	
Operating Frequency Range(s):	FDD: TX 1850 to 1910MHz /RX 1930 to 1990MHz for LTE BAND2 TX 1710 to 1755MHz /RX 2110 to 2155MHz for LTE BAND4 TX 824 to 849MHz /RX 869 to 894MHz for LTE BAND5 TX 2500 to 2570MHz /RX 2620 to 2690MHz for LTE BAND7 TX 699 to 716MHz /RX 729 to 746MHz for LTE BAND12 TX 777 to 787MHz /RX 746 to 756MHz for LTE BAND13 TX 1850 to 1915MHz /RX 1930 to 1995MHz for LTE BAND25 TX 824 to 849MHz /RX 869 to 894MHz for LTE BAND26 TX 2305 to 2315MHz /RX 2350 to 2360MHz for LTE BAND30 TDD: TX/RX 2496-2690MHz for LTE BAND41	
Supported Channel Bandwidth:	LTE BAND2	<input checked="" type="checkbox"/> 1.4MHz, <input checked="" type="checkbox"/> 3MHz, <input checked="" type="checkbox"/> 5MHz, <input checked="" type="checkbox"/> 10MHz, <input checked="" type="checkbox"/> 15MHz, <input checked="" type="checkbox"/> 20MHz,
	LTE BAND4	<input checked="" type="checkbox"/> 1.4MHz, <input checked="" type="checkbox"/> 3MHz, <input checked="" type="checkbox"/> 5MHz, <input checked="" type="checkbox"/> 10MHz, <input checked="" type="checkbox"/> 15MHz, <input checked="" type="checkbox"/> 20MHz,
	LTE BAND5	<input checked="" type="checkbox"/> 1.4MHz, <input checked="" type="checkbox"/> 3MHz, <input checked="" type="checkbox"/> 5MHz, <input checked="" type="checkbox"/> 10MHz
	LTE BAND7	<input checked="" type="checkbox"/> 5MHz, <input checked="" type="checkbox"/> 10MHz, <input checked="" type="checkbox"/> 15MHz, <input checked="" type="checkbox"/> 20MHz,
	LTE BAND12	<input checked="" type="checkbox"/> 1.4MHz, <input checked="" type="checkbox"/> 3MHz, <input checked="" type="checkbox"/> 5MHz, <input checked="" type="checkbox"/> 10MHz
	LTE BAND13	<input checked="" type="checkbox"/> 5MHz, <input checked="" type="checkbox"/> 10MHz
	LTE BAND25	<input checked="" type="checkbox"/> 1.4MHz, <input checked="" type="checkbox"/> 3MHz, <input checked="" type="checkbox"/> 5MHz, <input checked="" type="checkbox"/> 10MHz, <input checked="" type="checkbox"/> 15MHz, <input checked="" type="checkbox"/> 20MHz,
	LTE BAND26	<input checked="" type="checkbox"/> 1.4MHz, <input checked="" type="checkbox"/> 3MHz, <input checked="" type="checkbox"/> 5MHz, <input checked="" type="checkbox"/> 10MHz, <input checked="" type="checkbox"/> 15MHz
	LTE BAND30	<input checked="" type="checkbox"/> 5MHz, <input checked="" type="checkbox"/> 10MHz
LTE BAND41	<input checked="" type="checkbox"/> 5MHz, <input checked="" type="checkbox"/> 10MHz, <input checked="" type="checkbox"/> 15MHz, <input checked="" type="checkbox"/> 20MHz,	
TX and RX Antenna:	Ant1 (Main Antenna)-Support Transmit and Receive Ant2 (Slave Antenna)-Only Support Receive Remark: Ant2 cannot work independently, it only assists receiving function with the main antenna	
Antenna Type	FPC antenna	
Antenna Gain	4.8dBi for LTE BAND2 4.7dBi for LTE BAND4 3.7dBi for LTE BAND5 1.88dBi for LTE BAND7 4.1dBi for LTE BAND12 4.1dBi for LTE BAND13 4.8dBi for LTE BAND25 3.7dBi for LTE BAND26	

	1.88dBi for LTE BAND30 1.88dBi for LTE BAND41
Power supply	<input checked="" type="checkbox"/> DC 3.7V internal rechargeable lithium battery <input checked="" type="checkbox"/> DC 19V from Adapter
	<input checked="" type="checkbox"/> Adapter: Model: ADP-65JH HB INPUT: 100-240V~ 1.5A 50-60Hz OUTPUT: DC 19V, 3.42A
Battery information:	Rating: DC 3.7V, 10800mAh, 39.96Wh

Note: for more details, please refer to the User's manual of the EUT.

3 SUMMARY OF TEST RESULT

3.1 TEST ITEM

FCC Rule	Test Parameter	Verdict	Remark
2.1046	RF Power Output	PASS	
22.913, 24.232, 27.50	Equivalent (Isotropic) Radiated Power	PASS	
2.1047	Modulation Characteristics	PASS	
2.1049	Occupied Bandwidth	PASS	
2.1051, 22.917, 24.238, 27.53	Out of Band Emissions at Antenna Terminals	PASS	
	Band Edge Emission	PASS	
2.1053, 22.917, 24.238, 27.53	Field Strength of Spurious Radiation	PASS	
2.1055, 22.355, 24.235, 27.54	Frequency Stability versus Temperature	PASS	
	Frequency Stability versus Voltage	PASS	
24.232, 27.50	Peak to Average Ratio	PASS	
NOTE1: N/A (Not Applicable)			

RELATED SUBMITTAL(S) / GRANT(S):

This submittal(s) (test report) is intended for FCC ID: O86A1150 filing to comply with FCC 47 CFR Part 2, 22(H), 24(E), 27

The system is compliance with Subpart B is authorized under a DOC procedure

3.2 OUTLINE OF EUT

The T1150 sample, for LTE band supporting B2/B4/B5/B7/B12/B13/B25/B26/B30/B41, The uplink frequency band of LTE B2 is covered by B25, the uplink frequency band of LTE B5 is covered by B26. For test reduction, the bands covered by other bands, e.g., B2/B5 are reduced. The uplink frequencies and bandwidth configurations information are as following table:

Band No.	Frequency range (MHz)	Bandwidth configurations (MHz)	Note
2	1850 - 1910	1.4/3/5/10/15/20	Covered by B25 (B2 is a subset of B25. Both bands share the same hardware and have the same radio performance. Separate measurement in B2 is not required.)
4	1710 - 1755	1.4/3/5/10/15/20	--
5	824 - 849	1.4/3/5/10	Covered by B26 (B5 is a subset of B26. Both bands share the same hardware and have the same radio performance. Separate measurement in B5 is not required.)
7	2500 - 2570	5/10/15/20	--
12	699 - 716	1.4/3/5/10	--
13	777 - 787	5/10	--
25	1850 - 1915	1.4/3/5/10/15/20	--
26	824 - 849	1.4/3/5/10/15	--
30	2305 - 2315	5/10	--
41	2496 - 2690	5/10/15/20	TDD

4 TEST METHODOLOGY

4.1 GENERAL DESCRIPTION OF APPLIED STANDARDS

According to its specifications, the EUT must comply with the requirements of the following standards:

FCC 47 CFR Part 2, Subpart J

FCC 47 CFR Part 22H

FCC 47 CFR Part 24E

FCC 47 CFR Part 27

KDB971168 D01: v02r02

ANSI/TIA-603-D-2010

ANSI C63.26:2015

4.2 MEASUREMENT EQUIPMENT USED

4.2.1 Radiated Emission Test Equipment

EQUIPMENT TYPE	MFR	MODEL NUMBER	SERIAL NUMBER	LAST CAL.
EMI Test Receiver	R & S	ESU	1302.6005.26	May 20, 2018
Pre-Amplifier	HP	8447D	2944A07999	May 19, 2018
Bilog Antenna	Schwarzbeck	VULB9163	142	May 19, 2018
Bilog Antenna	Schwarzbeck	VULB9163	141	May 19, 2018
Loop Antenna	ARA	PLA-1030/B	1029	May 19, 2018
Horn Antenna	Schwarzbeck	BBHA 9170	BBHA9170399	May 20, 2018
Horn Antenna	Schwarzbeck	BBHA 9120	D143	May 19, 2018
Cable	Schwarzbeck	AK9513	ACRX1	May 20, 2018
Cable	Rosenberger	N/A	FP2RX2	May 20, 2018
Cable	Schwarzbeck	AK9513	CRPX1	May 20, 2018
Cable	Schwarzbeck	AK9513	CRRX2	May 20, 2018
Cable	H+B	0.5M SF104-26.5	289147/4	May 20, 2018
Cable	H+B	3M SF104-26.5	295838/4	May 20, 2018
Cable	H+B	6M SF104-26.5	295840/4	May 20, 2018

4.2.2 Radio Frequency Test Equipment

EQUIPMENT TYPE	MFR	MODEL NUMBER	SERIAL NUMBER	LAST CAL.
Spectrum Analyzer	Agilent	E4407B	88156318	May 20, 2018
Power meter	Anritsu	ML2495A	0824006	May 20, 2018
Power sensor	Anritsu	MA2411B	0738172	May 20, 2018
Spectrum Analyzer	Agilent	N9010A	My53470879	May 20, 2018
Spectrum Analyzer	R & S	FSV30	103040	May 20, 2018
Spectrum Analyzer	R & S	FSV40	132.1-3008K39-100967-AP	May 20, 2018
Universal Radio Communication	R&S	CMW500	1201.0002K50-140822zk	May 20, 2018
Universal Radio Communication	R&S	CMU200	111226	May 20, 2018
Power Splitter	MInI-Clrucits	ZFRSC-183-S +	S F808201417	May 20, 2018
Attenuator	Weinschel Associates	WA14	18-10-12	May 20, 2018
Temp. / Humidity Chamber	Kingson	THS-M1	242	May 20, 2018

Remark: Each piece of equipment is scheduled for calibration once a year.

4.3 DESCRIPTION OF TEST MODES

The EUT has been tested under its typical operating condition. The CMU200 and CMW500 used to control the EUT staying in continuous transmitting and receiving mode for testing.

The EUT configuration for testing is installed on RF field strength measurement to meet the Commissions requirement and operating in a manner which intends to maximize its emission characteristics in a continuous normal application.

During all testing, EUT is in link mode with base station emulator at maximum power level.

The Transmitter was operated in the normal operating mode. The TX frequency was fixed which was for the purpose of the measurements.

Test of channel included the lowest and middle and highest frequency to perform the test, then record on this report.

Pre-defined engineering program for regulatory testing used to control the EUT for staying in continuous transmitting and receiving mode is programmed.

■ Test Mode and system config

Configure the CMW500 call box to support all LTE tests in respect to the 3GPP 36.521.

UE term. Conn: User defined Channels

Exp. Nominal Power Mode: According to UL Power Control Settings

RS EPRE: -75.0 dBm/15kHz Full Cell BW Power: -50.2 dBm

PSS Power Offset = SSS Power Offset = PBCH Power Offset = PCFICH Power Offset = PDCCH Power Offset = 0.0 dB

PHICH Power Offset = -12 dB

OCNG ON

PDSCH Power Offset PA: 0 dB, Power Ratio Index PB: 0 (rhoB/rhoA: 1)

Active TPC Setup: Max Power

Security Settings: Authentication OFF, NAS Security OFF, AS Security OFF

Integrity Algorithm: NULL

Milenage OFF

Configure the desired channel, BW, resource block allocation and modulation.

Connect to test set.

Set CMW500 TPC Setup to Max Power (Up power control command).

According to 3GPP 36.521, V9.1.0., the output power level for Power Class 3 LTE is to be 23.0dBm + 2.7dB. The lower limit is shifted down by the MPR amount allowed for certain configurations. Maximum Power Reduction (MPR) is allowed due to higher order modulation and transmit bandwidth configurations. These MPR levels reduce the lower limit of each output power by the either 1 or 2dB per 3GPP 36.521.

Modulation	Channel bandwidth / Transmission bandwidth configuration[RB]						MPR (dB)
	1.4MHz	3MHz	5MHz	10MHz	15MHz	20MHz	
QPSK	> 5	> 4	> 8	> 12	> 16	> 18	≤ 1
16 QAM	≤ 5	≤ 4	≤ 8	≤ 12	≤ 16	≤ 18	≤ 1
16 QAM	> 5	> 4	> 8	> 12	> 16	> 18	≤ 2

■ Test Environment

Environment Parameter	Selected Values During Tests	
Relative Humidity	Ambient	
Temperature	TN	Ambient
Ambient	VL	3.03V
	VN	3.7V
	VH	4.07V
NOTE: VL= Lower Extreme Test Voltage VN= Nominal Voltage VH= Upper Extreme Test Voltage TN= Normal Temperature		

■ Test Channel and Frequency

Test Mode	Bandwidth	TX / RX	RF Channel		
			Low (L)	Middle (M)	High (H)
LTE BAND2	1.4MHz	TX	Channel 18607	Mid CH 18900	High CH 19193
			1850.7 MHz	1880.0 MHz	1909.3 MHz
	RX	Channel 607	Channel 900	Channel 1193	
		1930.7 MHz	1960 MHz	1989.3MHz	
	3MHz	TX	Channel 18615	Channel 18900	Channel 19185
			1851.5MHz	1880.0MHz	1908.5MHz
	RX	Channel 615	Channel 900	Channel 1185	
		1931.5 MHz	1960 MHz	1988.5 MHz	
	5MHz	TX	Channel 18625	Channel 18900	Channel 19175
			1852.5 MHz	1880 MHz	1907.5 MHz
	RX	Channel 625	Channel 900	Channel 1175	
		1932.5 MHz	1960 MHz	1987.5 MHz	
	10MHz	TX	Channel 18650	Channel 18900	Channel 19150
			1855 MHz	1880 MHz	1905 MHz
	RX	Channel 650	Channel 900	Channel 1150	
		1935 MHz	1960 MHz	1985 MHz	
	15MHz	TX	Channel 18675	Channel 18900	Channel 19125
			1857.5 MHz	1880 MHz	1902.5 MHz
	RX	Channel 675	Channel 900	Channel 1125	
		1937.5 MHz	1960 MHz	1982.5 MHz	
20MHz	TX	Channel 18700	Channel 18900	Channel 19100	
		1860 MHz	1880 MHz	1900 MHz	
RX	Channel 700	Channel 900	Channel 1100		
	1940 MHz	1960 MHz	1980 MHz		

Test Mode	Bandwidth	TX / RX	RF Channel		
			Low (L)	Middle (M)	High (H)
LTE BAND4	1.4MHz	TX	Channel 19957	Channel 20175	Channel 20393
			1710.7 MHz	1732.5 MHz	1754.3 MHz
	RX	Channel 1957	Channel 2175	Channel 2393	
		2110.7 MHz	2132.5MHz	2154.3 MHz	
	3MHz	TX	Channel 19965	Channel 20175	Channel 20385
			1711.5 MHz	1732.5 MHz	1753.5 MHz
	RX	Channel 2000	Channel 2175	Channel 2350	
		2111.5 MHz	2132.5MHz	2153.5 MHz	
	5MHz	TX	Channel 19975	Channel 20175	Channel 20375
			1712.5 MHz	1732.5 MHz	1752.5 MHz
RX	Channel 1975	Channel 2175	Channel 2375		

	10MHz	TX	2112.5 MHz	2132.5MHz	2152.5 MHz
			Channel 20000	Channel 20175	Channel 20350
			1715 MHz	1732.5 MHz	1750 MHz
		RX	Channel 2000	Channel 2175	Channel 2350
			2115 MHz	2132.5MHz	2150 MHz
			Channel 20025	Channel 20175	Channel 20325
	15MHz	TX	1717.5 MHz	1732.5 MHz	1747.5 MHz
			Channel 2025	Channel 2175	Channel 2325
			2117.5 MHz	2132.5MHz	2147.5 MHz
		RX	Channel 20050	Channel 20175	Channel 20300
			1720 MHz	1732.5 MHz	1745 MHz
			Channel 2050	Channel 2175	Channel 2300
20MHz	RX	2120 MHz	2132.5MHz	2145 MHz	

Test Mode	Bandwidth	TX / RX	RF Channel		
			Low (L)	Middle (M)	High (H)
LTE BAND5	1.4MHz	TX	Channel 20407	Channel 20525	Channel 20643
			824.7 MHz	836.5 MHz	848.3 MHz
		RX	Channel 8697	Channel 2525	Channel 2643
			859.7 MHz	881.5 MHz	893.3 MHz
	3MHz	TX	Channel 20415	Channel 20525	Channel 20635
			825.5 MHz	836.5 MHz	847.5 MHz
		RX	Channel 2415	Channel 2525	Channel 2635
			870.5 MHz	881.5 MHz	892.5 MHz
	5MHz	TX	Channel 20425	Channel 20525	Channel 20625
			826.5 MHz	836.5 MHz	846.5 MHz
		RX	Channel 2425	Channel 2525	Channel 2625
			871.5 MHz	881.5 MHz	891.5 MHz
10MHz	TX	Channel 20450	Channel 20525	Channel 20600	
		829 MHz	836.5 MHz	844 MHz	
	RX	Channel 2450	Channel 2525	Channel 2600	
		874 MHz	881.5 MHz	889 MHz	

LTE BAND26	1.4MHz	TX	Channel 26697	Channel 26865	Channel 27033
			814.7 MHz	831.5 MHz	848.3 MHz
		RX	Channel 8697	Channel 8865	Channel 9033
			859.7 MHz	876.5 MHz	893.3 MHz
	3MHz	TX	Channel 26705	Channel 26865	Channel 27025
			815.5 MHz	831.5 MHz	847.5 MHz
RX	Channel 8705	Channel 8865	Channel 9025		
		860.5 MHz	876.5 MHz	892.5 MHz	

Test Mode	Bandwidth	TX / RX	RF Channel		
			Low (L)	Middle (M)	High (H)
LTE BAND7	5MHz	TX	Channel 20775	Channel 21100	Channel 21425
			2502.5 MHz	2535 MHz	2567.5 MHz
		RX	Channel 2775	Channel 3100	Channel 3425
			2622.5 MHz	2655 MHz	2687.5 MHz
	10MHz	TX	Channel 20800	Channel 21100	Channel 21400
			2505 MHz	2535 MHz	2565 MHz
		RX	Channel 2800	Channel 3100	Channel 3400
			2625 MHz	2655 MHz	2685MHz
	15MHz	TX	Channel 20825	Channel 21100	Channel 21375
			2507.5 MHz	2535 MHz	2562.5 MHz

		RX	Channel2825	Channel 3100	Channel3375
			2627.5 MHz	2655 MHz	2682.5 MHz
	20MHz	TX	Channel 20850	Channel 3100	Channel 21350
			2510 MHz	2655 MHz	2560 MHz
		RX	Channel 2850	Channel 3100	Channel 3350
			2630 MHz	2655 MHz	2680 MHz

Test Mode	Bandwidth	TX / RX	RF Channel		
			Low (L)	Middle (M)	High (H)
LTE BAND12	1.4MHz	TX	Channel 23017	Channel 23095	Channel 23173
			699.7 MHz	707.5 MHz	715.3 MHz
		RX	Channel 5017	Channel 5095	Channel 5173
			729.7 MHz	737.5 MHz	745.3 MHz
	3MHz	TX	Channel 23025	Channel 23095	Channel 23165
			700.5 MHz	707.5 MHz	714.5 MHz
		RX	Channel 5025	Channel 5095	Channel 5165
			730.5 MHz	737.5 MHz	744.5 MHz
	5MHz	TX	Channel 23035	Channel 23095	Channel 23155
			701.5 MHz	707.5 MHz	713.5 MHz
		RX	Channel 5035	Channel 5095	Channel 5155
			731.5 MHz	737.5 MHz	743.5 MHz
10MHz	TX	Channel 23060	Channel 23095	Channel 23155	
		704 MHz	707.5 MHz	711 MHz	
	RX	Channel 5060	Channel 5095	Channel 5130	
		734 MHz	737.5 MHz	741 MHz	

Test Mode	Bandwidth	TX / RX	RF Channel		
			Low (L)	Middle (M)	High (H)
LTE BAND13	5MHz	TX	Channel 23205	Channel 23230	Channel 23255
			779.5 MHz	782 MHz	784.5 MHz
		RX	Channel 5205	Channel 5230	Channel 5255
			748.35 MHz	751 MHz	753.5 MHz
	10MHz	TX	Channel 23230	Channel 23230	Channel 23230
			782 MHz	782 MHz	782 MHz
RX	Channel 5230	Channel 5230	Channel 5230		
	751 MHz	751 MHz	751 MHz		

Test Mode	Bandwidth	TX / RX	RF Channel		
			Low (L)	Middle (M)	High (H)
LTE BAND25	1.4MHz	TX	Channel 26047	Channel 26365	Channel 26683
			1850.7 MHz	1882.5 MHz	1914.3 MHz
		RX	Channel 8047	Channel 8365	Channel 8047
			1930.7 MHz	1962.5 MHz	1992.5 MHz
	3MHz	TX	Channel 26055	Channel 26365	Channel 26675
			1851.5 MHz	1882.5 MHz	1913.5 MHz
		RX	Channel 8055	Channel 8365	Channel 8055
			1931.5 MHz	1962.5 MHz	1990.0 MHz
	5MHz	TX	Channel 26065	Channel 26365	Channel 26665
			1852.5 MHz	1882.5 MHz	1912.5 MHz
		RX	Channel 8065	Channel 8365	Channel 8665
			1932.5 MHz	1962.5 MHz	1992.5 MHz
10MHz	TX	Channel 26090	Channel 26365	Channel 26640	
		1855 MHz	1882.5 MHz	1910 MHz	
RX	Channel 8090	Channel 8365	Channel 8640		

	15MHz	TX	1935.0 MHz	1962.5 MHz	1990.0 MHz
			Channel 26115	Channel 26365	Channel 26615
		RX	1857.5 MHz	1882.5 MHz	1907.5 MHz
			Channel 8115	Channel 8365	Channel 8615
	20MHz	TX	1937.5 MHz	1962.5 MHz	1987.5 MHz
			Channel 26140	Channel 26365	Channel 26590
		RX	1860 MHz	1882.5 MHz	1905 MHz
			Channel 8140	Channel 8365	Channel 8590
			1940.0 MHz	1962.5 MHz	1985.0 MHz

Test Mode	Bandwidth	TX / RX	RF Channel		
			Low (L)	Middle (M)	High (H)
LTE BAND26	1.4MHz	TX	Channel 26797	Channel 26915	Channel 27033
			824.7 MHz	836.5 MHz	848.3 MHz
		RX	Channel 8797	Channel 8915	Channel 9033
			859.7 MHz	881.5 MHz	893.3 MHz
	3MHz	TX	Channel 26805	Channel 26915	Channel 27025
			825.5 MHz	836.5 MHz	847.5 MHz
		RX	Channel 8805	Channel 8915	Channel 9025
			870.5 MHz	881.5 MHz	892.5 MHz
	5MHz	TX	Channel 26815	Channel 26915	Channel 27015
			826.5 MHz	836.5 MHz	846.5 MHz
		RX	Channel 8815	Channel 8915	Channel 2625
			871.5 MHz	881.5 MHz	891.5 MHz
	10MHz	TX	Channel 26840	Channel 26915	Channel 26990
			829 MHz	836.5 MHz	844 MHz
		RX	Channel 8840	Channel 8915	Channel 2600
			874 MHz	881.5 MHz	889 MHz
15MHz	TX	Channel 26865	Channel 26915	Channel 26965	
		831.5 MHz	836.5 MHz	841.5 MHz	
	RX	Channel 8865	Channel 8915	Channel 2575	
		876.5 MHz	881.5 MHz	886.5 MHz	

Test Mode	Bandwidth	TX / RX	RF Channel		
			Low (L)	Middle (M)	High (H)
LTE BAND30	5MHz	TX	Channel 27685	Channel 27710	Channel 27735
			2307.5 MHz	2310 MHz	2312.5 MHz
		RX	Channel 9795	Channel 9820	Channel 9845
			2352.5 MHz	2355 MHz	2357.5 MHz
	10MHz	TX	Channel 27710	Channel 27710	Channel 27710
			2310MHz	2310 MHz	2310 MHz
RX	Channel 9820	Channel 9820	Channel 9820		
	2355 MHz	2355 MHz	2355 MHz		

Test Frequency ID		Bandwidth [MHz]	EARFCN	Frequency (UL and DL) [MHz]
LTE Band 41	Low Range	5	39675	2498.5
		10	39700	2501
		15	39725	2503.5
		20	39750	2506
	Mid-Range	5/10/15/20	40620	2593
	High Range	5	41565	2687.5
		10	41540	2685
		15	41515	2682.5
		20	41490	2680

5 FACILITIES AND ACCREDITATIONS

5.1 FACILITIES

All measurement facilities used to collect the measurement data are located at

Bldg 69, Majialong Industry Zone District, Nanshan District, Shenzhen, China

The sites are constructed in conformance with the requirements of ANSI C63.7, ANSI C63.26 and CISPR Publication 22.

5.2 LABORATORY ACCREDITATIONS AND LISTINGS

Site Description	
EMC Lab.	<p>: Accredited by CNAS, 2016.10.24 The certificate is valid until 2022.10.28 The Laboratory has been assessed and proved to be in compliance with CNAS-CL01: 2006(identical to ISO/IEC17025: 2005) The Certificate Registration Number is L2291</p> <p>Accredited by TUV Rheinland Shenzhen 2015.4 The Laboratory has been assessed according to the requirements ISO/IEC 17025.</p> <p>Accredited by FCC, August 03, 2017 Designation Number: CN1204 Test Firm Registration Number: 882943 Accredited by A2LA, July 31, 2017 The Certificate Registration Number is 4321.01.</p> <p>Accredited by Industry Canada, November 24, 2015 The Certificate Registration Number is 4480A</p>
Name of Firm	: EMTEK (SHENZHEN) CO., LTD.
Site Location	: Bldg 69, Majialong Industry Zone, Nanshan District, Shenzhen, Guangdong, China

6 TEST SYSTEM UNCERTAINTY

The following measurement uncertainty levels have been estimated for tests performed on the apparatus:

Parameter	Uncertainty
Radio Frequency	$\pm 1 \times 10^{-5}$
RF Power Output	$\pm 1.0\text{dB}$
Radiated Emission Test	$\pm 2.0\text{dB}$
Occupied Bandwidth Test	$\pm 1.0\text{dB}$
Band Edge Test	$\pm 3\text{dB}$
All emission, radiated	$\pm 3\text{dB}$
Antenna Port Emission	$\pm 3\text{dB}$
Temperature	$\pm 0.5^{\circ}\text{C}$
Humidity	$\pm 3\%$

Measurement Uncertainty for a level of Confidence of 95%

7 SETUP OF EQUIPMENT UNDER TEST

7.1 RADIO FREQUENCY TEST SETUP 1

The component's antenna ports(s) of the EUT are connected to the measurement instrument per an appropriate attenuator. The EUT is controlled by PC/software to emit the specified signals for the purpose of measurements.

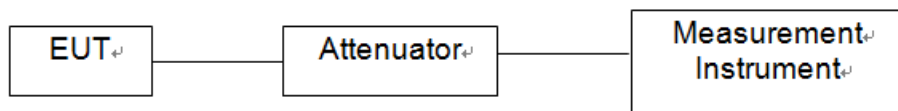

7.2 RADIO FREQUENCY TEST SETUP 2

The test site semi-anechoic chamber has met the requirement of NSA tolerance 4 dB according to the standards: ANSI C63.10. The test distance is 3m. The setup is according to the requirements in Section 13.1.4.1 of ANSI C63.26-2015 and CAN/CSA-CEI/IEC CISPR 22.

Below 30MHz:

The EUT is placed on a turntable 0.8 meters above the ground in the chamber, 3 meter away from the antenna (loop antenna). The Antenna should be positioned with its plane vertical at the specified distance from the EUT and rotated about its vertical axis for maximum response at each azimuth about the EUT. The center of the loop shall be 1 m above the ground. For certain applications, the loop antenna plane may also need to be positioned horizontally at the specified distance from the EUT.

Above 30MHz:

The EUT is placed on a turntable 0.8 meters above the ground in the chamber, 3 meter away from the antenna. The maximal emission value is acquired by adjusting the antenna height, polarisation and turntable azimuth. Normally, the height range of antenna is 1 m to 4 m, the azimuth range of turntable is 0° to 360°, and the receive antenna has two polarizations Vertical (V) and Horizontal (H).

Above 1GHz:

(Note: the FCC's permission to use 1.5m as an alternative per TCBC Conf call of Dec. 2, 2014.)

The EUT is placed on a turntable 1.5 meters above the ground in the chamber, 3 meter away from the antenna. The maximal emission value is acquired by adjusting the antenna height, polarisation and turntable azimuth. Normally, the height range of antenna is 1 m to 4 m, the azimuth range of turntable is 0° to 360°, and the receive antenna has two polarizations Vertical (V) and Horizontal (H).

(a) Radiated Emission Test Set-Up, Frequency Below 30MHz

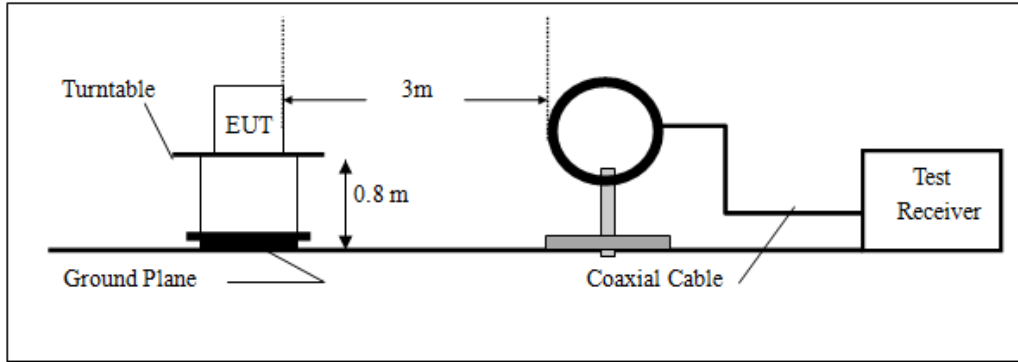

(b) Radiated Emission Test Set-Up, Frequency Below 1000MHz

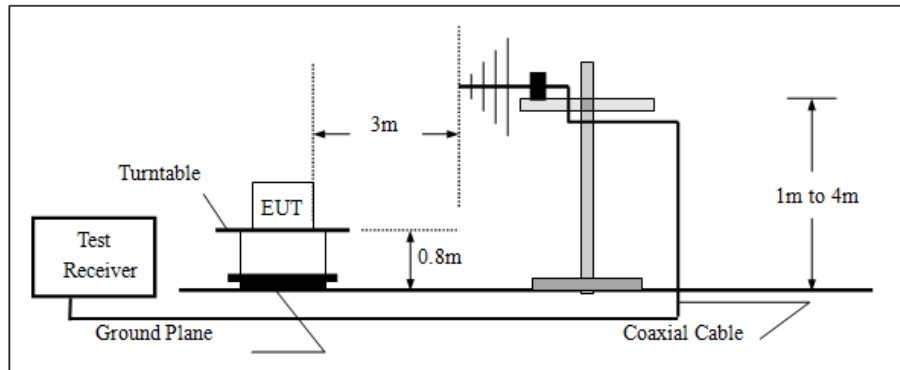

(c) Radiated Emission Test Set-Up, Frequency above 1000MHz

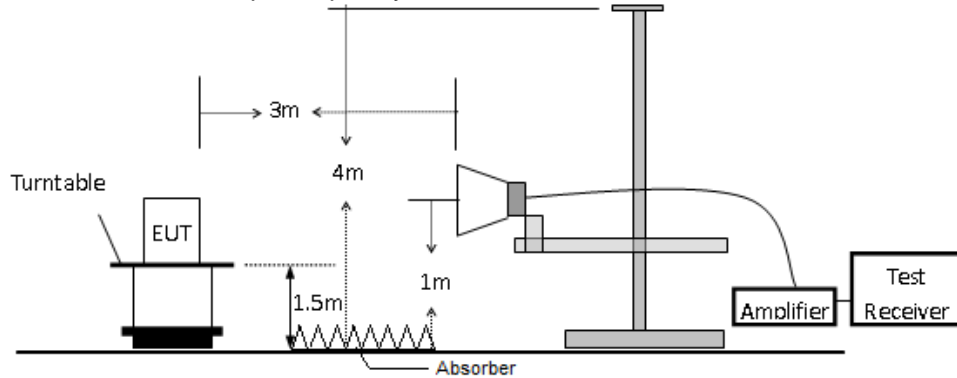

7.3 SUPPORT EQUIPMENT

Item	Equipment	Mfr/Brand	Model/Type No.	FCC ID	Note
N/A	N/A	N/A	N/A	N/A	N/A

Notes:

- 1. All the equipment/cables were placed in the worst-case configuration to maximize the emission during the test.*
- 2. Grounding was established in accordance with the manufacturer's requirements and conditions for the intended use.*

8 TEST REQUIREMENTS

8.1 RF POWER OUTPUT

8.1.1 Conformance Limit

No limit requirement.

8.1.2 Test Configuration

Test according to clause 7.1 radio frequency test setup 1

8.1.3 Test Procedure

Connect the EUT to Universal Radio Communication Tester CMU200 or CMU500 via the antenna connector. A call is set up by the SS according to the generic call set up procedure on a channel with ARFCN in the ARFCN range, power control level set to Max power. The frequency band is set as selected frequency,

The RF output of the transmitter was connected to base station simulator.

Set EUT at maximum average power by base station simulator.

Set RBW = 1-5% of the OBW, not to exceed 1 MHz.

Set VBW $\geq 3 \times$ RBW.

Number of points in sweep $\geq 2 \times$ span / RBW. (This gives bin-to-bin spacing \leq RBW/2, so that narrowband signals are not lost between frequency bins.)

Sweep time = auto.

Detector = RMS (power averaging).

Set sweep trigger to "free run".

Trace average at least 100 traces in power averaging (i.e., RMS) mode; however, the number of traces to be averaged shall be increased above 100 as needed such that the average accurately represents the true average over the on and off periods of the transmitter.

Compute power by integrating the spectrum across the OBW of the signal using the instrument's band power measurement function with band limits set equal to the OBW band edges. If the instrument does not have a band power function, sum the spectrum levels (in power units) at intervals equal to the RBW extending across the entire OBW of the spectrum.

Add $10 \log(1/x)$, where x is the duty cycle, to the measured power in order to compute the average power during the actual transmission times (because the measurement represents an average over both the on and off times of the transmission). For example, add $10 \log(1/0.25) = 6$ dB if the duty cycle is a constant 25%.

Measure lowest, middle, and highest channels for each bandwidth and different modulation.

Measure and record the results in the test report.

8.1.4 Test Results

Pass

Note: The details please see Appendix A.

8.2 EFFECTIVE (ISOTROPIC) RADIATED POWER

8.2.1 Conformance Limit

LTE BAND2 (25)	FCC Part 24.232
Mobile and portable stations are limited to 2 watts EIRP and the equipment must employ a means for limiting power to the minimum necessary for successful communications.	
LTE BAND4	FCC Part 27.50
Fixed, mobile, and portable (hand-held) stations operating in the 1710-1755 MHz band and mobile and portable stations operating in the 1695-1710 MHz and 1755-1780 MHz bands are limited to 1 watt EIRP. Fixed stations operating in the 1710-1755 MHz band are limited to a maximum antenna height of 10 meters above ground. Mobile and portable stations operating in these bands must employ a means for limiting power to the minimum necessary for successful communications.	
LTE BAND5 (26)	FCC Part 22.913, Part 90.635
According to Part 22.913(a) the ERP of mobile transmitters and auxiliary test transmitters must not exceed 7 Watts; According to Part 90.635(b), the maximum output power of the transmitter for mobile stations is 100 watts (20 dBw);	
LTE BAND7	FCC Part 27.50
Mobile and other user stations. Mobile stations are limited to 2.0 watts EIRP. All user stations are limited to 2.0 watts transmitter output power.	
LTE BAND12	FCC Part 27.50
Portable stations (hand-held devices) in the 600 MHz uplink band and the 698-746 MHz band, and fixed and mobile stations in the 600 MHz uplink band are limited to 3 watts ERP.	
LTE BAND13	FCC Part 27.50
Portable stations (hand-held devices) transmitting in the 746-757 MHz, 776-788 MHz, and 805-806 MHz bands are limited to 3 watts ERP	
LTE BAND17	FCC Part 27.50
Portable stations (hand-held devices) transmitting in the 746-757 MHz, 776-788 MHz, and 805-806 MHz bands are limited to 3 watts ERP	
LTE BAND30	FCC Part 27.50
Mobile and portable stations. (i) For mobile and portable stations transmitting in the 2305-2315 MHz band or the 2350-2360 MHz band, the average EIRP must not exceed 50 milliwatts within any 1 megahertz of authorized bandwidth, except that for mobile and portable stations compliant with 3GPP LTE standards	
LTE BAND41	FCC Part 27.50
Mobile and other user stations. Mobile stations are limited to 2.0 watts EIRP. All user stations are limited to 2.0 watts transmitter output power.	

8.2.2 Test Configuration

Test according to clause 7.3 radio frequency test setup 3

8.2.3 Test Procedure

Connect the EUT to Universal Radio Communication Tester CMU200 or CMU500 via the antenna connector. A call is set up by the SS according to the generic call set up procedure on a channel with ARFCN in the Mid ARFCN range, power control level set to Max power. MS TXPWR_MAX_CCH is set to the maximum value supported by the Power Class of the Mobile under test

The instrument must have an available measurement/resolution bandwidth that is equal to or exceeds the OBW. If this capability is available, then the following procedure can be used to determine the total peak output power.

- a) Set the RBW \geq OBW.
- b) Set VBW \geq 3 \times RBW.
- c) Set span \geq 2 \times RBW
- d) Sweep time = auto couple.

- e) Detector = peak.
- f) Ensure that the number of measurement points \geq span/RBW.
- g) Trace mode = max hold.
- h) Allow trace to fully stabilize.
- i) Use the peak marker function to determine the peak amplitude level.

The EUT was placed on a turn table which is 0.8m above ground plane. Maximum procedure was performed on the six highest emissions to ensure EUT compliance. And also, each emission was to be maximized by changing the polarization of receiving antenna both horizontal and vertical. Repeat above procedures until all frequency measured was complete.

A receiving antenna was placed on the antenna mast 3 meters from the EUT for emission measurements. The height of receiving antenna is 1.5m. The test setup refers to figure below. Detected emissions were maximized at each frequency by rotating the EUT through 360° and adjusting the receiving antenna polarization. The radiated emission measurements of all transmit frequencies in three channels (High, Middle, Low) weremeasured with peak detector.

The EUT is then put into continuously transmitting mode at its maximum power level during the test. And the maximum value of the receiver should be recorded as (Pr).

The EUT shall be replaced by a substitution antenna. The test setup refers to figure below. In the chamber, an substitution antenna for the frequency band of interest is placed at the reference point of the chamber. An RF Signal source for the frequency band of interest is connected to the substitution antenna with a cable that has been constructed to not interfere with the radiation pattern of the antenna. A power (PMea) is applied to the input of the substitution antenna, and adjust the level of the signal generator output until the value of the receiver reach the previously recorded (Pr). The power of signal source (PMea) is recorded. The test should be performed by rotating the test item and adjusting the receiving antennapolarization.

A amplifier should be connected to the Signal Source output port. And the cable should be connect between the Amplifier and the Substitution Antenna.

The cable loss (Pcl) ,the Substitution Antenna Gain (Ga) and the Amplifier Gain (PAg) should be recorded after test.

The measurement results are obtained as described below:

$$\text{Power(EIRP)} = \text{PMea} - \text{PAg} - \text{Pcl} - \text{Ga}$$

This value is EIRP since the measurement is calibrated using an antenna of known gain (2.15 dBi) and known input power.

ERP can be calculated from EIRP by subtracting the gain of the dipole,

$$\text{ERP} = \text{EIRP} - 2.15\text{dBi}.$$

8.2.4 Test Results

Pass

Note: The details please see Appendix B.

8.3 MODULATION CHARACTERISTICS

8.3.1 Conformance Limit

No specific modulation characteristics requirement limits.

8.3.2 Test Configuration

Test according to clause 7.1 radio frequency test setup 1

8.3.3 Test Procedure

Connect the EUT to Universal Radio Communication Tester CMU200 or CMU500 via the antenna connector. A call is set up by the SS according to the generic call set up procedure on a channel with ARFCN in the Mid ARFCN range, power control level set to Max power. MS TXPWR_MAX_CCH is set to the maximum value supported by the Power Class of the Mobile under test, The frequency band is set as selected frequency, test method was according to 3GPP TS 51.010 and 3GPP TS 34.121. and 3GPP2 C.S0011/TIA-98-E for 1XRTT. and 3GPP2 C.S0033-0/tia-866 for Rel.0 and 3GPP2 C.S0033-A for Rev.A The waveform quality and constellation of the was tested.

8.3.4 Test Results

Pass

8.4 OCCUPIED BANDWIDTH

8.4.1 Conformance Limit

No specific modulation characteristics requirement limits.

8.4.2 Test Configuration

Test according to clause 7.1 radio frequency test setup 1

8.4.3 Test Procedure

Connect the EUT to Universal Radio Communication Tester CMU200 or CMU500 via the antenna connector. A call is set up by the SS according to the generic call set up procedure on a channel with ARFCN in the Mid ARFCN range, power control level set to Max power. MS TXPWR_MAX_CCH is set to the maximum value supported by the Power Class of the Mobile under test,

■ 99% Occupied bandwidth

The following procedure shall be used for measuring (99 %) power bandwidth

- The spectrum analyzer center frequency is set to the nominal EUT channel center frequency. The frequency span for the spectrum analyzer shall be set wide enough to capture all modulation products including the emission skirts (i.e., two to five times the OBW).
- The nominal IF filter bandwidth (3 dB RBW) shall be in the range of 1 to 5 % of the anticipated OBW, and the VBW shall be at least 3 times the RBW.
- Set the reference level of the instrument as required to keep the signal from exceeding the maximum input mixer level for linear operation. In general, the peak of the spectral envelope must be at least $10\log(\text{OBW} / \text{RBW})$ below the reference level.
- NOTE—Steps a) through c) may require iteration to adjust within the specified tolerances.
- Set the detection mode to peak, and the trace mode to max hold..
- Use the 99 % power bandwidth function of the spectrum analyzer (if available) and report the measured bandwidth.
- If the instrument does not have a 99 % power bandwidth function, the trace data points are to be recovered and directly summed in linear power terms. The recovered amplitude data points, beginning at the lowest frequency, are placed in a running sum until 0.5 % of the total is reached; that frequency is recorded as the lower frequency. The process is repeated until 99.5 % of the total is reached; that frequency is recorded as the upper frequency. The 99 % power bandwidth is the difference between these two frequencies.
- The OBW shall be reported by providing plot(s) of the measuring instrument display. The frequency and amplitude axes and scale shall be clearly labeled. Tabular data may be reported in addition to the plot(s).

■ 26 dB Occupied bandwidth

The reference value is the highest level of the spectral envelope of the modulated signal.

- The spectrum analyzer center frequency is set to the nominal EUT channel center frequency. The span range for the spectrum analyzer shall be between two and five times the anticipated OBW.
- The nominal resolution bandwidth (RBW) shall be in the range of 1 to 5 % of the anticipated OBW, and the VBW shall be at least 3 times the RBW.
- Set the reference level of the instrument as required to prevent the signal from exceeding the maximum input mixer level for linear operation. In general, the peak of the spectral envelope must be at least $10\log(\text{OBW} / \text{RBW})$ below the reference level.
- NOTE—Steps a) through c) may require iteration to adjust within the specified tolerances.
- The dynamic range of the spectrum analyzer at the selected RBW shall be at least 10 dB below the target “-X dB down” requirement (i.e., if the requirement calls for measuring the -26 dB OBW, the spectrum analyzer noise floor at the selected RBW shall be at least 36 dB below the reference value).
- Set the detection mode to peak, and the trace mode to max hold.
- Determine the reference value: Set the EUT to transmit a modulated signal. Allow the trace to stabilize. Set the spectrum analyzer marker to the highest level of the displayed trace (this is the reference value).
- Determine the “-X dB down amplitude” as equal to (Reference Value – X). Alternatively, this calculation

can be performed by the analyzer by using the marker-delta function.

i) Place two markers, one at the lowest and the other at the highest frequency of the envelope of the spectral display such that each marker is at or slightly below the “-X dB down amplitude” determined in step g). If a marker is below this “-X dB down amplitude” value it shall be placed as close as possible to this value. The OBW is the positive frequency difference between the two markers.

j) The occupied bandwidth shall be reported by providing plot(s) of the measuring instrument display. The frequency and amplitude axes and scale shall be clearly labeled. Tabular data may be reported in addition to the plot(s)

8.4.4 Test Results

Pass

Note: The details please see Appendix C.

8.5 BAND EDGE EMISSION

8.5.1 Conformance Limit

LTE BAND5 (26)	FCC Part 22.917, Part 90.691
≤ -13 dBm/1%*EBW, in 1 MHz bands immediately outside and adjacent to the frequency block.	
LTE BAND2 (25)	FCC Part 24.238
≤ -13 dBm/1%*EBW, in 1 MHz bands immediately outside and adjacent to the frequency block.	
LTE BAND4	FCC Part 27.53(h)
≤ -13 dBm/1%*EBW, in 1 MHz bands immediately outside and adjacent to the frequency block.	
LTE BAND7 (41)	FCC Part 27.53(m)
For mobile digital stations, the attenuation factor shall be not less than 40 + 10 log (P) dB on all frequencies between the channel edge and 5 megahertz from the channel edge, 43 + 10 log (P) dB on all frequencies between 5 megahertz and X megahertz from the channel edge, and 55 + 10 log (P) dB on all frequencies more than X megahertz from the channel edge, where X is the greater of 6 megahertz or the actual emission bandwidth as defined in paragraph (m)(6) of this section. In addition, the attenuation factor shall not be less than 43 + 10 log (P) dB on all frequencies between 2490.5 MHz and 2496 MHz and 55 + 10 log (P) dB at or below 2490.5 MHz. Mobile Satellite Service licensees operating on frequencies below 2495 MHz may also submit a documented interference complaint against BRS licensees operating on channel BRS Channel 1 on the same terms and conditions as adjacent channel BRS or EBS licensees	
LTE BAND12	FCC Part 27.53(g)
≤ -13 dBm/1%*EBW, in 1 MHz bands immediately outside and adjacent to the frequency block.	
LTE BAND13	FCC Part 27.53(c)
≤ -13 dBm/1%*EBW, in 1 MHz bands immediately outside and adjacent to the frequency block.	
LTE BAND30	FCC Part 27.53(a)
By a factor of not less than: 43 + 10 log (P) dB on all frequencies between 2305 and 2320 MHz and on all frequencies between 2345 and 2360 MHz that are outside the licensed band(s) of operation, not less than 55 + 10 log (P) dB on all frequencies between 2320 and 2324 MHz and on all frequencies between 2341 and 2345 MHz, not less than 61 + 10 log (P) dB on all frequencies between 2324 and 2328 MHz and on all frequencies between 2337 and 2341 MHz, and not less than 67 + 10 log (P) dB on all frequencies between 2328 and 2337 MHz	
By a factor of not less than 43 + 10 log (P) dB on all frequencies between 2300 and 2305 MHz, 55 + 10 log (P) dB on all frequencies between 2296 and 2300 MHz, 61 + 10 log (P) dB on all frequencies between 2292 and 2296 MHz, 67 + 10 log (P) dB on all frequencies between 2288 and 2292 MHz, and 70 + 10 log (P) dB below 2288 MHz	

8.5.2 Test Configuration

Test according to clause 7.1 radio frequency test setup 1

8.5.3 Test Procedure

Connect the EUT to Universal Radio Communication Tester CMU200 or CMU500 via the antenna connector. A call is set up by the SS according to the generic call set up procedure on a channel with ARFCN in the Mid ARFCN range, power control level set to Max power. MS TXPWR_MAX_CCH is set to the maximum value supported by the Power Class of the Mobile under test,

Spectrum Analyzer is set as below:
 SET RBW ≥ 1% of Emission BW.
 SET VBW about three times of RBW
 Detector: RMS
 Trace mode= max hold.

8.5.4 Test Results

Pass

Note: The details please see Appendix D.

8.6 OUT OF BAND EMISSIONS AT ANTENNA TERMINALS

8.6.1 Conformance Limit

LTE BAND2 (25)	FCC Part 24.238
Out of band emissions. The power of any emission outside of the authorized operating frequency ranges must be attenuated below the transmitting power (P) by a factor of at least $43 + 10 \log(P)$ dB.	
LTE BAND4	FCC Part 27.53(h)
Out of band emissions. The power of any emission outside of the authorized operating frequency ranges must be attenuated below the transmitting power (P) by a factor of at least $43 + 10 \log(P)$ dB.	
LTE BAND5(26)	FCC Part 22.917
Out of band emissions. The power of any emission outside of the authorized operating frequency ranges must be attenuated below the transmitting power (P) by a factor of at least $43 + 10 \log(P)$ dB.	
LTE BAND7 (41)	FCC Part 27.53(m)
For mobile digital stations, the attenuation factor shall be not less than $40 + 10 \log(P)$ dB on all frequencies between the channel edge and 5 megahertz from the channel edge, $43 + 10 \log(P)$ dB on all frequencies between 5 megahertz and X megahertz from the channel edge, and $55 + 10 \log(P)$ dB on all frequencies more than X megahertz from the channel edge, where X is the greater of 6 megahertz or the actual emission bandwidth as defined in paragraph (m)(6) of this section. In addition, the attenuation factor shall not be less than $43 + 10 \log(P)$ dB on all frequencies between 2490.5 MHz and 2496 MHz and $55 + 10 \log(P)$ dB at or below 2490.5 MHz. Mobile Satellite Service licensees operating on frequencies below 2495 MHz may also submit a documented interference complaint against BRS licensees operating on channel BRS Channel 1 on the same terms and conditions as adjacent channel BRS or EBS licensees	
LTE BAND12	FCC Part 27.53(g)
Out of band emissions. The power of any emission outside of the authorized operating frequency ranges must be attenuated below the transmitting power (P) by a factor of at least $43 + 10 \log(P)$ dB.	
LTE BAND13	FCC Part 27.53(c)
Out of band emissions. The power of any emission outside of the authorized operating frequency ranges must be attenuated below the transmitting power (P) by a factor of at least $43 + 10 \log(P)$ dB.	
LTE BAND30	FCC Part 27.53(a)
By a factor of not less than $43 + 10 \log(P)$ dB on all frequencies between 2360 and 2365 MHz, and not less than $70 + 10 \log(P)$ dB above 2365 MHz.	

The specification that emissions shall be attenuated below the transmitter power (P) by at least $43 + 10 \log(P)$ dB, translates in the relevant power range (1 to 0.001 W) to -13 dBm. At 1 W the specified minimum attenuation becomes 43 dB and relative to a 30 dBm (1 W) carrier becomes a limit of -13 dBm. At 0.001 W (0 dBm) the minimum attenuation is 13 dB, which again yields a limit of -13 dBm. In this way a translation of the specification from relative to absolute terms is carried out.

8.6.2 Test Configuration

Test according to clause 7.1 radio frequency test setup 1

8.6.3 Test Procedure

The transmitter output (antenna port) was connected to the spectrum analyzer
Connect the EUT to Universal Radio Communication Tester CMU200 or CMU500 via the antenna connector. A call is set up by the SS according to the generic call set up procedure on a channel with ARFCN in the Mid ARFCN range, power control level set to Max power. MS TXPWR_MAX_CCH is set to the maximum value supported by the Power Class of the Mobile under test,

Spectrum Analyzer is set as below:

9kHz~150kHz, RBW = 1KHz, VBW \geq 3 \times RBW,

150kHz~30MHz, RBW = 10KHz, VBW \geq 3 \times RBW,

30MHz~1GHz, RBW = 100 kHz, VBW = 300 kHz. Above 1GHz, RBW = 1 MHz, VBW = 3 MHz.

Detector: Peak

Trace mode= max hold.

8.6.4 Test Results

Pass

Note: The details please see Appendix E.

8.7 FIELD STRENGTH OF SPURIOUS RADIATION

8.7.1 Conformance Limit

LTE BAND2 (25)	FCC Part 24.238
Out of band emissions. The power of any emission outside of the authorized operating frequency ranges must be attenuated below the transmitting power (P) by a factor of at least $43 + 10 \log(P)$ dB.	
LTE BAND4	FCC Part 27.53(h)
Out of band emissions. The power of any emission outside of the authorized operating frequency ranges must be attenuated below the transmitting power (P) by a factor of at least $43 + 10 \log(P)$ dB.	
LTE BAND5(26)	FCC Part 22.917
Out of band emissions. The power of any emission outside of the authorized operating frequency ranges must be attenuated below the transmitting power (P) by a factor of at least $43 + 10 \log(P)$ dB.	
LTE BAND7 (41)	FCC Part 27.53(m)
For mobile digital stations, the attenuation factor shall be not less than $40 + 10 \log(P)$ dB on all frequencies between the channel edge and 5 megahertz from the channel edge, $43 + 10 \log(P)$ dB on all frequencies between 5 megahertz and X megahertz from the channel edge, and $55 + 10 \log(P)$ dB on all frequencies more than X megahertz from the channel edge, where X is the greater of 6 megahertz or the actual emission bandwidth as defined in paragraph (m)(6) of this section. In addition, the attenuation factor shall not be less than $43 + 10 \log(P)$ dB on all frequencies between 2490.5 MHz and 2496 MHz and $55 + 10 \log(P)$ dB at or below 2490.5 MHz. Mobile Satellite Service licensees operating on frequencies below 2495 MHz may also submit a documented interference complaint against BRS licensees operating on channel BRS Channel 1 on the same terms and conditions as adjacent channel BRS or EBS licensees	
LTE BAND12	FCC Part 27.53(g)
Out of band emissions. The power of any emission outside of the authorized operating frequency ranges must be attenuated below the transmitting power (P) by a factor of at least $43 + 10 \log(P)$ dB.	
LTE BAND13	FCC Part 27.53(c)
Out of band emissions. The power of any emission outside of the authorized operating frequency ranges must be attenuated below the transmitting power (P) by a factor of at least $43 + 10 \log(P)$ dB.	
LTE BAND30	FCC Part 27.53(a)
By a factor of not less than $43 + 10 \log(P)$ dB on all frequencies between 2360 and 2365 MHz, and not less than $70 + 10 \log(P)$ dB above 2365 MHz.	

The specification that emissions shall be attenuated below the transmitter power (P) by at least $43 + 10 \log(P)$ dB, translates in the relevant power range (1 to 0.001 W) to -13 dBm. At 1 W the specified minimum attenuation becomes 43 dB and relative to a 30 dBm (1 W) carrier becomes a limit of -13 dBm. At 0.001 W (0 dBm) the minimum attenuation is 13 dB, which again yields a limit of -13 dBm. In this way a translation of the specification from relative to absolute terms is carried out.

8.7.2 Test Configuration

Test according to clause 7.3 radio frequency test setup 3

8.7.3 Test Procedure

Connect the EUT to Universal Radio Communication Tester CMU200 or CMU500 via the antenna connector. A call is set up by the SS according to the generic call set up procedure on a channel with ARFCN in the Mid ARFCN range, power control level set to Max power. MS TXPWR_MAX_CCH is set to the maximum value supported by the Power Class of the Mobile under test.

Compliance with these rules is based on the use of measurement instrumentation employing a resolution bandwidth of 100 kHz or greater. In the 1 MHz bands immediately outside and adjacent to the frequency block a resolution bandwidth of at least one percent of the emission bandwidth of the fundamental emission of the transmitter may be employed. A narrower resolution bandwidth is permitted in all cases to improve measurement accuracy provided the measured power is integrated over the full required measurement bandwidth (i.e. 100 kHz or 1 percent of emission bandwidth, as specified). The emission bandwidth is defined as the width of the signal between two points, one below the carrier center frequency and one above the carrier center frequency, outside of which all emissions

are attenuated at least 26 dB below the transmitter power.

then the following procedure can be used to determine spurious emission

- a) RBW = 1 MHz for $f \geq 1$ GHz(1GHz to 25GHz), 100 kHz for $f < 1$ GHz(30MHz to 1GHz), 200Hz for $f < 150$ KHz(9KHz to 150KHz), 9KHz for $f < 30$ MHz(150KHz to 30KHz)
- b) Set VBW $\geq 3 \times$ RBW.
- c) Set span wide enough to fully capture the emission being measured
- d) Sweep time = auto couple.
- e) Detector = peak.
- f) Ensure that the number of measurement points \geq span/RBW.
- g) Trace mode = max hold.
- h) Allow trace to fully stabilize.
- i) Use the peak marker function to determine the peak amplitude level.

Step1. The EUT was placed on a rotatable wooden table with 0.8 meter above ground.

Step2. The EUT was set 3 meters from the receiving antenna, which was mounted on the antenna tower.

Step3. The table was rotated 360 degrees to determine the position of the highest spurious emission.

Step4. The height of the receiving antenna is varied between one meter and four meters to search the maximum spurious emission for both horizontal and vertical polarizations.

Step5. Make the measurement with the spectrum analyzer's RBW , VBW , taking the record of maximum spurious emission.

Step6. A horn antenna was substituted in place of the EUT and was driven by a signal generator.

Step7. Tune the output power of signal generator to the same emission level with EUT maximum spurious emission.

Step8. Taking the record of output power at antenna port.

Step9. Repeat step 7 to step 8 for another polarization.

Step10. Emission level (dBm) = output power + substitution Gain. Test Results

8.7.4 Test Results

Pass

Note: The details please see Appendix F.

8.8 FREQUENCY STABILITY

8.8.1 Conformance Limit

The frequency stability shall be measured by variation of ambient temperature and variation of primary supply voltage to ensure that the fundamental emission stays within the authorized frequency block. The frequency stability of the transmitter shall be maintained within $\pm 0.00025\%$ ($\pm 2.5\text{ppm}$) of the center frequency.

8.8.2 Test Configuration

Test according to clause 7.2 conducted emission test setup2.

8.8.3 Test Procedure

Connect the EUT to Universal Radio Communication Tester CMU200 or CMU500 via the antenna connector. A call is set up by the SS according to the generic call set up procedure on a channel with ARFCN in the ARFCN range, power control level set to Max power. MS TXPWR_MAX_CCH is set to the maximum value supported by the Power Class of the Mobile under test.

EUT was placed at temperature chamber and connected to an external power supply.

Temperature and voltage condition shall be tested to confirm frequency stability.

(a) Frequency measurements shall be made at the extremes of the specified temperature range and at intervals of not more than 10° centigrade through the range. A period of time sufficient to stabilize all of the components of the oscillator circuit at each temperature level shall be allowed prior to frequency measurement. The short-term transient effects on the frequency of the transmitter due to keying (except for broadcast transmitters) and any heating element cycling normally occurring at each ambient temperature level also shall be shown. Only the portion or portions of the transmitter containing the frequency determining and stabilizing circuitry need be subjected to the temperature variation test.

(b) The frequency stability shall be measured with variation of primary supply voltage as follows:

(1) Vary primary supply voltage from 95 to 105 percent of the nominal value for other than hand carried battery equipment.

(2) For hand carried, battery powered equipment, reduce primary supply voltage to the battery operating end point, which shall be specified by the manufacturer.

8.8.4 Test Results

Pass

Note: The details please see Appendix G.

8.9 PEAK TO AVERAGE RATIO

8.9.1 Conformance Limit

LTE BAND2 (25)

FCC Part 24.232

Power measurements for transmissions by stations authorized under this section may be made either in accordance with a Commission-approved average power technique or in compliance with paragraph (e) of this section. In both instances, equipment employed must be authorized in accordance with the provisions of §24.51. In measuring transmissions in this band using an average power technique, the peak-to-average ratio (PAR) of the transmission may not exceed 13 dB.

LTE BAND4(7)(30)(41)

FCC Part 27.50

Equipment employed must be authorized in accordance with the provisions of §24.51. Power measurements for transmissions by stations authorized under this section may be made either in accordance with a Commission-approved average power technique or in compliance with paragraph (d)(6) of this section. In measuring transmissions in this band using an average power technique, the peak-to-average ratio (PAR) of the transmission may not exceed 13 dB.

8.9.2 Test Configuration

Test according to clause 7.1 conducted emission test setup1.

8.9.3 Test Procedure

The EUT was connected to Spectrum Analyzer and Base Station via power divider.

The RF output of EUT was connected to the spectrum analyzer by RF cable and attenuator. The path loss was compensated to the results for each measurement.

Set the number of counts to a value that stabilizes the measured CCDF curve.

Set the measurement interval to 1 ms.

Record the maximum PAPR level associated with a probability of 0.1%.

- a) Refer to instrument's analyzer instruction manual for details on how to use the power statistics/CCDF function;
- b) Set resolution/measurement bandwidth \geq signal's occupied bandwidth;
- c) Set the number of counts to a value that stabilizes the measured CCDF curve;
- d) Set the measurement interval as follows:
 - 1) for continuous transmissions, set to 1 ms,
 - 2) for burst transmissions, employ an external trigger that is synchronized with the EUT burst timing sequence, or use the internal burst trigger with a trigger level that allows the burst to stabilize and set the measurement interval to a time that is less than or equal to the burst duration.
- e) Record the maximum PAPR level associated with a probability of 0.1%.

8.9.4 Test Results

Pass

Note: The details please see Appendix H.

APPENDIX A: TEST DATA FOR RF POWER OUTPUT

Band/BW	Modulation	RB Size	RB Offset	Low CH 18607	Mid CH 18900	High CH 19193
				1850.7 MHz	1880.0 MHz	1909.3 MHz
2/1.4	QPSK	1	0	22.31	22.45	22.36
		1	2	22.30	22.44	22.35
		1	5	22.27	22.41	22.32
		3	0	22.30	22.44	22.35
		3	1	22.29	22.43	22.34
		3	3	22.26	22.40	22.31
	16QAM	6	0	21.37	21.51	21.42
		1	0	21.32	21.46	21.37
		1	2	21.29	21.43	21.34
		1	5	21.28	21.42	21.33
		3	0	21.30	21.44	21.35
		3	1	21.27	21.41	21.32
		3	3	21.26	21.40	21.31
		6	0	20.32	20.46	20.37

Band/BW	Modulation	RB Size	RB Offset	Low CH 18615	Mid CH 18900	High CH 19185
				1851.5 MHz	1880.0 MHz	1908.5 MHz
2/3	QPSK	1	0	22.34	22.48	22.39
		1	7	22.33	22.47	22.38
		1	14	22.30	22.44	22.35
		8	0	21.39	21.53	21.44
		8	3	21.37	21.51	21.42
		8	7	21.32	21.46	21.37
		15	0	21.40	21.54	21.45
	16QAM	1	0	21.35	21.49	21.40
		1	7	21.32	21.46	21.37
		1	14	21.31	21.45	21.36
		8	0	20.43	20.57	20.48
		8	3	20.42	20.56	20.47
		8	7	20.37	20.51	20.42
		15	0	20.35	20.49	20.40

Band/BW	Modulation	RB Size	RB Offset	Low CH 18625	Mid CH 18900	High CH 19175
				1852.5 MHz	1880.0 MHz	1907.5 MHz
2/5	QPSK	1	0	22.37	22.51	22.42
		1	12	22.36	22.50	22.41
		1	24	22.33	22.47	22.38
		12	0	21.42	21.56	21.47
		12	6	21.40	21.54	21.45
		12	13	21.35	21.49	21.40
		25	0	21.43	21.57	21.48
	16QAM	1	0	21.38	21.52	21.43
		1	12	21.35	21.49	21.40
		1	24	21.34	21.48	21.39
		12	0	20.46	20.60	20.51
		12	6	20.45	20.59	20.50
		12	13	20.40	20.54	20.45
		25	0	20.38	20.52	20.43

Band/BW	Modulation	RB Size	RB Offset	Low CH 18650	Mid CH 18900	High CH 19150
				1855.0 MHz	1880.0 MHz	1905.0 MHz
2/10	QPSK	1	0	22.39	22.53	22.44
		1	24	22.38	22.52	22.43
		1	49	22.35	22.49	22.40
		25	0	21.44	21.58	21.49
		25	12	21.42	21.56	21.47
		25	25	21.37	21.51	21.42
		50	0	21.45	21.59	21.50
	16QAM	1	0	21.40	21.54	21.45
		1	24	21.37	21.51	21.42
		1	49	21.36	21.50	21.41
		25	0	20.48	20.62	20.53
		25	12	20.47	20.61	20.52
		25	25	20.42	20.56	20.47
		50	0	20.40	20.54	20.45

Band/BW	Modulation	RB Size	RB Offset	Low CH 18675	Mid CH 18900	High CH 19125
				1857.5 MHz	1880.0 MHz	1902.5 MHz
2/15	QPSK	1	0	22.42	22.56	22.47
		1	37	22.41	22.55	22.46
		1	74	22.38	22.52	22.43
		36	0	21.47	21.61	21.52
		36	19	21.45	21.59	21.50
		36	39	21.40	21.54	21.45
		75	0	21.48	21.62	21.53
	16QAM	1	0	21.43	21.57	21.48
		1	37	21.40	21.54	21.45
		1	74	21.39	21.53	21.44
		36	0	20.51	20.65	20.56
		36	19	20.50	20.64	20.55
		36	39	20.45	20.59	20.50
		75	0	20.43	20.57	20.48

Band/BW	Modulation	RB Size	RB Offset	Low CH 18700	Mid CH 18900	High CH 19100
				1860.0 MHz	1880.0 MHz	1900.0 MHz
2/20	QPSK	1	0	22.47	22.61	22.52
		1	50	22.46	22.60	22.51
		1	99	22.43	22.57	22.48
		50	0	21.52	21.66	21.57
		50	25	21.50	21.64	21.55
		50	50	21.45	21.59	21.50
		100	0	21.53	21.67	21.58
	16QAM	1	0	21.48	21.62	21.53
		1	50	21.45	21.59	21.50
		1	99	21.44	21.58	21.49
		50	0	20.56	20.70	20.61
		50	25	20.55	20.69	20.60
		50	50	20.50	20.64	20.55
		100	0	20.48	20.62	20.53

Band/BW	Modulation	RB Size	RB Offset	Low CH 19957	Mid CH 20175	High CH 20393
				Frequency 1710.7 MHz	Frequency 1732.5 MHz	Frequency 1754.3 MHz
4/1.4	QPSK	1	0	22.58	22.69	22.61
		1	2	22.57	22.68	22.60
		1	5	22.54	22.65	22.57
		3	0	22.56	22.67	22.59
		3	1	22.55	22.66	22.58
		3	3	22.52	22.63	22.55
	16QAM	6	0	21.64	21.75	21.67
		1	0	21.59	21.70	21.62
		1	2	21.56	21.67	21.59
		1	5	21.55	21.66	21.58
		3	0	21.58	21.69	21.61
		3	1	21.55	21.66	21.58
		3	3	21.54	21.65	21.57
		6	0	20.59	20.70	20.62

Band/BW	Modulation	RB Size	RB Offset	Low CH 19965	Mid CH 20175	High CH 20385
				Frequency 1711.5 MHz	Frequency 1732.5 MHz	Frequency 1753.5 MHz
4/3	QPSK	1	0	22.59	22.70	22.62
		1	7	22.58	22.69	22.61
		1	14	22.55	22.66	22.58
		8	0	21.64	21.75	21.67
		8	3	21.62	21.73	21.65
		8	7	21.57	21.68	21.60
		15	0	21.65	21.76	21.68
	16QAM	1	0	21.60	21.71	21.63
		1	7	21.57	21.68	21.60
		1	14	21.56	21.67	21.59
		8	0	20.68	20.79	20.71
		8	3	20.67	20.78	20.70
		8	7	20.62	20.73	20.65
		15	0	20.60	20.71	20.63

Band/BW	Modulation	RB Size	RB Offset	Low CH 19975	Mid CH 20175	High CH 20375
				Frequency 1712.5 MHz	Frequency 1732.5 MHz	Frequency 1752.5 MHz
4/5	QPSK	1	0	22.62	22.73	22.65
		1	12	22.61	22.72	22.64
		1	24	22.58	22.69	22.61
		12	0	21.67	21.78	21.70
		12	6	21.65	21.76	21.68
		12	13	21.60	21.71	21.63
		25	0	21.68	21.79	21.71
	16QAM	1	0	21.63	21.74	21.66
		1	12	21.60	21.71	21.63
		1	24	21.59	21.70	21.62
		12	0	20.71	20.82	20.74
		12	6	20.70	20.81	20.73
		12	13	20.65	20.76	20.68
		25	0	20.63	20.74	20.66

Band/BW	Modulation	RB Size	RB Offset	Low CH 20000	Mid CH 20175	High CH 20350
				Frequency 1715 MHz	Frequency 1732.5 MHz	Frequency 1750 MHz
4/10	QPSK	1	0	22.66	22.77	22.69
		1	24	22.65	22.76	22.68
		1	49	22.62	22.73	22.65
		25	0	21.71	21.82	21.74
		25	12	21.69	21.80	21.72
		25	25	21.64	21.75	21.67
		50	0	21.72	21.83	21.75
	16QAM	1	0	21.67	21.78	21.70
		1	24	21.64	21.75	21.67
		1	49	21.63	21.74	21.66
		25	0	20.75	20.86	20.78
		25	12	20.74	20.85	20.77
		25	25	20.69	20.80	20.72
		50	0	20.67	20.78	20.70

Band/BW	Modulation	RB Size	RB Offset	Low CH 20025	Mid CH 20175	High CH 20325
				Frequency 1717.5 MHz	Frequency 1732.5 MHz	Frequency 1747.5 MHz
4/15	QPSK	1	0	22.72	22.83	22.75
		1	37	22.71	22.82	22.74
		1	74	22.68	22.79	22.71
		36	0	21.77	21.88	21.80
		36	19	21.75	21.86	21.78
		36	39	21.70	21.81	21.73
		75	0	21.78	21.89	21.81
	16QAM	1	0	21.73	21.84	21.76
		1	37	21.70	21.81	21.73
		1	74	21.69	21.80	21.72
		36	0	20.81	20.92	20.84
		36	19	20.80	20.91	20.83
		36	39	20.75	20.86	20.78
		75	0	20.73	20.84	20.76

Band/BW	Modulation	RB Size	RB Offset	Low CH 20050	Mid CH 20175	High CH 20300
				Frequency 1720 MHz	Frequency 1732.5 MHz	Frequency 1745 MHz
4/20	QPSK	1	0	22.75	22.86	22.78
		1	50	22.74	22.85	22.77
		1	99	22.71	22.82	22.74
		50	0	21.80	21.91	21.83
		50	25	21.78	21.89	21.81
		50	50	21.73	21.84	21.76
		100	0	21.81	21.92	21.84
	16QAM	1	0	21.76	21.87	21.79
		1	50	21.73	21.84	21.76
		1	99	21.72	21.83	21.75
		50	0	20.84	20.95	20.87
		50	25	20.83	20.94	20.86
		50	50	20.78	20.89	20.81
		100	0	20.76	20.87	20.79

Band/BW	Modulation	RB Size	RB Offset	Low CH 26697	Mid CH (26915)	High CH 27033
				Frequency (824.7) MHz	Frequency (836.5)MHz	Frequency (848.3) MHz
5/1.4	QPSK	1	0	22.62	22.81	22.74
		1	2	22.61	22.80	22.73
		1	5	22.58	22.77	22.70
		3	0	22.60	22.79	22.72
		3	1	22.59	22.78	22.71
		3	3	22.56	22.75	22.68
		6	0	21.68	21.87	21.80
	16QAM	1	0	21.63	21.82	21.75
		1	2	21.60	21.79	21.72
		1	5	21.59	21.78	21.71
		3	0	21.62	21.81	21.74
		3	1	21.59	21.78	21.71
		3	3	21.58	21.77	21.70
		6	0	20.63	20.82	20.75

Band/BW	Modulation	RB Size	RB Offset	Low CH (26805)	Mid CH (26915)	High CH (27025)
				Frequency (825.5)MHz	Frequency (836.5)MHz	Frequency (847.5)MHz
5/3	QPSK	1	0	22.66	22.85	22.78
		1	7	22.65	22.84	22.77
		1	14	22.62	22.81	22.74
		8	0	21.71	21.90	21.83
		8	3	21.69	21.88	21.81
		8	7	21.64	21.83	21.76
		15	0	21.72	21.91	21.84
	16QAM	1	0	21.67	21.86	21.79
		1	7	21.64	21.83	21.76
		1	14	21.63	21.82	21.75
		8	0	20.75	20.94	20.87
		8	3	20.74	20.93	20.86
		8	7	20.69	20.88	20.81
		15	0	20.67	20.86	20.79

Band/BW	Modulation	RB Size	RB Offset	Low CH (26815)	Mid CH (26915)	High CH (27015)
				Frequency (826.5)MHz	Frequency (836.5)MHz	Frequency (846.5)MHz
5/5	QPSK	1	0	22.72	22.91	22.84
		1	12	22.71	22.90	22.83
		1	24	22.68	22.87	22.80
		12	0	21.77	21.96	21.89
		12	6	21.75	21.94	21.87
		12	13	21.70	21.89	21.82
		25	0	21.78	21.97	21.90
	16QAM	1	0	21.73	21.92	21.85
		1	12	21.70	21.89	21.82
		1	24	21.69	21.88	21.81
		12	0	20.81	21.00	20.93
		12	6	20.80	20.99	20.92
		12	13	20.75	20.94	20.87
		25	0	20.73	20.92	20.85

Band/BW	Modulation	RB Size	RB Offset	Low CH (26840)	Mid CH (26915)	High CH (26990)
				Frequency (829)MHz	Frequency (836.5)MHz	Frequency (844)MHz
5/10	QPSK	1	0	22.75	22.94	22.87
		1	24	22.74	22.93	22.86
		1	49	22.71	22.90	22.83
		25	0	21.80	21.99	21.92
		25	12	21.78	21.97	21.90
		25	25	21.73	21.92	21.85
		50	0	21.81	22.00	21.93
	16QAM	1	0	21.76	21.95	21.88
		1	24	21.73	21.92	21.85
		1	49	21.72	21.91	21.84
		25	0	20.84	21.03	20.96
		25	12	20.83	21.02	20.95
		25	25	20.78	20.97	20.90
		50	0	20.76	20.95	20.88

Band/BW	Modulation	RB Size	RB Offset	Low CH 20775	Mid CH 21100	High CH 21425
				Frequency 2502.5 MHz	Frequency 2535 MHz	Frequency 2567.5 MHz
7/5	QPSK	1	0	20.46	20.60	20.44
		1	12	20.40	20.44	20.33
		1	24	20.41	20.46	20.31
		12	0	19.44	19.60	19.47
		12	6	19.45	19.54	19.37
		12	13	19.38	19.43	19.32
		25	0	19.44	19.61	19.50
	16QAM	1	0	19.41	19.56	19.42
		1	12	19.40	19.47	19.35
		1	24	19.39	19.47	19.38
		12	0	18.45	18.64	18.47
		12	6	18.47	18.60	18.46
		12	13	18.48	18.49	18.43
		25	0	18.41	18.52	18.39

Band/BW	Modulation	RB Size	RB Offset	Low CH 20800	Mid CH 21100	High CH 21400
				Frequency 2505 MHz	Frequency 2535 MHz	Frequency 2565 MHz
7/10	QPSK	1	0	20.50	20.64	20.48
		1	24	20.44	20.48	20.37
		1	49	20.45	20.50	20.35
		25	0	19.48	19.64	19.51
		25	12	19.49	19.58	19.41
		25	25	19.42	19.47	19.36
		50	0	19.48	19.65	19.54
	16QAM	1	0	19.45	19.60	19.46
		1	24	19.44	19.51	19.39
		1	49	19.43	19.51	19.42
		25	0	18.49	18.68	18.51
		25	12	18.51	18.64	18.50
		25	25	18.52	18.53	18.47
		50	0	18.45	18.56	18.43

Band/BW	Modulation	RB Size	RB Offset	Low CH 20825	Mid CH 21100	High CH 21375
				Frequency 2507.5 MHz	Frequency 2535 MHz	Frequency 2562.5 MHz
7/15	QPSK	1	0	20.56	20.70	20.54
		1	37	20.50	20.54	20.43
		1	74	20.51	20.56	20.41
		36	0	19.54	19.70	19.57
		36	19	19.55	19.64	19.47
		36	39	19.48	19.53	19.42
		75	0	19.54	19.71	19.60
	16QAM	1	0	19.51	19.66	19.52
		1	37	19.50	19.57	19.45
		1	74	19.49	19.57	19.48
		36	0	18.55	18.74	18.57
		36	19	18.57	18.70	18.56
		36	39	18.58	18.59	18.53
		75	0	18.51	18.62	18.49

Band/BW	Modulation	RB Size	RB Offset	Low CH 20850	Mid CH 21100	High CH 21350
				Frequency 2510 MHz	Frequency 2535 MHz	Frequency 2560 MHz
7/20	QPSK	1	0	20.59	20.73	20.57
		1	50	20.53	20.57	20.46
		1	99	20.54	20.59	20.44
		50	0	19.57	19.73	19.60
		50	25	19.58	19.67	19.50
		50	50	19.51	19.56	19.45
		100	0	19.57	19.74	19.63
	16QAM	1	0	19.54	19.69	19.55
		1	50	19.53	19.60	19.48
		1	99	19.52	19.60	19.51
		50	0	18.58	18.77	18.60
		50	25	18.60	18.73	18.59
		50	50	18.61	18.62	18.56
		100	0	18.54	18.65	18.52

Band/BW	Modulation	RB Size	RB Offset	Low CH 23017	Mid CH 23095	High CH 23173
				Frequency 699.7 MHz	Frequency 707.5 MHz	Frequency 715.3 MHz
12/1.4	QPSK	1	0	22.60	22.78	22.69
		1	2	22.59	22.77	22.68
		1	5	22.56	22.74	22.65
		3	0	22.58	22.76	22.67
		3	1	22.57	22.75	22.66
		3	3	22.54	22.72	22.63
	16QAM	6	0	21.61	21.80	21.70
		1	0	21.56	21.75	21.65
		1	2	21.53	21.72	21.62
		1	5	21.52	21.71	21.61
		3	0	21.55	21.74	21.64
		3	1	21.52	21.71	21.61
		3	3	21.51	21.70	21.60
		6	0	20.56	20.75	20.65

Band/BW	Modulation	RB Size	RB Offset	Low CH 23025	Mid CH 23095	High CH 23165
				Frequency 700.5 MHz	Frequency 707.5 MHz	Frequency 714.5 MHz
12/3	QPSK	1	0	22.64	22.82	22.73
		1	7	22.63	22.81	22.72
		1	14	22.60	22.78	22.69
		8	0	21.64	21.83	21.73
		8	3	21.62	21.81	21.71
		8	7	21.57	21.76	21.66
		15	0	21.65	21.84	21.74
	16QAM	1	0	21.60	21.79	21.69
		1	7	21.57	21.76	21.66
		1	14	21.56	21.75	21.65
		8	0	20.68	20.87	20.77
		8	3	20.67	20.86	20.76
		8	7	20.62	20.81	20.71
		15	0	20.60	20.79	20.69

Band/BW	Modulation	RB Size	RB Offset	Low CH 23035	Mid CH 23095	High CH 23155
				Frequency 701.5 MHz	Frequency 707.5 MHz	Frequency 713.5 MHz
12/5	QPSK	1	0	22.70	22.88	22.79
		1	12	22.69	22.87	22.78
		1	24	22.66	22.84	22.75
		12	0	21.70	21.89	21.79
		12	6	21.68	21.87	21.77
		12	13	21.63	21.82	21.72
		25	0	21.71	21.90	21.80
	16QAM	1	0	21.66	21.85	21.75
		1	12	21.63	21.82	21.72
		1	24	21.62	21.81	21.71
		12	0	20.74	20.93	20.83
		12	6	20.73	20.92	20.82
		12	13	20.68	20.87	20.77
		25	0	20.66	20.85	20.75

Band/BW	Modulation	RB Size	RB Offset	Low CH 23060	Mid CH 23095	High CH 23130
				Frequency 704 MHz	Frequency 707.5 MHz	Frequency 711 MHz
12/10	QPSK	1	0	22.73	22.91	22.82
		1	24	22.72	22.90	22.81
		1	49	22.69	22.87	22.78
		25	0	21.73	21.92	21.82
		25	12	21.71	21.90	21.80
		25	25	21.66	21.85	21.75
		50	0	21.74	21.93	21.83
	16QAM	1	0	21.69	21.88	21.78
		1	24	21.66	21.85	21.75
		1	49	21.65	21.84	21.74
		25	0	20.77	20.96	20.86
		25	12	20.76	20.95	20.85
		25	25	20.71	20.90	20.80
		50	0	20.69	20.88	20.78

Band/BW	Modulation	RB Size	RB Offset	CH 23205	CH 23230	CH 23255
				779.5 MHz	782.0 MHz	784.5 MHz
13 / 5	QPSK	1	0	22.67	22.83	22.81
		1	12	22.68	22.82	22.79
		1	24	22.65	22.79	22.71
		12	0	21.75	21.88	21.81
		12	6	21.74	21.86	21.82
		12	13	21.62	21.81	21.77
		25	0	21.73	21.89	21.81
	16QAM	1	0	21.64	21.84	21.77
		1	12	21.68	21.81	21.71
		1	24	21.67	21.80	21.74
		12	0	20.74	20.92	20.87
		12	6	20.79	20.91	20.80
		12	13	20.68	20.86	20.77
		25	0	20.73	20.84	20.78

Band/BW	Modulation	RB Size	RB Offset	CH	CH 23230	CH
				MHz	782.0 MHz	MHz
13 / 10	QPSK	1	0	/	22.86	/
		1	24	/	22.85	/
		1	49	/	22.82	/
		25	0	/	21.80	/
		25	12	/	21.78	/
		25	25	/	21.73	/
		50	0	/	21.81	/
	16QAM	1	0	/	21.76	/
		1	24	/	21.73	/
		1	49	/	21.72	/
		25	0	/	20.84	/
		25	12	/	20.83	/
		25	25	/	20.78	/
		50	0	/	20.76	/

Band/BW	Modulation	RB Size	RB Offset	Low CH 26047	Mid CH 26365	High CH 26683
				Frequency 1850.7 MHz	Frequency 1882.5 MHz	Frequency 1914.3 MHz
25/1.4	QPSK	1	0	22.49	22.66	22.58
		1	2	22.48	22.65	22.57
		1	5	22.45	22.62	22.54
		3	0	22.47	22.64	22.56
		3	1	22.46	22.63	22.55
		3	3	22.43	22.60	22.52
	16QAM	6	0	21.55	21.72	21.64
		1	0	21.50	21.67	21.59
		1	2	21.47	21.64	21.56
		1	5	21.46	21.63	21.55
		3	0	21.49	21.66	21.58
		3	1	21.46	21.63	21.55
		3	3	21.45	21.62	21.54
		6	0	20.50	20.67	20.59

Band/BW	Modulation	RB Size	RB Offset	Low CH 26055	Mid CH 26365	High CH 26675
				Frequency 1851.5 MHz	Frequency 1882.5 MHz	Frequency 1913.5 MHz
(25)/3	QPSK	1	0	22.50	22.67	22.59
		1	7	22.49	22.66	22.58
		1	14	22.46	22.63	22.55
		8	0	21.55	21.72	21.64
		8	3	21.53	21.70	21.62
		8	7	21.48	21.65	21.57
		15	0	21.56	21.73	21.65
	16QAM	1	0	21.51	21.68	21.60
		1	7	21.48	21.65	21.57
		1	14	21.47	21.64	21.56
		8	0	20.59	20.76	20.68
		8	3	20.58	20.75	20.67
		8	7	20.53	20.70	20.62
		15	0	20.51	20.68	20.60

Band/BW	Modulation	RB Size	RB Offset	Low CH 26065	Mid CH 26365	High CH 26665
				Frequency 1852.5 MHz	Frequency 1882.5 MHz	Frequency 1912.5 MHz
25/5	QPSK	1	0	22.52	22.69	22.61
		1	12	22.51	22.68	22.60
		1	24	22.48	22.65	22.57
		12	0	21.57	21.74	21.66
		12	6	21.55	21.72	21.64
		12	13	21.50	21.67	21.59
		25	0	21.58	21.75	21.67
	16QAM	1	0	21.53	21.70	21.62
		1	12	21.50	21.67	21.59
		1	24	21.49	21.66	21.58
		12	0	20.61	20.78	20.70
		12	6	20.60	20.77	20.69
		12	13	20.55	20.72	20.64
		25	0	20.53	20.70	20.62

Band/BW	Modulation	RB Size	RB Offset	Low CH 26090	Mid CH 26365	High CH 26640
				Frequency 1855 MHz	Frequency 1882.5 MHz	Frequency 1910 MHz
25/10	QPSK	1	0	22.54	22.71	22.63
		1	24	22.53	22.70	22.62
		1	49	22.50	22.67	22.59
		25	0	21.59	21.76	21.68
		25	12	21.57	21.74	21.66
		25	25	21.52	21.69	21.61
		50	0	21.60	21.77	21.69
	16QAM	1	0	21.55	21.72	21.64
		1	24	21.52	21.69	21.61
		1	49	21.51	21.68	21.60
		25	0	20.63	20.80	20.72
		25	12	20.62	20.79	20.71
		25	25	20.57	20.74	20.66
		50	0	20.55	20.72	20.64

Band/BW	Modulation	RB Size	RB Offset	Low CH 26115	Mid CH 26365	High CH 26615
				Frequency 1857.5 MHz	Frequency 1882.5 MHz	Frequency 1907.5 MHz
25/15	QPSK	1	0	22.56	22.73	22.65
		1	37	22.55	22.72	22.64
		1	74	22.52	22.69	22.61
		36	0	21.61	21.78	21.70
		36	19	21.59	21.76	21.68
		36	39	21.54	21.71	21.63
		75	0	21.62	21.79	21.71
	16QAM	1	0	21.57	21.74	21.66
		1	37	21.54	21.71	21.63
		1	74	21.53	21.70	21.62
		36	0	20.65	20.82	20.74
		36	19	20.64	20.81	20.73
		36	39	20.59	20.76	20.68
		75	0	20.57	20.74	20.66

Band/BW	Modulation	RB Size	RB Offset	Low CH 26140	Mid CH 26365	High CH 26590
				Frequency 1860 MHz	Frequency 1882.5 MHz	Frequency 1905 MHz
25/20	QPSK	1	0	22.59	22.76	22.68
		1	50	22.58	22.75	22.67
		1	99	22.55	22.72	22.64
		50	0	21.64	21.81	21.73
		50	25	21.62	21.79	21.71
		50	50	21.57	21.74	21.66
		100	0	21.65	21.82	21.74
	16QAM	1	0	21.60	21.77	21.69
		1	50	21.57	21.74	21.66
		1	99	21.56	21.73	21.65
		50	0	20.68	20.85	20.77
		50	25	20.67	20.84	20.76
		50	50	20.62	20.79	20.71
		100	0	20.60	20.77	20.69

Band/BW	Modulation	RB Size	RB Offset	Low CH 26697	Mid CH (26915)	High CH 27033
				Frequency (824.7) MHz	Frequency (836.5)MHz	Frequency (848.3) MHz
26/1.4	QPSK	1	0	22.69	22.76	22.65
		1	2	22.68	22.75	22.64
		1	5	22.65	22.72	22.61
		3	0	22.67	22.74	22.63
		3	1	22.66	22.73	22.62
		3	3	22.63	22.70	22.59
		6	0	21.75	21.82	21.71
	16QAM	1	0	21.70	21.77	21.66
		1	2	21.67	21.74	21.63
		1	5	21.66	21.73	21.62
		3	0	21.69	21.76	21.65
		3	1	21.66	21.73	21.62
		3	3	21.65	21.72	21.61
		6	0	20.70	20.77	20.66

Band/BW	Modulation	RB Size	RB Offset	Low CH (26805)	Mid CH (26915)	High CH (27025)
				Frequency (825.5)MHz	Frequency (836.5)MHz	Frequency (847.5)MHz
(26)/3	QPSK	1	0	22.70	22.77	22.66
		1	7	22.69	22.76	22.65
		1	14	22.66	22.73	22.62
		8	0	21.75	21.82	21.71
		8	3	21.73	21.80	21.69
		8	7	21.68	21.75	21.64
		15	0	21.76	21.83	21.72
	16QAM	1	0	21.71	21.78	21.67
		1	7	21.68	21.75	21.64
		1	14	21.67	21.74	21.63
		8	0	20.79	20.86	20.75
		8	3	20.78	20.85	20.74
		8	7	20.73	20.80	20.69
		15	0	20.71	20.78	20.67

Band/BW	Modulation	RB Size	RB Offset	Low CH (26815)	Mid CH (26915)	High CH (27015)
				Frequency (826.5)MHz	Frequency (836.5)MHz	Frequency (846.5)MHz
(26)/5	QPSK	1	0	22.72	22.79	22.68
		1	12	22.71	22.78	22.67
		1	24	22.68	22.75	22.64
		12	0	21.77	21.84	21.73
		12	6	21.75	21.82	21.71
		12	13	21.70	21.77	21.66
		25	0	21.78	21.85	21.74
	16QAM	1	0	21.73	21.80	21.69
		1	12	21.70	21.77	21.66
		1	24	21.69	21.76	21.65
		12	0	20.81	20.88	20.77
		12	6	20.80	20.87	20.76
		12	13	20.75	20.82	20.71
		25	0	20.73	20.80	20.69

Band/BW	Modulation	RB Size	RB Offset	Low CH (26840)	Mid CH (26915)	High CH (26990)
				Frequency (829)MHz	Frequency (836.5)MHz	Frequency (844)MHz
(26)/10	QPSK	1	0	22.74	22.81	22.70
		1	24	22.73	22.80	22.69
		1	49	22.70	22.77	22.66
		25	0	21.79	21.86	21.75
		25	12	21.77	21.84	21.73
		25	25	21.72	21.79	21.68
		50	0	21.80	21.87	21.76
	16QAM	1	0	21.75	21.82	21.71
		1	24	21.72	21.79	21.68
		1	49	21.71	21.78	21.67
		25	0	20.83	20.90	20.79
		25	12	20.82	20.89	20.78
		25	25	20.77	20.84	20.73
		50	0	20.75	20.82	20.71

Band/BW	Modulation	RB Size	RB Offset	Low CH (26865)	Mid CH (26915)	High CH (26965)
				Frequency (831.5)MHz	Frequency (836.5)MHz	Frequency (841.5)MHz
(26)/15	QPSK	1	0	22.76	22.83	22.72
		1	37	22.75	22.82	22.71
		1	74	22.72	22.79	22.68
		36	0	21.81	21.88	21.77
		36	19	21.79	21.86	21.75
		36	39	21.74	21.81	21.70
		75	0	21.82	21.89	21.78
	16QAM	1	0	21.77	21.84	21.73
		1	37	21.74	21.81	21.70
		1	74	21.73	21.80	21.69
		36	0	20.85	20.92	20.81
		36	19	20.84	20.91	20.80
		36	39	20.79	20.86	20.75
		75	0	20.77	20.84	20.73

Band/BW	Modulation	RB Size	RB Offset	Low CH 27685	Mid CH 27710	High CH 27735
				2307.5 MHz	2310.0 MHz	2312.5 MHz
30 / 5	QPSK	1	0	22.68	22.71	22.66
		1	12	22.67	22.70	22.65
		1	24	22.64	22.67	22.62
		12	0	21.73	21.76	21.71
		12	6	21.71	21.74	21.69
		12	13	21.66	21.69	21.64
		25	0	21.74	21.77	21.72
	16QAM	1	0	21.69	21.72	21.67
		1	12	21.66	21.69	21.64
		1	24	21.65	21.68	21.63
		12	0	20.77	20.80	20.75
		12	6	20.76	20.79	20.74
		12	13	20.71	20.74	20.69
		25	0	20.69	20.72	20.67

Band/BW	Modulation	RB Size	RB Offset	CH	Mid CH 27710	CH
				MHz	2310.0 MHz	MHz
30 / 10	QPSK	1	0	/	22.86	/
		1	24	/	22.85	/
		1	49	/	22.82	/
		25	0	/	21.91	/
		25	12	/	21.89	/
		25	25	/	21.84	/
		50	0	/	21.92	/
	16QAM	1	0	/	21.87	/
		1	24	/	21.84	/
		1	49	/	21.83	/
		25	0	/	20.95	/
		25	12	/	20.94	/
		25	25	/	20.89	/
		50	0	/	20.87	/

Band/BW	Modulation	RB Size	RB Offset	Low CH (39675)	Mid CH (40620)	High CH (41565)
				Frequency (2498.5)MHz	Frequency (2593)MHz	Frequency (2687.5)MHz
(41)/5	QPSK	1	0	22.65	22.72	22.54
		1	12	22.64	22.71	22.53
		1	24	22.61	22.68	22.50
		12	0	21.70	21.77	21.59
		12	6	21.68	21.75	21.57
		12	13	21.63	21.70	21.52
		25	0	21.71	21.78	21.60
	16QAM	1	0	21.66	21.73	21.55
		1	12	21.63	21.70	21.52
		1	24	21.62	21.69	21.51
		12	0	20.74	20.81	20.63
		12	6	20.73	20.80	20.62
		12	13	20.68	20.75	20.57
		25	0	20.66	20.73	20.55

Band/BW	Modulation	RB Size	RB Offset	Low CH (39700)	Mid CH (40620)	High CH (41540)
				Frequency (2501)MHz	Frequency (2593)MHz	Frequency (2685)MHz
(41)/10	QPSK	1	0	22.68	22.75	22.57
		1	24	22.67	22.74	22.56
		1	49	22.64	22.71	22.53
		25	0	21.73	21.80	21.62
		25	12	21.71	21.78	21.60
		25	25	21.66	21.73	21.55
		50	0	21.74	21.81	21.63
	16QAM	1	0	21.69	21.76	21.58
		1	24	21.66	21.73	21.55
		1	49	21.65	21.72	21.54
		25	0	20.77	20.84	20.66
		25	12	20.76	20.83	20.65
		25	25	20.71	20.78	20.60
		50	0	20.69	20.76	20.58

Band/BW	Modulation	RB Size	RB Offset	Low CH (39725)	Mid CH (40620)	High CH (41515)
				Frequency (2503.5)MHz	Frequency (2593)MHz	Frequency (2682.5)MHz
(41)/15	QPSK	1	0	22.72	22.79	22.61
		1	37	22.71	22.78	22.60
		1	74	22.68	22.75	22.57
		36	0	21.77	21.84	21.66
		36	19	21.75	21.82	21.64
		36	39	21.70	21.77	21.59
		75	0	21.78	21.85	21.67
	16QAM	1	0	21.73	21.80	21.62
		1	37	21.70	21.77	21.59
		1	74	21.69	21.76	21.58
		36	0	20.81	20.88	20.70
		36	19	20.80	20.87	20.69
		36	39	20.75	20.82	20.64
		75	0	20.73	20.80	20.62

Band/BW	Modulation	RB Size	RB Offset	Low CH (39750)	Mid CH (40620)	High CH (41490)
				Frequency (2506)MHz	Frequency (2593)MHz	Frequency (2680)MHz
(41)/20	QPSK	1	0	22.78	22.85	22.67
		1	50	22.77	22.84	22.66
		1	99	22.74	22.81	22.63
		50	0	21.83	21.90	21.72
		50	25	21.81	21.88	21.70
		50	50	21.76	21.83	21.65
		100	0	21.84	21.91	21.73
	16QAM	1	0	21.79	21.86	21.68
		1	50	21.76	21.83	21.65
		1	99	21.75	21.82	21.64
		50	0	20.87	20.94	20.76
		50	25	20.86	20.93	20.75
		50	50	20.81	20.88	20.70
		100	0	20.79	20.86	20.68

APPENDIX B: TEST DATA FOR EFFECTIVE (ISOTROPIC) RADIATED POWER

Band/BW	Modulation	RB Size	RB Offset	Low CH 18607	Mid CH 18900	High CH 19193
				1850.7 MHz	1880.0 MHz	1909.3 MHz
2/1.4	QPSK	1	0	24.31	24.33	24.42
		1	2	24.36	24.20	24.41
		1	5	24.25	24.42	24.36
		3	0	24.36	24.37	24.22
		3	1	24.35	24.37	24.34
		3	3	24.22	24.26	24.30
		6	0	23.36	23.34	23.50
	16QAM	1	0	23.34	23.27	23.40
		1	2	23.19	23.35	23.29
		1	5	23.34	23.33	23.35
		3	0	23.31	23.50	23.50
		3	1	23.30	23.26	23.28
		3	3	23.13	23.30	23.24
		6	0	22.22	22.36	22.46

Band/BW	Modulation	RB Size	RB Offset	Low CH 18615	Mid CH 18900	High CH 19185
				1851.5 MHz	1880.0 MHz	1908.5 MHz
2/3	QPSK	1	0	24.25	24.32	24.32
		1	7	24.22	24.23	24.31
		1	14	24.32	24.34	24.48
		8	0	23.41	23.30	23.34
		8	3	23.51	23.47	23.38
		8	7	23.19	23.37	23.31
		15	0	23.27	23.52	23.44
	16QAM	1	0	23.31	23.27	23.39
		1	7	23.30	23.27	23.41
		1	14	23.29	23.33	23.38
		8	0	22.44	22.57	22.53
		8	3	22.32	22.43	22.49
		8	7	22.38	22.25	22.42
		15	0	22.27	22.46	22.42

Band/BW	Modulation	RB Size	RB Offset	Low CH 18625	Mid CH 18900	High CH 19175
				1852.5 MHz	1880.0 MHz	1907.5 MHz
2/5	QPSK	1	0	24.31	24.36	24.44
		1	12	24.42	24.45	24.42
		1	24	24.19	24.29	24.41
		12	0	23.45	23.53	23.52
		12	6	23.28	23.48	23.44
		12	13	23.20	23.44	23.37
		25	0	23.32	23.45	23.39
	16QAM	1	0	23.50	23.41	23.31
		1	12	23.40	23.28	23.34
		1	24	23.19	23.31	23.25
		12	0	22.48	22.46	22.44
		12	6	22.24	22.43	22.36
		12	13	22.46	22.43	22.34
		25	0	22.35	22.43	22.28

Band/BW	Modulation	RB Size	RB Offset	Low CH 18650	Mid CH 18900	High CH 19150
				1855.0 MHz	1880.0 MHz	1905.0 MHz
2/10	QPSK	1	0	24.35	24.36	24.26
		1	24	24.27	24.43	24.32
		1	49	24.17	24.46	24.40
		25	0	23.40	23.44	23.54
		25	12	23.26	23.48	23.42
		25	25	23.37	23.32	23.38
		50	0	23.42	23.46	23.43
	16QAM	1	0	23.42	23.28	23.44
		1	24	23.35	23.39	23.25
		1	49	23.20	23.41	23.41
		25	0	22.45	22.45	22.57
		25	12	22.50	22.52	22.54
		25	25	22.35	22.49	22.53
		50	0	22.45	22.50	22.41

Band/BW	Modulation	RB Size	RB Offset	Low CH 18675	Mid CH 18900	High CH 19125
				1857.5 MHz	1880.0 MHz	1902.5 MHz
2/15	QPSK	1	0	24.24	24.52	24.36
		1	37	24.20	24.51	24.39
		1	74	24.20	24.44	24.29
		36	0	23.48	23.49	23.53
		36	19	23.43	23.42	23.57
		36	39	23.21	23.42	23.37
	16QAM	75	0	23.58	23.55	23.49
		1	0	23.35	23.38	23.40
		1	37	23.39	23.51	23.33
		1	74	23.23	23.51	23.47
		36	0	22.38	22.58	22.43
		36	19	22.57	22.50	22.55
		36	39	22.46	22.46	22.37
		75	0	22.47	22.35	22.43

Band/BW	Modulation	RB Size	RB Offset	Low CH 18700	Mid CH 18900	High CH 19100
				1860.0 MHz	1880.0 MHz	1900.0 MHz
2/20	QPSK	1	0	24.43	24.41	24.62
		1	50	24.29	24.46	24.41
		1	99	24.31	24.43	24.45
		50	0	23.46	23.39	23.56
		50	25	23.47	23.37	23.50
		50	50	23.22	23.34	23.44
	16QAM	100	0	23.50	23.61	23.52
		1	0	23.35	23.57	23.50
		1	50	23.39	23.36	23.56
		1	99	23.43	23.51	23.39
		50	0	22.52	22.55	22.40
		50	25	22.47	22.50	22.37
		50	50	22.57	22.54	22.52
		100	0	22.50	22.46	22.45

Band/BW	Modulation	RB Size	RB Offset	Low CH 19957	Mid CH 20175	High CH 20393
				Frequency 1710.7 MHz	Frequency 1732.5 MHz	Frequency 1754.3 MHz
4/1.4	QPSK	1	0	24.82	24.72	24.73
		1	2	24.75	24.74	24.80
		1	5	24.56	24.59	24.72
		3	0	24.69	24.66	24.61
		3	1	24.81	24.71	24.69
		3	3	24.72	24.78	24.57
	16QAM	6	0	23.85	23.57	23.71
		1	0	23.65	23.69	23.79
		1	2	23.93	23.74	23.80
		1	5	23.70	23.78	23.55
		3	0	23.65	23.74	23.74
		3	1	23.63	23.73	23.62
		3	3	23.59	23.79	23.72
		6	0	22.90	22.79	22.83
Limit:		30				

Band/BW	Modulation	RB Size	RB Offset	Low CH 19965	Mid CH 20175	High CH 20385
				Frequency 1711.5 MHz	Frequency 1732.5 MHz	Frequency 1753.5 MHz
4/3	QPSK	1	0	24.70	24.72	24.95
		1	7	24.89	24.62	24.71
		1	14	24.84	24.65	24.66
		8	0	24.00	23.83	23.58
		8	3	23.82	23.67	23.95
		8	7	23.75	23.70	23.82
		15	0	23.85	23.56	23.65
	16QAM	1	0	23.89	23.57	23.71
		1	7	23.68	23.77	23.63
		1	14	23.76	23.59	23.82
		8	0	22.89	22.72	22.72
		8	3	22.81	22.97	22.87
		8	7	22.80	22.75	22.70
		15	0	22.81	22.61	22.75
Limit:		30				

Band/BW	Modulation	RB Size	RB Offset	Low CH 19975	Mid CH 20175	High CH 20375
				Frequency 1712.5 MHz	Frequency 1732.5 MHz	Frequency 1752.5 MHz
4/5	QPSK	1	0	24.87	24.78	24.92
		1	12	24.84	24.59	24.61
		1	24	24.62	24.63	24.63
		12	0	23.94	23.93	23.79
		12	6	23.84	23.92	23.71
		12	13	23.72	23.56	23.85
	16QAM	25	0	23.91	23.74	23.89
		1	0	23.88	23.76	23.60
		1	12	23.62	23.73	23.74
		1	24	23.81	23.86	23.92
		12	0	22.96	22.88	22.86
		12	6	22.77	22.78	22.80
		12	13	22.88	22.68	22.83
		25	0	22.89	22.88	22.64
Limit:		30				

Band/BW	Modulation	RB Size	RB Offset	Low CH 20000	Mid CH 20175	High CH 20350
				Frequency 1715 MHz	Frequency 1732.5 MHz	Frequency 1750 MHz
4/10	QPSK	1	0	24.79	24.90	24.82
		1	24	24.82	24.89	24.79
		1	49	24.71	24.82	24.80
		25	0	23.93	23.85	23.78
		25	12	23.76	23.82	23.91
		25	25	23.83	23.57	23.77
	16QAM	50	0	23.87	23.79	23.96
		1	0	23.87	23.71	23.83
		1	24	23.90	23.73	23.94
		1	49	23.79	23.79	23.94
		25	0	22.83	23.04	22.97
		25	12	22.76	22.98	23.00
		25	25	22.69	22.78	22.93
		50	0	22.94	22.75	22.82
Limit:		30				

Band/BW	Modulation	RB Size	RB Offset	Low CH 20025	Mid CH 20175	High CH 20325
				Frequency 1717.5 MHz	Frequency 1732.5 MHz	Frequency 1747.5 MHz
4/15	QPSK	1	0	24.94	24.76	24.99
		1	37	24.81	24.83	24.96
		1	74	24.99	24.66	24.86
		36	0	24.07	23.82	23.91
		36	19	23.86	24.05	23.88
		36	39	23.76	24.00	23.91
		75	0	23.84	24.05	23.93
	16QAM	1	0	23.85	23.75	23.93
		1	37	23.73	23.85	23.96
		1	74	23.83	23.70	23.72
		36	0	23.01	22.93	23.02
		36	19	23.02	22.83	22.81
		36	39	22.88	22.83	22.87
		75	0	22.86	22.75	22.72
		Limit:		30		

Band/BW	Modulation	RB Size	RB Offset	Low CH 20050	Mid CH 20175	High CH 20300
				Frequency 1720 MHz	Frequency 1732.5 MHz	Frequency 1745 MHz
4/20	QPSK	1	0	24.85	24.87	24.81
		1	50	25.10	24.83	24.83
		1	99	24.91	24.83	24.84
		50	0	24.07	23.97	23.79
		50	25	24.06	23.83	23.91
		50	50	24.01	23.85	23.93
		100	0	24.02	23.98	24.01
	16QAM	1	0	23.94	23.95	23.84
		1	50	23.92	24.00	23.68
		1	99	23.83	23.86	24.00
		50	0	23.00	22.95	23.03
		50	25	23.06	22.85	22.81
		50	50	22.79	22.87	22.89
		100	0	22.95	22.75	22.85
		Limit:		30		

Band/BW	Modulation	RB Size	RB Offset	Low CH 26697	Mid CH (26915)	High CH 27033
				Frequency (824.7) MHz	Frequency (836.5)MHz	Frequency (848.3) MHz
5/1.4	QPSK	1	0	24.19	24.06	24.25
		1	2	24.23	24.26	24.30
		1	5	24.12	24.18	24.24
		3	0	24.30	24.33	24.03
		3	1	24.37	24.24	24.43
		3	3	24.13	24.30	24.44
		6	0	23.14	23.27	23.33
	16QAM	1	0	23.53	23.29	23.29
		1	2	23.16	23.35	23.34
		1	5	23.23	23.38	23.48
		3	0	23.34	23.43	23.04
		3	1	23.27	23.06	23.14
		3	3	23.10	23.26	23.34
		6	0	22.33	22.45	22.16

Band/BW	Modulation	RB Size	RB Offset	Low CH (26805)	Mid CH (26915)	High CH (27025)
				Frequency (825.5)MHz	Frequency (836.5)MHz	Frequency (847.5)MHz
5/3	QPSK	1	0	24.11	24.04	24.21
		1	7	24.21	24.21	24.24
		1	14	24.06	24.15	24.15
		8	0	24.23	24.27	24.01
		8	3	24.36	24.18	24.41
		8	7	24.08	24.21	24.41
		15	0	23.08	23.22	23.26
	16QAM	1	0	23.48	23.25	23.23
		1	7	23.08	23.29	23.31
		1	14	23.16	23.31	23.40
		8	0	23.34	23.36	23.03
		8	3	23.25	22.97	23.11
		8	7	23.08	23.22	23.32
		15	0	22.27	22.43	22.08

Band/BW	Modulation	RB Size	RB Offset	Low CH (26815)	Mid CH (26915)	High CH (27015)
				Frequency (826.5)MHz	Frequency (836.5)MHz	Frequency (846.5)MHz
5/5	QPSK	1	0	24.04	24.38	24.45
		1	12	24.42	24.50	24.13
		1	24	24.26	23.97	24.29
		12	0	23.23	23.48	23.31
		12	6	23.11	23.51	23.40
		12	13	23.18	23.45	23.27
	16QAM	25	0	23.34	23.40	23.35
		1	0	23.41	23.39	23.37
		1	12	23.41	23.45	23.28
		1	24	23.10	23.44	23.48
		12	0	22.20	22.30	22.44
		12	6	22.36	22.46	22.54
		12	13	22.60	22.35	22.18
		25	0	22.39	22.41	22.18

Band/BW	Modulation	RB Size	RB Offset	Low CH (26840)	Mid CH (26915)	High CH (26990)
				Frequency (829)MHz	Frequency (836.5)MHz	Frequency (844)MHz
5/10	QPSK	1	0	24.33	24.47	24.24
		1	24	24.25	24.22	24.36
		1	49	24.42	24.33	24.16
		25	0	23.37	23.41	23.41
		25	12	23.49	23.34	23.14
		25	25	23.28	23.29	23.31
		50	0	23.41	23.17	23.53
	16QAM	1	0	23.25	23.52	23.34
		1	24	23.30	23.15	23.38
		1	49	23.35	23.47	23.34
		25	0	22.37	22.23	22.56
		25	12	22.52	22.57	22.35
		25	25	22.30	22.32	22.45
		50	0	22.11	22.39	22.07

Band/BW	Modulation	RB Size	RB Offset	Low CH 20775	Mid CH 21100	High CH 21425
				Frequency 2502.5 MHz	Frequency 2535 MHz	Frequency 2567.5 MHz
7/5	QPSK	1	0	23.50	23.67	23.75
		1	12	23.67	23.58	23.49
		1	24	23.50	23.68	23.44
		12	0	22.61	22.78	22.71
		12	6	22.76	22.76	22.55
		12	13	22.62	22.52	22.76
		25	0	22.72	22.64	22.64
	16QAM	1	0	22.60	22.79	22.63
		1	12	22.65	22.61	22.59
		1	24	22.72	22.49	22.64
		12	0	21.65	21.64	21.82
		12	6	21.80	21.72	21.83
		12	13	21.75	21.72	21.66
		25	0	21.76	21.78	21.58
		Limit:		33		

Band/BW	Modulation	RB Size	RB Offset	Low CH 20800	Mid CH 21100	High CH 21400
				Frequency 2505 MHz	Frequency 2535 MHz	Frequency 2565 MHz
7/10	QPSK	1	0	23.45	23.60	23.65
		1	24	23.60	23.52	23.44
		1	49	23.45	23.66	23.36
		25	0	22.52	22.70	22.70
		25	12	22.70	22.75	22.52
		25	25	22.53	22.50	22.66
		50	0	22.63	22.59	22.55
	16QAM	1	0	22.52	22.70	22.59
		1	24	22.58	22.57	22.57
		1	49	22.68	22.43	22.60
		25	0	21.59	21.62	21.74
		25	12	21.76	21.69	21.82
		25	25	21.73	21.66	21.61
		50	0	21.73	21.71	21.56
		Limit:		33		

Band/BW	Modulation	RB Size	RB Offset	Low CH 20825	Mid CH 21100	High CH 21375
				Frequency 2507.5 MHz	Frequency 2535 MHz	Frequency 2562.5 MHz
7/15	QPSK	1	0	23.24	23.21	23.44
		1	37	23.53	23.41	22.97
		1	74	23.18	23.28	23.27
		36	0	22.55	22.35	22.21
		36	19	22.73	22.50	22.44
		36	39	22.63	22.56	22.20
		75	0	22.47	22.61	21.93
	16QAM	1	0	22.42	22.21	22.45
		1	37	22.20	22.48	22.30
		1	74	22.31	22.18	22.14
		36	0	21.09	20.96	21.72
		36	19	21.05	21.50	21.23
		36	39	21.18	21.39	21.05
		75	0	21.48	21.45	21.31
Limit:		33				

Band/BW	Modulation	RB Size	RB Offset	Low CH 20850	Mid CH 21100	High CH 21350
				Frequency 2510 MHz	Frequency 2535 MHz	Frequency 2560 MHz
7/20	QPSK	1	0	23.74	23.91	23.70
		1	50	23.59	23.61	23.58
		1	99	23.56	23.87	23.65
		50	0	22.90	22.82	22.72
		50	25	22.73	22.62	22.70
		50	50	22.81	22.85	22.66
		100	0	22.84	22.94	22.89
	16QAM	1	0	22.69	22.61	22.87
		1	50	22.84	22.71	22.56
		1	99	22.82	22.65	22.64
		50	0	21.90	21.76	21.73
		50	25	21.92	21.81	21.85
		50	50	21.81	21.95	21.82
		100	0	21.79	21.74	21.77
Limit:		33				

Band/BW	Modulation	RB Size	RB Offset	Low CH 23017	Mid CH 23095	High CH 23173
				Frequency 699.7 MHz	Frequency 707.5 MHz	Frequency 715.3 MHz
12/1.4	QPSK	1	0	24.28	24.41	24.15
		1	2	24.27	24.45	24.10
		1	5	24.19	24.22	24.21
		3	0	24.33	24.39	24.24
		3	1	24.21	24.39	24.15
		3	3	24.27	24.19	24.28
	16QAM	6	0	23.34	23.47	23.39
		1	0	23.42	23.26	23.16
		1	2	23.20	23.36	23.26
		1	5	23.16	23.16	23.18
		3	0	23.32	23.31	23.15
		3	1	23.32	23.23	23.21
		3	3	23.35	23.36	23.20
		6	0	22.34	22.32	22.29
Limit:		34.8				

Band/BW	Modulation	RB Size	RB Offset	Low CH 23025	Mid CH 23095	High CH 23165
				Frequency 700.5 MHz	Frequency 707.5 MHz	Frequency 714.5 MHz
12/3	QPSK	1	0	24.27	24.37	24.22
		1	7	24.54	24.35	24.31
		1	14	24.25	24.28	24.21
		8	0	24.32	24.42	24.28
		8	3	24.19	24.38	24.15
		8	7	24.25	24.23	24.32
		15	0	23.33	23.55	23.41
	16QAM	1	0	23.36	23.30	23.16
		1	7	23.23	23.39	23.27
		1	14	23.14	23.13	23.18
		8	0	23.36	23.24	23.16
		8	3	23.34	23.28	23.23
		8	7	23.35	23.35	23.25
		15	0	22.38	22.39	22.33
Limit:		34.8				

Band/BW	Modulation	RB Size	RB Offset	Low CH 23035	Mid CH 23095	High CH 23155
				Frequency 701.5 MHz	Frequency 707.5 MHz	Frequency 713.5 MHz
12/5	QPSK	1	0	24.29	24.47	24.47
		1	12	24.53	24.35	24.33
		1	24	24.46	24.37	24.35
		12	0	23.49	23.44	23.55
		12	6	23.53	23.64	23.48
		12	13	23.25	23.57	23.27
	16QAM	25	0	23.60	23.64	23.40
		1	0	23.54	23.47	23.46
		1	12	23.40	23.35	23.24
		1	24	23.39	23.37	23.39
		12	0	22.63	22.45	22.45
		12	6	22.57	22.43	22.39
		12	13	22.41	22.36	22.36
		25	0	22.45	22.54	22.27
		Limit:		34.8		

Band/BW	Modulation	RB Size	RB Offset	Low CH 23060	Mid CH 23095	High CH 23130
				Frequency 704 MHz	Frequency 707.5 MHz	Frequency 711 MHz
12/10	QPSK	1	0	24.59	24.92	24.87
		1	24	24.66	25.06	24.75
		1	49	24.89	25.04	24.93
		25	0	24.30	24.25	23.66
		25	12	24.16	23.99	23.85
		25	25	24.03	24.02	23.74
		50	0	24.25	24.11	23.90
	16QAM	1	0	24.04	24.18	23.70
		1	24	23.87	23.90	24.24
		1	49	23.90	24.25	23.82
		25	0	22.90	23.08	23.06
		25	12	23.29	22.75	23.20
		25	25	22.97	23.04	22.68
		50	0	22.73	22.66	22.90
		Limit:		34.8		

Band/BW	Modulation	RB Size	RB Offset	CH 23205	CH 23230	CH 23255
				779.5 MHz	782.0 MHz	784.5 MHz
13 / 5	QPSK	1	0	24.28	24.24	24.13
		1	12	24.11	24.22	24.28
		1	24	24.23	24.26	24.25
		12	0	23.32	23.30	23.23
		12	6	23.15	23.19	23.26
		12	13	23.33	23.19	23.33
		25	0	23.25	23.41	23.44
	16QAM	1	0	23.34	23.27	23.20
		1	12	23.25	23.33	23.31
		1	24	23.19	23.28	23.28
		12	0	22.47	22.37	22.25
		12	6	22.34	22.25	22.31
		12	13	22.27	22.34	22.37
		25	0	22.16	22.16	22.37
Limit:		34.8				

Band/BW	Modulation	RB Size	RB Offset	CH	CH 23230	CH
				MHz	782.0 MHz	MHz
13 / 10	QPSK	1	0	/	24.27	/
		1	24	/	24.23	/
		1	49	/	24.24	/
		25	0	/	23.37	/
		25	12	/	23.32	/
		25	25	/	23.11	/
		50	0	/	23.14	/
	16QAM	1	0	/	23.22	/
		1	24	/	23.19	/
		1	49	/	23.23	/
		25	0	/	22.39	/
		25	12	/	22.16	/
		25	25	/	22.29	/
		50	0	/	22.22	/
Limit:		34.8				

Band/BW	Modulation	RB Size	RB Offset	Low CH 26047	Mid CH 26365	High CH 26683
				Frequency 1850.7 MHz	Frequency 1882.5 MHz	Frequency 1914.3 MHz
25/1.4	QPSK	1	0	24.38	24.38	24.48
		1	2	24.45	24.29	24.45
		1	5	24.26	24.52	24.45
		3	0	24.36	24.43	24.31
		3	1	24.38	24.46	24.41
		3	3	24.22	24.35	24.33
	16QAM	6	0	23.40	23.37	23.57
		1	0	23.39	23.32	23.46
		1	2	23.27	23.43	23.37
		1	5	23.36	23.34	23.44
		3	0	23.36	23.52	23.54
		3	1	23.36	23.33	23.36
		3	3	23.20	23.33	23.30
		6	0	22.30	22.41	22.51
Limit:		33				

Band/BW	Modulation	RB Size	RB Offset	Low CH 26055	Mid CH 26365	High CH 26675
				Frequency 1851.5 MHz	Frequency 1882.5 MHz	Frequency 1913.5 MHz
(25)/3	QPSK	1	0	24.30	24.34	24.33
		1	7	24.23	24.29	24.37
		1	14	24.39	24.43	24.49
		8	0	23.47	23.37	23.35
		8	3	23.54	23.50	23.47
		8	7	23.27	23.46	23.40
		15	0	23.33	23.58	23.53
	16QAM	1	0	23.34	23.31	23.45
		1	7	23.35	23.33	23.44
		1	14	23.33	23.39	23.46
		8	0	22.48	22.57	22.59
		8	3	22.32	22.51	22.51
		8	7	22.38	22.34	22.46
		15	0	22.34	22.50	22.49
Limit:		33				

Band/BW	Modulation	RB Size	RB Offset	Low CH 26065	Mid CH 26365	High CH 26665
				Frequency 1852.5 MHz	Frequency 1882.5 MHz	Frequency 1912.5 MHz
25/5	QPSK	1	0	24.31	24.40	24.45
		1	12	24.42	24.55	24.44
		1	24	24.23	24.33	24.43
		12	0	23.46	23.60	23.59
		12	6	23.36	23.52	23.48
		12	13	23.29	23.46	23.43
		25	0	23.37	23.48	23.48
	16QAM	1	0	23.52	23.47	23.39
		1	12	23.44	23.31	23.37
		1	24	23.24	23.35	23.32
		12	0	22.51	22.52	22.48
		12	6	22.34	22.46	22.43
		12	13	22.48	22.50	22.42
		25	0	22.43	22.49	22.36
Limit:				33		

Band/BW	Modulation	RB Size	RB Offset	Low CH 26090	Mid CH 26365	High CH 26640
				Frequency 1855 MHz	Frequency 1882.5 MHz	Frequency 1910 MHz
25/10	QPSK	1	0	24.39	24.44	24.32
		1	24	24.34	24.44	24.40
		1	49	24.27	24.52	24.43
		25	0	23.44	23.52	23.60
		25	12	23.33	23.58	23.51
		25	25	23.40	23.39	23.42
		50	0	23.49	23.48	23.49
	16QAM	1	0	23.43	23.34	23.49
		1	24	23.41	23.41	23.32
		1	49	23.28	23.45	23.50
		25	0	22.48	22.53	22.60
		25	12	22.55	22.58	22.56
		25	25	22.43	22.57	22.54
		50	0	22.52	22.56	22.44
Limit:				33		

Band/BW	Modulation	RB Size	RB Offset	Low CH 26115	Mid CH 26365	High CH 26615
				Frequency 1857.5 MHz	Frequency 1882.5 MHz	Frequency 1907.5 MHz
25/15	QPSK	1	0	24.31	24.54	24.46
		1	37	24.25	24.56	24.43
		1	74	24.27	24.49	24.39
		36	0	23.52	23.51	23.55
		36	19	23.46	23.51	23.59
		36	39	23.29	23.52	23.43
	16QAM	75	0	23.59	23.62	23.58
		1	0	23.41	23.43	23.44
		1	37	23.39	23.54	23.42
		1	74	23.31	23.52	23.55
		36	0	22.42	22.66	22.52
		36	19	22.60	22.58	22.59
		36	39	22.53	22.52	22.44
		75	0	22.55	22.44	22.49
Limit:		33				

Band/BW	Modulation	RB Size	RB Offset	Low CH 26140	Mid CH 26365	High CH 26590
				Frequency 1860 MHz	Frequency 1882.5 MHz	Frequency 1905 MHz
25/20	QPSK	1	0	24.45	24.49	24.67
		1	50	24.30	24.47	24.42
		1	99	24.40	24.49	24.54
		50	0	23.52	23.48	23.65
		50	25	23.48	23.42	23.58
		50	50	23.28	23.41	23.49
	16QAM	100	0	23.54	23.69	23.54
		1	0	23.42	23.60	23.59
		1	50	23.47	23.44	23.56
		1	99	23.48	23.54	23.45
		50	0	22.54	22.60	22.48
		50	25	22.50	22.50	22.46
		50	50	22.58	22.60	22.61
		100	0	22.53	22.46	22.49
Limit:		33				

Band/BW	Modulation	RB Size	RB Offset	Low CH 26697	Mid CH (26915)	High CH 27033
				Frequency (824.7) MHz	Frequency (836.5)MHz	Frequency (848.3) MHz
26/1.4	QPSK	1	0	24.78	24.87	24.91
		1	2	24.80	25.00	24.90
		1	5	24.78	25.00	24.85
		3	0	24.89	25.00	24.75
		3	1	24.79	24.86	24.87
		3	3	24.77	24.74	24.90
	16QAM	6	0	23.92	24.00	23.94
		1	0	23.86	23.97	23.91
		1	2	23.72	24.03	23.70
		1	5	23.83	23.81	23.83
		3	0	23.90	24.06	23.73
		3	1	23.74	23.89	23.82
		3	3	23.90	23.91	23.83
		6	0	22.77	22.92	22.87
Limit:		38.4				

Band/BW	Modulation	RB Size	RB Offset	Low CH (26805)	Mid CH (26915)	High CH (27025)
				Frequency (825.5)MHz	Frequency (836.5)MHz	Frequency (847.5)MHz
(26)/3	QPSK	1	0	24.71	24.94	24.85
		1	7	24.93	24.85	24.81
		1	14	24.91	24.98	24.81
		8	0	23.84	24.05	23.96
		8	3	23.85	24.03	23.85
		8	7	23.85	23.96	23.81
		15	0	23.85	23.96	23.87
	16QAM	1	0	23.96	23.91	23.81
		1	7	23.87	23.90	23.93
		1	14	23.91	23.97	23.97
		8	0	22.93	23.08	23.08
		8	3	22.97	23.13	22.90
		8	7	22.75	22.90	22.92
		15	0	22.80	22.90	22.87
Limit:		38.4				

Band/BW	Modulation	RB Size	RB Offset	Low CH (26815)	Mid CH (26915)	High CH (27015)
				Frequency (826.5)MHz	Frequency (836.5)MHz	Frequency (846.5)MHz
(26)/5	QPSK	1	0	24.93	25.00	24.95
		1	12	24.87	25.00	24.76
		1	24	24.79	24.89	24.94
		12	0	23.89	24.01	23.88
		12	6	24.02	23.95	23.85
		12	13	23.86	23.88	23.82
	16QAM	25	0	23.93	24.10	24.06
		1	0	23.92	24.07	23.84
		1	12	23.90	23.95	23.85
		1	24	23.89	24.04	23.98
		12	0	23.00	22.95	23.00
		12	6	22.98	23.07	22.92
		12	13	22.80	22.89	22.89
		25	0	22.89	23.01	22.91
Limit:		38.4				

Band/BW	Modulation	RB Size	RB Offset	Low CH (26840)	Mid CH (26915)	High CH (26990)
				Frequency (829)MHz	Frequency (836.5)MHz	Frequency (844)MHz
(26)/10	QPSK	1	0	24.82	25.00	24.93
		1	24	24.78	24.85	24.94
		1	49	24.93	24.98	24.87
		25	0	24.04	24.09	23.91
		25	12	24.01	23.97	23.96
		25	25	23.97	24.07	23.90
		50	0	23.91	24.04	23.88
	16QAM	1	0	24.00	23.95	23.99
		1	24	23.80	24.06	23.94
		1	49	23.85	24.03	23.97
		25	0	22.92	22.95	22.94
		25	12	23.05	22.91	22.97
		25	25	22.99	22.88	22.91
		50	0	23.02	23.09	23.04
Limit:		38.4				

Band/BW	Modulation	RB Size	RB Offset	Low CH (26865)	Mid CH (26915)	High CH (26965)
				Frequency (831.5)MHz	Frequency (836.5)MHz	Frequency (841.5)MHz
(26)/15	QPSK	1	0	24.96	24.95	24.95
		1	37	24.92	24.91	24.92
		1	74	24.78	25.01	24.91
		36	0	24.05	24.15	24.12
		36	19	23.97	24.01	23.88
		36	39	23.90	23.95	23.89
		75	0	23.94	24.08	23.92
	16QAM	1	0	24.00	24.04	23.99
		1	37	23.94	23.98	24.02
		1	74	24.00	24.11	23.98
		36	0	23.08	22.98	23.13
		36	19	22.98	23.06	22.87
		36	39	23.03	23.01	23.06
		75	0	23.05	23.02	23.05
Limit:		38.4				

Band/BW	Modulation	RB Size	RB Offset	Low CH 27685	Mid CH 27710	High CH 27735
				2307.5 MHz	2310.0 MHz	2312.5 MHz
30 / 5	QPSK	1	0	23.47	23.46	23.29
		1	12	23.35	23.47	23.49
		1	24	23.41	23.45	23.31
		12	0	22.54	22.54	22.57
		12	6	22.53	22.39	22.37
		12	13	22.39	22.33	22.41
		25	0	22.41	22.64	22.43
	16QAM	1	0	22.46	22.38	22.30
		1	12	22.29	22.51	22.28
		1	24	22.48	22.31	22.36
		12	0	21.54	21.58	21.33
		12	6	21.42	21.52	21.54
		12	13	21.45	21.59	21.40
		25	0	21.27	21.47	21.56
Limit:		/				

Band/BW	Modulation	RB Size	RB Offset	CH	Mid CH	CH
				MHz	27710 2310.0 MHz	MHz
30 / 10	QPSK	1	0	/	23.49	/
		1	24	/	23.30	/
		1	49	/	23.28	/
		25	0	/	22.45	/
		25	12	/	22.30	/
		25	25	/	22.21	/
	16QAM	50	0	/	22.34	/
		1	0	/	22.40	/
		1	24	/	22.44	/
		1	49	/	22.37	/
		25	0	/	21.37	/
		25	12	/	21.53	/
		25	25	/	21.30	/
		50	0	/	21.35	/
Limit:		/				

Band/BW	Modulation	RB Size	RB Offset	Low CH	Mid CH	High CH
				(39675) Frequency (2498.5)MHz	(40620) Frequency (2593)MHz	(41565) Frequency (2687.5)MHz
(41)/5	QPSK	1	0	23.87	24.05	24.07
		1	12	23.93	24.03	24.11
		1	24	24.00	23.97	24.10
		12	0	22.95	23.10	23.15
		12	6	23.01	22.99	22.94
		12	13	22.84	22.79	23.00
		25	0	23.07	22.86	22.90
	16QAM	1	0	23.06	22.84	23.11
		1	12	22.97	23.03	22.87
		1	24	22.78	22.84	22.94
		12	0	21.85	22.05	21.96
		12	6	22.03	21.93	22.20
		12	13	21.93	21.96	22.11
		25	0	22.05	21.89	22.14
		Limit:		33		

Band/BW	Modulation	RB Size	RB Offset	Low CH (39700)	Mid CH (40620)	High CH (41540)
				Frequency (2501)MHz	Frequency (2593)MHz	Frequency (2685)MHz
(41)/10	QPSK	1	0	23.85	23.99	24.02
		1	24	23.93	24.02	24.02
		1	49	23.98	23.91	24.01
		25	0	22.93	23.07	23.12
		25	12	22.97	22.96	22.88
		25	25	22.75	22.79	22.92
	16QAM	50	0	23.03	22.82	22.89
		1	0	23.06	22.79	23.07
		1	24	22.88	22.96	22.84
		1	49	22.70	22.76	22.89
		25	0	21.76	21.96	21.96
		25	12	22.03	21.84	22.19
		25	25	21.83	21.92	22.09
		50	0	22.03	21.88	22.05
Limit:		33				

Band/BW	Modulation	RB Size	RB Offset	Low CH (39725)	Mid CH (40620)	High CH (41515)
				Frequency (2503.5)MHz	Frequency (2593)MHz	Frequency (2682.5)MHz
(41)/15	QPSK	1	0	24.08	23.90	23.95
		1	37	23.94	24.10	23.93
		1	74	23.96	23.98	23.86
		36	0	22.96	23.01	23.13
		36	19	22.81	23.12	23.10
		36	39	22.91	22.97	23.09
		75	0	23.07	23.10	23.11
	16QAM	1	0	22.86	23.01	23.02
		1	37	22.77	22.84	23.12
		1	74	23.00	22.87	22.93
		36	0	22.04	22.08	22.07
		36	19	22.09	22.04	22.15
		36	39	21.78	22.10	22.06
		75	0	22.06	21.93	21.87
Limit:		33				

Band/BW	Modulation	RB Size	RB Offset	Low CH (39750)	Mid CH (40620)	High CH (41490)
				Frequency (2506)MHz	Frequency (2593)MHz	Frequency (2680)MHz
(41)/20	QPSK	1	0	24.11	23.94	24.11
		1	50	24.08	24.10	24.05
		1	99	24.16	24.20	24.02
		50	0	23.03	23.14	23.19
		50	25	22.97	23.15	23.12
		50	50	23.08	23.10	23.24
	16QAM	100	0	23.16	23.27	23.18
		1	0	23.12	23.12	23.12
		1	50	23.07	23.03	23.07
		1	99	23.11	23.26	22.97
		50	0	22.13	22.20	22.34
		50	25	22.30	22.06	22.39
		50	50	22.13	22.09	22.04
		100	0	22.18	22.01	22.25
Limit:		33				

APPENDIX C: TEST DATA FOR OCCUPIED BANDWIDTH

Operation Mode	Band Width	Channel Number	Channel Frequency (MHz)	QPSK		16QAM	
				Occupied Bandwidth (KHz)	Emission Bandwidth (KHz)	Occupied Bandwidth (KHz)	Emission Bandwidth (KHz)
LTE BAND2	1.4MHz	18900	1880	1090.9	1237.8	1084.9	1204.8
	3MHz	18900	1880	2703.3	2975.0	2709.3	2969.0
	5MHz	18900	1880	4505	4977	4525	4977
	10MHz	18900	1880	9071	9970	9031	9950
	15MHz	18900	1880	13516	14665	13457	14605
	20MHz	18900	1880	18541	20509	18541	20430
LTE BAND4	1.4MHz	20175	1732.5	1090.9	1251.2	1090.9	1233.3
	3MHz	20175	1732.5	2703.2	2980.5	2703.3	3022.5
	5MHz	20175	1732.5	4515	4905	4496	4955
	10MHz	20175	1732.5	9051	9950	9051	9990
	15MHz	20175	1732.5	13487	14595	13516	14745
	20MHz	20175	1732.5	18462	20549	18581	20749
LTE BAND5	1.4MHz	20525	836.5	1090.9	1246.8	1093.9	1237.8
	3MHz	20525	836.5	2709.3	2949.1	2691.3	2973.0
	5MHz	20525	836.5	4505	4957	4496	4917
	10MHz	20525	836.5	9051	10002	9051	9982
LTE BAND7	5MHz	21100	2535	4515	4985	4525	4945
	10MHz	21100	2535	9051	10110	9051	10010
	15MHz	21100	2535	13516	14815	13516	14725
	20MHz	21100	2535	18501	20420	18541	20579
LTE BAND12	1.4MHz	23095	707.5	1096.9	1246.8	1099.9	1249.8
	3MHz	23095	707.5	2703.3	2991.0	2697.3	2973.0
	5MHz	23095	707.5	4525	4941	4505	4941
	10MHz	23095	707.5	9051	9962	8991	9962
LTE BAND13	5MHz	23230	782.0	4486	4905	4486	4855
	10MHz	23230	782.0	9011	9910	9031	10010
LTE BAND25	1.4MHz	26365	1882.5	1087.9	1237.8	1093.9	1240.8
	3MHz	26365	1882.5	2703.3	3026.9	2709.3	3008.9
	5MHz	26365	1882.5	4505	4907	4505	4936
	10MHz	26365	1882.5	9091	10150	9051	9970
	15MHz	26365	1882.5	13516	14885	13487	14735
	20MHz	26365	1882.5	18501	20440	18581	20519
LTE BAND26	1.4MHz	26915	836.5	1093.9	1243.8	1096.9	1243.8
	3MHz	26915	836.5	2691.3	2988.0	2685.3	2928.1
	5MHz	26915	836.5	4506	4906	4496	4966
	10MHz	26915	836.5	9051	10007	9071	9947
	15MHz	26915	836.5	13457	14802	13457	14712
LTE BAND30	5MHz	27710	2310	4505	4925	4515	4975
	10MHz	27710	2310	9071	10040	9091	10020
LTE BAND41	5MHz	40620	2593	4486	4935	4496	4885
	10MHz	40620	2593	9091	10819	9056	10280
	15MHz	40620	2593	13516	15974	13546	15704
	20MHz	40620	2593	18501	22118	18541	22837

Test plots as follow:

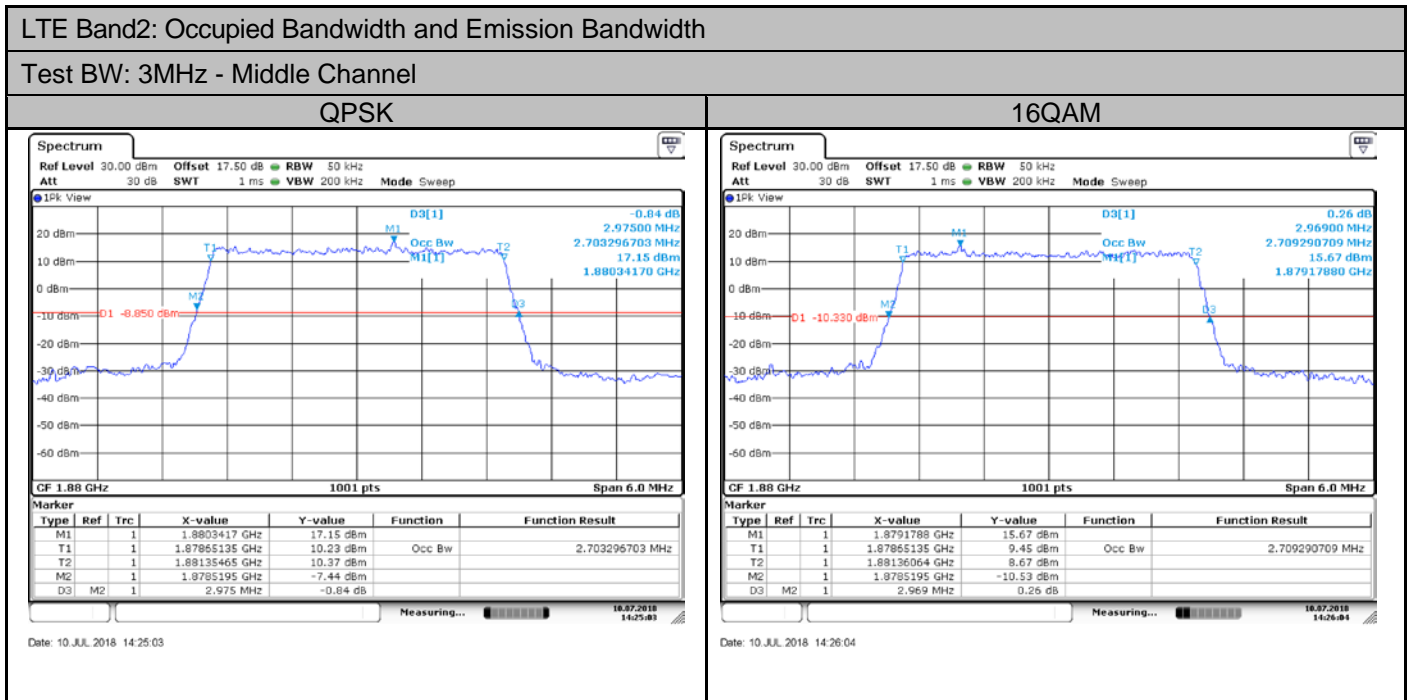
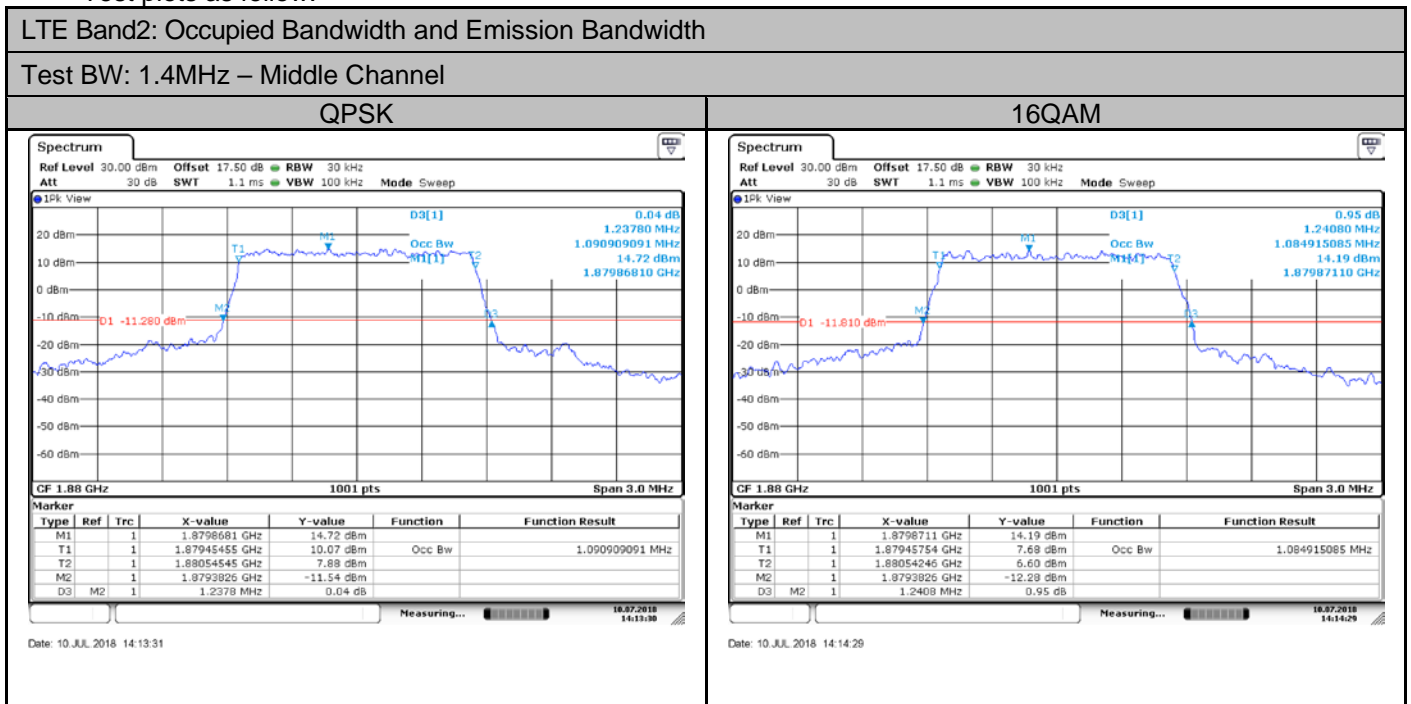

LTE Band2: Occupied Bandwidth and Emission Bandwidth

Test BW: 5MHz - Middle Channel

QPSK

16QAM

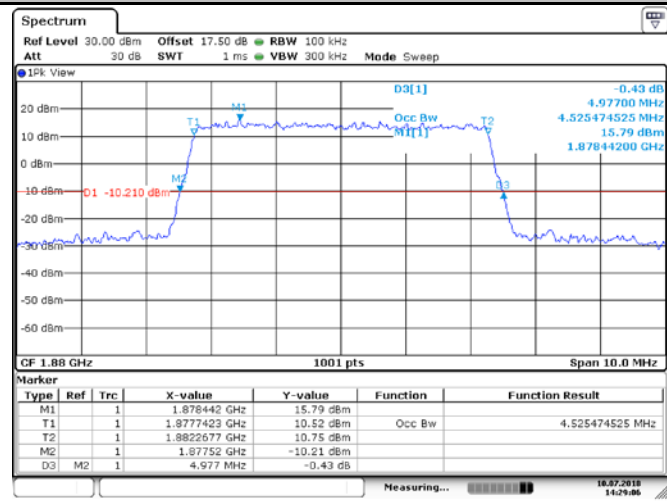
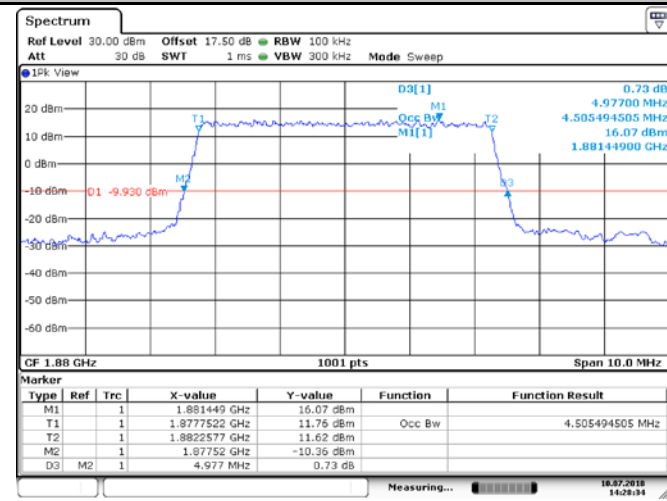

Date: 10 JUL 2018 14:28:34

Date: 10 JUL 2018 14:29:06

LTE Band2: Occupied Bandwidth and Emission Bandwidth

Test BW: 10MHz - Middle Channel

QPSK

16QAM

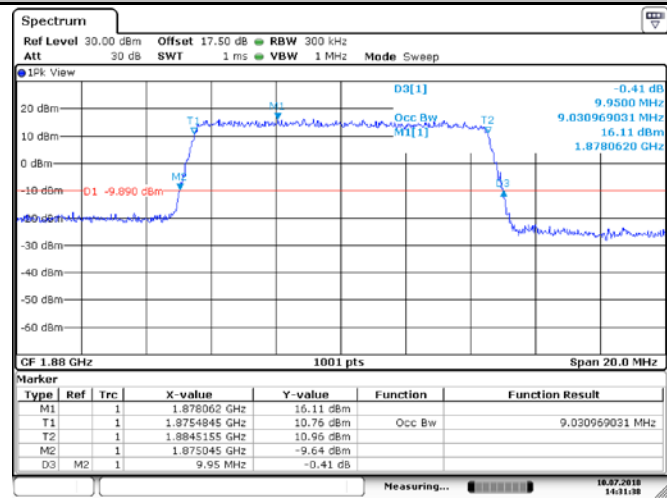
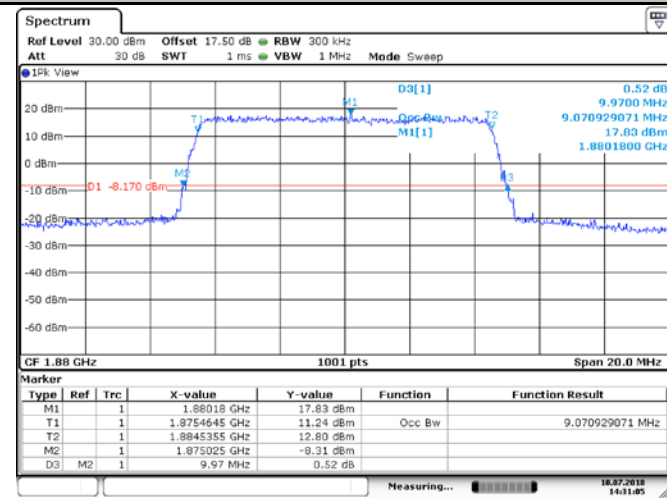

Date: 10 JUL 2018 14:31:05

Date: 10 JUL 2018 14:31:38

LTE Band2: Occupied Bandwidth and Emission Bandwidth

Test BW: 15MHz - Middle Channel

QPSK

16QAM

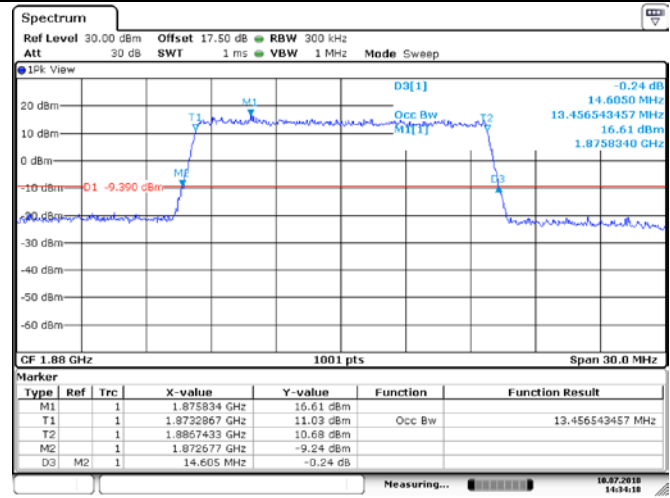
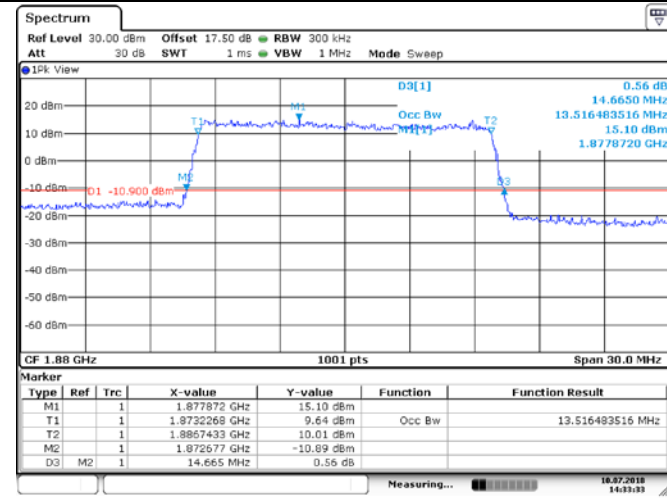

Date: 10 JUL 2018 14:33:33

Date: 10 JUL 2018 14:34:17

LTE Band2: Occupied Bandwidth and Emission Bandwidth

Test BW: 20MHz - Middle Channel

QPSK

16QAM

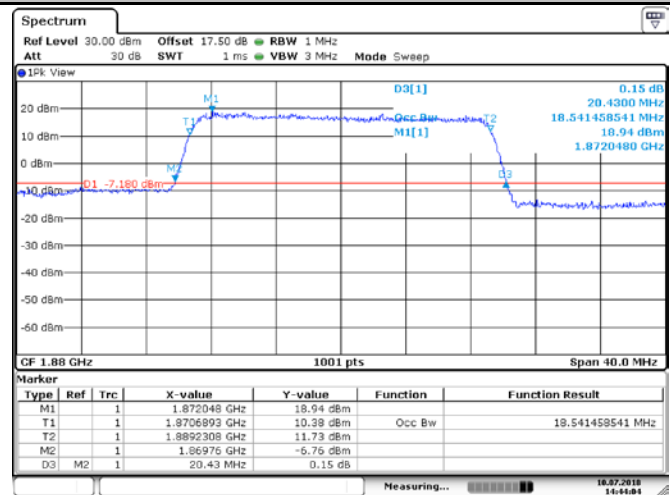
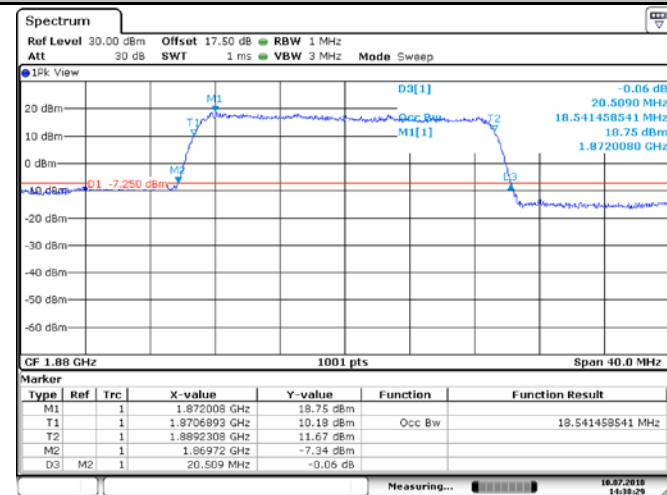

Date: 10 JUL 2018 14:38:29

Date: 10 JUL 2018 14:44:03

LTE Band4: Occupied Bandwidth and Emission Bandwidth

Test BW: 1.4MHz – Middle Channel

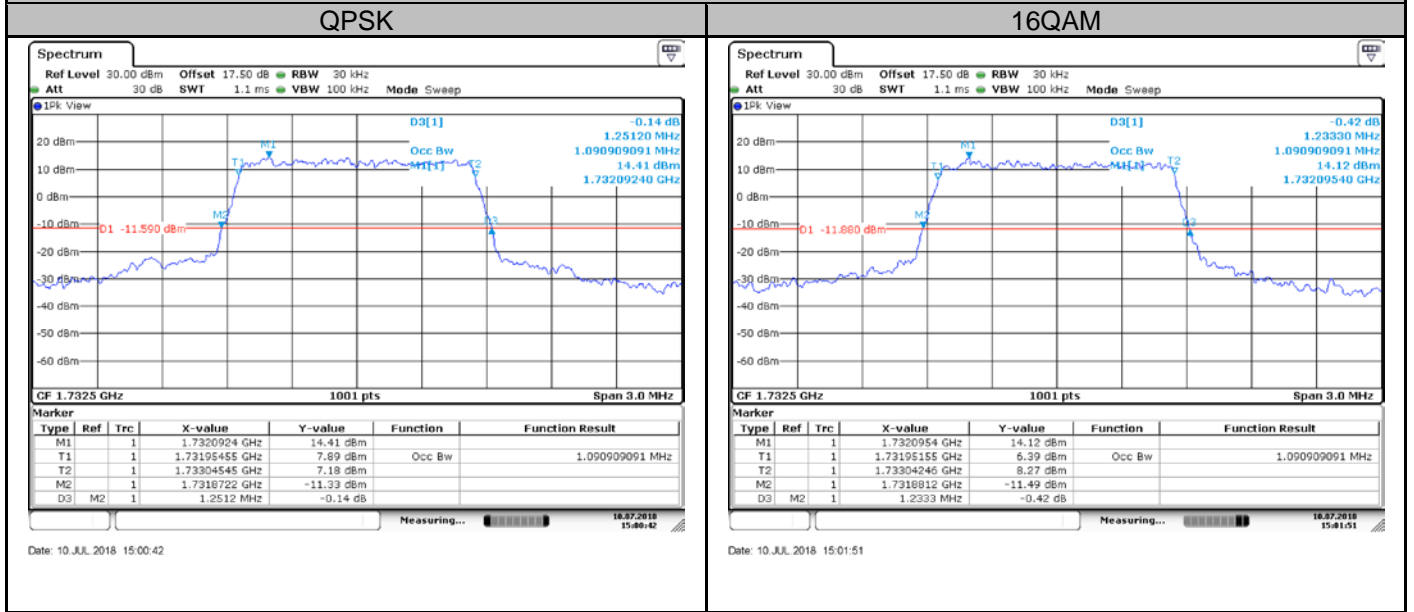

LTE Band4: Occupied Bandwidth and Emission Bandwidth

Test BW: 3MHz - Middle Channel

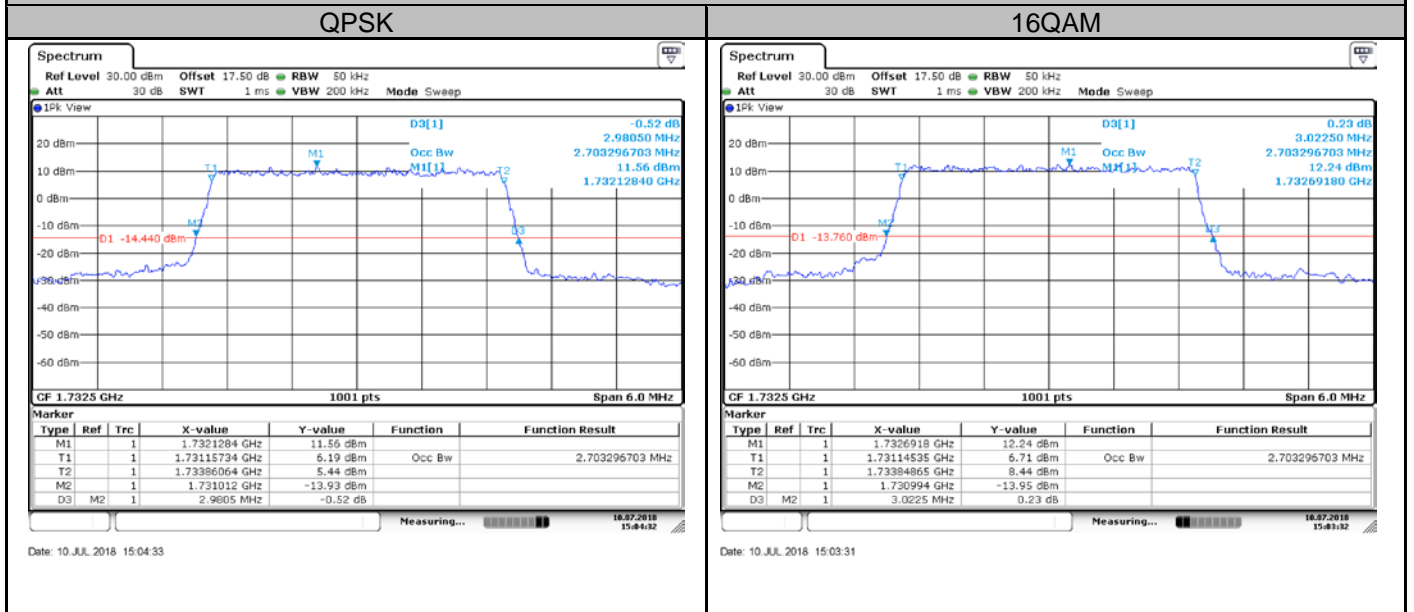

LTE Band4: Occupied Bandwidth and Emission Bandwidth

Test BW: 5MHz - Middle Channel

QPSK

16QAM

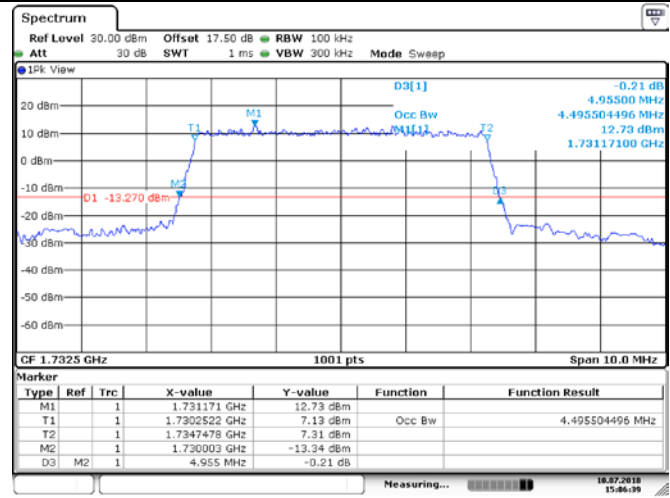
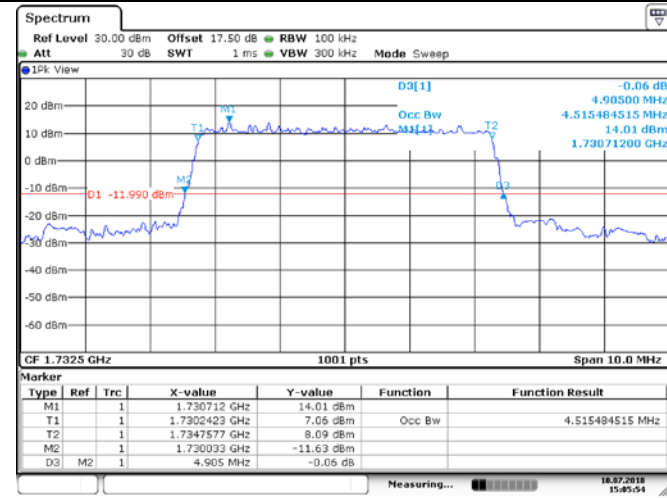

LTE Band4: Occupied Bandwidth and Emission Bandwidth

Test BW: 10MHz - Middle Channel

QPSK

16QAM

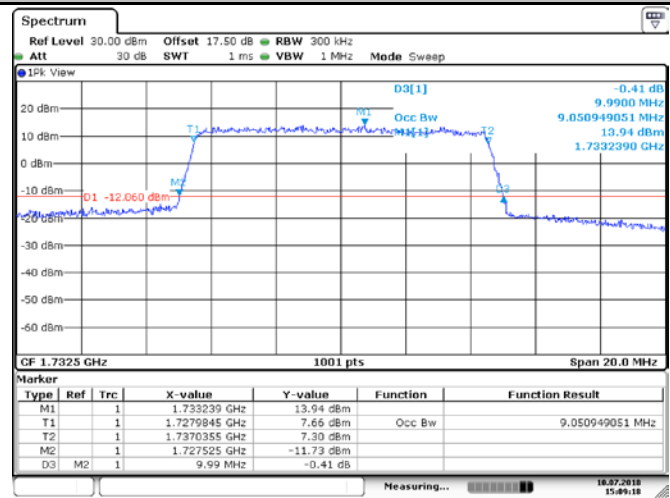
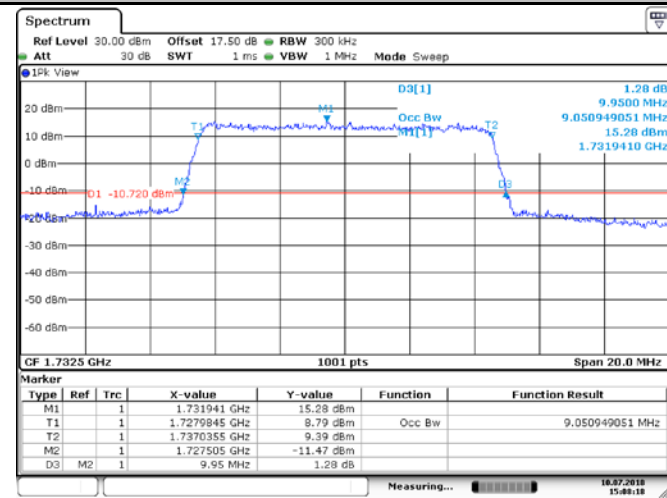

LTE Band4: Occupied Bandwidth and Emission Bandwidth

Test BW: 15MHz - Middle Channel

QPSK

16QAM

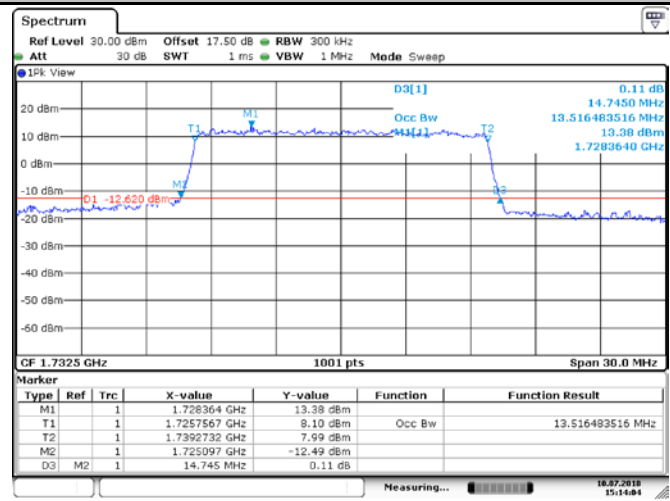
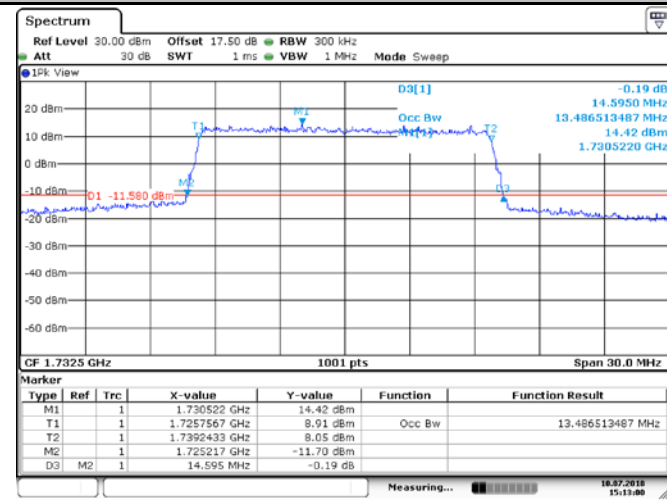

Date: 10 JUL 2018 15:12:59

Date: 10 JUL 2018 15:14:05

LTE Band4: Occupied Bandwidth and Emission Bandwidth

Test BW: 20MHz - Middle Channel

QPSK

16QAM

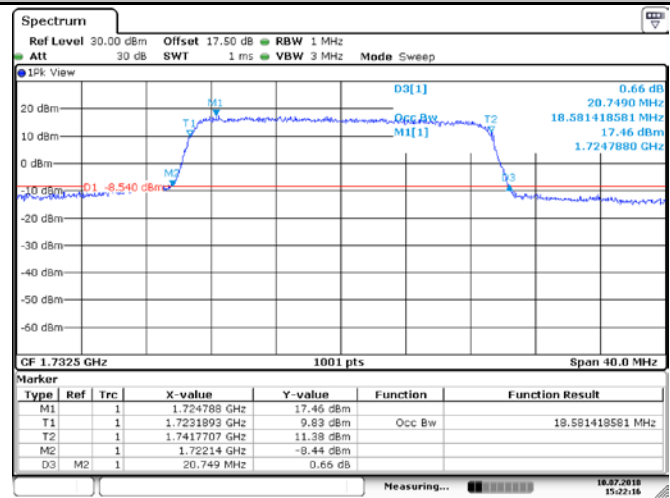
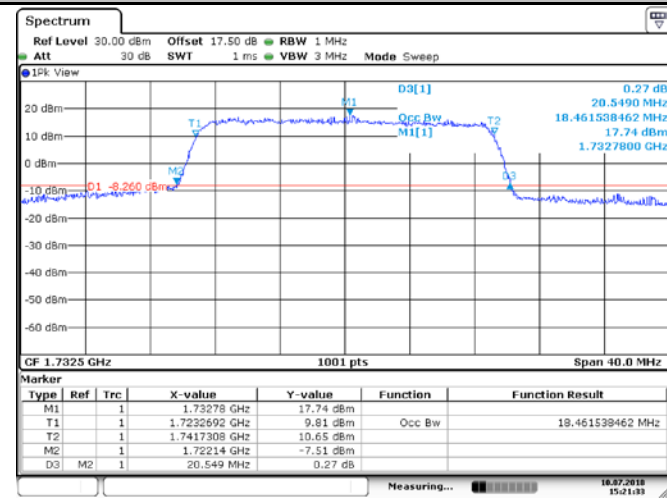

Date: 10 JUL 2018 15:21:33

Date: 10 JUL 2018 15:22:16

LTE Band5: Occupied Bandwidth and Emission Bandwidth

Test BW: 1.4MHz – Middle Channel

QPSK

16QAM

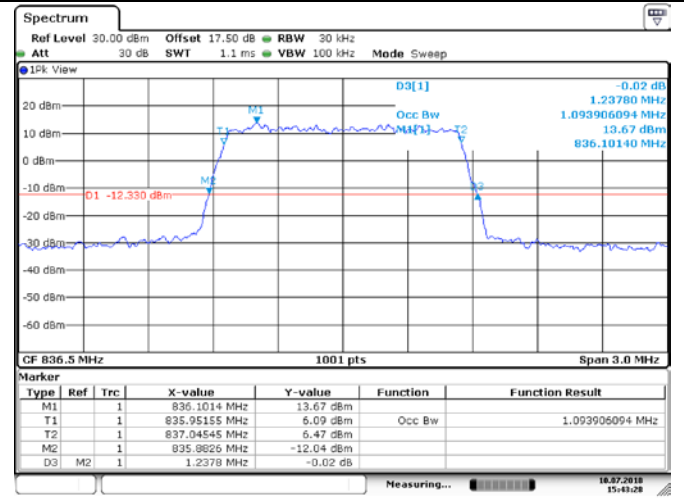
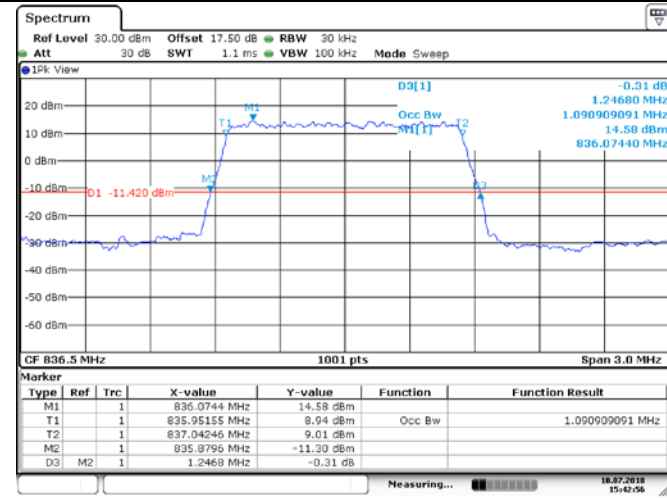

Date: 10 JUL 2018 15:42:56

Date: 10 JUL 2018 15:43:28

LTE Band5: Occupied Bandwidth and Emission Bandwidth

Test BW: 3MHz - Middle Channel

QPSK

16QAM

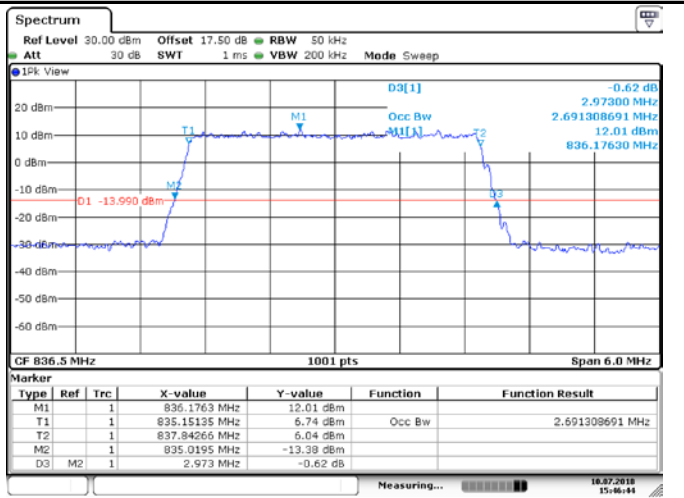
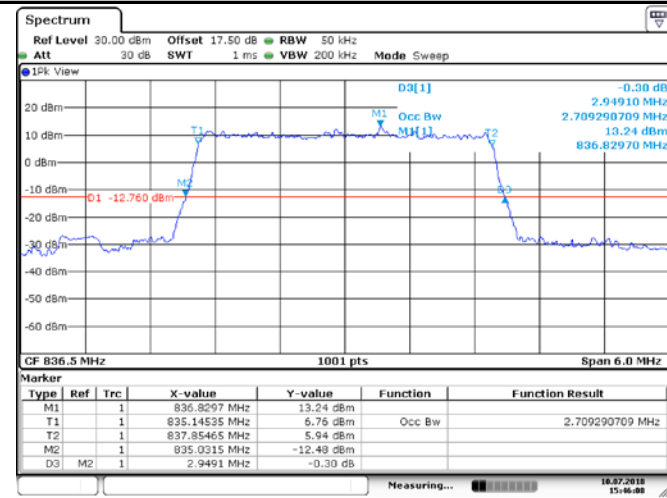

Date: 10 JUL 2018 15:46:08

Date: 10 JUL 2018 15:46:44