

## 4.6 BAND EDGES MEASUREMENT

### 4.6.1 LIMITS OF BAND EDGES MEASUREMENT

Below -20dB of the highest emission level of operating band (in 100KHz RB).

### 4.6.2 TEST INSTRUMENTS

Description & Manufacturer	Model No.	Serial No.	Calibrated Until
ROHDE & SCHWARZ TEST RECEIVER	ESMI	848926/005 846839/018	Dec 03, 2001
HP ATTENUATOR	8496B	3247A18505	Cal. on use
HP PLOTTER	7475A	2641V27755	N/A

Notes:

- 1.The measurement uncertainty is less than +/- 2.6dB, which is calculated as per the NAMAS document NIS81.
- 2.The calibration interval of the above test instruments is 12 months. And the calibrations are traceable to NML/ROC and NIST/USA.

### 4.6.3 TEST PROCEDURE

The transmitter output was connected to the spectrum analyzer via a low lose cable. Set both RBW and VBW of spectrum analyzer to 100 kHz with suitable frequency span including 100 kHz bandwidth from band edge. The band edges was measured and recorded.



#### 4.6.4 EUT OPERATING CONDITION

The software provided by client enabled the EUT to transmit and receive data at lowest, middle and highest channel frequencies individually.

#### 4.6.5 TEST RESULTS

The spectrum plots are attached below. D2 line indicates the highest level, D1 line indicates the 20dB offset below D2. It shows compliance with the requirement in part 15.247(C).



#### 4.6.6 NOTE ON BAND EDGE EMISSION

The band edge emission plot on page 44 shows 49.77dB delta between carrier maximum power and local maximum emission in restrict band (2.4835GHz). The emission of carrier strength list in table of page 24 is 101.7dB  $\mu$  V/m, so the maximum field strength in restrict band is  $101.7-49.77=51.93$  dB  $\mu$  V/m which is under 54 dB  $\mu$  V/m limit.

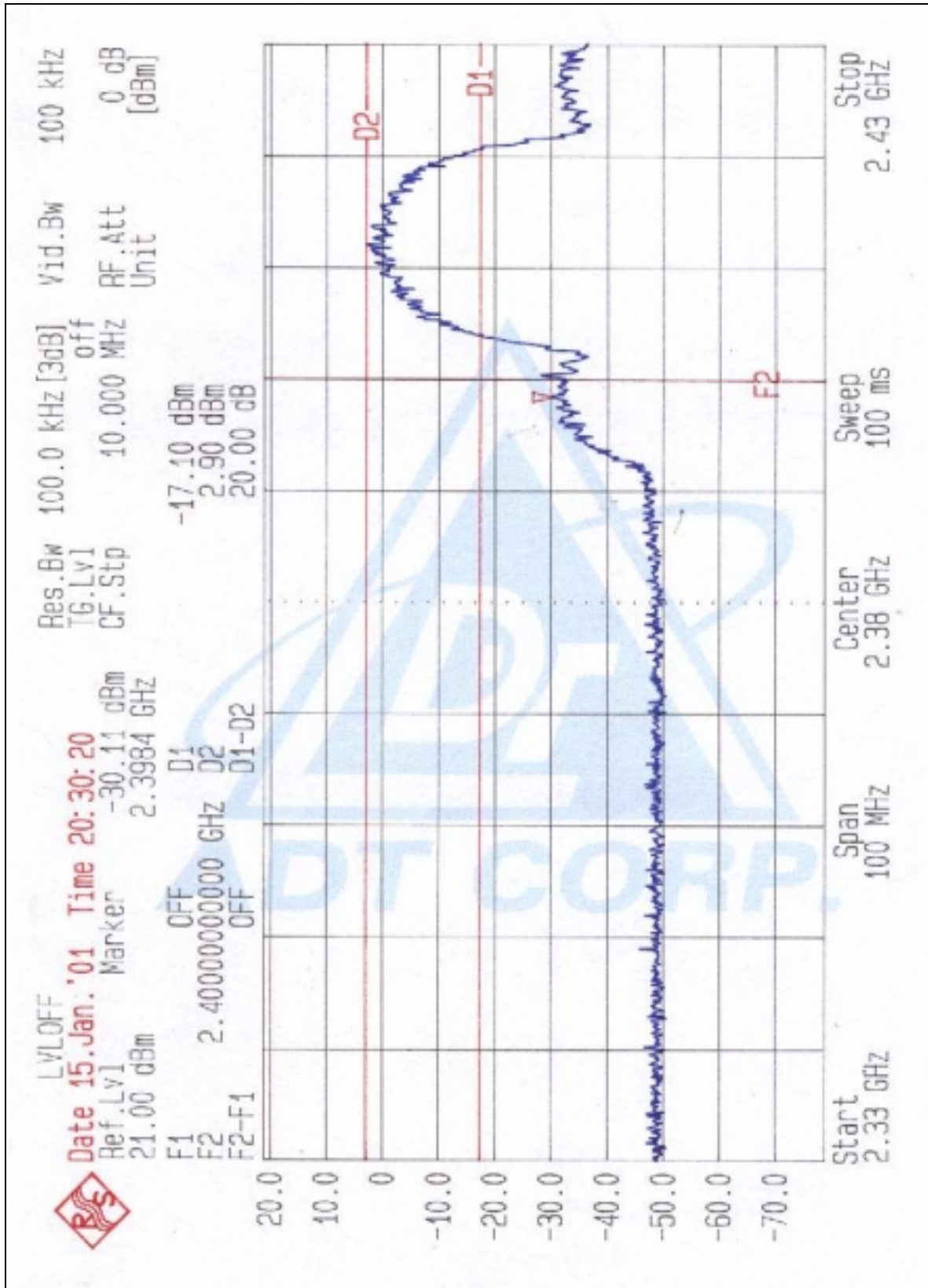

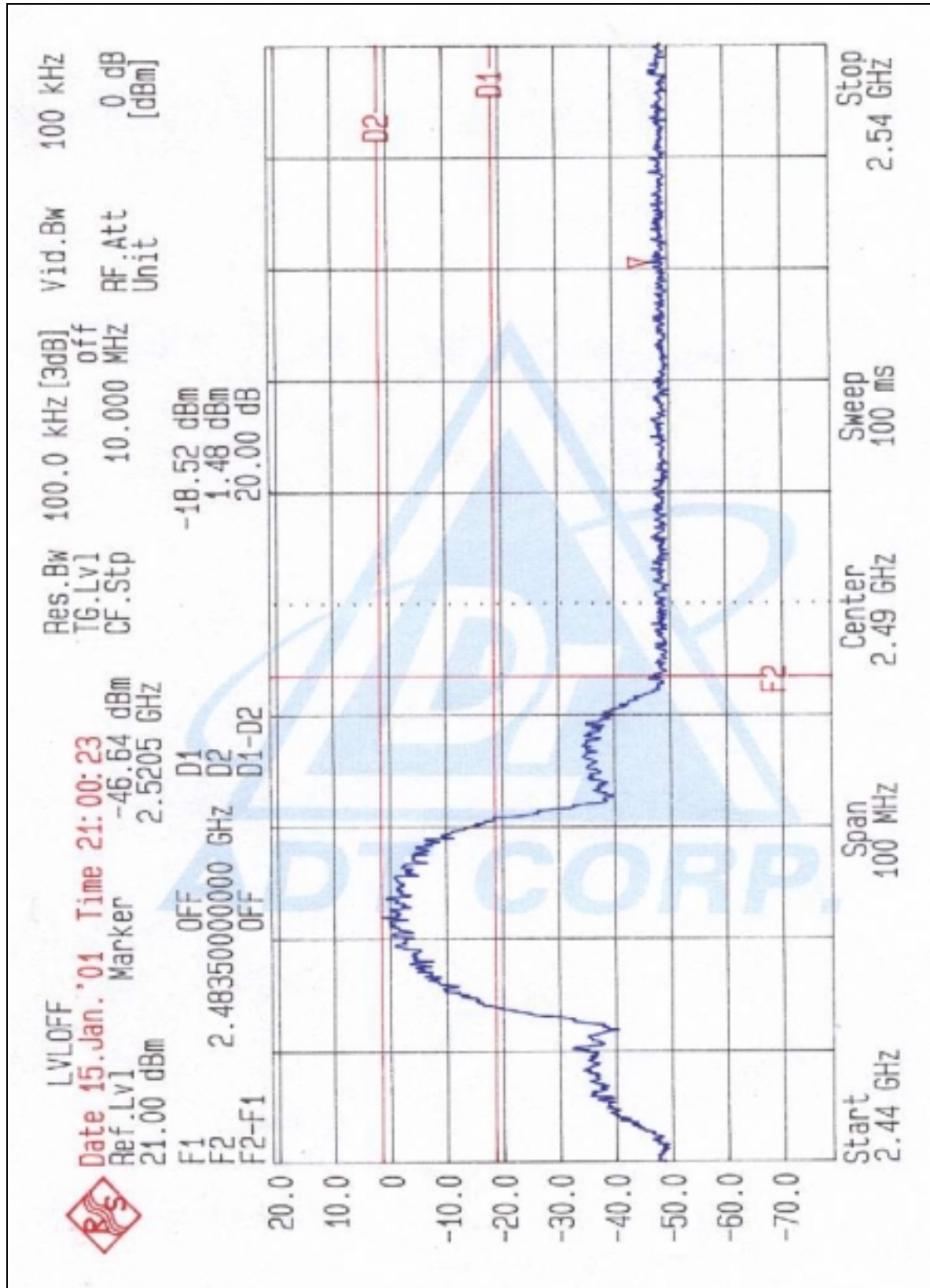

#### 4.7 PROCESSING GAIN OF A DIRECT SEQUENCE SPREAD SPECTRUM MEASUREMENT(WORSE CASE)

##### 4.7.1 LIMITS OF PROCESSING GAIN OF A DIRECT SEQUENCE SPREAD SPECTRUM MEASUREMENT

The limit of processing gain is 10dB.

##### 4.7.2 TEST INSTRUMENTS & SUPPORT UNIT

Description & Manufacturer	Model No.	Serial No.
Hewlett Packard Spectrum Analyzer, 9kHz to 22GHz	HP8593E	S942848
Marconi Signal Generator, 10kHz to 2.7GHz	2031	953426
Hewlett Packard Power Meter,	HP438A	S952633
Hewlett Packard Power Sensor, -20 to -70dBm	HP8481D	SCD15369
Hewlett Packard Attenuator, 6dB to 10 dB	HP8493A	NA
Hewlett Packard Step Attenuator, 1dB steps	HP8494A	NA
Hewlett Packard Step Attenuator, 10dB steps	HP8495D	NA
Hewlett Packard Power Splitter,	HP11667B	04390
Cmpaq Laptop Computer (Qty 2),	Armada 1700	NA

### 4.7.3 METHOD OF MEASUREMENT

The processing gain may be measured using the CW jamming margin method. Figure 1 shows the test configuration. The test consists of stepping a signal generator in 50 kHz increments across the passband of the system. At each point, the generator level required to produce the recommended Bit Error Rate (BER) is recorded. This level is jammer level. The output power of the transmitting unit is measured at the same point. The jammer to Signal (J/S) ratio is then calculated. Discard the worst 20% of the J/S data points. The lowest remaining J/S ratio is used when calculating the Process Gain.

The reference PER is specified as 8%. The corresponding Es/No (signal to noise ratio per symbol) is 16.4 dB. The curve is attached as below.

#### 1.1 1000 byte PER vs. Es/No

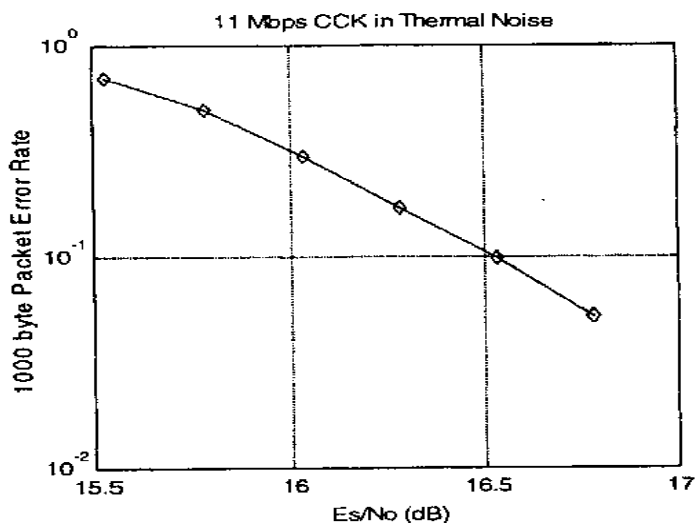

This value and the measured J/S ratio are used in the following equation to calculate the Process Gain (Gp) of the system.

$$G_p = (S/N)_o + M_j + L_{sys}$$

Where:

(S/N)<sub>o</sub>: Signal to noise ratio for the chosen BER.

M<sub>j</sub> : Maximum jammer to Signal Ratio recorded at the detected BER.

Lsys : System losses . For the purpose of this processing gain calculation, we assume Lsys at its minimum value of 2 dB.

Applicable Reference Documents.

“HFA3861A Direct Sequence Spread Spectrum Baseband Processor” Harris Corporation Semiconductor Sector Preliminary Data Sheet, Melbourne FL, July 1999.  
 “M-ary Orthogonal Keying BER Curve”.

4.7.4 TEST SETUP

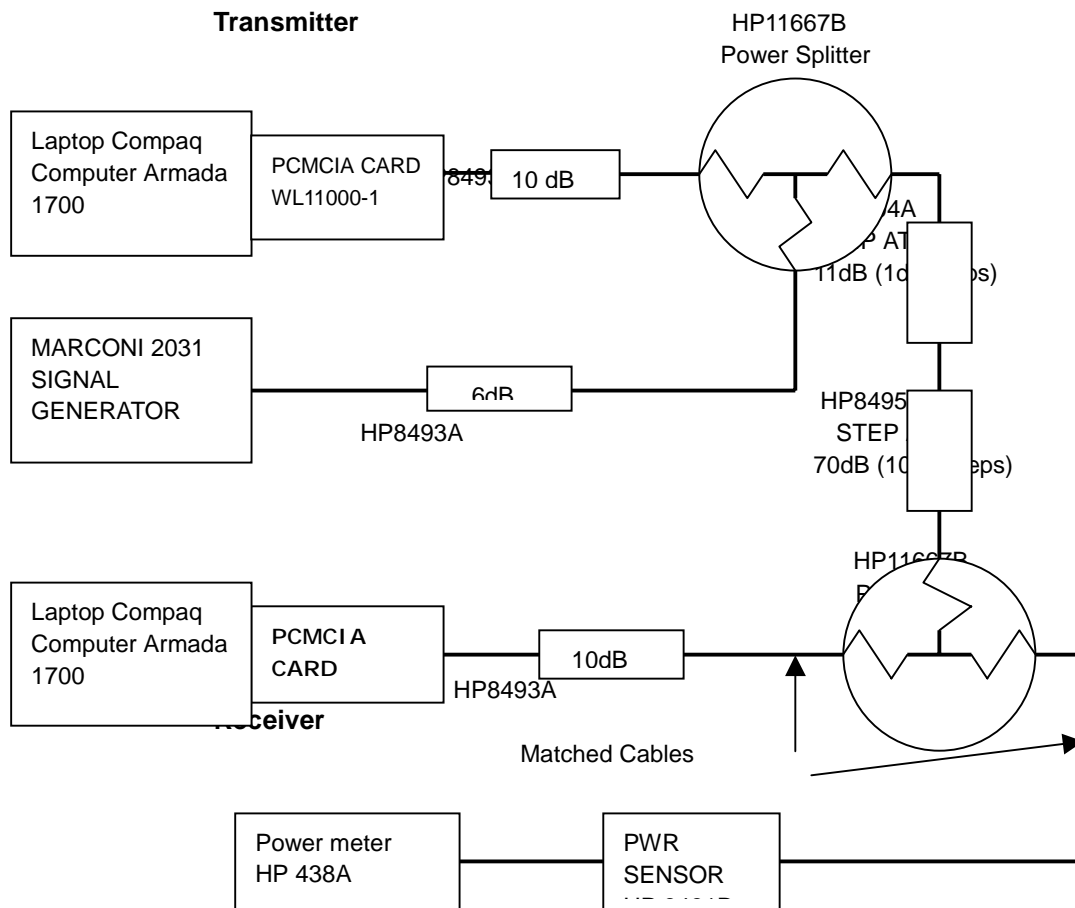

For the actual test configuration, please refer to the related Item – Photographs of the Test Configuration.





#### 4.7.5 TEST PROCEDURES

Obtain the simplex link shown. Perform all independent instrumentation calibrations prior to this procedure. Set operating power levels using fixed and variable attenuators in system to meet the following objectives:

Signal Power at receiver approximately  $-60\text{dBm}$  (above thermal sensitivity such that thermal noise does not cause bit errors).

Signal Power at power meter between  $-20$  and  $-30\text{dBm}$  for optimal linearity.

Use spectrum analyzer to monitor test.

Ensure that CW Jammer generator RF output is disabled and measure the power at the power meter port using the power meter. This is the relative signal power,  $S_r$ .

Disable Transmitter, and set CW Jammer generator RF output frequency equal to the carrier frequency and enable generator output. Set reference CW Jammer power level at power meter port  $8.4\text{dB}$  below  $S_r$  (minimum J/S, or  $10\text{dB}$  processing gain reference level). Note the power level setting on the generator, this is the reference CW Jammer power setting,  $J_r$ .

Disable CW Jammer, re-establish link. PER test should be operating essentially error -free.

Enable CW Jammer at the reference power level and verify that the PER test indicates a PER of less than 8%.

Alternatively, adjust the CW Jammer level to that which causes 8% PER and verify that the S/J is less than  $8.4\text{dB}$ .

Repeat step 7 for uniform steps in frequency increments of  $50\text{ kHz}$  across the receiver passband with the CW Jammer. In this case the receiver passband is  $\pm 8.5\text{ MHz}$ .

The numerical data associated with the following radio channel is tabulated and presented for :

Channel 1	: 2412 MHz
Channel 6	: 2437 MHz
Channel 11	: 2462 MHz

#### 4.7.6 EUT OPERATING CONDITION

The software provided by client to set the EUT to transmit at lowest, middle and highest channel.



4.7.7 TEST RESULTS

<b>EUT</b>	EtherFast Wireless AP + Cable/DSL Router with 4-Port Switch	<b>Model</b>	BEFW11S4
<b>Environmental Conditions</b>	20°C, 60%RH	<b>Tested By</b>	Steven Lu

Although the theoretical processing gain is lower than 10 dB, but the CCK coding provides an extra coding gain of 2.2dB.

11Mbps CHANNEL 1 Processing Gain						
Gp = (S/N) ° + Mj + Lsys						
Freq. (GHz)	Gp (dB)	(S/N) ° (dB)	Mj = J/S (dB)	Lsys (dB)	Jammer (dBm)	LVL (dBm)
2.4095	11.3	16.4	-7.1	2	-47.1	-0.7
2.40955	11.4	16.4	-7	2	-47	-0.6
2.4096	11.4	16.4	-7	2	-47	-0.6
2.40965	11.4	16.4	-7	2	-47	-0.6
2.4097	11.3	16.4	-7.1	2	-47.1	-0.7
2.40975	11.3	16.4	-7.1	2	-47.1	-0.7
2.4098	11.1	16.4	-7.3	2	-47.3	-0.9
2.40985	11.1	16.4	-7.3	2	-47.3	0.9
2.4099	11	16.4	-7.4	2	-47.4	-1
2.40995	11	16.4	-7.4	2	-47.4	-1
2.41	10.9	16.4	-7.5	2	-47.5	-1.1
2.41005	11	16.4	-7.4	2	-47.4	-1
2.4101	11	16.4	-7.4	2	-47.4	-1
2.41015	11.1	16.4	-7.3	2	-47.3	-0.9
2.4102	11.2	16.4	-7.2	2	-47.2	-0.8
2.41025	11.3	16.4	-7.1	2	-47.1	-0.7
2.4103	11.3	16.4	-7.1	2	-47.1	-0.7
2.41035	11.4	16.4	-7	2	-47	-0.6
2.4104	11.3	16.4	-7.1	2	-47.1	-0.7
2.41045	11.3	16.4	-7.1	2	-47.1	-0.7
2.4105	11.3	16.4	-7.1	2	-47.1	-0.7
2.41055	11.2	16.4	-7.2	2	-47.2	-0.8
2.4106	11.2	16.4	-7.2	2	-47.2	-0.8
2.41065	11.3	16.4	-7.1	2	-47.1	-0.7
2.4107	11.3	16.4	-7.1	2	-47.1	-0.7
2.41075	11.3	16.4	-7.1	2	-47.1	-0.7
2.4108	11.4	16.4	-7	2	-47	-0.6
2.41085	11.5	16.4	-6.9	2	-46.9	-0.5
2.4109	11.6	16.4	-6.8	2	-46.8	-0.4
2.41095	11.6	16.4	-6.8	2	-46.8	-0.4
2.411	11.6	16.4	-6.8	2	-46.8	-0.4
2.41105	11.4	16.4	-7	2	-47	-0.6
2.4111	11.5	16.4	-6.9	2	-46.9	-0.5
2.41115	11.6	16.4	-6.8	2	-46.8	-0.4



11Mbps CHANNEL 1 Processing Gain						
Gp = (S/N) ° + Mj + Lsys						
Freq. (GHz)	Gp (dB)	(S/N) ° (dB)	Mj = J/S (dB)	Lsys (dB)	Jammer (dBm)	LVL (dBm)
2.4112	11.5	16.4	-6.9	2	-46.9	-0.5
2.41125	11.5	16.4	-6.9	2	-46.9	-0.5
2.4113	11.5	16.4	-6.9	2	-46.9	-0.5
2.41135	11.4	16.4	-7	2	-47	-0.6
2.4114	11.4	16.4	-7	2	-47	-0.6
2.41145	11.4	16.4	-7	2	-47	-0.6
2.4115	11.4	16.4	-7	2	-47	-0.6
2.41155	11.4	16.4	-7	2	-47	-0.6
2.4116	11.6	16.4	-6.8	2	-46.8	-0.4
2.41165	11.6	16.4	-6.8	2	-46.8	-0.4
2.4117	11.5	16.4	-6.9	2	-46.9	-0.5
2.41175	11.4	16.4	-7	2	-47	-0.6
2.4118	11.2	16.4	-7.2	2	-47.2	-0.8
2.41185	11.1	16.4	-7.3	2	-47.3	-0.9
2.4119	11	16.4	-7.4	2	-47.4	-1
2.41195	10.8	16.4	-7.6	2	-47.6	-1.2
2.412	10.9	16.4	-7.5	2	-47.5	-1.1
2.41205	10.9	16.4	-7.5	2	-47.5	-1.1
2.4121	11.1	16.4	-7.3	2	-47.3	-0.9
2.41215	11.4	16.4	-7	2	-47	-0.6
2.4122	11.5	16.4	-6.9	2	-46.9	-0.5
2.41225	11.6	16.4	-6.8	2	-46.8	-0.4
2.4123	11.7	16.4	-6.7	2	-46.7	-0.3
2.41235	11.7	16.4	-6.7	2	-46.7	-0.3
2.4124	11.7	16.4	-6.7	2	-46.7	-0.3
2.41245	11.6	16.4	-6.8	2	-46.8	-0.4
2.4125	11.6	16.4	-6.8	2	-46.8	-0.4
2.41255	11.6	16.4	-6.8	2	-46.8	-0.4
2.4126	11.6	16.4	-6.8	2	-46.8	-0.4
2.41265	11.6	16.4	-6.8	2	-46.8	-0.4
2.4127	11.7	16.4	-6.7	2	-46.7	-0.3
2.41275	11.6	16.4	-6.8	2	-46.8	-0.4
2.4128	11.8	16.4	-6.6	2	-46.6	-0.2
2.41285	11.8	16.4	-6.6	2	-46.6	-0.2



11Mbps CHANNEL 1 Processing Gain						
Gp = (S/N) ° + Mj + Lsys						
Freq.	Gp	(S/N) °	Mj = J/S	Lsys	Jammer	LVL
(GHz)	(dB)	(dB)	(dB)	(dB)	(dBm)	(dBm)
2.4129	11.8	16.4	-6.6	2	-46.6	-0.2
2.41295	11.9	16.4	-6.5	2	-46.5	-0.1
2.413	11.8	16.4	-6.6	2	-46.6	-0.2
2.41305	11.8	16.4	-6.6	2	-46.6	-0.2
2.4131	11.8	16.4	-6.6	2	-46.6	-0.2
2.41315	11.7	16.4	-6.7	2	-46.7	-0.3
2.4132	11.6	16.4	-6.8	2	-46.8	-0.4
2.41325	11.7	16.4	-6.7	2	-46.7	-0.3
2.4133	11.6	16.4	-6.8	2	-46.8	-0.4
2.41335	11.6	16.4	-6.8	2	46.8	-0.4
2.4134	11.6	16.4	-6.8	2	-46.8	-0.4
2.41345	11.6	16.4	-6.8	2	-46.8	-0.4
2.4135	11.6	16.4	-6.8	2	-46.8	-0.4
2.41355	11.7	16.4	-6.8	2	-46.8	-0.4
2.4136	11.6	16.4	-6.7	2	-46.7	-0.3
2.41365	11.7	16.4	-6.7	2	-46.7	-0.3
2.4137	11.7	16.4	-6.7	2	-46.7	-0.3
2.41375	11.7	16.4	-6.7	2	-46.7	-0.3
2.4138	11.6	16.4	-6.8	2	-46.8	-0.4
2.41385	11.5	16.4	-6.9	2	-46.9	-0.5
2.4139	11.4	16.4	-7	2	-47	-0.6
2.41395	11.3	16.4	-7.1	2	-47.1	-0.7
2.414	11.2	16.4	-7.2	2	-47.2	-0.8
2.41405	11.2	16.4	-7.2	2	-47.2	-0.8
2.4141	11.2	16.4	-7.2	2	-47.2	-0.8
2.41415	11.2	16.4	-7.2	2	-47.2	-0.8
2.4142	11.3	16.4	-7.1	2	-47.1	-0.7
2.41425	11.4	16.4	-7	2	-47	-0.6
2.4143	11.5	16.4	-6.9	2	-46.9	-0.5
2.41435	11.5	16.4	-6.9	2	-46.9	-0.5
2.4144	11.5	16.4	-6.9	2	-46.9	-0.5
2.41445	11.5	16.4	-6.9	2	-46.9	-0.5
2.4145	11.4	16.4	-7	2	-47	-0.6
Processing Gain : 11.5 dB						

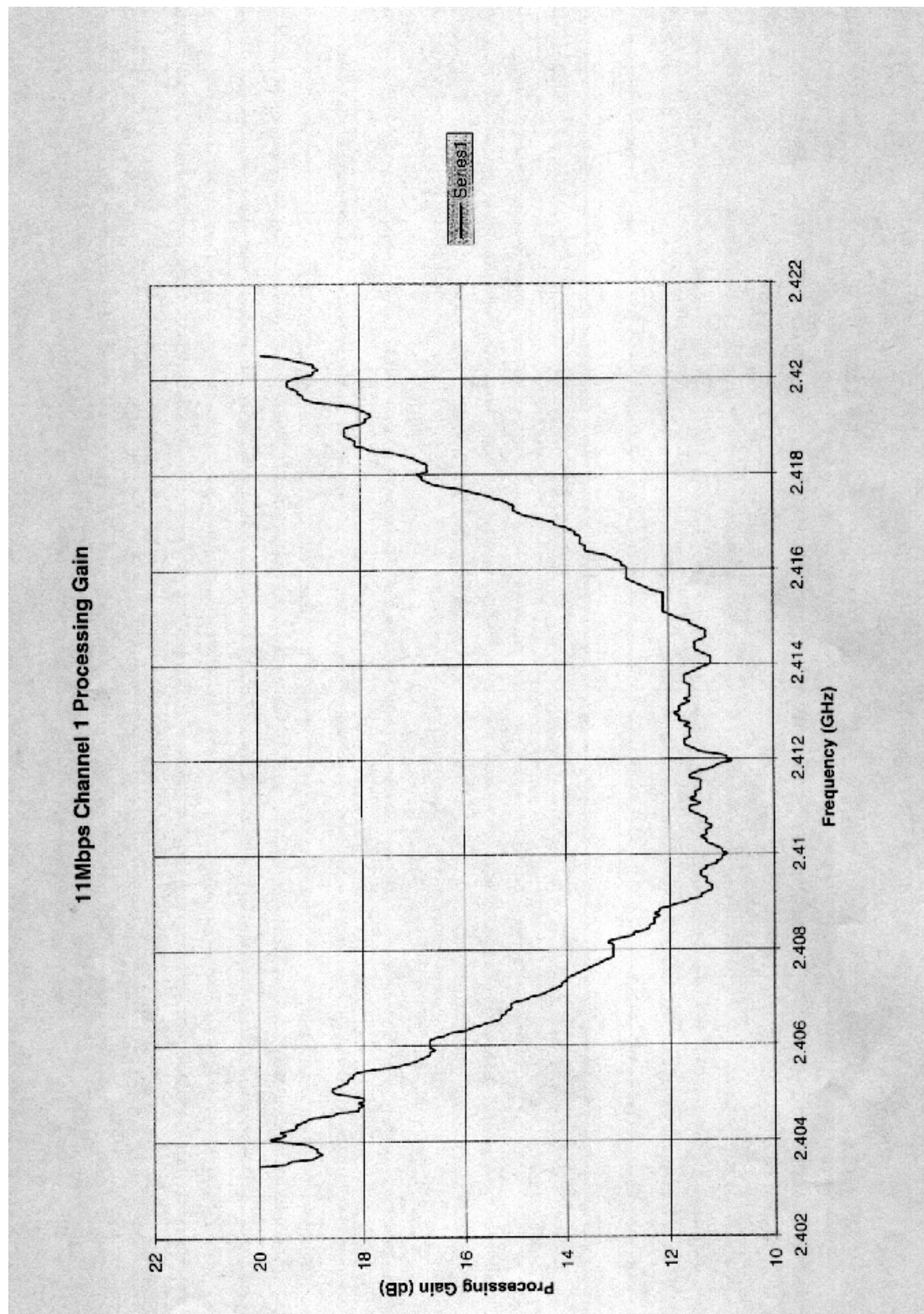



11Mbps CHANNEL 6 Processing Gain						
Gp = (S/N) ° + Mj + Lsys						
Freq. (GHz)	Gp (dB)	(S/N) ° (dB)	Mj = J/S (dB)	Lsys (dB)	Jammer (dBm)	LVL (dBm)
2.4345	11.2	16.4	-7.2	2	-47.2	-3.1
2.43455	11.2	16.4	-7.2	2	-47.2	-3.1
2.4346	11.2	16.4	-7.2	2	-47.2	-3.1
2.43465	11.3	16.4	-7.1	2	-47.1	-3
2.4347	11.3	16.4	-7.1	2	-47.1	-3
2.43475	11.2	16.4	-7.2	2	-47.2	-3.1
2.4348	11.1	16.4	-7.3	2	-47.3	-3.2
2.43485	11.1	16.4	-7.3	2	-47.3	-3.2
2.4349	11	16.4	-7.4	2	-47.4	-3.3
2.43495	11	16.4	-7.4	2	-47.4	-3.3
2.435	11	16.4	-7.4	2	-47.4	-3.3
2.43505	11.1	16.4	-7.3	2	-47.3	-3.2
2.4351	11.1	16.4	-7.3	2	-47.3	-3.2
2.43515	11.2	16.4	-7.2	2	-47.2	-3.1
2.4352	11.3	16.4	-7.1	2	-47.1	-3
2.43525	11.3	16.4	-7.1	2	-47.1	-3
2.4353	11.4	16.4	-7	2	-47	-2.9
2.43535	11.4	16.4	-7	2	-47	-2.9
2.4354	11.3	16.4	-7.1	2	-47.1	-3
2.43545	11.3	16.4	-7.1	2	-47.1	-3
2.4355	11.2	16.4	-7.2	2	-47.2	-3.1
2.43555	11.2	16.4	-7.2	2	-47.2	-3.1
2.4356	11.2	16.4	-7.2	2	-47.2	-3.1
2.43565	11.2	16.4	-7.2	2	-47.2	-3.1
2.4357	11.2	16.4	-7.2	2	-47.2	-3.1
2.43575	11.3	16.4	-7.1	2	-47.1	-3
2.4358	11.4	16.4	-7	2	-47	-2.9
2.43585	11.5	16.4	-6.9	2	-46.9	-2.8
2.4359	11.5	16.4	-6.9	2	-46.9	-2.8
2.43595	11.5	16.4	-6.9	2	-46.9	-2.8
2.436	11.5	16.4	-6.9	2	-46.9	-2.8
2.43605	11.4	16.4	-7	2	-47	-2.9
2.4361	11.5	16.4	-6.9	2	-46.9	-2.8
2.43615	11.5	16.4	-6.9	2	-46.9	-2.8



11Mbps CHANNEL 6 Processing Gain						
Gp = (S/N) ° + Mj + Lsys						
Freq.	Gp	(S/N) °	Mj = J/S	Lsys	Jammer	LVL
(GHz)	(dB)	(dB)	(dB)	(dB)	(dBm)	(dBm)
2.4362	11.5	16.4	-6.9	2	-46.9	-2.8
2.43625	11.5	16.4	-6.9	2	-46.9	-2.8
2.4363	11.5	16.4	-6.9	2	-46.9	-2.8
2.43635	11.4	16.4	-7	2	-47	-2.9
2.4364	11.4	16.4	-7	2	-47	-2.9
2.43645	11.4	16.4	-7	2	-47	-2.9
2.4365	11.4	16.4	-7	2	-47	-2.9
2.43655	11.4	16.4	-7	2	-47	-2.9
2.4366	11.4	16.4	-7	2	-47	-2.9
2.43665	11.5	16.4	-6.9	2	-46.9	-2.8
2.4367	11.5	16.4	-6.9	2	-46.9	-2.8
2.43675	11.4	16.4	-7	2	-47	-2.9
2.4368	11.3	16.4	-7.1	2	-47.1	-3
2.43685	11.1	16.4	-7.3	2	-47.3	-3.2
2.4369	11	16.4	-7.4	2	-47.4	-3.3
2.43695	10.9	16.4	-7.5	2	-47.5	-3.4
2.437	10.9	16.4	-7.5	2	-47.5	-3.4
2.43705	11	16.4	-7.4	2	-47.4	-3.3
2.4371	11.1	16.4	-7.3	2	-47.3	-3.2
2.43715	11.2	16.4	-7.2	2	-47.2	-3.1
2.4372	11.3	16.4	-7.1	2	-47.1	-3
2.43725	11.5	16.4	-6.9	2	-46.9	-2.8
2.4373	11.6	16.4	-6.8	2	-46.8	-2.7
2.43735	11.6	16.4	-6.8	2	-46.8	-2.7
2.4374	11.5	16.4	-6.9	2	-46.9	-2.8
2.43745	11.4	16.4	-7	2	-47	-2.9
2.4375	11.4	16.4	-7	2	-47	-2.9
2.43755	11.5	16.4	-6.9	2	-46.9	-2.8
2.4376	11.5	16.4	-6.9	2	-46.9	-2.8
2.43765	11.5	16.4	-6.9	2	-46.9	-2.8
2.4377	11.5	16.4	-6.9	2	-46.9	-2.8
2.43775	11.5	16.4	-6.9	2	-46.9	-2.8
2.4378	11.6	16.4	-6.8	2	-46.8	-2.7
2.43785	11.7	16.4	-6.7	2	-46.7	-2.6



11Mbps CHANNEL 6 Processing Gain						
Gp = (S/N) ° + Mj + Lsys						
Freq. (GHz)	Gp (dB)	(S/N) ° (dB)	Mj = J/S (dB)	Lsys (dB)	Jammer (dBm)	LVL (dBm)
2.4379	11.8	16.4	-6.6	2	-46.6	-2.5
2.43795	11.7	16.4	-6.7	2	-46.7	-2.6
2.438	11.7	16.4	-6.7	2	-46.7	-2.6
2.43805	11.6	16.4	-6.8	2	-46.8	-2.7
2.4381	11.6	16.4	-6.8	2	-46.8	-2.7
2.43815	11.5	16.4	-6.9	2	-46.9	-2.8
2.4382	11.5	16.4	-6.9	2	-46.9	-2.8
2.43825	11.4	16.4	-7	2	-47	-2.9
2.4383	11.4	16.4	-7	2	-47	-2.9
2.43835	11.3	16.4	-7.1	2	-47.1	-3
2.4384	11.3	16.4	-7.1	2	-47.1	-3
2.43845	11.3	16.4	-7.1	2	-47.1	-3
2.4385	11.3	16.4	-7.1	2	-47.1	-3
2.43855	11.4	16.4	-7	2	-47	-2.9
2.4386	11.4	16.4	-7	2	-47	-2.9
2.43865	11.4	16.4	-7	2	-47	-2.9
2.4387	11.4	16.4	-7	2	-47	-2.9
2.43875	11.4	16.4	-7	2	-47	-2.9
2.4388	11.3	16.4	-7.1	2	-47.1	-3
2.43885	11.3	16.4	-7.1	2	-47.1	-3
2.4389	11.2	16.4	-7.2	2	-47.2	-3.1
2.4895	11.1	16.4	-7.3	2	-47.3	-3.2
2.439	11.1	16.4	-7.3	2	-47.3	-3.2
2.43905	11	16.4	-7.4	2	-47.4	-3.3
2.4391	11	16.4	-7.4	2	-47.4	-3.3
2.43915	11	16.4	-7.4	2	-47.4	-3.3
2.4392	11	16.4	-7.4	2	-47.4	-3.3
2.43925	11.1	16.4	-7.3	2	-47.3	-3.2
2.4393	11.2	16.4	-7.2	2	-47.2	-3.1
2.43935	11.2	16.4	-7.2	2	-47.2	-3.1
2.4394	11.4	16.4	-7	2	-47	-2.9
2.43945	11.4	16.4	-7	2	-47	-2.9
2.4395	11.2	16.4	-7.2	2	-47.2	-3.1

Processing Gain : 11.4 dB



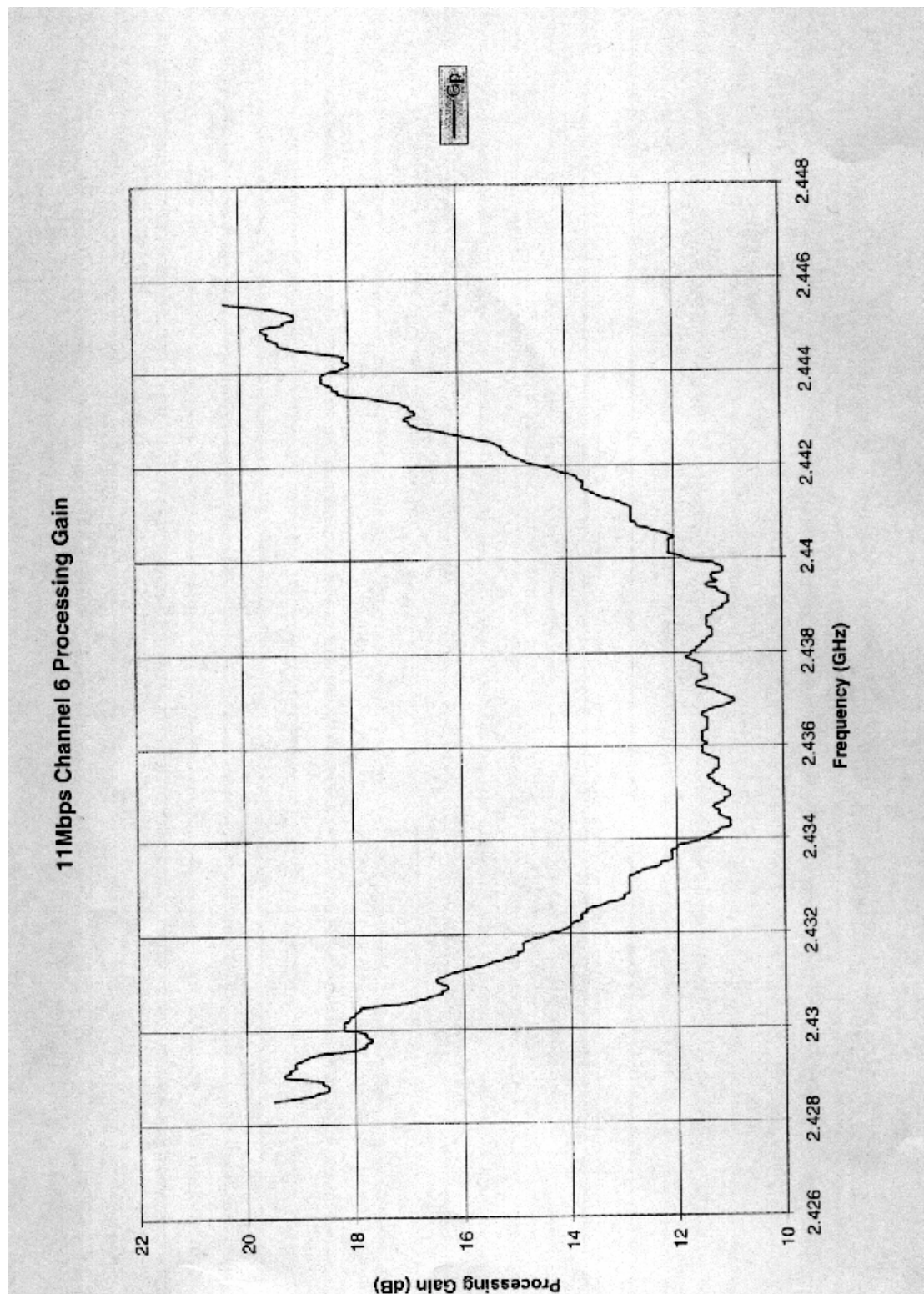

11Mbps CHANNEL 11 Processing Gain						
Gp = (S/N) ° + Mj + Lsys						
Freq.	Gp	(S/N) °	Mj = J/S	Lsys	Jammer	LVL
(GHz)	(dB)	(dB)	(dB)	(dB)	(dBm)	(dBm)
2.4595	11.7	16.4	-6.7	2	-46.7	-4.9
2.45955	11.8	16.4	-6.6	2	-46.6	-4.8
5.4596	11.8	16.4	-6.6	2	-46.6	-4.8
2.45965	11.7	16.4	-6.7	2	-46.7	-4.9
2.4597	11.7	16.4	-6.7	2	-46.7	-4.9
2.45975	11.6	16.4	-6.8	2	-46.8	-5
2.4598	11.5	16.4	-6.9	2	-46.9	-5.1
2.45985	11.4	16.4	-7	2	-47	-5.2
2.4599	11.4	16.4	-7	2	-47	-5.2
2.45995	11.3	16.4	-7.1	2	-47.1	-5.3
2.46	11.3	16.4	-7.1	2	-47.1	-5.3
2.46005	11.3	16.4	-7.1	2	-47.1	-5.3
2.4601	11.4	16.4	-7	2	-47	-5.2
2.46015	11.5	16.4	-6.9	2	-46.9	-5.1
2.4602	11.5	16.4	-6.9	2	-46.9	-5.1
2.46025	11.6	16.4	-6.8	2	-46.8	-5
2.4603	11.6	16.4	-6.8	2	-46.8	-5
2.46035	11.6	16.4	-6.8	2	-46.8	-5
2.4604	11.6	16.4	-6.8	2	-46.8	-5
2.46045	11.5	16.4	-6.9	2	-46.9	-5.1
2.4605	11.5	16.4	-6.9	2	-46.9	-5.1
2.46055	11.4	16.4	-7	2	-47	-5.2
2.4606	11.4	16.4	-7	2	-47	-5.2
2.46065	11.5	16.4	-6.9	2	-46.9	-5.1
2.4607	11.5	16.4	-6.9	2	-46.9	-5.1
2.46075	11.6	16.4	-6.8	2	-46.8	-5
2.4608	11.6	16.4	-6.8	2	-46.8	-5
2.46085	11.8	16.4	-6.6	2	-46.6	-4.8
2.4609	11.9	16.4	-6.5	2	-46.5	-4.7
2.46095	12	16.4	-6.4	2	-46.4	-4.6
2.461	12	16.4	-6.4	2	-46.4	-4.6
2.46105	11.9	16.4	-6.5	2	-46.5	-4.7
2.4611	12	16.4	-6.4	2	-46.4	-4.6
2.46115	12.1	16.4	-6.3	2	-46.3	-4.5



11Mbps CHANNEL 11 Processing Gain						
Gp = (S/N) ° + Mj + Lsys						
Freq. (GHz)	Gp (dB)	(S/N) ° (dB)	Mj = J/S (dB)	Lsys (dB)	Jammer (dBm)	LVL (dBm)
2.4612	12.1	16.4	-6.3	2	-46.3	-4.5
2.46125	12.1	16.4	-6.3	2	-46.3	-4.5
2.4613	12.1	16.4	-6.3	2	-46.3	-4.5
2.46135	12.1	16.4	-6.3	2	-46.3	-4.5
2.4614	12.1	16.4	-6.3	2	-46.3	-4.5
2.46145	12.1	16.4	-6.3	2	-46.3	-4.5
2.4615	12.2	16.4	-6.2	2	-46.2	-4.4
2.46155	12.2	16.4	-6.2	2	-46.2	-4.4
2.4616	12.3	16.4	-6.1	2	-46.1	-4.3
2.46165	12.3	16.4	-6.1	2	-46.1	-4.3
2.4617	12.4	16.4	-6	2	-46	-4.2
2.46175	12.3	16.4	-6.1	2	-46.1	-4.3
2.4618	12.2	16.4	-6.2	2	-46.2	-4.4
2.46185	12.1	16.4	-6.3	2	-46.3	-4.5
2.4619	12	16.4	-6.4	2	-46.4	-4.6
2.46195	12	16.4	-6.4	2	-46.4	-4.6
2.462	11.9	16.4	-6.5	2	-46.5	-4.7
2.46205	12	16.4	-6.4	2	-46.4	-4.6
2.4621	12.1	16.4	-6.3	2	-46.3	-4.5
2.46215	12.2	16.4	-6.2	2	-46.2	-4.4
2.4622	12.3	16.4	-6.1	2	-46.1	-4.3
2.46225	12.4	16.4	-6	2	-46	-4.2
2.4623	12.5	16.4	-5.9	2	-45.9	-4.1
2.46235	12.4	16.4	-6	2	-46	-4.2
2.4624	12.4	16.4	-6	2	-46	-4.2
2.46245	12.3	16.4	-6.1	2	-46.1	-4.3
2.4625	12.3	16.4	-6.1	2	-46.1	-4.3
2.46255	12.3	16.4	-6.1	2	-46.1	-4.3
2.4626	12.3	16.4	-6.1	2	-46.1	-4.3
2.46265	12.3	16.4	-6.1	2	-46.1	-4.3
2.4627	12.2	16.4	-6.2	2	-46.2	-4.4
2.46275	12.3	16.4	-6.1	2	-46.1	-4.3
2.4628	12.3	16.4	-6.1	2	-46.1	-4.3
2.46285	12.3	16.4	-6.1	2	-46.1	-4.3



11Mbps CHANNEL 11 Processing Gain						
Gp = (S/N) ° + Mj + Lsys						
Freq. (GHz)	Gp (dB)	(S/N) ° (dB)	Mj = J/S (dB)	Lsys (dB)	Jammer (dBm)	LVL (dBm)
2.4629	12.2	16.4	-6.2	2	-46.2	-4.4
2.46295	12.2	16.4	-6.2	2	-46.2	-4.4
2.463	12.2	16.4	-6.2	2	-46.2	-4.4
2.46305	12.1	16.4	-6.3	2	-46.3	-4.5
2.4631	12	16.4	-6.4	2	-46.4	-4.6
2.46315	11.9	16.4	-6.5	2	-46.5	-4.7
2.4632	11.9	16.4	-6.5	2	-46.5	-4.7
2.46325	11.8	16.4	-6.6	2	-46.6	-4.8
2.4633	11.8	16.4	-6.6	2	-46.6	-4.8
2.46335	11.7	16.4	-6.7	2	-46.7	-4.9
2.4634	11.8	16.4	-6.6	2	-46.6	-4.8
2.46345	11.8	16.4	-6.6	2	-46.6	-4.8
2.4635	11.9	16.4	-6.5	2	-46.5	-4.7
2.46355	11.9	16.4	-6.5	2	-46.5	-4.7
2.4636	12	16.4	-6.4	2	-46.4	-4.6
2.46365	12	16.4	-6.4	2	-46.4	-4.6
2.4637	12.1	16.4	-6.3	2	-46.3	-4.5
2.46375	12.1	16.4	-6.3	2	-46.3	-4.5
2.4638	12	16.4	-6.4	2	-46.4	-4.6
2.46385	12	16.4	-6.4	2	-46.4	-4.6
2.4639	11.9	16.4	-6.5	2	-46.5	-4.7
2.46395	11.8	16.4	-6.6	2	-46.6	-4.8
2.464	11.8	16.4	-6.6	2	-46.6	-4.8
2.46405	11.8	16.4	-6.6	2	-46.6	-4.8
2.4641	11.8	16.4	-6.6	2	-46.6	-4.8
2.46415	11.8	16.4	-6.6	2	-46.6	-4.8
2.4642	11.9	16.4	-6.5	2	-46.5	-4.7
2.46425	12	16.4	-6.4	2	-46.4	-4.6
2.4643	12.1	16.4	-6.3	2	-46.3	-4.5
2.46435	12.2	16.4	-6.2	2	-46.2	-4.4
4.4644	12.2	16.4	-6.2	2	-46.2	-4.4
2.46445	12.2	16.4	-6.2	2	-46.2	-4.4
2.4645	12.2	16.4	-6.2	2	-46.2	-4.4

Processing Gain : 12 dB



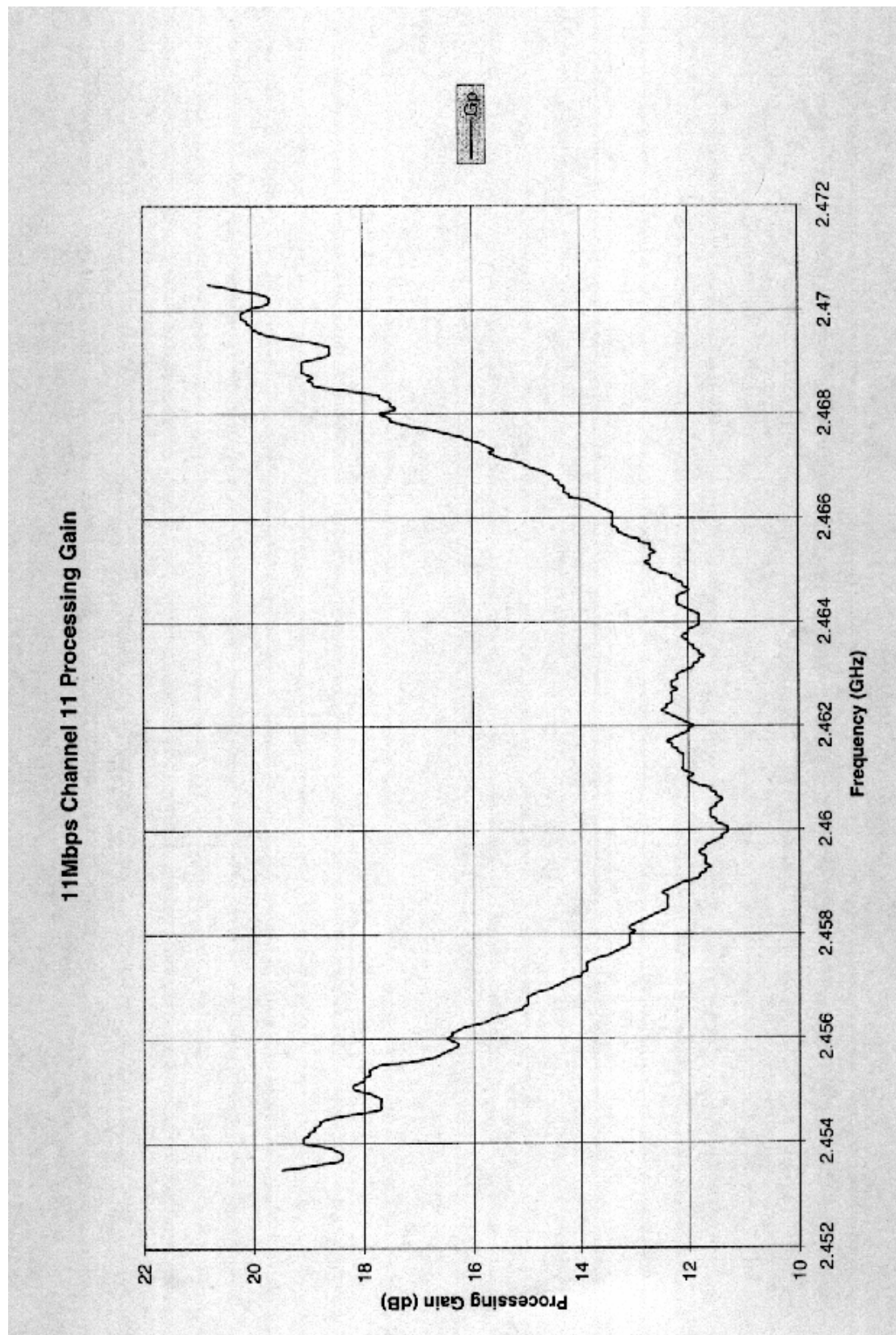



2Mbps CHANNEL 6 Processing Gain						
Gp = (S/N) ° + Mj + Lsys						
Freq. (GHz)	Gp (dB)	(S/N) ° (dB)	Mj = J/S (dB)	Lsys (dB)	Jammer (dBm)	LVL (dBm)
2.4345	12.1	13.3	-3.2	2	-43.2	0.5
2.43455	12.7	13.3	-2.6	2	-42.6	1.1
2.4346	12.9	13.3	-2.4	2	-42.4	1.3
2.43465	13	13.3	-2.3	2	-42.3	1.4
2.4347	13	13.3	-2.3	2	-42.3	1.4
2.43475	12.9	13.3	-2.4	2	-42.4	1.3
2.4348	13.1	13.3	-2.2	2	-42.2	1.5
2.43485	12.4	13.3	-2.9	2	-42.9	0.8
2.4349	12.1	13.3	-3.2	2	-43.2	0.5
2.43495	12.6	13.3	-2.7	2	-42.7	1
2.435	12.6	13.3	-2.7	2	-42.7	1
2.43505	12.5	13.3	-2.8	2	-42.8	0.9
2.4351	12.4	13.3	-2.9	2	-42.9	0.8
2.43515	12.4	13.3	-2.9	2	-42.9	0.8
2.4352	12.2	13.3	-3.1	2	-43.1	0.6
2.43525	12.2	13.3	-3.1	2	-43.7	0.6
2.4353	12.3	13.3	-3	2	-43	0.7
2.43535	11.9	13.3	-3.4	2	-43.4	0.3
2.4354	11.5	13.3	-3.8	2	-43.8	-0.1
2.43545	12.1	13.3	-3.2	2	-43.2	0.5
2.4355	11.5	13.3	-3.8	2	-43.8	-0.1
2.43555	12.4	13.3	-2.9	2	-42.9	0.8
2.4356	12.7	13.3	-2.6	2	-42.6	1.1
2.43565	12.9	13.3	-2.4	2	-42.4	1.3
2.4357	12.8	13.3	-2.5	2	-42.5	1.2
5.43575	12.8	13.3	-2.5	2	-42.5	1.2
2.4358	12.9	13.3	-2.4	2	-42.4	1.3
2.43585	12.1	13.3	-3.2	2	-43.2	0.5
2.4359	11.7	13.3	-3.6	2	-43.6	0.1
2.43595	12.4	13.3	-2.9	2	-42.9	0.8
2.436	12.5	13.3	-2.8	2	-42.8	0.9
2.43605	12.5	13.3	-2.8	2	-42.8	0.9
2.4361	12.4	13.3	-2.9	2	-42.9	0.8
2.43615	12.4	13.3	-2.9	2	-42.9	0.8



2Mbps CHANNEL 6 Processing Gain						
Gp = (S/N) ° + Mj + Lsys						
Freq. (GHz)	Gp (dB)	(S/N) ° (dB)	Mj = J/S (dB)	Lsys (dB)	Jammer (dBm)	LVL (dBm)
2.4362	12.1	13.3	-3.2	2	-43.2	0.5
2.43625	12.1	13.3	-3.2	2	-43.2	0.5
2.4363	12.1	13.3	-3.2	2	-43.2	0.5
2.43635	11.5	13.3	-3.8	2	-43.8	-0.1
2.4364	11.1	13.3	-4.2	2	-44.2	-0.5
2.43645	11.7	13.3	-3.6	2	-43.6	0.1
2.4365	11.2	13.3	-4.1	2	-44.1	-0.4
2.43655	12.6	13.3	-2.7	2	-42.7	1
2.4366	13.1	13.3	-2.2	2	-42.2	1.5
2.43665	13.7	13.3	-1.6	2	-41.6	2.1
2.4367	14.1	13.3	-1.2	2	-41.2	2.5
2.43675	15.1	13.3	-0.2	2	-40.2	3.5
2.4368	15.7	13.3	0.4	2	-39.6	4.1
2.43685	16.2	13.3	0.9	2	-39.1	4.6
2.4369	16.1	13.3	0.8	2	-39.2	4.5
2.43695	16.3	13.3	1	2	-39	4.7
2.437	16.6	13.3	1.3	2	-38.7	5
2.43705	16.3	13.3	1	2	-39	4.7
2.4371	16.3	13.3	1	2	-39	4.7
2.43715	16	13.3	0.7	2	-39.3	4.4
2.4372	15.5	13.3	0.2	2	-39.8	3.9
2.43725	14.8	13.3	-0.5	2	-40.5	3.2
2.4373	14	13.3	-1.3	2	-41.3	2.4
2.43735	13.5	13.3	-1.8	2	-41.8	1.9
2.4374	12.7	13.3	-2.6	2	-42.6	1.1
2.43745	12.6	13.3	-2.7	2	-42.7	1
2.4375	11.6	13.3	-3.7	2	-43.7	0
2.43755	12.1	13.3	-3.2	2	-43.2	0.5
2.4376	12.1	13.3	-3.2	2	-43.2	0.5
2.43765	12.1	13.3	-3.2	2	-43.2	0.5
2.4377	12	13.3	-3.3	2	-43.3	0.4
2.43775	11.7	13.3	-3.6	2	-43.6	0.1
2.4378	12	13.3	-3.3	2	43.3	0.4
2.43785	11.1	13.3	-4.2	2	-44.2	-0.5



2Mbps CHANNEL 6 Processing Gain						
Gp = (S/N) ° + Mj + Lsys						
Freq. (GHz)	Gp (dB)	(S/N) ° (dB)	Mj = J/S (dB)	Lsys (dB)	Jammer (dBm)	LVL (dBm)
2.4379	11.2	13.3	-4.1	2	-44.1	-0.4
2.43795	12.1	13.3	-3.2	2	-43.2	0.5
2.438	12.5	13.3	-2.8	2	-42.8	0.9
2.43805	12.7	13.3	-2.6	2	-42.6	1.1
2.4381	12.8	13.3	-2.5	2	-42.5	1.2
2.43815	12.9	13.3	-2.4	2	-42.4	1.3
2.4382	12.9	13.3	-2.4	2	-42.4	1.3
2.43825	12.9	13.3	-2.4	2	-42.4	1.3
2.4383	12.8	13.3	-2.5	2	-42.5	1.2
2.43835	12.6	13.3	-2.7	2	-42.7	1
2.4384	12	13.3	-3.3	2	-43.3	0.4
2.43845	12.4	13.3	-2.9	2	-42.9	0.8
2.4385	11.7	13.3	-3.6	2	-43.6	0.1
2.43855	12.3	13.3	-3	2	-43	0.7
2.4386	12.3	13.3	-3	2	-43	0.7
2.43865	12.3	13.3	-3	2	-43	0.7
2.4387	12.2	13.3	-3.1	2	-43.1	0.6
2.43875	12	13.3	-3.3	2	-43.3	0.4
2.4388	12.3	13.3	-3	2	-43	0.7
2.43885	11.6	13.3	-3.7	2	-43.7	0
2.4389	11.6	13.3	-3.7	2	-43.7	0
2.43895	12.4	13.3	-2.9	2	-42.9	0.8
2.439	12.7	13.3	-2.6	2	-42.6	1.1
2.43905	12.7	13.3	-2.6	2	-42.6	1.1
2.4391	12.8	13.3	-2.5	2	-42.5	1.2
2.43915	12.9	13.3	-2.4	2	-42.4	1.3
2.4392	12.8	13.3	-2.5	2	-42.5	1.2
2.43925	12.9	13.3	-2.4	2	-42.4	1.3
2.4393	12.8	13.3	-2.5	2	-42.5	1.2
2.43935	12.6	13.3	-2.7	2	-42.7	1
2.4394	12.3	13.3	-3	2	-43	0.7
2.43945	12.5	13.3	-2.8	2	-42.8	0.9
2.4395	12	13.3	-3.3	2	-43.3	0.4

Processing Gain : 12.5 dB



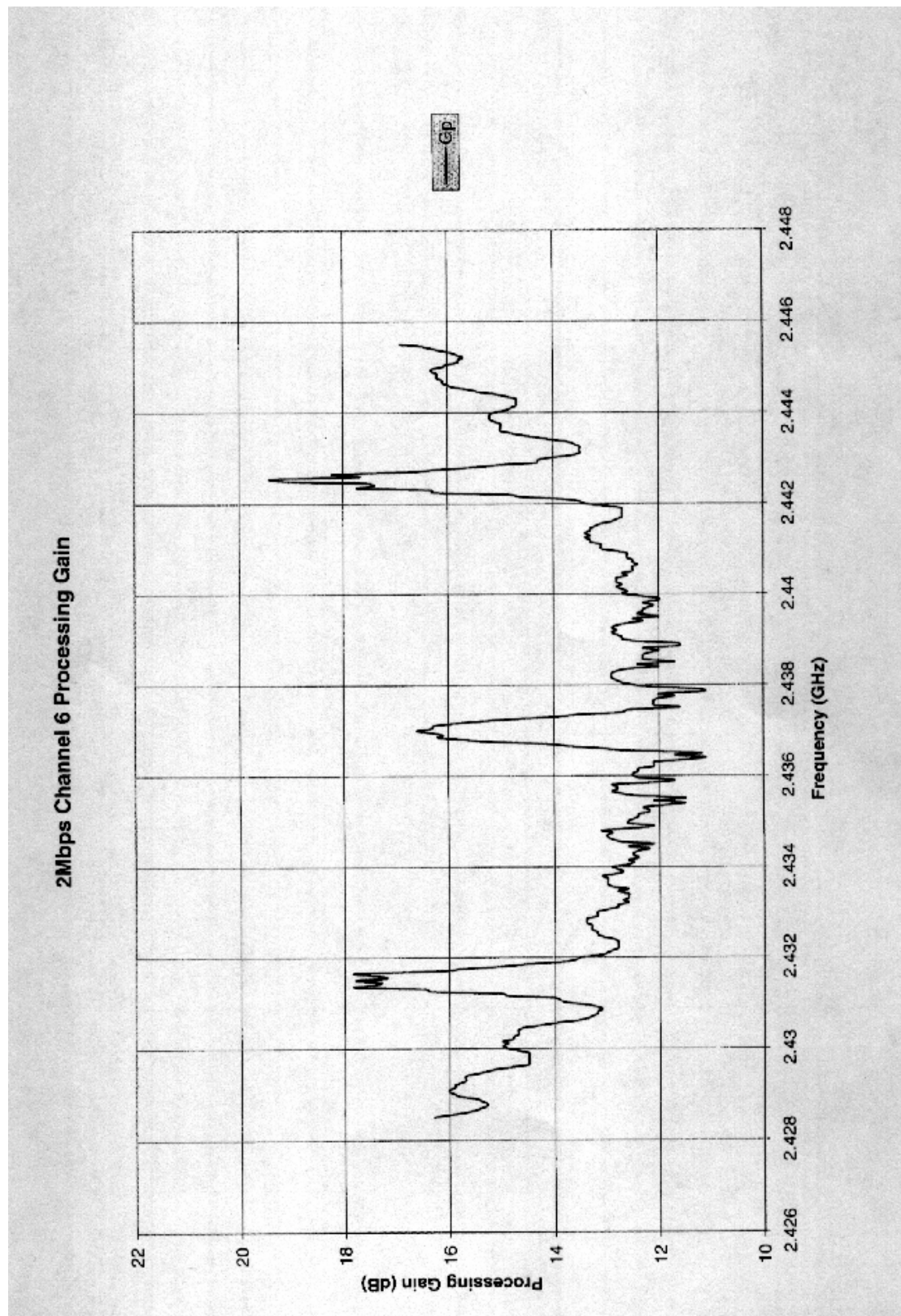



## **4.8 ANTENNA REQUIREMENT**

### **4.8.1 STANDARD APPLICABLE**

For intentional device, according to FCC 47 CFR Section 15.203, an intentional radiator shall be designed to ensure that no antenna other than that furnished by the responsible party shall be used with the device.

And according to FCC 47 CFR Section 15.247 (b), if transmitting antennas of directional gain greater than 6 dBi are used, the power shall be reduced by the amount in dB that the directional gain of the antenna exceeds 6 dBi.

### **4.8.2 ANTENNA CONNECTED CONSTRUCTION**

The antenna used in this product is monopole. The external antenna connector is Reverse TNC and the internal connector is MMCX. The maximum Gain of this antenna is only 1dBi.

## 5 PHOTOGRAPHS OF THE TEST CONFIGURATION CONDUCTED EMISSION TEST



## RADIATED EMISSION TEST

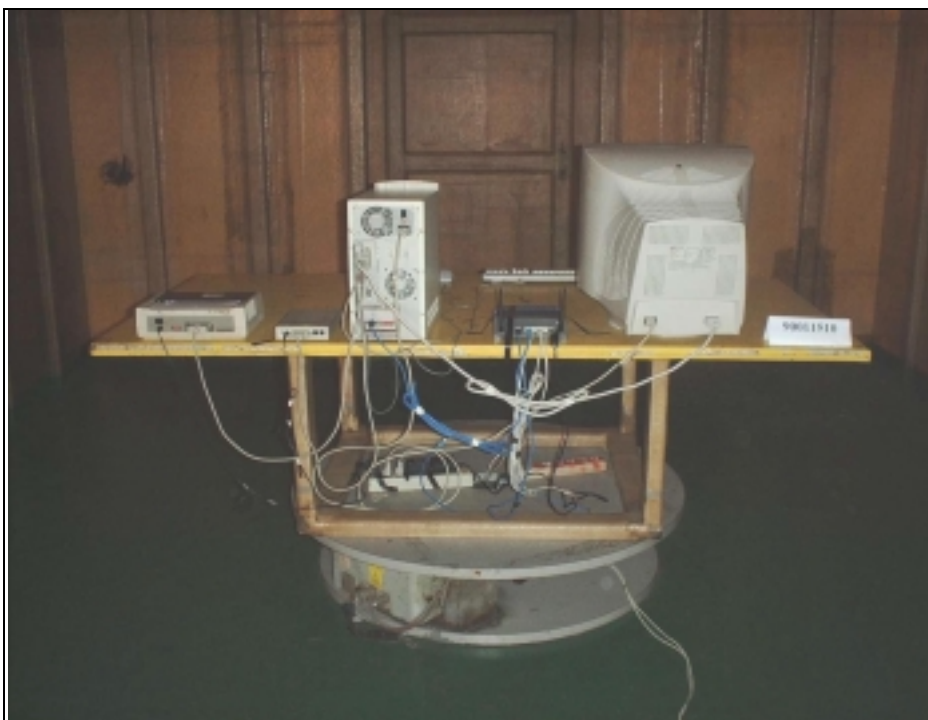
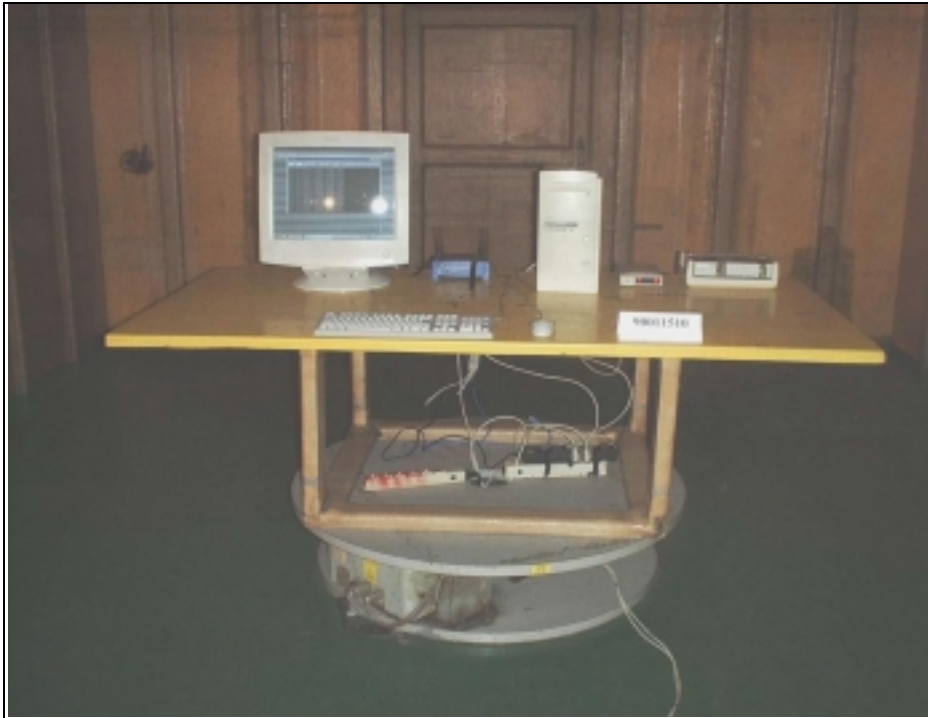



## 6 INFORMATION ON THE TESTING LABORATORIES

We, ADT Corp., were founded in 1988 to provide our best service in EMC and Safety consultation. Our laboratories are accredited by the following approval agencies according to ISO/IEC Guide 25 or EN 45001:

<b>USA</b>	FCC, NVLAP
<b>Germany</b>	TUV Rheinland
<b>Japan</b>	VCCI
<b>New Zealand</b>	RFS
<b>Norway</b>	NEMKO, DNV
<b>U.K.</b>	INCHCAPE
<b>R.O.C.</b>	BSMI

Copies of accreditation certificates of our laboratories obtained from approval agencies can be downloaded from our web site: [www.adt.com.tw/index.5/phtml](http://www.adt.com.tw/index.5/phtml).

If you have any comments, please feel free to contact us at the following:

**Lin Kou EMC Lab:**

Tel: 886-2-26052180

Fax: 886-2-26052943

**Lin Kou Safety Lab:**

Tel: 886-2-26093195

Fax: 886-2-26093184

**Hsin Chu EMC Lab:**

Tel: 886-35-935343

Fax: 886-35-935342

**Design Center:**

Tel: 886-2-26093195

Fax: 886-2-26093184

**Email:** [service@mail.adt.com.tw](mailto:service@mail.adt.com.tw)

**Web Site:** [www.adt.com.tw](http://www.adt.com.tw)