



# FCC TEST REPORT

**REPORT NO.:** RF89111710-1  
**MODEL NO.:** GL2411AP, WAP11  
**RECEIVED:** November 17, 2000  
**TESTED:** May 7, 2001

**APPLICANT:** GLOBAL SUN TECHNOLOGY, INC.

**ADDRESS:** No.13, Tung Yuan Road, Jung Li Industrial Park,  
Jung Li City, TaoYuan Hsien, Taiwan, R.O.C.

**ISSUED BY:** Advance Data Technology Corporation

**LAB LOCATION:** 47, 14<sup>th</sup> Lin, Chiapao Tsuen, Linkou,  
Taipei, Taiwan, R.O.C.

This test report consists of 47 pages in total. It may be duplicated completely for legal use with the approval of the applicant. It should not be reproduced except in full, without the written approval of our laboratory. The client should not use it to claim product endorsement by NVLAP or any U.S. government agencies. The test results in the report only apply to the tested sample.



Accredited Laboratory



## Table of Contents

1	CERTIFICATION .....	4
2	SUMMARY OF TEST RESULTS.....	5
3	GENERAL INFORMATION .....	6
3.1	GENERAL DESCRIPTION OF EUT .....	6
3.2	DESCRIPTION OF TEST MODES .....	6
3.3	GENERAL DESCRIPTION OF APPLIED STANDARDS.....	7
3.4	DESCRIPTION OF SUPPORT UNITS .....	7
3.5	CONFIGURATION OF SYSTEM UNDER TEST .....	7
4	TEST PROCEDURES AND RESULTS .....	8
4.1	CONDUCTED EMISSION MEASUREMENT .....	8
4.1.1	LIMITS OF CONDUCTED EMISSION MEASUREMENT .....	8
4.1.2	TEST INSTRUMENTS .....	8
4.1.3	TEST PROCEDURES .....	9
4.1.4	TEST SETUP .....	10
4.1.5	TEST RESULTS .....	11
4.2	RADIATED EMISSION MEASUREMENT .....	17
4.2.1	LIMITS OF RADIATED EMISSION MEASUREMENT.....	17
4.2.2	TEST INSTRUMENTS .....	18
4.2.3	TEST PROCEDURES .....	19
4.2.4	TEST SETUP .....	20
4.2.5	TEST RESULTS .....	21
4.3	6dB BANDWIDTH MEASUREMENT .....	25
4.3.1	LIMITS OF 6dB BANDWIDTH MEASUREMENT .....	25
4.3.2	TEST INSTRUMENTS .....	25
4.3.3	TEST PROCEDURE.....	26
4.3.4	TEST SETUP .....	26
4.3.5	EUT OPERATING CONDITION.....	26
4.3.6	TEST RESULTS .....	27
4.4	MAXIMUM PEAK OUTPUT POWER.....	31
4.4.1	LIMITS OF MAXIMUM PEAK OUTPUT POWER MEASUREMENT.....	31
4.4.2	INSTRUMENTS.....	31
4.4.3	TEST PROCEDURES .....	32
4.4.4	TEST SETUP .....	32
4.4.5	EUT OPERATING CONDITION.....	32
4.4.6	TEST RESULTS .....	33
4.5	POWER SPECTRAL DENSITY MEASUREMENT .....	34
4.5.1	LIMITS OF POWER SPECTRAL DENSITY MEASUREMENT .....	34



4.5.2 TEST INSTRUMENTS .....34

4.5.3 TEST PROCEDURE.....35

4.5.4 TEST SETUP .....35

4.5.5 EUT OPERATING CONDITION.....35

4.5.6 TEST RESULTS .....36

4.6 BAND EDGES MEASUREMENT ..... 40

4.6.1 LIMITS OF BAND EDGES MEASUREMENT .....40

4.6.2 TEST INSTRUMENTS .....40

4.6.3 TEST PROCEDURE.....40

4.6.4 EUT OPERATING CONDITION.....41

4.6.5 TEST RESULTS .....41

4.6.6 NOTE ON BAND EDGE EMISSION.....41

5 PHOTOGRAPHS OF THE TEST CONFIGURATION..... **44**

6 ANTENNA REQUIREMENT ..... **46**

6.1 STANDARD APPLICABLE ..... 46

6.2 ANTENNA CONNECTED CONSTRUCTION ..... 46

7 INFORMATION ON THE TESTING LABORATORIES..... **47**

ANNEX PHOTOGRAPHS OF EUT



## 1 CERTIFICATION

**PRODUCT :** Wireless Access Point  
**BRAND NAME :** GSTec  
**MODEL NO. :** GL2411AP, WAP11 (for OEM)  
**APPLICANT :** Global Sun Technology Inc.  
**OEM BRAND HOLDER :** The Linksys Group Inc.  
**OEM PRODUCT NAME :** Wireless Network Access Point  
**OEM BRAND NAME :** Linksys  
**OEM MODEL NO.:** WAP11  
**STANDARDS :** 47 CFR Part 15, Subpart C (Section 15.247),  
ANSI C63.4-1992  
**SITE REGISTRATION NO. :** 90422 (FCC)  
IC 3789-5 (Canada IC)

We, **Advance Data Technology Corporation**, hereby certify that one sample of the designation (model: WAP11) has been tested in our facility on May 7, 2001.

The test record, data evaluation and Equipment Under Test (EUT) configurations represented herein are true and accurate accounts of the measurements of the sample's EMC characteristics under the conditions herein specified.

Tested by : Gary Chang , Date: May 11, 2001  
Gary Chang

Prepared by : Demi Chen , Date: May 11, 2001  
Demi Chen

Approved by : Harris W. Lai , Date: May 11, 2001  
Harris W. Lai

## 2 SUMMARY OF TEST RESULTS

The EUT has been tested according to the following specifications:

<b>APPLIED STANDARD: 47 CFR Part 15, Subpart C</b>			
<b>STANDARD PARAGRAPH</b>	<b>TEST REQUIREMENTS</b>	<b>PASS</b>	<b>REMARK</b>
15.107	AC Power Conducted Emissions Spec.: 48dBuV	Yes	Minimum passing margin is -3.72dBuV at 16.04117 MHz
15.247(a)(2)	Spectrum Bandwidth of a Direct Sequence Spread Spectrum System Spec.: min. 500Khz	Yes	10.18 MHz > 500 kHz
15.247(b)	Maximum Peak Output Power Spec.: max. 30dBm	Yes	17.18dBm < 30dBm
15.247(c)	Transmitter Radiated Emissions Spec.: Table 15.209	Yes	Minimum passing margin is -5.6dBuV at 319.98 MHz
15.247(d)	Power Spectral Density Spec.: max. 8dBm	Yes	-11.42dBm < 8dBm
15.247(c)	Band Edge Measurement	Yes	N/A
15.247(e)	Processing Gain of Direct Sequence Spread Spectrum System Spec.: min. 10 dB	Yes	11.4dB $\geq$ 10dB

### NOTE:

The EUT is also considered as a PC peripheral, because the connection to computer is necessary for typical use. The test has been verified to comply with FCC Part 15, Subpart B, Class B – Computing Devices (FCC DoC). The engineering test report can be provided upon FCC requests.

### 3 GENERAL INFORMATION

#### 3.1 GENERAL DESCRIPTION OF EUT

<b>PRODUCT</b>	Wireless Access Point
<b>MODEL NO.</b>	GL2411AP, WAP11(for OEM)
<b>POWER SUPPLY</b>	AC Adapter
<b>MODULATION TYPE</b>	CCK, BPSK, QPSK
<b>TRANSFER RATE</b>	1/2/5.5/11Mbps
<b>FREQUENCY RANGE</b>	2412MHz ~ 2483.5MHz
<b>NUMBER OF CHANNEL</b>	11
<b>CHANNEL SPACING</b>	5MHz
<b>ANTENNA TYPE</b>	Dual Monopole Antenna
<b>OUTPUT POWER</b>	15dBm
<b>ASSOCIATED DEVICES</b>	NA

Note: This report is prepared for FCC class II permissive change. The difference compared with original design is only one extra SRAM added on the base band circuit.

The GL2411AP and WAP11 has been approved by FCC under FCC ID:O7JGL2411AP.The WAP 11 was chosen as the representative for test, because the GL2411AP and WAP11 are almost same except for the plastic outer appearance.

#### 3.2 DESCRIPTION OF TEST MODES

Eleven channels are provided in this EUT.

Channel	Frequency	Channel	Frequency
1	2412 MHz	7	2442 MHz
2	2417 MHz	8	2447 MHz
3	2422 MHz	9	2452 MHz
4	2427 MHz	10	2457 MHz
5	2432 MHz	11	2462 MHz
6	2437 MHz		

Note: 1. Below 1 GHz, the channel 1, 6, and 11 were pre-tested in chamber. The channel, worst case one, was chosen for final test.  
2. Above 1 GHz, the channel 1, 6, and 11 were chosen for evaluation.



**GENERAL DESCRIPTION OF APPLIED STANDARDS**

The EUT is a Wireless Access Point, according to the specifications of the EUT, it must comply with the requirements of the following standards:

**FCC CFR 47 Part 15, Subpart C. (15.247)**

All tests have been performed and recorded as per the above standards.

**3.3 DESCRIPTION OF SUPPORT UNITS**

The EUT has been tested as an independent unit together with other necessary accessories or support units. The following support units or accessories were used to form a representative test configuration during the tests.

No	Product	Brand	Model No.	Serial No.	I/O Cable
1	NOTEBOOK	DELL	PPX	99125	Nonshielded

Note: A shielded USB cable (1.5m) was connected to the USB port of EUT during the test.  
The USB port is designed for engineering setup only.

**3.4 CONFIGURATION OF SYSTEM UNDER TEST**

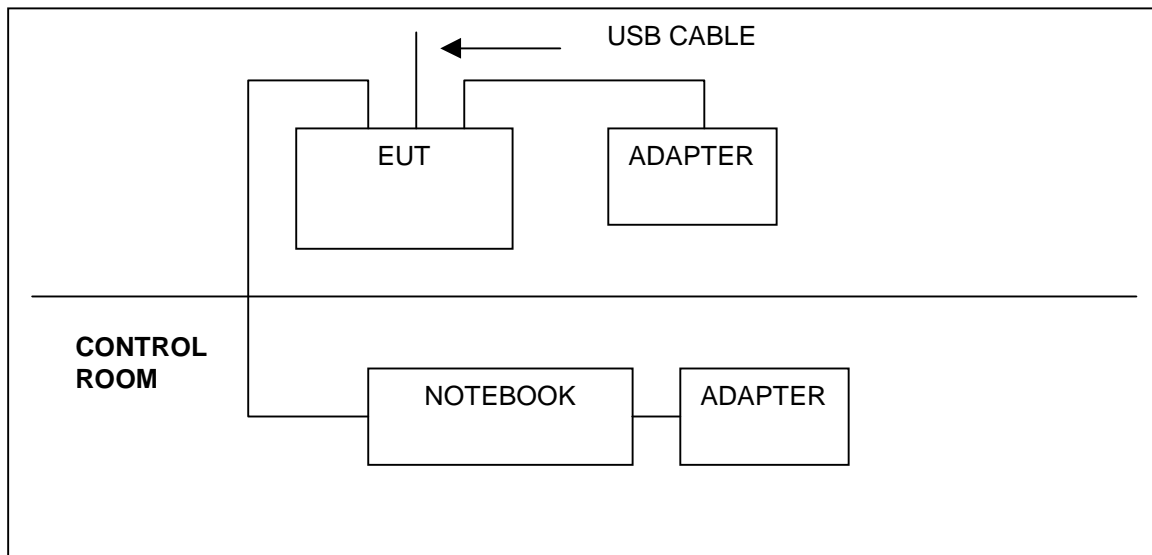

## 4 TEST PROCEDURES AND RESULTS

### 4.1 CONDUCTED EMISSION MEASUREMENT

#### 4.1.1 LIMITS OF CONDUCTED EMISSION MEASUREMENT

FREQUENCY (MHz)	Class A (dBuV)		Class B (dBuV)	
	Quasi-peak	Average	Quasi-peak	Average
0.45 – 30	48	-	48	-

Notes:

1. The lower limit shall apply at the transition frequencies.
2. All emanations from a class A/B digital device or system, including any network of conductors and apparatus connected thereto, shall not exceed the level of field strengths specified above.

#### 4.1.2 TEST INSTRUMENTS

DESCRIPTION & MANUFACTURER	MODEL NO.	SERIAL NO.	CALIBRATED UNTIL
ROHDE & SCHWARZ Test Receiver	ESHS30	828109/007	July 6, 2001
ROHDE & SCHWARZ Artificial Mains Network (for EUT)	ESH3-Z5	839135/006	July 9, 2001
ROHDE & SCHWARZ 4-wire ISN	ENY41	837032/016	Nov. 28, 2001
ROHDE & SCHWARZ 2-wire ISN	ENY22	837497/016	Dec. 3, 2001
EMCO-L.I.S.N. (for peripheral)	3825/2	9204-1964	July 9, 2001
Software	Cond-V2e	NA	NA
RF cable (JYEBAO)	RG-58A/U	Cable-C02.01	July 9, 2001
HP Terminator (For EMCO LISN)	11593A	E1-01-298	Feb. 20, 2002
HP Terminator (For EMCO LISN)	11593A	E1-01-299	Feb. 20, 2002
Shielded Room	Site 2	ADT-C02	NA
VCCI Site Registration No.	Site 2	C-240	NA

Notes:

1. The measurement uncertainty is less than +/- 2.6dB, which is calculated as per the NAMAS document NIS81.
2. The calibration interval of the above test instruments is 12 months. And the calibrations are traceable to NML/ROC and NIST/USA.





#### 4.1.3 TEST PROCEDURES

1. Place the EUT at 0.4 meter away from the conduction wall of the shielded room.
2. Connect the EUT to the power mains through a Line Impedance Stabilization Network (LISN).
3. Connect the other support units to the other LISN too.
4. Make sure the  $50\Omega/ 50\mu\text{H}$  coupling impedance is provided to the measurement instrument by the LISNs.
5. Measure the maximum conducted interference on both lines of the power mains connects to the EUT, within frequency range 450KHz ~ 30MHz.
6. The emission level under limit by 10dB is not needed to be reported.

## 4.1.4 TEST SETUP

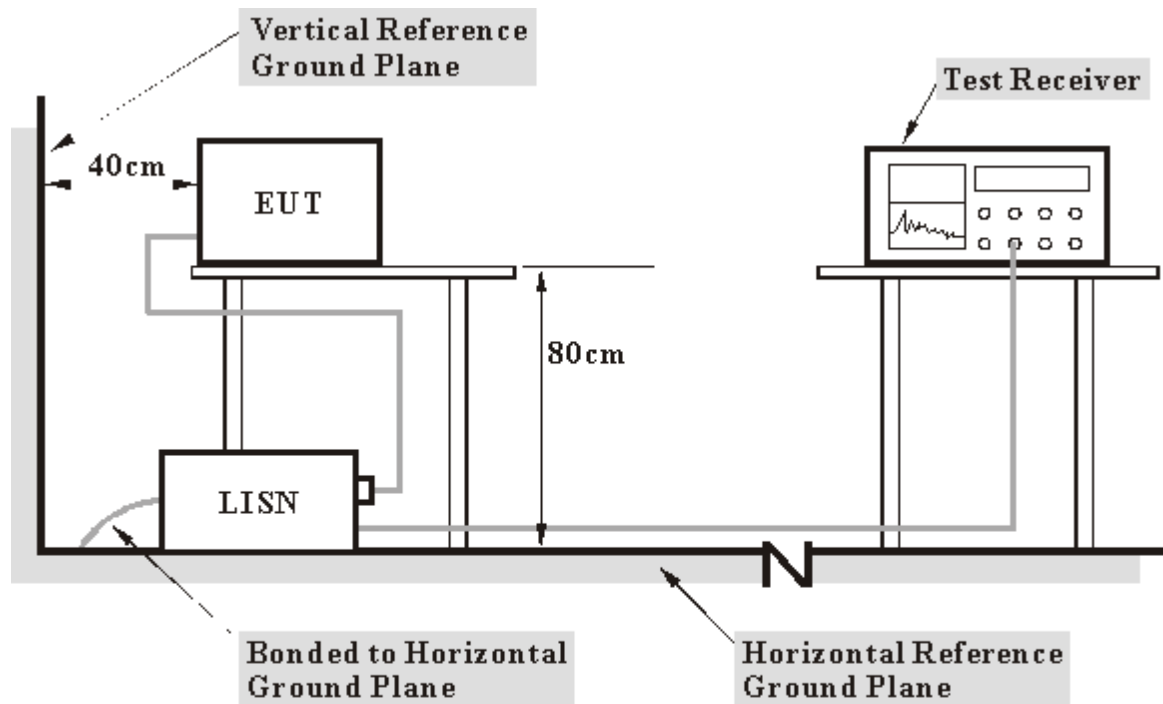

- Note:**
1. Support units were connected to second LISN.
  2. Both of LISNs (AMN) 80 cm from EUT and at the least 80 cm from other units and other metal planes support units.

For the actual test configuration, please refer to the related Item in this test report ( **Photographs of the Test Configuration** ).



4.1.5 TEST RESULTS

<b>EUT</b>	Wireless Access Point	<b>Model</b>	WAP11
<b>Channel</b>	Channel 1	<b>Phase</b>	L
<b>Environmental Conditions</b>	20°C , 60%RH	<b>Tested By</b>	Gary Chang

No	Freq. [MHz]	Corr. Factor (dB)	Reading Value [dB (uV)]		Emission Level [dB (uV)]		Limit [dB (uV)]		Margin (dB)	
			Q.P.	AV.	Q.P.	AV.	Q.P.	AV.	Q.P.	AV.
			1	0.51900	0.20	29.07	---	29.27	---	48.00
2	2.69400	0.27	36.97	---	37.24	---	48.00	---	-10.76	---
3	6.52400	0.53	20.24	---	20.77	---	48.00	---	-27.23	---
4	9.52100	0.68	30.64	---	31.32	---	48.00	---	-16.68	---
5	16.22300	1.02	33.36	---	34.38	---	48.00	---	-13.62	---
6	23.78600	1.33	32.12	---	33.45	---	48.00	---	-14.55	---

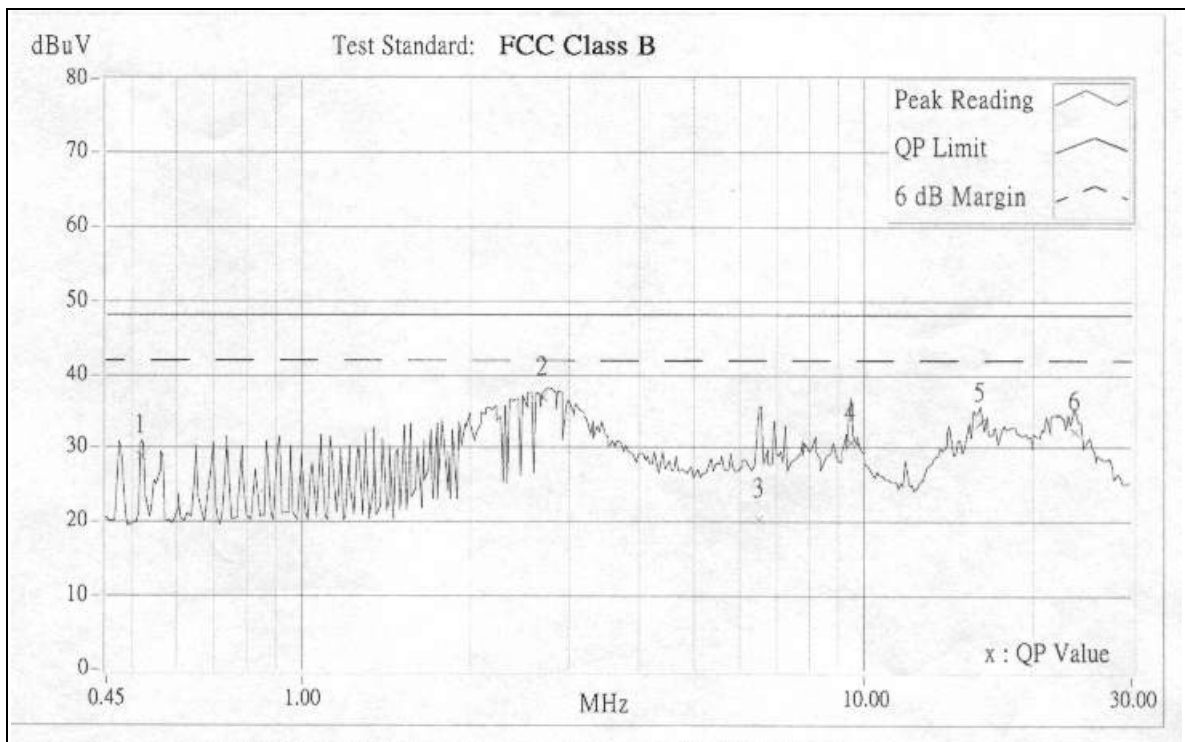

- Remarks:
1. Q.P. and AV. are abbreviations of quasi-peak and average individually.
  2. "-": NA
  3. The emission levels of other frequencies were very low against the limit.
  4. Margin value = Emission level - Limit value
  5. Emission Level = Correction Factor + Reading Value.



<b>EUT</b>	Wireless Access Point	<b>Model</b>	WAP11
<b>Channel</b>	Channel 1	<b>Phase</b>	N
<b>Environmental Conditions</b>	20°C , 60%RH	<b>Tested By</b>	Gary Chang

No	Freq. [MHz]	Corr. Factor (dB)	Reading Value [dB (uV)]		Emission Level [dB (uV)]		Limit [dB (uV)]		Margin (dB)	
			Q.P.	AV.	Q.P.	AV.	Q.P.	AV.	Q.P.	AV.
1	0.52200	0.20	37.89	---	38.09	---	48.00	---	-9.91	---
2	0.91200	0.20	34.63	---	34.83	---	48.00	---	-13.17	---
3	2.65073	0.27	35.56	---	35.83	---	48.00	---	-12.17	---
4	7.28000	0.51	33.90	---	34.41	---	48.00	---	-13.59	---
5	16.22452	0.92	33.48	---	34.40	---	48.00	---	-13.60	---
6	23.78981	1.23	32.16	---	33.39	---	48.00	---	-14.61	---

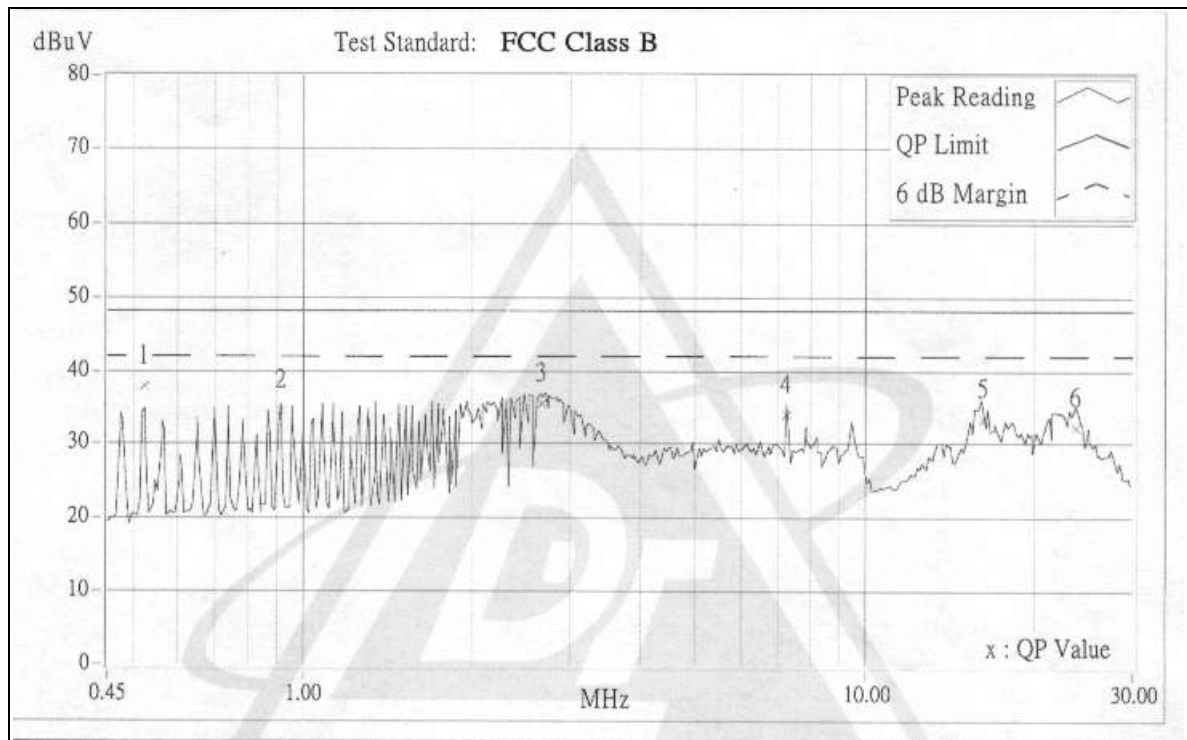

- Remarks:
1. Q.P. and AV. are abbreviations of quasi-peak and average individually.
  2. "-": NA
  3. The emission levels of other frequencies were very low against the limit.
  4. Margin value = Emission level - Limit value
  5. Emission Level = Correction Factor + Reading Value.



<b>EUT</b>	Wireless Access Point	<b>Model</b>	WAP11
<b>Channel</b>	Channel 6	<b>Phase</b>	L
<b>Environmental Conditions</b>	20°C , 60%RH	<b>Tested By</b>	Gary Chang

No	Freq. [MHz]	Corr. Factor (dB)	Reading Value [dB (uV)]		Emission Level [dB (uV)]		Limit [dB (uV)]		Margin (dB)	
			Q.P.	AV.	Q.P.	AV.	Q.P.	AV.	Q.P.	AV.
1	2.69101	0.27	37.09	---	37.36	---	48.00	---	-10.64	---
2	7.89374	0.59	35.74	---	36.33	---	48.00	---	-11.67	---
3	8.90174	0.65	34.57	---	35.22	---	48.00	---	-12.78	---
4	15.95855	1.02	42.64	---	43.66	---	48.00	---	-4.34	---
5	21.41728	1.19	38.06	---	39.25	---	48.00	---	-8.75	---
6	24.02127	1.34	38.91	---	40.25	---	48.00	---	-7.75	---

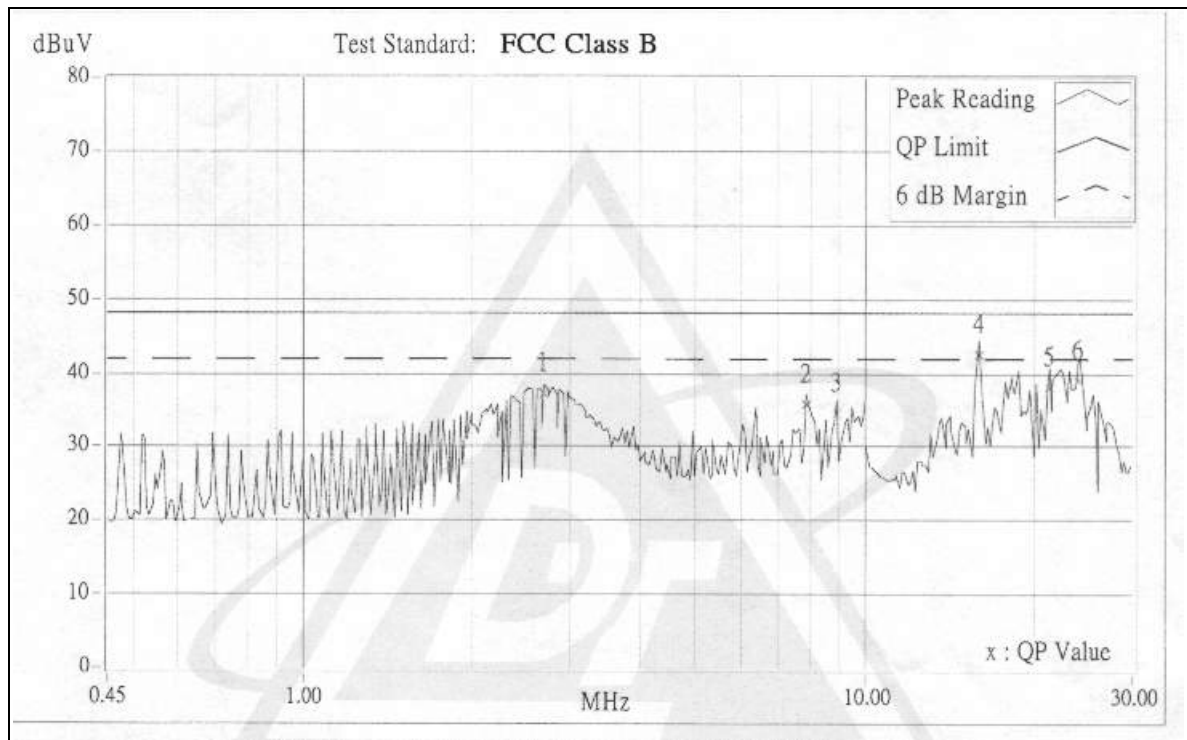

- Remarks:
1. Q.P. and AV. are abbreviations of quasi-peak and average individually.
  2. "-": NA
  3. The emission levels of other frequencies were very low against the limit.
  4. Margin value = Emission level - Limit value
  5. Emission Level = Correction Factor + Reading Value.



<b>EUT</b>	Wireless Access Point	<b>Model</b>	WAP11
<b>Channel</b>	Channel 6	<b>Phase</b>	N
<b>Environmental Conditions</b>	20°C , 60%RH	<b>Tested By</b>	Gary Chang

No	Freq. [MHz]	Corr. Factor (dB)	Reading Value [dB (uV)]		Emission Level [dB (uV)]		Limit [dB (uV)]		Margin (dB)	
			Q.P.	AV.	Q.P.	AV.	Q.P.	AV.	Q.P.	AV.
1	0.69300	0.20	34.53	---	34.73	---	48.00	---	-13.27	---
2	2.82000	0.28	35.66	---	35.94	---	48.00	---	-12.06	---
3	15.95600	0.92	43.28	---	44.20	---	48.00	---	-3.80	---
4	18.81200	0.98	38.53	---	39.51	---	48.00	---	-8.49	---
5	21.29300	1.08	15.16	---	16.24	---	48.00	---	-31.76	---
6	22.25600	1.14	39.05	---	40.19	---	48.00	---	-7.81	---

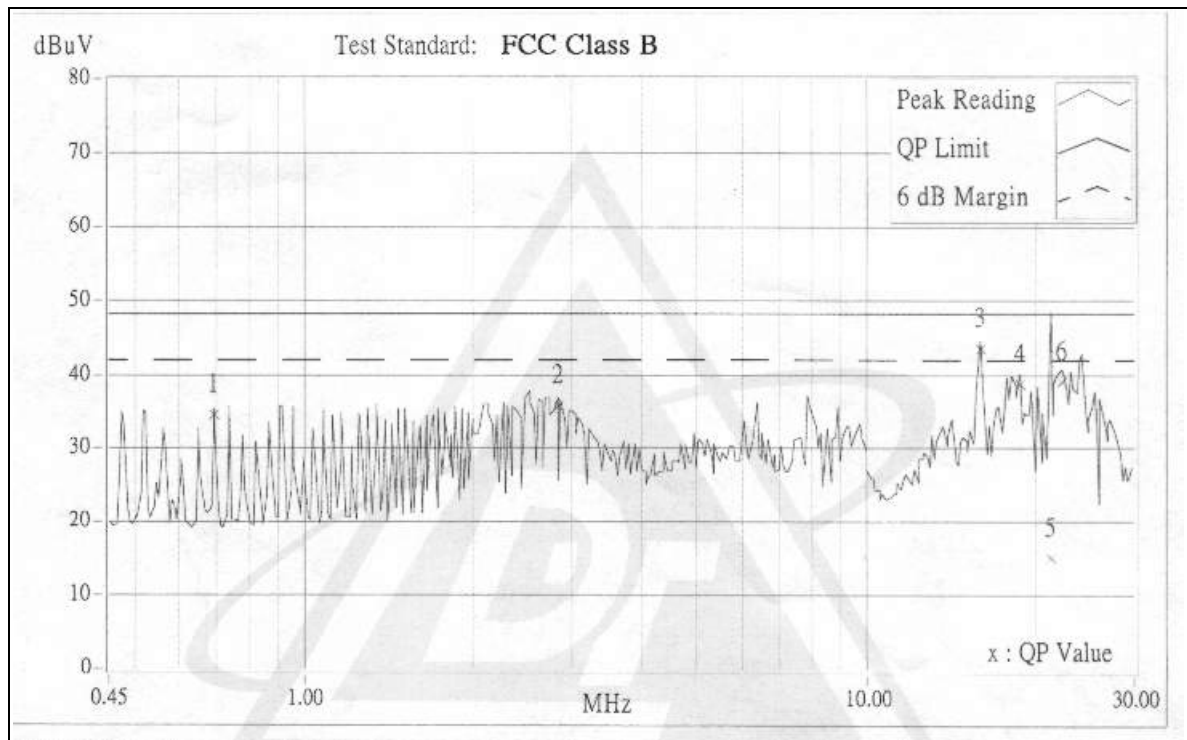

- Remarks:
1. Q.P. and AV. are abbreviations of quasi-peak and average individually.
  2. "-": NA
  3. The emission levels of other frequencies were very low against the limit.
  4. Margin value = Emission level - Limit value
  5. Emission Level = Correction Factor + Reading Value.



<b>EUT</b>	Wireless Access Point	<b>Model</b>	WAP11
<b>Channel</b>	Channel 11	<b>Phase</b>	L
<b>Environmental Conditions</b>	20°C , 60%RH	<b>Tested By</b>	Gary Chang

No	Freq. [MHz]	Corr. Factor (dB)	Reading Value [dB (uV)]		Emission Level [dB (uV)]		Limit [dB (uV)]		Margin (dB)	
			Q.P.	AV.	Q.P.	AV.	Q.P.	AV.	Q.P.	AV.
			1	2.69100	0.27	37.19	---	37.46	---	48.00
2	7.89627	0.59	35.64	---	36.23	---	48.00	---	-11.77	---
3	8.90000	0.65	33.73	---	34.38	---	48.00	---	-13.62	---
4	16.04117	1.02	43.26	---	44.28	---	48.00	---	-3.72	---
5	22.25728	1.24	38.37	---	39.61	---	48.00	---	-8.39	---
6	24.10323	1.35	40.37	---	41.72	---	48.00	---	-6.28	---

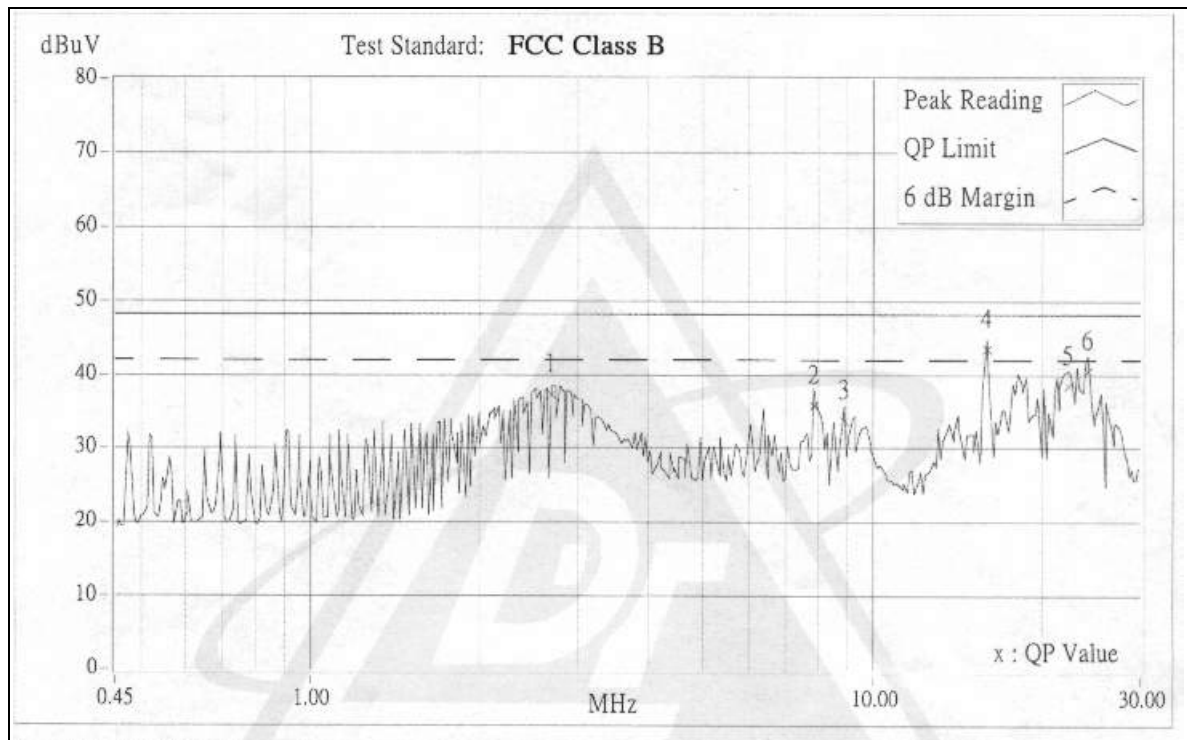

- Remarks:
1. Q.P. and AV. are abbreviations of quasi-peak and average individually.
  2. "-": NA
  3. The emission levels of other frequencies were very low against the limit.
  4. Margin value = Emission level - Limit value
  5. Emission Level = Correction Factor + Reading Value.



<b>EUT</b>	Wireless Access Point	<b>Model</b>	WAP11
<b>Channel</b>	Channel 11	<b>Phase</b>	N
<b>Environmental Conditions</b>	20°C , 60%RH	<b>Tested By</b>	Gary Chang

No	Freq. [MHz]	Corr. Factor (dB)	Reading Value [dB (uV)]		Emission Level [dB (uV)]		Limit [dB (uV)]		Margin (dB)	
			Q.P.	AV.	Q.P.	AV.	Q.P.	AV.	Q.P.	AV.
			1	0.69300	0.20	34.65	---	34.85	---	48.00
2	2.51700	0.25	36.50	---	36.75	---	48.00	---	-11.25	---
3	7.89500	0.53	36.04	---	36.57	---	48.00	---	-11.43	---
4	16.04256	0.92	43.24	---	44.16	---	48.00	---	-3.84	---
5	18.81200	0.98	38.61	---	39.59	---	48.00	---	-8.41	---
6	24.10526	1.25	40.71	---	41.96	---	48.00	---	-6.04	---

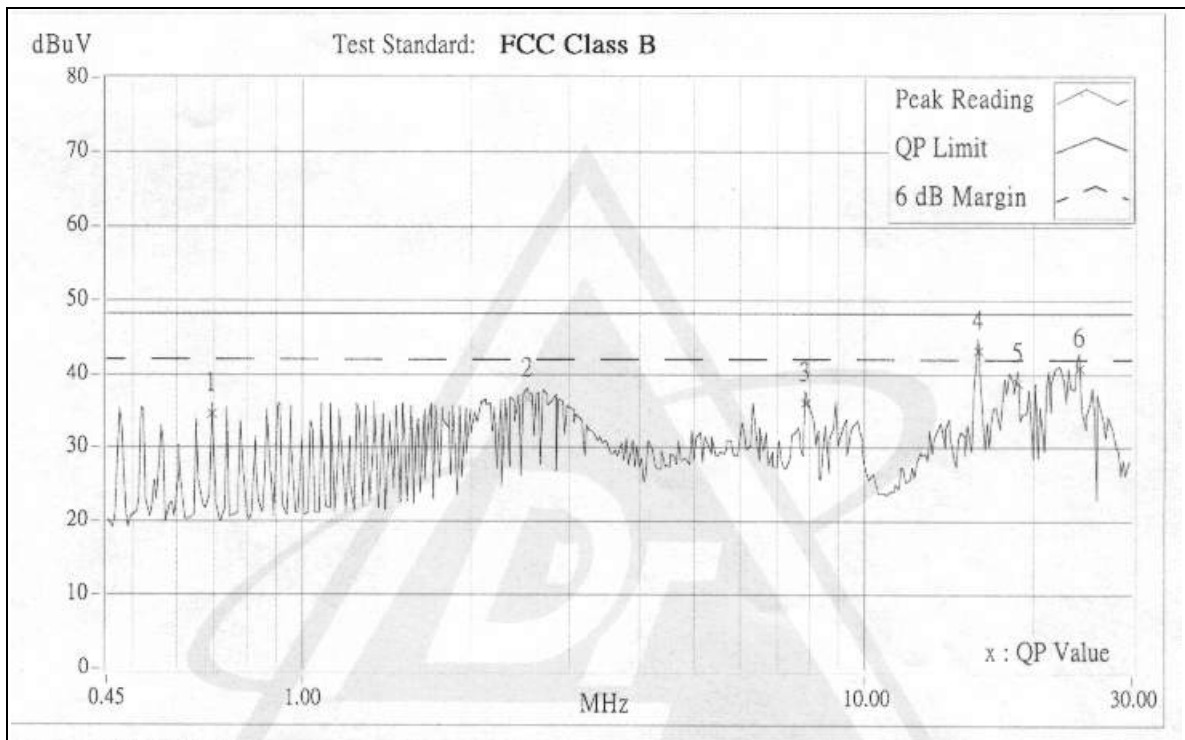

- Remarks:
1. Q.P. and AV. are abbreviations of quasi-peak and average individually.
  2. "-": NA
  3. The emission levels of other frequencies were very low against the limit.
  4. Margin value = Emission level - Limit value
  5. Emission Level = Correction Factor + Reading Value.



## 4.2 RADIATED EMISSION MEASUREMENT

### 4.2.1 LIMITS OF RADIATED EMISSION MEASUREMENT

Field strength limits are at the distance of 3 meters, emissions radiated outside of the specified bands, shall be according to the general radiated limits in 15.209 as following:

Frequencies (MHz)	Field Strength of Fundamental	
	$\mu\text{V}/\text{meter}$	$\text{dB}\mu\text{V}/\text{meter}$
30-88	100	40.0
88-216	150	43.5
216-960	200	46.0
Above 960	500	54.0

As shown in 15.35(b), for frequencies above 1000MHz, the field strength limits are based on average detector, however, the peak field strength of any emission shall not exceed the maximum permitted average limits, specified above by more than 20dB under any condition of modulation.

### LIMIT OF RADIATED EMISSION OF FCC PART 15, SUBPART B FOR FREQUENCY ABOVE 1000 MHz

FREQUENCY (MHz)	Class A (at 10m)		Class B (at 3m)	
	$\mu\text{V}/\text{m}$	$\text{dBuV}/\text{m}$	$\mu\text{V}/\text{m}$	$\text{dBuV}/\text{m}$
Above 1000	300	49.5	500	54.0

- Note:
1. The lower limit shall apply at the transition frequencies.
  2. Emission level ( $\text{dBuV}/\text{m}$ ) =  $20 \log$  Emission level ( $\mu\text{V}/\text{m}$ ).
  3. All emanation from a class A/B digital device or system, including any network of conductors and apparatus connected thereto, shall not exceed the level of field strengths specified above.



#### 4.2.2 TEST INSTRUMENTS

DESCRIPTION & MANUFACTURER	MODEL NO.	SERIAL NO.	CALIBRATED UNTIL
*HP Spectrum Analyzer	8590L	3544A01176	May 7, 2002
*HP Preamplifier	8447D	2944A08485	Nov. 4, 2001
* HP Preamplifier	8449B	3008A01201	Dec. 13, 2001
* ROHDE & SCHWARZ TEST RECEIVER	ESMI	839013/007 839379/002	Jan. 25, 2002
SCHWARZBECK Tunable Dipole Antenna	VHA 9103 UHA 9105	E101051 E101055	Nov. 23, 2001
* CHASE BILOG Antenna	CBL6112A	2221	Aug. 4, 2001
* EMCO Turn Table	1060	1115	NA
* SHOSHIN Tower	AP-4701	A6Y005	NA
* Software	AS61D	NA	NA
* ANRITSU RF Switches	MP59B	M35046	Aug. 4, 2001
* TIMES RF cable	LMR-600	CABLE-ST5-01	Aug. 4, 2001
* Antenna (Horn)	BBHA9120-D	D130	July 10, 2001
Open Field Test Site	Site 5	ADT-R05	July 28, 2001
VCCI Site Registration No.	Site 5	R-1039	NA

#### Notes:

- 1.The measurement uncertainty is less than +/- 2.6dB, which is calculated as per the NAMAS document NIS81.
- 2.The calibration interval of the above test instruments is 12 months. And the calibrations are traceable to NML/ROC and NIST/USA.

### 4.2.3 TEST PROCEDURES

1. The EUT was placed on the turn table 0.8 meter above ground in 3 meter open area test site.
2. Set the resolution bandwidth to 120KHz in the test receiver and select Peak function to scan the frequency below 1 GHz.
3. Shift the interference-receiving antenna located in antenna tower upwards and downwards between 1 and 4 meters above ground and find out the local peak emission on frequency domain.
4. Locate the interference-receiving antenna at the position where the local peak reach the maximum emission.
5. Rotate the turn table and stop at the angle where the measurement device has maximum reading
6. Shift the interference-receiving antenna again to detect the maximum emission of the local peak
7. If the reading of the local peak under Peak function is lower than limit by 6dB, then Quasi Peak detection is not needed and this reading should be recorded. And if it is higher than Peak limit, then the test is fail. Others, switch the receiver to Quasi Peak function, set the resolution bandwidth to 100kHz and repeat the procedures C ~ F. If the reading is lower than limit, this reading should be recorded, otherwise, the test is fail.
8. Set the resolution and video bandwidth of the spectrum analyzer to 1MHz and repeat procedures C ~ F for frequency band from 1 GHz to 10 times carrier frequency.
9. If the reading for the local peak is lower than the Average limit, no further testing is needed in this local peak and this reading should be recorded. If it is higher than Average limit but lower than Peak limit, then set the resolution bandwidth to 1MHz and video bandwidth to 300Hz. Repeat procedures C ~ F. If the maximum reading is lower than Average limit, then this reading should be recorded. If it is higher, then the test is fail.

- Note:
1. The frequency range of verification is either from 30 MHz to 1GHz or from 30 MHz up to 10 times carrier frequency of EUT (whichever is the highest frequency range).
  2. The resolution bandwidth and video bandwidth of test receiver/spectrum analyzer is 120kHz for frequency below 1GHz.
  3. The resolution bandwidth of test receiver/spectrum analyzer is 1 MHz and the video bandwidth is 300 Hz for frequency above 1GHz.

## 4.2.4 TEST SETUP

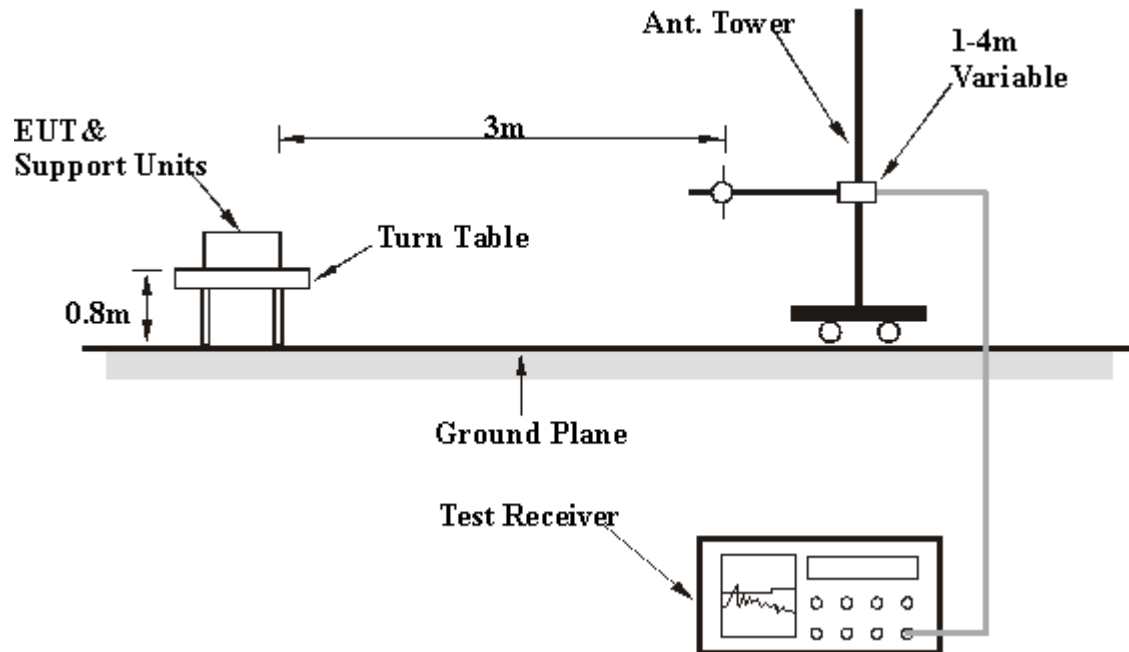

For the actual test configuration, please refer to the related Item in this test report (**Photographs of the Test Configuration**).

## 4.2.5 TEST RESULTS

### Digital Portion

<b>EUT</b>	Wireless Access Point	<b>Model</b>	WAP11
<b>Mode</b>	Channel 11	<b>Detector Function</b>	Quasi-Peak
<b>Frequency Range</b>	30-1000 MHz	<b>Test Distance</b>	3M
<b>Environmental Conditions</b>	20°C, 60%RH	<b>Tested By</b>	Gary Chang

#### ANTENNA POLARITY: VERTICAL

Frequency (MHz)	Correction Factor (dB)	Reading Value (dBuV)	Emission Level (dBuV/m)	Limit (dBuV/m)	Margin (dB)	Antenna Height (cm)	Table Angle (Degree)
160.00	15.29	49.56	34.3	46.0	-9.2	250	301
175.00	15.62	44.14	28.5	46.0	-15.0	100	161
199.99	15.80	50.89	35.1	46.0	-8.4	250	32
319.98	10.71	51.12	40.4	46.0	-5.6	250	75
499.98	6.36	45.59	39.2	46.0	-6.8	282	332
649.76	5.60	37.38	31.8	46.0	-14.2	253	88
660.01	5.39	43.90	38.5	46.0	-7.5	155	267
799.95	3.75	38.04	34.3	46.0	-11.7	137	57

#### ANTENNA POLARITY: HORIZONTAL

Frequency (MHz)	Correction Factor (dB)	Reading Value (dBuV)	Emission Level (dBuV/m)	Limit (dBuV/m)	Margin (dB)	Antenna Height (cm)	Table Angle (Degree)
80.02	18.43	47.47	29.0	46.0	-11.0	100	161
150.00	14.38	48.56	34.2	46.0	-9.3	100	359
159.51	15.15	47.55	32.4	46.0	-11.1	100	-2
174.99	15.62	48.98	33.4	46.0	-10.1	100	3
199.98	15.80	48.49	32.7	46.0	-10.8	104	328
249.98	12.61	46.80	34.2	46.0	-11.8	100	38
299.99	11.37	45.73	34.4	46.0	-11.6	211	354
319.99	10.71	48.74	38.0	46.0	-8.0	100	356
499.97	6.36	44.95	38.6	46.0	-7.4	178	77
699.95	4.54	40.53	36.0	46.0	-10.0	100	350
748.00	3.98	34.33	30.4	46.0	-15.6	216	94
799.93	3.77	37.88	34.1	46.0	-11.9	148	64

- NOTES: 1 Emission level (dBuV/m) = Reading value (dBuV) - Correction Factor (dB).  
 2 Correction Factor (dB) = Ant. Factor (dB)+Cable loss (dB)  
 3 The other emission levels were very low against the limit.  
 4 Margin value = Emission level - Limit value

<b>EUT</b>	Wireless Access Point	<b>Model</b>	WAP11
<b>Mode</b>	Channel 1	<b>Detector Function</b>	Peak, Average
<b>Frequency Range</b>	Above 1000 MHz	<b>Test Distance</b>	3M
<b>Environmental Conditions</b>	20°C, 70%RH	<b>Tested By</b>	Gary Chang

<b>ANTENNA POLARITY: Vertical</b>		<b>Detector Function :</b>				<b>6dB Bandwidth : 1MHz</b>				<b>Frequency Range : Above 1GHz</b>	
Frequency (MHz)	Correction Factor (dB)	Reading Value (dBuV)		Emission Level (dBuV/m)		Limit (dBuV/m)		Margin (dB)		Antenna Height (cm)	Table Angle (Degree)
		P.K.	A.V.	P.K.	A.V.	P.K.	A.V.	P.K.	A.V.		
2037.8	-29.61	17.01	-	46.6	-	74.0	54.0	-27.4	-	100	353
*2412.0	-31.04	78.00	69.00	109.0	100.0	-	-	-	-	100	54
4076.2	-34.79	16.02	-	50.8	-	74.0	54.0	-23.2	-	102	110
4824.0	-35.66	14.52	-	51.1	-	74.0	54.0	-22.9	-	100	14

<b>ANTENNA POLARITY: Horizontal</b>		<b>Detector Function :</b>				<b>6dB Bandwidth:1MHz</b>				<b>Frequency Range: Above 1GHz</b>	
Frequency (MHz)	Correction Factor (dB)	Reading Value (dBuV)		Emission Level (dBuV/m)		Limit (dBuV/m)		Margin (dB)		Antenna Height (cm)	Table Angle (Degree)
		P.K.	A.V.	P.K.	A.V.	P.K.	A.V.	P.K.	A.V.		
2038.6	-29.61	16.25	-	45.9	-	74.0	54.0	-28.1	-	105	47
*2411.9	-31.04	70.44	61.43	101.5	92.5	-	-	-	-	101	5
4076.1	-34.79	16.32	-	51.1	-	74.0	54.0	-22.9	-	103	97
4824.0	-36.55	13.56	-	50.1	-	74.0	54.0	-23.9	-	103	187

- NOTES: 1. Emission level (dBuV/m) = Reading value (dBuV) - Correction Factor (dB).  
2. Correction Factor (dB) = Ant. Factor (dB)+Cable loss (dB)  
3. The other emission levels were very low against the limit.  
4. Margin value = Emission level - Limit value  
5. The limit value is defined as per 15.247  
6. “ \* “ : Fundamental frequency

<b>EUT</b>	Wireless Access Point	<b>Model</b>	WAP11
<b>Mode</b>	Channel 6	<b>Detector Function</b>	Peak, Average
<b>Frequency Range</b>	Above 1000 MHz	<b>Test Distance</b>	3M
<b>Environmental Conditions</b>	23°C, 70%RH	<b>Tested By</b>	Gary Chang

<b>ANTENNA POLARITY: Vertical</b>		<b>Detector Function :</b>				<b>6dB Bandwidth:1MHz</b>				<b>Frequency Range: Above 1GHz</b>	
Frequency (MHz)	Correction Factor (dB)	Reading Value (dBuV)		Emission Level (dBuV/m)		Limit (dBuV/m)		Margin (dB)		Antenna Height (cm)	Table Angle (Degree)
		P.K.	A.V.	P.K.	A.V.	P.K.	A.V.	P.K.	A.V.		
2063.3	-29.69	20.30	-	50.0	-	74.0	54.0	-24.0	-	107	120
*2437.3	-31.16	77.0	70.00	108.2	101.2	-	-	-	-	100	310
4125.8	-34.90	16.09	-	51.0	-	74.0	54.0	-23.0	-	100	296
4874.0	-36.69	12.94	-	49.6	-	74.0	54.0	-24.4	-	104	208

<b>ANTENNA POLARITY: Horizontal</b>		<b>Detector Function :</b>				<b>6dB Bandwidth:1MHz.</b>				<b>Frequency Range: Above 1GHz.</b>	
Frequency (MHz)	Correction Factor (dB)	Reading Value (dBuV)		Emission Level (dBuV/m)		Limit (dBuV/m)		Margin (dB)		Antenna Height (cm)	Table Angle (Degree)
		P.K.	A.V.	P.K.	A.V.	P.K.	A.V.	P.K.	A.V.		
2063.8	-29.69	21.30	-	51.0	-	74.0	54.0	-23.0	-	100	204
*2438.7	-31.16	71.21	63.26	102.4	94.4	-	-	-	-	100	204
4125.8	-34.90	16.60	-	51.5	-	74.0	54.0	-22.5	-	103	163
4874.0	-36.69	12.16	-	48.8	-	74.0	54.0	-25.2	-	105	215

- NOTES: 1. Emission level (dBuV/m) = Reading value (dBuV) - Correction Factor (dB).  
2. Correction Factor (dB) = Ant. Factor (dB)+Cable loss (dB)  
3. The other emission levels were very low against the limit.  
4. Margin value = Emission level - Limit value  
5. The limit value is defined as per 15.247  
6. “ \* “ : Fundamental frequency



<b>EUT</b>	Wireless Network Access Point	<b>Model</b>	WAP11
<b>Mode</b>	Channel 11	<b>Detector Function</b>	Peak, Average
<b>Frequency Range</b>	Above 1000MHz	<b>Test Distance</b>	3M
<b>Environmental Conditions</b>	23°C, 70%RH	<b>Tested By</b>	Steven Lu

<b>ANTENNA POLARITY: Vertical</b>		<b>Detector Function :</b>				<b>6dB Bandwidth:1MHz.</b>				<b>Frequency Range: Above 1GHz</b>	
Frequency (MHz)	Correction Factor (dB)	Reading Value (dBuV)		Emission Level (dBuV/m)		Limit (dBuV/m)		Margin (dB)		Antenna Height (cm)	Table Angle (Degree)
		P.K.	A.V.	P.K.	A.V.	P.K.	A.V.	P.K.	A.V.		
2087.9	-29.81	20.60	-	50.4	-	74.0	54.0	-23.6	-	103	47
*2462.2	-31.24	75.60	68.10	106.8	99.3	-	-	-	-	105	162
4176.9	-35.00	16.75	-	51.7	-	74.0	54.0	-22.3	-	104	223
4924.1	-36.83	13.63	-	50.5	-	74.0	54.0	-23.5	-	100	268

<b>ANTENNA POLARITY: Horizontal</b>		<b>Detector Function :</b>				<b>6dB Bandwidth:1MHz.</b>				<b>Frequency Range: Above 1GHz</b>	
Frequency (MHz)	Correction Factor (dB)	Reading Value (dBuV)		Emission Level (dBuV/m)		Limit (dBuV/m)		Margin (dB)		Antenna Height (cm)	Table Angle (Degree)
		P.K.	A.V.	P.K.	A.V.	P.K.	A.V.	P.K.	A.V.		
2088.2	-29.81	20.90	-	50.7	-	74.0	54.0	-23.3	-	100	66
*2462.8	-31.24	70.95	61.68	102.2	92.9	-	-	-	-	100	155
4176.1	-35.00	14.57	-	49.6	-	74.0	54.0	-24.4	-	100	188
4924.0	-36.83	14.24	-	51.1	-	74.0	54.0	-22.9	-	100	142

- NOTES: 1. Emission level (dBuV/m) = Reading value (dBuV) - Correction Factor (dB)  
 2. Correction Factor (dB) = Ant. Factor (dB)+Cable loss (dB)  
 3. The other emission levels were very low against the limit.  
 4. Margin value = Emission level - Limit value  
 5. The limit value is defined as per 15.247  
 6. “ \* “ : Fundamental frequency





### 4.3 6dB BANDWIDTH MEASUREMENT

#### 4.3.1 LIMITS OF 6dB BANDWIDTH MEASUREMENT

The Limit of 6dB Bandwidth Measurement is 0.5 MHz.

#### 4.3.2 TEST INSTRUMENTS

Description & Manufacturer	Model No.	Serial No.	Calibrated Until
ROHDE & SCHWARZ TEST RECEIVER	ESMI	839379/002	Aug. 04, 2001
HP ATTENUATOR	8496B	3247A18505	Cal. on use
HP PLOTTER	7475A	2641V27755	N/A

Notes:

- 1.The measurement uncertainty is less than +/- 2.6dB, which is calculated as per the NAMAS document NIS81.
- 2.The calibration interval of the above test instruments is 12 months. And the calibrations are traceable to NML/ROC and NIST/USA.

### 4.3.3 TEST PROCEDURE

The transmitter output was connected to the spectrum analyzer through an attenuator. The bandwidth of the fundamental frequency was measured by spectrum analyzer with 100 kHz RBW and 100 kHz VBW. The 6 dB bandwidth is defined as the total spectrum the power of which is higher than peak power minus 6 dB.

### 4.3.4 TEST SETUP

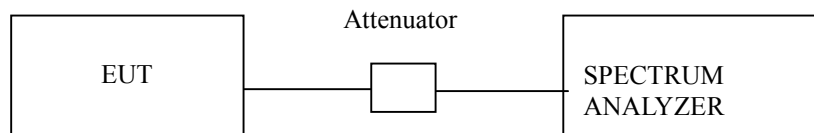

For the actual test configuration, please refer to the related Item – Photographs of the Test Configuration.

### 4.3.5 EUT OPERATING CONDITION

The software provided by client enabled the EUT to transmit and receive data at lowest, middle and highest channel frequencies individually.

## 4.3.6 TEST RESULTS

<b>EUT</b>	Wireless Access Point	<b>Model</b>	WAP11
<b>Environmental Conditions</b>	23°C, 70%RH	<b>Tested By</b>	Gary Chang

<b>CHANNEL</b>	<b>CHANNEL FREQUENCY (MHz)</b>	<b>6 dB BANDWIDTH (MHz)</b>	<b>MINIMUM LIMIT (MHz)</b>	<b>PASS/FAIL</b>
1	2412	10.18	0.5	PASS
6	2437	10.67	0.5	PASS
11	2462	11.04	0.5	PASS



CHI

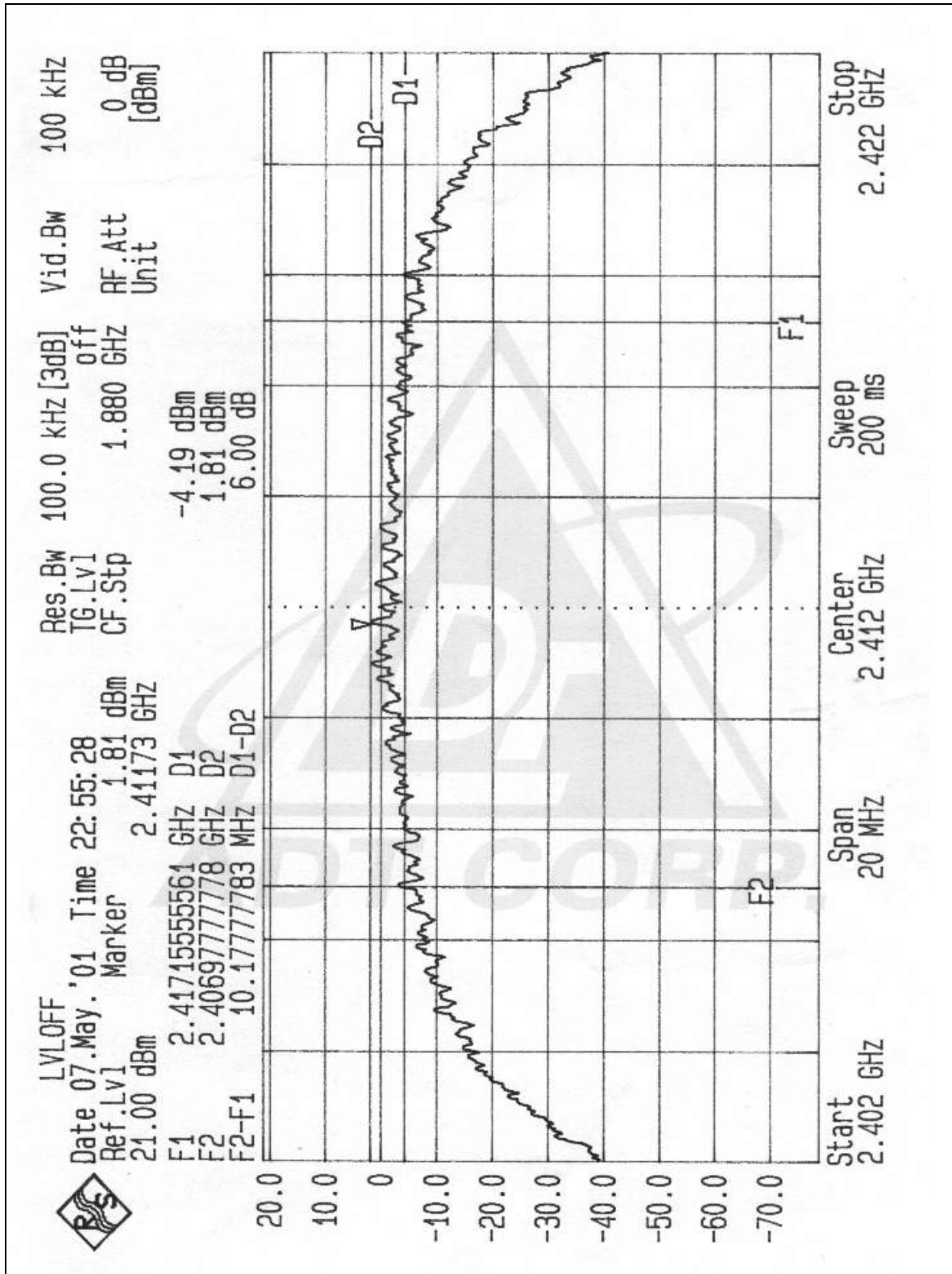



CH6

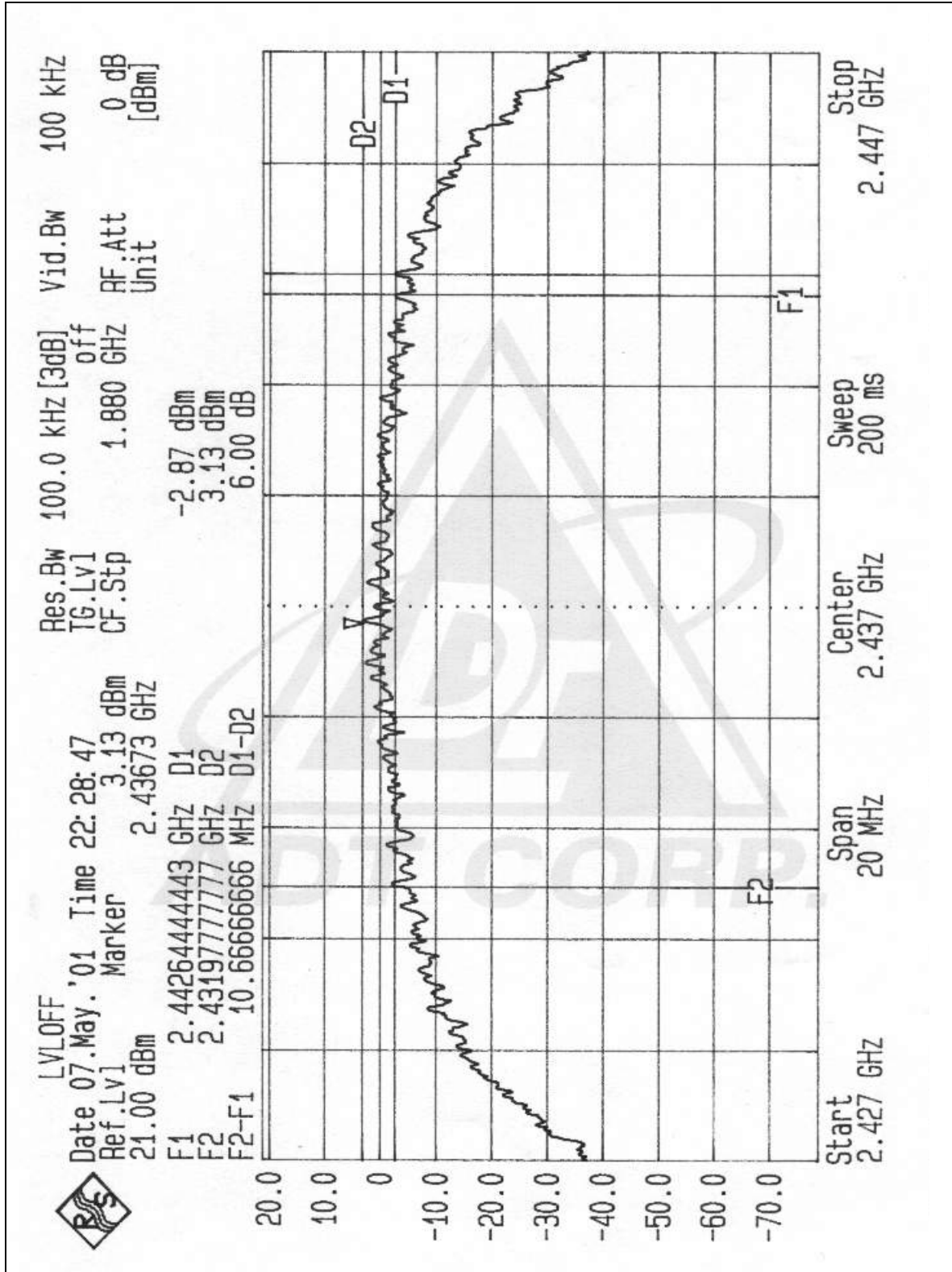



CH11

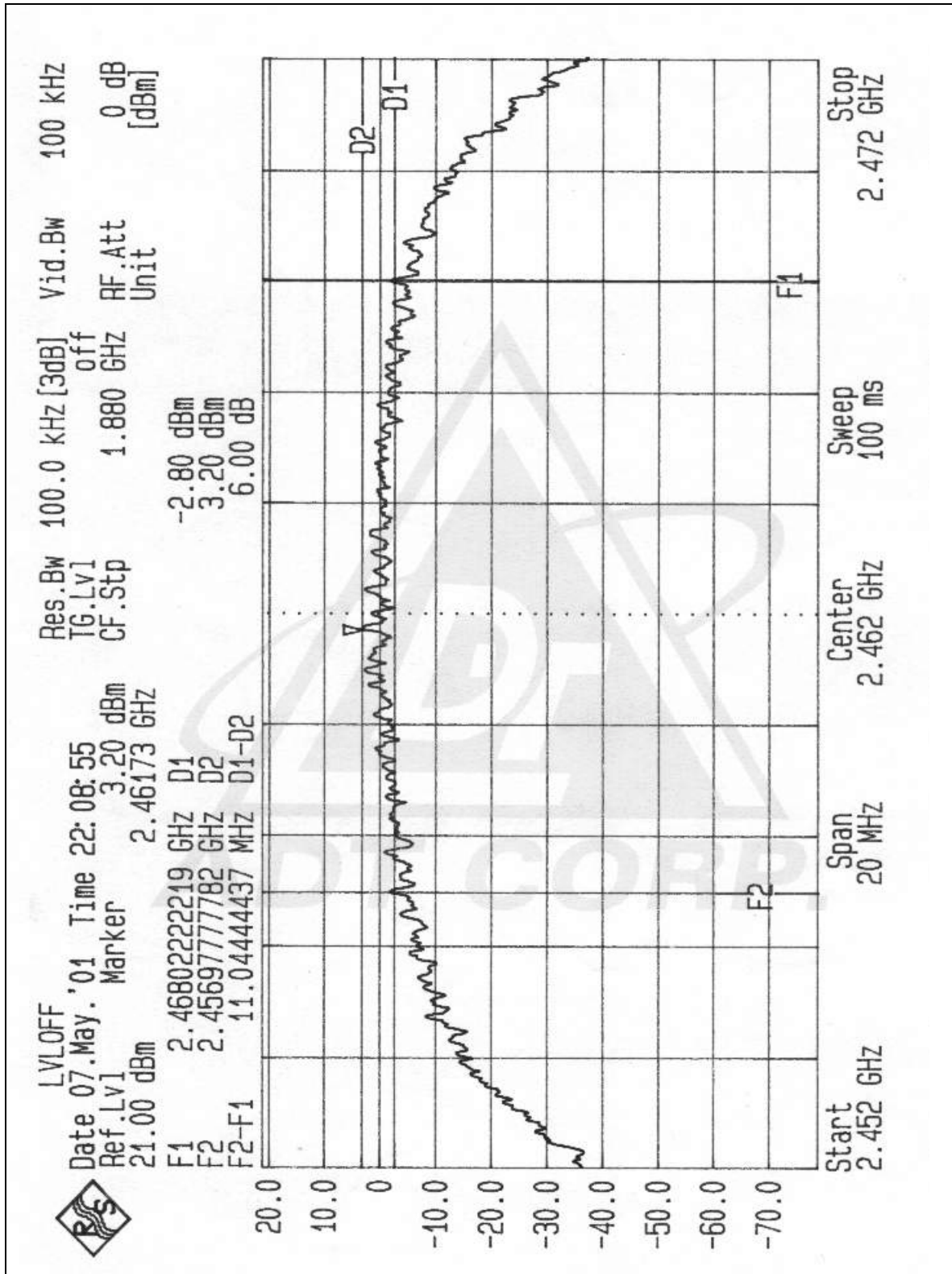

#### 4.4 MAXIMUM PEAK OUTPUT POWER

##### 4.4.1 LIMITS OF MAXIMUM PEAK OUTPUT POWER MEASUREMENT

The Limit of Maximum Peak Output Power Measurement is 30dBm.

##### 4.4.2 INSTRUMENTS

Description & Manufacturer	Model No.	Serial No.	Calibrated Until
ROHDE & SCHWARZ TEST RECEIVER	ESMI	839379/002	Aug. 04, 2001
HP ATTENUATOR	8496B	3247A18505	Cal. on use
HP PLOTTER	7475A	2641V27755	N/A

Notes:

- 1.The measurement uncertainty is less than +/- 2.6dB, which is calculated as per the NAMAS document NIS81.
- 2.The calibration interval of the above test instruments is 12 months. And the calibrations are traceable to NML/ROC and NIST/USA.

#### 4.4.3 TEST PROCEDURES

1. The transmitter output was connected to the spectrum analyzer through an attenuator.
2. The center frequency of the spectrum analyzer is set to the fundamental frequency and using 3 MHz RBW and 3 MHz VBW.
3. The span of the spectrum analyzer should be larger than 6dB BandWidth plus 10MHz.
4. Use Peak Search to read the peak power after Maximum Hold function is activated.
5. Shift the marker to +/- 3MHz and +/-6MHz, and record the reading.
6. The Maximum Peak Output Power is the linear summation of the 5 readings in (4) and (5).

Note: This measurement is the total power of 15MHz bandwidth which is far more wider than 6dB bandwidth.

#### 4.4.4 TEST SETUP

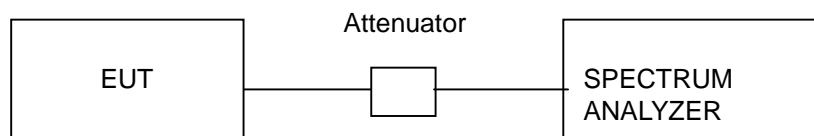

For the actual test configuration, please refer to the related Item – Photographs of the Test Configuration.

#### 4.4.5 EUT OPERATING CONDITION

The software provided by client enabled the EUT to transmit and receive data at lowest, middle and highest channel frequencies individually.



## 4.4.6 TEST RESULTS

Output Power Into Antenna:

<b>EUT</b>	Wireless Access Point	<b>Model</b>	WAP11
<b>Environmental Conditions</b>	20°C , 60%RH	<b>Tested By</b>	Gary Chang

CHANNEL	CHANNEL FREQUENCY (MHz)	PEAK POWER OUTPUT (dBm)	PEAK POWER LIMIT (dBm)	PASS/FAIL
1	2412	17.18	30	PASS
6	2437	16.75	30	PASS
11	2462	16.55	30	PASS