



FCC TEST REPORT

REPORT NO.: RF931230L03

MODEL NO.: WL VP 2454 26A0 (Refer to page 6 for other models)

RECEIVED: Dec. 16, 2004

TESTED: Dec. 16, 2004 ~ Jan. 04, 2005

ISSUED: Feb. 14, 2005

APPLICANT: GLOBAL SUN TECHNOLOGY INC.

ADDRESS: No.281, Sinhu 3rd Rd., Neihu District, Taipei
City 114, Taiwan (R.O.C.)

ISSUED BY: Advance Data Technology Corporation

LAB ADDRESS: No. 47, 14th Ling, Chia Pau Tsuen, Lin Kou
Hsiang 244, Taipei Hsien, Taiwan, R.O.C.

TEST LOCATION: No. 19, Hwa Ya 2nd Rd., Wen Hwa Tsuen, Kwei
Shan Hsiang, Taoyuan Hsien 333, Taiwan,
R.O.C.

This test report consists of 72 pages in total. It may be duplicated completely for legal use with the approval of the applicant. It should not be reproduced except in full, without the written approval of our laboratory. The client should not use it to claim product endorsement by CNLA, A2LA or any government agencies. The test results in the report only apply to the tested sample.



0528
ILAC MRA



No. 2177-01



Table of Contents

1.	CERTIFICATION	4
2.	SUMMARY OF TEST RESULTS	5
2.1	MEASUREMENT UNCERTAINTY	5
3.	GENERAL INFORMATION.....	6
3.1	GENERAL DESCRIPTION OF EUT	6
3.2	DESCRIPTION OF TEST MODES.....	7
3.2.1	CONFIGURATION OF SYSTEM UNDER TEST	7
3.2.2	TEST MODE APPLICABILITY AND TESTED CHANNEL DETAIL:	8
3.3	GENERAL DESCRIPTION OF APPLIED STANDARDS	10
3.4	DESCRIPTION OF SUPPORT UNITS	10
4.	TEST TYPES AND RESULTS	11
4.1	CONDUCTED EMISSION MEASUREMENT	11
4.1.1	LIMITS OF CONDUCTED EMISSION MEASUREMENT.....	11
4.1.2	TEST INSTRUMENTS.....	11
4.1.3	TEST PROCEDURES	12
4.1.4	DEVIATION FROM TEST STANDARD	12
4.1.5	TEST SETUP	13
4.1.6	EUT OPERATING CONDITIONS	13
4.1.7	TEST RESULTS	14
4.2	RADIATED EMISSION MEASUREMENT	20
4.2.1	LIMITS OF RADIATED EMISSION MEASUREMENT.....	20
4.2.2	TEST INSTRUMENTS.....	21
4.2.3	TEST PROCEDURES	22
4.2.4	DEVIATION FROM TEST STANDARD	22
4.2.5	TEST SETUP	23
4.2.6	EUT OPERATING CONDITIONS	23
4.2.7	TEST RESULTS	24
4.3	6dB BANDWIDTH MEASUREMENT	32
4.3.1	LIMITS OF 6DB BANDWIDTH MEASUREMENT	32
4.3.2	TEST INSTRUMENTS.....	32
4.3.3	TEST PROCEDURE.....	33
4.3.4	DEVIATION FROM TEST STANDARD	33
4.3.5	TEST SETUP	33
4.3.6	EUT OPERATING CONDITIONS	33
4.3.7	TEST RESULTS	34
4.4	MAXIMUM PEAK OUTPUT POWER	42
4.4.1	LIMITS OF MAXIMUM PEAK OUTPUT POWER MEASUREMENT	42



4.4.2	INSTRUMENTS.....	42
4.4.1	TEST PROCEDURES	43
4.4.2	DEVIATION FROM TEST STANDARD	43
4.4.3	TEST SETUP	43
4.4.4	EUT OPERATING CONDITIONS	43
4.4.3	TEST RESULTS	44
4.5	POWER SPECTRAL DENSITY MEASUREMENT	46
4.5.1	LIMITS OF POWER SPECTRAL DENSITY MEASUREMENT	46
4.5.2	TEST INSTRUMENTS.....	46
4.5.3	TEST PROCEDURE.....	47
4.5.4	DEVIATION FROM TEST STANDARD	47
4.5.5	TEST SETUP	47
4.5.6	EUT OPERATING CONDITION	47
4.5.7	TEST RESULTS	48
4.6	BAND EDGES MEASUREMENT	56
4.6.1	LIMITS OF BAND EDGES MEASUREMENT	56
4.6.2	TEST INSTRUMENTS.....	56
4.6.3	TEST PROCEDURE.....	56
4.6.4	DEVIATION FROM TEST STANDARD	56
4.6.5	EUT OPERATING CONDITION	56
4.6.6	TEST RESULTS	57
4.6.7	TEST RESULTS	57
4.7	ANTENNA REQUIREMENT	69
4.7.1	STANDARD APPLICABLE	69
4.7.2	ANTENNA CONNECTED CONSTRUCTION	69
5.	PHOTOGRAPHS OF THE TEST CONFIGURATION.....	70
6.	INFORMATION ON THE TESTING LABORATORIES	72



1. CERTIFICATION

PRODUCT: 802.11g Wireless PCI Adapter
BRAND NAME: GLOBAL SUN (Refer to page 6 for other brands)
MODEL NO.: WL VP 2454 26A0 (Refer to page 6 for other models)
TEST SAMPLE: ENGINEERING SAMPLE
TESTED: Dec. 16, 2004 ~ Jan. 04, 2005
APPLICANT: GLOBAL SUN Technology Co., Ltd.
STANDARDS: FCC Part 15, Subpart C (Section 15.247),
ANSI C63.4-2003

The above equipment (Model: WL VP 2454 26A0) have been tested by **Advance Data Technology Corporation**, and found compliance with the requirement of the above standards. The test record, data evaluation & Equipment Under Test (EUT) configurations represented herein are true and accurate accounts of the measurements of the sample's EMC characteristics under the conditions specified in this report.

PREPARED BY : Kerry Lee , **DATE:** Feb. 14, 2005
(Kerry Lee)

TECHNICAL ACCEPTANCE : Gary Chang , **DATE:** Feb. 14, 2005
Responsible for
RF
(Gary Chang)

APPROVED BY : Cody Chang , **DATE:** Feb. 14, 2005
(Cody Chang, Deputy Manager)

2. SUMMARY OF TEST RESULTS

The EUT has been tested according to the following specifications:

APPLIED STANDARD: FCC Part 15, Subpart C			
Standard Section	Test Type and Limit	Result	Remark
15.207	AC Power Conducted Emission	PASS	Meet the requirement of limit. Minimum passing margin is -17.04dB at 0.634MHz
15.247(a)(2)	Spectrum Bandwidth of a Direct Sequence Spread Spectrum System Limit: min. 500kHz	PASS	Meet the requirement of limit.
15.247(b)	Maximum Peak Output Power Limit: max. 30dBm	PASS	Meet the requirement of limit.
15.247(d)	Radiated Emissions Limit: Table 15.209	PASS	Meet the requirement of limit. Minimum passing margin is -1.56dB at 2483.50MHz
15.247(e)	Power Spectral Density Limit: max. 8dBm	PASS	Meet the requirement of limit.
15.247(d)	Band Edge Measurement Limit: 20dB less than the peak value of fundamental frequency	PASS	Meet the requirement of limit.

2.1 MEASUREMENT UNCERTAINTY

Where relevant, the following measurement uncertainty levels have been estimated for tests performed on the EUT as specified in CISPR 16-4:

Measurement	Frequency	Uncertainty
Conducted emissions	9kHz~30MHz	2.44 dB
Radiated emissions	30MHz ~ 200MHz	3.73 dB
	200MHz ~ 1000MHz	3.74 dB
	1GHz ~ 18GHz	2.20 dB
	18GHz ~ 40GHz	1.88 dB



3. GENERAL INFORMATION

3.1 GENERAL DESCRIPTION OF EUT

EUT	802.11g Wireless PCI Adapter
MODEL NO.	WL VP 2454 26A0 (refer as below for other models)
POWER SUPPLY	3.3Vdc from host equipment
MODULATION TYPE	CCK, DQPSK, DBPSK for DSSS 64QAM, 16QAM, QPSK, BPSK for OFDM
RADIO TECHNOLOGY	DSSS, OFDM
TRANSFER RATE	802.11b: 11/5.5/2/1Mbps 802.11g: 54/48/36/24/18/12/9/6Mbps (Turbo mode: up to 108Mbps *see Note 2)
FREQUENCY RANGE	2412MHz ~ 2462MHz
NUMBER OF CHANNEL	11
OUTPUT POWER	51.523mW
ANTENNA TYPE	Dipole antenna with 2.0dBi gain
DATA CABLE	NA
I/O PORTS	NA
ASSOCIATED DEVICES	NA

NOTE:

1. The EUT operates in the 2.4GHz frequency spectrum with throughput of up to 54Mbps.
2. This EUT is capable of providing data rates of up to 108Mbps in 802.11g Turbo Mode depending upon reception quality.
3. The EUT complies with IEEE 802.11g standards and backwards compatible with IEEE 802.11b products.
4. The following models are provided to this EUT and identical to each other except for their models and brands due to marketing requirement.

Brand	Model No.	Remark
TRUST	SPEEDSHARE TURBO PRO WIRELESS PCI ADAPTER	OEM
	NW-3600 108Mbps Wireless Network PCI Card	OEM
Level One	WNC-0300	OEM
TOPCOM	Skvr@cer Pro PCI 154	OEM
Kcorp	KLG-530	OEM
Niposom	LAN108GPCI	OEM
Atlantis	A02-WP-54G	OEM
Crypto	WP 100E	OEM
PLANET	WL-8310	OEM
ROPER	RO80211GA-PCI	OEM
Dynamode	WL-GI-600XAPLUS	OEM
	DW600GT	OEM
X-Micro	XWL-11GCAG	OEM

5. The above EUT information was declared by manufacturer and for more detailed features description, please refer to the manufacturer's specifications or User's Manual.



3.2 DESCRIPTION OF TEST MODES

Eleven channels are provided to this EUT.

Channel	Frequency	Channel	Frequency
1	2412 MHz	7	2442 MHz
2	2417 MHz	8	2447 MHz
3	2422 MHz	9	2452 MHz
4	2427 MHz	10	2457 MHz
5	2432 MHz	11	2462 MHz
6	2437 MHz		

3.2.1 CONFIGURATION OF SYSTEM UNDER TEST

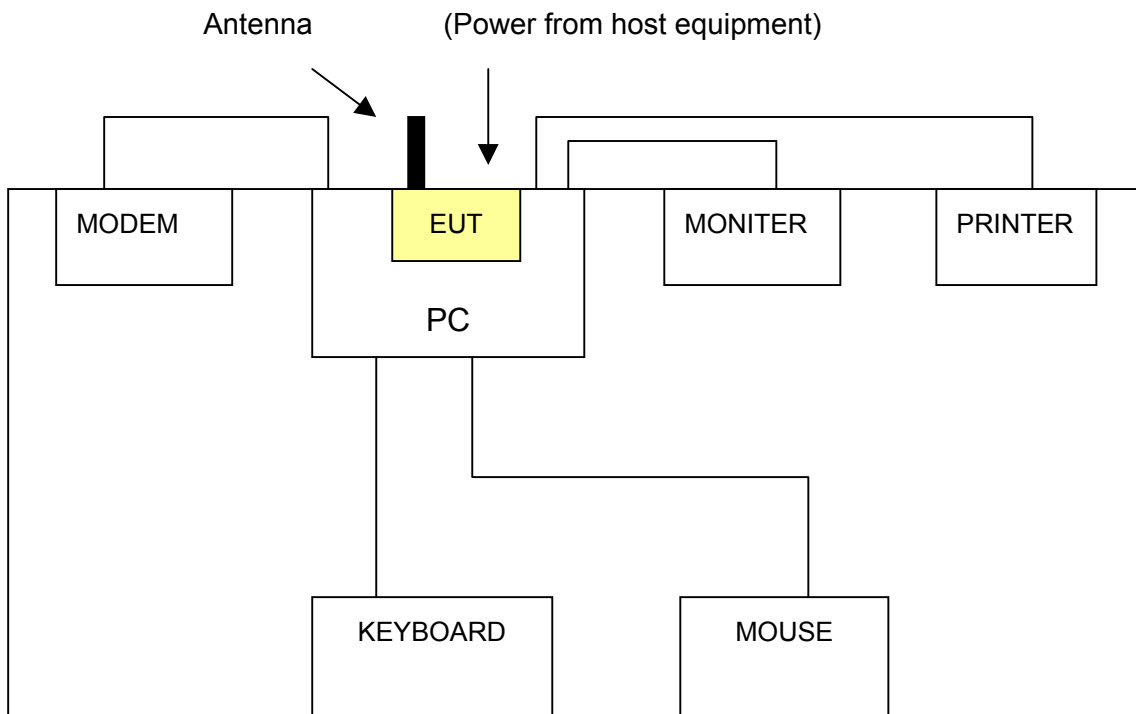



3.2.2 TEST MODE APPLICABILITY AND TESTED CHANNEL DETAIL:

EUT configure mode	Applicable to				Description
	PLC	RE<1G	RE≥1G	APCM	
-	X	X	X	X	NA

Where PLC: Power Line Conducted Emission RE<1G RE: Radiated Emission below 1GHz
 RE≥1G: Radiated Emission above 1GHz APCM: Antenna Port Conducted Measurement

Power Line Conducted Emission Test:

- Pre-Scan has been conducted to determine the worst-case mode from all possible combinations between available modulations, data rates and antenna ports (if EUT with antenna diversity architecture).
- Following channel(s) was (were) selected for the final test as listed below.

Mode	Available Channel	Tested Channel	Modulation Technology	Modulation Type	Data Rate (Mbps)
802.11g	1 to 11	1, 6, 11	OFDM	BPSK	6

Radiated Emission Test (Below 1 GHz):

- Pre-Scan has been conducted to determine the worst-case mode from all possible combinations between available modulations, data rates and antenna ports (if EUT with antenna diversity architecture).
- Following channel(s) was (were) selected for the final test as listed below.

Mode	Available Channel	Tested Channel	Modulation Technology	Modulation Type	Data Rate (Mbps)
802.11g	1 to 11	1	OFDM	BPSK	6

Radiated Emission Test (Above 1 GHz):

- Pre-Scan has been conducted to determine the worst-case mode from all possible combinations between available modulations, data rates and antenna ports (if EUT with antenna diversity architecture).
- Following channel(s) was (were) selected for the final test as listed below.

Mode	Available Channel	Tested Channel	Modulation Technology	Modulation Type	Data Rate (Mbps)
802.11b	1 to 11	1, 6, 11	DSSS	CCK	11
802.11g	1 to 11	1, 6, 11	OFDM	BPSK	6
802.11g Turbo	6	6	OFDM	BPSK	12



Bandedge Measurement:

- Pre-Scan has been conducted to determine the worst-case mode from all possible combinations between available modulations, data rates and antenna ports (if EUT with antenna diversity architecture).
- Following channel(s) was (were) selected for the final test as listed below.

Mode	Available Channel	Tested Channel	Modulation Technology	Modulation Type	Data Rate (Mbps)
802.11b	1 to 11	1, 11	DSSS	CCK	11
802.11g	1 to 11	1, 11	OFDM	BPSK	6
802.11g Turbo	6	6	OFDM	BPSK	12

Antenna Port Conducted Measurement:

- Pre-Scan has been conducted to determine the worst-case mode from all possible combinations between available modulations, data rates and antenna ports (if EUT with antenna diversity architecture).
- Following channel(s) was (were) selected for the final test as listed below.

Mode	Available Channel	Tested Channel	Modulation Technology	Modulation Type	Data Rate (Mbps)
802.11b	1 to 11	1, 6, 11	DSSS	CCK	11
802.11g	1 to 11	1, 6, 11	OFDM	BPSK	6
802.11g Turbo	6	6	OFDM	BPSK	12



3.3 GENERAL DESCRIPTION OF APPLIED STANDARDS

The EUT is a 802.11g Wireless PCI Adapter. According to the specifications of the manufacturer, it must comply with the requirements of the following standards:

FCC Part 15, Subpart C. (15.247)

ANSI C63.4- 2003

All test items have been performed and recorded as per the above standards.

NOTE: The EUT is also considered as a kind of computer peripheral, because the connection to computer is necessary for typical use. It has been verified to comply with the requirements of FCC Part 15, Subpart B, Class B (DoC). The test report has been issued separately.

3.4 DESCRIPTION OF SUPPORT UNITS

The EUT has been tested as an independent unit together with other necessary accessories or support units. The following support units or accessories were used to form a representative test configuration during the tests.

NO.	PRODUCT	BRAND	MODEL NO.	SERIAL NO.	FCC ID
1	PC	MSI	Hetis 865G Giga	3AS0119572	FCC DoC Approved
2	LCD MONITOR	COMPAQ	FP 5315	CNN3480KP2	FCC DoC Approved
3	PRINTER	EPSON	LQ-300+	DCGY054147	FCC DoC Approved
4	MODEM	ACEEX	1414V/3	0401008269	IFAXDM1414
5	KEYBOARD	HP	SK-1688	C0306114659	GYUR84SK
6	MOUSE	HP	M-S69	M4-010565	INZ211443

NO.	SIGNAL CABLE DESCRIPTION OF THE ABOVE SUPPORT UNITS
1	NA
2	1.8 shielded cable without core
3	1.2 shielded cable without core
4	1.2 shielded cable without core
5	1.3 shielded cable without core
6	1.8 shielded cable without core

NOTE: 1. All power cords of the above support units are non-shielded (1.8m).



4. TEST TYPES AND RESULTS

4.1 CONDUCTED EMISSION MEASUREMENT

4.1.1 LIMITS OF CONDUCTED EMISSION MEASUREMENT

FREQUENCY OF EMISSION (MHz)	CONDUCTED LIMIT (dB μ V)	
	Quasi-peak	Average
0.15-0.5	66 to 56	56 to 46
0.5-5	56	46
5-30	60	50

- NOTE:**
1. The lower limit shall apply at the transition frequencies.
 2. The limit decreases in line with the logarithm of the frequency in the range of 0.15 to 0.50 MHz.
 3. All emanations from a class A/B digital device or system, including any network of conductors and apparatus connected thereto, shall not exceed the level of field strengths specified above.

4.1.2 TEST INSTRUMENTS

DESCRIPTION & MANUFACTURER	MODEL NO.	SERIAL NO.	CALIBRATED UNTIL
Test Receiver ROHDE & SCHWARZ	ESCS30	100288	Nov. 06, 2005
RF signal cable Woken	5D-FB	Cable-HyC02-01	Mar. 07, 2005
LISN ROHDE & SCHWARZ	ESH2-Z5	100100	Mar. 10, 2005
LISN ROHDE & SCHWARZ	ESH3-Z5	100311	Mar. 04, 2005
Software ADT	ADT_Cond_V3	NA	NA

- NOTE:**
1. The calibration interval of the above test instruments is 12 months and the calibrations are traceable to NML/ROC and NIST/USA.
 2. The test was performed in HwaYa Shielded Room 2.
 3. The VCCI Site Registration No. is C-2047.



4.1.3 TEST PROCEDURES

- a. The EUT was placed 0.4 meters from the conducting wall of the shielded room with EUT being connected to the power mains through a line impedance stabilization network (LISN). Other support units were connected to the power mains through another LISN. The two LISNs provide 50 ohm/ 50uH of coupling impedance for the measuring instrument.
- b. Both lines of the power mains connected to the EUT were checked for maximum conducted interference.
- c. The frequency range from 150kHz to 30MHz was searched. Emission levels under (Limit - 20dB) was not recorded.

4.1.4 DEVIATION FROM TEST STANDARD

No deviation

4.1.5 TEST SETUP

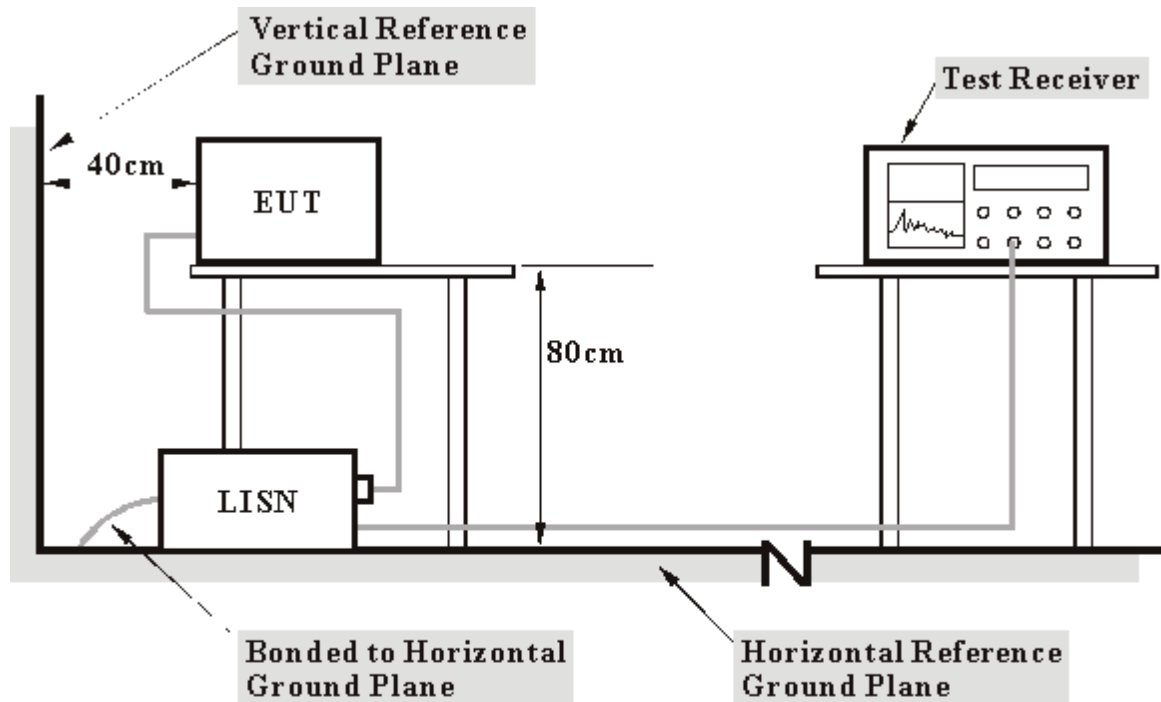

- Note:**
1. Support units were connected to second LISN.
 2. Both of LISNs (AMN) 80 cm from EUT and at the least 80 cm from other units and other metal planes support units.

For the actual test configuration, please refer to the related item – Photographs of the Test Configuration.

4.1.6 EUT OPERATING CONDITIONS

- a. Connected the EUT into a computer system placed on a testing table.
- b. The computer system ran a test program (provided by manufacturer) to enable EUT under transmission/receiving condition continuously at specific channel frequency.
- c. The notebook system sent "H" messages to its screen.
- d. The notebook system sent "H" messages to modem.
- e. The notebook system sent "H" messages to printer, and the printer printed them on paper.
- f. Steps c ~ e were repeated.



4.1.7 TEST RESULTS

Conducted Worst-Case Data

EUT	802.11g Wireless PCI Adapter	MODEL	WL VP 2454 26A0
CHANNEL	Channel 1	6dB BANDWIDTH	9 kHz
MODULATION TYPE	BPSK	TRANSFER RATE	6Mbps
INPUT POWER (SYSTEM)	120Vac, 60 Hz	PHASE	Line (L)
ENVIRONMENTAL CONDITIONS	24deg. C, 64%RH, 991hPa	TESTED BY	Leo Hung

No	Freq. [MHz]	Corr. Factor (dB)	Reading Value [dB (uV)]		Emission Level [dB (uV)]		Limit [dB (uV)]		Margin (dB)	
			Q.P.	AV.	Q.P.	AV.	Q.P.	AV.	Q.P.	AV.
			1	0.177	0.11	42.93	-	43.04	-	64.61
2	0.220	0.12	43.08	-	43.20	-	62.81	52.81	-19.61	-
3	0.248	0.12	35.08	-	35.20	-	61.84	51.84	-26.63	-
4	0.341	0.12	31.20	-	31.32	-	59.17	49.17	-27.84	-
5	1.914	0.16	29.22	-	29.38	-	56.00	46.00	-26.62	-
6	10.184	0.32	33.04	-	33.36	-	60.00	50.00	-26.64	-

- REMARKS:**
1. Q.P. and AV. are abbreviations of quasi-peak and average individually.
 2. "-": The Quasi-peak reading value also meets average limit and measurement with the average detector is unnecessary.
 3. The emission levels of other frequencies were very low against the limit.
 4. Margin value = Emission level - Limit value
 5. Correction factor = Insertion loss + Cable loss
 6. Emission Level = Correction Factor + Reading Value.

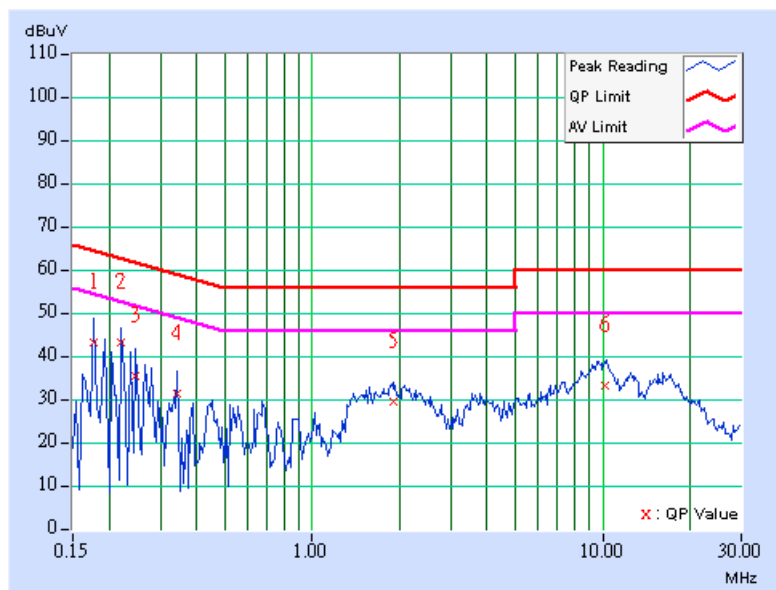



EUT	802.11g Wireless PCI Adapter	MODEL	WL VP 2454 26A0
CHANNEL	Channel 1	6dB BANDWIDTH	9 kHz
MODULATION TYPE	BPSK	TRANSFER RATE	6Mbps
INPUT POWER (SYSTEM)	120Vac, 60 Hz	PHASE	Neutral (N)
ENVIRONMENTAL CONDITIONS	24deg. C, 64%RH, 991hPa	TESTED BY	Leo Hung

No	Freq. [MHz]	Corr. Factor (dB)	Reading Value [dB (uV)]		Emission Level [dB (uV)]		Limit [dB (uV)]		Margin (dB)	
			Q.P.	AV.	Q.P.	AV.	Q.P.	AV.	Q.P.	AV.
			1	0.189	0.10	44.13	-	44.23	-	64.08
2	0.380	0.11	39.19	-	39.30	-	58.27	48.27	-18.97	-
3	0.880	0.21	33.64	-	33.85	-	56.00	46.00	-22.15	-
4	1.703	0.25	32.48	-	32.73	-	56.00	46.00	-23.27	-
5	3.531	0.29	31.39	-	31.68	-	56.00	46.00	-24.32	-
6	9.648	0.48	31.56	-	32.04	-	60.00	50.00	-27.96	-

- REMARKS:**
1. Q.P. and AV. are abbreviations of quasi-peak and average individually.
 2. "-": The Quasi-peak reading value also meets average limit and measurement with the average detector is unnecessary.
 3. The emission levels of other frequencies were very low against the limit.
 4. Margin value = Emission level - Limit value
 5. Correction factor = Insertion loss + Cable loss
 6. Emission Level = Correction Factor + Reading Value.

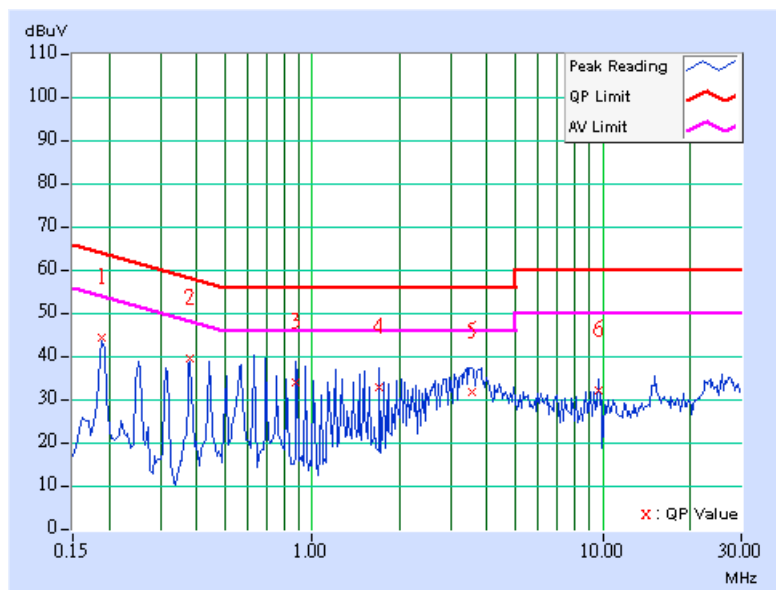



EUT	802.11g Wireless PCI Adapter	MODEL	WL VP 2454 26A0
CHANNEL	Channel 6	6dB BANDWIDTH	9 kHz
MODULATION TYPE	BPSK	TRANSFER RATE	6Mbps
INPUT POWER (SYSTEM)	120Vac, 60 Hz	PHASE	Line (L)
ENVIRONMENTAL CONDITIONS	24deg. C, 64%RH, 991hPa	TESTED BY	Leo Hung

No	Freq. [MHz]	Corr. Factor (dB)	Reading Value [dB (uV)]		Emission Level [dB (uV)]		Limit [dB (uV)]		Margin (dB)	
			Q.P.	AV.	Q.P.	AV.	Q.P.	AV.	Q.P.	AV.
			1	0.158	0.11	36.65	-	36.76	-	65.58
2	0.177	0.11	42.10	-	42.21	-	64.61	54.61	-22.40	-
3	0.216	0.12	43.08	-	43.20	-	62.96	52.96	-19.76	-
4	1.930	0.16	29.17	-	29.33	-	56.00	46.00	-26.67	-
5	10.285	0.33	32.97	-	33.30	-	60.00	50.00	-26.70	-
6	16.266	0.84	28.86	-	29.70	-	60.00	50.00	-30.30	-

- REMARKS:**
1. Q.P. and AV. are abbreviations of quasi-peak and average individually.
 2. "-": The Quasi-peak reading value also meets average limit and measurement with the average detector is unnecessary.
 3. The emission levels of other frequencies were very low against the limit.
 4. Margin value = Emission level - Limit value
 5. Correction factor = Insertion loss + Cable loss
 6. Emission Level = Correction Factor + Reading Value.

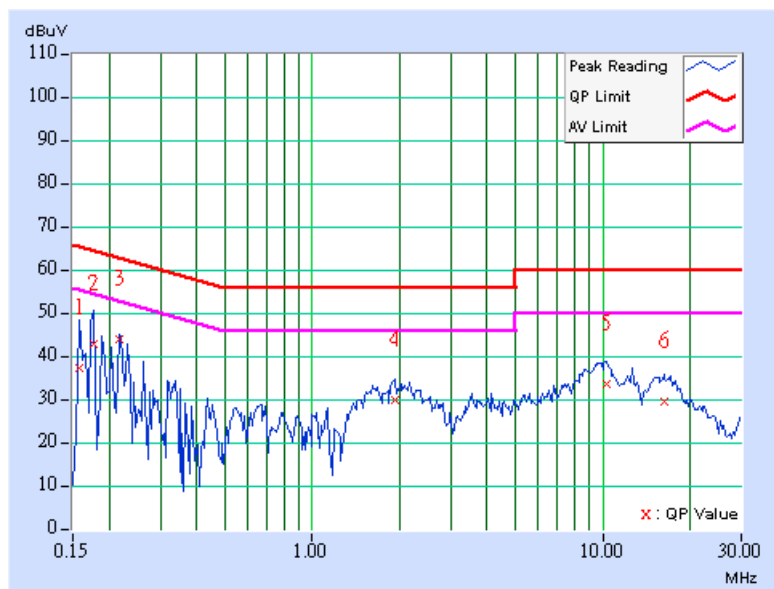



EUT	802.11g Wireless PCI Adapter	MODEL	WL VP 2454 26A0
CHANNEL	Channel 6	6dB BANDWIDTH	9 kHz
MODULATION TYPE	BPSK	TRANSFER RATE	6Mbps
INPUT POWER (SYSTEM)	120Vac, 60 Hz	PHASE	Neutral (N)
ENVIRONMENTAL CONDITIONS	24deg. C, 64%RH, 991hPa	TESTED BY	Leo Hung

No	Freq. [MHz]	Corr. Factor (dB)	Reading Value [dB (uV)]		Emission Level [dB (uV)]		Limit [dB (uV)]		Margin (dB)	
			Q.P.	AV.	Q.P.	AV.	Q.P.	AV.	Q.P.	AV.
			1	0.189	0.10	43.87	-	43.97	-	64.08
2	0.380	0.11	39.44	-	39.55	-	58.27	48.27	-18.72	-
3	0.951	0.23	38.10	-	38.33	-	56.00	46.00	-17.67	-
4	1.203	0.24	37.90	-	38.14	-	56.00	46.00	-17.86	-
5	3.484	0.29	35.16	-	35.45	-	56.00	46.00	-20.55	-
6	15.070	0.56	33.84	-	34.40	-	60.00	50.00	-25.60	-

- REMARKS:**
1. Q.P. and AV. are abbreviations of quasi-peak and average individually.
 2. "-": The Quasi-peak reading value also meets average limit and measurement with the average detector is unnecessary.
 3. The emission levels of other frequencies were very low against the limit.
 4. Margin value = Emission level - Limit value
 5. Correction factor = Insertion loss + Cable loss
 6. Emission Level = Correction Factor + Reading Value.

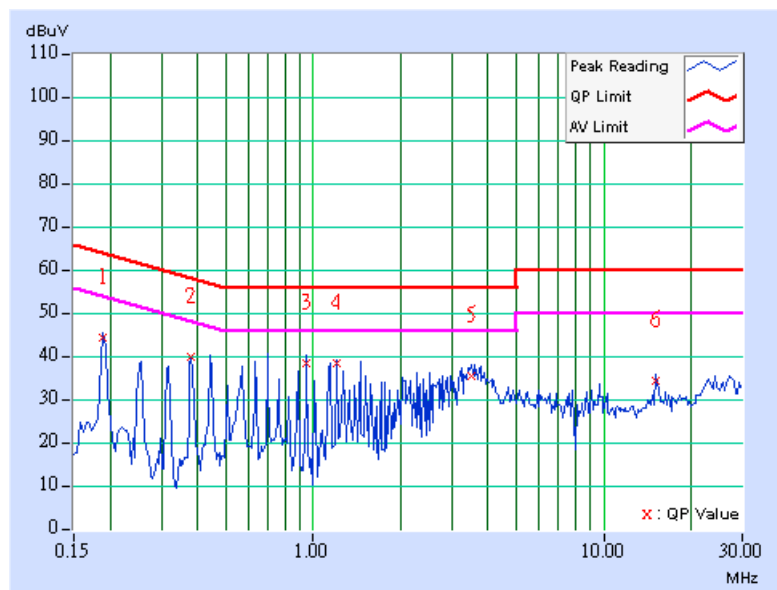



EUT	802.11g Wireless PCI Adapter	MODEL	WL VP 2454 26A0
CHANNEL	Channel 11	6dB BANDWIDTH	9 kHz
MODULATION TYPE	BPSK	TRANSFER RATE	6Mbps
INPUT POWER (SYSTEM)	120Vac, 60 Hz	PHASE	Line (L)
ENVIRONMENTAL CONDITIONS	24deg. C, 64%RH, 991hPa	TESTED BY	Leo Hung

No	Freq. [MHz]	Corr. Factor (dB)	Reading Value [dB (uV)]		Emission Level [dB (uV)]		Limit [dB (uV)]		Margin (dB)	
			Q.P.	AV.	Q.P.	AV.	Q.P.	AV.	Q.P.	AV.
			1	0.189	0.10	44.63	-	44.73	-	64.08
2	0.439	0.12	35.92	-	36.04	-	57.08	47.08	-21.04	-
3	1.004	0.25	34.74	-	34.99	-	56.00	46.00	-21.01	-
4	1.762	0.26	35.35	-	35.61	-	56.00	46.00	-20.39	-
5	3.582	0.30	33.31	-	33.61	-	56.00	46.00	-22.39	-
6	15.063	0.70	32.31	-	33.01	-	60.00	50.00	-26.99	-

- REMARKS:**
1. Q.P. and AV. are abbreviations of quasi-peak and average individually.
 2. "-": The Quasi-peak reading value also meets average limit and measurement with the average detector is unnecessary.
 3. The emission levels of other frequencies were very low against the limit.
 4. Margin value = Emission level - Limit value
 5. Correction factor = Insertion loss + Cable loss
 6. Emission Level = Correction Factor + Reading Value.

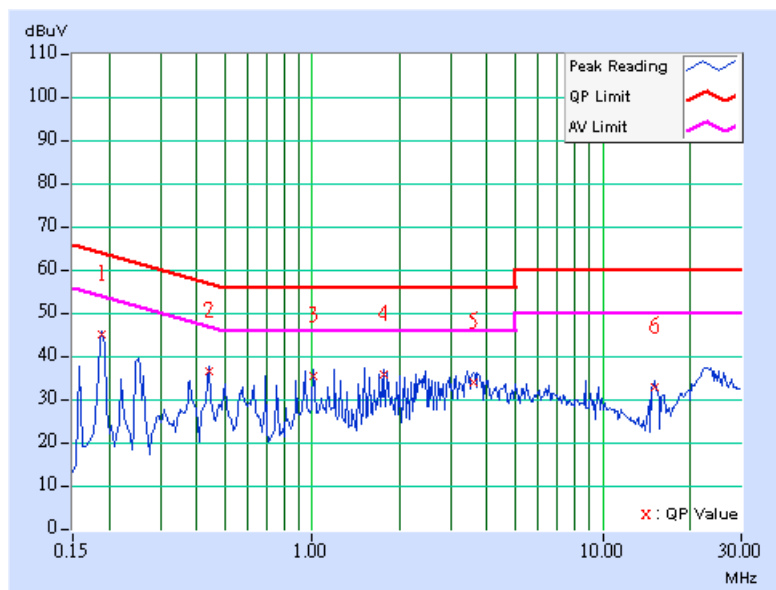



EUT	802.11g Wireless PCI Adapter	MODEL	WL VP 2454 26A0
CHANNEL	Channel 11	6dB BANDWIDTH	9 kHz
MODULATION TYPE	BPSK	TRANSFER RATE	6Mbps
INPUT POWER (SYSTEM)	120Vac, 60 Hz	PHASE	Neutral (N)
ENVIRONMENTAL CONDITIONS	24deg. C, 64%RH, 991hPa	TESTED BY	Leo Hung

No	Freq. [MHz]	Corr. Factor (dB)	Reading Value [dB (uV)]		Emission Level [dB (uV)]		Limit [dB (uV)]		Margin (dB)	
			Q.P.	AV.	Q.P.	AV.	Q.P.	AV.	Q.P.	AV.
			1	0.189	0.10	43.85	-	43.95	-	64.08
2	0.380	0.11	39.48	-	39.59	-	58.27	48.27	-18.68	-
3	0.634	0.16	38.80	-	38.96	-	56.00	46.00	-17.04	-
4	1.203	0.24	38.04	-	38.28	-	56.00	46.00	-17.72	-
5	3.484	0.29	35.91	-	36.20	-	56.00	46.00	-19.80	-
6	15.074	0.56	34.29	-	34.85	-	60.00	50.00	-25.15	-

- REMARKS:**
1. Q.P. and AV. are abbreviations of quasi-peak and average individually.
 2. "-": The Quasi-peak reading value also meets average limit and measurement with the average detector is unnecessary.
 3. The emission levels of other frequencies were very low against the limit.
 4. Margin value = Emission level - Limit value
 5. Correction factor = Insertion loss + Cable loss
 6. Emission Level = Correction Factor + Reading Value.

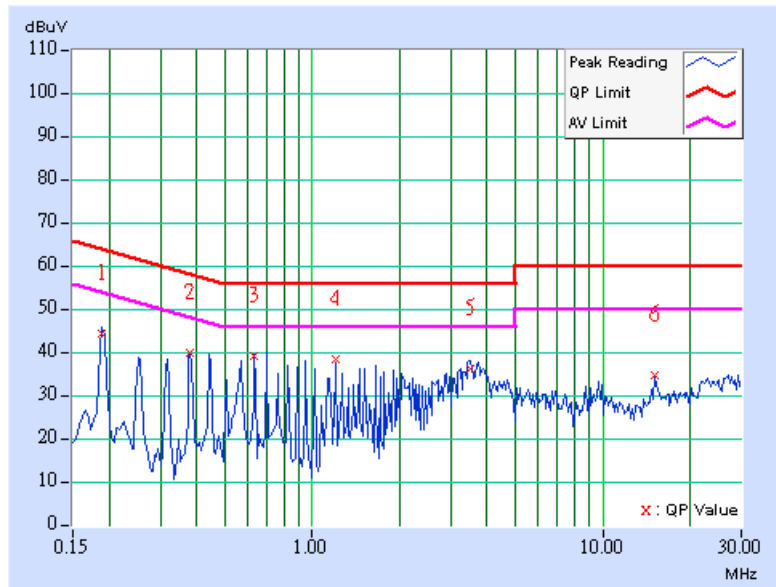



4.2 RADIATED EMISSION MEASUREMENT

4.2.1 LIMITS OF RADIATED EMISSION MEASUREMENT

Emissions radiated outside of the specified bands, shall be according to the general radiated limits in 15.209 as following:

Frequencies (MHz)	Field strength (microvolts/meter)	Measurement distance (meters)
0.009-0.490	2400/F(kHz)	300
0.490-1.705	24000/F(kHz)	30
1.705-30.0	30	30
30-88	100	3
88-216	150	3
216-960	200	3
Above 960	500	3

NOTE:

1. The lower limit shall apply at the transition frequencies.
2. Emission level (dBuV/m) = 20 log Emission level (uV/m).
3. As shown in 15.35(b), for frequencies above 1000MHz, the field strength limits are based on average detector, however, the peak field strength of any emission shall not exceed the maximum permitted average limits, specified above by more than 20dB under any condition of modulation.



4.2.2 TEST INSTRUMENTS

DESCRIPTION & MANUFACTURER	MODEL NO.	SERIAL NO.	CALIBRATED UNTIL
Test Receiver ROHDE & SCHWARZ	ESIB7	100188	Dec. 19, 2005
Spectrum Analyzer ROHDE & SCHWARZ	FSP40	100039	Nov. 21, 2005
BILOG Antenna SCHWARZBECK	VULB9168	9168-157	Jan. 22, 2006
HORN Antenna SCHWARZBECK	BBHA 9120 D	9120D-407	Jan. 16, 2006
HORN Antenna SCHWARZBECK	BBHA 9170	BBHA 9170241	Feb. 23, 2005
Preamplifier Agilent	8449B	3008A01961	Nov. 09, 2005
Preamplifier Agilent	8447D	2944A10629	Nov. 09, 2005
RF signal cable HUBER+SUHNER	SUCOFLEX 104	218182/4	Mar. 04, 2005
RF signal cable HUBER+SUHNER	SUCOFLEX 104	218194/4	Mar. 04, 2005
Software ADT.	ADT_Radiated_V5.14	NA	NA
Antenna Tower ADT.	AT100	AT93021702	NA
Turn Table ADT.	TT100.	TT93021702	NA
Controller ADT.	SC100.	SC93021702	NA

- NOTE:**
1. The calibration interval of the above test instruments is 12 months and the calibrations are traceable to NML/ROC and NIST/USA.
 2. The test was performed in HwaYa Chamber 1.
 3. The horn antenna and HP preamplifier (model: 8449B) are used only for the measurement of emission frequency above 1GHz if tested.
 4. The IC Site Registration No. is IC4924-2.



4.2.3 TEST PROCEDURES

- a. The EUT was placed on the top of a rotating table 0.8 meters above the ground at a 3 meter semi-anechoic chamber. The table was rotated 360 degrees to determine the position of the highest radiation.
- b. The EUT was set 3 meters away from the interference-receiving antenna, which was mounted on the top of a variable-height antenna tower.
- c. The antenna is a broadband antenna, and its height is varied from one meter to four meters above the ground to determine the maximum value of the field strength. Both horizontal and vertical polarizations of the antenna are set to make the measurement.
- d. For each suspected emission, the EUT was arranged to its worst case and then the antenna was tuned to heights from 1 meter to 4 meters and the rotatable table was turned from 0 degrees to 360 degrees to find the maximum reading.
- e. The test-receiver system was set to Peak Detect Function and Specified Bandwidth with Maximum Hold Mode.
- f. If the emission level of the EUT in peak mode was 10 dB lower than the limit specified, then testing could be stopped and the peak values of the EUT would be reported. Otherwise the emissions that did not have 10 dB margin would be re-tested one by one using the quasi-peak method or average method as specified and then reported in Data sheet peak mode and QP mode.

NOTE:

1. The resolution bandwidth and video bandwidth of test receiver/spectrum analyzer is 120kHz for Quasi-peak detection at frequency below 1GHz.
2. The resolution bandwidth and video bandwidth of test receiver/spectrum analyzer is 1 MHz for Peak detection (PK) at frequency above 1GHz.
3. The resolution bandwidth of test receiver/spectrum analyzer is 1 MHz and the video bandwidth is 10 Hz for Average detection (AV) at frequency above 1GHz.

4.2.4 DEVIATION FROM TEST STANDARD

No deviation

4.2.5 TEST SETUP

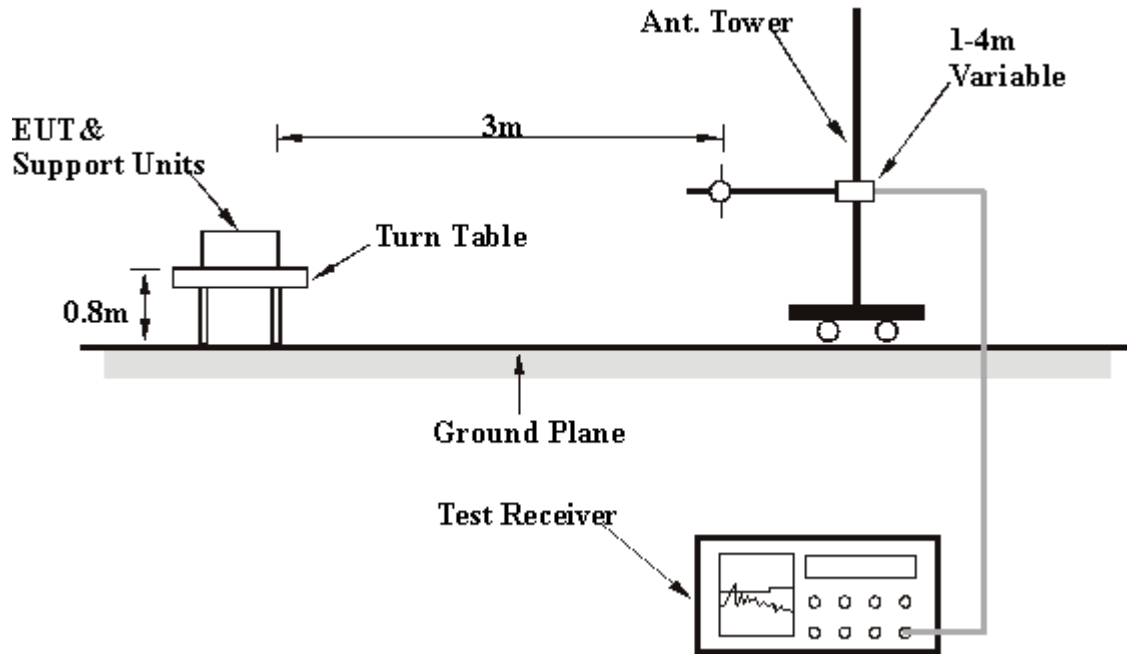

For the actual test configuration, please refer to the related item – Photographs of the Test Configuration.

4.2.6 EUT OPERATING CONDITIONS

Same as 4.1.6

4.2.7 TEST RESULTS

Below 1GHz Worst-Case Data

EUT	802.11g Wireless PCI Adapter	MODEL	WL VP 2454 26A0
CHANNEL	Channel 1	FREQUENCY RANGE	Below 1000MHz
MODULATION TYPE	BPSK	TRANSFER RATE	6Mbps
INPUT POWER (SYSTEM)	120Vac, 60 Hz	DETECTOR FUNCTION	Quasi-Peak
ENVIRONMENTAL CONDITIONS	22deg. C, 62%RH, 991hPa	TESTED BY	Match Tsui

ANTENNA POLARITY & TEST DISTANCE: HORIZONTAL AT 3 M

No.	Freq. (MHz)	Emission Level (dBuV/m)	Limit (dBuV/m)	Margin (dB)	Antenna Height (m)	Table Angle (Degree)	Raw Value (dBuV)	Correction Factor (dB/m)
1	134.97	22.65 QP	43.50	-20.85	1.50 H	241	8.58	14.07
2	134.97	22.65 QP	43.50	-20.85	1.50 H	241	8.58	14.07
3	203.01	20.68 QP	43.50	-22.82	1.75 H	67	9.23	11.46
4	302.14	22.37 QP	46.00	-23.63	1.00 H	127	7.82	14.55
5	399.34	32.20 QP	46.00	-13.80	1.00 H	217	15.47	16.74
6	467.37	29.68 QP	46.00	-16.32	1.75 H	307	11.39	18.30
7	482.93	43.93 QP	46.00	-2.07	1.75 H	301	25.43	18.50
8	496.53	38.95 QP	46.00	-7.05	1.50 H	229	20.26	18.68
9	539.30	31.72 QP	46.00	-14.28	1.25 H	307	12.24	19.48
10	595.67	28.77 QP	46.00	-17.23	1.75 H	214	7.87	20.90
11	642.32	31.58 QP	46.00	-14.42	1.25 H	217	10.00	21.58
12	675.37	33.76 QP	46.00	-12.24	1.00 H	31	11.76	21.99
13	811.44	29.47 QP	46.00	-16.53	1.00 H	214	5.56	23.90
14	875.59	27.77 QP	46.00	-18.23	1.00 H	196	3.11	24.66

ANTENNA POLARITY & TEST DISTANCE: VERTICAL AT 3 M

No.	Freq. (MHz)	Emission Level (dBuV/m)	Limit (dBuV/m)	Margin (dB)	Antenna Height (m)	Table Angle (Degree)	Raw Value (dBuV)	Correction Factor (dB/m)
1	41.66	30.49 QP	40.00	-9.51	1.25 V	295	15.24	15.25
2	127.19	23.70 QP	43.50	-19.80	1.25 V	181	10.17	13.53
3	366.29	26.64 QP	46.00	-19.36	1.25 V	355	10.64	16.01
4	403.23	37.51 QP	46.00	-8.49	1.25 V	1	20.68	16.84
5	488.76	43.68 QP	46.00	-2.32	1.00 V	43	25.10	18.58
6	496.53	38.86 QP	46.00	-7.14	1.00 V	349	20.18	18.68
7	593.73	34.05 QP	46.00	-11.95	1.00 V	259	13.21	20.84
8	675.37	34.23 QP	46.00	-11.77	1.25 V	43	12.23	21.99
9	745.35	29.74 QP	46.00	-16.26	1.50 V	181	6.33	23.42
10	811.44	33.05 QP	46.00	-12.95	1.25 V	172	9.14	23.90
11	846.43	33.28 QP	46.00	-12.72	1.25 V	178	9.11	24.16
12	976.67	33.01 QP	54.00	-20.99	1.75 V	193	7.28	25.73

- REMARKS:**
1. Emission level(dBuV/m)=Raw Value(dBuV) + Correction Factor(dB/m)
 2. Correction Factor(dB/m) = Antenna Factor (dB/m) + Cable Factor (dB)
 3. The other emission levels were very low against the limit.
 4. Margin value = Emission level – Limit value.



802.11b DSSS modulation

EUT	802.11g Wireless PCI Adapter	MODEL	WL VP 2454 26A0
CHANNEL	Channel 1	FREQUENCY RANGE	1 ~ 25GHz
MODULATION TYPE	CCK	TRANSFER RATE	11Mbps
INPUT POWER (SYSTEM)	120Vac, 60 Hz	DETECTOR FUNCTION	Peak(PK) Average (AV)
ENVIRONMENTAL CONDITIONS	22deg. C, 62%RH, 991hPa	TESTED BY	Match Tsui

ANTENNA POLARITY & TEST DISTANCE: HORIZONTAL AT 3 M

No.	Freq. (MHz)	Emission Level (dBuV/m)	Limit (dBuV/m)	Margin (dB)	Antenna Height (m)	Table Angle (Degree)	Raw Value (dBuV)	Correction Factor (dB/m)
1	2386.00	55.12 PK	74.00	-18.88	1.00 H	127	23.33	31.79
1	2386.00	45.34 AV	54.00	-8.66	1.00 H	127	13.55	31.79
2	*2412.00	106.50 PK			1.00 H	127	74.63	31.87
2	*2412.00	99.40 AV			1.00 H	127	67.53	31.87
3	3216.00	49.09 PK	74.00	-24.91	1.00 H	18	14.11	34.98
4	4824.00	46.83 PK	74.00	-27.17	1.05 H	167	8.71	38.11

ANTENNA POLARITY & TEST DISTANCE: VERTICAL AT 3 M

No.	Freq. (MHz)	Emission Level (dBuV/m)	Limit (dBuV/m)	Margin (dB)	Antenna Height (m)	Table Angle (Degree)	Raw Value (dBuV)	Correction Factor (dB/m)
1	2320.00	48.65 PK	74.00	-25.35	1.13 V	296	17.07	31.58
2	2386.00	57.38 PK	74.00	-16.62	1.28 V	195	25.59	31.79
2	2386.00	47.99 AV	54.00	-6.01	1.28 V	195	16.20	31.79
3	*2412.00	115.69 PK			1.28 V	195	83.82	31.87
3	*2412.00	108.07 AV			1.28 V	195	76.20	31.87
4	3216.00	51.36 PK	74.00	-22.64	1.06 V	336	16.38	34.98
4	3216.00	47.91 AV	54.00	-6.09	1.06 V	336	12.93	34.98
5	4824.00	47.70 PK	74.00	-26.30	1.11 V	122	9.58	38.11

- REMARKS:**
1. Emission level(dBuV/m)=Raw Value(dBuV) + Correction Factor(dB/m)
 2. Correction Factor(dB/m) = Antenna Factor (dB/m) + Cable Factor (dB)
 3. The other emission levels were very low against the limit.
 4. Margin value = Emission level – Limit value.
 5. “ * “ : Fundamental frequency



EUT	802.11g Wireless PCI Adapter	MODEL	WL VP 2454 26A0
CHANNEL	Channel 6	FREQUENCY RANGE	1 ~ 25GHz
MODULATION TYPE	CCK	TRANSFER RATE	11Mbps
INPUT POWER (SYSTEM)	120Vac, 60 Hz	DETECTOR FUNCTION	Peak(PK) Average (AV)
ENVIRONMENTAL CONDITIONS	22deg. C, 62%RH, 991hPa	TESTED BY	Match Tsui

ANTENNA POLARITY & TEST DISTANCE: HORIZONTAL AT 3 M

No.	Freq. (MHz)	Emission Level (dBuV/m)	Limit (dBuV/m)	Margin (dB)	Antenna Height (m)	Table Angle (Degree)	Raw Value (dBuV)	Correction Factor (dB/m)
1	*2437.00	106.25 PK			1.20 H	128	74.30	31.95
1	*2437.00	98.82 AV			1.20 H	128	66.87	31.95
2	3249.00	50.94 PK	74.00	-23.06	1.14 H	16	15.94	35.00
3	4874.00	46.78 PK	74.00	-27.22	1.03 H	160	8.49	38.28

ANTENNA POLARITY & TEST DISTANCE: VERTICAL AT 3 M

No.	Freq. (MHz)	Emission Level (dBuV/m)	Limit (dBuV/m)	Margin (dB)	Antenna Height (m)	Table Angle (Degree)	Raw Value (dBuV)	Correction Factor (dB/m)
1	2320.00	49.79 PK	74.00	-24.21	1.14 V	299	18.21	31.58
2	*2437.00	114.15 PK			1.08 V	267	82.20	31.95
2	*2437.00	106.61 AV			1.08 V	267	74.66	31.95
3	3249.00	51.68 PK	74.00	-22.32	1.04 V	340	16.68	35.00
3	3249.00	47.92 AV	54.00	-6.08	1.04 V	340	12.92	35.00
4	4874.00	48.32 PK	74.00	-25.68	1.12 V	1	10.03	38.28

- REMARKS:**
1. Emission level(dBuV/m)=Raw Value(dBuV) + Correction Factor(dB/m)
 2. Correction Factor(dB/m) = Antenna Factor (dB/m) + Cable Factor (dB)
 3. The other emission levels were very low against the limit.
 4. Margin value = Emission level – Limit value.
 5. “ * “ : Fundamental frequency



EUT	802.11g Wireless PCI Adapter	MODEL	WL VP 2454 26A0
CHANNEL	Channel 11	FREQUENCY RANGE	1 ~ 25GHz
MODULATION TYPE	CCK	TRANSFER RATE	11Mbps
INPUT POWER (SYSTEM)	120Vac, 60 Hz	DETECTOR FUNCTION	Peak(PK) Average (AV)
ENVIRONMENTAL CONDITIONS	22deg. C, 62%RH, 991hPa	TESTED BY	Match Tsui

ANTENNA POLARITY & TEST DISTANCE: HORIZONTAL AT 3 M

No.	Freq. (MHz)	Emission Level (dBuV/m)	Limit (dBuV/m)	Margin (dB)	Antenna Height (m)	Table Angle (Degree)	Raw Value (dBuV)	Correction Factor (dB/m)
1	*2462.00	106.28 PK			1.00 H	128	74.26	32.02
1	*2462.00	99.03 AV			1.00 H	128	67.01	32.02
2	2487.00	55.95 PK	74.00	-18.05	1.00 H	128	23.85	32.10
2	2487.00	45.94 AV	54.00	-8.06	1.00 H	128	13.84	32.10
3	3282.00	50.05 PK	74.00	-23.95	1.12 H	360	15.03	35.02
4	4924.00	48.44 PK	74.00	-25.56	1.07 H	300	9.95	38.49

ANTENNA POLARITY & TEST DISTANCE: VERTICAL AT 3 M

No.	Freq. (MHz)	Emission Level (dBuV/m)	Limit (dBuV/m)	Margin (dB)	Antenna Height (m)	Table Angle (Degree)	Raw Value (dBuV)	Correction Factor (dB/m)
1	2320.00	50.24 PK	74.00	-23.76	1.14 V	296	18.66	31.58
2	*2462.00	115.63 PK			1.24 V	195	83.61	32.02
2	*2462.00	108.05 AV			1.24 V	195	76.03	32.02
3	2487.00	58.32 PK	74.00	-15.68	1.24 V	195	26.22	32.10
3	2487.00	50.10 AV	54.00	-3.90	1.24 V	195	18.00	32.10
4	3282.00	50.64 PK	74.00	-23.36	1.21 V	19	15.62	35.02
5	4924.00	51.35 PK	74.00	-22.65	1.15 V	5	12.86	38.49
5	4924.00	43.43 AV	54.00	-10.57	1.15 V	5	4.94	38.49

- REMARKS:**
1. Emission level(dBuV/m)=Raw Value(dBuV) + Correction Factor(dB/m)
 2. Correction Factor(dB/m) = Antenna Factor (dB/m) + Cable Factor (dB)
 3. The other emission levels were very low against the limit.
 4. Margin value = Emission level – Limit value.
 5. “ * “ : Fundamental frequency



802.11g OFDM modulation

EUT	802.11g Wireless PCI Adapter	MODEL	WL VP 2454 26A0
CHANNEL	Channel 1	FREQUENCY RANGE	1 ~ 25GHz
MODULATION TYPE	BPSK	TRANSFER RATE	6Mbps
INPUT POWER (SYSTEM)	120Vac, 60 Hz	DETECTOR FUNCTION	Peak(PK) Average (AV)
ENVIRONMENTAL CONDITIONS	22deg. C, 62%RH, 991hPa	TESTED BY	Match Tsui

ANTENNA POLARITY & TEST DISTANCE: HORIZONTAL AT 3 M

No.	Freq. (MHz)	Emission Level (dBuV/m)	Limit (dBuV/m)	Margin (dB)	Antenna Height (m)	Table Angle (Degree)	Raw Value (dBuV)	Correction Factor (dB/m)
1	2390.00	54.69 PK	74.00	-19.31	1.26 H	149	22.89	31.80
1	2390.00	45.50 AV	54.00	-8.50	1.26 H	149	13.70	31.80
2	*2412.00	101.74 PK			1.26 H	149	69.87	31.87
2	*2412.00	92.24 AV			1.26 H	149	60.37	31.87
3	3216.00	50.68 PK	74.00	-23.32	1.14 H	19	15.70	34.98
4	4824.00	46.57 PK	74.00	-27.43	1.09 H	210	8.45	38.11

ANTENNA POLARITY & TEST DISTANCE: VERTICAL AT 3 M

No.	Freq. (MHz)	Emission Level (dBuV/m)	Limit (dBuV/m)	Margin (dB)	Antenna Height (m)	Table Angle (Degree)	Raw Value (dBuV)	Correction Factor (dB/m)
1	2320.00	50.85 PK	74.00	-23.15	1.15 V	321	19.27	31.58
2	2390.00	66.06 PK	74.00	-7.94	1.27 V	194	34.26	31.80
2	2390.00	50.97 AV	54.00	-3.03	1.27 V	194	19.17	31.80
3	*2412.00	110.97 PK			1.27 V	194	79.10	31.87
3	*2412.00	101.67 AV			1.27 V	194	69.80	31.87
4	3216.00	53.33 PK	74.00	-20.67	1.03 V	319	18.35	34.98
4	3216.00	49.92 AV	54.00	-4.08	1.03 V	319	14.94	34.98
5	4824.00	46.48 PK	74.00	-27.52	1.16 V	360	8.36	38.11

- REMARKS:**
1. Emission level(dBuV/m)=Raw Value(dBuV) + Correction Factor(dB/m)
 2. Correction Factor(dB/m) = Antenna Factor (dB/m) + Cable Factor (dB)
 3. The other emission levels were very low against the limit.
 4. Margin value = Emission level – Limit value.
 5. “ * “ : Fundamental frequency



EUT	802.11g Wireless PCI Adapter	MODEL	WL VP 2454 26A0
CHANNEL	Channel 6	FREQUENCY RANGE	1 ~ 25GHz
MODULATION TYPE	BPSK	TRANSFER RATE	6Mbps
INPUT POWER (SYSTEM)	120Vac, 60 Hz	DETECTOR FUNCTION	Peak(PK) Average (AV)
ENVIRONMENTAL CONDITIONS	22deg. C, 62%RH, 991hPa	TESTED BY	Match Tsui

ANTENNA POLARITY & TEST DISTANCE: HORIZONTAL AT 3 M

No.	Freq. (MHz)	Emission Level (dBuV/m)	Limit (dBuV/m)	Margin (dB)	Antenna Height (m)	Table Angle (Degree)	Raw Value (dBuV)	Correction Factor (dB/m)
1	*2437.00	101.98 PK			1.00 H	133	70.03	31.95
1	*2437.00	92.43 AV			1.00 H	133	60.48	31.95
2	3249.00	51.82 PK	74.00	-22.18	1.12 H	360	16.82	35.00
2	3249.00	48.33 AV	54.00	-5.67	1.12 H	360	13.33	35.00
3	4787.00	45.94 PK	74.00	-28.06	1.05 H	117	7.93	38.01

ANTENNA POLARITY & TEST DISTANCE: VERTICAL AT 3 M

No.	Freq. (MHz)	Emission Level (dBuV/m)	Limit (dBuV/m)	Margin (dB)	Antenna Height (m)	Table Angle (Degree)	Raw Value (dBuV)	Correction Factor (dB/m)
1	2320.00	49.75 PK	74.00	-24.25	1.00 V	12	18.17	31.58
2	*2437.00	110.60 PK			1.06 V	268	78.65	31.95
2	*2437.00	101.03 AV			1.06 V	268	69.08	31.95
3	3249.00	53.73 PK	74.00	-20.27	1.02 V	344	18.73	35.00
3	3249.00	50.32 AV	54.00	-3.68	1.02 V	344	15.32	35.00
4	4874.00	46.45 PK	74.00	-27.55	1.05 V	1	8.16	38.28

- REMARKS:**
1. Emission level(dBuV/m)=Raw Value(dBuV) + Correction Factor(dB/m)
 2. Correction Factor(dB/m) = Antenna Factor (dB/m) + Cable Factor (dB)
 3. The other emission levels were very low against the limit.
 4. Margin value = Emission level – Limit value.
 5. “ * “ : Fundamental frequency



EUT	802.11g Wireless PCI Adapter	MODEL	WL VP 2454 26A0
CHANNEL	Channel 11	FREQUENCY RANGE	1 ~ 25GHz
MODULATION TYPE	BPSK	TRANSFER RATE	6Mbps
INPUT POWER (SYSTEM)	120Vac, 60 Hz	DETECTOR FUNCTION	Peak(PK) Average (AV)
ENVIRONMENTAL CONDITIONS	22deg. C, 62%RH, 991hPa	TESTED BY	Match Tsui

ANTENNA POLARITY & TEST DISTANCE: HORIZONTAL AT 3 M

No.	Freq. (MHz)	Emission Level (dBuV/m)	Limit (dBuV/m)	Margin (dB)	Antenna Height (m)	Table Angle (Degree)	Raw Value (dBuV)	Correction Factor (dB/m)
1	*2462.00	102.34 PK			1.18 H	129	70.32	32.02
1	*2462.00	93.13 AV			1.18 H	129	61.11	32.02
2	2483.50	59.70 PK	74.00	-14.30	1.18 H	129	27.61	32.09
2	2483.50	48.55 AV	54.00	-5.45	1.18 H	129	16.46	32.09
3	2640.00	45.53 PK	74.00	-28.47	1.21 H	14	12.84	32.69
4	4924.00	47.30 PK	74.00	-26.70	1.04 H	109	8.81	38.49

ANTENNA POLARITY & TEST DISTANCE: VERTICAL AT 3 M

No.	Freq. (MHz)	Emission Level (dBuV/m)	Limit (dBuV/m)	Margin (dB)	Antenna Height (m)	Table Angle (Degree)	Raw Value (dBuV)	Correction Factor (dB/m)
1	*2462.00	109.81 PK			1.05 V	314	77.79	32.02
1	*2462.00	100.57 AV			1.05 V	314	68.55	32.02
2	2483.50	70.02 PK	74.00	-3.98	1.05 V	314	37.93	32.09
2	2483.50	52.44 AV	54.00	-1.56	1.05 V	314	20.35	32.09
3	2640.00	50.69 PK	74.00	-23.31	1.21 V	327	18.00	32.69
4	3282.00	49.82 PK	74.00	-24.18	1.01 V	20	14.80	35.02
5	4924.00	47.72 PK	74.00	-26.28	1.04 V	2	9.23	38.49

- REMARKS:**
1. Emission level(dBuV/m)=Raw Value(dBuV) + Correction Factor(dB/m)
 2. Correction Factor(dB/m) = Antenna Factor (dB/m) + Cable Factor (dB)
 3. The other emission levels were very low against the limit.
 4. Margin value = Emission level – Limit value.
 5. “ * “ : Fundamental frequency



802.11g Turbo OFDM modulation

EUT	802.11g Wireless PCI Adapter	MODEL	WL VP 2454 26A0
CHANNEL	Channel 6	FREQUENCY RANGE	1 ~ 25GHz
MODULATION TYPE	BPSK	TRANSFER RATE	12Mbps
INPUT POWER (SYSTEM)	120Vac, 60 Hz	DETECTOR FUNCTION	Peak(PK) Average (AV)
ENVIRONMENTAL CONDITIONS	25deg. C, 61%RH, 991hPa	TESTED BY	Brad Wu

ANTENNA POLARITY & TEST DISTANCE: HORIZONTAL AT 3 M								
No.	Freq. (MHz)	Emission Level (dBuV/m)	Limit (dBuV/m)	Margin (dB)	Antenna Height (m)	Table Angle (Degree)	Raw Value (dBuV)	Correction Factor (dB/m)
1	2390.00	49.66 PK	74.00	-24.34	1.41 H	19	18.05	31.61
2	*2437.00	99.30 PK			1.41 H	19	67.45	31.85
2	*2437.00	90.49 AV			1.41 H	19	58.64	31.85
3	2483.50	47.45 PK	74.00	-26.55	1.41 H	19	15.32	32.13
4	3248.00	51.13 PK	74.00	-22.87	1.01 H	29	17.28	33.86
4	3248.00	46.39 AV	54.00	-7.61	1.01 H	29	12.54	33.86
5	4874.00	47.93 PK	74.00	-26.07	1.39 H	20	10.27	37.66

ANTENNA POLARITY & TEST DISTANCE: VERTICAL AT 3 M								
No.	Freq. (MHz)	Emission Level (dBuV/m)	Limit (dBuV/m)	Margin (dB)	Antenna Height (m)	Table Angle (Degree)	Raw Value (dBuV)	Correction Factor (dB/m)
1	2390.00	59.98 PK	74.00	-14.02	1.18 V	17	28.37	31.61
1	2390.00	50.77 AV	54.00	-3.23	1.18 V	17	19.16	31.61
2	*2437.00	109.62 PK			1.18 V	17	77.77	31.85
2	*2437.00	100.41 AV			1.18 V	17	68.56	31.85
3	2483.50	57.77 PK	74.00	-16.23	1.18 V	17	25.64	32.13
3	2483.50	48.56 AV	54.00	-5.44	1.18 V	17	16.43	32.13
4	3248.00	53.51 PK	74.00	-20.49	1.04 V	8	19.66	33.86
4	3248.00	50.30 AV	54.00	-3.70	1.04 V	8	16.45	33.86
5	4874.00	48.25 PK	74.00	-25.75	1.20 V	34	10.59	37.66

- REMARKS:**
1. Emission level(dBuV/m)=Raw Value(dBuV) + Correction Factor(dB/m)
 2. Correction Factor(dB/m) = Antenna Factor (dB/m) + Cable Factor (dB)
 3. The other emission levels were very low against the limit.
 4. Margin value = Emission level – Limit value.
 5. “ * “ : Fundamental frequency



4.3 6dB BANDWIDTH MEASUREMENT

4.3.1 LIMITS OF 6dB BANDWIDTH MEASUREMENT

The minimum of 6dB Bandwidth Measurement is 0.5 MHz.

4.3.2 TEST INSTRUMENTS

Description & Manufacturer	Model No.	Serial No.	Calibrated Until
SPECTRUM ANALYZER	FSEK 30	100049	Aug. 12, 2005

NOTE: The calibration interval of the above test instruments is 12 months and the calibrations are traceable to NML/ROC and NIST/USA.

4.3.3 TEST PROCEDURE

The transmitter output was connected to the spectrum analyzer through an attenuator. The bandwidth of the fundamental frequency was measured by spectrum analyzer with 100kHz RBW and 100kHz VBW. The 6dB bandwidth is defined as the total spectrum the power of which is higher than peak power minus 6dB.

4.3.4 DEVIATION FROM TEST STANDARD

No deviation

4.3.5 TEST SETUP



4.3.6 EUT OPERATING CONDITIONS

The software provided by client to enable the EUT under transmission condition continuously at lowest, middle and highest channel frequencies individually.



4.3.7 TEST RESULTS

802.11b DSSS modulation

EUT	802.11g Wireless PCI Adapter	MODEL	WL VP 2454 26A0
MODULATION TYPE	CCK	TRANSFER RATE	11Mbps
INPUT POWER (SYSTEM)	120Vac, 60 Hz	ENVIRONMENTAL CONDITIONS	24deg. C, 64%RH, 991hPa
TESTED BY	Leo Hung		

CHANNEL	CHANNEL FREQUENCY (MHz)	6dB BANDWIDTH (MHz)	MINIMUM LIMIT (MHz)	PASS/FAIL
1	2412	12.18	0.5	PASS
6	2437	11.54	0.5	PASS
11	2462	12.02	0.5	PASS



CH1

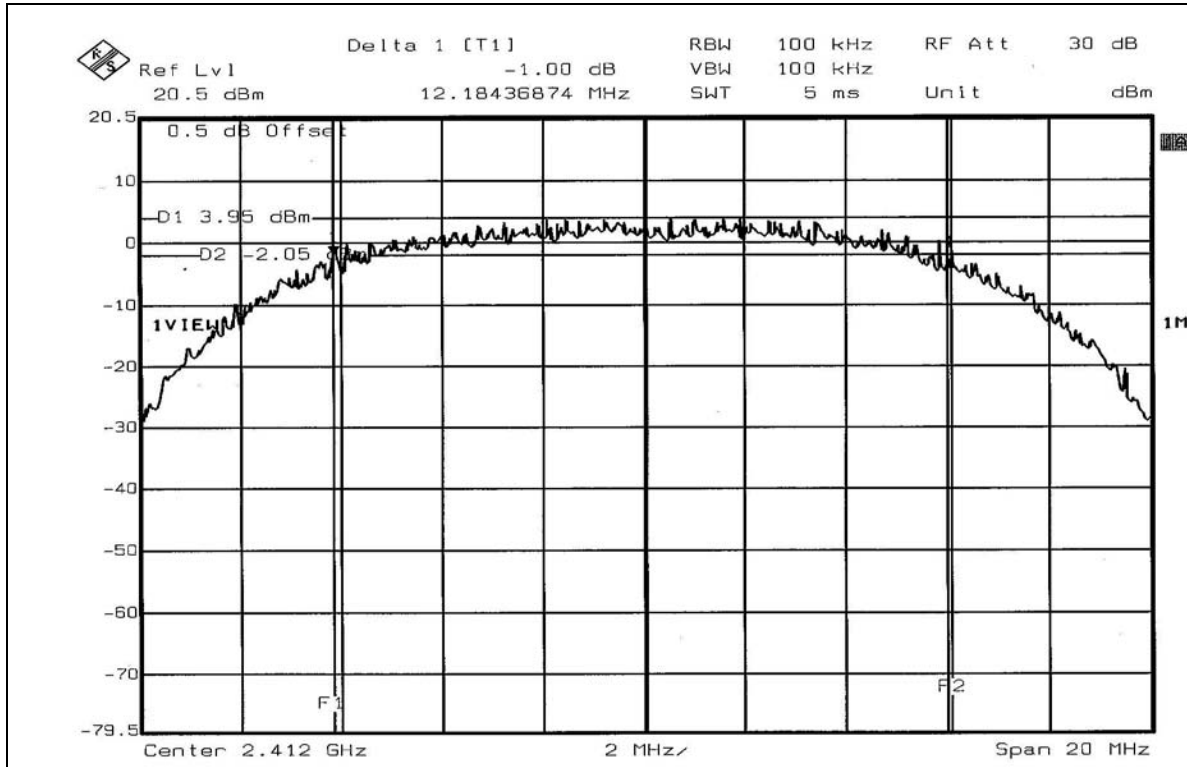

CH6

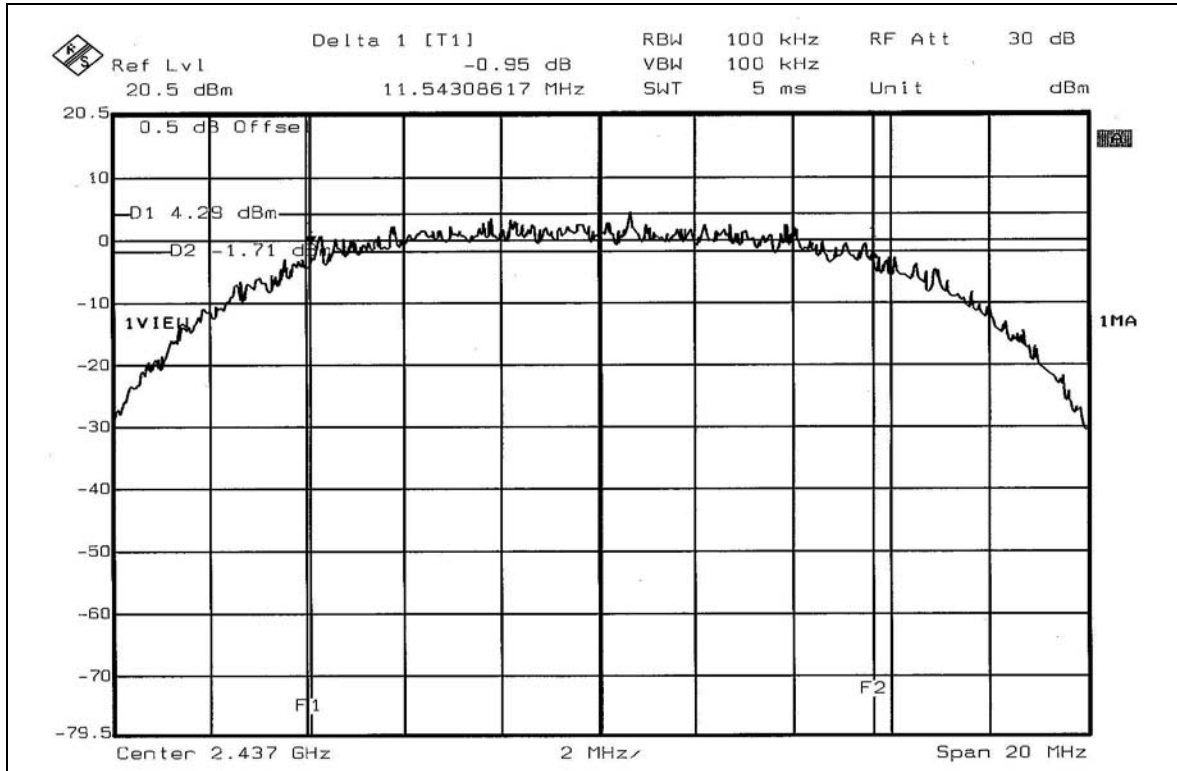



CH11

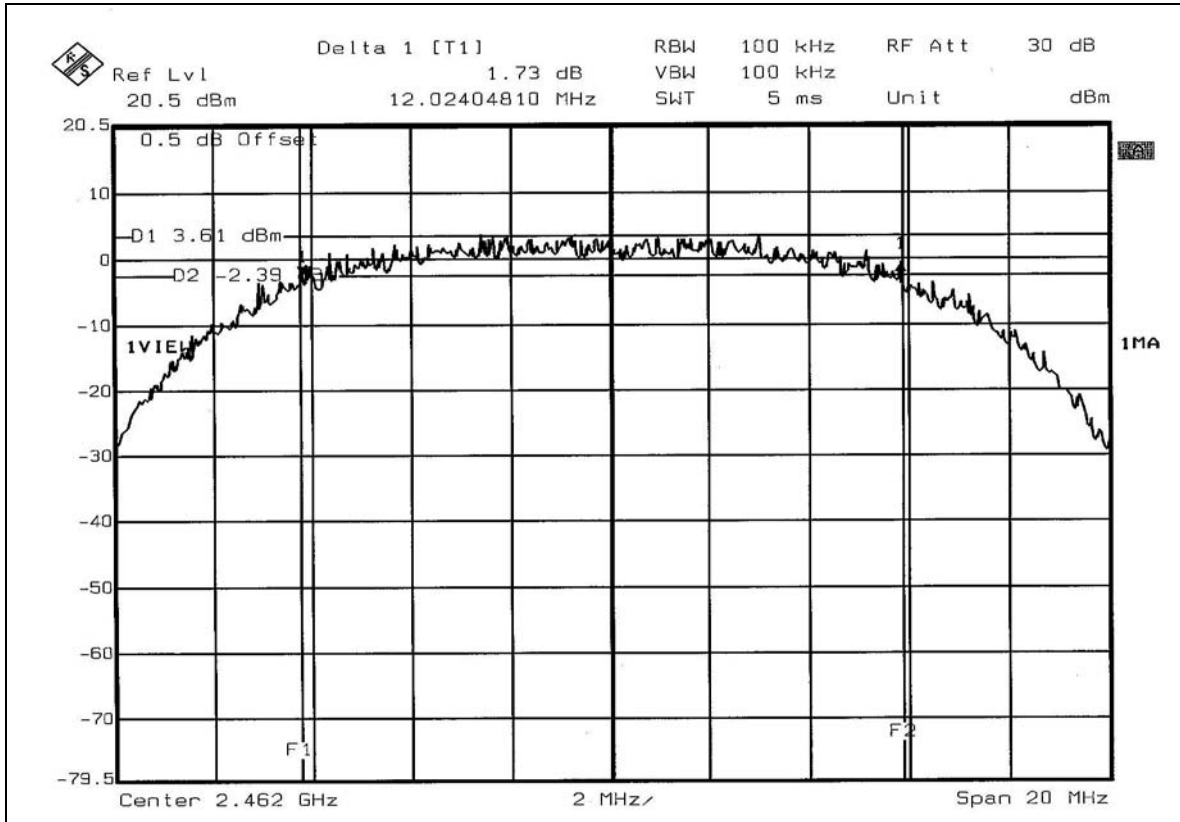

**802.11g OFDM modulation**

EUT	802.11g Wireless PCI Adapter	MODEL	WL VP 2454 26A0
MODULATION TYPE	BPSK	TRANSFER RATE	6Mbps
INPUT POWER (SYSTEM)	120Vac, 60 Hz	ENVIRONMENTAL CONDITIONS	24deg. C, 64%RH, 991hPa
TESTED BY	Leo Hung		

CHANNEL	CHANNEL FREQUENCY (MHz)	6dB BANDWIDTH (MHz)	MINIMUM LIMIT (MHz)	PASS/FAIL
1	2412	16.39	0.5	PASS
6	2437	16.43	0.5	PASS
11	2462	16.47	0.5	PASS



CH1

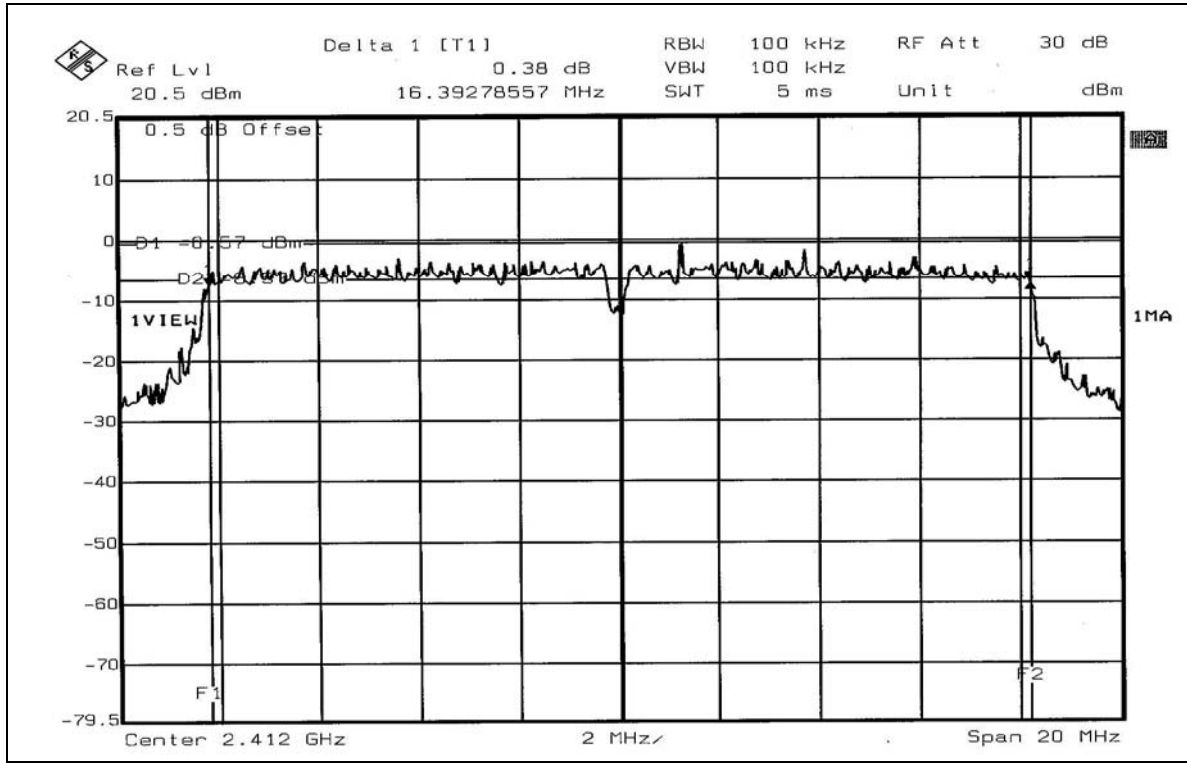

CH6

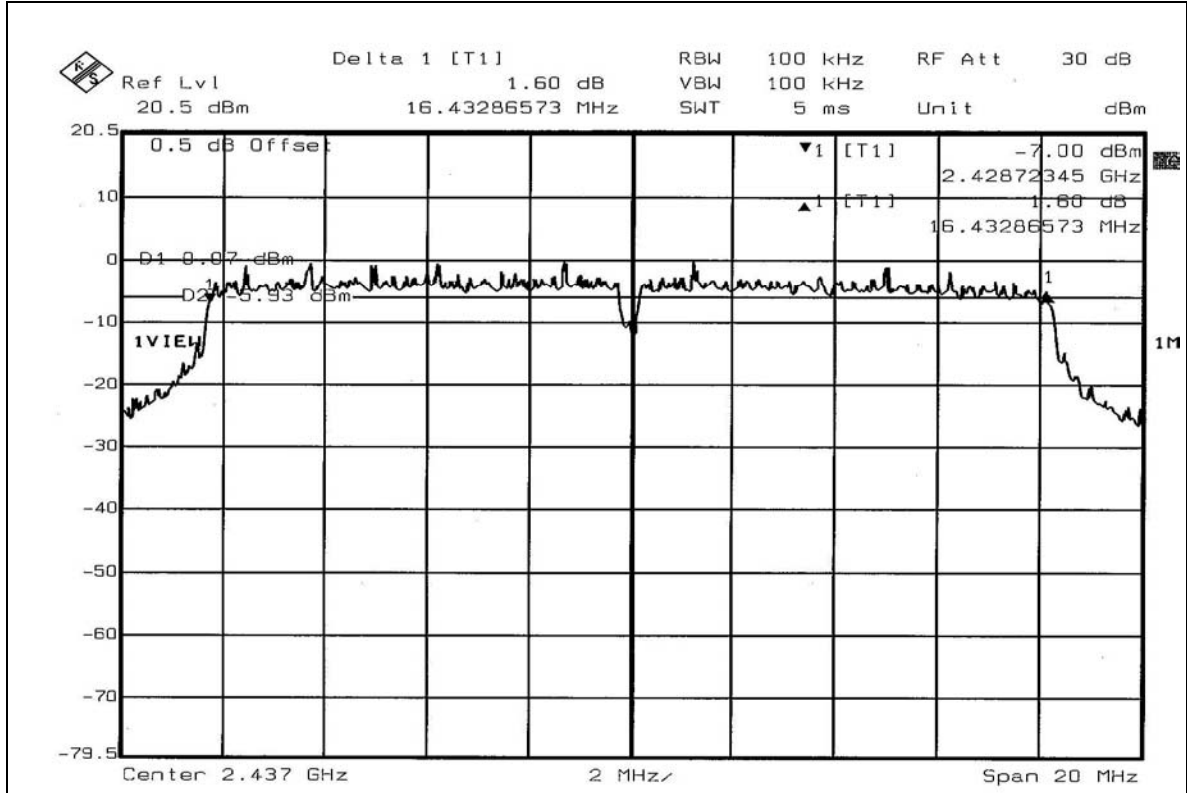



CH11

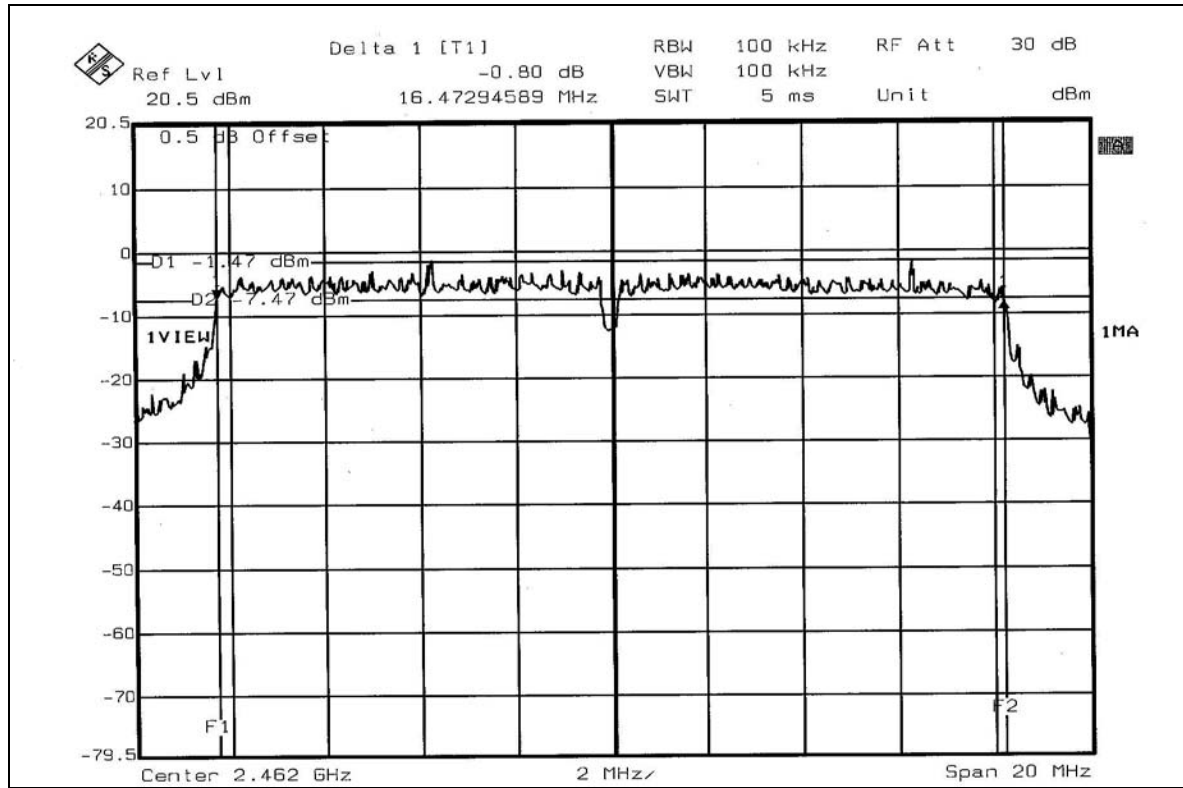



802.11g Turbo OFDM modulation

EUT	802.11g Wireless PCI Adapter	MODEL	WL VP 2454 26A0
MODULATION TYPE	BPSK	TRANSFER RATE	12Mbps
INPUT POWER (SYSTEM)	120 Vac, 60 Hz	ENVIRONMENTAL CONDITIONS	24 deg. C, 64% RH, 991 hPa
TESTED BY	Leo Hung		

CHANNEL	CHANNEL FREQUENCY (MHz)	6dB BANDWIDTH (MHz)	MINIMUM LIMIT (MHz)	PASS/FAIL
6	2437	32.94	0.5	PASS



CH6

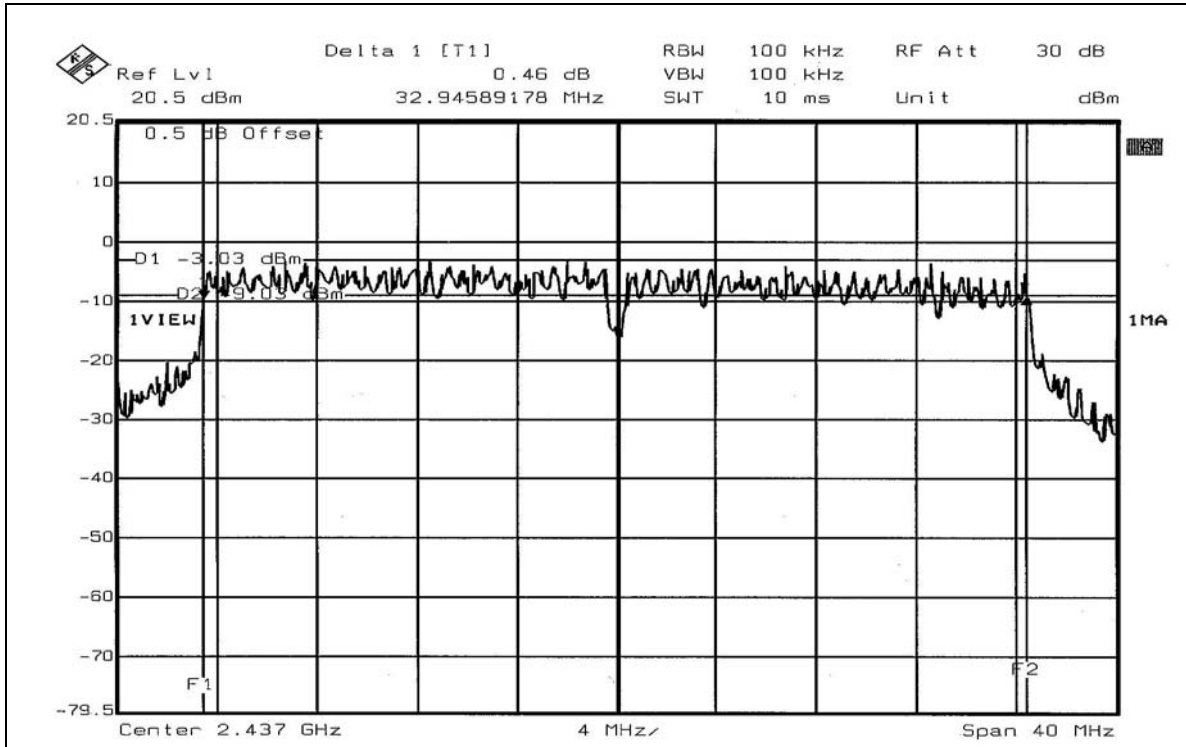



4.4 MAXIMUM PEAK OUTPUT POWER

4.4.1 LIMITS OF MAXIMUM PEAK OUTPUT POWER MEASUREMENT

The Maximum Peak Output Power Measurement is 30dBm.

4.4.2 INSTRUMENTS

Description & Manufacturer	Model No.	Serial No.	Calibrated Until
R&S SPECTRUM ANALYZER	FSEK30	100049	Aug. 12, 2005
AGILENT SIGNAL GENERATOR	E8257C	MY43320668	Dec. 06, 2005
DIGITAL RT OSCILLOSCOPE	TDS1012	C037299	Dec. 07, 2005
NARDA DETECTOR	4503A	FSCM99899	NA

NOTE:

The calibration interval of the above test instruments is 12 months and the calibrations are traceable to NML/ROC and NIST/USA..



4.4.1 TEST PROCEDURES

1. A detector was used on the output port of the EUT. An oscilloscope was used to read the response of the detector.
2. Replaced the EUT by the signal generator. The center frequency of the S.G was adjusted to the center frequency of the measured channel.
3. Adjusted the power to have the same reading on oscilloscope. Record the power level.

4.4.2 DEVIATION FROM TEST STANDARD

No deviation

4.4.3 TEST SETUP



4.4.4 EUT OPERATING CONDITIONS

Same as Item 4.3.6



4.4.3 TEST RESULTS

802.11b DSSS modulation

EUT	802.11g Wireless PCI Adapter	MODEL	WL VP 2454 26A0
MODULATION TYPE	CCK	TRANSFER RATE	11Mbps
INPUT POWER (SYSTEM)	120Vac, 60 Hz	ENVIRONMENTAL CONDITIONS	24deg. C, 64%RH, 991hPa
TESTED BY	Leo Hung		

CHANNEL	CHANNEL FREQUENCY (MHz)	PEAK POWER OUTPUT (mW)	PEAK POWER OUTPUT (dBm)	PEAK POWER LIMIT (dBm)	PASS/FAIL
1	2412	50.582	17.04	30	PASS
6	2437	50.582	17.04	30	PASS
11	2462	51.523	17.12	30	PASS

**802.11g OFDM modulation**

EUT	802.11g Wireless PCI Adapter	MODEL	WL VP 2454 26A0
MODULATION TYPE	BPSK	TRANSFER RATE	6Mbps
INPUT POWER (SYSTEM)	120Vac, 60 Hz	ENVIRONMENTAL CONDITIONS	24deg.C, 64%RH, 991hPa
TESTED BY	Leo Hung		

CHANNEL	CHANNEL FREQUENCY (MHz)	PEAK POWER OUTPUT (mW)	PEAK POWER OUTPUT (dBm)	PEAK POWER LIMIT (dBm)	PASS/FAIL
1	2412	40.179	16.04	30	PASS
6	2437	40.458	16.07	30	PASS
11	2462	40.832	16.11	30	PASS

802.11g Turbo OFDM modulation

EUT	802.11g Wireless PCI Adapter	MODEL	WL VP 2454 26A0
MODULATION TYPE	BPSK	TRANSFER RATE	12Mbps
INPUT POWER (SYSTEM)	120Vac, 60 Hz	ENVIRONMENTAL CONDITIONS	24deg.C, 64%RH, 991hPa
TESTED BY	Leo Hung		

CHANNEL	CHANNEL FREQUENCY (MHz)	PEAK POWER OUTPUT (mW)	PEAK POWER OUTPUT (dBm)	PEAK POWER LIMIT (dBm)	PASS/FAIL
6	2437	40.458	16.07	30	PASS



4.5 POWER SPECTRAL DENSITY MEASUREMENT

4.5.1 LIMITS OF POWER SPECTRAL DENSITY MEASUREMENT

The Maximum of Power Spectral Density Measurement is 8dBm.

4.5.2 TEST INSTRUMENTS

Description & Manufacturer	Model No.	Serial No.	Calibrated Until
R&S SPECTRUM ANALYZER	FSEK30	100049	Aug. 12, 2005

NOTE:

The calibration interval of the above test instruments is 12 months and the calibrations are traceable to NML/ROC and NIST/USA.

4.5.3 TEST PROCEDURE

The transmitter output was connected to the spectrum analyzer through an attenuator, the bandwidth of the fundamental frequency was measured with the spectrum analyzer using 3kHz RBW and 30kHz VBW, set sweep time = span/3kHz. The power spectral density was measured and recorded. The sweep time is allowed to be longer than span/3kHz for a full response of the mixer in the spectrum analyzer.

4.5.4 DEVIATION FROM TEST STANDARD

No deviation

4.5.5 TEST SETUP

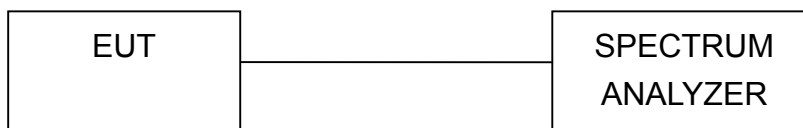

4.5.6 EUT OPERATING CONDITION

Same as Item 4.3.6



4.5.7 TEST RESULTS

802.11b DSSS modulation

EUT	802.11g Wireless PCI Adapter	MODEL	WL VP 2454 26A0
MODULATION TYPE	CCK	TRANSFER RATE	11Mbps
INPUT POWER (SYSTEM)	120Vac, 60 Hz	ENVIRONMENTAL CONDITIONS	24deg. C, 64%RH, 991hPa
TESTED BY	Leo Hung		

CHANNEL	CHANNEL FREQUENCY (MHz)	RF POWER LEVEL IN 3kHz BW (dBm)	MAXIMUM LIMIT (dBm)	PASS/FAIL
1	2412	-10.48	8	PASS
6	2437	-10.26	8	PASS
11	2462	-10.12	8	PASS



CH1

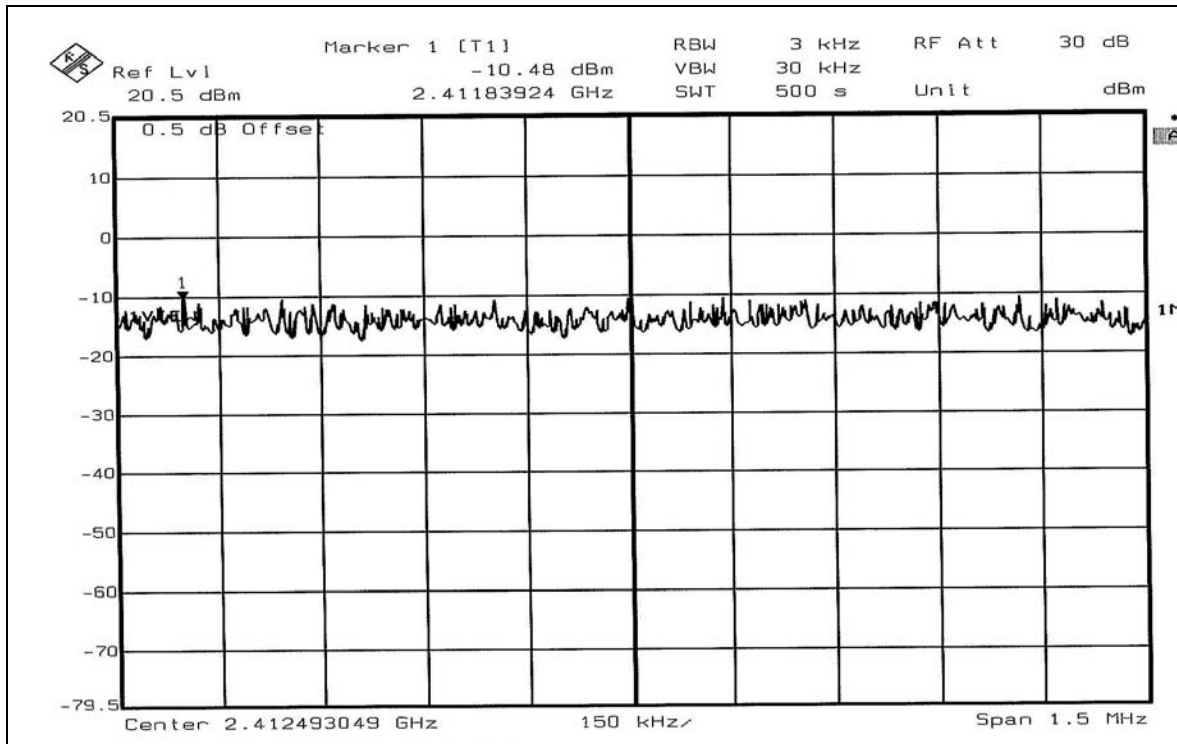

CH6

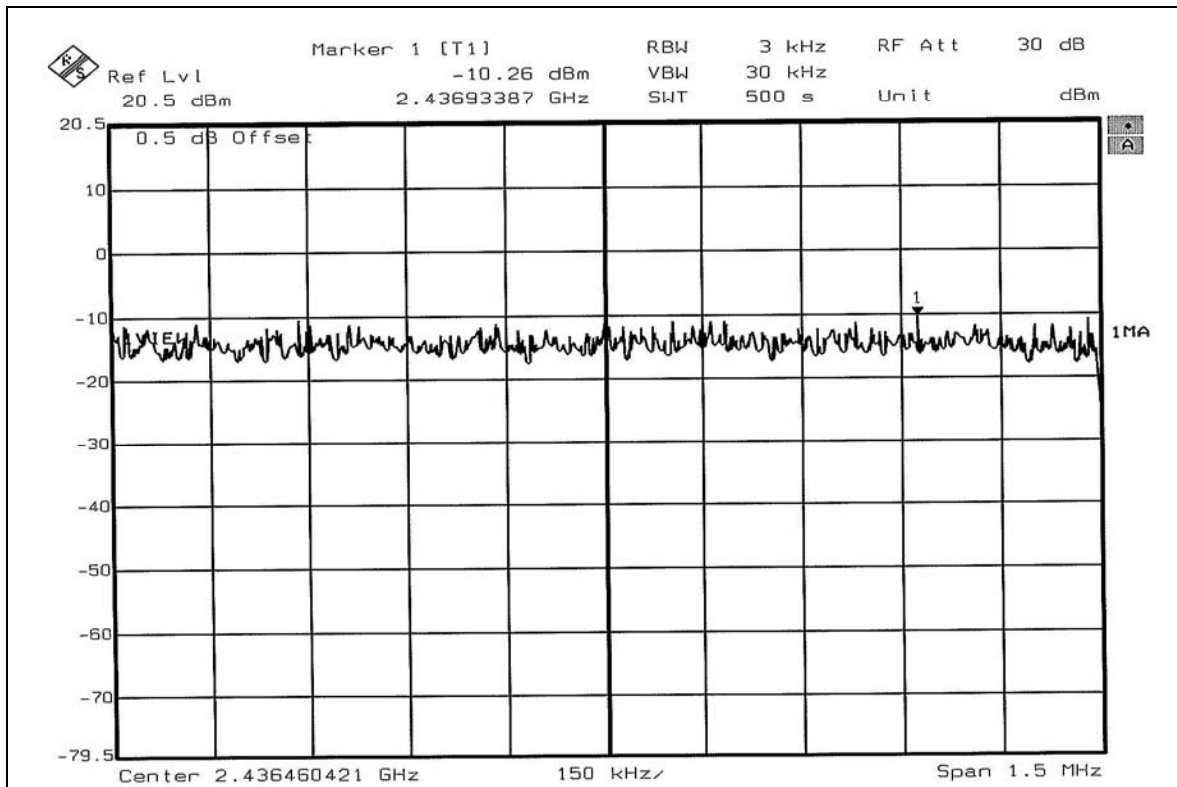



CH11

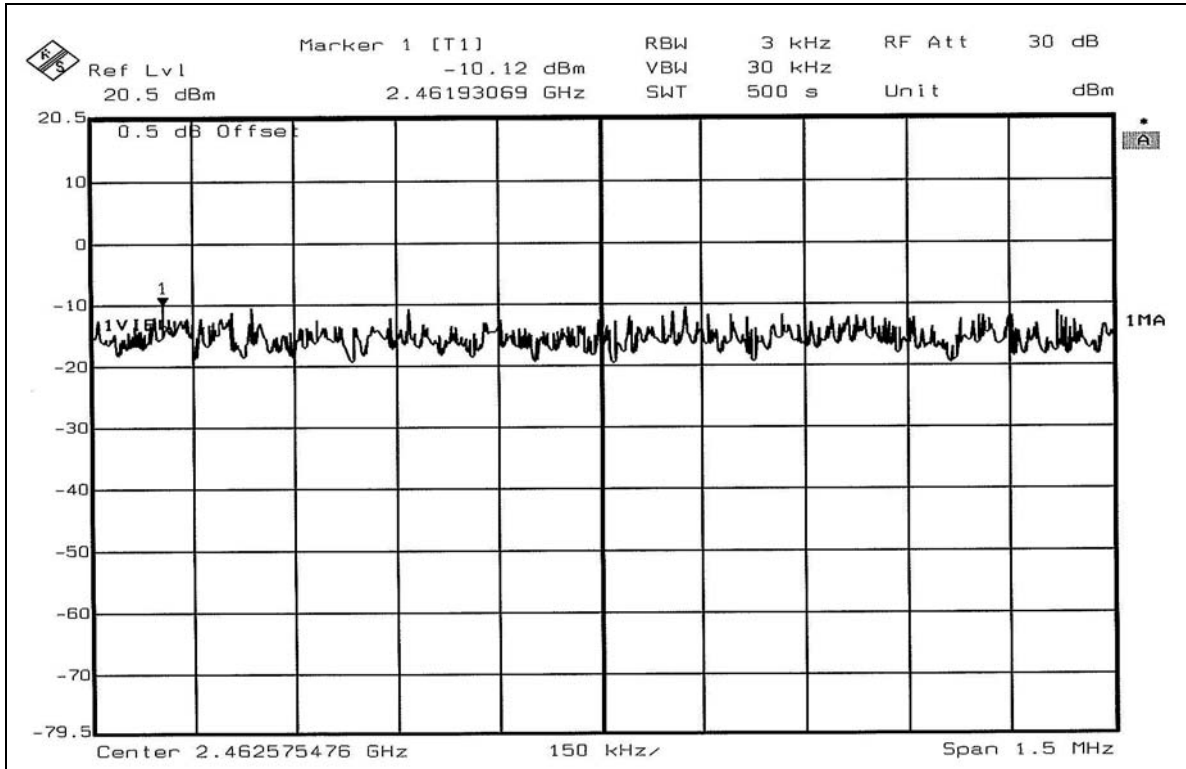

**802.11g OFDM modulation**

EUT	802.11g Wireless PCI Adapter	MODEL	WL VP 2454 26A0
MODULATION TYPE	BPSK	TRANSFER RATE	6Mbps
INPUT POWER (SYSTEM)	120Vac, 60 Hz	ENVIRONMENTAL CONDITIONS	24deg. C, 64%RH, 991hPa
TESTED BY	Leo Hung		

CHANNEL	CHANNEL FREQUENCY (MHz)	RF POWER LEVEL IN 3kHz BW (dBm)	MAXIMUM LIMIT (dBm)	PASS/FAIL
1	2412	-14.30	8	PASS
6	2437	-14.45	8	PASS
11	2462	-14.98	8	PASS



CH1

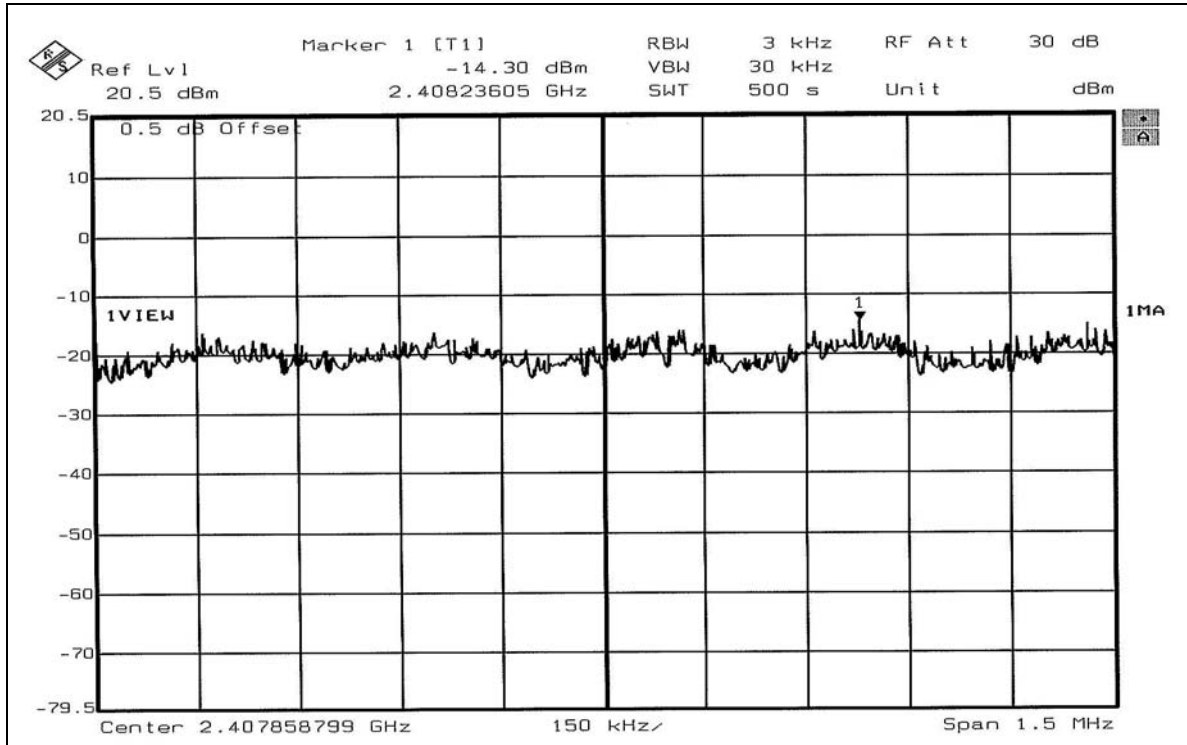

CH6

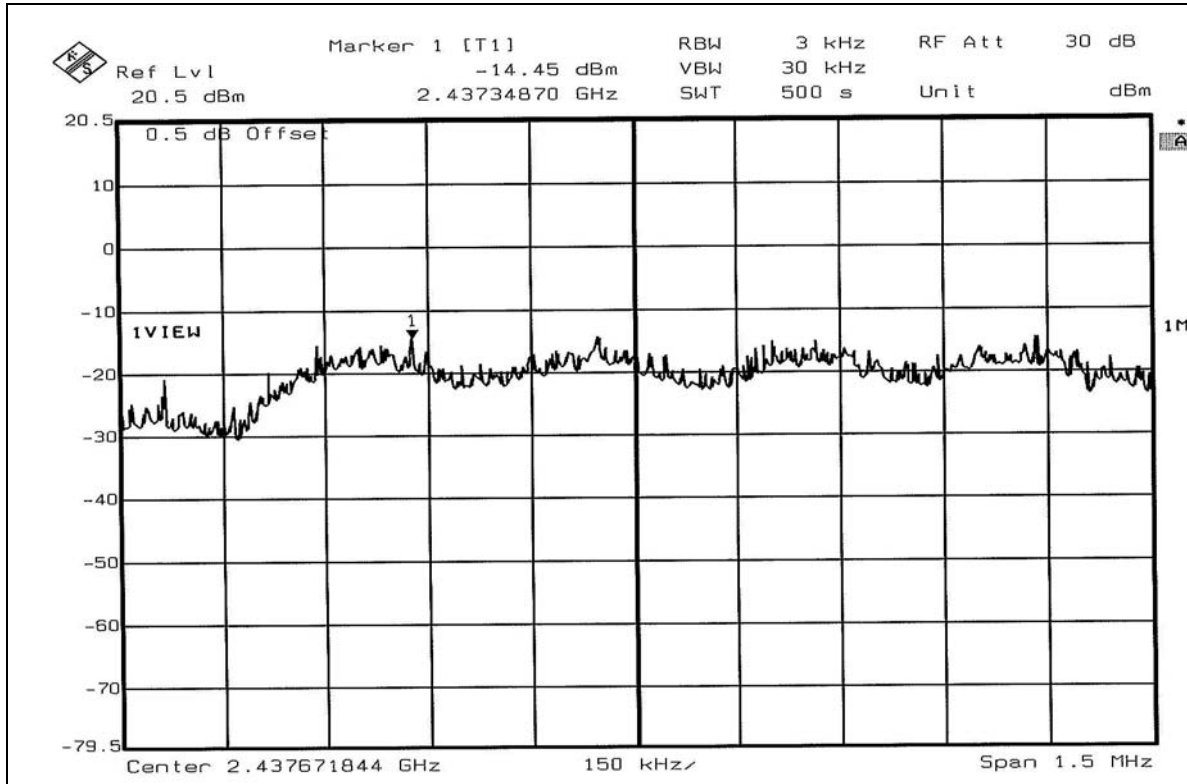



CH11

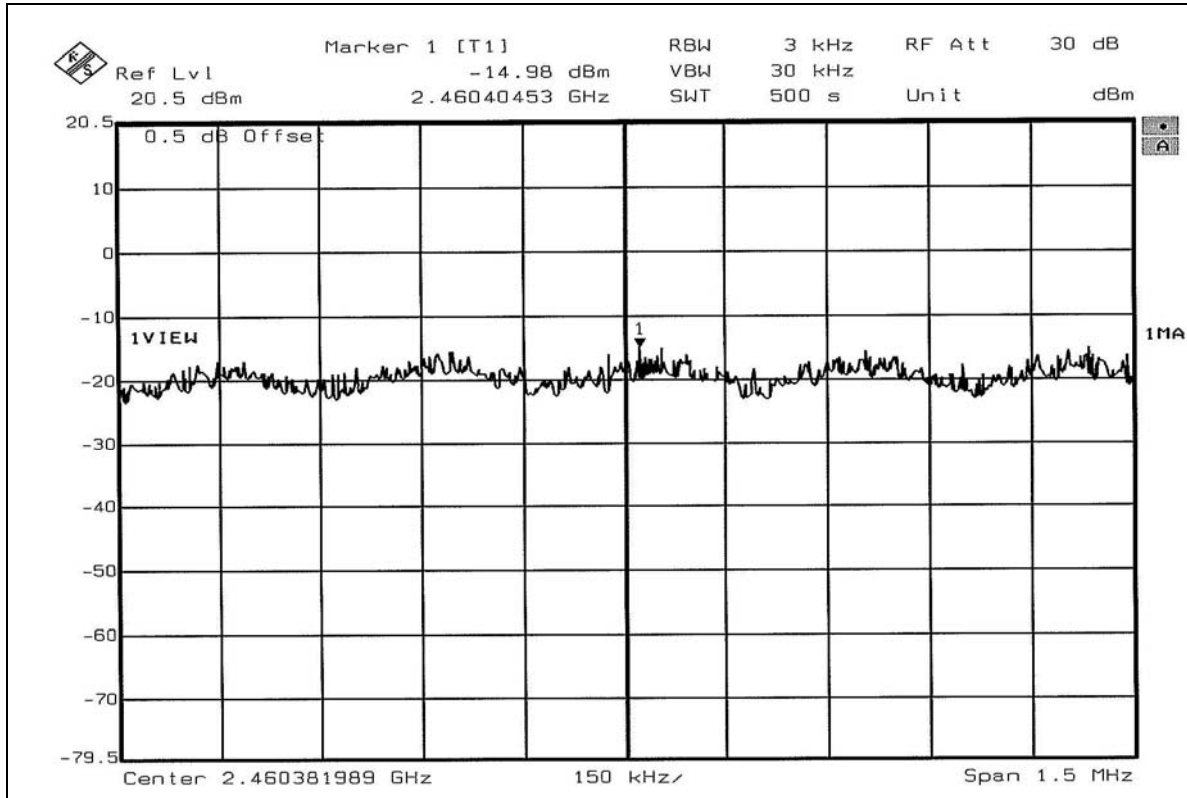

**802.11g Turbo OFDM modulation**

EUT	802.11g Wireless PCI Adapter	MODEL	WL VP 2454 26A0
MODULATION TYPE	BPSK	TRANSFER RATE	12Mbps
INPUT POWER (SYSTEM)	120Vac, 60 Hz	ENVIRONMENTAL CONDITIONS	24deg. C, 64%RH, 991hPa
TESTED BY	Leo Hung		

CHANNEL	CHANNEL FREQUENCY (MHz)	RF POWER LEVEL IN 3kHz BW (dBm)	MAXIMUM LIMIT (dBm)	PASS/FAIL
6	2437	-14.81	8	PASS



CH6

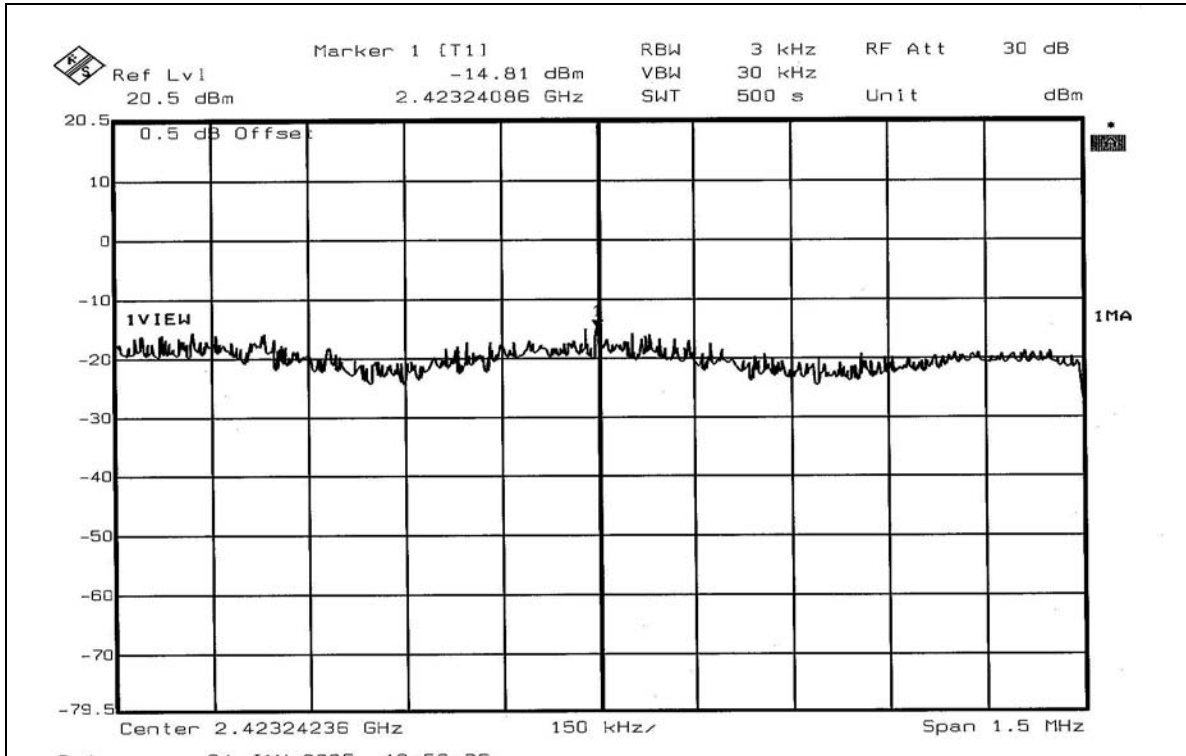



4.6 BAND EDGES MEASUREMENT

4.6.1 LIMITS OF BAND EDGES MEASUREMENT

Below -20dB of the highest emission level of operating band (in 100kHz Resolution Bandwidth).

4.6.2 TEST INSTRUMENTS

Description & Manufacturer	Model No.	Serial No.	Calibrated Until
R&S SPECTRUM ANALYZER	FSEK30	100049	Aug. 12, 2005

NOTE: The calibration interval of the above test instruments is 12 months and the calibrations are traceable to NML/ROC and NIST/USA.

4.6.3 TEST PROCEDURE

The transmitter output was connected to the spectrum analyzer via a low lose cable. Set both RBW and VBW of spectrum analyzer to 100 kHz and 100 kHz with suitable frequency span including 100 MHz bandwidth from band edge. The band edges was measured and recorded.

The spectrum plots (Peak RBW=VBW=100kHz ; Average RBW=1MHz, VBW=10Hz) are attached on the following pages.

4.6.4 DEVIATION FROM TEST STANDARD

No deviation

4.6.5 EUT OPERATING CONDITION

Same as Item 4.3.6



4.6.6 TEST RESULTS

The spectrum plots are attached on the following 18 images. D2 line indicates the highest level, and D1 line indicates the 20dB offset below D2. It shows compliance with the requirement in part 15.247(d).

4.6.7 TEST RESULTS

802.11b DSSS modulation

NOTE 1:The band edge emission plot on page 60 shows 57.64dBc between carrier maximum power and local maximum emission in restrict band (2.3503GHz). The emission of carrier strength list in the test result of channel 1 at the item 4.2.7 is 115.69dBuV/m (Peak), so the maximum field strength in restrict band is $115.69 - 57.64 = 58.05$ dBuV/m which is under 74dBuV/m limit.

The band edge emission plot on page 60 shows 59.47dBc between carrier maximum power and local maximum emission in restrict band (2.3900GHz). The emission of carrier strength list in the test result of channel 1 at the item 4.2.7 is 108.07dBuV/m (Average), so the maximum field strength in restrict band is $108.07 - 59.47 = 48.60$ dBuV/m which is under 54dBuV/m limit.

NOTE 2:The band edge emission plot on page 61 shows 55.70dBc between carrier maximum power and local maximum emission in restrict band (2.4879GHz). The emission of carrier strength list in the test result of channel 11 at the item 4.2.7 is 115.63dBuV/m (Peak), so the maximum field strength in restrict band is $115.63 - 55.70 = 59.93$ dBuV/m which is under 74dBuV/m limit.

The band edge emission plot on page 62 shows 57.70dBc between carrier maximum power and local maximum emission in restrict band (2.4873GHz). The emission of carrier strength list in the test result of channel 11 at the item 4.2.7 is 108.05dBuV/m (Average), so the maximum field strength in restrict band is $108.05 - 57.70 = 50.35$ dBuV/m which is under 54dBuV/m limit.



802.11g OFDM modulation

NOTE 1:The band edge emission plot on page 63 shows 47.71dBc between carrier maximum power and local maximum emission in restrict band (2.3900GHz). The emission of carrier strength list in the test result of channel 1 at the item 4.2.7 is 110.97dBuV/m (Peak), so the maximum field strength in restrict band is $110.97 - 47.71 = 63.26$ dBuV/m which is under 74dBuV/m limit.

The band edge emission plot on page 63 shows 49.03dBc between carrier maximum power and local maximum emission in restrict band (2.3900GHz). The emission of carrier strength list in the test result of channel 1 at the item 4.2.7 is 101.67dBuV/m (Average), so the maximum field strength in restrict band is $101.67 - 49.03 = 52.64$ dBuV/m which is under 54dBuV/m limit.

NOTE 2:The band edge emission plot on page 64 shows 45.98dBc between carrier maximum power and local maximum emission in restrict band (2.4835GHz). The emission of carrier strength list in the test result of channel 11 at the item 4.2.7 is 109.81dBuV/m (Peak), so the maximum field strength in restrict band is $109.81 - 45.98 = 63.83$ dBuV/m which is under 74dBuV/m limit.

The band edge emission plot on page 65 shows 47.63dBc between carrier maximum power and local maximum emission in restrict band (2.4835GHz). The emission of carrier strength list in the test result of channel 11 at the item 4.2.7 is 100.57dBuV/m (Average), so the maximum field strength in restrict band is $100.57 - 47.63 = 52.94$ dBuV/m which is under 54dBuV/m limit.



802.11g Turbo OFDM modulation

NOTE 1: The band edge emission plot on page 66 shows 49.48dBc between carrier maximum power and local maximum emission in restrict band (2.3900GHz). The emission of carrier strength list in the test result of channel 6 at the item 4.2.7 is 109.62dBuV/m (Peak), so the maximum field strength in restrict band is $109.62 - 49.48 = 60.14$ dBuV/m which is under 74dBuV/m limit.

The band edge emission plot on page 66 shows 48.06dBc between carrier maximum power and local maximum emission in restrict band (2.3900GHz). The emission of carrier strength list in the test result of channel 6 at the item 4.2.7 is 100.41dBuV/m (Average), so the maximum field strength in restrict band is $100.41 - 48.06 = 52.35$ dBuV/m which is under 54dBuV/m limit.

NOTE 2: The band edge emission plot on page 67 shows 53.56dBc between carrier maximum power and local maximum emission in restrict band (2.4844GHz). The emission of carrier strength list in the test result of channel 6 at the item 4.2.7 is 109.62dBuV/m (Peak), so the maximum field strength in restrict band is $109.62 - 53.56 = 56.06$ dBuV/m which is under 74dBuV/m limit.

The band edge emission plot on page 68 shows 50.52dBc between carrier maximum power and local maximum emission in restrict band (2.4835GHz). The emission of carrier strength list in the test result of channel 6 at the item 4.2.7 is 100.41dBuV/m (Average), so the maximum field strength in restrict band is $100.41 - 50.52 = 49.89$ dBuV/m which is under 54dBuV/m limit.



802.11b DSSS modulation

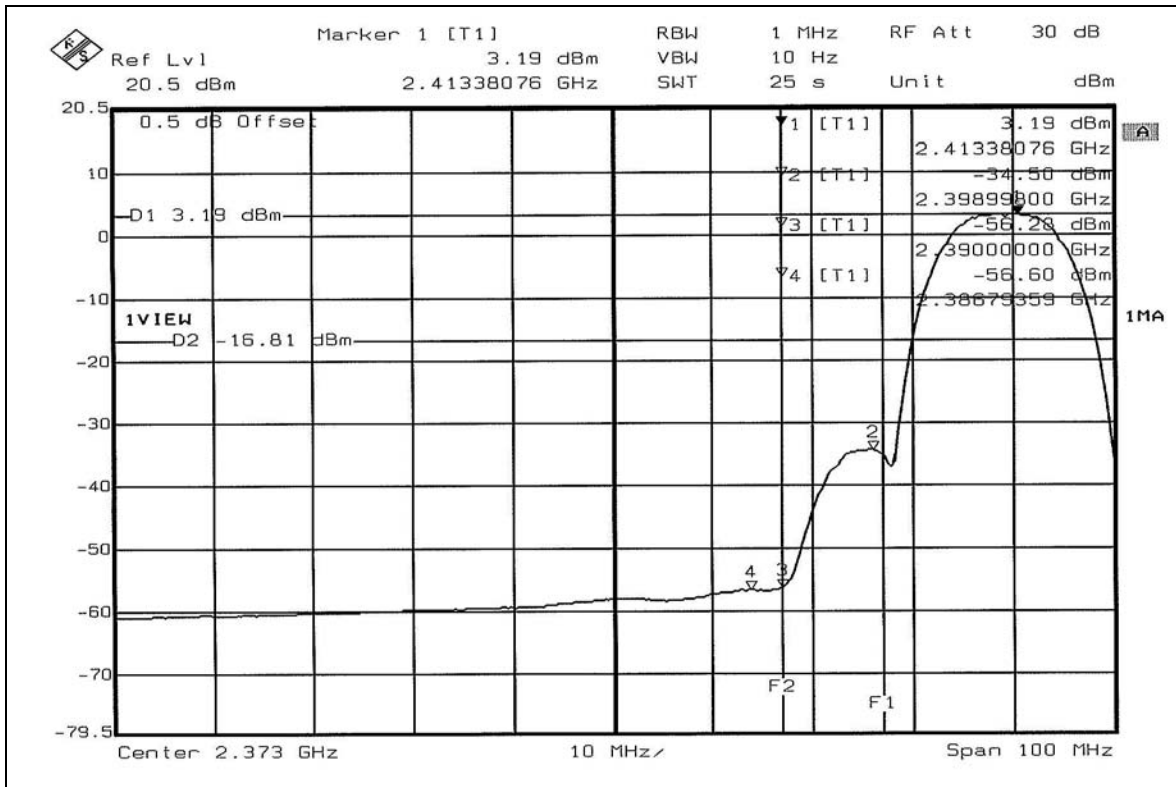
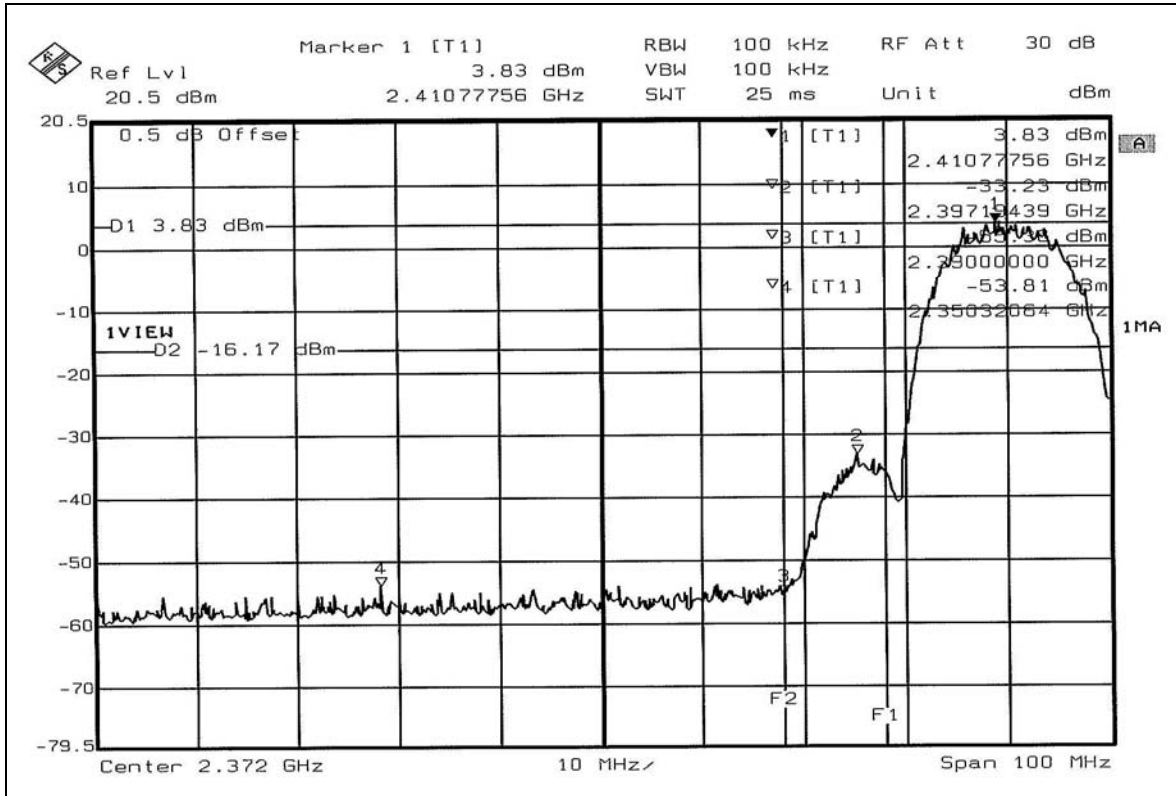

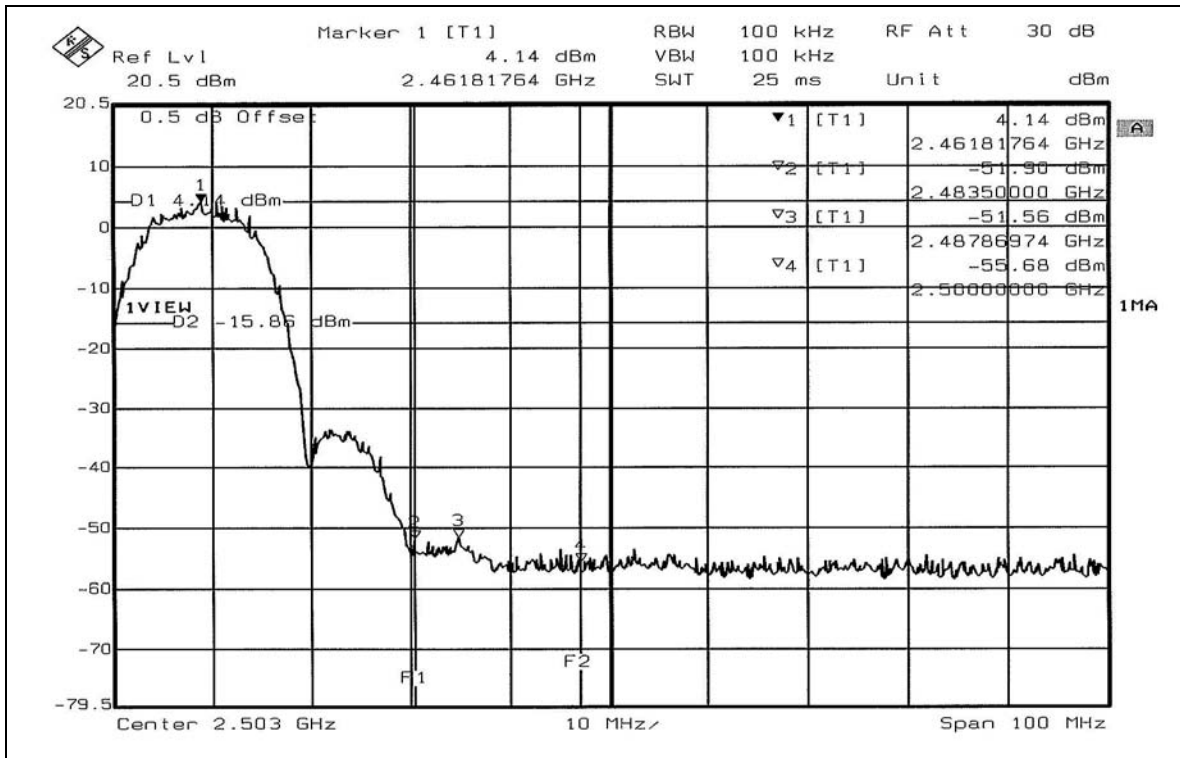
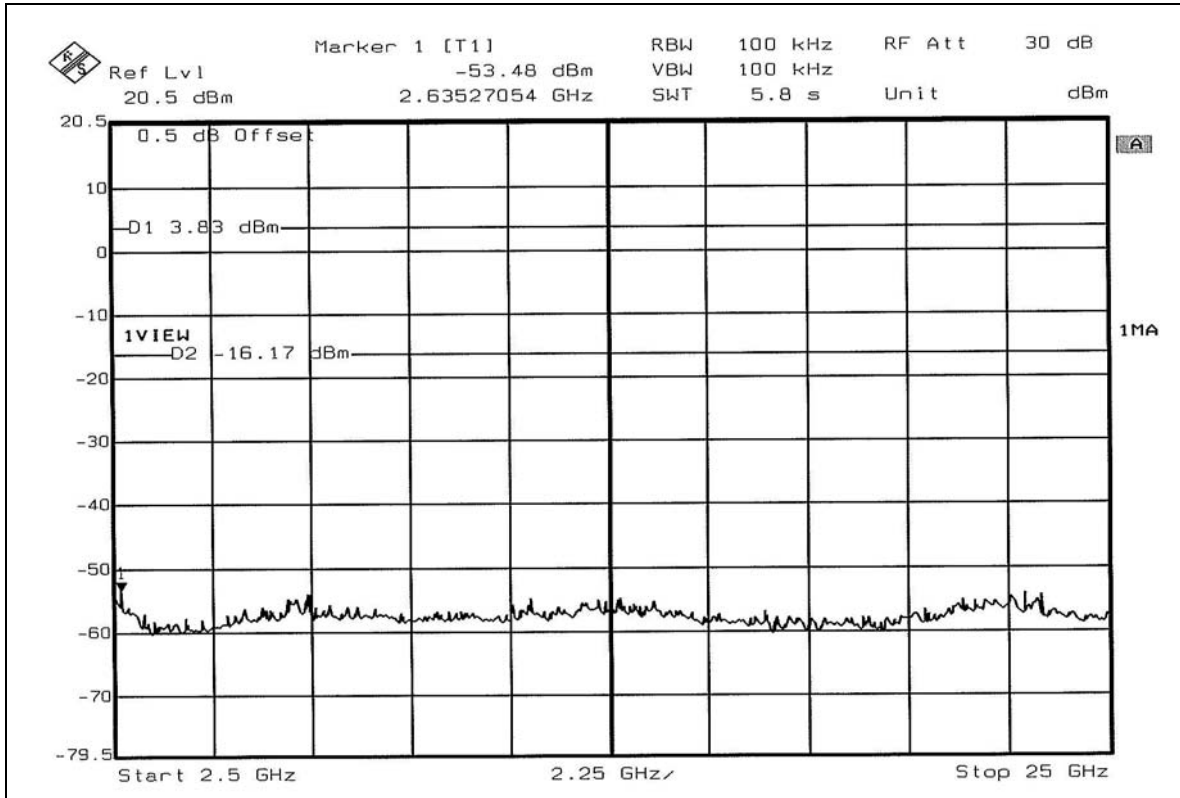

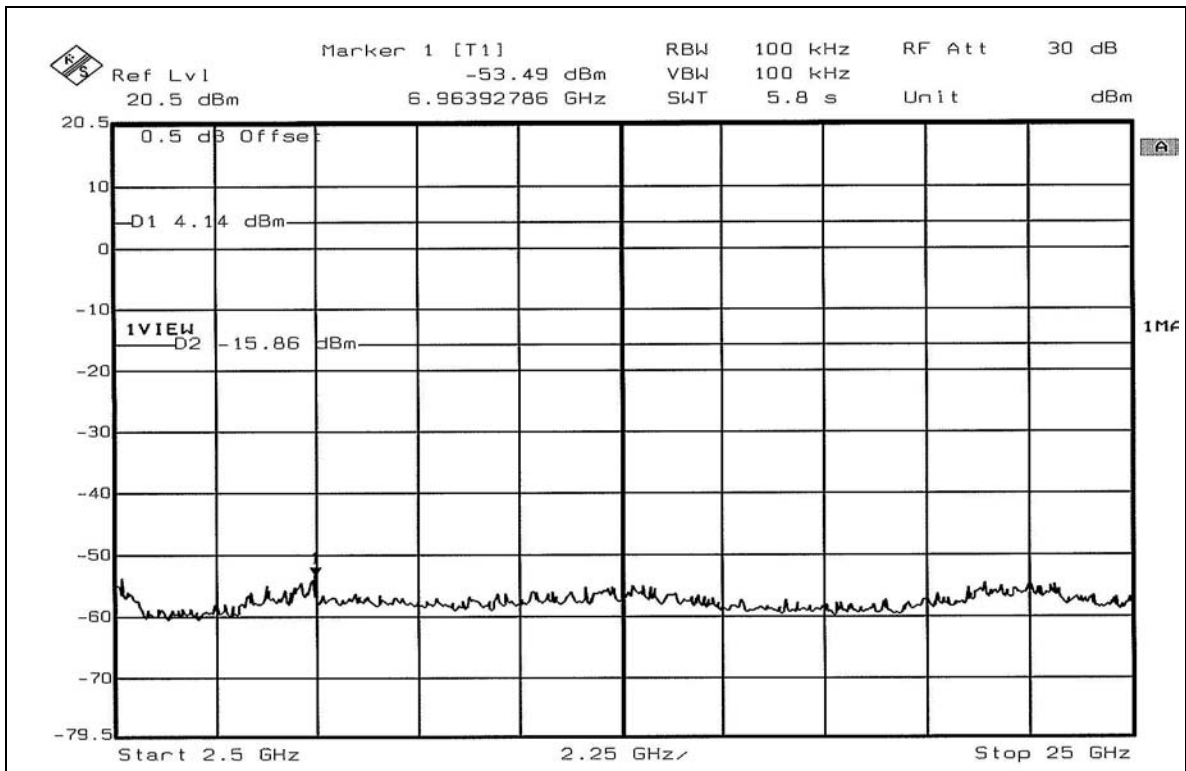
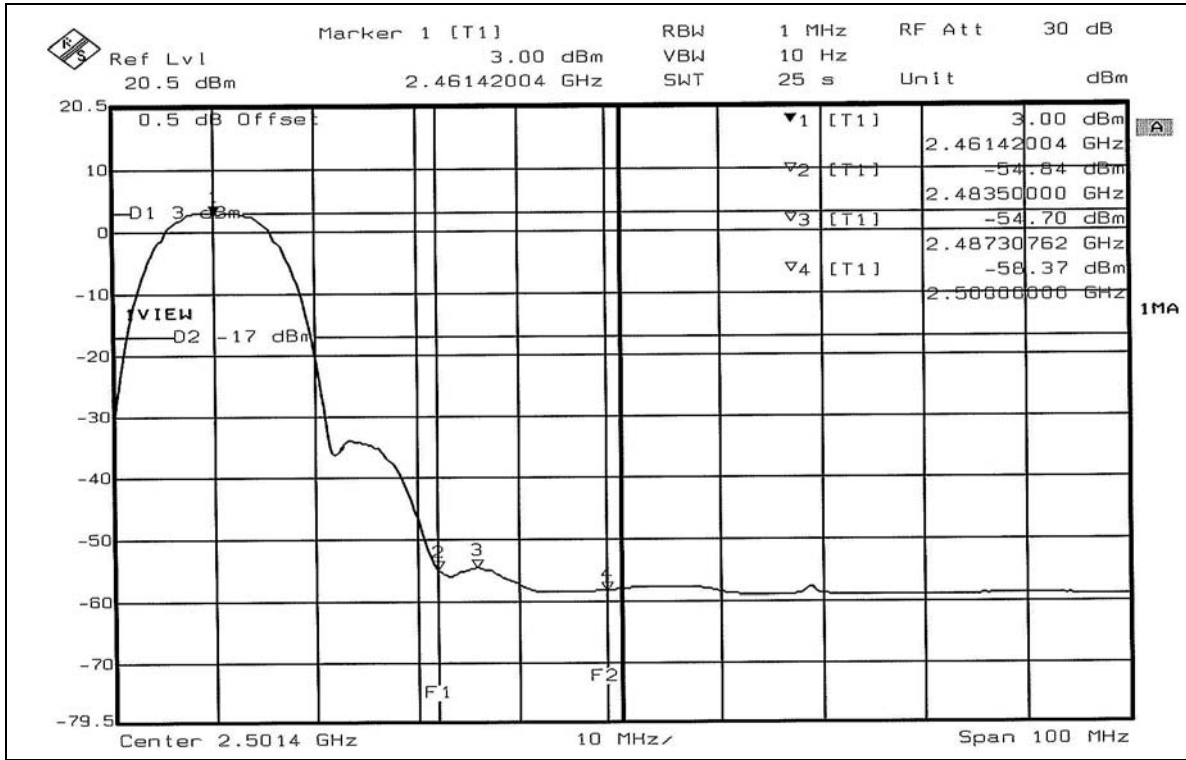



802.11g OFDM modulation

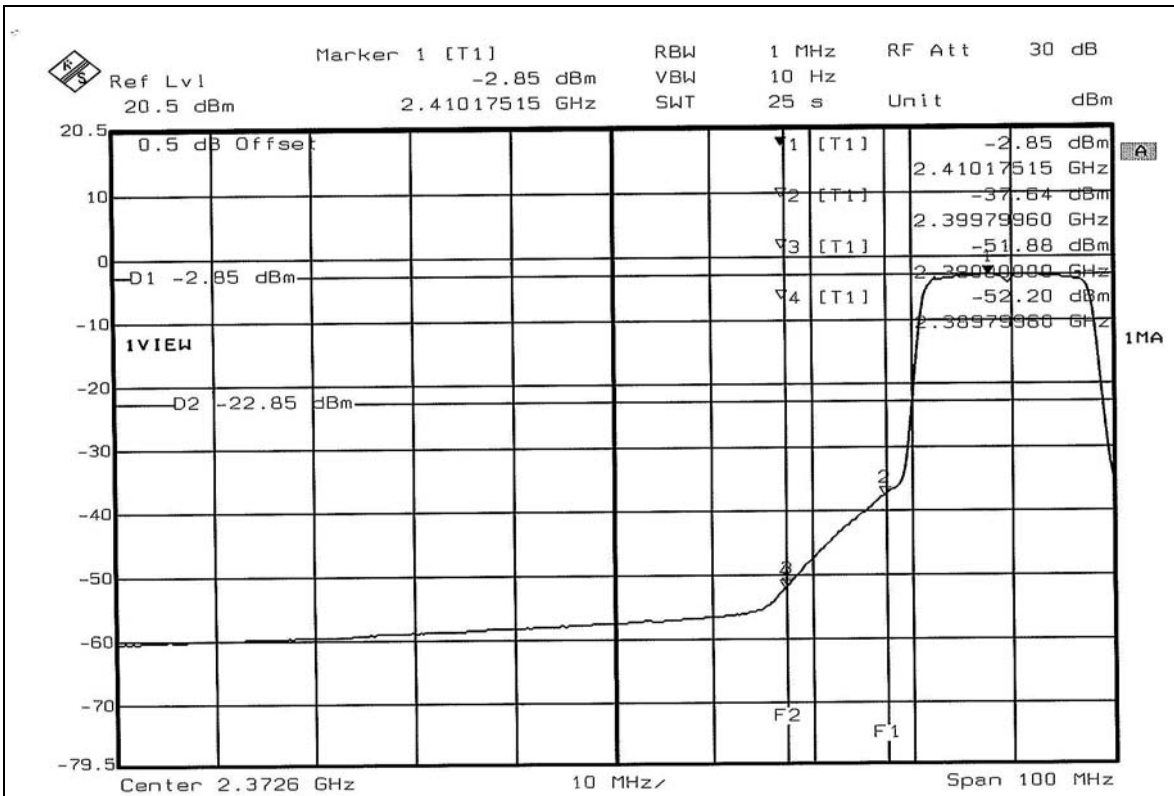
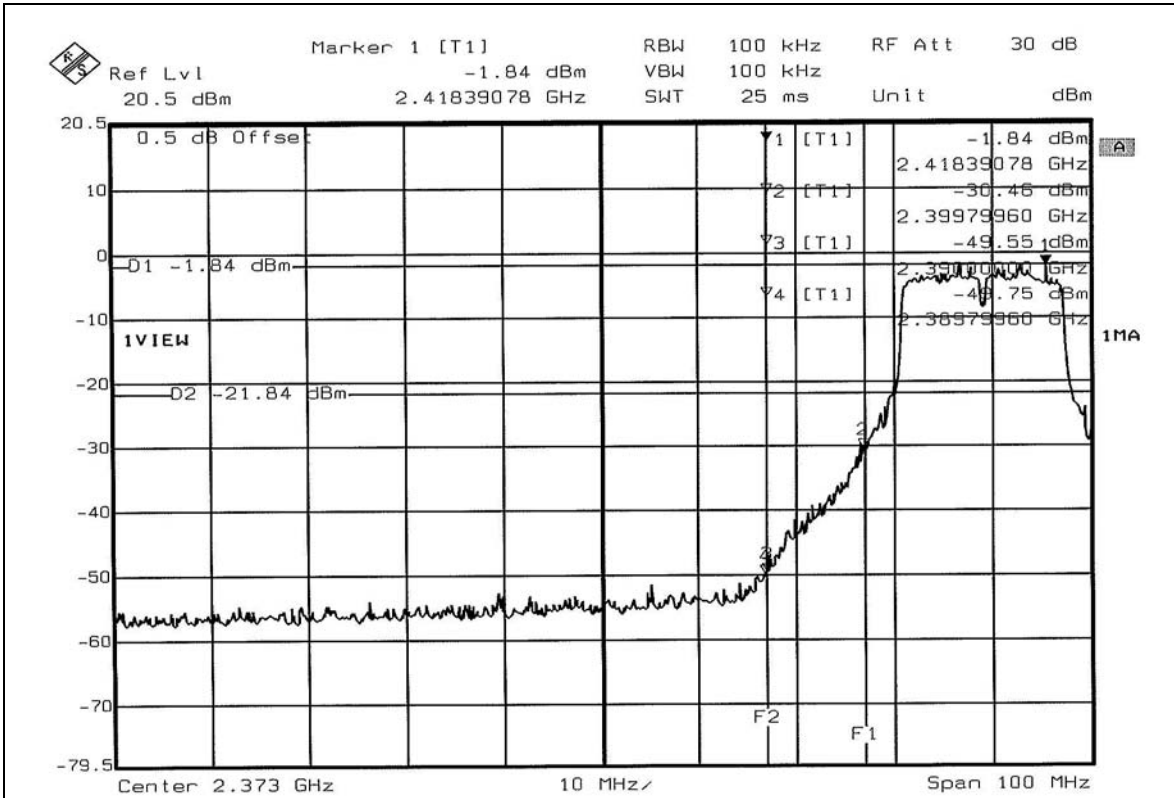

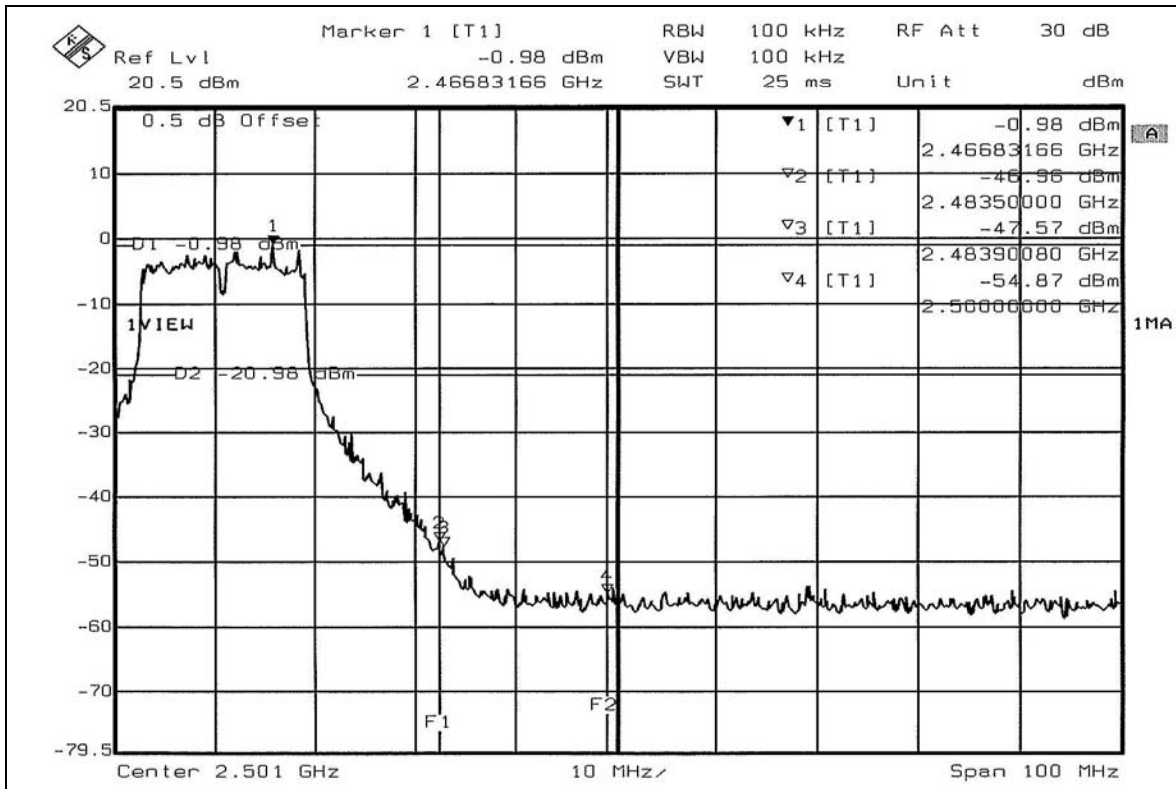
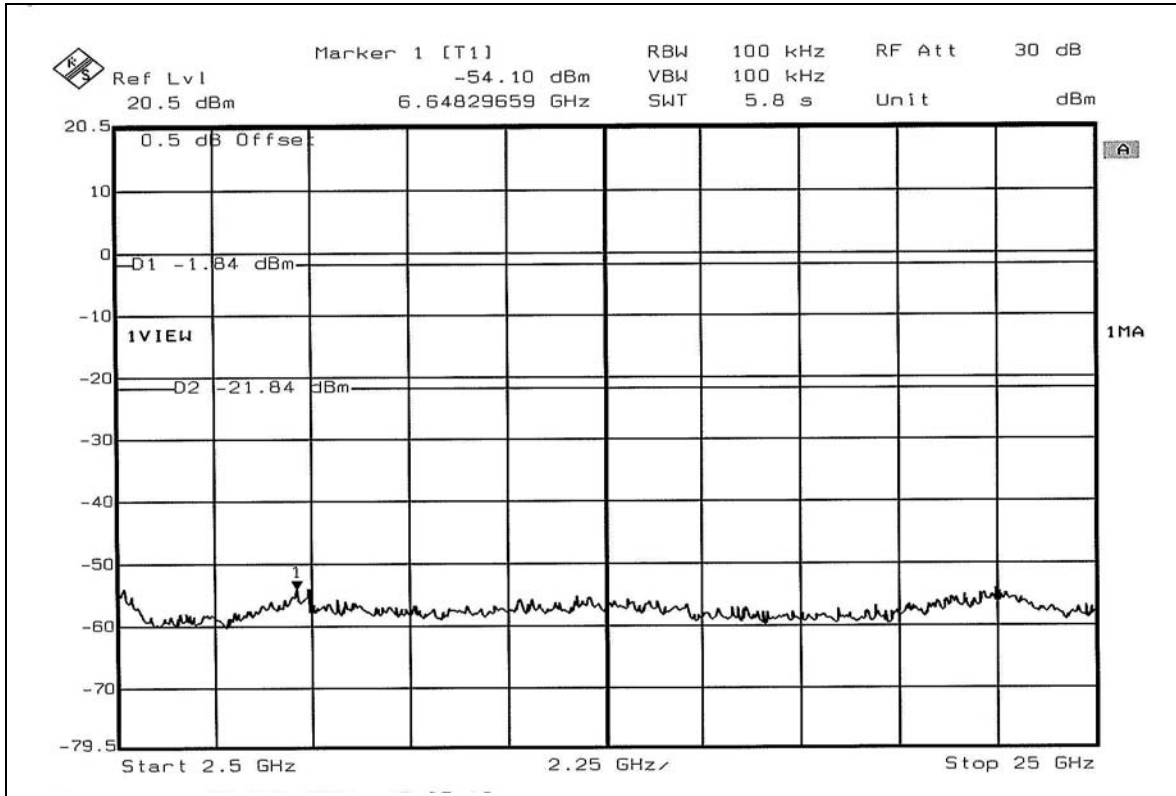

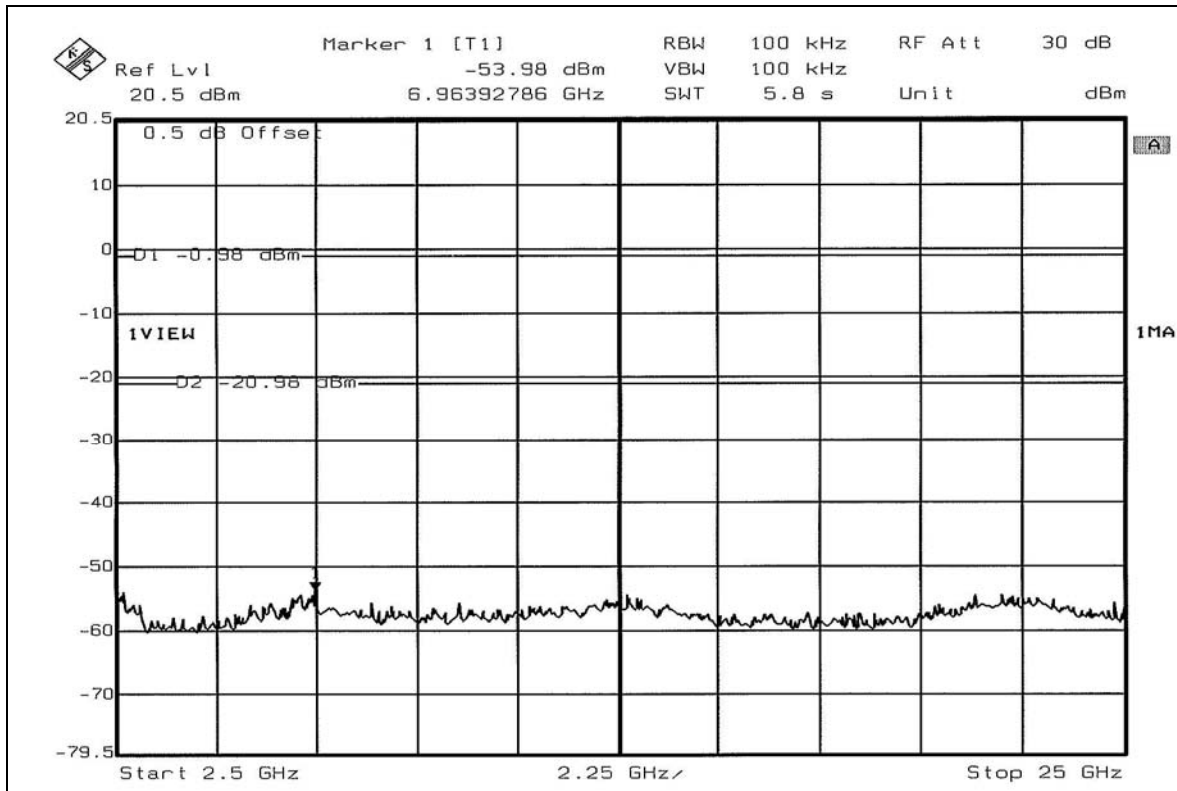
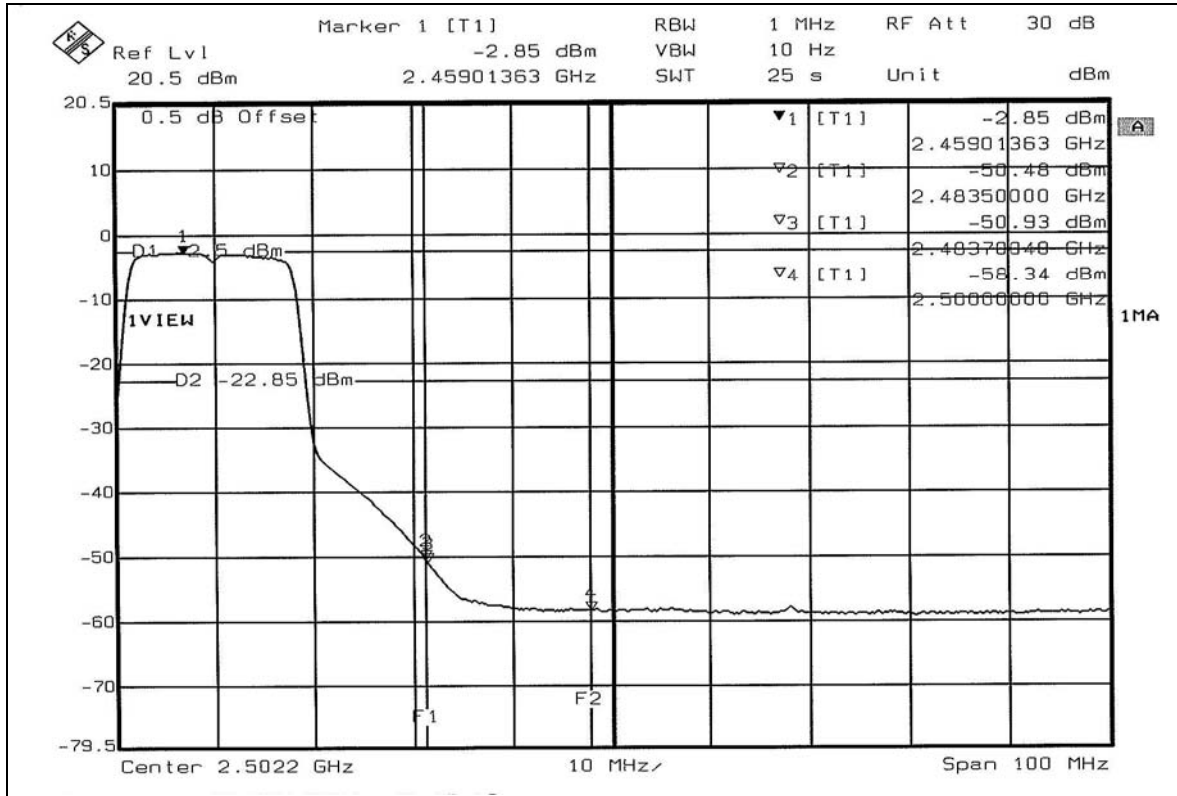



802.11g Turbo OFDM modulation

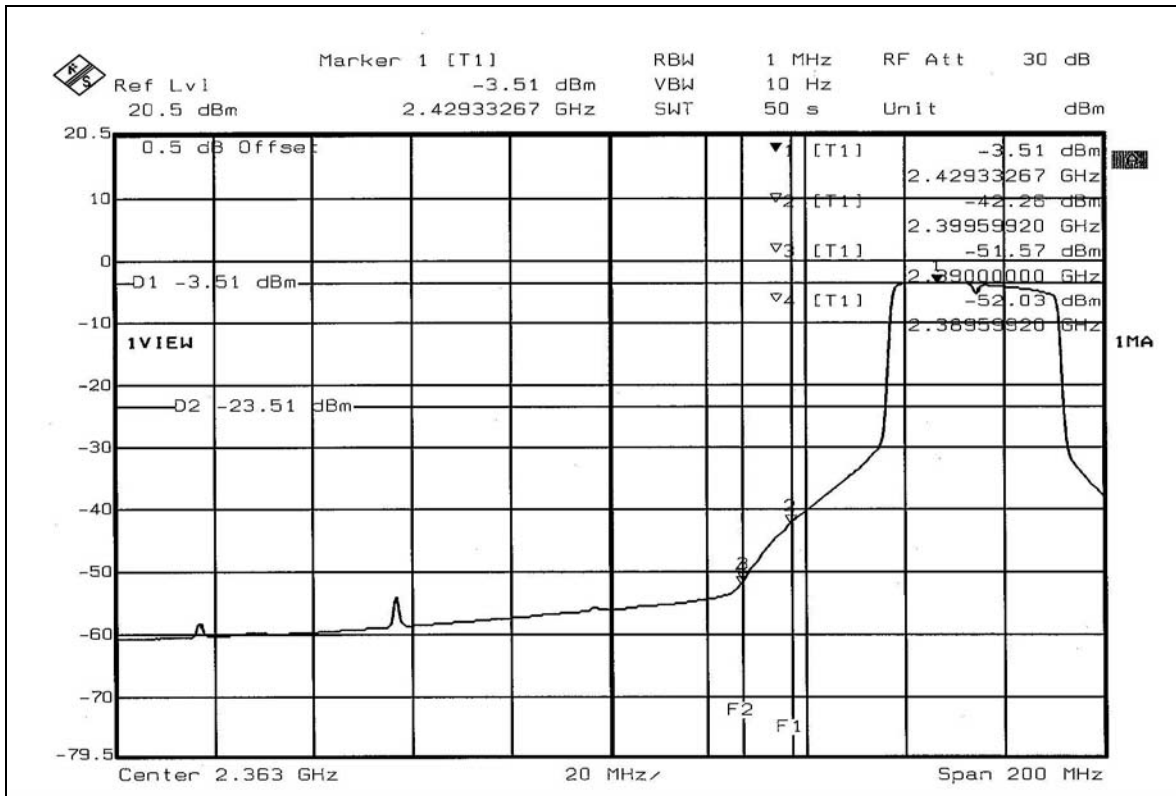
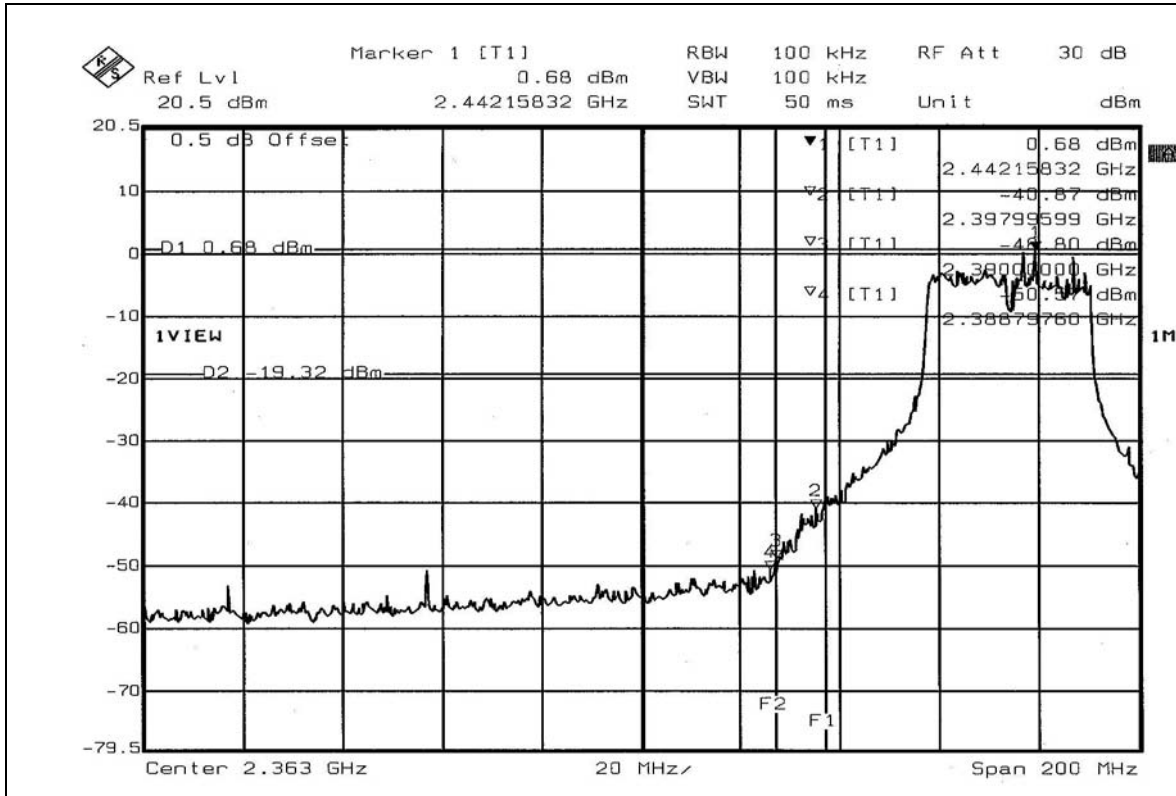

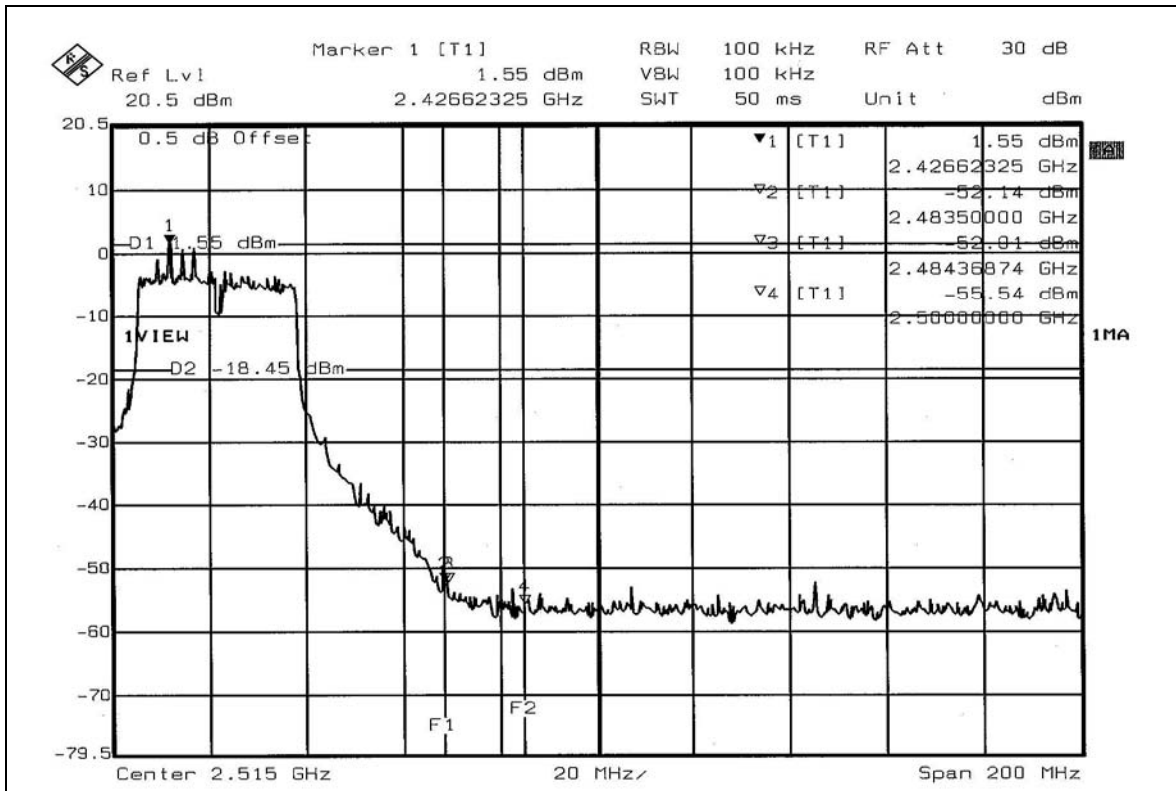
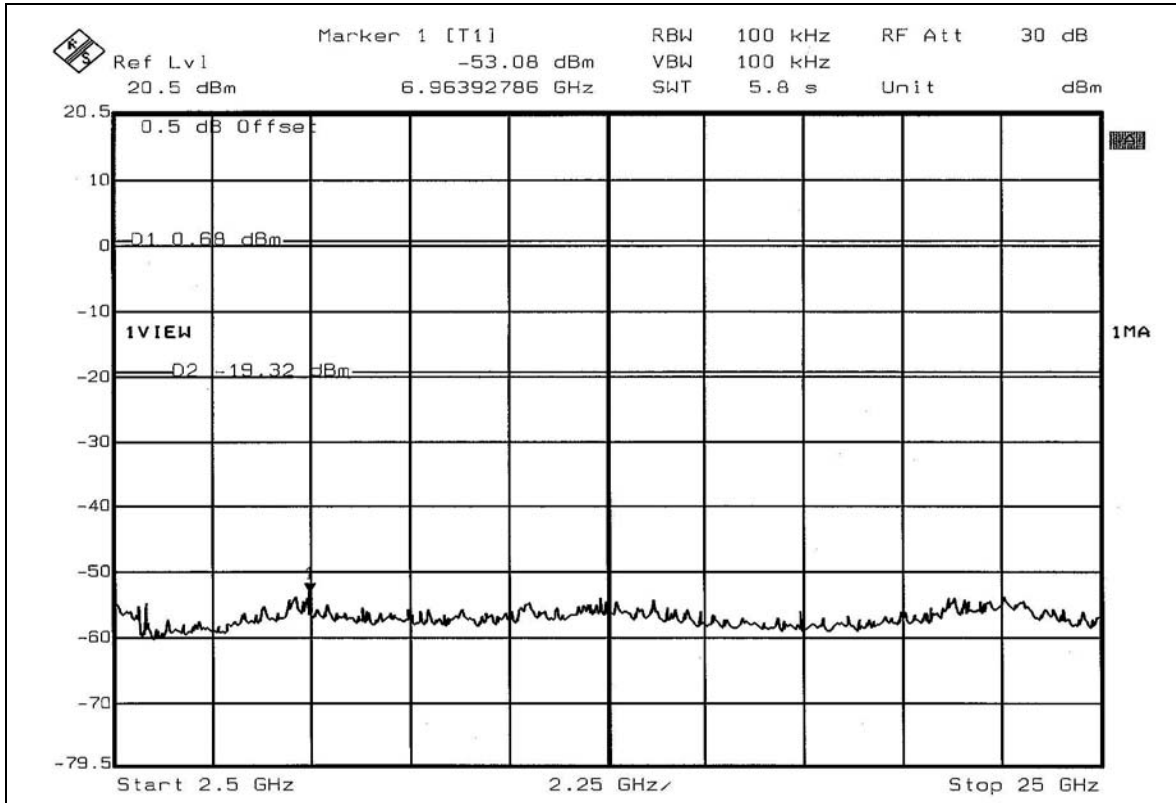

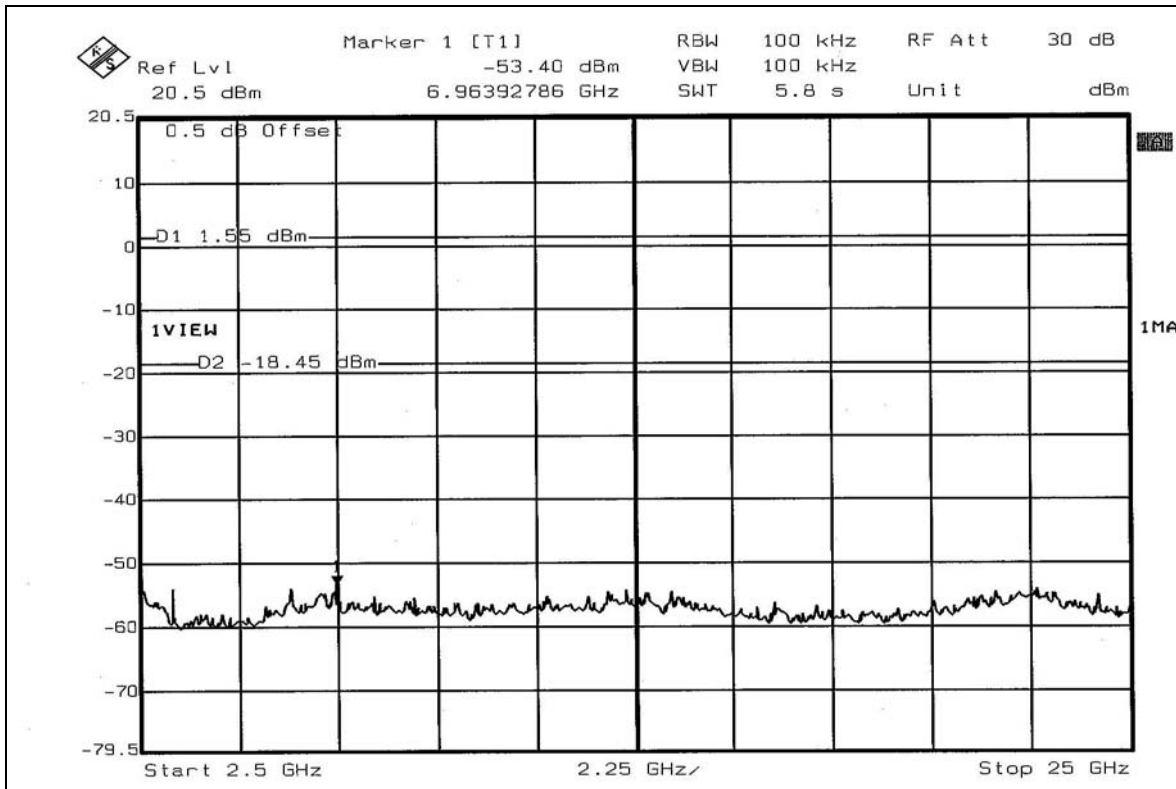
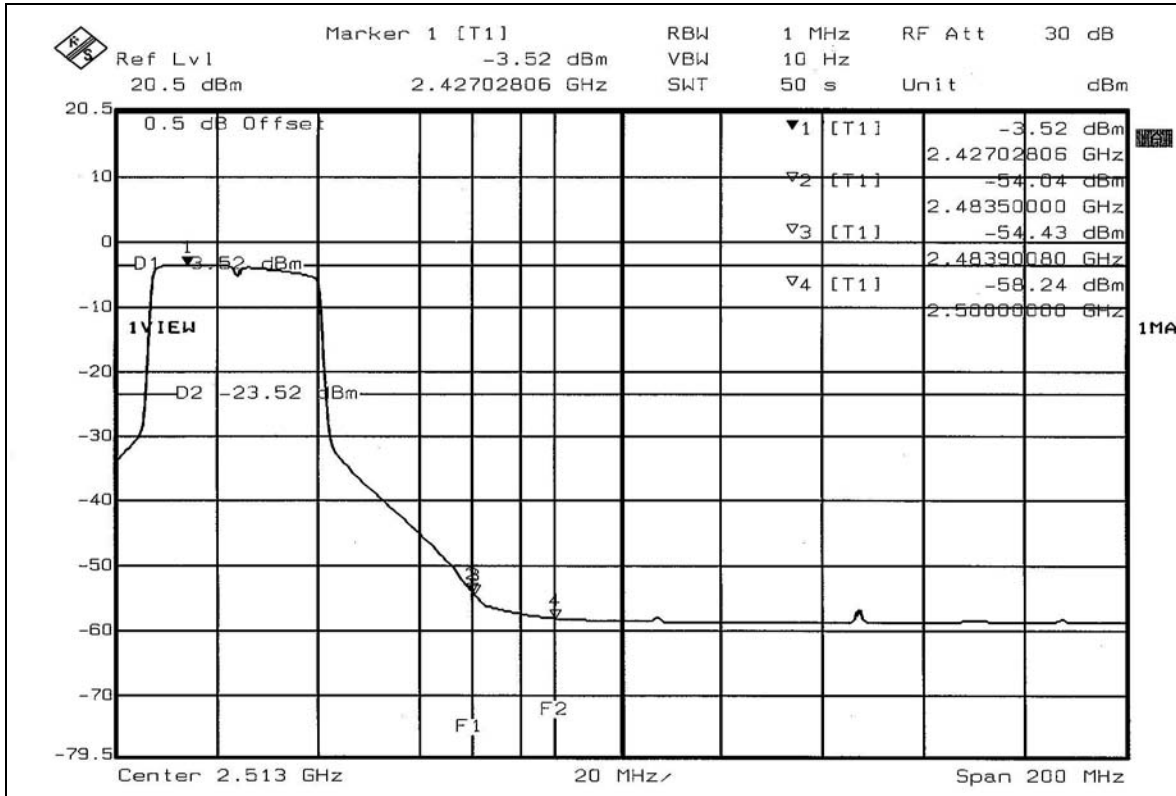



4.7 ANTENNA REQUIREMENT

4.7.1 STANDARD APPLICABLE

For intentional device, according to FCC 47 CFR Section 15.203, an intentional radiator shall be designed to ensure that no antenna other than that furnished by the responsible party shall be used with the device. And according to FCC 47 CFR Section 15.247 (b), if transmitting antennas of directional gain greater than 6dBi are used, the power shall be reduced by the amount in dB that the directional gain of the antenna exceeds 6dBi.

4.7.2 ANTENNA CONNECTED CONSTRUCTION

The antenna used in this product is Dipole antenna with RSMA antenna connector. The maximum Gain of the antenna is 2.0dBi.

5. PHOTOGRAPHS OF THE TEST CONFIGURATION

CONDUCTED EMISSION TEST



RADIATED EMISSION TEST

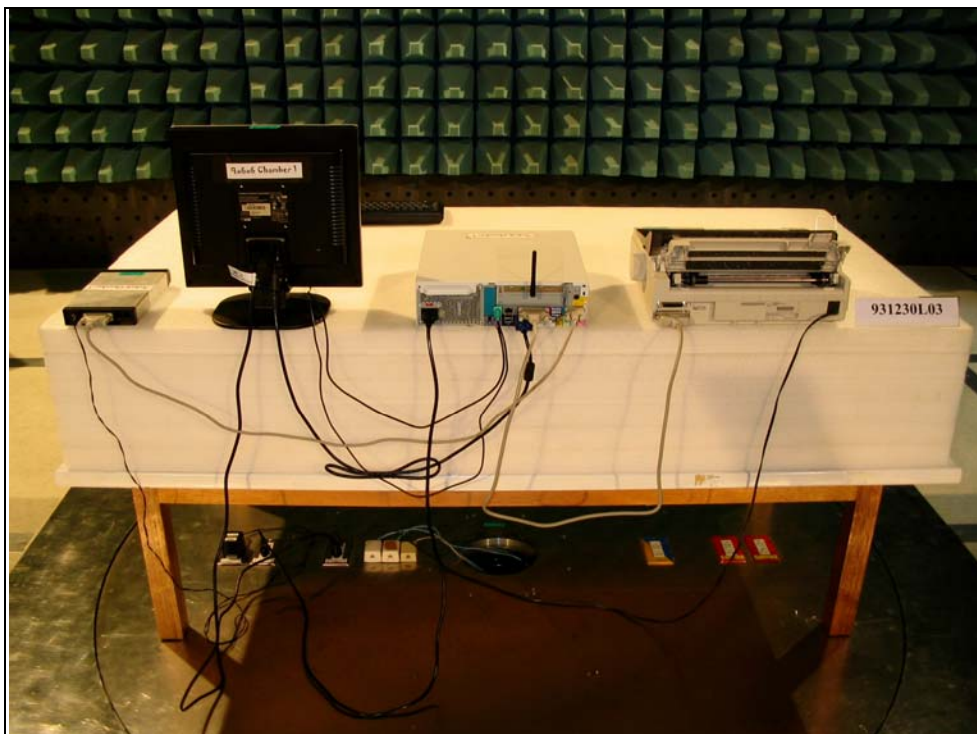



6. INFORMATION ON THE TESTING LABORATORIES

We, ADT Corp., were founded in 1988 to provide our best service in EMC, Radio, Telecom and Safety consultation. Our laboratories are accredited and approved by the following approval agencies according to ISO/IEC 17025.

USA	FCC, NVLAP, UL, A2LA
Germany	TUV Rheinland
Japan	VCCI
Norway	NEMKO
Canada	INDUSTRY CANADA , CSA
R.O.C.	CNLA, BSMI, DGT
Netherlands	Telefication
Singapore	PSB , GOST-ASIA(MOU)
Russia	CERTIS(MOU)

Copies of accreditation certificates of our laboratories obtained from approval agencies can be downloaded from our web site:

www.adt.com.tw/index.5/phtml. If you have any comments, please feel free to contact us at the following:

Linko EMC/RF Lab:

Tel: 886-2-26052180

Fax: 886-2-26052943

Hsin Chu EMC/RF Lab:

Tel: 886-3-5935343

Fax: 886-3-5935342

Hwa Ya EMC/RF/Safety Telecom Lab:

Tel: 886-3-3183232

Fax: 886-3-3185050

Linko RF Lab.

Tel: 886-3-3270910

Fax: 886-3-3270892

Web Site: www.adt.com.tw

The address and road map of all our labs can be found in our web site also