



FCC TEST REPORT

REPORT NO.: RF921015R03

MODEL NO.: GL2554MP-1A

RECEIVED: October 15, 2003

TESTED: September 23 ~ November 27, 2003

APPLICANT: GLOBAL SUN TECHNOLOGY INC.

ADDRESS: NO.13 Tung Yuan Rd., Jung Li Industrial Park
Jung Li City, Tao Yuan Hsien, Taiwan

ISSUED BY: Advance Data Technology Corporation

LAB LOCATION: 47 14th Lin, Chiapau Tsun, Linko, Taipei,
Taiwan, R.O.C.

This test report consists of 241 pages in total. It may be duplicated completely for legal use with the approval of the applicant. It should not be reproduced except in full, without the written approval of our laboratory. The client should not use it to claim product endorsement by CNLA, NVLAP or any government agencies. The test results in the report only apply to the tested sample.



0528
ILAC MRA



Lab Code: 200102-0



Table of Contents

1.	CERTIFICATION.....	5
2.	SUMMARY OF TEST RESULTS	6
3.	GENERAL INFORMATION	8
3.1	GENERAL DESCRIPTION OF EUT	8
3.2	DESCRIPTION OF TEST MODES	9
3.3	GENERAL DESCRIPTION OF APPLIED STANDARDS.....	10
3.4	DESCRIPTION OF SUPPORT UNITS.....	11
3.5	CONFIGURATION OF SYSTEM UNDER TEST	11
4.	TEST TYPES AND RESULTS (FOR PART 802.11b & DRAFT 802.11g).....	12
4.1	CONDUCTED EMISSION MEASUREMENT.....	12
4.1.1	LIMITS OF CONDUCTED EMISSION MEASUREMENT	12
4.1.2	TEST INSTRUMENTS.....	12
4.1.3	TEST PROCEDURES.....	13
4.1.4	DEVIATION FROM TEST STANDARD	13
4.1.5	TEST SETUP.....	14
4.1.6	EUT OPERATING CONDITIONS.....	14
4.1.7	TEST RESULTS.....	15
4.2	RADIATED EMISSION MEASUREMENT	21
4.2.1	LIMITS OF RADIATED EMISSION MEASUREMENT	21
4.2.2	TEST INSTRUMENTS.....	22
4.2.3	TEST PROCEDURES	23
4.2.4	DEVIATION FROM TEST STANDARD	23
4.2.5	TEST SETUP.....	24
4.2.6	EUT OPERATING CONDITIONS	24
4.2.7	TEST RESULTS	25
4.2.8	TEST RESULTS (A).....	29
4.2.9	TEST RESULTS (B).....	41
4.2.10	TEST RESULTS (C)	53
4.3	6dB BANDWIDTH MEASUREMENT	54
4.3.1	LIMITS OF 6dB BANDWIDTH MEASUREMENT.....	54
4.3.2	TEST INSTRUMENTS.....	54
4.3.3	TEST PROCEDURE.....	55
4.3.4	DEVIATION FROM TEST STANDARD	55
4.3.5	TEST SETUP.....	55
4.3.6	EUT OPERATING CONDITIONS	55
4.3.7	TEST RESULTS (A).....	56
4.3.8	TEST RESULTS (B).....	60
4.3.9	TEST RESULTS (C)	64
4.4	MAXIMUM PEAK OUTPUT POWER.....	66
4.4.1	LIMITS OF MAXIMUM PEAK OUTPUT POWER MEASUREMENT.....	66
4.4.2	TEST INSTRUMENTS.....	66
4.4.3	TEST PROCEDURES	67
4.4.4	DEVIATION FROM TEST STANDARD	67
4.4.5	TEST SETUP.....	67



4.4.6	EUT OPERATING CONDITIONS	67
4.4.7	TEST RESULTS (A).....	68
4.4.8	TEST RESULTS (B).....	68
4.4.9	TEST RESULTS (C)	68
4.5	POWER SPECTRAL DENSITY MEASUREMENT	69
4.5.1	LIMITS OF POWER SPECTRAL DENSITY MEASUREMENT	69
4.5.2	TEST INSTRUMENTS.....	69
4.5.3	TEST PROCEDURE.....	70
4.5.4	DEVIATION FROM TEST STANDARD.....	70
4.5.5	TEST SETUP.....	70
4.5.6	EUT OPERATING CONDITION.....	70
4.5.7	TEST RESULTS (A).....	71
4.5.8	TEST RESULTS (B).....	75
4.5.9	TEST RESULTS (C)	79
4.6	BAND EDGES MEASUREMENT.....	81
4.6.1	LIMITS OF BAND EDGES MEASUREMENT	81
4.6.2	TEST INSTRUMENTS.....	81
4.6.3	TEST PROCEDURE.....	81
4.6.4	DEVIATION FROM TEST STANDARD.....	81
4.6.5	EUT OPERATING CONDITION.....	81
4.6.6	TEST RESULTS (A).....	82
4.6.7	TEST RESULTS (B).....	85
4.6.8	TEST RESULTS (C)	88
4.7	ANTENNA REQUIREMENT	91
4.7.1	STANDARD APPLICABLE.....	91
4.7.2	ANTENNA CONNECTED CONSTRUCTION	91
5.	TEST TYPES AND RESULTS (FOR PART 802.11a).....	92
5.1	CONDUCTED EMISSION MEASUREMENT.....	92
5.1.1	LIMITS OF CONDUCTED EMISSION MEASUREMENT	92
5.1.2	TEST INSTRUMENTS.....	92
5.1.3	TEST PROCEDURES	93
5.1.4	DEVIATION FROM TEST STANDARD.....	93
5.1.5	TEST SETUP.....	94
5.1.6	EUT OPERATING CONDITIONS	94
5.1.7	TEST RESULTS	95
5.2	RADIATED EMISSION MEASUREMENT.....	97
5.2.1	LIMITS OF RADIATED EMISSION MEASUREMENT	97
5.2.2	LIMITS OF UNWANTED EMISSION OUT OF THE RESTRICTED BANDS..	98
5.2.3	TEST INSTRUMENTS.....	99
5.2.4	TEST PROCEDURES	100
5.2.5	DEVIATION FROM TEST STANDARD.....	100
5.2.6	TEST SETUP.....	101
5.2.7	EUT OPERATING CONDITIONS	101
5.2.8	TEST RESULTS	102
5.2.9	TEST RESULTS (MODE 1)	106
5.2.10	TEST RESULTS (MODE 2)	112
5.2.11	TEST RESULTS (MODE 2)	118



5.2.12 TEST RESULTS (MODE 3) 123

5.2.13 TEST RESULTS (MODE 4) 129

5.3 PEAK TRANSMIT POWER MEASUREMENT 135

5.3.1 LIMITS OF PEAK TRANSMIT POWER MEASUREMENT 135

5.3.2 TEST INSTRUMENTS 135

5.3.3 TEST PROCEDURE 136

5.3.4 DEVIATION FROM TEST STANDARD 136

5.3.5 TEST SETUP 136

5.3.6 EUT OPERATING CONDITIONS 136

5.3.7 TEST RESULTS 137

5.4 PEAK POWER EXCURSION MEASUREMENT 174

5.4.1 LIMITS OF PEAK POWER EXCURSION MEASUREMENT 174

5.4.2 TEST INSTRUMENTS 174

5.4.3 TEST PROCEDURE 175

5.4.4 DEVIATION FROM TEST STANDARD 175

5.4.5 TEST SETUP 175

5.4.6 EUT OPERATING CONDITIONS 175

5.4.7 TEST RESULTS 176

5.5 PEAK POWER SPECTRAL DENSITY MEASUREMENT 196

5.5.1 LIMITS OF PEAK POWER SPECTRAL DENSITY MEASUREMENT 196

5.5.2 TEST INSTRUMENTS 196

5.5.3 TEST PROCEDURES 196

5.5.4 DEVIATION FROM TEST STANDARD 196

5.5.5 TEST SETUP 197

5.5.6 EUT OPERATING CONDITIONS 197

5.5.7 TEST RESULTS 198

5.5.8 TEST RESULTS 205

5.5.9 TEST RESULTS 211

5.6 FREQUENCY STABILITY 218

5.6.1 LIMITS OF FREQUENCY STABILITY MEASUREMENT 218

5.6.2 TEST INSTRUMENTS 218

5.6.3 TEST PROCEDURE 218

5.6.4 DEVIATION FROM TEST STANDARD 219

5.6.5 TEST SETUP 219

5.6.6 EUT OPERATING CONDITION 219

5.6.7 TEST RESULTS (MODE1 、 MODE 2 、 MODE 3 、 MODE 4) 220

5.7 BAND EDGES MEASUREMENT 221

5.7.1 TEST INSTRUMENTS 221

5.7.2 TEST PROCEDURE 221

5.7.3 EUT OPERATING CONDITION 221

5.7.4 TEST RESULTS 221

5.8 ANTENNA REQUIREMENT 228

5.8.1 STANDARD APPLICABLE 228

5.8.2 ANTENNA CONNECTED CONSTRUCTION 228

6. PHOTOGRAPHS OF THE TEST CONFIGURATION 229

7. INFORMATION ON THE TESTING LABORATORIES 241



1. CERTIFICATION

PRODUCT : 2.4/5GHz 54Mbps Wireless Mini PCI Card
BRAND NAME : GLOBAL SUN
MODEL NO. : GL2554MP-1A
TEST ITEM: ENGINEERING SAMPLE
APPLICANT : GLOBAL SUN TECHNOLOGY INC.
STANDARDS : 47 CFR Part 15, Subpart C (Section 15.247),
Subpart E (Section 15.407), ANSI C63.4-1992

We, **Advance Data Technology Corporation**, hereby certify that one sample of the designation has been tested in our facility from September 23 ~ November 27, 2003. The test record, data evaluation and Equipment Under Test (EUT) configurations represented herein are true and accurate accounts of the measurements of the sample's EMC characteristics under the conditions herein specified.

PREPARED BY: Wendy Liao , DATE: November 02, 2003
Wendy Liao
APPROVED BY: Ellis Eu , DATE: November 02, 2003
Ellis Eu / Manager



2. SUMMARY OF TEST RESULTS

The EUT has been tested according to the following specifications:

APPLIED STANDARD: 47 CFR Part 15, Subpart C			
Standard Section	Test Type and Limit	Result	REMARK
15.207	AC Power Conducted Emission	PASS	Meet the requirement of limit Minimum passing margin is -12.03dB at 0.177MHz
15.247(a)(2)	Spectrum Bandwidth of a Direct Sequence Spread Spectrum System Limit: min. 500kHz	PASS	Meet the requirement of limit
15.247(b)	Maximum Peak Output Power Limit: max. 30dBm	PASS	Meet the requirement of limit
15.247(c)	Radiated Emissions Limit: Table 15.209	PASS	Meet the requirement of limit Minimum passing margin is -2.00dB at 2390.00MHz
15.247(d)	Power Spectral Density Limit: max. 8dBm	PASS	Meet the requirement of limit
15.247(c)	Band Edge Measurement Limit: 20dB less than the peak value of fundamental frequency	PASS	Meet the requirement of limit

NOTE: The information of measurement uncertainty is available upon the customer's request.



APPLIED STANDARD: 47 CFR Part 15, Subpart E			
Standard Section	Test Type	Result	REMARK
15.407(b)(5)	AC Power Conducted Emission	PASS	Meet the requirement of limit Minimum passing margin is -15.79dB at 0.181MHz
15.407(b/1/2/3)(b)(5)	Electric Field Strength Spurious Emissions, 30MHz ~ 40000MHz	PASS	Meet the requirement of limit Minimum passing margin is -1.68dB at 11490.00MHz
15.407(a/1/2/3)	Peak Transmit Power	PASS	Meet the requirement of limit
15.407(a)(6)	Peak Power Excursion	PASS	Meet the requirement of limit
15.407(a/1/2/3)	Peak Power Spectral Density	PASS	Meet the requirement of limit
15.407(g)	Frequency Stability	PASS	Meet the requirement of limit

NOTE: The information of measurement uncertainty is available upon the customer's request.



3. GENERAL INFORMATION

3.1 GENERAL DESCRIPTION OF EUT

PRODUCT	2.4/5GHz 54Mbps Wireless Mini PCI Card
MODEL NO.	GL2554MP-1A
POWER SUPPLY	3.3VDC from host equipment
MODULATION TYPE	BPSK, QPSK, CCK, 16QAM, 64QAM
MODULATION TECHNOLOGY	DSSS, OFDM
TRANSFER RATE	54/48/36/24/18/12/9/6Mbps *(Turbo mode : up to 108Mbps)
FREQUENCY RANGE	802.11b and draft 802.11g: 2412~2462MHz 802.11a: 5.15~5.35GHz and 5.725~5.825GHz
NUMBER OF CHANNEL	802.11b and 802.11g: 11 / 1 for Turbo mode 802.11a: 12 for Normal mode / 5 for Turbo mode
CHANNEL SPACING	802.11b and 802.11g: 5MHz 802.11a: 20MHz for Normal mode / 40MHz for Turbo mode
OUTPUT POWER	802.11b and draft 802.11g: 18.00dBm 802.11a: 16.52dBm
DATA CABLE	NA
ANTENNA TYPE	Dipole antenna and PIFA antennas (see note 3)
I/O PORTS	NA
ASSOCIATED DEVICES	NA

NOTE:

- The EUT operates in both the 5GHz and 2.4GHz Bands and compatibility with 802.11a and 802.11g technology.
- IEEE 802.11a, 802.11b, and Draft 802.11g Compliant.
- There are four types of antennas provided to this EUT, and four test modes in the following table:

Item	Test Mode	Antenna Type	Antenna Gain (dBi)
1	Mode 1	Dipole	3
2	Mode 2	PIFA	5
3	Mode 3	PIFA	3
4	Mode 4	PIFA	1.5

- For more detailed features description, please refer to the manufacturer's specifications or User's Manual.



3.2 DESCRIPTION OF TEST MODES

For 802.11b and draft 802.11g: Eleven channels are provided to this EUT.

Channel	Frequency	Channel	Frequency
1	2412 MHz	7	2442 MHz
2	2417 MHz	8	2447 MHz
3	2422 MHz	9	2452 MHz
4	2427 MHz	10	2457 MHz
5	2432 MHz	11	2462 MHz
6	2437 MHz		

NOTE:

1. Below 1GHz, the channel 1, 6, and 11 were pre-tested in chamber. The channel 11, worst case one, was chosen for final test.
2. Above 1GHz, the channel 1, 6, and 11 were tested individually.
3. Transfer rate of 11Mbps with CCK technique and 6Mbps with OFDM technique, the worst case, was chosen for final test.
4. One turbo mode at frequency 2437MHz.
5. Test result A is for CCK technique, test result B is for OFDM technique and test result C is for OFDM technique in Turbo mode which presented in Section 4.

For 802.11a: Twelve channels are provided to this EUT for Normal mode.

Channel	Frequency	Channel	Frequency
1	5180 MHz	7	5300 MHz
2	5200 MHz	8	5320 MHz
3	5220 MHz	9	5745 MHz
4	5240 MHz	10	5765 MHz
5	5260 MHz	11	5785 MHz
6	5280 MHz	12	5805 MHz

Five channels are provided to this EUT for Turbo Mode.

Channel	Frequency	Channel	Frequency
1	5210 MHz	4	5760 MHz
2	5250 MHz	5	5800 MHz
3	5290 MHz		

NOTE:

1. The EUT was tested in both normal mode (channel bandwidth of approximately 30MHz) and turbo mode (channel bandwidth of approximately 60MHz).
2. "Normal Mode" allows data rates of up to 54Mbps. The device was, therefore, tested in Normal mode at the data rate that produced the highest output power for normal mode (6Mbps).
3. "Turbo Mode" allows data rates of up to 108Mbps. At data rates higher than 12Mbps the PA gain is reduced to improve signal fidelity. The device was, therefore, tested in turbo mode at the data rate that produced the highest output power for turbo mode (12Mbps).
4. Channel 1, 4, 5, 8, 9 and 12 are the closest frequencies to the band edge, were chosen for final test of Normal Mode.
5. Channel 1 ~ 5 were chosen for final test of turbo mode.



3.3 GENERAL DESCRIPTION OF APPLIED STANDARDS

The EUT is a 2.4/5GHz 54Mbps Wireless Mini PCI Card. According to the specifications of the manufacturer, it must comply with the requirements of the following standards:

**FCC 47 CFR Part 15, Subpart C. (15.247),
Subpart E (15.407). ANSI C63.4 : 1992**

All test items have been performed and recorded as per the above standards.

NOTE: The EUT is also considered as a kind of computer peripheral, because the connection to computer is necessary for typical use. It has been verified to comply with the requirements of FCC Part 15, Subpart B, Class B (DoC). The test report has been issued separately.



3.4 DESCRIPTION OF SUPPORT UNITS

The EUT has been tested as an independent unit together with other necessary accessories or support units. The following support units or accessories were used to form a representative test configuration during the tests.

NO.	PRODUCT	BRAND	MODEL NO.	SERIAL NO.	FCC ID
1	NOTEBOOK	DELL	PP01L	TW-0791UH-12800-123-5423	FCC DoC Approved
2	MODEM	ACEEX	1414	980020503	IFAXDM1414
3	PRINTER	EPSON	LQ-300+	DCGY017096	FCC DoC Approved

NO.	SIGNAL CABLE DESCRIPTION OF THE ABOVE SUPPORT UNITS
1	NA
2	1.2 m braid shielded wire, terminated with DB25 and DB9 connector via metallic frame, w/o core.
3	1.2m braid shielded wire, terminated with DB25 and Centronics connector via metallic frame, w/o core

NOTE: All power cords of the above support units are non shielded (1.8m).

3.5 CONFIGURATION OF SYSTEM UNDER TEST

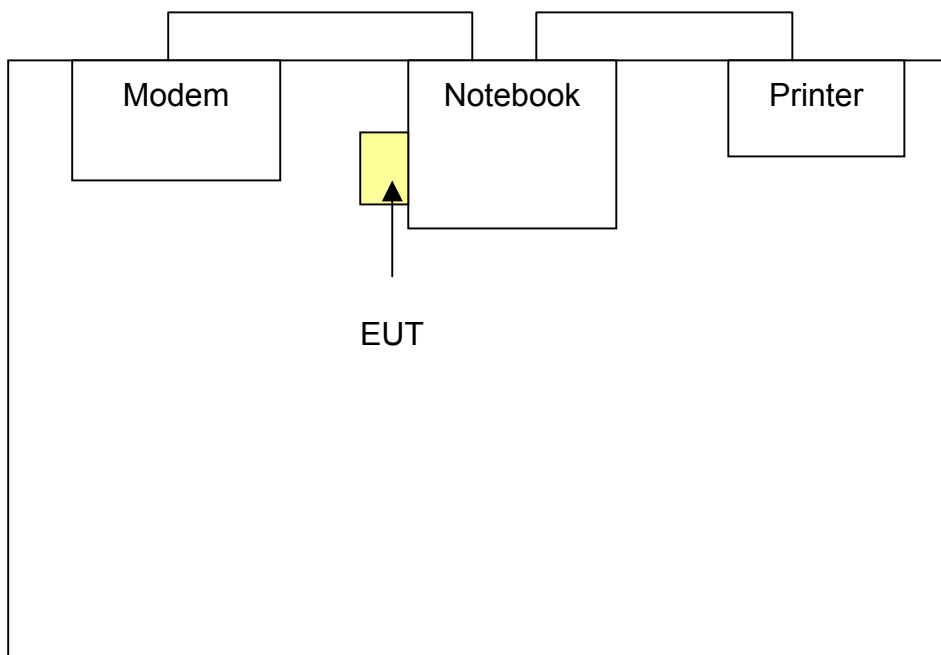



4. TEST TYPES AND RESULTS (FOR PART 802.11b & draft 802.11g)

4.1 CONDUCTED EMISSION MEASUREMENT

4.1.1 LIMITS OF CONDUCTED EMISSION MEASUREMENT

FREQUENCY OF EMISSION (MHz)	CONDUCTED LIMIT (dB μ V)	
	Quasi-peak	Average
0.15-0.5	66 to 56	56 to 46
0.5-5	56	46
5-30	60	50

- NOTE:**
1. The lower limit shall apply at the transition frequencies.
 2. The limit decreases in line with the logarithm of the frequency in the range of 0.15 to 0.50 MHz.
 3. All emanations from a class A/B digital device or system, including any network of conductors and apparatus connected thereto, shall not exceed the level of field strengths specified above.

4.1.2 TEST INSTRUMENTS

DESCRIPTION & MANUFACTURER	MODEL NO.	SERIAL NO.	CALIBRATED UNTIL
ROHDE & SCHWARZ Test Receiver	ESCS 30	838251/021	Jan. 20, 2004
ROHDE & SCHWARZ Artificial Mains Network (for EUT)	ESH3-Z5	100218	Dec. 18, 2003
ROHDE & SCHWARZ Artificial Mains Network (for peripherals)	ESH3-Z5	100219	Dec. 18, 2003
ROHDE & SCHWARZ Artificial Mains Network (for peripherals)	ESH3-Z5	100220	Dec. 18, 2003
*ROHDE & SCHWARZ 4-wire ISN	ENY41	837032/016	Nov. 19 2004
*ROHDE & SCHWARZ 2-wire ISN	ENY22	837497/016	Nov. 19 2004
Software	Cond-V2M3	NA	NA
RF cable (JYEBAO)	5D-FB	Cable-C10.01	May 01, 2004
SUHNER Terminator (For ROHDE & SCHWARZ LISN)	65BNC-5001	E1-010770	Mar. 24, 2004
SUHNER Terminator (For ROHDE & SCHWARZ LISN)	65BNC-5001	E1-010773	Apr. 06, 2004

- NOTE:**
1. The calibration interval of the above test instruments is 12 months and the calibrations are traceable to NML/ROC and NIST/USA.
 2. “*”: These equipment are used for conducted telecom port test only (if tested).
 3. The test was performed in ADT Shielded Room No. 10.
 4. The VCCI Site Registration No. is C-1312.



4.1.3 TEST PROCEDURES

- a. The EUT was placed 0.4 meters from the conducting wall of the shielded room with EUT being connected to the power mains through a line impedance stabilization network (LISN). Other support units were connected to the power mains through another LISN. The two LISNs provide 50 ohm/ 50uH of coupling impedance for the measuring instrument.
- b. Both lines of the power mains connected to the EUT were checked for maximum conducted interference.
- c. The frequency range from 150kHz to 30MHz was searched. Emission levels over 10dB under the prescribed limits could not be reported

4.1.4 DEVIATION FROM TEST STANDARD

No deviation

4.1.5 TEST SETUP

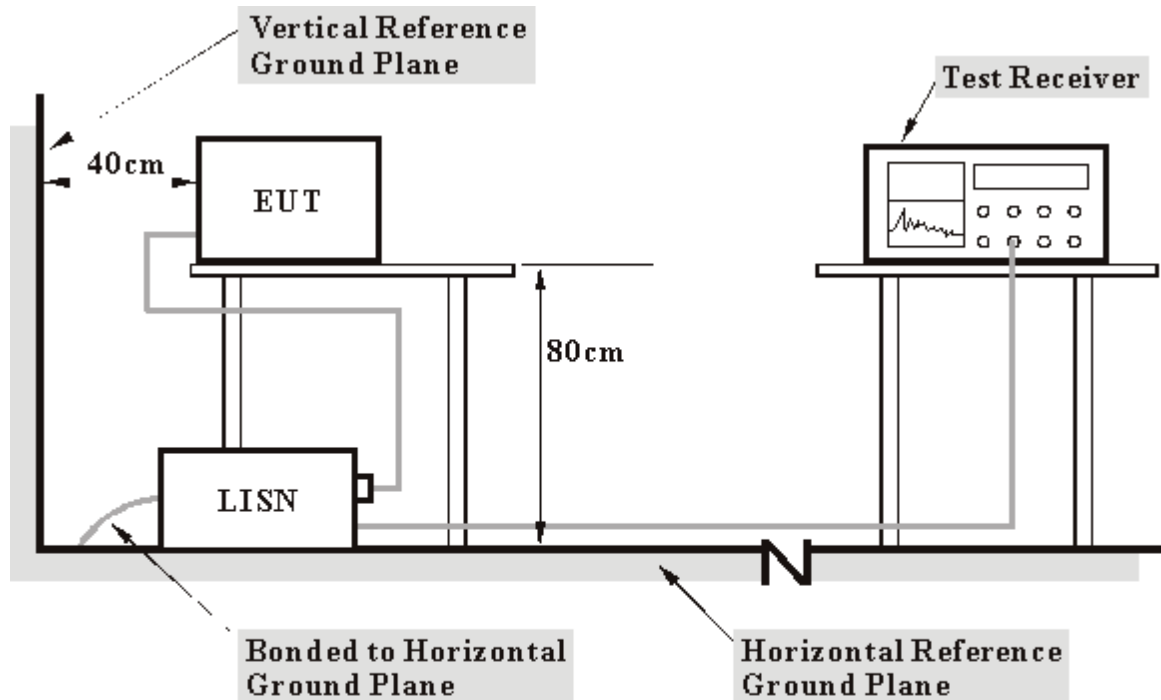

- Note:**
1. Support units were connected to second LISN.
 2. Both of LISNs (AMN) 80 cm from EUT and at the least 80 cm from other units and other metal planes support units.

For the actual test configuration, please refer to the related item – Photographs of the Test Configuration.

4.1.6 EUT OPERATING CONDITIONS

- a. Plug the EUT into the computer system placed on a testing table.
- b. The computer system ran a test program to enable EUT under transmission/receiving condition continuously at specific channel frequency.
- c. The computer system sent "H" messages to its screen.
- d. The computer system sent "H" messages to modem.
- e. The computer system sent "H" messages to printer, and the printer prints them on paper.



4.1.7 TEST RESULTS

EUT	2.4/5GHz 54Mbps Wireless Mini PCI Card	MODEL	GL2554MP-1A
MODE	Channel 1	6dB BANDWIDTH	9 kHz
		PHASE	Line (L)
ENVIRONMENTAL CONDITIONS	25deg. C, 60%RH, 991hPa	INPUT POWER (SYSTEM)	120Vac, 60Hz
TESTED BY	Martin Lee		

No	Freq. [MHz]	Corr. Factor (dB)	Reading Value [dB (uV)]		Emission Level [dB (uV)]		Limit [dB (uV)]		Margin (dB)	
			Q.P.	AV.	Q.P.	AV.	Q.P.	AV.	Q.P.	AV.
			1	0.177	0.06	52.52	-	52.58	-	64.61
2	0.236	0.06	45.78	-	45.84	-	62.24	52.24	-16.40	-
3	0.470	0.07	33.37	-	33.44	-	56.51	46.51	-23.07	-
4	3.949	0.22	31.52	-	31.74	-	56.00	46.00	-24.26	-
5	13.203	0.51	32.12	-	32.63	-	60.00	50.00	-27.37	-
6	22.179	0.75	33.40	-	34.15	-	60.00	50.00	-25.85	-

- REMARKS:**
1. Q.P. and AV. are abbreviations of quasi-peak and average individually.
 2. "-": The Quasi-peak reading value also meets average limit and measurement with the average detector is unnecessary.
 3. The emission levels of other frequencies were very low against the limit.
 4. Margin value = Emission level - Limit value
 5. Correction factor = Insertion loss + Cable loss
 6. Emission Level = Correction Factor + Reading Value.

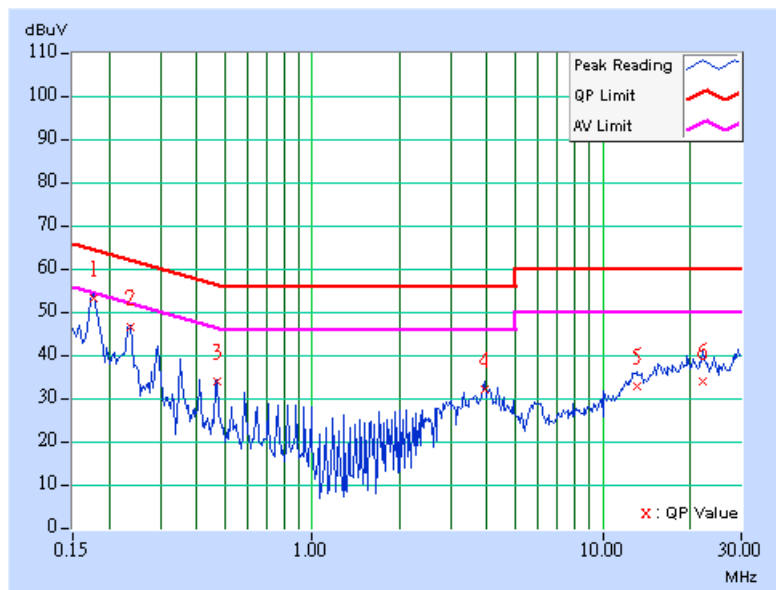



EUT	2.4/5GHz 54Mbps Wireless Mini PCI Card	MODEL	GL2554MP-1A
MODE	Channel 1	6dB BANDWIDTH	9 kHz
		PHASE	Neutral (N)
ENVIRONMENTAL CONDITIONS	25deg. C, 60%RH, 991hPa	INPUT POWER (SYSTEM)	120Vac, 60Hz
TESTED BY	Martin Lee		

No	Freq. [MHz]	Corr. Factor (dB)	Reading Value [dB (uV)]		Emission Level [dB (uV)]		Limit [dB (uV)]		Margin (dB)	
			Q.P.	AV.	Q.P.	AV.	Q.P.	AV.	Q.P.	AV.
			1	0.177	0.05	51.28	-	51.33	-	64.61
2	0.295	0.05	38.08	-	38.13	-	60.40	50.40	-22.27	-
3	0.591	0.08	27.68	-	27.76	-	56.00	46.00	-28.24	-
4	4.443	0.22	29.95	-	30.17	-	56.00	46.00	-25.83	-
5	9.419	0.37	27.44	-	27.81	-	60.00	50.00	-32.19	-
6	19.616	0.51	33.78	-	34.29	-	60.00	50.00	-25.71	-

- REMARKS:**
1. Q.P. and AV. are abbreviations of quasi-peak and average individually.
 2. "-": The Quasi-peak reading value also meets average limit and measurement with the average detector is unnecessary.
 3. The emission levels of other frequencies were very low against the limit.
 4. Margin value = Emission level - Limit value
 5. Correction factor = Insertion loss + Cable loss
 6. Emission Level = Correction Factor + Reading Value.

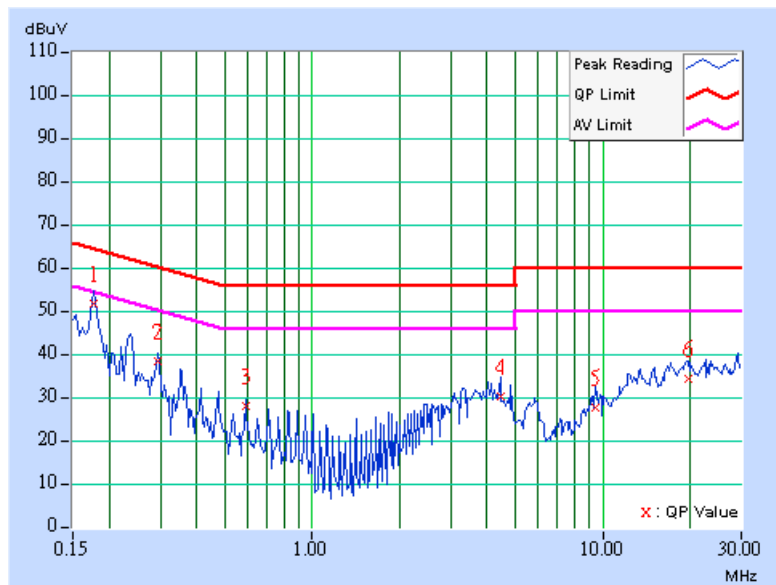



EUT	2.4/5GHz 54Mbps Wireless Mini PCI Card	MODEL	GL2554MP-1A
MODE	Channel 6	6dB BANDWIDTH	9 kHz
		PHASE	Line (L)
ENVIRONMENTAL CONDITIONS	25deg. C, 60%RH, 991hPa	INPUT POWER (SYSTEM)	120Vac, 60Hz
TESTED BY	Martin Lee		

No	Freq. [MHz]	Corr. Factor (dB)	Reading Value [dB (uV)]		Emission Level [dB (uV)]		Limit [dB (uV)]		Margin (dB)	
			Q.P.	AV.	Q.P.	AV.	Q.P.	AV.	Q.P.	AV.
			1	0.177	0.06	50.70	-	50.76	-	64.61
2	0.357	0.06	36.92	-	36.98	-	58.80	48.80	-21.82	-
3	0.595	0.09	29.59	-	29.68	-	56.00	46.00	-26.32	-
4	4.641	0.24	29.07	-	29.31	-	56.00	46.00	-26.69	-
5	19.547	0.63	33.69	-	34.32	-	60.00	50.00	-25.68	-
6	28.602	0.89	31.89	-	32.78	-	60.00	50.00	-27.22	-

- REMARKS:**
1. Q.P. and AV. are abbreviations of quasi-peak and average individually.
 2. "-": The Quasi-peak reading value also meets average limit and measurement with the average detector is unnecessary.
 3. The emission levels of other frequencies were very low against the limit.
 4. Margin value = Emission level - Limit value
 5. Correction factor = Insertion loss + Cable loss
 6. Emission Level = Correction Factor + Reading Value.

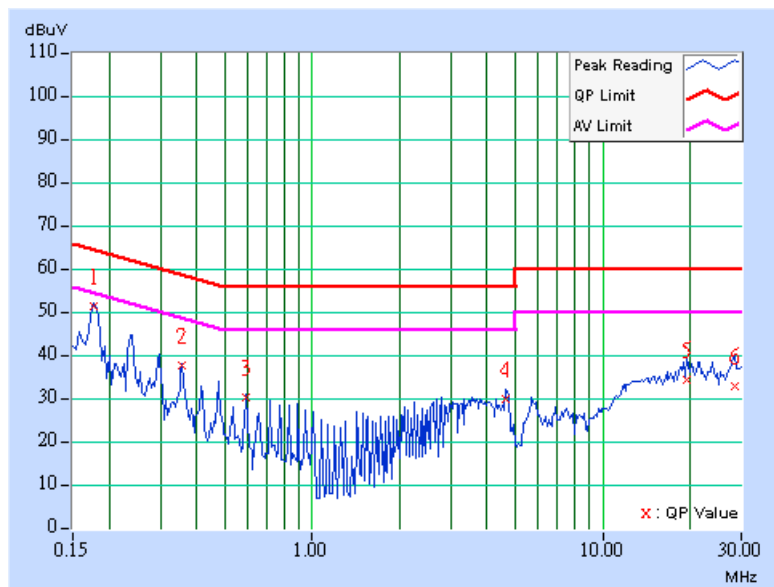



EUT	2.4/5GHz 54Mbps Wireless Mini PCI Card	MODEL	GL2554MP-1A
MODE	Channel 6	6dB BANDWIDTH	9 kHz
		PHASE	Neutral (N)
ENVIRONMENTAL CONDITIONS	25deg. C, 60%RH, 991hPa	INPUT POWER (SYSTEM)	120Vac, 60Hz
TESTED BY	Martin Lee		

No	Freq. [MHz]	Corr. Factor (dB)	Reading Value [dB (uV)]		Emission Level [dB (uV)]		Limit [dB (uV)]		Margin (dB)	
			Q.P.	AV.	Q.P.	AV.	Q.P.	AV.	Q.P.	AV.
			1	0.177	0.05	50.09	-	50.14	-	64.61
2	0.298	0.05	36.95	-	37.00	-	60.29	50.29	-23.29	-
3	0.594	0.08	27.50	-	27.58	-	56.00	46.00	-28.42	-
4	3.862	0.20	34.60	-	34.80	-	56.00	46.00	-21.20	-
5	12.240	0.43	31.84	-	32.27	-	60.00	50.00	-27.73	-
6	19.195	0.51	33.45	-	33.96	-	60.00	50.00	-26.04	-

- REMARKS:**
1. Q.P. and AV. are abbreviations of quasi-peak and average individually.
 2. "-": The Quasi-peak reading value also meets average limit and measurement with the average detector is unnecessary.
 3. The emission levels of other frequencies were very low against the limit.
 4. Margin value = Emission level - Limit value
 5. Correction factor = Insertion loss + Cable loss
 6. Emission Level = Correction Factor + Reading Value.

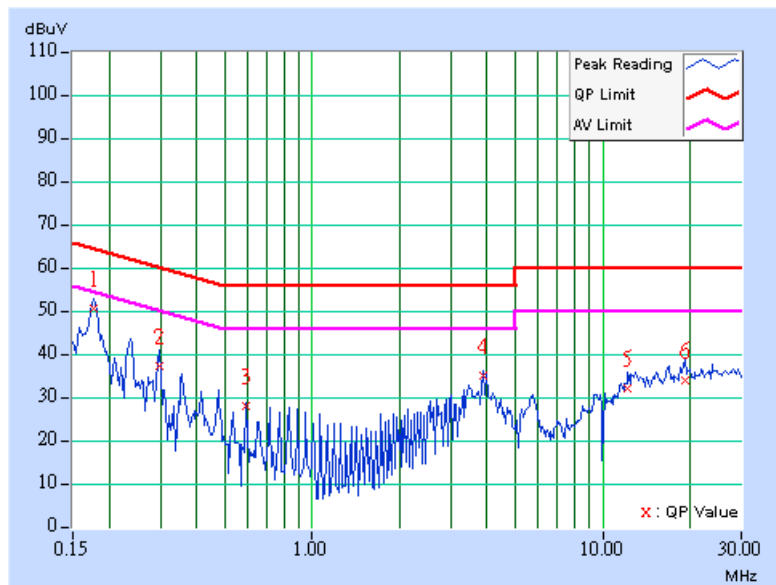



EUT	2.4/5GHz 54Mbps Wireless Mini PCI Card	MODEL	GL2554MP-1A
MODE	Channel 11	6dB BANDWIDTH	9 kHz
		PHASE	Line (L)
ENVIRONMENTAL CONDITIONS	25deg. C, 60%RH, 991hPa	INPUT POWER (SYSTEM)	120Vac, 60Hz
TESTED BY	Martin Lee		

No	Freq. [MHz]	Corr. Factor (dB)	Reading Value [dB (uV)]		Emission Level [dB (uV)]		Limit [dB (uV)]		Margin (dB)	
			Q.P.	AV.	Q.P.	AV.	Q.P.	AV.	Q.P.	AV.
1	0.177	0.06	49.75	-	49.81	-	64.61	54.61	-14.80	-
2	0.298	0.06	38.39	-	38.45	-	60.29	50.29	-21.84	-
3	0.595	0.09	29.39	-	29.48	-	56.00	46.00	-26.52	-
4	4.057	0.22	27.68	-	27.90	-	56.00	46.00	-28.10	-
5	12.532	0.49	31.70	-	32.19	-	60.00	50.00	-27.81	-
6	21.433	0.71	33.14	-	33.85	-	60.00	50.00	-26.15	-

- REMARKS:**
1. Q.P. and AV. are abbreviations of quasi-peak and average individually.
 2. "-": The Quasi-peak reading value also meets average limit and measurement with the average detector is unnecessary.
 3. The emission levels of other frequencies were very low against the limit.
 4. Margin value = Emission level - Limit value
 5. Correction factor = Insertion loss + Cable loss
 6. Emission Level = Correction Factor + Reading Value.

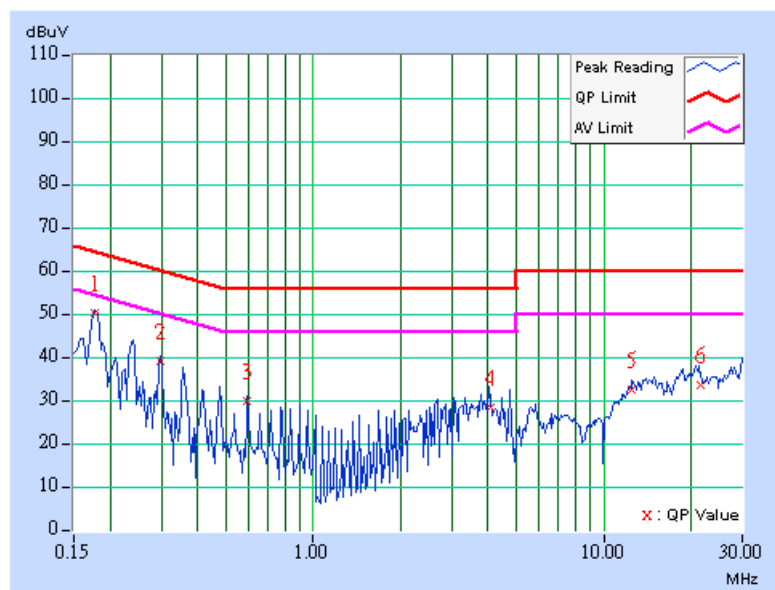



EUT	2.4/5GHz 54Mbps Wireless Mini PCI Card	MODEL	GL2554MP-1A
MODE	Channel 11	6dB BANDWIDTH	9 kHz
		PHASE	Neutral (N)
ENVIRONMENTAL CONDITIONS	25deg. C, 60%RH, 991hPa	INPUT POWER (SYSTEM)	120Vac, 60Hz
TESTED BY	Martin Lee		

No	Freq. [MHz]	Corr. Factor (dB)	Reading Value		Emission Level		Limit		Margin	
			[dB (uV)]		[dB (uV)]		[dB (uV)]		(dB)	
			Q.P.	AV.	Q.P.	AV.	Q.P.	AV.	Q.P.	AV.
1	0.177	0.05	47.21	-	47.26	-	64.61	54.61	-17.35	-
2	0.298	0.05	35.66	-	35.71	-	60.29	50.29	-24.58	-
3	0.716	0.11	26.33	-	26.44	-	56.00	46.00	-29.56	-
4	3.347	0.20	32.06	-	32.26	-	56.00	46.00	-23.74	-
5	12.135	0.43	30.70	-	31.13	-	60.00	50.00	-28.87	-
6	21.473	0.57	30.16	-	30.73	-	60.00	50.00	-29.27	-

- REMARKS:**
1. Q.P. and AV. are abbreviations of quasi-peak and average individually.
 2. "-": The Quasi-peak reading value also meets average limit and measurement with the average detector is unnecessary.
 3. The emission levels of other frequencies were very low against the limit.
 4. Margin value = Emission level - Limit value
 5. Correction factor = Insertion loss + Cable loss
 6. Emission Level = Correction Factor + Reading Value.

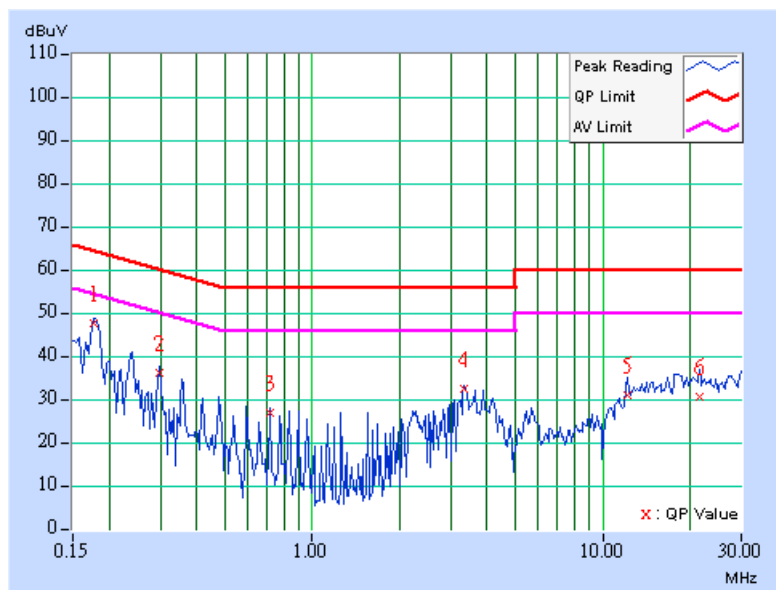



4.2 RADIATED EMISSION MEASUREMENT

4.2.1 LIMITS OF RADIATED EMISSION MEASUREMENT

Emissions radiated outside of the specified bands, shall be according to the general radiated limits in 15.209 as following:

Frequencies (MHz)	Field strength (microvolts/meter)	Measurement distance (meters)
0.009-0.490	2400/F(kHz)	300
0.490-1.705	24000/F(kHz)	30
1.705-30.0	30	30
30-88	100	3
88-216	150	3
216-960	200	3
Above 960	500	3

NOTE:

1. The lower limit shall apply at the transition frequencies.
2. Emission level (dBuV/m) = 20 log Emission level (uV/m).
3. As shown in 15.35(b), for frequencies above 1000MHz, the field strength limits are based on average detector, however, the peak field strength of any emission shall not exceed the maximum permitted average limits, specified above by more than 20dB under any condition of modulation.



4.2.2 TEST INSTRUMENTS

DESCRIPTION & MANUFACTURER	MODEL NO.	SERIAL NO.	CALIBRATED UNTIL
* HP Spectrum Analyzer	8590L	3544A01176	Jun. 10, 2004
* HP Preamplifier	8447D	2944A08485	May 01, 2004
* HP Preamplifier	8449B	3008A01292	Aug. 13, 2004
ROHDE & SCHWARZ TEST RECEIVER	ESI7	838496/016	Feb. 23, 2004
* ROHDE & SCHWARZ TEST RECEIVER	ESMI	839013/007 839379/002	Feb. 13, 2004
SCHAFFNER Tunable Dipole Antenna	VHBA 9123	459	Jun. 26, 2004
SCHWARZBECK Tunable Dipole Antenna	UHA 9105	977	
* CHASE BILOG Antenna	CBL6112A	2221	July 26, 2004
* SCHWARZBECK Horn Antenna	BBHA9120-D1	D130	Jun. 30, 2004
* EMCO Horn Antenna	3115	9312-4192	Mar. 23, 2004
* EMCO Turn Table	1060	1115	NA
* CHANCE Tower	CM-AT40	CM-A010	NA
* Software	ADT_Radiate d_V5.14	NA	NA
* ANRITSU RF Switches	MP59B	M35046	Jan. 05, 2004
* TIMES RF cable	LMR-600	CABLE-ST5-01	Jan. 05, 2004

NOTE: 1. The calibration interval of the above test instruments is 12 months. And the calibrations are traceable to NML/ROC and NIST/USA.

2. "*" = These equipment are used for the final measurement.
3. The horn antenna and HP preamplifier (model: 8449B) are used only for the measurement of emission frequency above 1GHz if tested.
4. The test was performed in ADT Open Site No. 5.
5. The VCCI Site Registration No. is R-1039.



4.2.3 TEST PROCEDURES

- a. The EUT was placed on the top of a rotating table 0.8 meters above the ground at a 10 meter open area test site. The table was rotated 360 degrees to determine the position of the highest radiation.
- b. The EUT was set 3 meters away from the interference-receiving antenna, which was mounted on the top of a variable-height antenna tower.
- c. The antenna is a broadband antenna, and its height is varied from one meter to four meters above the ground to determine the maximum value of the field strength. Both horizontal and vertical polarizations of the antenna are set to make the measurement.
- d. For each suspected emission, the EUT was arranged to its worst case and then the antenna was tuned to heights from 1 meter to 4 meters and the rotatable table was turned from 0 degrees to 360 degrees to find the maximum reading.
- e. The test-receiver system was set to Peak Detect Function and Specified Bandwidth with Maximum Hold Mode.
- f. If the emission level of the EUT in peak mode was 10 dB lower than the limit specified, then testing could be stopped and the peak values of the EUT would be reported. Otherwise the emissions that did not have 10 dB margin would be re-tested one by one using the quasi-peak method or average method as specified and then reported in Data sheet peak mode and QP mode.

NOTE:

1. The resolution bandwidth and video bandwidth of test receiver/spectrum analyzer is 120kHz for Quasi-peak detection at frequency below 1GHz.
2. The resolution bandwidth and video bandwidth of test receiver/spectrum analyzer is 1 MHz for Peak detection (PK) at frequency above 1GHz.
3. The resolution bandwidth of test receiver/spectrum analyzer is 1 MHz and the video bandwidth is 10 Hz for Average detection (AV) at frequency above 1GHz.

4.2.4 DEVIATION FROM TEST STANDARD

No deviation

4.2.5 TEST SETUP

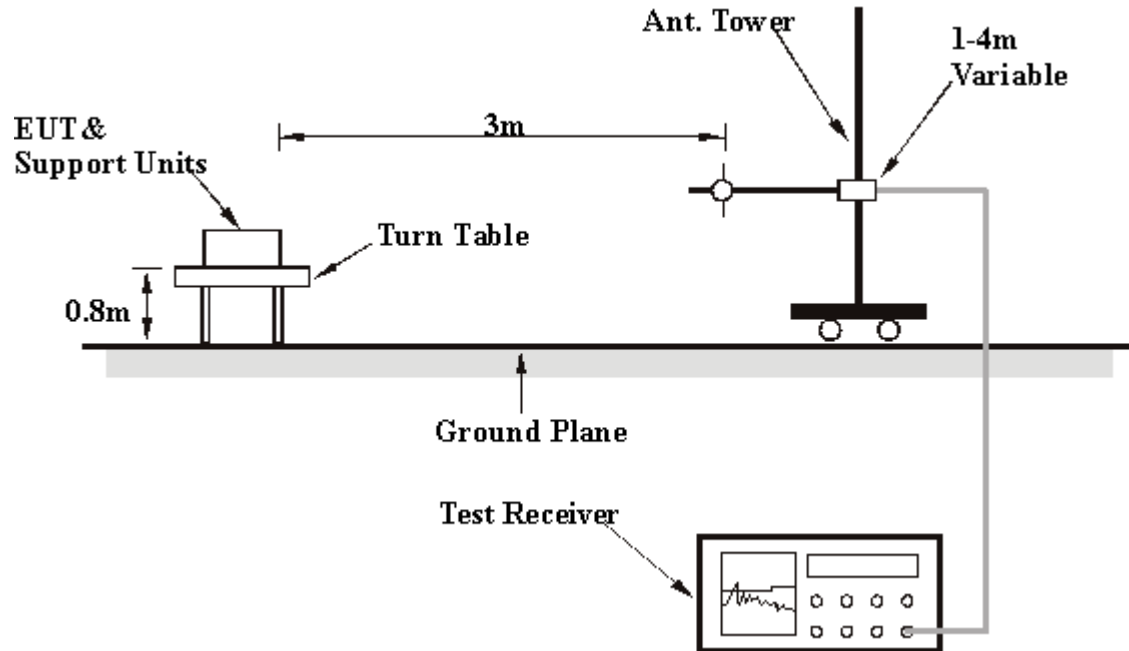

For the actual test configuration, please refer to the related item – Photographs of the Test Configuration.

4.2.6 EUT OPERATING CONDITIONS

Same as 4.1.6



4.2.7 TEST RESULTS

Mode 1

EUT	2.4/5GHz 54Mbps Wireless Mini PCI Card	MODEL	GL2554MP-1A
MODE	Channel 11	FREQUENCY RANGE	Below 1000MHz
INPUT POWER (SYSTEM)	120Vac, 60Hz	DETECTOR FUNCTION	Quasi-Peak
ENVIRONMENTAL CONDITIONS	30deg. C, 60%RH, 991hPa	TESTED BY: Hardaway Lee	

ANTENNA POLARITY & TEST DISTANCE: HORIZONTAL AT 10 M								
No.	Freq. (MHz)	Emission Level (dBuV/m)	Limit (dBuV/m)	Margin (dB)	Antenna Height (m)	Table Angle (Degree)	Raw Value (dBuV)	Correction Factor (dB/m)
1	131.90	30.17 QP	43.50	-13.33	2.15 H	111	17.71	12.46
2	167.43	40.00 QP	43.50	-3.50	1.71 H	163	29.39	10.61
3	199.85	30.62 QP	43.50	-12.88	1.56 H	65	19.86	10.76
4	211.98	32.68 QP	43.50	-10.82	1.30 H	243	21.24	11.44
5	217.55	35.54 QP	46.00	-10.46	1.49 H	59	23.78	11.76
6	233.50	33.53 QP	46.00	-12.47	1.59 H	260	20.86	12.67
7	260.98	34.32 QP	46.00	-11.68	1.59 H	304	19.20	15.12
8	457.00	39.03 QP	46.00	-6.97	1.01 H	35	19.98	19.05
9	503.00	36.48 QP	46.00	-9.52	1.01 H	140	16.31	20.17

ANTENNA POLARITY & TEST DISTANCE: VERTICAL AT 3 M								
No.	Freq. (MHz)	Emission Level (dBuV/m)	Limit (dBuV/m)	Margin (dB)	Antenna Height (m)	Table Angle (Degree)	Raw Value (dBuV)	Correction Factor (dB/m)
1	129.00	29.54 QP	43.50	-13.96	1.01 V	0	16.93	12.61
2	166.90	34.82 QP	43.50	-8.68	1.01 V	147	24.21	10.61
3	202.65	28.46 QP	43.50	-15.04	1.01 V	157	17.55	10.91
4	225.05	37.60 QP	46.00	-8.40	1.01 V	309	25.41	12.19
5	280.93	32.37 QP	46.00	-13.63	1.72 V	32	17.02	15.35
6	400.00	30.60 QP	46.00	-15.40	1.05 V	324	12.36	18.24
7	469.00	35.52 QP	46.00	-10.48	1.05 V	345	16.17	19.35
8	800.50	33.58 QP	46.00	-12.42	1.66 V	249	9.88	23.70

- REMARKS:**
1. Emission level(dBuV/m)=Raw Value(dBuV) + Correction Factor(dB)
 2. Correction Factor(dB/m) = Antenna Factor (dB/m) + Cable Factor (dB)
 3. The other emission levels were very low against the limit.
 4. Margin value = Emission level – Limit value.



Mode 2

EUT	2.4/5GHz 54Mbps Wireless Mini PCI Card	MODEL	GL2554MP-1A
MODE	Channel 11	FREQUENCY RANGE	Below 1000MHz
INPUT POWER (SYSTEM)	120Vac, 60Hz	DETECTOR FUNCTION	Quasi-Peak
ENVIRONMENTAL CONDITIONS	30deg. C, 60%RH, 991hPa	TESTED BY: Hardaway Lee	

ANTENNA POLARITY & TEST DISTANCE: HORIZONTAL AT 10 M

No.	Freq. (MHz)	Emission Level (dBuV/m)	Limit (dBuV/m)	Margin (dB)	Antenna Height (m)	Table Angle (Degree)	Raw Value (dBuV)	Correction Factor (dB/m)
1	133.38	40.18 QP	43.50	-3.32	2.10 H	120	27.80	12.38
2	167.13	30.11 QP	43.50	-13.39	2.17 H	216	19.50	10.61
3	200.58	31.11 QP	43.50	-12.39	2.06 H	207	20.32	10.79
4	233.15	33.42 QP	46.00	-12.58	1.59 H	228	20.77	12.65
5	301.00	35.18 QP	46.00	-10.82	1.01 H	120	19.51	15.67
6	326.00	32.23 QP	46.00	-13.77	1.25 H	218	16.19	16.04
7	501.00	33.90 QP	46.00	-12.10	1.01 H	27	13.76	20.14
8	802.00	36.27 QP	46.00	-9.73	1.57 H	1	12.55	23.72

ANTENNA POLARITY & TEST DISTANCE: VERTICAL AT 3 M

No.	Freq. (MHz)	Emission Level (dBuV/m)	Limit (dBuV/m)	Margin (dB)	Antenna Height (m)	Table Angle (Degree)	Raw Value (dBuV)	Correction Factor (dB/m)
1	133.55	30.47 QP	43.50	-13.03	1.01 V	159	18.09	12.38
2	167.75	26.60 QP	43.50	-16.90	1.01 V	347	16.00	10.60
3	196.65	28.34 QP	43.50	-15.16	1.01 V	12	17.63	10.71
4	200.00	26.75 QP	43.50	-16.75	2.15 V	259	15.99	10.76
5	225.05	30.21 QP	46.00	-15.79	1.50 V	133	18.02	12.19
6	260.98	33.29 QP	46.00	-12.71	1.84 V	332	18.17	15.12
7	375.00	31.46 QP	46.00	-14.54	1.23 V	303	14.14	17.32
8	457.00	38.05 QP	46.00	-7.95	1.39 V	162	19.00	19.05
9	498.00	35.95 QP	46.00	-10.05	1.83 V	139	15.87	20.08
10	913.00	34.20 QP	46.00	-11.80	1.23 V	344	9.69	24.51

- REMARKS:**
1. Emission level(dBuV/m)=Raw Value(dBuV) + Correction Factor(dB)
 2. Correction Factor(dB/m) = Antenna Factor (dB/m) + Cable Factor (dB)
 3. The other emission levels were very low against the limit.
 4. Margin value = Emission level – Limit value.

**Mode 3**

EUT	2.4/5GHz 54Mbps Wireless Mini PCI Card	MODEL	GL2554MP-1A
MODE	Channel 11	FREQUENCY RANGE	Below 1000MHz
INPUT POWER (SYSTEM)	120Vac, 60Hz	DETECTOR FUNCTION	Quasi-Peak
ENVIRONMENTAL CONDITIONS	25deg. C, 60%RH, 991hPa	TESTED BY: Martin Lee	

ANTENNA POLARITY & TEST DISTANCE: HORIZONTAL AT 10 M

No.	Freq. (MHz)	Emission Level (dBuV/m)	Limit (dBuV/m)	Margin (dB)	Antenna Height (m)	Table Angle (Degree)	Raw Value (dBuV)	Correction Factor (dB/m)
1	33.23	28.83 QP	40.00	-11.17	2.00 H	10	15.62	13.22
2	66.64	35.12 QP	40.00	-4.88	3.00 H	10	22.78	12.34
3	99.66	41.07 QP	43.50	-2.43	2.88 H	360	30.81	10.26
4	133.47	34.98 QP	43.50	-8.52	3.00 H	244	21.68	13.30
5	166.88	31.26 QP	43.50	-12.24	2.00 H	292	17.60	13.67
6	199.21	34.07 QP	43.50	-9.43	1.00 H	280	22.83	11.24
7	232.62	35.94 QP	46.00	-10.06	1.50 H	22	23.13	12.81
8	311.30	35.17 QP	46.00	-10.83	1.00 H	298	19.78	15.39
9	354.41	33.88 QP	46.00	-12.12	1.00 H	82	17.34	16.53
10	400.76	36.52 QP	46.00	-9.48	1.00 H	16	18.79	17.73
11	601.22	36.73 QP	46.00	-9.27	1.50 H	40	14.12	22.62
12	733.79	33.28 QP	46.00	-12.72	1.50 H	112	8.38	24.91
13	799.53	31.28 QP	46.00	-14.72	1.00 H	238	5.66	25.62
14	831.87	30.01 QP	46.00	-15.99	1.50 H	22	4.06	25.95
15	867.43	32.28 QP	46.00	-13.72	1.00 H	40	5.79	26.49
16	899.77	30.38 QP	46.00	-15.62	1.00 H	64	3.25	27.14
17	934.26	37.89 QP	46.00	-8.11	1.00 H	172	10.36	27.53

ANTENNA POLARITY & TEST DISTANCE: VERTICAL AT 3 M

No.	Freq. (MHz)	Emission Level (dBuV/m)	Limit (dBuV/m)	Margin (dB)	Antenna Height (m)	Table Angle (Degree)	Raw Value (dBuV)	Correction Factor (dB/m)
1	38.62	27.93 QP	40.00	-12.07	1.00 V	340	13.79	14.14
2	73.11	32.26 QP	40.00	-7.74	1.00 V	340	21.15	11.11
3	162.57	28.35 QP	43.50	-15.15	1.00 V	274	14.29	14.05
4	284.36	32.00 QP	46.00	-14.00	2.00 V	178	17.27	14.73
5	321.00	37.89 QP	46.00	-8.11	1.50 V	202	22.24	15.65
6	353.33	33.26 QP	46.00	-12.74	2.00 V	190	16.76	16.51
7	601.22	30.18 QP	46.00	-15.82	1.50 V	130	7.57	22.62
8	664.81	37.30 QP	46.00	-8.70	1.00 V	142	13.84	23.47
9	934.26	36.04 QP	46.00	-9.96	1.00 V	358	8.50	27.53

- REMARKS:**
1. Emission level(dBuV/m)=Raw Value(dBuV) + Correction Factor(dB)
 2. Correction Factor(dB/m) = Antenna Factor (dB/m) + Cable Factor (dB)
 3. The other emission levels were very low against the limit.
 4. Margin value = Emission level – Limit value

**Mode 4**

EUT	2.4/5GHz 54Mbps Wireless Mini PCI Card	MODEL	GL2554MP-1A
MODE	Channel 11	FREQUENCY RANGE	Below 1000MHz
INPUT POWER (SYSTEM)	120Vac, 60Hz	DETECTOR FUNCTION	Quasi-Peak
ENVIRONMENTAL CONDITIONS	25deg. C, 60%RH, 991hPa	TESTED BY: Martin Lee	

ANTENNA POLARITY & TEST DISTANCE: HORIZONTAL AT 10 M

No.	Freq. (MHz)	Emission Level (dBuV/m)	Limit (dBuV/m)	Margin (dB)	Antenna Height (m)	Table Angle (Degree)	Raw Value (dBuV)	Correction Factor (dB/m)
1	33.23	28.91 QP	40.00	-11.09	3.00 H	10	15.69	13.22
2	66.64	35.19 QP	40.00	-4.81	1.50 H	358	22.85	12.34
3	100.06	40.20 QP	43.50	-3.30	2.00 H	22	29.90	10.30
4	133.47	32.47 QP	43.50	-11.03	1.50 H	304	19.17	13.30
5	166.88	32.18 QP	43.50	-11.32	1.50 H	298	18.51	13.67
6	200.29	35.30 QP	43.50	-8.20	1.50 H	268	24.10	11.20
7	232.62	33.83 QP	46.00	-12.17	1.50 H	352	21.02	12.81
8	284.36	34.03 QP	46.00	-11.97	1.00 H	286	19.30	14.73
9	333.93	36.15 QP	46.00	-9.85	1.00 H	214	20.16	15.99
10	366.27	32.10 QP	46.00	-13.90	1.00 H	346	15.26	16.84
11	398.60	39.76 QP	46.00	-6.24	1.00 H	238	22.09	17.67
12	467.58	33.08 QP	46.00	-12.92	1.00 H	208	13.53	19.55
13	601.22	38.64 QP	46.00	-7.36	1.50 H	28	16.02	22.62
14	654.03	31.46 QP	46.00	-14.54	1.00 H	322	8.15	23.31
15	733.79	32.80 QP	46.00	-13.20	1.50 H	100	7.90	24.91
16	801.69	31.55 QP	46.00	-14.45	1.00 H	208	5.91	25.64
17	867.43	32.45 QP	46.00	-13.55	1.00 H	82	5.97	26.49
18	934.26	37.43 QP	46.00	-8.57	1.00 H	58	9.90	27.53

ANTENNA POLARITY & TEST DISTANCE: VERTICAL AT 3 M

No.	Freq. (MHz)	Emission Level (dBuV/m)	Limit (dBuV/m)	Margin (dB)	Antenna Height (m)	Table Angle (Degree)	Raw Value (dBuV)	Correction Factor (dB/m)
1	33.23	34.34 QP	40.00	-5.66	1.00 V	358	21.13	13.22
2	66.64	35.62 QP	40.00	-4.38	1.00 V	46	23.28	12.34
3	162.57	28.98 QP	43.50	-14.52	1.00 V	322	14.93	14.05
4	200.29	29.77 QP	43.50	-13.73	2.00 V	262	18.56	11.20
5	310.22	33.59 QP	46.00	-12.41	2.00 V	220	18.23	15.36
6	352.26	33.01 QP	46.00	-12.99	2.00 V	148	16.53	16.48
7	533.32	37.30 QP	46.00	-8.70	1.00 V	256	16.55	20.75
8	601.22	32.26 QP	46.00	-13.74	1.50 V	118	9.65	22.62
9	794.14	32.82 QP	46.00	-13.18	1.50 V	274	7.24	25.59
10	934.26	36.90 QP	46.00	-9.10	1.50 V	142	9.37	27.53

- REMARKS:**
1. Emission level(dBuV/m)=Raw Value(dBuV) + Correction Factor(dB)
 2. Correction Factor(dB/m) = Antenna Factor (dB/m) + Cable Factor (dB)
 3. The other emission levels were very low against the limit.
 4. Margin value = Emission level – Limit value



4.2.8 TEST RESULTS (A)

Mode 1

EUT	2.4/5GHz 54Mbps Wireless Mini PCI Card	MODEL	GL2554MP-1A
MODE	Channel 1	FREQUENCY RANGE	Above 1000 MHz
INPUT POWER (SYSTEM)	120Vac, 60Hz	DETECTOR FUNCTION	Peak(PK) Average (AV)
ENVIRONMENTAL CONDITIONS	30deg. C, 60%RH, 991hPa	TESTED BY: Jun Wu	

ANTENNA POLARITY & TEST DISTANCE: HORIZONTAL AT 3 M								
No.	Freq. (MHz)	Emission Level (dBuV/m)	Limit (dBuV/m)	Margin (dB)	Antenna Height (m)	Table Angle (Degree)	Raw Value (dBuV)	Correction Factor (dB/m)
1	2390.00	45.65 PK	74.00	-28.35	1.00 H	210	16.00	29.65
2	*2412.00	98.34 PK			1.00 H	210	68.62	29.72
2	*2412.00	89.96 AV			1.00 H	210	60.24	29.72
3	4824.00	49.78 PK	74.00	-24.22	1.81 H	169	14.33	35.45

ANTENNA POLARITY & TEST DISTANCE: VERTICAL AT 3 M								
No.	Freq. (MHz)	Emission Level (dBuV/m)	Limit (dBuV/m)	Margin (dB)	Antenna Height (m)	Table Angle (Degree)	Raw Value (dBuV)	Correction Factor (dB/m)
1	2390.00	56.98 PK	74.00	-17.02	1.45 V	188	27.33	29.65
1	2390.00	49.67 AV	54.00	-4.33	1.45 V	188	20.02	29.65
2	*2412.00	109.67 PK			1.45 V	188	79.95	29.72
2	*2412.00	102.36 AV			1.45 V	188	72.64	29.72
3	4824.00	58.03 PK	74.00	-15.97	1.81 H	169	22.58	35.45
3	4824.00	50.72 AV	54.00	-3.28	1.81 H	169	15.27	35.45

- REMARKS:**
1. Emission level(dBuV/m)=Raw Value(dBuV) + Correction Factor(dB)
 2. Correction Factor(dB/m) = Antenna Factor (dB/m) + Cable Factor (dB)
 3. The other emission levels were very low against the limit.
 4. Margin value = Emission level – Limit value.
 5. The limit value is defined as per 15.247
 6. “ * “ : Fundamental frequency



EUT	2.4/5GHz 54Mbps Wireless Mini PCI Card	MODEL	GL2554MP-1A
MODE	Channel 6	FREQUENCY RANGE	Above 1000 MHz
INPUT POWER (SYSTEM)	120Vac, 60Hz	DETECTOR FUNCTION	Peak(PK) Average (AV)
ENVIRONMENTAL CONDITIONS	30deg. C, 60%RH, 991hPa	TESTED BY: Jun Wu	

ANTENNA POLARITY & TEST DISTANCE: HORIZONTAL AT 3 M								
No.	Freq. (MHz)	Emission Level (dBuV/m)	Limit (dBuV/m)	Margin (dB)	Antenna Height (m)	Table Angle (Degree)	Raw Value (dBuV)	Correction Factor (dB/m)
1	*2437.00	101.17 PK			1.53 H	138	71.38	29.79
1	*2437.00	94.05 AV			1.53 H	138	64.26	29.79
2	4874.00	51.00 PK	74.00	-23.00	1.14 H	157	15.21	35.79

ANTENNA POLARITY & TEST DISTANCE: VERTICAL AT 3 M								
No.	Freq. (MHz)	Emission Level (dBuV/m)	Limit (dBuV/m)	Margin (dB)	Antenna Height (m)	Table Angle (Degree)	Raw Value (dBuV)	Correction Factor (dB/m)
1	*2437.00	111.08 PK			1.45 V	218	81.29	29.79
1	*2437.00	103.72 AV			1.45 V	218	73.93	29.79
2	4874.00	62.53 PK	74.00	-11.47	1.21 V	184	26.74	35.79
2	4874.00	47.89 AV	54.00	-6.11	1.21 V	184	12.10	35.79

- REMARKS:**
1. Emission level(dBuV/m)=Raw Value(dBuV) + Correction Factor(dB)
 2. Correction Factor(dB/m) = Antenna Factor (dB/m) + Cable Factor (dB)
 3. The other emission levels were very low against the limit.
 4. Margin value = Emission level – Limit value.
 5. The limit value is defined as per 15.247
 6. “ * “ : Fundamental frequency



EUT	2.4/5GHz 54Mbps Wireless Mini PCI Card	MODEL	GL2554MP-1A
MODE	Channel 11	FREQUENCY RANGE	Above 1000 MHz
INPUT POWER (SYSTEM)	120Vac, 60Hz	DETECTOR FUNCTION	Peak(PK) Average (AV)
ENVIRONMENTAL CONDITIONS	30deg. C, 60%RH, 991hPa	TESTED BY: Jun Wu	

ANTENNA POLARITY & TEST DISTANCE: HORIZONTAL AT 3 M								
No.	Freq. (MHz)	Emission Level (dBuV/m)	Limit (dBuV/m)	Margin (dB)	Antenna Height (m)	Table Angle (Degree)	Raw Value (dBuV)	Correction Factor (dB/m)
1	*2462.00	104.04 PK			1.28 H	120	74.19	29.85
1	*2462.00	96.02 AV			1.28 H	120	66.17	29.85
2	2483.50	50.93 PK	74.00	-23.07	1.28 H	120	21.02	29.91
3	4924.00	49.40 PK	74.00	-24.60	1.32 H	195	13.31	36.09

ANTENNA POLARITY & TEST DISTANCE: VERTICAL AT 3 M								
No.	Freq. (MHz)	Emission Level (dBuV/m)	Limit (dBuV/m)	Margin (dB)	Antenna Height (m)	Table Angle (Degree)	Raw Value (dBuV)	Correction Factor (dB/m)
1	*2462.00	111.06 PK			1.41 V	190	81.21	29.85
1	*2462.00	104.01 AV			1.41 V	190	74.16	29.85
2	2483.50	57.95 PK	74.00	-16.05	1.41 V	190	28.04	29.91
2	2483.50	51.00 AV	54.00	-3.00	1.41 V	190	21.09	29.91
3	4924.00	59.64 PK	74.00	-14.36	1.09 V	180	23.55	36.09
3	4924.00	45.63 AV	54.00	-8.37	1.09 V	180	9.54	36.09

- REMARKS:**
1. Emission level(dBuV/m)=Raw Value(dBuV) + Correction Factor(dB)
 2. Correction Factor(dB/m) = Antenna Factor (dB/m) + Cable Factor (dB)
 3. The other emission levels were very low against the limit.
 4. Margin value = Emission level – Limit value.
 5. The limit value is defined as per 15.247
 6. “ * “ : Fundamental frequency



Mode 2

EUT	2.4/5GHz 54Mbps Wireless Mini PCI Card	MODEL	GL2554MP-1A
MODE	Channel 1	FREQUENCY RANGE	Above 1000 MHz
INPUT POWER (SYSTEM)	120Vac, 60Hz	DETECTOR FUNCTION	Peak(PK) Average (AV)
ENVIRONMENTAL CONDITIONS	30deg. C, 60%RH, 991hPa	TESTED BY: Jun Wu	

ANTENNA POLARITY & TEST DISTANCE: HORIZONTAL AT 3 M								
No.	Freq. (MHz)	Emission Level (dBuV/m)	Limit (dBuV/m)	Margin (dB)	Antenna Height (m)	Table Angle (Degree)	Raw Value (dBuV)	Correction Factor (dB/m)
1	2390.00	57.35 PK	74.00	-16.65	1.00 H	329	27.70	29.65
1	2390.00	49.79 AV	54.00	-4.21	1.00 H	329	20.14	29.65
2	*2412.00	108.44 PK			1.00 H	329	78.72	29.72
2	*2412.00	100.88 AV			1.00 H	329	71.16	29.72
3	4824.00	48.96 PK	74.00	-25.04	1.17 H	329	13.51	35.45

ANTENNA POLARITY & TEST DISTANCE: VERTICAL AT 3 M								
No.	Freq. (MHz)	Emission Level (dBuV/m)	Limit (dBuV/m)	Margin (dB)	Antenna Height (m)	Table Angle (Degree)	Raw Value (dBuV)	Correction Factor (dB/m)
1	2390.00	51.70 PK	74.00	-22.30	1.37 V	329	22.05	29.65
1	2390.00	44.24 AV	54.00	-9.76	1.37 V	329	14.59	29.65
2	*2412.00	102.79 PK			1.37 V	329	73.07	29.72
2	*2412.00	95.33 AV			1.37 V	329	65.61	29.72
3	4824.00	50.38 PK	74.00	-23.62	1.46 V	224	14.93	35.45

- REMARKS:**
1. Emission level(dBuV/m)=Raw Value(dBuV) + Correction Factor(dB)
 2. Correction Factor(dB/m) = Antenna Factor (dB/m) + Cable Factor (dB)
 3. The other emission levels were very low against the limit.
 4. Margin value = Emission level – Limit value.
 5. The limit value is defined as per 15.247
 6. “ * “ : Fundamental frequency



EUT	2.4/5GHz 54Mbps Wireless Mini PCI Card	MODEL	GL2554MP-1A
MODE	Channel 6	FREQUENCY RANGE	Above 1000 MHz
INPUT POWER (SYSTEM)	120Vac, 60Hz	DETECTOR FUNCTION	Peak(PK) Average (AV)
ENVIRONMENTAL CONDITIONS	30deg. C, 60%RH, 991hPa	TESTED BY: Jun Wu	

ANTENNA POLARITY & TEST DISTANCE: HORIZONTAL AT 3 M

No.	Freq. (MHz)	Emission Level (dBuV/m)	Limit (dBuV/m)	Margin (dB)	Antenna Height (m)	Table Angle (Degree)	Raw Value (dBuV)	Correction Factor (dB/m)
1	*2437.00	105.16 PK			1.32 H	110	75.37	29.79
1	*2437.00	102.56 AV			1.32 H	110	72.77	29.79
2	4874.00	48.13 PK	74.00	-25.87	1.15 H	163	12.34	35.79

ANTENNA POLARITY & TEST DISTANCE: VERTICAL AT 3 M

No.	Freq. (MHz)	Emission Level (dBuV/m)	Limit (dBuV/m)	Margin (dB)	Antenna Height (m)	Table Angle (Degree)	Raw Value (dBuV)	Correction Factor (dB/m)
1	*2437.00	99.83 PK			1.22 V	162	70.04	29.79
1	*2437.00	97.47 AV			1.22 V	162	67.68	29.79
2	4874.00	52.29 PK	74.00	-21.71	1.27 V	257	16.50	35.79
2	4874.00	47.81 AV	54.00	-6.19	1.27 V	257	12.02	35.79

- REMARKS:**
1. Emission level(dBuV/m)=Raw Value(dBuV) + Correction Factor(dB)
 2. Correction Factor(dB/m) = Antenna Factor (dB/m) + Cable Factor (dB)
 3. The other emission levels were very low against the limit.
 4. Margin value = Emission level – Limit value.
 5. The limit value is defined as per 15.247
 6. “ * “ : Fundamental frequency



EUT	2.4/5GHz 54Mbps Wireless Mini PCI Card	MODEL	GL2554MP-1A
MODE	Channel 11	FREQUENCY RANGE	Above 1000 MHz
INPUT POWER (SYSTEM)	120Vac, 60Hz	DETECTOR FUNCTION	Peak(PK) Average (AV)
ENVIRONMENTAL CONDITIONS	30deg. C, 60%RH, 991hPa	TESTED BY: Jun Wu	

ANTENNA POLARITY & TEST DISTANCE: HORIZONTAL AT 3 M

No.	Freq. (MHz)	Emission Level (dBuV/m)	Limit (dBuV/m)	Margin (dB)	Antenna Height (m)	Table Angle (Degree)	Raw Value (dBuV)	Correction Factor (dB/m)
1	*2462.00	109.25 PK			1.09 H	313	79.40	29.85
1	*2462.00	101.87 AV			1.09 H	313	72.02	29.85
2	2483.50	54.00 PK	74.00	-20.00	1.09 H	313	24.09	29.91
2	2483.50	46.62 AV	54.00	-7.38	1.09 H	313	16.71	29.91
3	4924.00	48.16 PK	74.00	-25.84	1.09 H	285	12.07	36.09

ANTENNA POLARITY & TEST DISTANCE: VERTICAL AT 3 M

No.	Freq. (MHz)	Emission Level (dBuV/m)	Limit (dBuV/m)	Margin (dB)	Antenna Height (m)	Table Angle (Degree)	Raw Value (dBuV)	Correction Factor (dB/m)
1	*2462.00	103.45 PK			1.20 V	146	73.60	29.85
1	*2462.00	92.71 AV			1.20 V	146	62.86	29.85
2	2483.50	48.20 PK	74.00	-25.80	1.20 V	146	18.29	29.91
3	4924.00	49.87 PK	74.00	-24.13	1.68 V	184	13.78	36.09

- REMARKS:**
1. Emission level(dBuV/m)=Raw Value(dBuV) + Correction Factor(dB)
 2. Correction Factor(dB/m) = Antenna Factor (dB/m) + Cable Factor (dB)
 3. The other emission levels were very low against the limit.
 4. Margin value = Emission level – Limit value.
 5. The limit value is defined as per 15.247
 6. “ * “ : Fundamental frequency



Mode 3

EUT	2.4/5GHz 54Mbps Wireless Mini PCI Card	MODEL	GL2554MP-1A
MODE	Channel 1	FREQUENCY RANGE	Above 1000 MHz
INPUT POWER (SYSTEM)	120Vac, 60Hz	DETECTOR FUNCTION	Peak(PK) Average (AV)
ENVIRONMENTAL CONDITIONS	25deg. C, 60%RH, 991hPa	TESTED BY: Martin Lee	

ANTENNA POLARITY & TEST DISTANCE: HORIZONTAL AT 3 M								
No.	Freq. (MHz)	Emission Level (dBuV/m)	Limit (dBuV/m)	Margin (dB)	Antenna Height (m)	Table Angle (Degree)	Raw Value (dBuV)	Correction Factor (dB/m)
1	2390.00	54.18 PK	74.00	-19.82	1.18 H	226	22.70	31.48
1	2390.00	45.34 AV	54.00	-8.66	1.18 H	226	13.86	31.48
2	*2412.00	102.04 PK			1.44 H	279	70.53	31.51
2	*2412.00	93.20 AV			1.44 H	279	61.69	31.51
3	4824.00	50.32 PK	74.00	-23.68	1.18 H	226	12.47	37.86

ANTENNA POLARITY & TEST DISTANCE: VERTICAL AT 3 M								
No.	Freq. (MHz)	Emission Level (dBuV/m)	Limit (dBuV/m)	Margin (dB)	Antenna Height (m)	Table Angle (Degree)	Raw Value (dBuV)	Correction Factor (dB/m)
1	2390.00	48.79 PK	74.00	-25.21	1.00 V	25	17.31	31.48
2	*2412.00	96.65 PK			1.00 V	25	65.14	31.51
2	*2412.00	88.33 AV			1.00 V	25	56.82	31.51
3	4824.00	49.25 PK	74.00	-24.75	1.10 V	325	11.40	37.86

- REMARKS:**
1. Emission level(dBuV/m)=Raw Value(dBuV) + Correction Factor(dB)
 2. Correction Factor(dB/m) = Antenna Factor (dB/m) + Cable Factor (dB)
 3. The other emission levels were very low against the limit.
 4. Margin value = Emission level – Limit value.
 5. The limit value is defined as per 15.247
 6. “ * “ : Fundamental frequency



EUT	2.4/5GHz 54Mbps Wireless Mini PCI Card	MODEL	GL2554MP-1A
MODE	Channel 6	FREQUENCY RANGE	Above 1000 MHz
INPUT POWER (SYSTEM)	120Vac, 60Hz	DETECTOR FUNCTION	Peak(PK) Average (AV)
ENVIRONMENTAL CONDITIONS	25deg. C, 60%RH, 991hPa	TESTED BY: Martin Lee	

ANTENNA POLARITY & TEST DISTANCE: HORIZONTAL AT 3 M

No.	Freq. (MHz)	Emission Level (dBuV/m)	Limit (dBuV/m)	Margin (dB)	Antenna Height (m)	Table Angle (Degree)	Raw Value (dBuV)	Correction Factor (dB/m)
1	*2437.00	102.03 PK			1.28 H	229	70.49	31.54
1	*2437.00	91.80 AV			1.28 H	229	60.26	31.54
2	4874.00	53.11 PK	74.00	-20.89	1.28 H	229	15.17	37.94
2	4874.00	36.62 AV	54.00	-17.38	1.28 H	229	-1.32	37.94

ANTENNA POLARITY & TEST DISTANCE: VERTICAL AT 3 M

No.	Freq. (MHz)	Emission Level (dBuV/m)	Limit (dBuV/m)	Margin (dB)	Antenna Height (m)	Table Angle (Degree)	Raw Value (dBuV)	Correction Factor (dB/m)
1	*2437.00	100.47 PK			1.04 V	326	68.93	31.54
1	*2437.00	92.65 AV			1.04 V	326	61.11	31.54
2	4874.00	53.49 PK	74.00	-20.51	1.00 V	150	15.55	37.94
2	4874.00	38.76 AV	54.00	-15.24	1.00 V	150	0.82	37.94

- REMARKS:**
1. Emission level(dBuV/m)=Raw Value(dBuV) + Correction Factor(dB)
 2. Correction Factor(dB/m) = Antenna Factor (dB/m) + Cable Factor (dB)
 3. The other emission levels were very low against the limit.
 4. Margin value = Emission level – Limit value.
 5. The limit value is defined as per 15.247
 6. “ * “ : Fundamental frequency



EUT	2.4/5GHz 54Mbps Wireless Mini PCI Card	MODEL	GL2554MP-1A
MODE	Channel 11	FREQUENCY RANGE	Above 1000 MHz
INPUT POWER (SYSTEM)	120Vac, 60Hz	DETECTOR FUNCTION	Peak(PK) Average (AV)
ENVIRONMENTAL CONDITIONS	25deg. C, 60%RH, 991hPa	TESTED BY: Martin Lee	

ANTENNA POLARITY & TEST DISTANCE: HORIZONTAL AT 3 M								
No.	Freq. (MHz)	Emission Level (dBuV/m)	Limit (dBuV/m)	Margin (dB)	Antenna Height (m)	Table Angle (Degree)	Raw Value (dBuV)	Correction Factor (dB/m)
1	*2462.00	99.08 PK			1.04 H	141	67.51	31.57
1	*2462.00	91.33 AV			1.04 H	141	59.76	31.57
2	2483.50	51.40 PK	74.00	-22.60	1.15 H	26	19.80	31.60
2	2483.50	43.65 AV	54.00	-10.35	1.15 H	26	12.05	31.60
3	4924.00	49.48 PK	74.00	-24.52	1.15 H	26	11.46	38.02

ANTENNA POLARITY & TEST DISTANCE: VERTICAL AT 3 M								
No.	Freq. (MHz)	Emission Level (dBuV/m)	Limit (dBuV/m)	Margin (dB)	Antenna Height (m)	Table Angle (Degree)	Raw Value (dBuV)	Correction Factor (dB/m)
1	*2462.00	97.81 PK			1.13 V	154	66.24	31.57
1	*2462.00	90.29 AV			1.13 V	154	58.72	31.57
2	2483.50	50.13 PK	74.00	-23.87	1.13 V	154	18.53	31.60
3	4924.00	52.25 PK	74.00	-21.75	1.06 V	76	14.23	38.02
3	4924.00	36.28 AV	54.00	-17.72	1.06 V	76	-1.74	38.02

- REMARKS:**
1. Emission level(dBuV/m)=Raw Value(dBuV) + Correction Factor(dB)
 2. Correction Factor(dB/m) = Antenna Factor (dB/m) + Cable Factor (dB)
 3. The other emission levels were very low against the limit.
 4. Margin value = Emission level – Limit value.
 5. The limit value is defined as per 15.247
 6. “ * “ : Fundamental frequency



Mode 4

EUT	2.4/5GHz 54Mbps Wireless Mini PCI Card	MODEL	GL2554MP-1A
MODE	Channel 1	FREQUENCY RANGE	Above 1000 MHz
INPUT POWER (SYSTEM)	120Vac, 60Hz	DETECTOR FUNCTION	Peak(PK) Average (AV)
ENVIRONMENTAL CONDITIONS	25deg. C, 60%RH, 991hPa	TESTED BY: Martin Lee	

ANTENNA POLARITY & TEST DISTANCE: HORIZONTAL AT 3 M								
No.	Freq. (MHz)	Emission Level (dBuV/m)	Limit (dBuV/m)	Margin (dB)	Antenna Height (m)	Table Angle (Degree)	Raw Value (dBuV)	Correction Factor (dB/m)
1	2390.00	51.44 PK	74.00	-22.56	1.24 H	228	19.96	31.48
1	2390.00	43.49 AV	54.00	-10.51	1.24 H	228	12.01	31.48
2	*2412.00	99.30 PK			1.24 H	228	67.79	31.51
2	*2412.00	91.35 AV			1.24 H	228	59.84	31.51
3	4824.00	49.02 PK	74.00	-24.98	1.56 H	87	11.17	37.86

ANTENNA POLARITY & TEST DISTANCE: VERTICAL AT 3 M								
No.	Freq. (MHz)	Emission Level (dBuV/m)	Limit (dBuV/m)	Margin (dB)	Antenna Height (m)	Table Angle (Degree)	Raw Value (dBuV)	Correction Factor (dB/m)
1	2390.00	52.43 PK	74.00	-21.57	1.26 V	352	20.95	31.48
1	2390.00	44.50 AV	54.00	-9.50	1.26 V	352	13.02	31.48
2	*2412.00	100.29 PK			1.26 V	352	68.78	31.51
2	*2412.00	92.36 AV			1.26 V	352	60.85	31.51
3	4824.00	50.77 PK	74.00	-23.23	1.00 V	258	12.92	37.86

- REMARKS:**
1. Emission level(dBuV/m)=Raw Value(dBuV) + Correction Factor(dB)
 2. Correction Factor(dB/m) = Antenna Factor (dB/m) + Cable Factor (dB)
 3. The other emission levels were very low against the limit.
 4. Margin value = Emission level – Limit value.
 5. The limit value is defined as per 15.247
 6. “ * “ : Fundamental frequency



EUT	2.4/5GHz 54Mbps Wireless Mini PCI Card	MODEL	GL2554MP-1A
MODE	Channel 6	FREQUENCY RANGE	Above 1000 MHz
INPUT POWER (SYSTEM)	120Vac, 60Hz	DETECTOR FUNCTION	Peak(PK) Average (AV)
ENVIRONMENTAL CONDITIONS	25deg. C, 60%RH, 991hPa	TESTED BY: Martin Lee	

ANTENNA POLARITY & TEST DISTANCE: HORIZONTAL AT 3 M

No.	Freq. (MHz)	Emission Level (dBuV/m)	Limit (dBuV/m)	Margin (dB)	Antenna Height (m)	Table Angle (Degree)	Raw Value (dBuV)	Correction Factor (dB/m)
1	*2437.00	103.63 PK			1.00 H	35	72.09	31.54
1	*2437.00	95.24 AV			1.00 H	35	63.70	31.54
2	4874.00	51.86 PK	74.00	-22.14	1.25 H	147	13.92	37.94
2	4874.00	35.80 AV	54.00	-18.20	1.25 H	147	-2.14	37.94

ANTENNA POLARITY & TEST DISTANCE: VERTICAL AT 3 M

No.	Freq. (MHz)	Emission Level (dBuV/m)	Limit (dBuV/m)	Margin (dB)	Antenna Height (m)	Table Angle (Degree)	Raw Value (dBuV)	Correction Factor (dB/m)
1	*2437.00	99.73 PK			1.20 V	49	68.19	31.54
1	*2437.00	91.78 AV			1.20 V	49	60.24	31.54
2	4874.00	50.49 PK	74.00	-23.51	1.05 V	126	12.55	37.94

- REMARKS:**
1. Emission level(dBuV/m)=Raw Value(dBuV) + Correction Factor(dB)
 2. Correction Factor(dB/m) = Antenna Factor (dB/m) + Cable Factor (dB)
 3. The other emission levels were very low against the limit.
 4. Margin value = Emission level – Limit value.
 5. The limit value is defined as per 15.247
 6. “ * “ : Fundamental frequency



EUT	2.4/5GHz 54Mbps Wireless Mini PCI Card	MODEL	GL2554MP-1A
MODE	Channel 11	FREQUENCY RANGE	Above 1000 MHz
INPUT POWER (SYSTEM)	120Vac, 60Hz	DETECTOR FUNCTION	Peak(PK) Average (AV)
ENVIRONMENTAL CONDITIONS	25deg. C, 60%RH, 991hPa	TESTED BY: Martin Lee	

ANTENNA POLARITY & TEST DISTANCE: HORIZONTAL AT 3 M								
No.	Freq. (MHz)	Emission Level (dBuV/m)	Limit (dBuV/m)	Margin (dB)	Antenna Height (m)	Table Angle (Degree)	Raw Value (dBuV)	Correction Factor (dB/m)
1	*2462.00	100.98 PK			1.00 H	115	69.41	31.57
1	*2462.00	93.44 AV			1.00 H	115	61.87	31.57
2	2483.50	53.30 PK	74.00	-20.70	1.00 H	115	21.70	31.60
2	2483.50	45.76 AV	54.00	-8.24	1.00 H	115	14.16	31.60
3	4924.00	50.94 PK	74.00	-23.06	1.04 H	14	12.92	38.02

ANTENNA POLARITY & TEST DISTANCE: VERTICAL AT 3 M								
No.	Freq. (MHz)	Emission Level (dBuV/m)	Limit (dBuV/m)	Margin (dB)	Antenna Height (m)	Table Angle (Degree)	Raw Value (dBuV)	Correction Factor (dB/m)
1	*2462.00	100.93 PK			1.19 V	0	69.36	31.57
1	*2462.00	92.73 AV			1.19 V	0	61.16	31.57
2	2483.50	53.25 PK	74.00	-20.75	1.19 V	0	21.65	31.60
2	2483.50	45.05 AV	54.00	-8.95	1.19 V	0	13.45	31.60
3	4924.00	50.35 PK	74.00	-23.65	1.20 V	135	12.33	38.02

- REMARKS:**
1. Emission level(dBuV/m)=Raw Value(dBuV) + Correction Factor(dB)
 2. Correction Factor(dB/m) = Antenna Factor (dB/m) + Cable Factor (dB)
 3. The other emission levels were very low against the limit.
 4. Margin value = Emission level – Limit value.
 5. The limit value is defined as per 15.247
 6. “ * “ : Fundamental frequency



4.2.9 TEST RESULTS (B)

Mode 1

EUT	2.4/5GHz 54Mbps Wireless Mini PCI Card	MODEL	GL2554MP-1A
MODE	Channel 1	FREQUENCY RANGE	Above 1000 MHz
INPUT POWER (SYSTEM)	120Vac, 60Hz	DETECTOR FUNCTION	Peak(PK) Average (AV)
ENVIRONMENTAL CONDITIONS	30deg. C, 60%RH, 991hPa	TESTED BY: Hardaway Lee	

ANTENNA POLARITY & TEST DISTANCE: HORIZONTAL AT 3 M								
No.	Freq. (MHz)	Emission Level (dBuV/m)	Limit (dBuV/m)	Margin (dB)	Antenna Height (m)	Table Angle (Degree)	Raw Value (dBuV)	Correction Factor (dB/m)
1	2390.00	49.36 PK	74.00	-24.64	1.03 H	49	19.77	29.59
2	*2412.00	94.96 PK			1.03 H	49	65.30	29.66
2	*2412.00	85.58 AV			1.03 H	49	55.92	29.66
3	4824.00	45.57 PK	74.00	-28.43	1.20 H	219	10.31	35.25

ANTENNA POLARITY & TEST DISTANCE: VERTICAL AT 3 M								
No.	Freq. (MHz)	Emission Level (dBuV/m)	Limit (dBuV/m)	Margin (dB)	Antenna Height (m)	Table Angle (Degree)	Raw Value (dBuV)	Correction Factor (dB/m)
1	2390.00	62.20 PK	74.00	-11.80	1.08 V	280	32.60	29.60
1	2390.00	52.00 AV	54.00	-2.00	1.08 V	280	22.40	29.60
2	*2412.00	107.80 PK			1.08 V	280	78.20	29.70
2	*2412.00	97.60 AV			1.08 V	280	68.00	29.70
3	4824.00	47.40 PK	74.00	-26.60	1.45 V	241	12.10	35.30
4	9066.00	59.80 PK	74.00	-14.20	1.34 V	291	17.30	42.50
4	9066.00	46.70 AV	54.00	-7.30	1.34 V	291	4.20	42.50

- REMARKS:**
1. Emission level(dBuV/m)=Raw Value(dBuV) + Correction Factor(dB)
 2. Correction Factor(dB/m) = Antenna Factor (dB/m) + Cable Factor (dB)
 3. The other emission levels were very low against the limit.
 4. Margin value = Emission level – Limit value.
 5. The limit value is defined as per 15.247
 6. “ * “ : Fundamental frequency



EUT	2.4/5GHz 54Mbps Wireless Mini PCI Card	MODEL	GL2554MP-1A
MODE	Channel 6	FREQUENCY RANGE	Above 1000 MHz
INPUT POWER (SYSTEM)	120Vac, 60Hz	DETECTOR FUNCTION	Peak(PK) Average (AV)
ENVIRONMENTAL CONDITIONS	30deg. C, 60%RH, 991hPa	TESTED BY: Hardaway Lee	

ANTENNA POLARITY & TEST DISTANCE: HORIZONTAL AT 3 M								
No.	Freq. (MHz)	Emission Level (dBuV/m)	Limit (dBuV/m)	Margin (dB)	Antenna Height (m)	Table Angle (Degree)	Raw Value (dBuV)	Correction Factor (dB/m)
1	*2437.00	97.72 PK			1.16 H	175	67.98	29.74
1	*2437.00	88.73 AV			1.16 H	175	58.99	29.74
2	4874.00	46.24 PK	74.00	-27.76	1.46 H	258	10.77	35.46
3	7311.00	51.54 PK	74.00	-22.46	1.20 H	324	10.27	41.28
3	7311.00	37.34 AV	54.00	-16.66	1.20 H	324	-3.93	41.28

ANTENNA POLARITY & TEST DISTANCE: VERTICAL AT 3 M								
No.	Freq. (MHz)	Emission Level (dBuV/m)	Limit (dBuV/m)	Margin (dB)	Antenna Height (m)	Table Angle (Degree)	Raw Value (dBuV)	Correction Factor (dB/m)
1	*2437.00	107.33 PK			1.43 V	189	77.59	29.74
1	*2437.00	97.28 AV			1.43 V	189	67.54	29.74
2	4874.00	48.86 PK	74.00	-25.14	1.46 V	254	13.39	35.46
3	7311.00	53.80 PK	74.00	-20.20	1.38 V	13	12.53	41.28
3	7311.00	39.54 AV	54.00	-14.46	1.38 V	13	-1.73	41.28

- REMARKS:**
1. Emission level(dBuV/m)=Raw Value(dBuV) + Correction Factor(dB)
 2. Correction Factor(dB/m) = Antenna Factor (dB/m) + Cable Factor (dB)
 3. The other emission levels were very low against the limit.
 4. Margin value = Emission level – Limit value.
 5. The limit value is defined as per 15.247
 6. “ * “ : Fundamental frequency



EUT	2.4/5GHz 54Mbps Wireless Mini PCI Card	MODEL	GL2554MP-1A
MODE	Channel 11	FREQUENCY RANGE	Above 1000 MHz
INPUT POWER (SYSTEM)	120Vac, 60Hz	DETECTOR FUNCTION	Peak(PK) Average (AV)
ENVIRONMENTAL CONDITIONS	30deg. C, 60%RH, 991hPa	TESTED BY: Hardaway Lee	

ANTENNA POLARITY & TEST DISTANCE: HORIZONTAL AT 3 M								
No.	Freq. (MHz)	Emission Level (dBuV/m)	Limit (dBuV/m)	Margin (dB)	Antenna Height (m)	Table Angle (Degree)	Raw Value (dBuV)	Correction Factor (dB/m)
1	*2462.00	95.72 PK			1.08 H	325	65.89	29.83
1	*2462.00	86.12 AV			1.08 H	325	56.29	29.83
2	2483.50	50.45 PK	74.00	-23.55	1.08 H	325	20.55	29.90
3	4924.00	48.98 PK	74.00	-25.02	1.14 H	241	13.31	35.67
4	7386.00	51.90 PK	74.00	-22.10	1.08 H	325	10.44	41.46
4	7386.00	38.40 AV	54.00	-15.60	1.08 H	325	-3.06	41.46

ANTENNA POLARITY & TEST DISTANCE: VERTICAL AT 3 M								
No.	Freq. (MHz)	Emission Level (dBuV/m)	Limit (dBuV/m)	Margin (dB)	Antenna Height (m)	Table Angle (Degree)	Raw Value (dBuV)	Correction Factor (dB/m)
1	*2462.00	105.94 PK			1.86 V	256	76.28	29.66
1	*2462.00	97.16 AV			1.86 V	256	67.50	29.66
2	2483.50	60.67 PK	74.00	-13.33	1.86 V	256	30.77	29.90
2	2483.50	51.89 AV	54.00	-2.11	1.86 V	256	21.99	29.90
3	4924.00	50.76 PK	74.00	-23.24	1.23 V	352	15.09	35.67
4	7387.00	56.08 PK	74.00	-17.92	1.14 V	177	14.62	41.46
4	7387.00	39.50 AV	54.00	-14.50	1.14 V	177	-1.96	41.46

- REMARKS:**
1. Emission level(dBuV/m)=Raw Value(dBuV) + Correction Factor(dB)
 2. Correction Factor(dB/m) = Antenna Factor (dB/m) + Cable Factor (dB)
 3. The other emission levels were very low against the limit.
 4. Margin value = Emission level – Limit value.
 5. The limit value is defined as per 15.247
 6. " * " : Fundamental frequency



Mode 2

EUT	2.4/5GHz 54Mbps Wireless Mini PCI Card	MODEL	GL2554MP-1A
MODE	Channel 1	FREQUENCY RANGE	Above 1000 MHz
INPUT POWER (SYSTEM)	120Vac, 60Hz	DETECTOR FUNCTION	Peak(PK) Average (AV)
ENVIRONMENTAL CONDITIONS	30deg. C, 60%RH, 991hPa	TESTED BY: Jun Wu	

ANTENNA POLARITY & TEST DISTANCE: HORIZONTAL AT 3 M								
No.	Freq. (MHz)	Emission Level (dBuV/m)	Limit (dBuV/m)	Margin (dB)	Antenna Height (m)	Table Angle (Degree)	Raw Value (dBuV)	Correction Factor (dB/m)
1	2390.00	59.84 PK	74.00	-14.16	1.04 H	329	30.25	29.59
1	2390.00	51.03 AV	54.00	-2.97	1.04 H	329	21.44	29.59
2	*2412.00	105.74 PK			1.04 H	329	76.08	29.66
2	*2412.00	96.93 AV			1.04 H	329	67.27	29.66
3	4824.00	47.85 PK	74.00	-26.15	1.66 H	329	12.59	35.25

ANTENNA POLARITY & TEST DISTANCE: VERTICAL AT 3 M								
No.	Freq. (MHz)	Emission Level (dBuV/m)	Limit (dBuV/m)	Margin (dB)	Antenna Height (m)	Table Angle (Degree)	Raw Value (dBuV)	Correction Factor (dB/m)
1	2390.00	52.46 PK	74.00	-21.54	1.02 V	60	22.87	29.59
1	2390.00	43.10 AV	54.00	-10.90	1.02 V	60	13.51	29.59
2	*2412.00	98.36 PK			1.02 V	60	68.70	29.66
2	*2412.00	89.00 AV			1.02 V	60	59.34	29.66
3	4824.00	49.89 PK	74.00	-24.11	1.08 V	258	14.63	35.25

- REMARKS:**
1. Emission level(dBuV/m)=Raw Value(dBuV) + Correction Factor(dB)
 2. Correction Factor(dB/m) = Antenna Factor (dB/m) + Cable Factor (dB)
 3. The other emission levels were very low against the limit.
 4. Margin value = Emission level – Limit value.
 5. The limit value is defined as per 15.247
 6. “ * “ : Fundamental frequency



EUT	2.4/5GHz 54Mbps Wireless Mini PCI Card	MODEL	GL2554MP-1A
MODE	Channel 6	FREQUENCY RANGE	Above 1000 MHz
INPUT POWER (SYSTEM)	120Vac, 60Hz	DETECTOR FUNCTION	Peak(PK) Average (AV)
ENVIRONMENTAL CONDITIONS	30deg. C, 60%RH, 991hPa	TESTED BY: Jun Wu	

ANTENNA POLARITY & TEST DISTANCE: HORIZONTAL AT 3 M

No.	Freq. (MHz)	Emission Level (dBuV/m)	Limit (dBuV/m)	Margin (dB)	Antenna Height (m)	Table Angle (Degree)	Raw Value (dBuV)	Correction Factor (dB/m)
1	*2437.00	107.41 PK			1.12 H	221	77.67	29.74
1	*2437.00	98.81 AV			1.12 H	221	69.07	29.74
2	4874.00	47.25 PK	74.00	-26.75	1.51 H	221	11.78	35.46

ANTENNA POLARITY & TEST DISTANCE: VERTICAL AT 3 M

No.	Freq. (MHz)	Emission Level (dBuV/m)	Limit (dBuV/m)	Margin (dB)	Antenna Height (m)	Table Angle (Degree)	Raw Value (dBuV)	Correction Factor (dB/m)
1	*2437.00	101.85 PK			1.04 V	63	72.11	29.74
1	*2437.00	92.61 AV			1.04 V	63	62.87	29.74
2	4874.00	47.90 PK	74.00	-26.10	1.18 V	298	12.43	35.46

- REMARKS:**
1. Emission level(dBuV/m)=Raw Value(dBuV) + Correction Factor(dB)
 2. Correction Factor(dB/m) = Antenna Factor (dB/m) + Cable Factor (dB)
 3. The other emission levels were very low against the limit.
 4. Margin value = Emission level – Limit value.
 5. The limit value is defined as per 15.247
 6. " * " : Fundamental frequency



EUT	2.4/5GHz 54Mbps Wireless Mini PCI Card	MODEL	GL2554MP-1A
MODE	Channel 11	FREQUENCY RANGE	Above 1000 MHz
INPUT POWER (SYSTEM)	120Vac, 60Hz	DETECTOR FUNCTION	Peak(PK) Average (AV)
ENVIRONMENTAL CONDITIONS	30deg. C, 60%RH, 991hPa	TESTED BY: Jun Wu	

ANTENNA POLARITY & TEST DISTANCE: HORIZONTAL AT 3 M								
No.	Freq. (MHz)	Emission Level (dBuV/m)	Limit (dBuV/m)	Margin (dB)	Antenna Height (m)	Table Angle (Degree)	Raw Value (dBuV)	Correction Factor (dB/m)
1	*2462.00	106.47 PK			1.04 H	312	76.64	29.83
1	*2462.00	97.51 AV			1.04 H	312	67.68	29.83
2	2483.50	60.79 PK	74.00	-13.21	1.04 H	312	30.89	29.90
2	2483.50	51.83 AV	54.00	-2.17	1.04 H	312	21.93	29.90
3	4924.00	48.71 PK	74.00	-25.29	1.40 H	298	13.04	35.67

ANTENNA POLARITY & TEST DISTANCE: VERTICAL AT 3 M								
No.	Freq. (MHz)	Emission Level (dBuV/m)	Limit (dBuV/m)	Margin (dB)	Antenna Height (m)	Table Angle (Degree)	Raw Value (dBuV)	Correction Factor (dB/m)
1	*2462.00	100.07 PK	74.00	26.07	1.22 V	308	70.24	29.83
1	*2462.00	91.30 AV	54.00	37.30	1.22 V	308	61.47	29.83
2	2483.50	54.39 PK	74.00	-19.61	1.22 V	308	24.49	29.90
2	2483.50	45.62 AV	54.00	-8.38	1.22 V	308	15.72	29.90
3	4924.00	45.71 PK	74.00	-28.29	1.31 V	39	10.04	35.67

- REMARKS:**
1. Emission level(dBuV/m)=Raw Value(dBuV) + Correction Factor(dB)
 2. Correction Factor(dB/m) = Antenna Factor (dB/m) + Cable Factor (dB)
 3. The other emission levels were very low against the limit.
 4. Margin value = Emission level – Limit value.
 5. The limit value is defined as per 15.247
 6. “ * “ : Fundamental frequency



Mode 3

EUT	2.4/5GHz 54Mbps Wireless Mini PCI Card	MODEL	GL2554MP-1A
MODE	Channel 1	FREQUENCY RANGE	Above 1000 MHz
INPUT POWER (SYSTEM)	120Vac, 60Hz	DETECTOR FUNCTION	Peak(PK) Average (AV)
ENVIRONMENTAL CONDITIONS	25deg. C, 60%RH, 991hPa	TESTED BY: Martin Lee	

ANTENNA POLARITY & TEST DISTANCE: HORIZONTAL AT 3 M								
No.	Freq. (MHz)	Emission Level (dBuV/m)	Limit (dBuV/m)	Margin (dB)	Antenna Height (m)	Table Angle (Degree)	Raw Value (dBuV)	Correction Factor (dB/m)
1	2390.00	58.27 PK	74.00	-15.73	1.28 H	229	26.79	31.48
1	2390.00	48.04 AV	54.00	-5.96	1.28 H	229	16.56	31.48
2	*2412.00	102.03 PK			1.28 H	229	70.52	31.51
2	*2412.00	91.80 AV			1.28 H	229	60.29	31.51
3	4824.00	53.11 PK	74.00	-20.89	1.28 H	229	15.26	37.86
3	4824.00	36.62 AV	54.00	-17.38	1.28 H	229	-1.23	37.86

ANTENNA POLARITY & TEST DISTANCE: VERTICAL AT 3 M								
No.	Freq. (MHz)	Emission Level (dBuV/m)	Limit (dBuV/m)	Margin (dB)	Antenna Height (m)	Table Angle (Degree)	Raw Value (dBuV)	Correction Factor (dB/m)
1	2390.00	54.04 PK	74.00	-19.96	1.03 V	316	22.56	31.48
1	2390.00	44.51 AV	54.00	-9.49	1.03 V	316	13.03	31.48
2	*2412.00	97.80 PK			1.03 V	316	66.29	31.51
2	*2412.00	88.27 AV			1.03 V	316	56.76	31.51
3	4824.00	51.35 PK	74.00	-22.65	1.15 V	136	13.50	37.86
3	4824.00	36.07 AV	54.00	-17.93	1.15 V	136	-1.78	37.86

- REMARKS:**
1. Emission level(dBuV/m)=Raw Value(dBuV) + Correction Factor(dB)
 2. Correction Factor(dB/m) = Antenna Factor (dB/m) + Cable Factor (dB)
 3. The other emission levels were very low against the limit.
 4. Margin value = Emission level – Limit value.
 5. The limit value is defined as per 15.247
 6. “ * “ : Fundamental frequency



EUT	2.4/5GHz 54Mbps Wireless Mini PCI Card	MODEL	GL2554MP-1A
MODE	Channel 6	FREQUENCY RANGE	Above 1000 MHz
INPUT POWER (SYSTEM)	120Vac, 60Hz	DETECTOR FUNCTION	Peak(PK) Average (AV)
ENVIRONMENTAL CONDITIONS	25deg. C, 60%RH, 991hPa	TESTED BY: Martin Lee	

ANTENNA POLARITY & TEST DISTANCE: HORIZONTAL AT 3 M

No.	Freq. (MHz)	Emission Level (dBuV/m)	Limit (dBuV/m)	Margin (dB)	Antenna Height (m)	Table Angle (Degree)	Raw Value (dBuV)	Correction Factor (dB/m)
1	*2437.00	104.82 PK			1.06 H	85	73.28	31.54
1	*2437.00	94.53 AV			1.06 H	85	62.99	31.54
2	4874.00	49.48 PK	74.00	-24.52	1.54 H	96	11.54	37.94

ANTENNA POLARITY & TEST DISTANCE: VERTICAL AT 3 M

No.	Freq. (MHz)	Emission Level (dBuV/m)	Limit (dBuV/m)	Margin (dB)	Antenna Height (m)	Table Angle (Degree)	Raw Value (dBuV)	Correction Factor (dB/m)
1	*2437.00	99.81 PK			1.04 V	351	68.27	31.54
1	*2437.00	89.65 AV			1.04 V	351	58.11	31.54
2	4874.00	50.10 PK	74.00	-23.90	1.00 V	199	12.16	37.94

- REMARKS:**
1. Emission level(dBuV/m)=Raw Value(dBuV) + Correction Factor(dB)
 2. Correction Factor(dB/m) = Antenna Factor (dB/m) + Cable Factor (dB)
 3. The other emission levels were very low against the limit.
 4. Margin value = Emission level – Limit value.
 5. The limit value is defined as per 15.247
 6. “ * “ : Fundamental frequency



EUT	2.4/5GHz 54Mbps Wireless Mini PCI Card	MODEL	GL2554MP-1A
MODE	Channel 11	FREQUENCY RANGE	Above 1000 MHz
INPUT POWER (SYSTEM)	120Vac, 60Hz	DETECTOR FUNCTION	Peak(PK) Average (AV)
ENVIRONMENTAL CONDITIONS	25deg. C, 60%RH, 991hPa	TESTED BY: Martin Lee	

ANTENNA POLARITY & TEST DISTANCE: HORIZONTAL AT 3 M

No.	Freq. (MHz)	Emission Level (dBuV/m)	Limit (dBuV/m)	Margin (dB)	Antenna Height (m)	Table Angle (Degree)	Raw Value (dBuV)	Correction Factor (dB/m)
1	*2462.00	101.26 PK			1.00 H	184	69.69	31.57
1	*2462.00	91.94 AV			1.00 H	184	60.37	31.57
2	2483.50	56.03 PK	74.00	-17.97	1.00 H	184	24.43	31.60
2	2483.50	46.71 AV	54.00	-7.29	1.00 H	184	15.11	31.60
3	4924.00	51.39 PK	74.00	-22.61	1.21 H	209	13.37	38.02
3	4924.00	37.04 AV	54.00	-16.96	1.21 H	209	-0.98	38.02
4	7390.00	60.19 PK	74.00	-13.81	1.38 H	84	17.74	42.44
4	7390.00	40.77 AV	54.00	-13.23	1.38 H	84	-1.68	42.44

ANTENNA POLARITY & TEST DISTANCE: VERTICAL AT 3 M

No.	Freq. (MHz)	Emission Level (dBuV/m)	Limit (dBuV/m)	Margin (dB)	Antenna Height (m)	Table Angle (Degree)	Raw Value (dBuV)	Correction Factor (dB/m)
1	*2462.00	101.06 PK			1.67 V	260	69.49	31.57
1	*2462.00	91.20 AV			1.67 V	260	59.63	31.57
2	2483.50	55.83 PK	74.00	-18.17	1.67 V	260	24.23	31.60
2	2483.50	45.97 AV	54.00	-8.03	1.67 V	260	14.37	31.60
3	4924.00	53.56 PK	74.00	-20.44	1.11 V	42	15.54	38.02
3	4924.00	37.17 AV	54.00	-16.83	1.11 V	42	-0.85	38.02
4	7386.00	61.73 PK	74.00	-12.27	1.50 V	82	19.29	42.44
4	7386.00	40.75 AV	54.00	-13.25	1.50 V	82	-1.69	42.44

- REMARKS:**
1. Emission level(dBuV/m)=Raw Value(dBuV) + Correction Factor(dB)
 2. Correction Factor(dB/m) = Antenna Factor (dB/m) + Cable Factor (dB)
 3. The other emission levels were very low against the limit.
 4. Margin value = Emission level – Limit value.
 5. The limit value is defined as per 15.247
 6. “ * “ : Fundamental frequency



Mode 4

EUT	2.4/5GHz 54Mbps Wireless Mini PCI Card	MODEL	GL2554MP-1A
MODE	Channel 1	FREQUENCY RANGE	Above 1000 MHz
INPUT POWER (SYSTEM)	120Vac, 60Hz	DETECTOR FUNCTION	Peak(PK) Average (AV)
ENVIRONMENTAL CONDITIONS	25deg. C, 60%RH, 991hPa	TESTED BY: Martin Lee	

ANTENNA POLARITY & TEST DISTANCE: HORIZONTAL AT 3 M								
No.	Freq. (MHz)	Emission Level (dBuV/m)	Limit (dBuV/m)	Margin (dB)	Antenna Height (m)	Table Angle (Degree)	Raw Value (dBuV)	Correction Factor (dB/m)
1	2390.00	57.29 PK	74.00	-16.71	1.27 H	39	25.81	31.48
1	2390.00	47.38 AV	54.00	-6.62	1.27 H	39	15.90	31.48
2	*2412.00	101.05 PK			1.27 H	39	69.54	31.51
2	*2412.00	91.14 AV			1.27 H	39	59.63	31.51
3	4824.00	50.02 PK	74.00	-23.98	1.03 H	48	12.17	37.86

ANTENNA POLARITY & TEST DISTANCE: VERTICAL AT 3 M								
No.	Freq. (MHz)	Emission Level (dBuV/m)	Limit (dBuV/m)	Margin (dB)	Antenna Height (m)	Table Angle (Degree)	Raw Value (dBuV)	Correction Factor (dB/m)
1	2390.00	58.89 PK	74.00	-15.11	1.00 V	331	27.41	31.48
1	2390.00	49.36 AV	54.00	-4.64	1.00 V	331	17.88	31.48
2	*2412.00	102.65 PK			1.00 V	331	71.14	31.51
2	*2412.00	93.12 AV			1.00 V	331	61.61	31.51
3	4824.00	50.74 PK	74.00	-23.26	1.38 V	231	12.89	37.86

- REMARKS:**
1. Emission level(dBuV/m)=Raw Value(dBuV) + Correction Factor(dB)
 2. Correction Factor(dB/m) = Antenna Factor (dB/m) + Cable Factor (dB)
 3. The other emission levels were very low against the limit.
 4. Margin value = Emission level – Limit value.
 5. The limit value is defined as per 15.247
 6. “ * “ : Fundamental frequency



EUT	2.4/5GHz 54Mbps Wireless Mini PCI Card	MODEL	GL2554MP-1A
MODE	Channel 6	FREQUENCY RANGE	Above 1000 MHz
INPUT POWER (SYSTEM)	120Vac, 60Hz	DETECTOR FUNCTION	Peak(PK) Average (AV)
ENVIRONMENTAL CONDITIONS	25deg. C, 60%RH, 991hPa	TESTED BY: Martin Lee	

ANTENNA POLARITY & TEST DISTANCE: HORIZONTAL AT 3 M

No.	Freq. (MHz)	Emission Level (dBuV/m)	Limit (dBuV/m)	Margin (dB)	Antenna Height (m)	Table Angle (Degree)	Raw Value (dBuV)	Correction Factor (dB/m)
1	*2437.00	102.79 PK			1.27 H	256	71.25	31.54
1	*2437.00	91.63 AV			1.27 H	256	60.09	31.54
2	4874.00	49.90 PK	74.00	-24.10	1.05 H	96	11.96	37.94

ANTENNA POLARITY & TEST DISTANCE: VERTICAL AT 3 M

No.	Freq. (MHz)	Emission Level (dBuV/m)	Limit (dBuV/m)	Margin (dB)	Antenna Height (m)	Table Angle (Degree)	Raw Value (dBuV)	Correction Factor (dB/m)
1	*2437.00	103.31 PK			1.00 V	0	71.77	31.54
1	*2437.00	93.23 AV			1.00 V	0	61.69	31.54
2	4874.00	50.25 PK	74.00	-23.75	1.40 V	139	12.31	37.94

- REMARKS:**
1. Emission level(dBuV/m)=Raw Value(dBuV) + Correction Factor(dB)
 2. Correction Factor(dB/m) = Antenna Factor (dB/m) + Cable Factor (dB)
 3. The other emission levels were very low against the limit.
 4. Margin value = Emission level – Limit value.
 5. The limit value is defined as per 15.247
 6. “ * “ : Fundamental frequency



EUT	2.4/5GHz 54Mbps Wireless Mini PCI Card	MODEL	GL2554MP-1A
MODE	Channel 11	FREQUENCY RANGE	Above 1000 MHz
INPUT POWER (SYSTEM)	120Vac, 60Hz	DETECTOR FUNCTION	Peak(PK) Average (AV)
ENVIRONMENTAL CONDITIONS	25deg. C, 60%RH, 991hPa	TESTED BY: Martin Lee	

ANTENNA POLARITY & TEST DISTANCE: HORIZONTAL AT 3 M

No.	Freq. (MHz)	Emission Level (dBuV/m)	Limit (dBuV/m)	Margin (dB)	Antenna Height (m)	Table Angle (Degree)	Raw Value (dBuV)	Correction Factor (dB/m)
1	*2462.00	100.80 PK			1.00 H	145	69.23	31.57
1	*2462.00	90.65 AV			1.00 H	145	59.08	31.57
2	2483.50	55.57 PK	74.00	-18.43	1.00 H	145	23.97	31.60
2	2483.50	45.42 AV	54.00	-8.58	1.00 H	145	13.82	31.60
3	4924.00	49.58 PK	74.00	-24.42	1.24 H	57	11.56	38.02

ANTENNA POLARITY & TEST DISTANCE: VERTICAL AT 3 M

No.	Freq. (MHz)	Emission Level (dBuV/m)	Limit (dBuV/m)	Margin (dB)	Antenna Height (m)	Table Angle (Degree)	Raw Value (dBuV)	Correction Factor (dB/m)
1	*2462.00	102.07 PK			1.00 V	332	70.50	31.57
1	*2462.00	92.52 AV			1.00 V	332	60.95	31.57
2	2483.50	56.84 PK	74.00	-17.16	1.00 V	332	25.24	31.60
2	2483.50	47.29 AV	54.00	-6.71	1.00 V	332	15.69	31.60
3	4924.00	50.85 PK	74.00	-23.15	1.00 V	14	12.83	38.02

- REMARKS:**
1. Emission level(dBuV/m)=Raw Value(dBuV) + Correction Factor(dB)
 2. Correction Factor(dB/m) = Antenna Factor (dB/m) + Cable Factor (dB)
 3. The other emission levels were very low against the limit.
 4. Margin value = Emission level – Limit value.
 5. The limit value is defined as per 15.247
 6. “ * ” : Fundamental frequency



4.2.10 TEST RESULTS (C)

Mode 2

EUT	2.4/5GHz 54Mbps Wireless Mini PCI Card	MODEL	GL2554MP-1A
MODE	Channel 6	FREQUENCY RANGE	Above 1000 MHz
INPUT POWER (SYSTEM)	120Vac, 60Hz	DETECTOR FUNCTION	Peak(PK) Average (AV)
ENVIRONMENTAL CONDITIONS	25deg. C, 60%RH, 991hPa	TESTED BY: Martin Lee	

ANTENNA POLARITY & TEST DISTANCE: HORIZONTAL AT 3 M								
No.	Freq. (MHz)	Emission Level (dBuV/m)	Limit (dBuV/m)	Margin (dB)	Antenna Height (m)	Table Angle (Degree)	Raw Value (dBuV)	Correction Factor (dB/m)
1	2390.00	52.98 PK	74.00	-21.02	1.00 H	145	21.50	31.48
1	2390.00	42.51 AV	54.00	-11.49	1.00 H	145	11.03	31.48
2	*2437.00	99.71 PK			1.00 H	145	68.17	31.54
2	*2437.00	89.24 AV			1.00 H	145	57.70	31.54
3	2483.50	47.71 PK	74.00	-26.29	1.00 H	145	16.11	31.60
4	4874.00	50.10 PK	74.00	-23.90	1.23 H	57	12.16	37.94

ANTENNA POLARITY & TEST DISTANCE: VERTICAL AT 3 M								
No.	Freq. (MHz)	Emission Level (dBuV/m)	Limit (dBuV/m)	Margin (dB)	Antenna Height (m)	Table Angle (Degree)	Raw Value (dBuV)	Correction Factor (dB/m)
1	2390.00	57.17 PK	74.00	-16.83	1.00 V	140	25.69	31.48
1	2390.00	48.01 AV	54.00	-5.99	1.00 V	140	16.53	31.48
2	*2437.00	103.87 PK			1.00 V	140	72.33	31.54
2	*2437.00	94.74 AV			1.00 V	140	63.20	31.54
3	2483.50	51.87 PK	74.00	-22.13	1.00 V	140	20.27	31.60
3	2483.50	42.74 AV	54.00	-11.26	1.00 V	140	11.14	31.60
4	4874.00	51.18 PK	74.00	-22.82	1.00 V	36	13.24	37.94
4	4874.00	36.10 AV	54.00	-17.90	1.00 V	36	-1.84	37.94

- REMARKS:**
1. Emission level(dBuV/m)=Raw Value(dBuV) + Correction Factor(dB)
 2. Correction Factor(dB/m) = Antenna Factor (dB/m) + Cable Factor (dB)
 3. The other emission levels were very low against the limit.
 4. Margin value = Emission level – Limit value.
 5. The limit value is defined as per 15.247
 6. “ * “ : Fundamental frequency



4.3 6dB BANDWIDTH MEASUREMENT

4.3.1 LIMITS OF 6dB BANDWIDTH MEASUREMENT

The minimum of 6dB Bandwidth Measurement is 0.5 MHz.

4.3.2 TEST INSTRUMENTS

Description & Manufacturer	Model No.	Serial No.	Calibrated Until
SPECTRUM ANALYZER	FSEK30	100049	Aug.12, 2004

4.3.3 TEST PROCEDURE

The transmitter output was connected to the spectrum analyzer through an attenuator. The bandwidth of the fundamental frequency was measured by spectrum analyzer with 100kHz RBW and 100kHz VBW. The 6dB bandwidth is defined as the total spectrum the power of which is higher than peak power minus 6dB.

4.3.4 DEVIATION FROM TEST STANDARD

No deviation

4.3.5 TEST SETUP

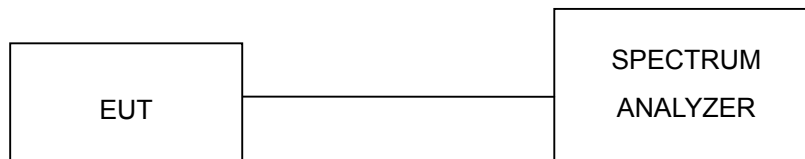

4.3.6 EUT OPERATING CONDITIONS

The software provided by client to enable the EUT under transmission condition continuously at lowest, middle and highest channel frequencies individually.



4.3.7 TEST RESULTS (A)

EUT	2.4/5GHz 54Mbps Wireless Mini PCI Card	MODEL	GL2554MP-1A
INPUT POWER (SYSTEM)	120Vac, 60Hz	ENVIRONMENTAL CONDITIONS	24deg. C, 63%RH, 991hPa
TESTED BY	Ansen Lei		

CHANNEL	CHANNEL FREQUENCY (MHz)	6dB BANDWIDTH (MHz)	MINIMUM LIMIT (MHz)	PASS/FAIL
1	2412	11.86	0.5	PASS
6	2437	11.86	0.5	PASS
11	2462	11.38	0.5	PASS



CH1

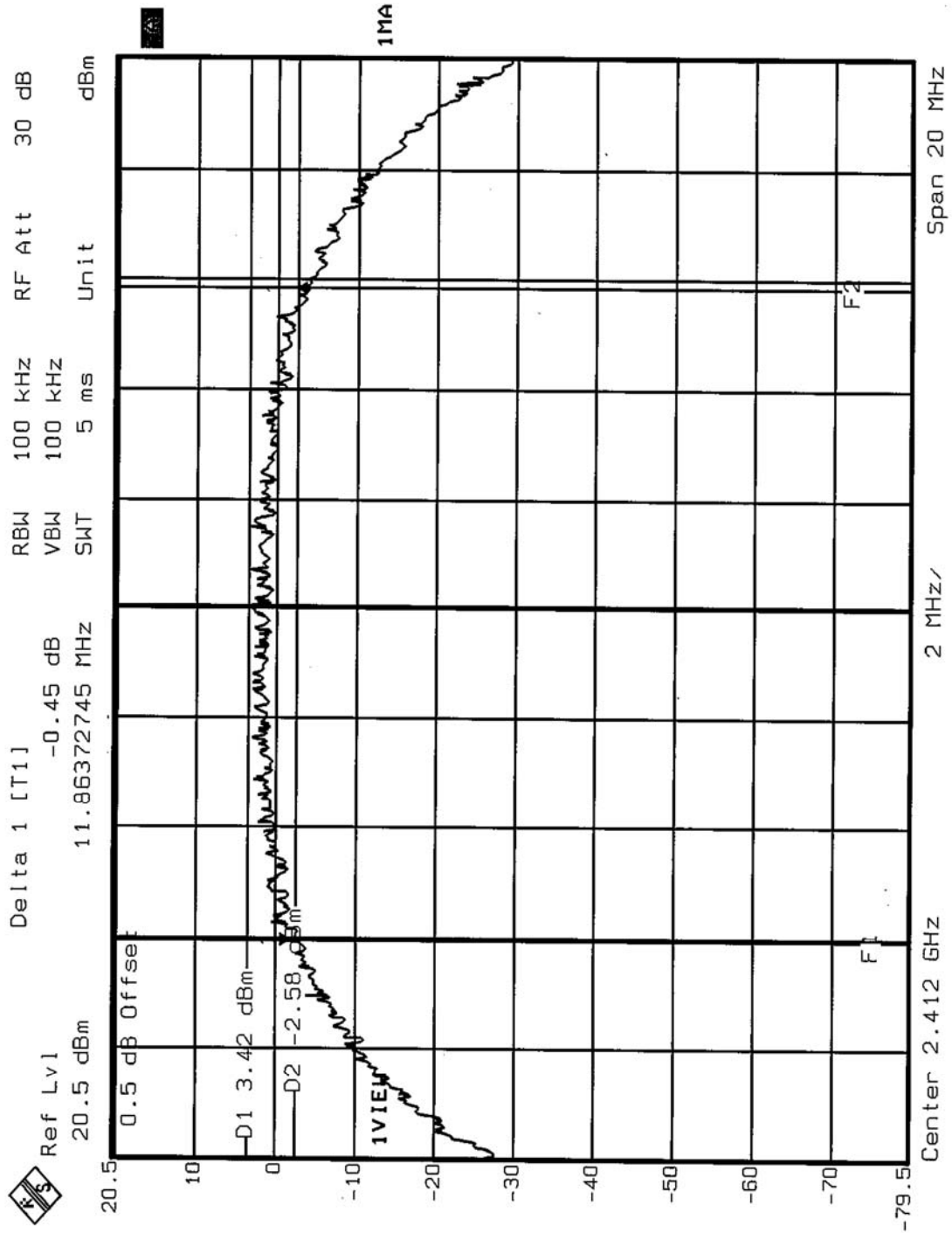



CH6

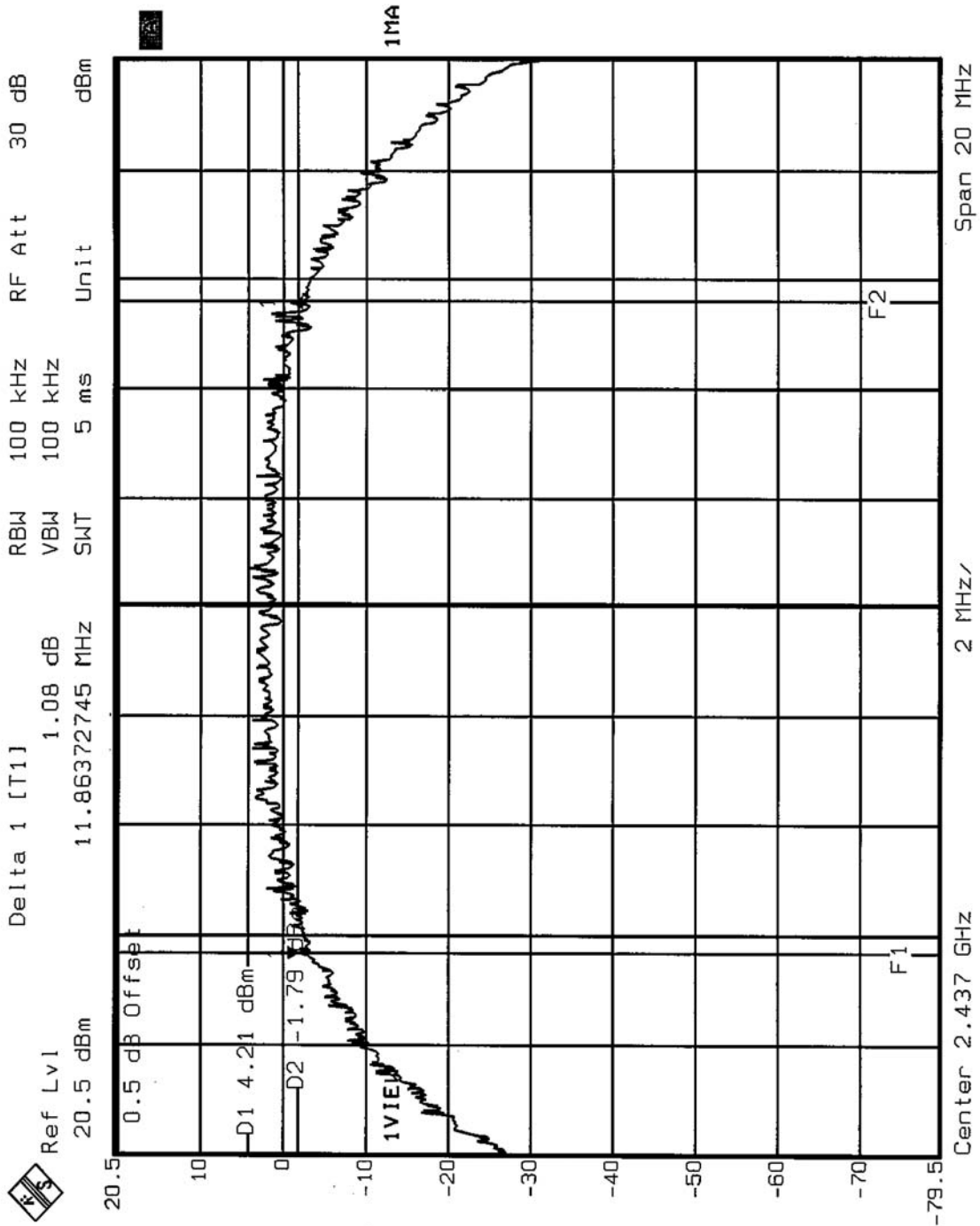



CH11

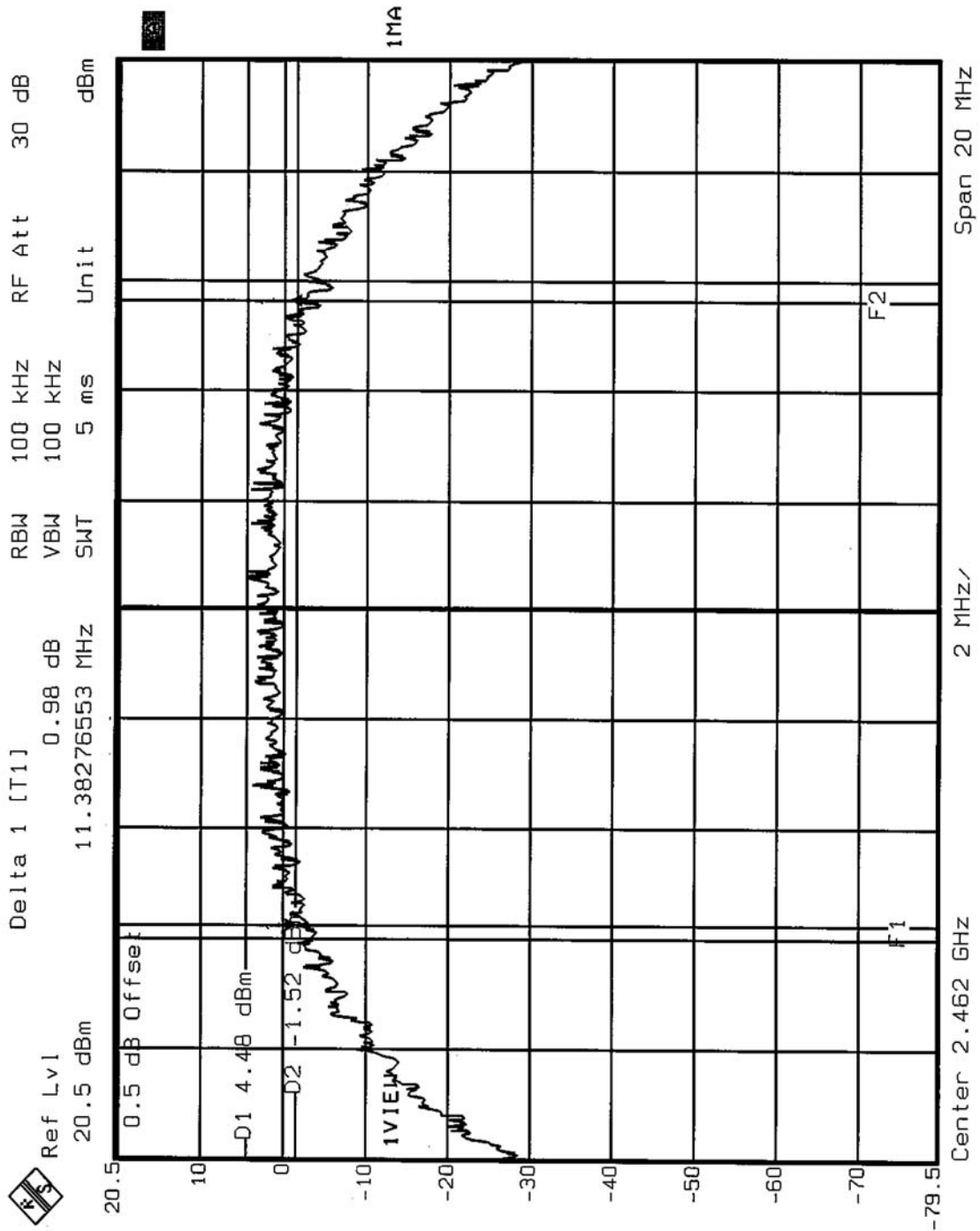



4.3.8 TEST RESULTS (B)

EUT	2.4/5GHz 54Mbps Wireless Mini PCI Card	MODEL	GL2554MP-1A
INPUT POWER (SYSTEM)	120Vac, 60Hz	ENVIRONMENTAL CONDITIONS	24deg. C, 65%RH, 991hPa
TESTED BY	Ansen Lei		

CHANNEL	CHANNEL FREQUENCY (MHz)	6dB BANDWIDTH (MHz)	MINIMUM LIMIT (MHz)	PASS/FAIL
1	2412	16.47	0.5	PASS
6	2437	16.47	0.5	PASS
11	2462	16.47	0.5	PASS



CH1

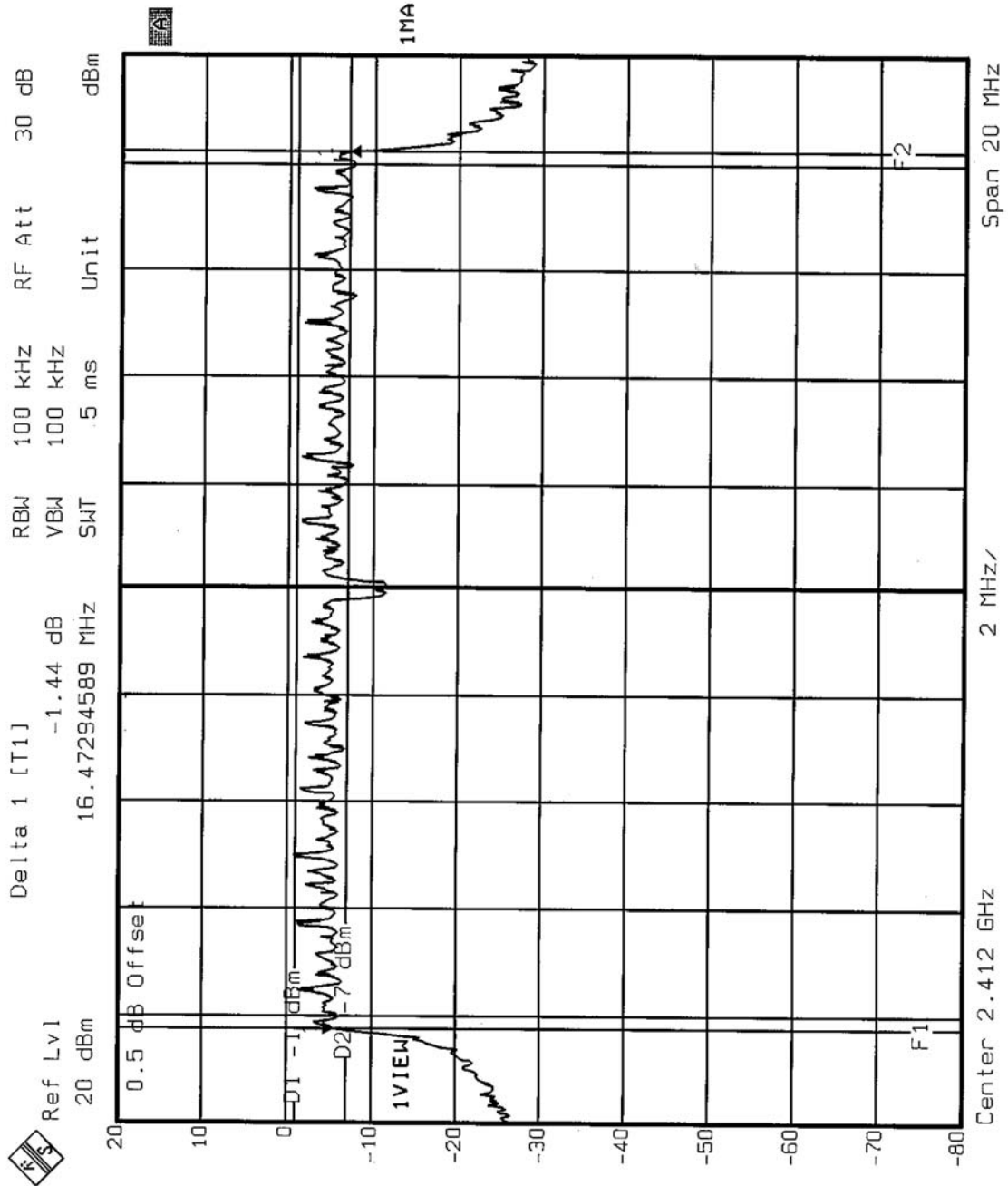



CH6

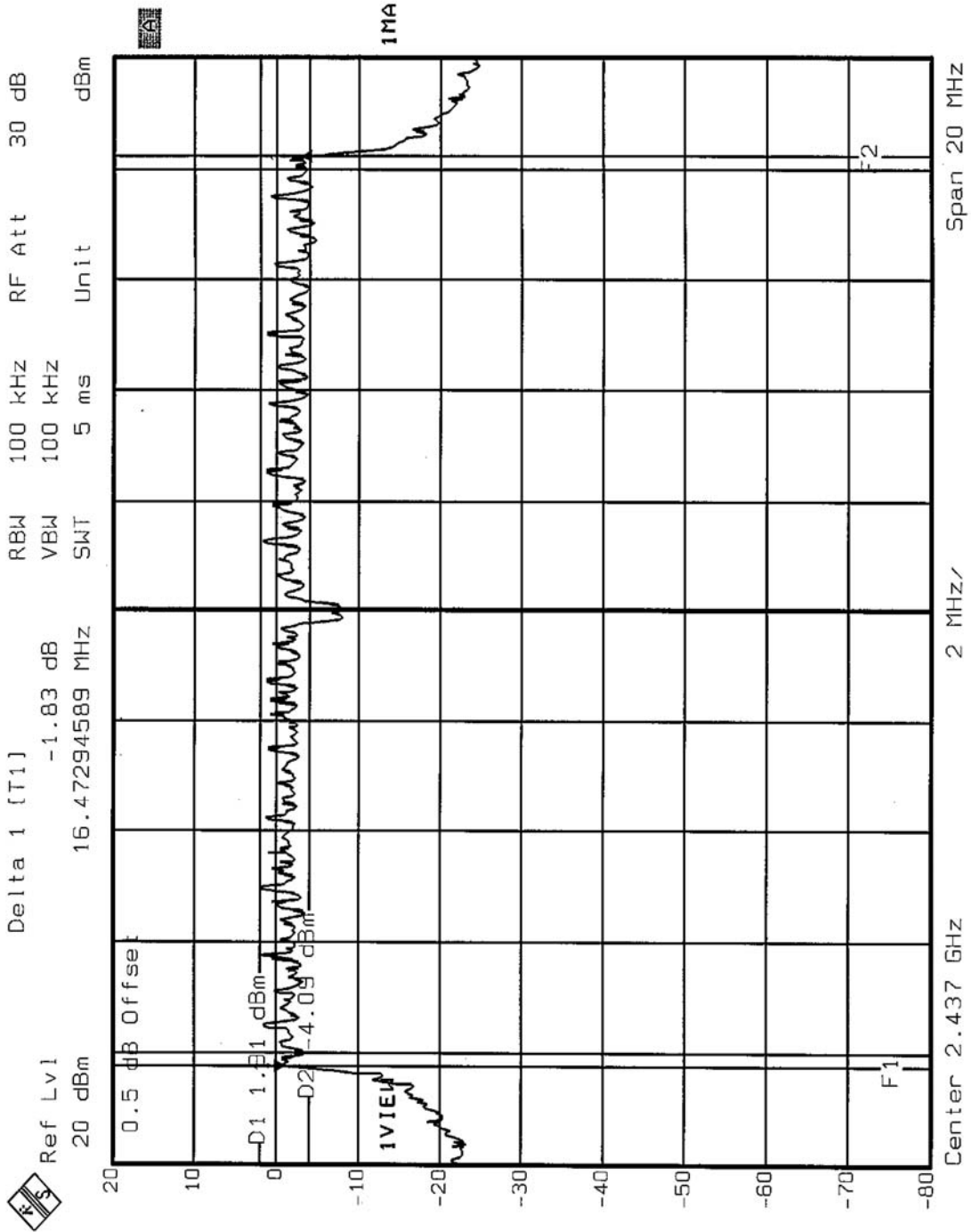



CH11

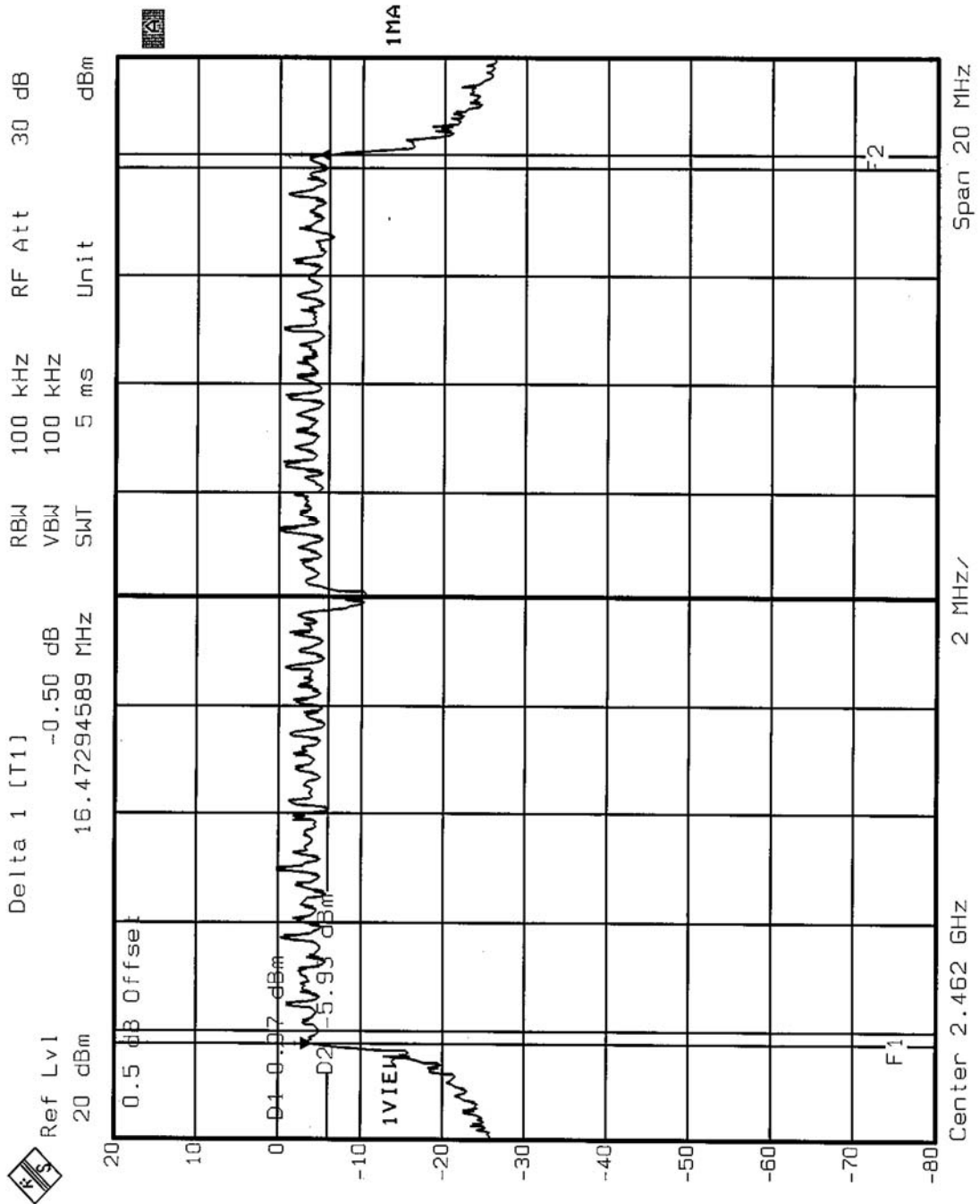



4.3.9 TEST RESULTS (C)

EUT	2.4/5GHz 54Mbps Wireless Mini PCI Card	MODEL	GL2554MP-1A
INPUT POWER (SYSTEM)	120Vac, 60Hz	ENVIRONMENTAL CONDITIONS	24deg. C, 65%RH, 991hPa
TEST MODE	OFDM	TESTED BY	Ansen Lei

CHANNEL	CHANNEL FREQUENCY (MHz)	6dB BANDWIDTH (MHz)	MINIMUM LIMIT (MHz)	PASS/FAIL
6	2437	31.52	0.5	PASS



CH6

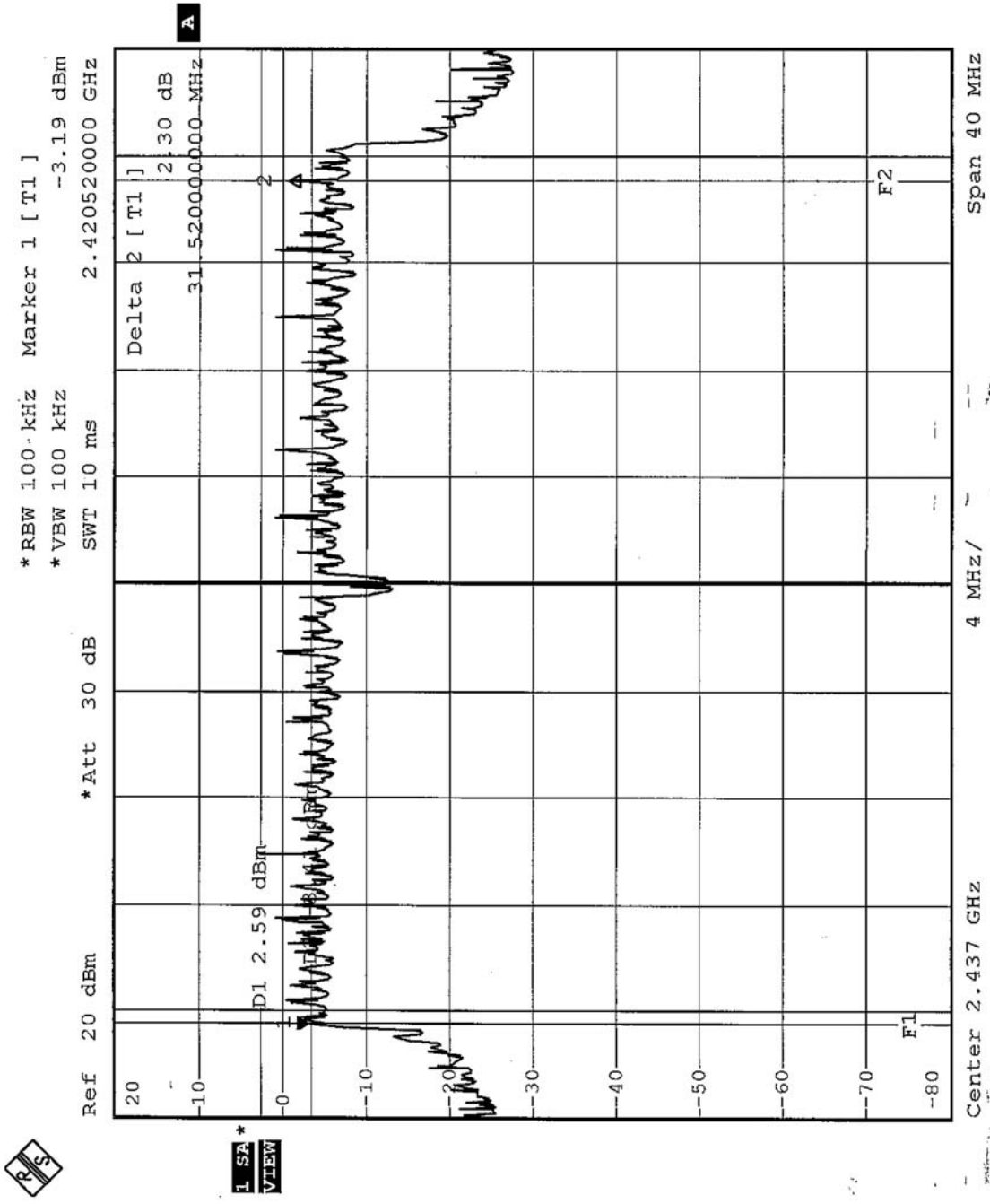



4.4 MAXIMUM PEAK OUTPUT POWER

4.4.1 LIMITS OF MAXIMUM PEAK OUTPUT POWER MEASUREMENT

The Maximum Peak Output Power Measurement is 30dBm.

4.4.2 TEST INSTRUMENTS

Description & Manufacturer	Model No.	Serial No.	Calibrated Until
R&S SPECTRUM ANALYZER	FSEK30	100049	Aug. 12, 2004
R&S SIGNAL GENERATOR	SMP04	100011	May 28, 2004
TEKTRONIX OSCILLOSCOPE	TDS 220	B048470	Mar. 05, 2004
NARDA DETECTOR	4503A	FSCM99899	NA

NOTE: The calibration interval of the above test instruments is 12 months and the calibrations are traceable to NML/ROC and NIST/USA.



4.4.3 TEST PROCEDURES

1. A detector was used on the output port of the EUT. An oscilloscope was used to read the response of the detector.
2. Replaced the EUT by the signal generator . The center frequency of the S.G was adjusted to the center frequency of the measured channel.
3. Adjusted the power to have the same reading on oscilloscope. Record the power level.

4.4.4 DEVIATION FROM TEST STANDARD

No deviation

4.4.5 TEST SETUP

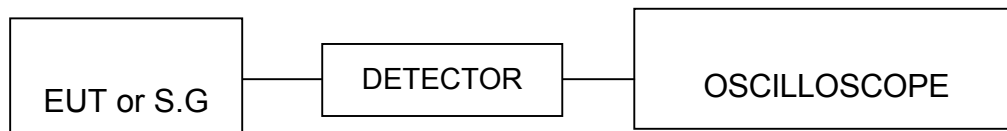

4.4.6 EUT OPERATING CONDITIONS

Same as Item 4.3.6



4.4.7 TEST RESULTS (A)

Mode 1 、 Mode 2 、 Mode 3 、 Mode 4

EUT	2.4/5GHz 54Mbps Wireless Mini PCI Card	MODEL	GL2554MP-1A
INPUT POWER (SYSTEM)	120Vac, 60Hz	ENVIRONMENTAL CONDITIONS	24deg. C, 65%RH, 991hPa
TESTED BY	Ansen Lei		

CHANNEL	CHANNEL FREQUENCY (MHz)	PEAK POWER OUTPUT (dBm)	PEAK POWER LIMIT (dBm)	PASS/FAIL
1	2412	14.54	30	PASS
6	2437	15.56	30	PASS
11	2462	15.54	30	PASS

4.4.8 TEST RESULTS (B)

Mode 1 、 Mode 2 、 Mode 3 、 Mode 4

EUT	2.4/5GHz 54Mbps Wireless Mini PCI Card	MODEL	GL2554MP-1A
INPUT POWER (SYSTEM)	120Vac, 60Hz	ENVIRONMENTAL CONDITIONS	24deg. C, 65%RH, 991hPa
TESTED BY	Ansen Lei		

CHANNEL	CHANNEL FREQUENCY (MHz)	PEAK POWER OUTPUT (dBm)	PEAK POWER LIMIT (dBm)	PASS/FAIL
1	2412	15.50	30	PASS
6	2437	18.00	30	PASS
11	2462	16.00	30	PASS

4.4.9 TEST RESULTS (C)

Mode 2

EUT	2.4/5GHz 54Mbps Wireless Mini PCI Card	MODEL	GL2554MP-1A
INPUT POWER (SYSTEM)	120Vac, 60Hz	ENVIRONMENTAL CONDITIONS	24deg. C, 65%RH, 991hPa
TESTED BY	Ansen Lei		

CHANNEL	CHANNEL FREQUENCY (MHz)	PEAK POWER OUTPUT (dBm)	PEAK POWER LIMIT (dBm)	PASS/FAIL
6	2437	17.60	30	PASS



4.5 POWER SPECTRAL DENSITY MEASUREMENT

4.5.1 LIMITS OF POWER SPECTRAL DENSITY MEASUREMENT

The Maximum of Power Spectral Density Measurement is 8dBm.

4.5.2 TEST INSTRUMENTS

Description & Manufacturer	Model No.	Serial No.	Calibrated Until
SPECTRUM ANALYZER	FSEK30	100049	Aug. 12, 2004

NOTE The calibration interval of the above test instruments is 12 months and the calibrations are traceable to NML/ROC and NIST/USA.

4.5.3 TEST PROCEDURE

The transmitter output was connected to the spectrum analyzer through an attenuator, the bandwidth of the fundamental frequency was measured with the spectrum analyzer using 3kHz RBW and 30kHz VBW, set sweep time = span/3kHz. The power spectral density was measured and recorded. The sweep time is allowed to be longer than span/3kHz for a full response of the mixer in the spectrum analyzer.

4.5.4 DEVIATION FROM TEST STANDARD

No deviation

4.5.5 TEST SETUP

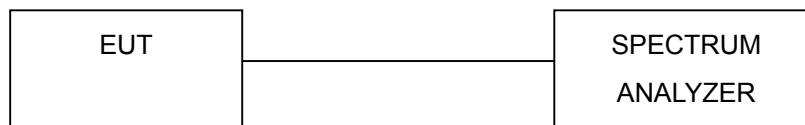

4.5.6 EUT OPERATING CONDITION

Same as Item 4.3.6



4.5.7 TEST RESULTS (A)

EUT	2.4/5GHz 54Mbps Wireless Mini PCI Card	MODEL	GL2554MP-1A
INPUT POWER (SYSTEM)	120Vac, 60Hz	ENVIRONMENTAL CONDITIONS	24deg. C, 65%RH, 991hPa
TESTED BY	Ansen Lei		

CHANNEL	CHANNEL FREQUENCY (MHz)	RF POWER LEVEL IN 3kHz BW (dBm)	MAXIMUM LIMIT (dBm)	PASS/FAIL
1	2412	-10.38	8	PASS
6	2437	-10.30	8	PASS
11	2462	-9.56	8	PASS



CH1

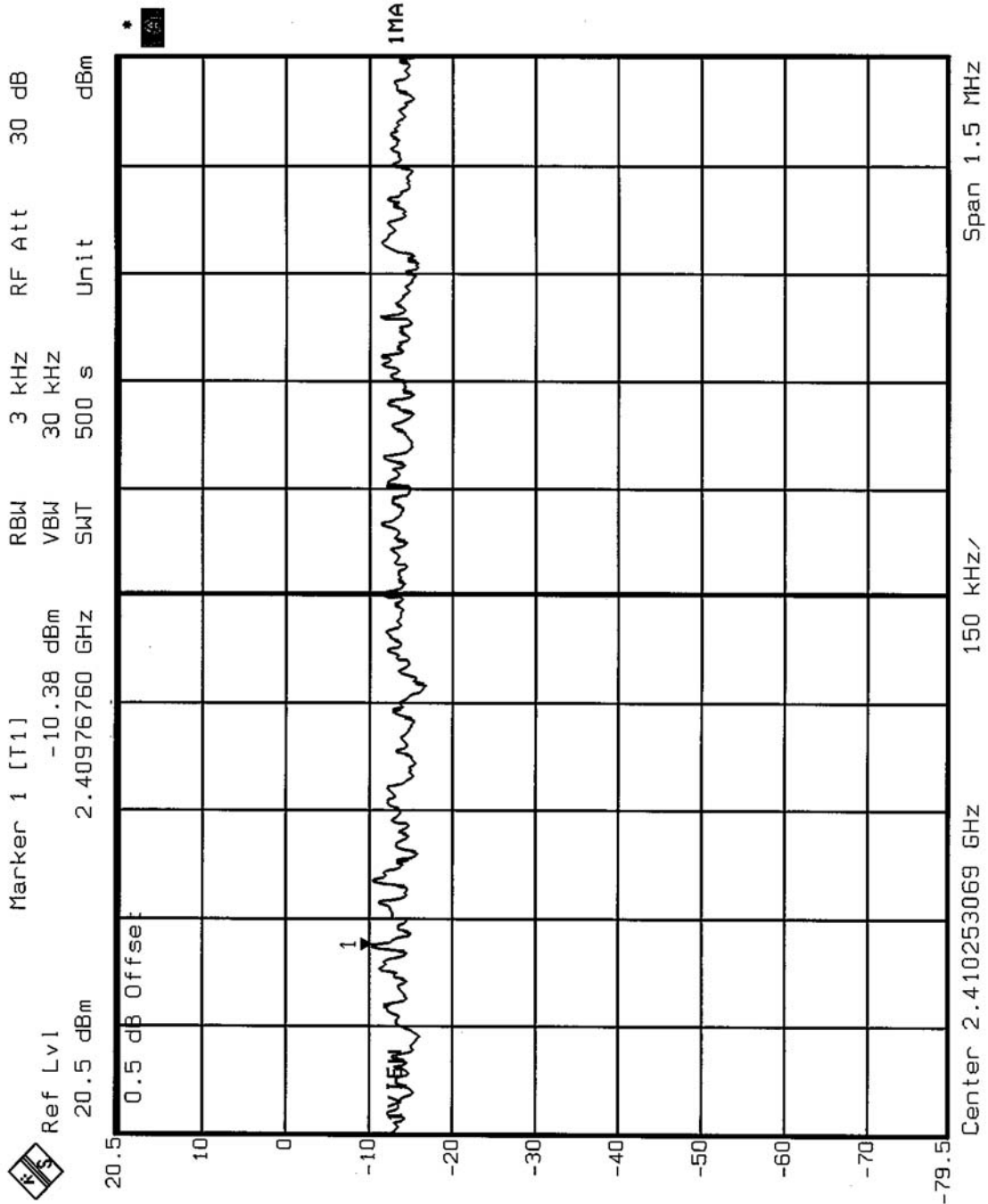



CH6

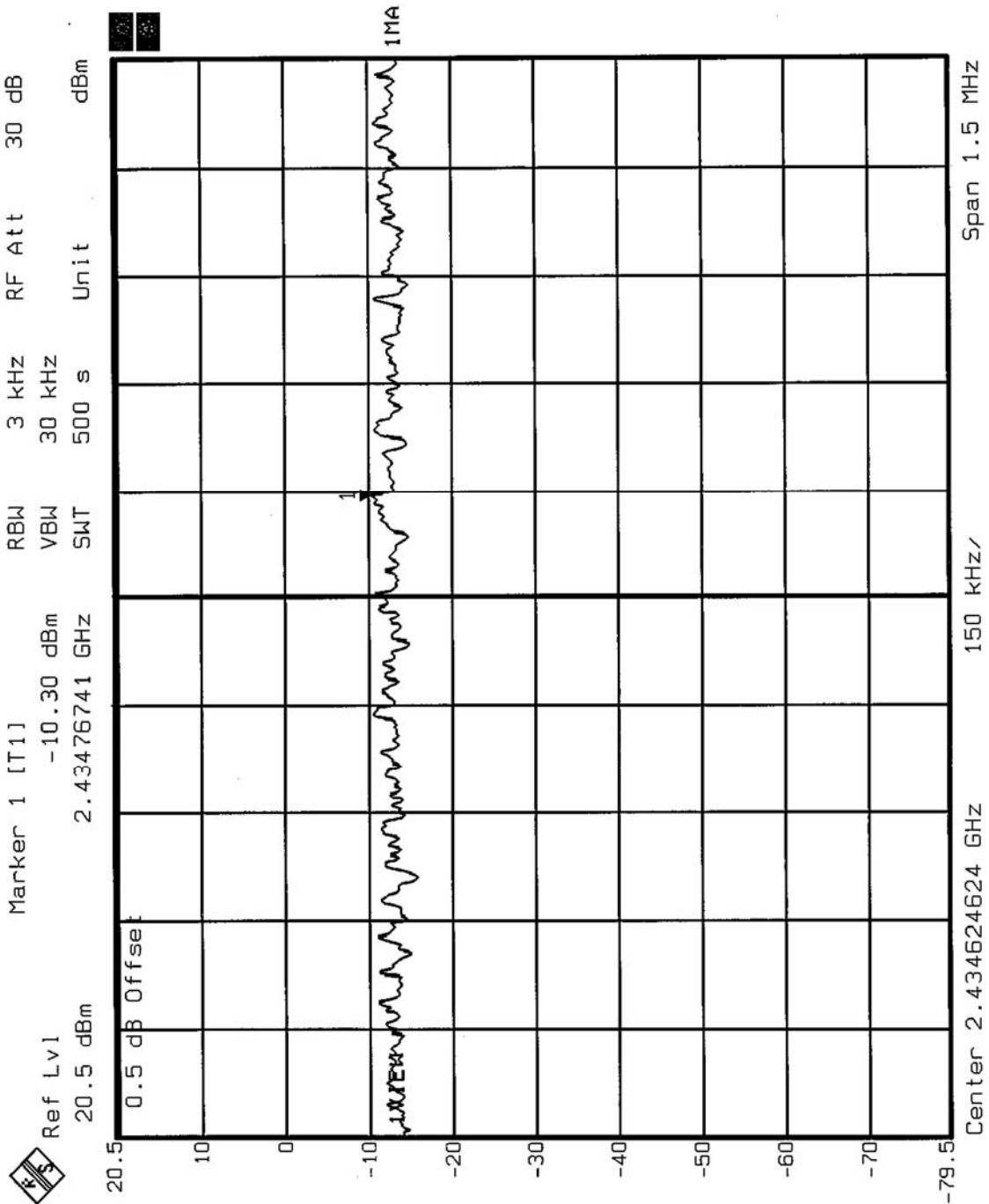



CH11

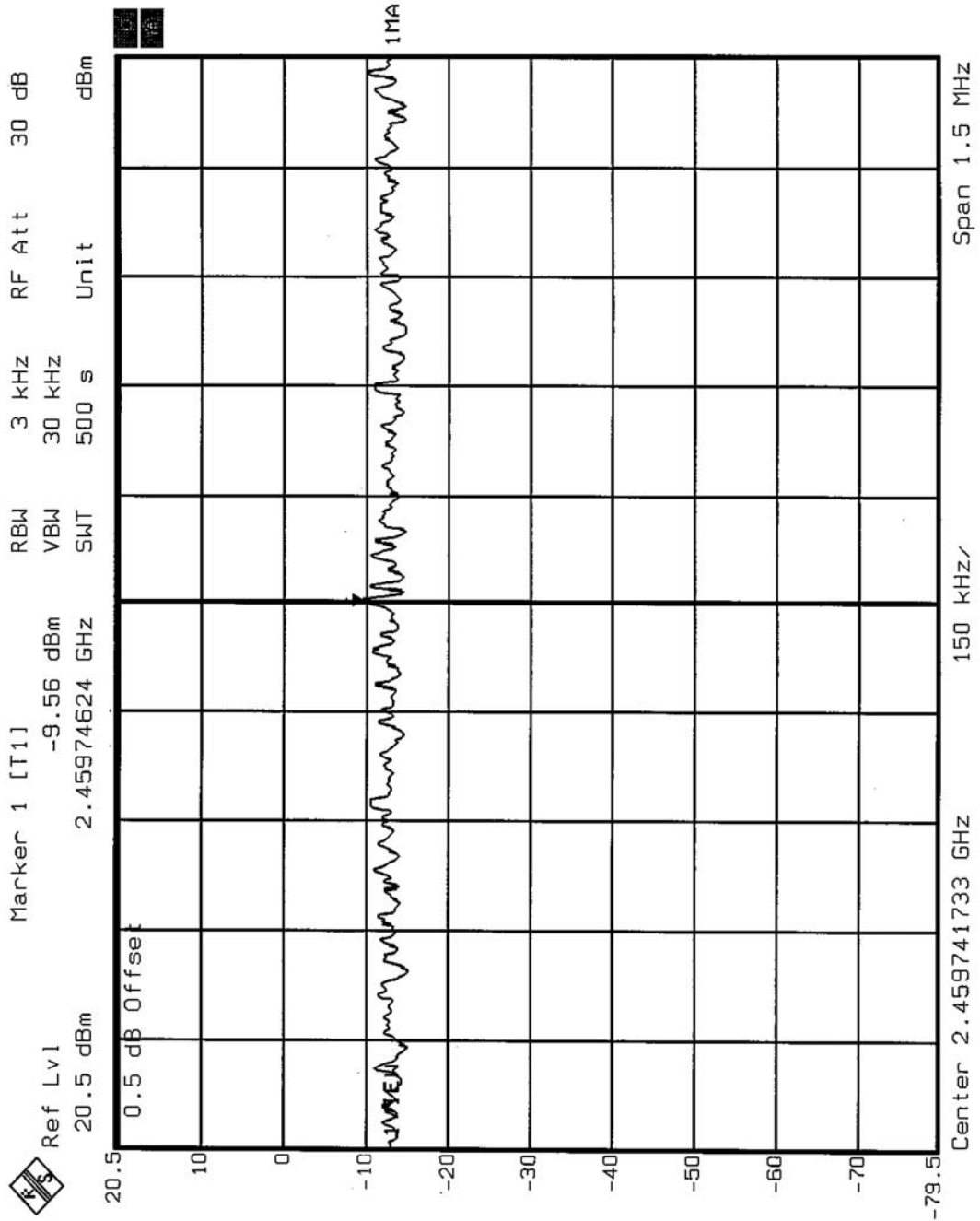

4.5



4.5.8 TEST RESULTS (B)

EUT	2.4/5GHz 54Mbps Wireless Mini PCI Card	MODEL	GL2554MP-1A
INPUT POWER (SYSTEM)	120Vac, 60Hz	ENVIRONMENTAL CONDITIONS	24deg. C, 65%RH, 991hPa
TESTED BY	Ansen Lei		

CHANNEL	CHANNEL FREQUENCY (MHz)	RF POWER LEVEL IN 3kHz BW (dBm)	MAXIMUM LIMIT (dBm)	PASS/FAIL
1	2412	-15.14	8	PASS
6	2437	-13.51	8	PASS
11	2462	-15.10	8	PASS



CH1

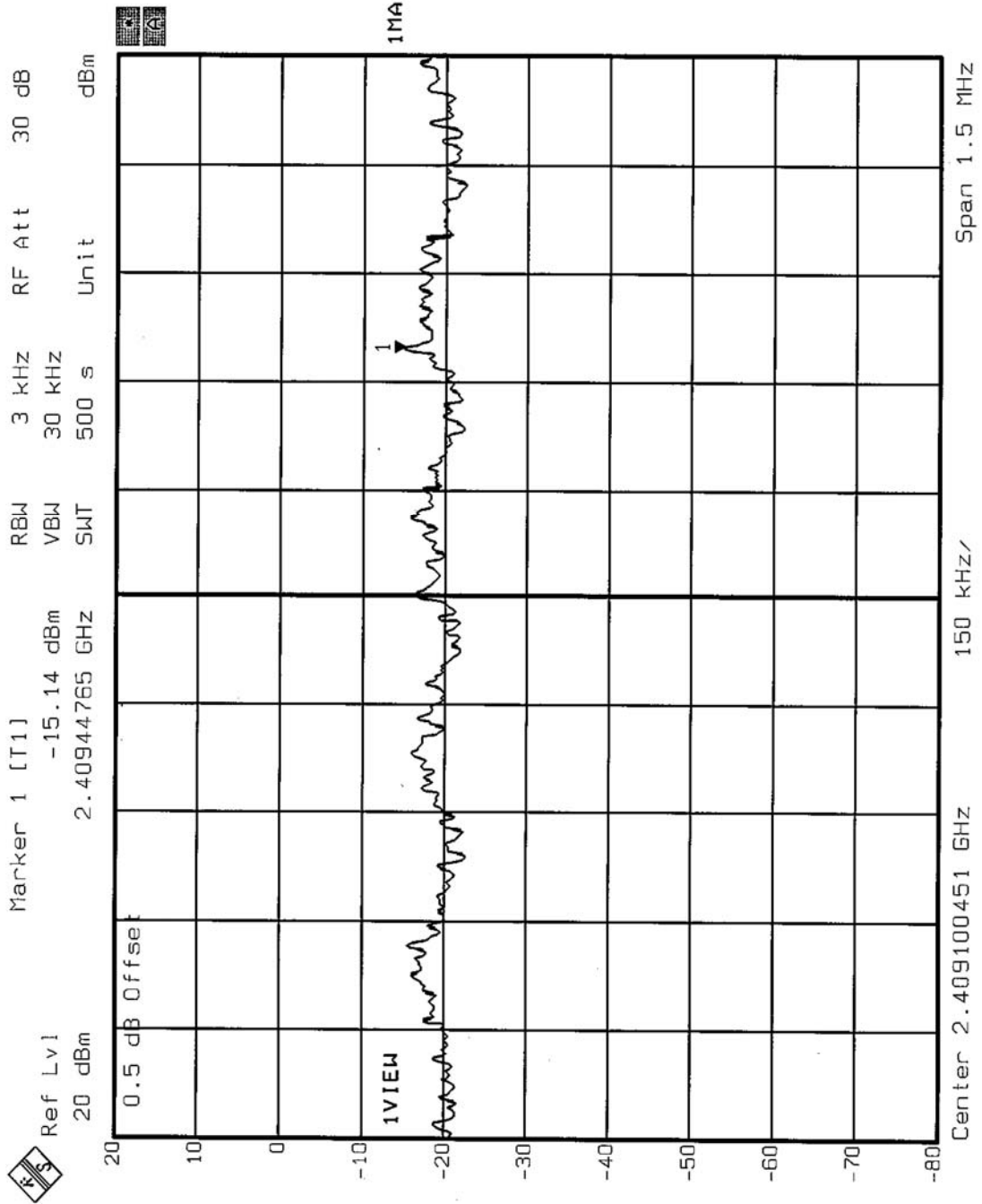



CH6

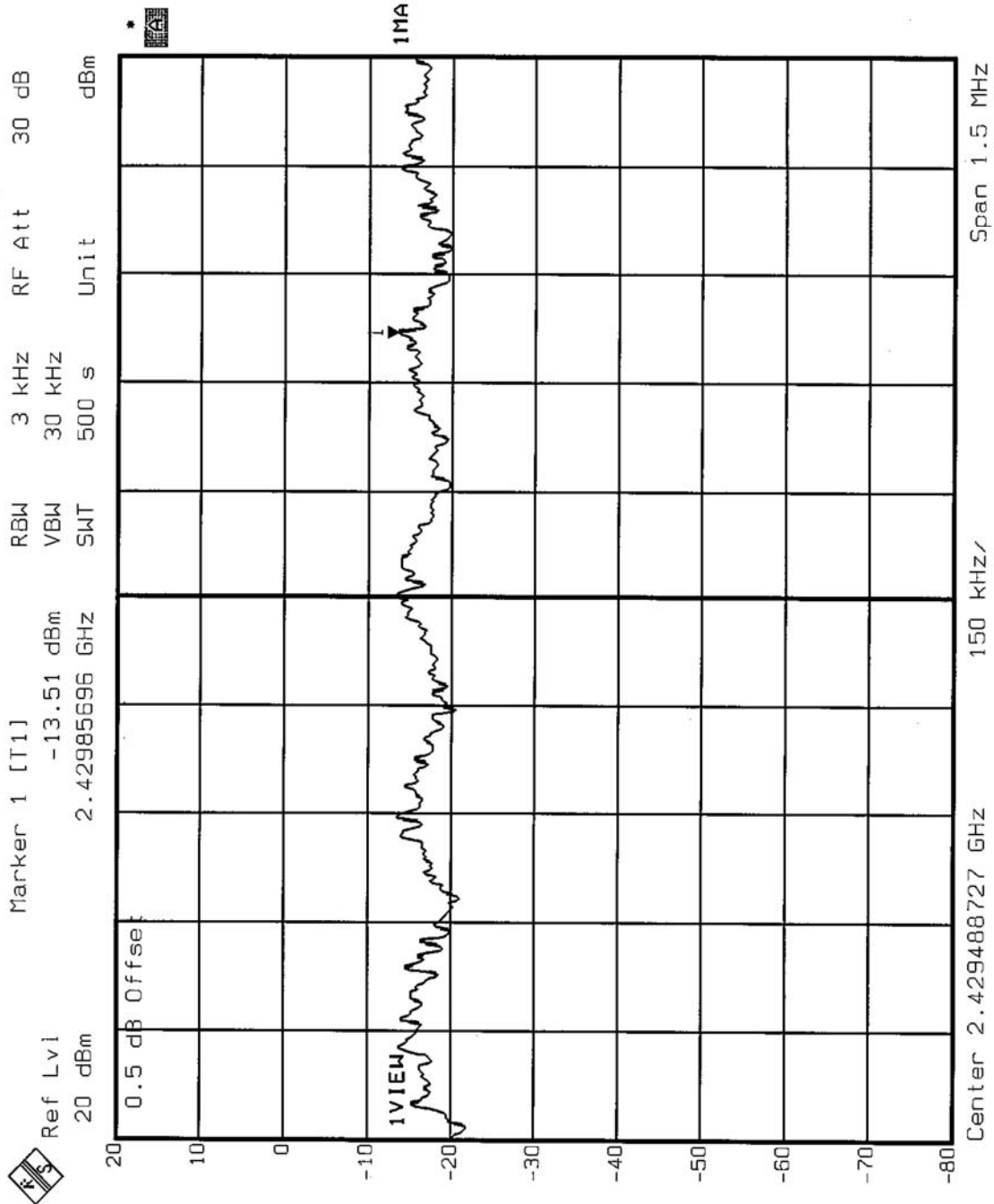



CH11

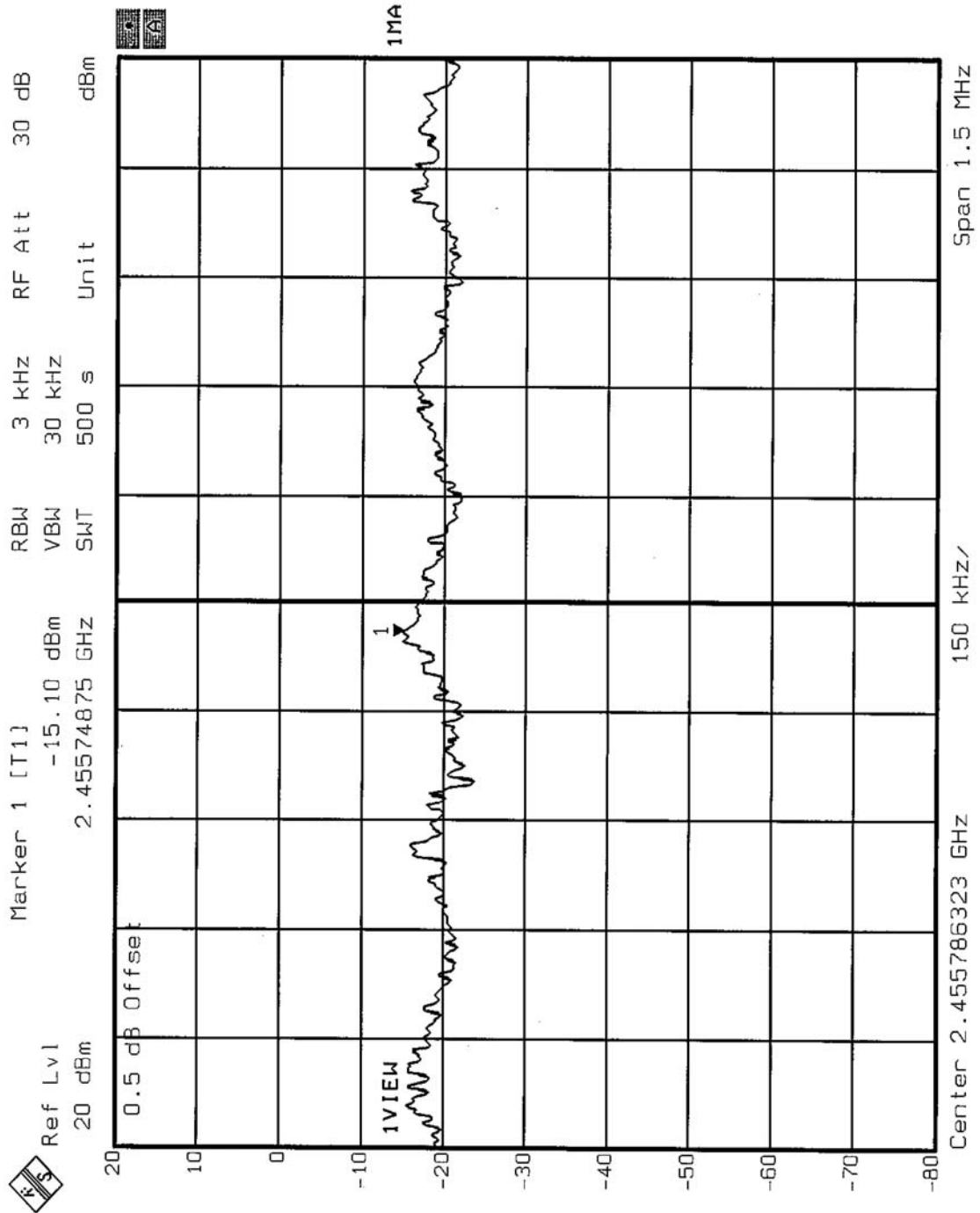



4.5.9 TEST RESULTS (C)

Mode 2

EUT	2.4/5GHz 54Mbps Wireless Mini PCI Card	MODEL	GL2554MP-1A
INPUT POWER (SYSTEM)	120Vac, 60Hz	ENVIRONMENTAL CONDITIONS	24deg. C, 65%RH, 991hPa
TESTED BY	Ansen Lei		

CHANNEL	CHANNEL FREQUENCY (MHz)	RF POWER LEVEL IN 3kHz BW (dBm)	MAXIMUM LIMIT (dBm)	PASS/FAIL
6	2437	-13.45	8	PASS



CH6

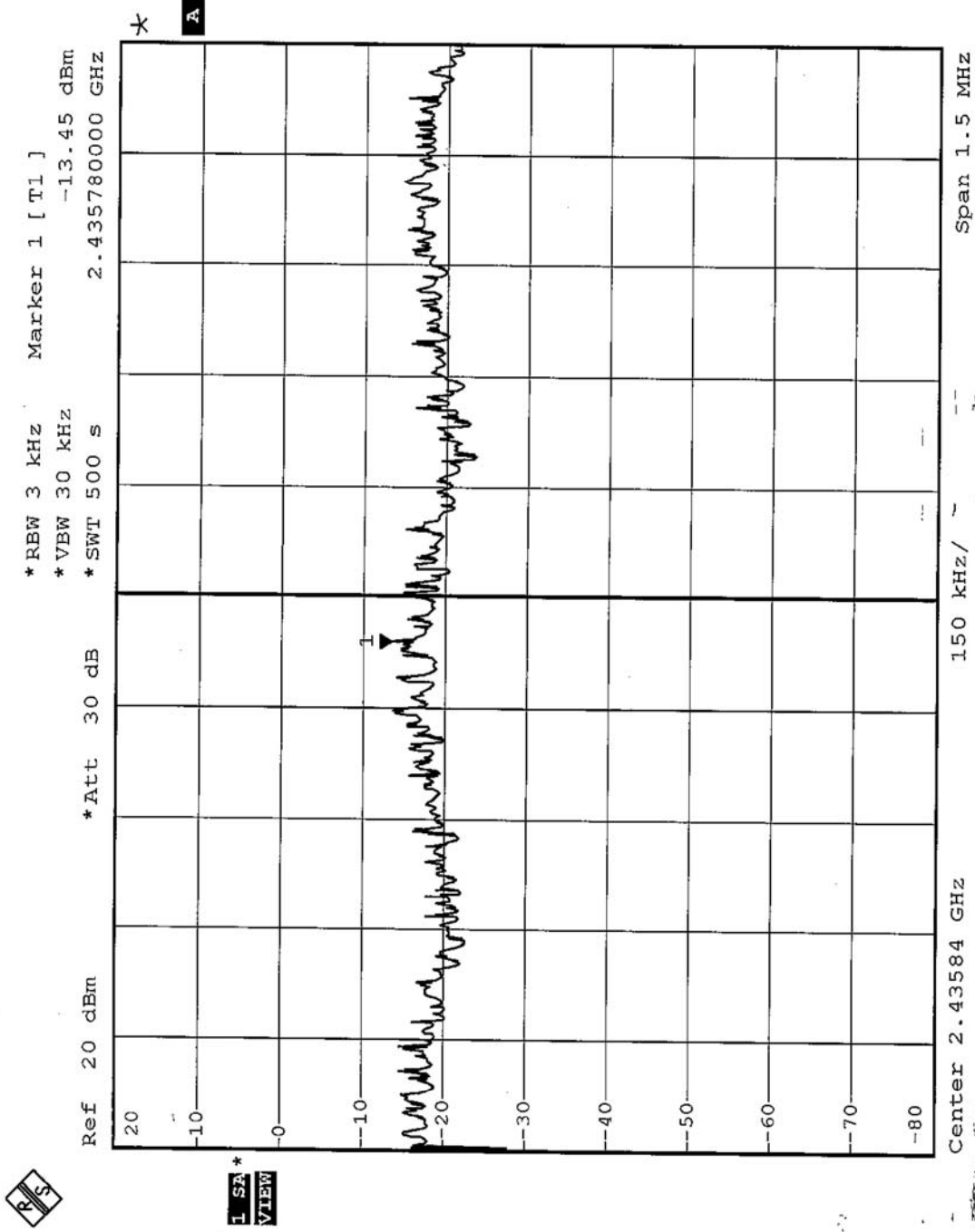



4.6 BAND EDGES MEASUREMENT

4.6.1 LIMITS OF BAND EDGES MEASUREMENT

Below -20dB of the highest emission level of operating band (in 100KHz Resolution Bandwidth).

4.6.2 TEST INSTRUMENTS

Description & Manufacturer	Model No.	Serial No.	Calibrated Until
SPECTRUM ANALYZER	FSEK30	100049	Aug. 12, 2004

NOTE: The measurement uncertainty is less than +/- 2.6dB, which is calculated as per the NAMAS document NIS81.

4.6.3 TEST PROCEDURE

The transmitter output was connected to the spectrum analyzer via a low lose cable. Set both RBW and VBW of spectrum analyzer to 100kHz with suitable frequency span including 100kHz bandwidth from band edge. The band edges was measured and recorded.

4.6.4 DEVIATION FROM TEST STANDARD

No deviation

4.6.5 EUT OPERATING CONDITION

Same as Item 4.3.6



4.6.6 TEST RESULTS (A)

The spectrum plots are attached on the following 2 pages. D2 line indicates the highest level, D1 line indicates the 20dB offset below D2. It shows compliance with the requirement in part 15.247(C).

Mode 1 、 Mode 2 、 Mode 3 、 Mode 4

NOTE 1: The band edge emission plot of CCK technique on the following page shows 50.83dB delta between carrier maximum power and local maximum emission in restrict band (2.3865GHz). The emission of carrier strength list in the test result of channel 1 at the item 4.2.8 is 102.36dBuV/m, so the maximum field strength in restrict band is $102.36 - 50.83 = 51.53$ dBuV/m which is under 54dBuV/m limit.

NOTE 2: The band edge emission plot of CCK on the following page shows 51.53dB delta between carrier maximum power and local maximum emission in restrict band (2.4879GHz). The emission of carrier strength list in the test result of channel 11 at the item 4.2.8 is 104.01dBuV/m, so the maximum field strength in restrict band is $104.01 - 51.53 = 52.48$ dBuV/m which is under 54 dBuV/m limit.

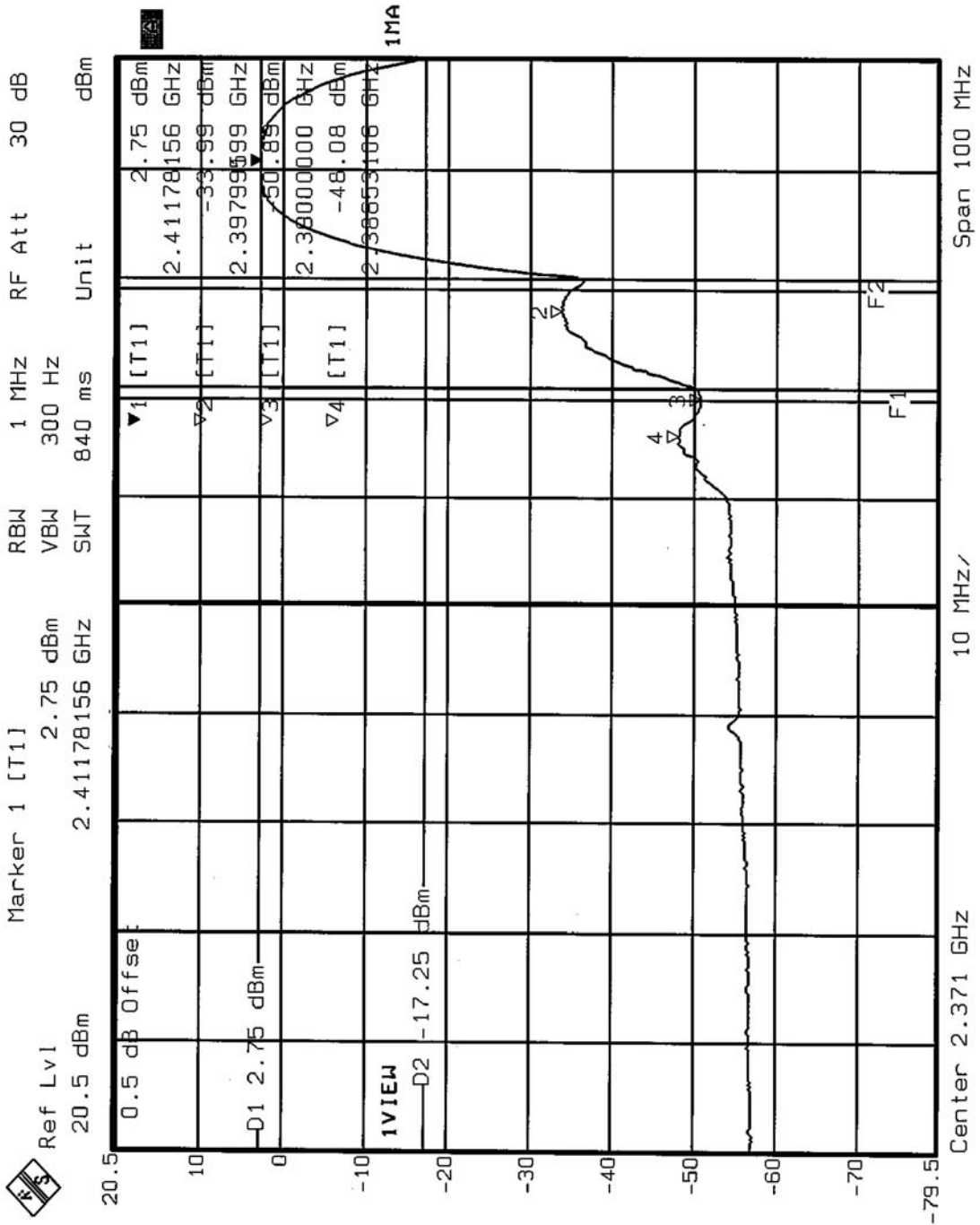

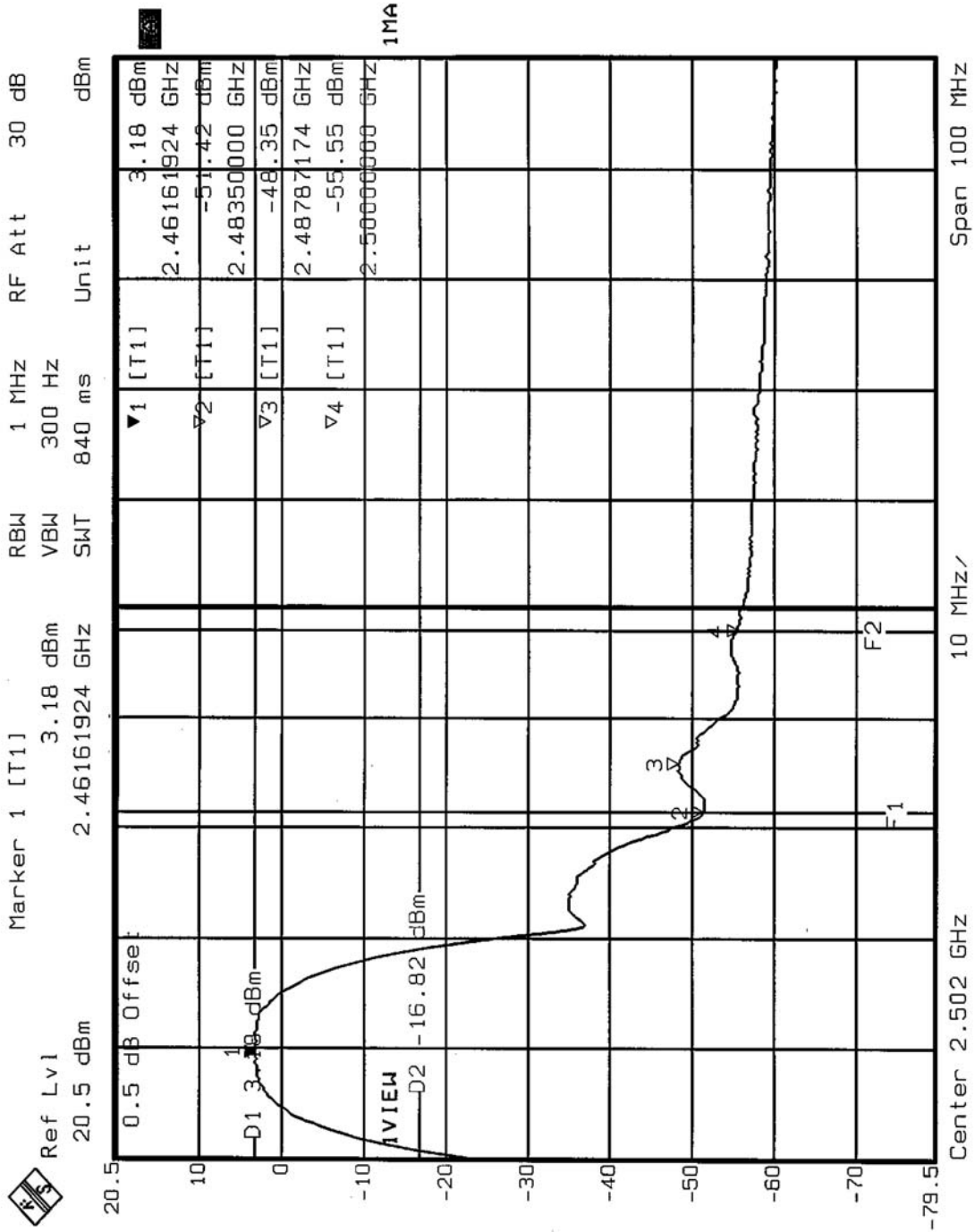



4.6.7 TEST RESULTS (B)

The spectrum plots are attached on the following 2 pages. D2 line indicates the highest level, D1 line indicates the 20dB offset below D2. It shows compliance with the requirement in part 15.247(C).

Mode 1 、 Mode 2 、 Mode 3 、 Mode 4

NOTE 1: The band edge emission plot of OFDM technique on the following page shows 45.02dB delta between carrier maximum power and local maximum emission in restrict band (2.3900GHz). The emission of carrier strength list in the test result of channel 1 at the item 4.2.9 is 97.60dBuV/m, so the maximum field strength in restrict band is $97.60-45.02=52.58$ dBuV/m which is under 54 dBuV/m limit.

NOTE 2: The band edge emission plot of OFDM on the following page shows 45.18dB delta between carrier maximum power and local maximum emission in restrict band (2.4835GHz). The emission of carrier strength list in the test result of channel 11 at the item 4.2.9 is 97.51dBuV/m, so the maximum field strength in restrict band is $97.51-45.18=52.33$ dBuV/m which is under 54dBuV/m limit.

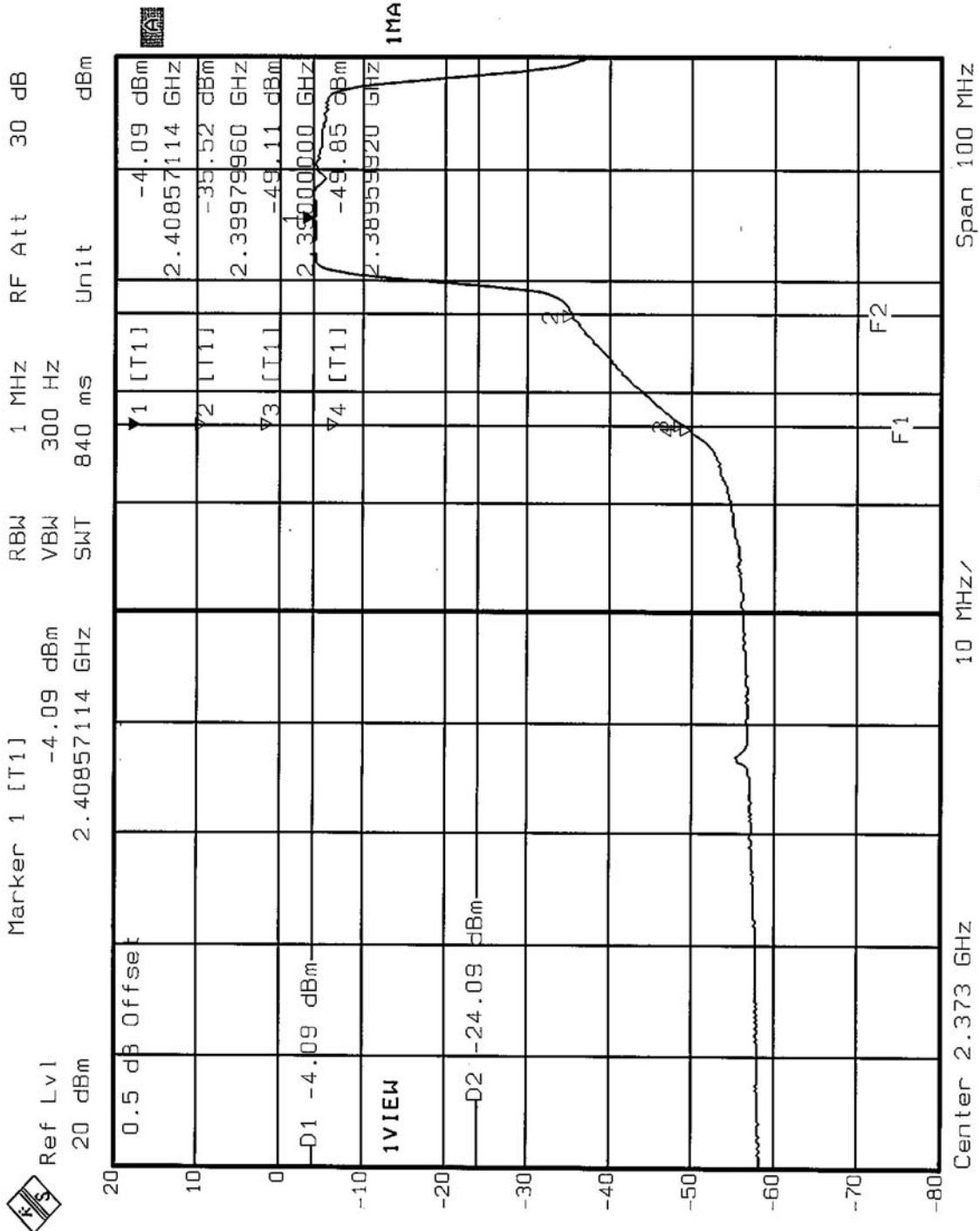

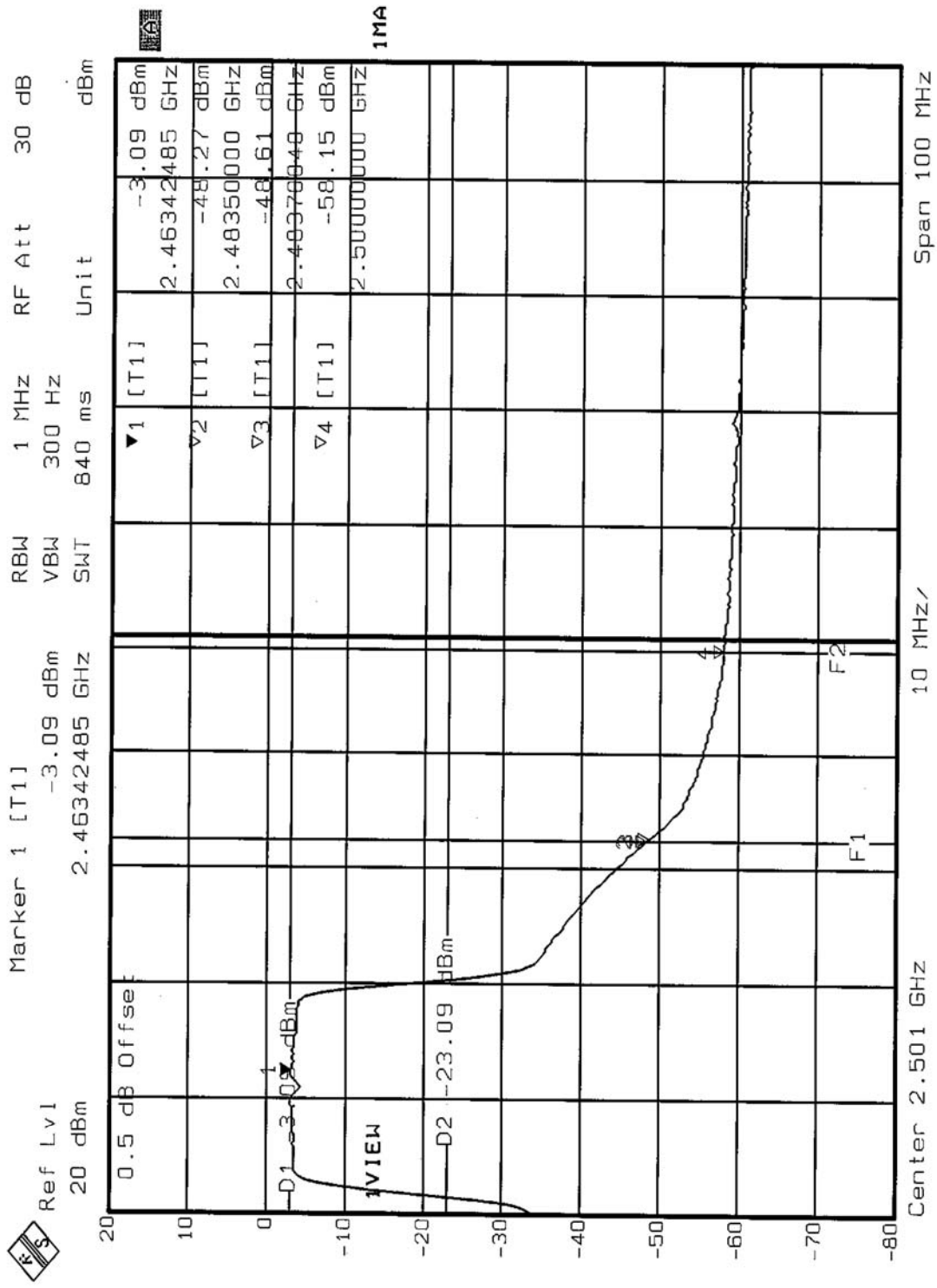



4.6.8 TEST RESULTS (C)

The spectrum plots are attached on the following 2 pages. D2 line indicates the highest level, D1 line indicates the 20dB offset below D2. It shows compliance with the requirement in part 15.247(C).

Mode 2

NOTE 1: The band edge emission plot of technique on the following page shows 45.56dB delta between carrier maximum power and local maximum emission in restrict band (2.3898GHz). The emission of carrier strength list in the test result of channel 1 at the item 4.2.10 is 94.74dBuV/m, so the maximum field strength in restrict band is $94.74 - 45.56 = 49.18$ dBuV/m which is under 54 dBuV/m limit.

NOTE 2: The band edge emission plot of on the following page shows 50.57dB delta between carrier maximum power and local maximum emission in restrict band (2.4835GHz). The emission of carrier strength list in the test result of channel 11 at the item 4.2.10 is 94.74dBuV/m, so the maximum field strength in restrict band is $94.74 - 50.57 = 44.17$ dBuV/m which is under 54dBuV/m limit.

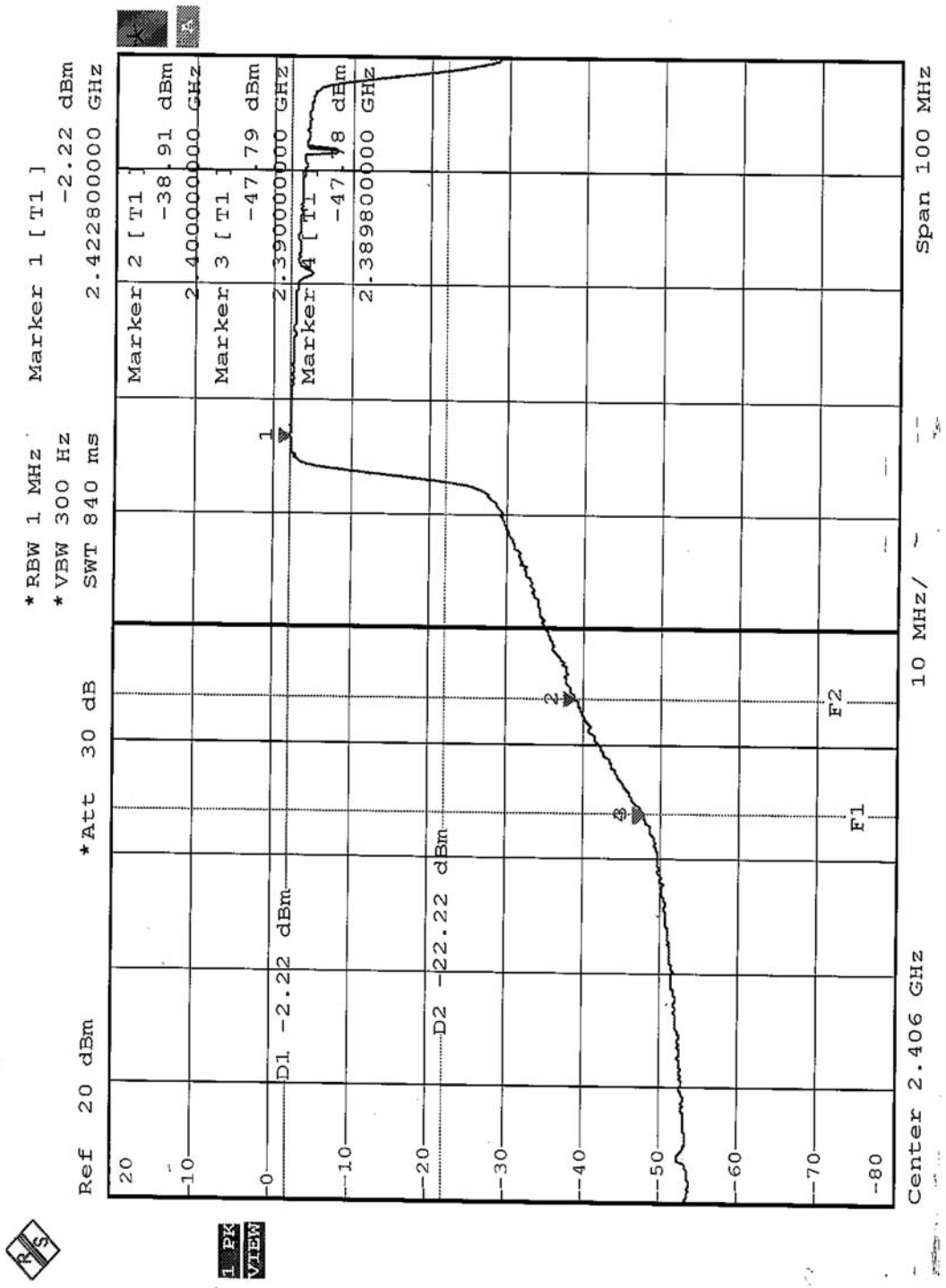

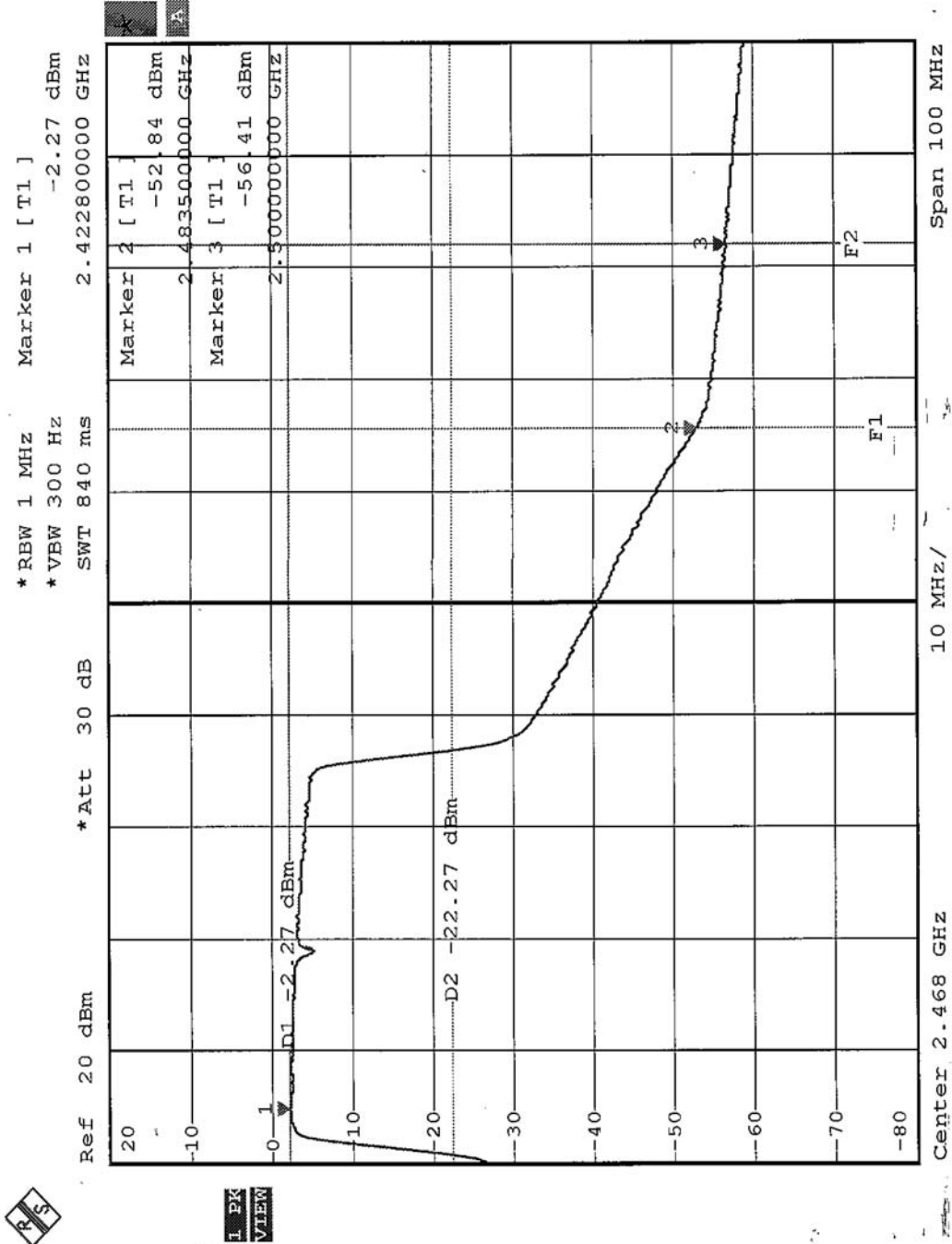



4.7 ANTENNA REQUIREMENT

4.7.1 STANDARD APPLICABLE

For intentional device, according to FCC 47 CFR Section 15.203, an intentional radiator shall be designed to ensure that no antenna other than that furnished by the responsible party shall be used with the device. And according to FCC 47 CFR Section 15.247 (b), if transmitting antennas of directional gain greater than 6dBi are used, the power shall be reduced by the amount in dB that the directional gain of the antenna exceeds 6dBi.

4.7.2 ANTENNA CONNECTED CONSTRUCTION

The antennas used in this product are dipole and PIFA antennas with UFL connector. The maximum Gain of the antenna is 5dBi.



5. TEST TYPES AND RESULTS (FOR PART 802.11a)

5.1 CONDUCTED EMISSION MEASUREMENT

5.1.1 LIMITS OF CONDUCTED EMISSION MEASUREMENT

FREQUENCY OF EMISSION (MHz)	CONDUCTED LIMIT (dB μ V)	
	Quasi-peak	Average
0.15-0.5	66 to 56	56 to 46
0.5-5	56	46
5-30	60	50

- NOTE:**
1. The lower limit shall apply at the transition frequencies.
 2. The limit decreases in line with the logarithm of the frequency in the range of 0.15 to 0.50 MHz.
 3. All emanations from a class A/B digital device or system, including any network of conductors and apparatus connected thereto, shall not exceed the level of field strengths specified above.

5.1.2 TEST INSTRUMENTS

DESCRIPTION & MANUFACTURER	MODEL NO.	SERIAL NO.	CALIBRATED UNTIL
ROHDE & SCHWARZ Test Receiver	ESCS 30	838251/021	Jan. 20, 2004
ROHDE & SCHWARZ Artificial Mains Network (for EUT)	ESH3-Z5	100218	Dec. 18, 2003
ROHDE & SCHWARZ Artificial Mains Network (for peripherals)	ESH3-Z5	100219	Dec. 18, 2003
ROHDE & SCHWARZ Artificial Mains Network (for peripherals)	ESH3-Z5	100220	Dec. 18, 2003
*ROHDE & SCHWARZ 4-wire ISN	ENY41	837032/016	Nov. 19 2004
*ROHDE & SCHWARZ 2-wire ISN	ENY22	837497/016	Nov. 19 2004
Software	Cond-V2M3	NA	NA
RF cable (JYEBAO)	5D-FB	Cable-C10.01	May 01, 2004
SUHNER Terminator (For ROHDE & SCHWARZ LISN)	65BNC-5001	E1-010770	Mar. 24, 2004
SUHNER Terminator (For ROHDE & SCHWARZ LISN)	65BNC-5001	E1-010773	Apr. 06, 2004

- NOTE:**
1. The calibration interval of the above test instruments is 12 months and the calibrations are traceable to NML/ROC and NIST/USA.
 2. “*”: These equipment are used for conducted telecom port test only (if tested).
 3. The test was performed in ADT Shielded Room No. 10.
 4. The VCCI Site Registration No. is C-1312.



5.1.3 TEST PROCEDURES

- a. The EUT was placed 0.4 meters from the conducting wall of the shielded room with EUT being connected to the power mains through a line impedance stabilization network (LISN). Other support units were connected to the power mains through another LISN. The two LISNs provide 50 ohm/ 50uH of coupling impedance for the measuring instrument.
- b. Both lines of the power mains connected to the EUT were checked for maximum conducted interference.
- c. The frequency range from 150kHz to 30MHz was searched. Emission levels over 10dB under the prescribed limits could not be reported

5.1.4 DEVIATION FROM TEST STANDARD

No deviation

5.1.5 TEST SETUP

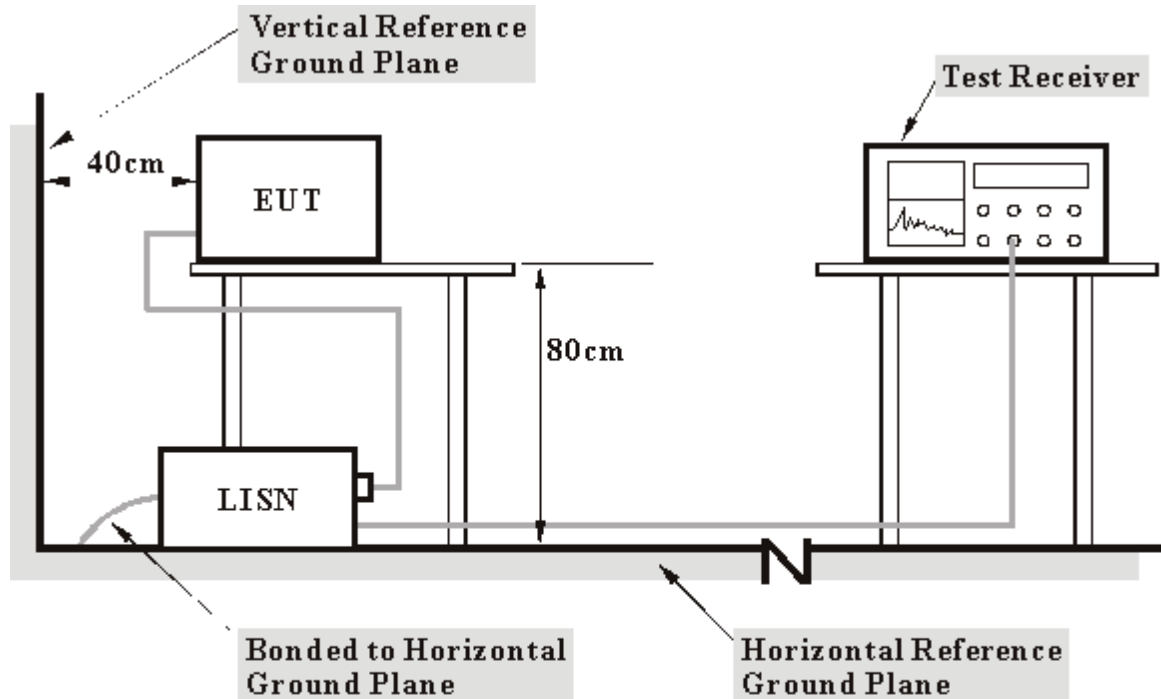

- Note:**
1. Support units were connected to second LISN.
 2. Both of LISNs (AMN) 80 cm from EUT and at the least 80 cm from other units and other metal planes support units.

For the actual test configuration, please refer to the related item – Photographs of the Test Configuration.

5.1.6 EUT OPERATING CONDITIONS

Same as 4.1.6



5.1.7 TEST RESULTS

EUT	2.4/5GHz 54Mbps Wireless Mini PCI Card	MODEL	GL2554MP-1A
		6dB BANDWIDTH	9 kHz
INPUT POWER (SYSTEM)	120Vac, 60 Hz	PHASE	Line (L)
ENVIRONMENTAL CONDITIONS	25deg. C, 60%RH, 991hPa	TESTED BY: Martin Lee	

No	Freq. [MHz]	Corr. Factor (dB)	Reading Value [dB (uV)]		Emission Level [dB (uV)]		Limit [dB (uV)]		Margin (dB)	
			Q.P.	AV.	Q.P.	AV.	Q.P.	AV.	Q.P.	AV.
1	0.181	0.06	48.58	-	48.64	-	64.43	54.43	-15.79	-
2	0.298	0.06	37.32	-	37.38	-	60.29	50.29	-22.91	-
3	0.838	0.13	26.65	-	26.78	-	56.00	46.00	-29.22	-
4	3.832	0.22	32.07	-	32.29	-	56.00	46.00	-23.71	-
5	13.595	0.52	31.87	-	32.39	-	60.00	50.00	-27.61	-
6	28.367	0.89	29.57	-	30.46	-	60.00	50.00	-29.54	-

- REMARKS:**
1. Q.P. and AV. are abbreviations of quasi-peak and average individually.
 2. "-": The Quasi-peak reading value also meets average limit and measurement with the average detector is unnecessary.
 3. The emission levels of other frequencies were very low against the limit.
 4. Margin value = Emission level - Limit value
 5. Correction factor = Insertion loss + Cable loss
 6. Emission Level = Correction Factor + Reading Value.

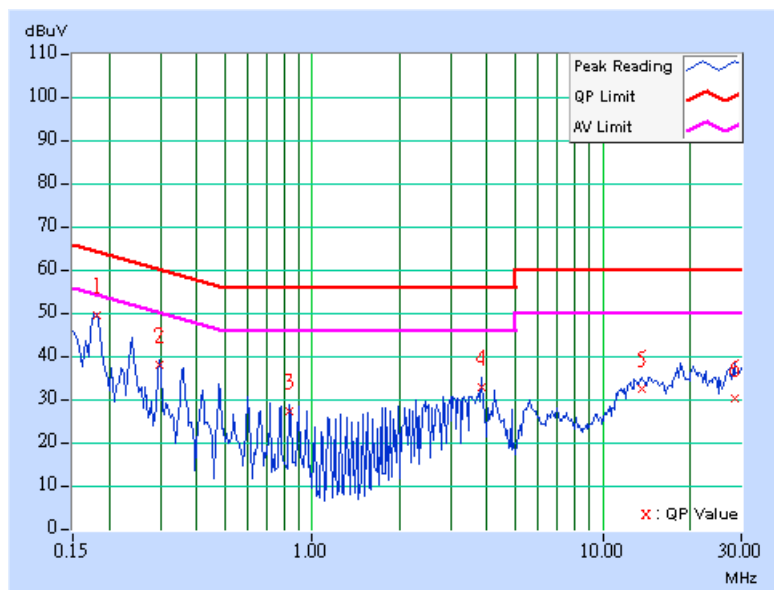



EUT	2.4/5GHz 54Mbps Wireless Mini PCI Card	MODEL	GL2554MP-1A
		6dB BANDWIDTH	9 kHz
INPUT POWER (SYSTEM)	120Vac, 60 Hz	PHASE	Neutral (N)
ENVIRONMENTAL CONDITIONS	25deg. C, 60%RH, 991hPa	TESTED BY: Martin Lee	

No	Freq. [MHz]	Corr. Factor (dB)	Reading Value [dB (uV)]		Emission Level [dB (uV)]		Limit [dB (uV)]		Margin (dB)	
			Q.P.	AV.	Q.P.	AV.	Q.P.	AV.	Q.P.	AV.
1	0.181	0.05	47.05	-	47.10	-	64.43	54.43	-17.33	-
2	0.357	0.05	33.10	-	33.15	-	58.80	48.80	-25.65	-
3	0.838	0.13	25.50	-	25.63	-	56.00	46.00	-30.37	-
4	3.887	0.21	35.79	-	36.00	-	56.00	46.00	-20.00	-
5	13.699	0.46	31.57	-	32.03	-	60.00	50.00	-27.97	-
6	27.517	0.72	30.81	-	31.53	-	60.00	50.00	-28.47	-

- REMARKS:**
1. Q.P. and AV. are abbreviations of quasi-peak and average individually.
 2. "-": The Quasi-peak reading value also meets average limit and measurement with the average detector is unnecessary.
 3. The emission levels of other frequencies were very low against the limit.
 4. Margin value = Emission level - Limit value
 5. Correction factor = Insertion loss + Cable loss
 6. Emission Level = Correction Factor + Reading Value.

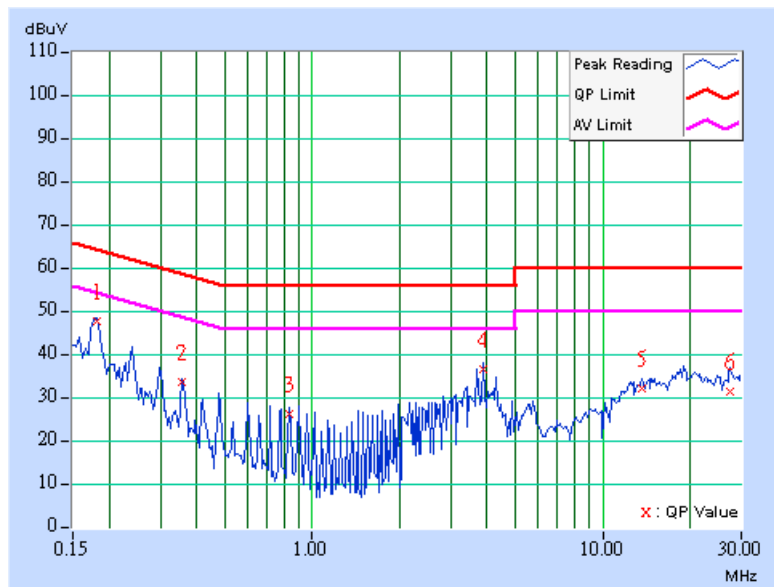



5.2 RADIATED EMISSION MEASUREMENT

5.2.1 LIMITS OF RADIATED EMISSION MEASUREMENT

Emissions radiated outside of the specified bands, shall be according to the general radiated limits in 15.209 as following:

Frequencies (MHz)	Field strength (microvolts/meter)	Measurement distance (meters)
0.009-0.490	2400/F(kHz)	300
0.490-1.705	24000/F(kHz)	30
1.705-30.0	30	30
30-88	100	3
88-216	150	3
216-960	200	3
Above 960	500	3

NOTE:

1. The lower limit shall apply at the transition frequencies.
2. Emission level (dBuV/m) = 20 log Emission level (uV/m).
3. As shown in 15.35(b), for frequencies above 1000MHz, the field strength limits are based on average detector, however, the peak field strength of any emission shall not exceed the maximum permitted average limits, specified above by more than 20dB under any condition of modulation.



5.2.2 LIMITS OF UNWANTED EMISSION OUT OF THE RESTRICTED BANDS

Mode 1 and Mode 3

Frequencies (MHz)	EIRP Limit (dBm)	Equivalent Field Strength at 3m (dBµV/m) *note 3
5150~5250	-27	71.3
5250~5350	-27	71.3
5725~5825	-27 *note 1	71.3
	-17 *note 2	81.3

Mode 2

Frequencies (MHz)	EIRP Limit (dBm)	Equivalent Field Strength at 3m (dBµV/m) *note 3
5150~5250	-27	73.3
5250~5350	-27	73.3
5725~5825	-27 *note 1	73.3
	-17 *note 2	83.3

Mode 4

Frequencies (MHz)	EIRP Limit (dBm)	Equivalent Field Strength at 3m (dBµV/m) *note 3
5150~5250	-27	69.8
5250~5350	-27	69.8
5725~5825	-27 *note 1	69.8
	-17 *note 2	79.8

NOTE:

1. For frequencies 10MHz or greater above or below the band edge.
2. All emissions within the frequency range from the band edge to 10MHz above or below the band edge.
3. The following formula is used to convert the equipment isotropic radiated power (eirp) to field strength

$$E = \frac{1000000\sqrt{30P}}{3} \text{ } \mu\text{V/m, where P is the eirp (Watts)}$$



5.2.3 TEST INSTRUMENTS

DESCRIPTION & MANUFACTURER	MODEL NO.	SERIAL NO.	CALIBRATED UNTIL
* HP Spectrum Analyzer	8590L	3544A01176	Jun. 10, 2004
* HP Preamplifier	8447D	2944A08485	May 01, 2004
* HP Preamplifier	8449B	3008A01292	Aug. 13, 2004
ROHDE & SCHWARZ TEST RECEIVER	ESI7	838496/016	Feb. 23, 2004
* ROHDE & SCHWARZ TEST RECEIVER	ESMI	839013/007 839379/002	Feb. 13, 2004
SCHAFFNER Tunable Dipole Antenna	VHBA 9123	459	Jun. 26, 2004
SCHWARZBECK Tunable Dipole Antenna	UHA 9105	977	
* CHASE BILOG Antenna	CBL6112A	2221	July 26, 2004
* SCHWARZBECK Horn Antenna	BBHA9120-D1	D130	Jun. 30, 2004
* EMCO Horn Antenna	3115	9312-4192	Mar. 23, 2004
* EMCO Turn Table	1060	1115	NA
* CHANCE Tower	CM-AT40	CM-A010	NA
* Software	ADT_Radiate d_V5.14	NA	NA
* ANRITSU RF Switches	MP59B	M35046	Jan. 05, 2004
* TIMES RF cable	LMR-600	CABLE-ST5-01	Jan. 05, 2004

NOTE: 1. The calibration interval of the above test instruments is 12 months. And the calibrations are traceable to NML/ROC and NIST/USA.

2. "*" = These equipment are used for the final measurement.
3. The horn antenna and HP preamplifier (model: 8449B) are used only for the measurement of emission frequency above 1GHz if tested.
4. The test was performed in ADT Open Site No. 5.
5. The VCCI Site Registration No. is R-1039.



5.2.4 TEST PROCEDURES

- a. The EUT was placed on the top of a rotating table 0.8 meters above the ground at a 10 meter open area test site. The table was rotated 360 degrees to determine the position of the highest radiation.
- b. The EUT was set 3 meters away from the interference-receiving antenna, which was mounted on the top of a variable-height antenna tower.
- c. The antenna is a broadband antenna, and its height is varied from one meter to four meters above the ground to determine the maximum value of the field strength. Both horizontal and vertical polarizations of the antenna are set to make the measurement.
- d. For each suspected emission, the EUT was arranged to its worst case and then the antenna was tuned to heights from 1 meter to 4 meters and the rotatable table was turned from 0 degrees to 360 degrees to find the maximum reading.
- e. The test-receiver system was set to Peak Detect Function and Specified Bandwidth with Maximum Hold Mode.
- f. If the emission level of the EUT in peak mode was 10dB lower than the limit specified, then testing could be stopped and the peak values of the EUT would be reported. Otherwise the emissions that did not have 10dB margin would be re-tested one by one using peak, quasi-peak or average method as specified and then reported in a data sheet.

NOTE:

1. The resolution bandwidth and video bandwidth of test receiver/spectrum analyzer is 120kHz for Peak detection (PK) and Quasi-peak detection (QP) at frequency below 1GHz.
2. The resolution bandwidth and video bandwidth of test receiver/spectrum analyzer is 1 MHz for Peak detection at frequency above 1GHz.
3. The resolution bandwidth of test receiver/spectrum analyzer is 1 MHz and the video bandwidth is 10 Hz for Average detection (AV) at frequency above 1GHz.

5.2.5 DEVIATION FROM TEST STANDARD

No deviation