



FCC TEST REPORT

REPORT NO.: RF920917R02
MODEL NO.: GL2454RT-QA (Brand: GLOBAL SUN)
OEM MODEL NO.: 6800G (Brand: AT&T)
RECEIVED: Sept. 17, 2003
TESTED: Sept. 29, 2003 ~ Nov. 4, 2003

APPLICANT: GLOBAL SUN TECHNOLOGY INC.

ADDRESS: NO.13 Tung Yuan Rd., Jung Li Industrial Park
Jung Li City, Tao Yuan Hsien , Taiwan

ISSUED BY: Advance Data Technology Corporation

LAB LOCATION: 47 14th Lin, Chiapau Tsun, Linko, Taipei,
Taiwan, R.O.C.

This test report consists of 101 pages in total. It may be duplicated completely for legal use with the approval of the applicant. It should not be reproduced except in full, without the written approval of our laboratory. The client should not use it to claim product endorsement by CNLA, NVLAP or any government agencies. The test results in the report only apply to the tested sample.



0528
ILAC MRA



Lab Code: 200102-0



Table of Contents

1	CERTIFICATION.....	5
2	SUMMARY OF TEST RESULTS.....	6
3	GENERAL INFORMATION	7
3.1	GENERAL DESCRIPTION OF EUT.....	7
3.2	DESCRIPTION OF TEST MODES.....	8
3.3	GENERAL DESCRIPTION OF APPLIED STANDARDS	8
3.4	DESCRIPTION OF SUPPORT UNITS.....	9
3.5	CONFIGURATION OF SYSTEM UNDER TEST	10
4	TEST TYPES AND RESULTS.....	11
4.1	CONDUCTED EMISSION MEASUREMENT	11
4.1.1	LIMITS OF CONDUCTED EMISSION MEASUREMENT.....	11
4.1.2	TEST INSTRUMENTS	11
4.1.3	TEST PROCEDURES.....	12
4.1.4	DEVIATION FROM TEST STANDARD	12
4.1.5	TEST SETUP	13
4.1.6	EUT OPERATING CONDITIONS.....	14
4.1.7	TEST RESULTS (A).....	15
4.1.8	TEST RESULTS (B).....	21
4.2	RADIATED EMISSION MEASUREMENT	27
4.2.1	LIMITS OF RADIATED EMISSION MEASUREMENT.....	27
4.2.2	TEST INSTRUMENTS	28
4.2.3	TEST PROCEDURES.....	29
4.2.4	DEVIATION FROM TEST STANDARD	29
4.2.5	TEST SETUP	30
4.2.6	EUT OPERATING CONDITIONS.....	30
4.2.7	TEST RESULTS (A).....	31
4.2.8	TEST RESULTS (B).....	38
4.3	6dB BANDWIDTH MEASUREMENT	45
4.3.1	LIMITS OF 6dB BANDWIDTH MEASUREMENT.....	45
4.3.2	TEST INSTRUMENTS	45
4.3.3	TEST PROCEDURE	45



4.3.4	DEVIATION FROM TEST STANDARD	45
4.3.5	TEST SETUP	46
4.3.6	EUT OPERATING CONDITIONS.....	46
4.3.7	TEST RESULTS (A)	47
4.3.8	TEST RESULTS (B).....	55
4.4	MAXIMUM PEAK OUTPUT POWER	63
4.4.1	LIMITS OF MAXIMUM PEAK OUTPUT POWER MEASUREMENT	63
4.4.2	TEST INSTRUMENTS	63
4.4.3	TEST PROCEDURES.....	64
4.4.4	DEVIATION FROM TEST STANDARD	64
4.4.5	TEST SETUP	64
4.4.6	EUT OPERATING CONDITIONS.....	64
4.4.7	TEST RESULTS (A).....	65
4.4.7	TEST RESULTS (8)	66
4.5	POWER SPECTRAL DENSITY MEASUREMENT	67
4.5.1	LIMITS OF POWER SPECTRAL DENSITY MEASUREMENT	67
4.5.2	TEST INSTRUMENTS	67
4.5.3	TEST PROCEDURE	68
4.5.4	DEVIATION FROM TEST STANDARD	68
4.5.5	TEST SETUP	68
4.5.6	EUT OPERATING CONDITIONS.....	68
4.5.7	TEST RESULTS (A).....	69
4.5.8	TEST RESULTS (B).....	77
4.6	BAND EDGES MEASUREMENT	85
4.6.1	LIMITS OF BAND EDGES MEASUREMENT	85
4.6.2	TEST INSTRUMENTS	85
4.6.3	TEST PROCEDURE (A)	85
4.6.4	TEST PROCEDURE (B)	85
4.6.5	DEVIATION FROM TEST STANDARD	85
4.6.6	EUT OPERATING CONDITION	86
4.6.7	TEST RESULTS (A).....	86



4.6.8	TEST RESULTS (B)	91
4.7	ANTENNA REQUIREMENT	96
4.7.1	STANDARD APPLICABLE	96
4.7.2	ANTENNA CONNECTED CONSTRUCTION	96
5	PHOTOGRAPHS OF THE TEST CONFIGURATION	97
6	INFORMATION ON THE TESTING LABORATORIES	101



1 CERTIFICATION

PRODUCT NAME : 2.4GHz 54Mbps Wireless Router
MODEL NO.: GL2454RT-QA
BRAND NAME : GLOBAL SUN
OEM PRODUCT NAME : AT&T Plug&Share 54Mbps Wireless Router
OEM MODEL NO.: 6800G
OEM BRAND NAME : AT&T
APPLICANT : GLOBAL SUN TECHNOLOGY INC.
TEST ITEM : ENGINEERING SAMPLE
STANDARDS : 47 CFR Part 15, Subpart C (Section 15.247),
ANSI C63.4-1992

We, **Advance Data Technology Corporation**, hereby certify that two samples of the designation have been tested in our facility from Sept. 29, 2003 to Nov. 4, 2003. The test record, data evaluation and Equipment Under Test (EUT) configurations represented herein are true and accurate accounts of the measurements of the sample's EMC characteristics under the conditions herein specified.

PREPARED BY: *Emely Lu* , **DATE:** December 04, 2003
Emely Lu

APPROVED BY: *Ellis Wu* , **DATE:** December 04, 2003
Ellis Wu / Manager



2 SUMMARY OF TEST RESULTS

The EUT has been tested according to the following specifications:

APPLIED STANDARD: 47 CFR Part 15, Subpart C			
Standard Section	Test Type and Limit	Result	REMARK
15.207	AC Power Conducted Emission	PASS	Meet the requirement of limit Minimum passing margin is -14.16dB at 2.516MHz
15.247(a)(2)	Spectrum Bandwidth of a Direct Sequence Spread Spectrum System. Limit: min. 500kHz	PASS	Meet the requirement of limit
15.247(b)	Maximum Peak Output Power Limit: max. 30dBm	PASS	Meet the requirement of limit
15.247(c)	Transmitter Radiated Emissions Limit: Table 15.209	PASS	Meet the requirement of limit Minimum passing margin is -2.50dB at 2390.00MHz
15.247(d)	Power Spectral Density Limit: max. 8dBm	PASS	Meet the requirement of limit
15.247(c)	Band Edge Measurement Limit: 20dB less than the peak value of fundamental frequency	PASS	Meet the requirement of limit



3 GENERAL INFORMATION

3.1 GENERAL DESCRIPTION OF EUT

PRODUCT NAME	2.4GHz 54Mbps Wireless Router
MODEL NO.	GL2454RT-QA
OEM PRODUCT NAME	AT&T Plug&Share 54Mbps Wireless Router
OEM MODEL NO.	6800G
POWER SUPPLY	5VDC from power adapter
MODULATION TYPE	BPSK, QPSK, CCK, 16QAM, 64QAM
RADIO TECHNOLOGY	DSSS, OFDM
TRANSFER RATE	1/2/5.5/6/9/11/12/18/24/36/48/54Mbps
FREQUENCY RANGE	2412MHz ~ 2462MHz
NUMBER OF CHANNEL	11
OUTPUT POWER	17.62dBm
ANTENNA TYPE	Dipole antenna with 2.0dBi gain
DATA CABLE	NA
I/O PORTS	RJ45
ASSOCIATED DEVICES	NA

NOTE:

- Two samples were provided to this test and tested with the following adapters:

FOR MODEL GL2454RT-QA	
BRAND :	FAIRWAY
MODEL :	WN10A-050U
INPUT :	100-240V--1.0A MAX 50-60Hz
OUTPUT :	+5.0V--0.5A

FOR MODEL 6800G	
MODEL :	JTA0302B
INPUT :	100-120V 0.5A 50-60Hz
OUTPUT :	+5.0V--2.5A

- Two models are identical except for their outer appearances, model number and brand name.
- The EUT operates in the 2.4GHz frequency spectrum and compatible with the draft 802.11g standard to provide a wireless data rate of up to 54Mbps.
- For more detailed features description, please refer to the manufacturer's specifications or User's Manual.



3.2 DESCRIPTION OF TEST MODES

Eleven channels are provided to this EUT.

Channel	Frequency	Channel	Frequency
1	2412 MHz	7	2442 MHz
2	2417 MHz	8	2447 MHz
3	2422 MHz	9	2452 MHz
4	2427 MHz	10	2457 MHz
5	2432 MHz	11	2462 MHz
6	2437 MHz		

NOTE:

1. Below 1GHz, the channel 1, 6, and 11 were pre-tested in chamber. The channel 11, the worst case, was chosen for final test.
2. Above 1GHz, the channel 1, 6, and 11 were tested individually.
3. For radiated emission measurement, transfer rate at 11Mbps with CCK technique and 6Mbps with OFDM technique, worst cases, were chosen for final test.
4. Two test results were presented in the following sections, test result (A) is for model GL2454RT-QA and test result (B) is for model 6800G

3.3 GENERAL DESCRIPTION OF APPLIED STANDARDS

The EUT is the specifications of the manufacturer, it must comply with the requirements of the following standards:

FCC 47 CFR Part 15, Subpart C. (15.247)

ANSI C63.4: 1992

All test items have been performed and recorded as per the above standards.

NOTE: The EUT is also considered as a kind of computer peripheral, because the connection to computer is necessary for typical use. It has been verified to comply with the requirements of FCC Part 15, Subpart B, Class B (DoC). The test report has been issued separately.



3.4 DESCRIPTION OF SUPPORT UNITS

The EUT has been tested as an independent unit together with other necessary accessories or support units. The following support units or accessories were used to form a representative test configuration during the tests.

NO.	PRODUCT	BRAND	MODEL NO.	SERIAL NO.	FCC ID
1	PERSONAL COMPUTER	HP	DTPC 27	SG21103587	FCC DoC
2	MONITOR	HP	D2842A	KR93473113	BEJCB910
3	PS/2 KEYBOARD	BTC	5200T	F24800238	E5XKB5122WTH0110
4	PS/2 MOUSE	BTC	M851	N/A	E5XMSM860
5	PRINTER	EPSON	LQ-300+	DCGY017070	FCC DoC
6	MODEM	ACEEX	1414	980020525	IFAXDM1414
7	Notebook	Dell	PP01L	TW-09C748-12800-16M-5064	FCC DoC
8	USB 10/100 Fast Ethernet	D-Link	DU-E100	UR15001597	FCC DoC

NO.	SIGNAL CABLE DESCRIPTION OF THE ABOVE SUPPORT UNITS
1	NA
2	1.8 m braid shielded wire, terminated with VGA connector via metallic frame, w/o core.
3	1.6 m foil shielded wire, terminated with PS/2 connector via metallic frame, w/o core.
4	1.5 m Non shielded wire, terminated with PS/2 connector via drain wire, w/o core.
5	1.2m braid shielded wire, terminated with DB25 and Centronics connector via metallic frame, w/o core
6	1.2 m braid shielded wire, terminated with DB25 and DB9 connector via metallic frame, w/o core.
7	NA
8	NA

NOTE: All power cords of the above support units are non shielded (1.8m).



3.5 CONFIGURATION OF SYSTEM UNDER TEST

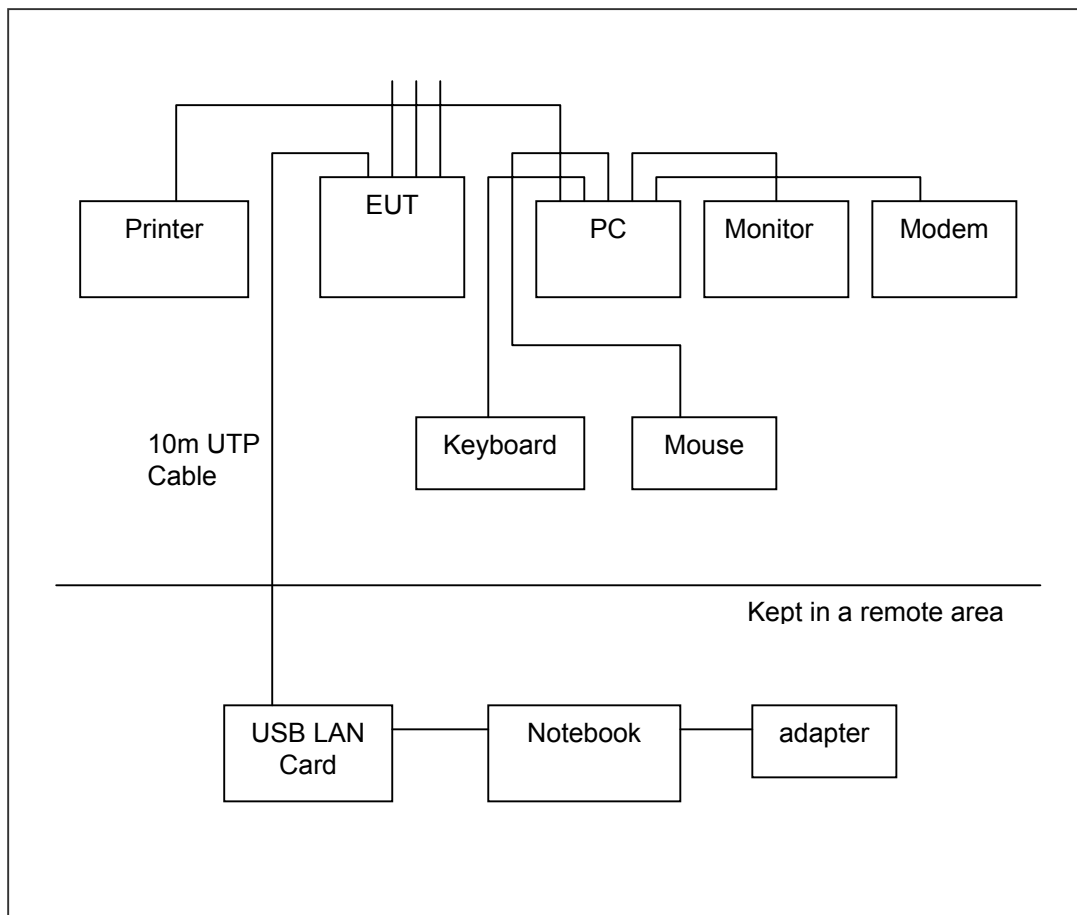



4 TEST TYPES AND RESULTS

4.1 CONDUCTED EMISSION MEASUREMENT

4.1.1 LIMITS OF CONDUCTED EMISSION MEASUREMENT

FREQUENCY OF EMISSION (MHz)	CONDUCTED LIMIT (dB μ V)	
	Quasi-peak	Average
0.15-0.5	66 to 56	56 to 46
0.5-5	56	46
5-30	60	50

- NOTE:**
1. The lower limit shall apply at the transition frequencies.
 2. The limit decreases in line with the logarithm of the frequency in the range of 0.15 to 0.50 MHz.
 3. All emanations from a class A/B digital device or system, including any network of conductors and apparatus connected thereto, shall not exceed the level of field strengths specified above.

4.1.2 TEST INSTRUMENTS

DESCRIPTION & MANUFACTURER	MODEL NO.	SERIAL NO.	CALIBRATED UNTIL
ROHDE & SCHWARZ Test Receiver	ESCS 30	838251/021	Jan. 20, 2004
ROHDE & SCHWARZ Artificial Mains Network (for EUT)	ESH3-Z5	100218	Dec. 18, 2003
ROHDE & SCHWARZ Artificial Mains Network (for peripherals)	ESH3-Z5	100219	Dec. 18, 2003
ROHDE & SCHWARZ Artificial Mains Network (for peripherals)	ESH3-Z5	100220	Dec. 18, 2003
*ROHDE & SCHWARZ 4-wire ISN	ENY41	837032/016	Nov. 19 2004
*ROHDE & SCHWARZ 2-wire ISN	ENY22	837497/016	Nov. 19 2004
Software	Cond-V2M3	NA	NA
RF cable (JYBAO)	5D-FB	Cable-C10.01	May 01, 2004
SUHNER Terminator (For ROHDE & SCHWARZ LISN)	65BNC-5001	E1-010770	Mar. 24, 2004
SUHNER Terminator (For ROHDE & SCHWARZ LISN)	65BNC-5001	E1-010773	Apr. 06, 2004

- NOTE:**
1. The calibration interval of the above test instruments is 12 months and the calibrations are traceable to NML/ROC and NIST/USA.
 2. “*”: These equipment are used for conducted telecom port test only (if tested).
 3. The test was performed in ADT Shielded Room No. 10.
 4. The VCCI Site Registration No. is C-1312.



4.1.3 TEST PROCEDURES

- a. The EUT was placed 0.4 meters from the conducting wall of the shielded room with EUT being connected to the power mains through a line impedance stabilization network (LISN). Other support units were connected to the power mains through another LISN. The two LISNs provide 50 ohm/ 50uH of coupling impedance for the measuring instrument.
- b. Both lines of the power mains connected to the EUT were checked for maximum conducted interference.
- c. The frequency range from 150kHz to 30MHz was searched. Emission levels over 10dB under the prescribed limits could not be reported

4.1.4 DEVIATION FROM TEST STANDARD

No deviation

4.1.5 TEST SETUP

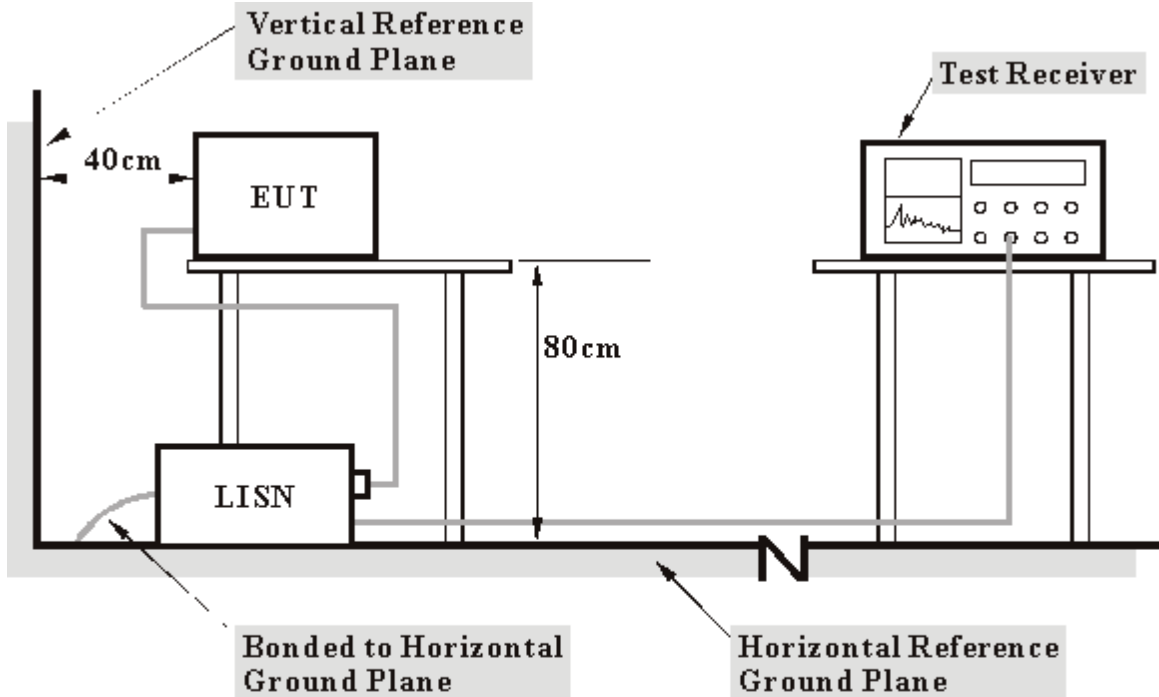

- Note:**
1. Support units were connected to second LISN.
 2. Both of LISNs (AMN) 80 cm from EUT and at the least 80 cm from other units and other metal planes support units.

For the actual test configuration, please refer to the related item – Photographs of the Test Configuration.



4.1.6 EUT OPERATING CONDITIONS

- a. Placed the EUT on the testing table.
- b. The computer system sent data to EUT by command "PIN" via RJ45 cable.
- c. The computer system sent "H" messages to Color Monitor and Monitor displayed "H" patterns on its screen.
- d. The computer system sent "H" messages to modem.
- e. The computer system sent "H" messages to the printer, and the printer prints them on paper.
- f. Prepared another computer system to act as a communication partner and placed it outside of testing area.
- g. The communication partner ran a test program to enable EUT under transmission/receiving condition continuously at specific channel frequency via RJ45 cable.
- h. The communication partner sent data to EUT by command "PING".



4.1.7 TEST RESULTS (A)

EUT	2.4GHz 54Mbps Wireless Router	MODEL	GL2454RT-QA
CHANNEL	Channel 1	6dB BANDWIDTH	9kHz
INPUT POWER (SYSTEM)	120Vac, 60 Hz	PHASE	Line (L)
ENVIRONMENTAL CONDITIONS	25deg.C, 65%RH, 991hPa	TESTED BY: Jamison Chan	

No	Freq. [MHz]	Corr. Factor (dB)	Reading Value [dB (uV)]		Emission Level [dB (uV)]		Limit [dB (uV)]		Margin (dB)	
			Q.P.	AV.	Q.P.	AV.	Q.P.	AV.	Q.P.	AV.
			1	0.154	0.06	46.46	-	46.52	-	65.79
2	0.310	0.06	33.49	-	33.55	-	59.97	49.97	-26.42	-
3	0.912	0.15	23.25	-	23.40	-	56.00	46.00	-32.60	-
4	1.547	0.17	27.78	-	27.95	-	56.00	46.00	-28.05	-
5	19.027	0.62	19.63	-	20.25	-	60.00	50.00	-39.75	-
6	26.352	0.89	20.08	-	20.97	-	60.00	50.00	-39.03	-

- REMARKS:**
1. Q.P. and AV. are abbreviations of quasi-peak and average individually.
 2. "-": The Quasi-peak reading value also meets average limit and measurement with the average detector is unnecessary.
 3. The emission levels of other frequencies were very low against the limit.
 4. Margin value = Emission level - Limit value
 5. Correction factor = Insertion loss + Cable loss
 6. Emission Level = Correction Factor + Reading Value.

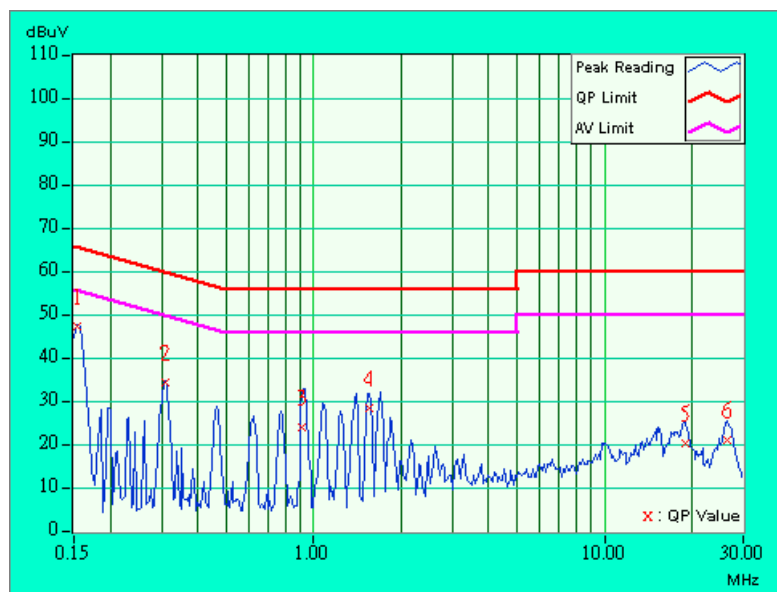



EUT	2.4GHz 54Mbps Wireless Router	MODEL	GL2454RT-QA
CHANNEL	Channel 1	6dB BANDWIDTH	9kHz
INPUT POWER (SYSTEM)	120Vac, 60 Hz	PHASE	Neutral (N)
ENVIRONMENTAL CONDITIONS	25deg.C, 65%RH, 991hPa	TESTED BY: Jamison Chan	

No	Freq. [MHz]	Corr. Factor (dB)	Reading Value		Emission Level		Limit		Margin	
			[dB (uV)]		[dB (uV)]		[dB (uV)]		(dB)	
			Q.P.	AV.	Q.P.	AV.	Q.P.	AV.	Q.P.	AV.
1	0.158	0.05	47.23	-	47.28	-	65.58	55.58	-18.30	-
2	0.306	0.05	30.74	-	30.79	-	60.07	50.07	-29.28	-
3	0.927	0.15	30.55	-	30.70	-	56.00	46.00	-25.30	-
4	1.535	0.17	26.87	-	27.04	-	56.00	46.00	-28.96	-
5	19.027	0.51	19.00	-	19.51	-	60.00	50.00	-40.49	-
6	26.172	0.73	20.09	-	20.82	-	60.00	50.00	-39.18	-

- REMARKS:**
1. Q.P. and AV. are abbreviations of quasi-peak and average individually.
 2. "-": The Quasi-peak reading value also meets average limit and measurement with the average detector is unnecessary.
 3. The emission levels of other frequencies were very low against the limit.
 4. Margin value = Emission level - Limit value
 5. Correction factor = Insertion loss + Cable loss
 6. Emission Level = Correction Factor + Reading Value.

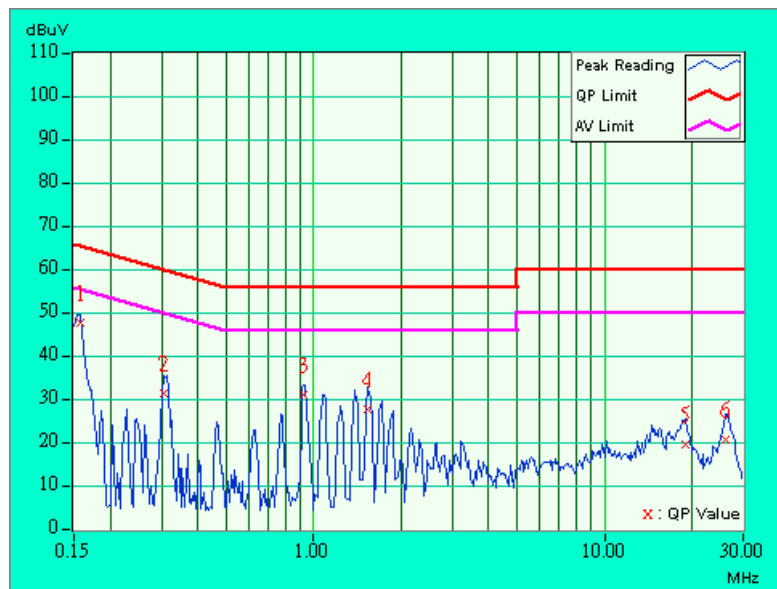



EUT	2.4GHz 54Mbps Wireless Router	MODEL	GL2454RT-QA
CHANNEL	Channel 6	6dB BANDWIDTH	9kHz
INPUT POWER (SYSTEM)	120Vac, 60 Hz	PHASE	Line (L)
ENVIRONMENTAL CONDITIONS	25deg.C, 65%RH, 991hPa	TESTED BY: Jamison Chan	

No	Freq. [MHz]	Corr. Factor (dB)	Reading Value [dB (uV)]		Emission Level [dB (uV)]		Limit [dB (uV)]		Margin (dB)	
			Q.P.	AV.	Q.P.	AV.	Q.P.	AV.	Q.P.	AV.
			1	0.154	0.06	46.48	-	46.54	-	65.79
2	0.310	0.06	33.53	-	33.59	-	59.97	49.97	-26.38	-
3	0.923	0.15	29.30	-	29.45	-	56.00	46.00	-26.55	-
4	1.711	0.17	27.85	-	28.02	-	56.00	46.00	-27.98	-
5	18.848	0.62	19.89	-	20.51	-	60.00	50.00	-39.49	-
6	26.414	0.89	21.09	-	21.98	-	60.00	50.00	-38.02	-

- REMARKS:**
1. Q.P. and AV. are abbreviations of quasi-peak and average individually.
 2. "-": The Quasi-peak reading value also meets average limit and measurement with the average detector is unnecessary.
 3. The emission levels of other frequencies were very low against the limit.
 4. Margin value = Emission level - Limit value
 5. Correction factor = Insertion loss + Cable loss
 6. Emission Level = Correction Factor + Reading Value.

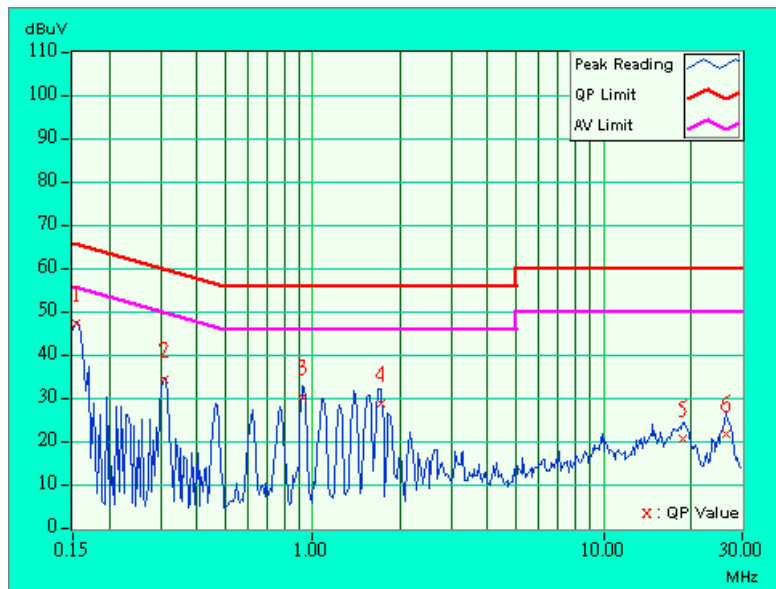



EUT	2.4GHz 54Mbps Wireless Router	MODEL	GL2454RT-QA
CHANNEL	Channel 6	6dB BANDWIDTH	9kHz
INPUT POWER (SYSTEM)	120Vac, 60 Hz	PHASE	Neutral (N)
ENVIRONMENTAL CONDITIONS	25deg.C, 65%RH, 991hPa	TESTED BY: Jamison Chan	

No	Freq. [MHz]	Corr. Factor (dB)	Reading Value [dB (uV)]		Emission Level [dB (uV)]		Limit [dB (uV)]		Margin (dB)	
			Q.P.	AV.	Q.P.	AV.	Q.P.	AV.	Q.P.	AV.
	1	0.154	0.05	48.54	-	48.59	-	65.79	55.79	-17.20
2	0.314	0.05	32.56	-	32.61	-	59.86	49.86	-27.25	-
3	0.927	0.15	30.80	-	30.95	-	56.00	46.00	-25.05	-
4	1.531	0.17	27.36	-	27.53	-	56.00	46.00	-28.47	-
5	18.668	0.50	19.57	-	20.07	-	60.00	50.00	-39.93	-
6	26.293	0.72	20.64	-	21.36	-	60.00	50.00	-38.64	-

- REMARKS:**
1. Q.P. and AV. are abbreviations of quasi-peak and average individually.
 2. "-": The Quasi-peak reading value also meets average limit and measurement with the average detector is unnecessary.
 3. The emission levels of other frequencies were very low against the limit.
 4. Margin value = Emission level - Limit value
 5. Correction factor = Insertion loss + Cable loss
 6. Emission Level = Correction Factor + Reading Value.

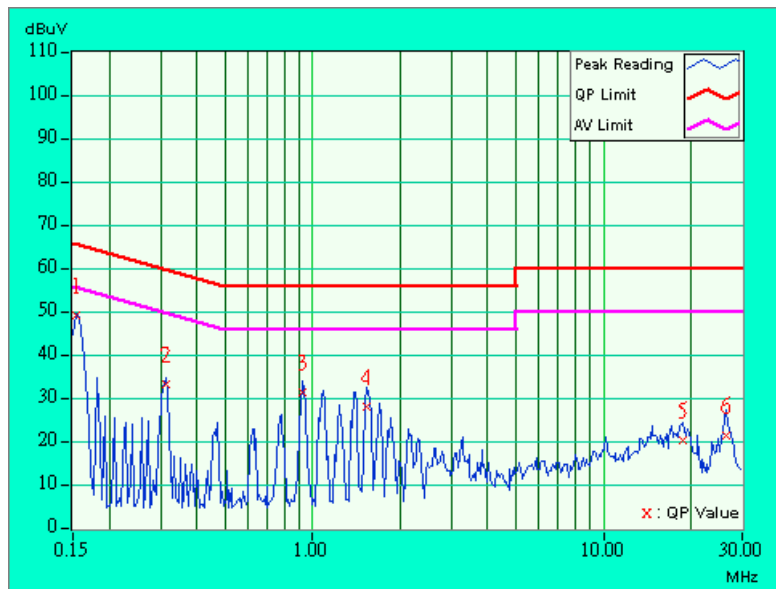



EUT	2.4GHz 54Mbps Wireless Router	MODEL	GL2454RT-QA
CHANNEL	Channel 11	6dB BANDWIDTH	9kHz
INPUT POWER (SYSTEM)	120Vac, 60 Hz	PHASE	Line (L)
ENVIRONMENTAL CONDITIONS	25deg.C, 65%RH, 991hPa	TESTED BY: Jamison Chan	

No	Freq. [MHz]	Corr. Factor (dB)	Reading Value [dB (uV)]		Emission Level [dB (uV)]		Limit [dB (uV)]		Margin (dB)	
			Q.P.	AV.	Q.P.	AV.	Q.P.	AV.	Q.P.	AV.
	1	0.154	0.06	46.54	-	46.60	-	65.79	55.79	-19.19
2	0.310	0.06	33.61	-	33.67	-	59.97	49.97	-26.30	-
3	0.927	0.15	30.30	-	30.45	-	56.00	46.00	-25.55	-
4	1.691	0.17	27.71	-	27.88	-	56.00	46.00	-28.12	-
5	19.031	0.62	19.73	-	20.35	-	60.00	50.00	-39.65	-
6	26.113	0.89	21.57	-	22.46	-	60.00	50.00	-37.54	-

- REMARKS:**
1. Q.P. and AV. are abbreviations of quasi-peak and average individually.
 2. "-": The Quasi-peak reading value also meets average limit and measurement with the average detector is unnecessary.
 3. The emission levels of other frequencies were very low against the limit.
 4. Margin value = Emission level - Limit value
 5. Correction factor = Insertion loss + Cable loss
 6. Emission Level = Correction Factor + Reading Value.

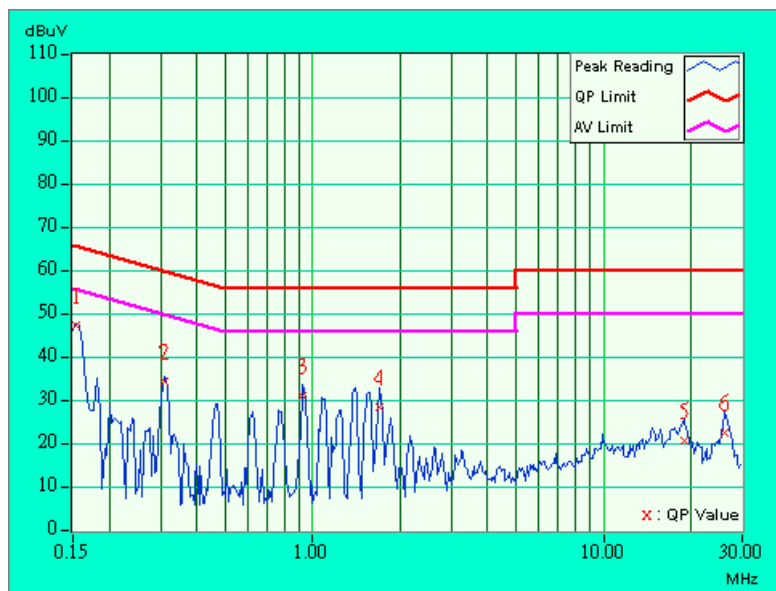



EUT	2.4GHz 54Mbps Wireless Router	MODEL	GL2454RT-QA
CHANNEL	Channel 11	6dB BANDWIDTH	9kHz
INPUT POWER (SYSTEM)	120Vac, 60 Hz	PHASE	Neutral (N)
ENVIRONMENTAL CONDITIONS	25deg.C, 65%RH, 991hPa	TESTED BY: Jamison Chan	

No	Freq. [MHz]	Corr. Factor (dB)	Reading Value [dB (uV)]		Emission Level [dB (uV)]		Limit [dB (uV)]		Margin (dB)	
			Q.P.	AV.	Q.P.	AV.	Q.P.	AV.	Q.P.	AV.
	1	0.154	0.05	48.40	-	48.45	-	65.79	55.79	-17.34
2	0.310	0.05	33.79	-	33.84	-	59.97	49.97	-26.13	-
3	0.931	0.15	30.53	-	30.68	-	56.00	46.00	-25.32	-
4	1.555	0.17	28.29	-	28.46	-	56.00	46.00	-27.54	-
5	19.031	0.51	19.89	-	20.40	-	60.00	50.00	-39.60	-
6	26.777	0.72	19.25	-	19.97	-	60.00	50.00	-40.03	-

- REMARKS:**
1. Q.P. and AV. are abbreviations of quasi-peak and average individually.
 2. "-": The Quasi-peak reading value also meets average limit and measurement with the average detector is unnecessary.
 3. The emission levels of other frequencies were very low against the limit.
 4. Margin value = Emission level - Limit value
 5. Correction factor = Insertion loss + Cable loss
 6. Emission Level = Correction Factor + Reading Value.

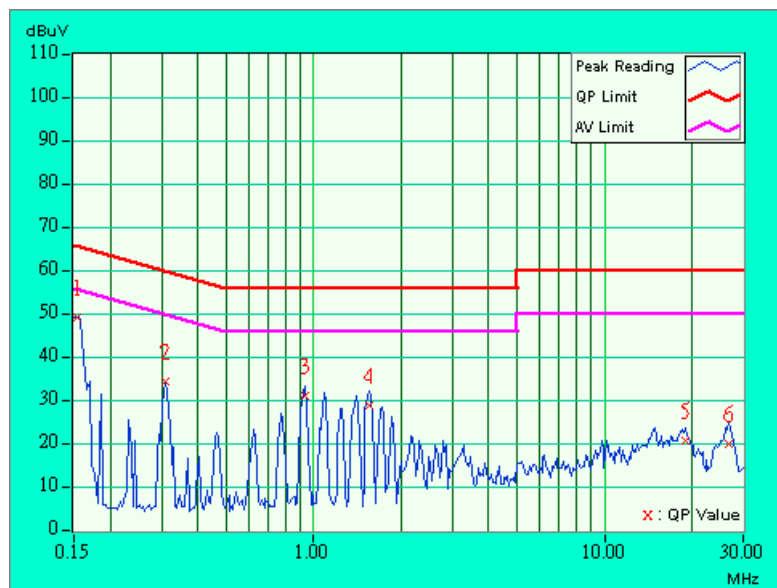



4.1.8 TEST RESULTS (B)

EUT	AT&T Plug&Share 54Mbps Wireless Router	MODEL	6800G
CHANNEL	Channel 1	6dB BANDWIDTH	9kHz
INPUT POWER (SYSTEM)	120Vac, 60 Hz	PHASE	Line (L)
ENVIRONMENTAL CONDITIONS	22deg.C, 65%RH, 991hPa	TESTED BY: Allen Chang	

No	Freq. [MHz]	Corr. Factor (dB)	Reading Value		Emission Level		Limit		Margin	
			[dB (uV)]		[dB (uV)]		[dB (uV)]		(dB)	
			Q.P.	AV.	Q.P.	AV.	Q.P.	AV.	Q.P.	AV.
1	0.201	0.06	41.99	-	42.05	-	63.58	53.58	-21.53	-
2	0.267	0.06	31.37	-	31.43	-	61.20	51.20	-29.77	-
3	0.334	0.06	26.49	-	26.55	-	59.36	49.36	-32.81	-
4	1.734	0.17	5.35	-	5.52	-	56.00	46.00	-50.48	-
5	2.070	0.18	6.42	-	6.60	-	56.00	46.00	-49.40	-
6	2.738	0.19	16.97	-	17.16	-	56.00	46.00	-38.84	-

- REMARKS:**
1. Q.P. and AV. are abbreviations of quasi-peak and average individually.
 2. "-": The Quasi-peak reading value also meets average limit and measurement with the average detector is unnecessary.
 3. The emission levels of other frequencies were very low against the limit.
 4. Margin value = Emission level - Limit value
 5. Correction factor = Insertion loss + Cable loss
 6. Emission Level = Correction Factor + Reading Value.

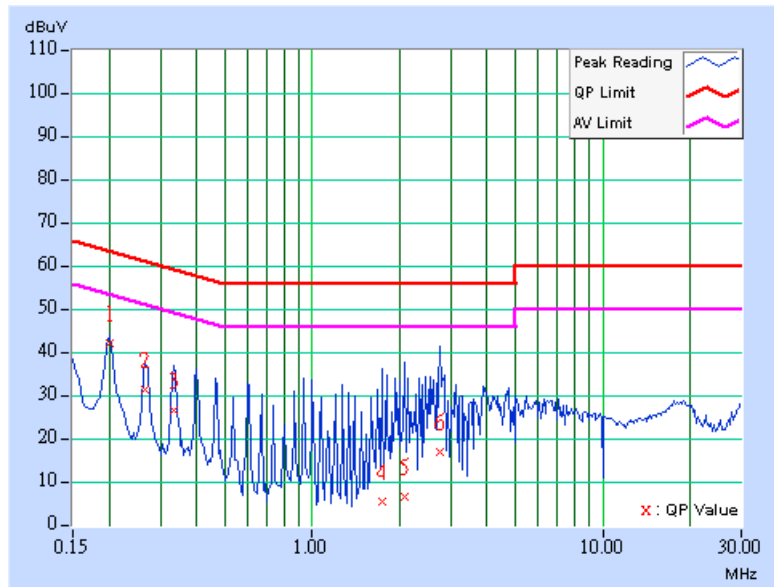



EUT	AT&T Plug&Share 54Mbps Wireless Router	MODEL	6800G
CHANNEL	Channel 1	6dB BANDWIDTH	9kHz
INPUT POWER (SYSTEM)	120Vac, 60 Hz	PHASE	Neutral (N)
ENVIRONMENTAL CONDITIONS	22deg.C, 65%RH, 991hPa	TESTED BY: Allen Chang	

No	Freq. [MHz]	Corr. Factor (dB)	Reading Value [dB (uV)]		Emission Level [dB (uV)]		Limit [dB (uV)]		Margin (dB)	
			Q.P.	AV.	Q.P.	AV.	Q.P.	AV.	Q.P.	AV.
	1	0.205	0.05	38.90	-	38.95	-	63.42	53.42	-24.47
2	0.271	0.05	36.11	-	36.16	-	61.08	51.08	-24.92	-
3	0.408	0.05	35.92	-	35.97	-	57.69	47.69	-21.72	-
4	1.629	0.17	34.14	-	34.31	-	56.00	46.00	-21.69	-
5	1.699	0.17	36.85	-	37.02	-	56.00	46.00	-18.98	-
6	2.578	0.19	35.16	-	35.35	-	56.00	46.00	-20.65	-

- REMARKS:**
1. Q.P. and AV. are abbreviations of quasi-peak and average individually.
 2. "-": The Quasi-peak reading value also meets average limit and measurement with the average detector is unnecessary.
 3. The emission levels of other frequencies were very low against the limit.
 4. Margin value = Emission level - Limit value
 5. Correction factor = Insertion loss + Cable loss
 6. Emission Level = Correction Factor + Reading Value.

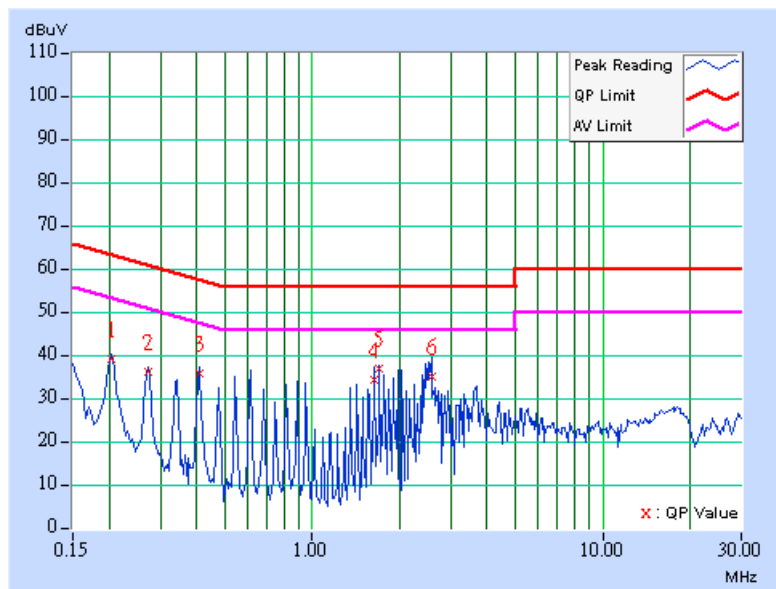



EUT	AT&T Plug&Share 54Mbps Wireless Router	MODEL	6800G
CHANNEL	Channel 6	6dB BANDWIDTH	9kHz
INPUT POWER (SYSTEM)	120Vac, 60 Hz	PHASE	Line (L)
ENVIRONMENTAL CONDITIONS	22deg.C, 65%RH, 991hPa	TESTED BY: Allen Chang	

No	Freq. [MHz]	Corr. Factor (dB)	Reading Value		Emission Level		Limit		Margin	
			[dB (uV)]		[dB (uV)]		[dB (uV)]		(dB)	
			Q.P.	AV.	Q.P.	AV.	Q.P.	AV.	Q.P.	AV.
1	0.205	0.06	40.72	-	40.78	-	63.42	53.42	-22.64	-
2	0.271	0.06	36.05	-	36.11	-	61.08	51.08	-24.97	-
3	0.338	0.06	34.87	-	34.93	-	59.26	49.26	-24.33	-
4	0.408	0.06	34.32	-	34.38	-	57.69	47.69	-23.31	-
5	2.582	0.19	38.27	-	38.46	-	56.00	46.00	-17.54	-
6	2.852	0.20	35.32	-	35.52	-	56.00	46.00	-20.48	-

- REMARKS:**
1. Q.P. and AV. are abbreviations of quasi-peak and average individually.
 2. "-": The Quasi-peak reading value also meets average limit and measurement with the average detector is unnecessary.
 3. The emission levels of other frequencies were very low against the limit.
 4. Margin value = Emission level - Limit value
 5. Correction factor = Insertion loss + Cable loss
 6. Emission Level = Correction Factor + Reading Value.

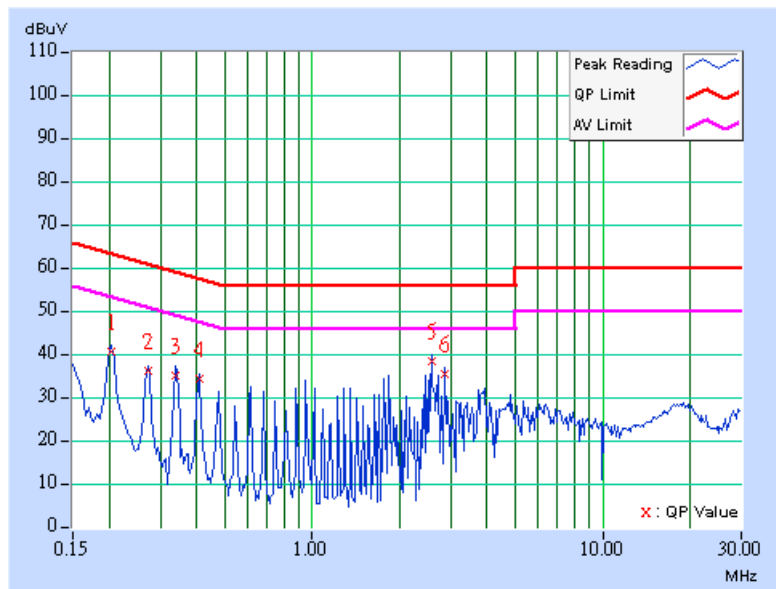



EUT	AT&T Plug&Share 54Mbps Wireless Router	MODEL	6800G
CHANNEL	Channel 6	6dB BANDWIDTH	9kHz
INPUT POWER (SYSTEM)	120Vac, 60 Hz	PHASE	Neutral (N)
ENVIRONMENTAL CONDITIONS	22deg.C, 65%RH, 991hPa	TESTED BY: Allen Chang	

No	Freq. [MHz]	Corr. Factor (dB)	Reading Value		Emission Level		Limit		Margin	
			[dB (uV)]		[dB (uV)]		[dB (uV)]		(dB)	
			Q.P.	AV.	Q.P.	AV.	Q.P.	AV.	Q.P.	AV.
1	0.205	0.05	39.26	-	39.31	-	63.42	53.42	-24.11	-
2	0.271	0.05	36.16	-	36.21	-	61.08	51.08	-24.87	-
3	0.404	0.05	33.41	-	33.46	-	57.77	47.77	-24.31	-
4	1.898	0.18	32.04	-	32.22	-	56.00	46.00	-23.78	-
5	1.969	0.18	35.14	-	35.32	-	56.00	46.00	-20.68	-
6	2.508	0.19	39.81	-	40.00	-	56.00	46.00	-16.00	-

- REMARKS:**
1. Q.P. and AV. are abbreviations of quasi-peak and average individually.
 2. "-": The Quasi-peak reading value also meets average limit and measurement with the average detector is unnecessary.
 3. The emission levels of other frequencies were very low against the limit.
 4. Margin value = Emission level - Limit value
 5. Correction factor = Insertion loss + Cable loss
 6. Emission Level = Correction Factor + Reading Value.

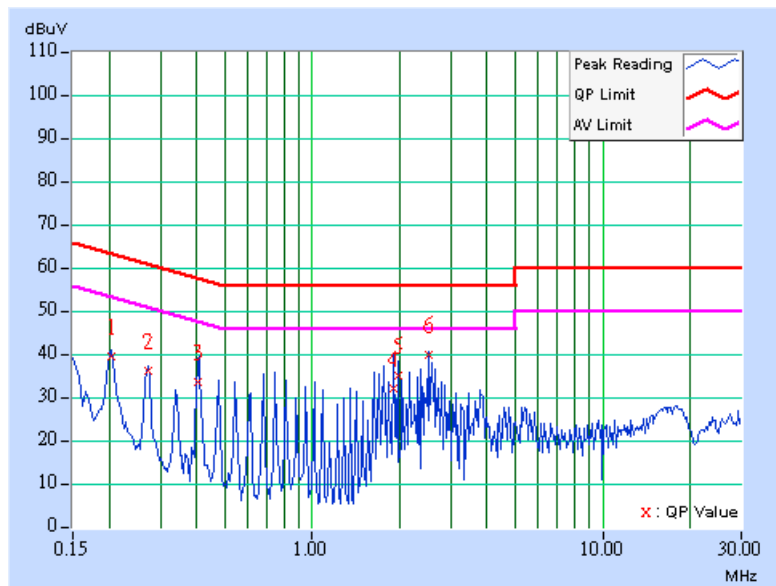



EUT	AT&T Plug&Share 54Mbps Wireless Router	MODEL	6800G
CHANNEL	Channel 11	6dB BANDWIDTH	9kHz
INPUT POWER (SYSTEM)	120Vac, 60 Hz	PHASE	Line (L)
ENVIRONMENTAL CONDITIONS	22deg.C, 65%RH, 991hPa	TESTED BY: Allen Chang	

No	Freq. [MHz]	Corr. Factor (dB)	Reading Value [dB (uV)]		Emission Level [dB (uV)]		Limit [dB (uV)]		Margin (dB)	
			Q.P.	AV.	Q.P.	AV.	Q.P.	AV.	Q.P.	AV.
	1	0.205	0.06	38.85	-	38.91	-	63.42	53.42	-24.51
2	0.338	0.06	31.98	-	32.04	-	59.26	49.26	-27.22	-
3	0.408	0.06	36.00	-	36.06	-	57.69	47.69	-21.63	-
4	0.611	0.10	34.76	-	34.86	-	56.00	46.00	-21.14	-
5	2.516	0.19	41.65	-	41.84	-	56.00	46.00	-14.16	-
6	2.789	0.20	35.30	-	35.50	-	56.00	46.00	-20.50	-

- REMARKS:**
1. Q.P. and AV. are abbreviations of quasi-peak and average individually.
 2. "-": The Quasi-peak reading value also meets average limit and measurement with the average detector is unnecessary.
 3. The emission levels of other frequencies were very low against the limit.
 4. Margin value = Emission level - Limit value
 5. Correction factor = Insertion loss + Cable loss
 6. Emission Level = Correction Factor + Reading Value.

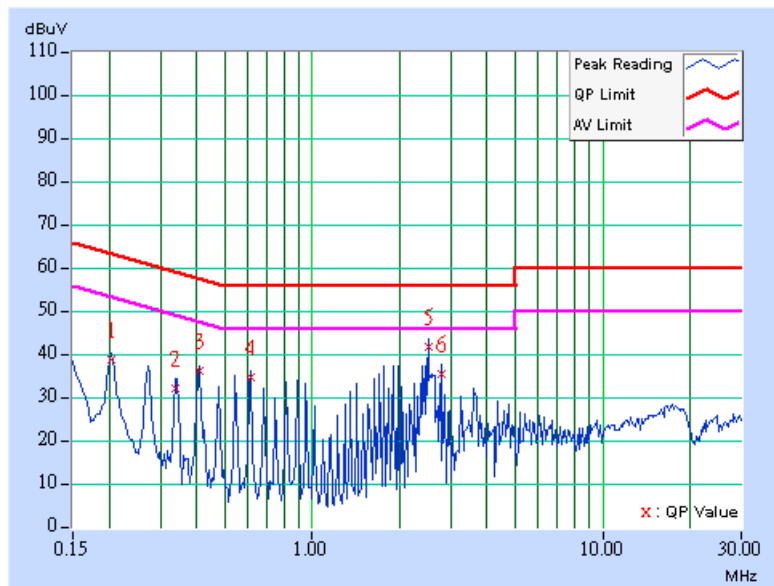



EUT	AT&T Plug&Share 54Mbps Wireless Router	MODEL	6800G
CHANNEL	Channel 11	6dB BANDWIDTH	9kHz
INPUT POWER (SYSTEM)	120Vac, 60 Hz	PHASE	Neutral (N)
ENVIRONMENTAL CONDITIONS	22deg.C, 65%RH, 991hPa	TESTED BY: Allen Chang	

No	Freq. [MHz]	Corr. Factor (dB)	Reading Value [dB (uV)]		Emission Level [dB (uV)]		Limit [dB (uV)]		Margin (dB)	
			Q.P.	AV.	Q.P.	AV.	Q.P.	AV.	Q.P.	AV.
	1	0.205	0.05	40.74	-	40.79	-	63.42	53.42	-22.63
2	0.271	0.05	35.99	-	36.04	-	61.08	51.08	-25.04	-
3	0.338	0.05	34.83	-	34.88	-	59.26	49.26	-24.38	-
4	0.408	0.05	34.28	-	34.33	-	57.69	47.69	-23.36	-
5	0.951	0.15	32.60	-	32.75	-	56.00	46.00	-23.25	-
6	2.520	0.19	37.97	-	38.16	-	56.00	46.00	-17.84	-

- REMARKS:**
1. Q.P. and AV. are abbreviations of quasi-peak and average individually.
 2. "-": The Quasi-peak reading value also meets average limit and measurement with the average detector is unnecessary.
 3. The emission levels of other frequencies were very low against the limit.
 4. Margin value = Emission level - Limit value
 5. Correction factor = Insertion loss + Cable loss
 6. Emission Level = Correction Factor + Reading Value.

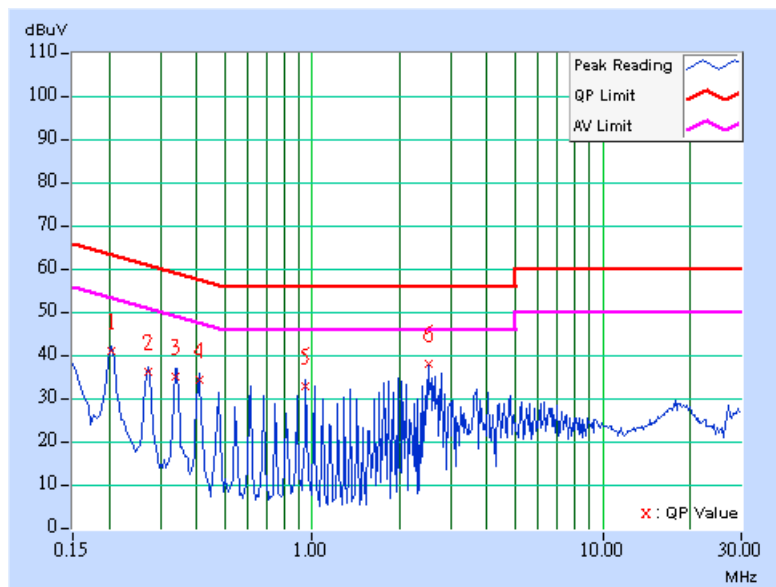



4.2 RADIATED EMISSION MEASUREMENT

4.2.1 LIMITS OF RADIATED EMISSION MEASUREMENT

Emissions radiated outside of the specified bands, shall be according to the general radiated limits in 15.209 as following:

Frequencies (MHz)	Field strength (microvolts/meter)	Measurement distance (meters)
0.009-0.490	2400/F(kHz)	300
0.490-1.705	24000/F(kHz)	30
1.705-30.0	30	30
30-88	100	3
88-216	150	3
216-960	200	3
Above 960	500	3

NOTE:

1. The lower limit shall apply at the transition frequencies.
2. Emission level (dBuV/m) = 20 log Emission level (uV/m).
3. As shown in 15.35(b), for frequencies above 1000MHz, the field strength limits are based on average detector, however, the peak field strength of any emission shall not exceed the maximum permitted average limits, specified above by more than 20dB under any condition of modulation.



4.2.2 TEST INSTRUMENTS

DESCRIPTION & MANUFACTURER	MODEL NO.	SERIAL NO.	CALIBRATED UNTIL
* HP Spectrum Analyzer	8594E	3911A07465	Jul. 07, 2004
* HP Preamplifier	8447D	2944A10386	Aug. 12, 2004
* HP Preamplifier	8449B	3008A01201	Dec. 01, 2003
* HP Preamplifier	8449B	3008A01292	Aug. 11, 2004
SCHAFFNER Tunable Dipole Antenna	VHBA 9123	459	Nov. 22, 2003
SCHWARZBECK Tunable Dipole Antenna	UHA 9105	977	
SCHAFFNER TEST RECEIVER	SCR 3501	409	Jan. 26, 2004
* SCHAFFNER BILOG Antenna	CBL6111C	2727	Jul. 15, 2004
* SCHWARZBECK Horn Antenna	BBHA9120-D1	D130	Jun 30, 2004
* EMCO Horn Antenna	3115	9312-4192	Mar. 23 2004
* ADT. Turn Table	TT100	0201	NA
* ADT. Tower	AT100	0201	NA
* Software	ADT_Radiated_V5.14	NA	NA
* ANRITSU RF Switches	MP59B	6100237246	Oct. 30, 2003
* TIMES RF cable	LMR-600	CABLE-ST10-01	Oct. 30, 2003

- NOTE:**
1. The calibration interval of the above test instruments is 12 months. And the calibrations are traceable to NML/ROC and NIST/USA.
 2. "*" = These equipment are used for the final measurement.
 3. The horn antenna and HP preamplifier (model: 8449B) are used only for the measurement of emission frequency above 1GHz if tested.
 4. The test was performed in ADT Open Site No. 10.
 5. The VCCI Site Registration No. is R-1625.



4.2.3 TEST PROCEDURES

- a. The EUT was placed on the top of a rotating table 0.8 meters above the ground at a 10 meter open area test site. The table was rotated 360 degrees to determine the position of the highest radiation.
- b. The EUT was set 3 meters away from the interference-receiving antenna, which was mounted on the top of a variable-height antenna tower.
- c. The antenna is a broadband antenna, and its height is varied from one meter to four meters above the ground to determine the maximum value of the field strength. Both horizontal and vertical polarizations of the antenna are set to make the measurement.
- d. For each suspected emission, the EUT was arranged to its worst case and then the antenna was tuned to heights from 1 meter to 4 meters and the rotatable table was turned from 0 degrees to 360 degrees to find the maximum reading.
- e. The test-receiver system was set to Peak Detect Function and Specified Bandwidth with Maximum Hold Mode.
- f. If the emission level of the EUT in peak mode was 10 dB lower than the limit specified, then testing could be stopped and the peak values of the EUT would be reported. Otherwise the emissions that did not have 10 dB margin would be re-tested one by one using peak, quasi-peak or average method as specified and then reported in a data sheet.

NOTE:

1. The resolution bandwidth and video bandwidth of test receiver/spectrum analyzer is 120kHz for Peak detection (PK) and Quasi-peak detection (QP) at frequency below 1GHz.
2. The resolution bandwidth and video bandwidth of test receiver/spectrum analyzer is 1 MHz for Peak detection at frequency above 1GHz.
3. The resolution bandwidth of test receiver/spectrum analyzer is 1 MHz and the video bandwidth is 300 Hz for Average detection (AV) at frequency above 1GHz.

4.2.4 DEVIATION FROM TEST STANDARD

No deviation

4.2.5 TEST SETUP

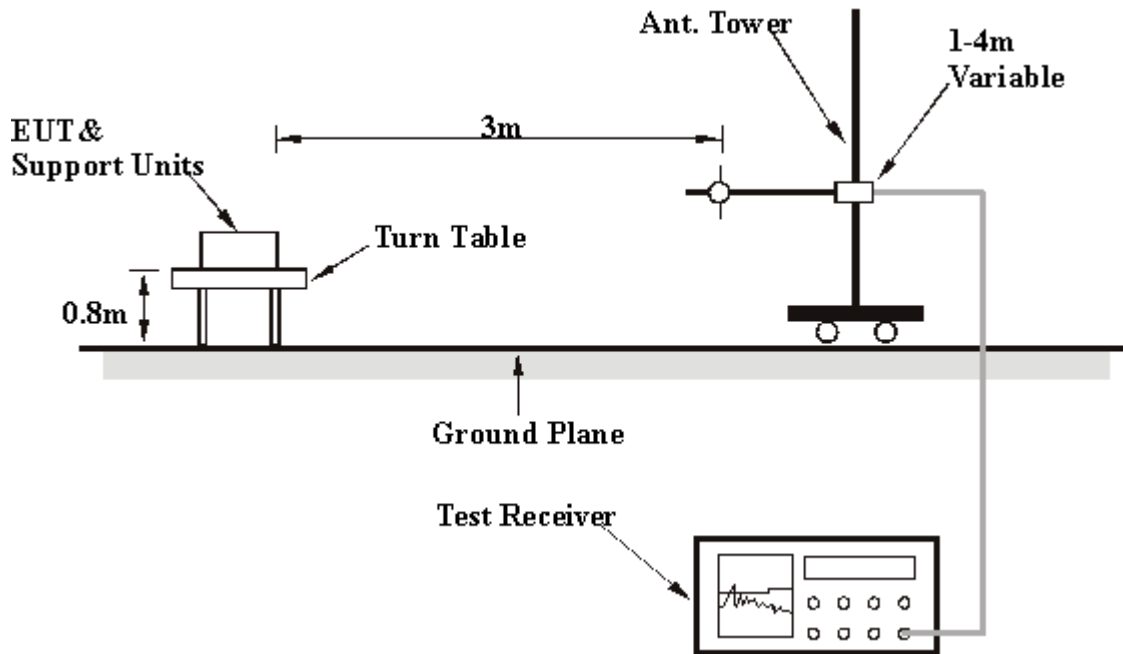

For the actual test configuration, please refer to the related item – Photographs of the Test Configuration.

4.2.6 EUT OPERATING CONDITIONS

Same as 4.1.6



4.2.7 TEST RESULTS (A)

EUT	2.4GHz 54Mbps Wireless Router	MODEL	GL2454RT-QA
CHANNEL	Channel 11	FREQUENCY RANGE	Below 1000MHz
INPUT POWER (SYSTEM)	120Vac, 60 Hz	DETECTOR FUNCTION	Quasi-Peak
ENVIRONMENTAL CONDITIONS	30deg. C, 60%RH, 991hPa	TESTED BY: Jamison Chan	

ANTENNA POLARITY & TEST DISTANCE: HORIZONTAL AT 3 M								
No.	Freq. (MHz)	Emission Level (dBuV/m)	Limit (dBuV/m)	Margin (dB)	Antenna Height (m)	Table Angle (Degree)	Raw Value (dBuV)	Correction Factor (dB/m)
1	250.03	42.1 QP	46.00	-3.90	1.25 H	301	29.60	12.50
2	270.00	38.2 QP	46.00	-7.80	1.17 H	321	24.40	13.70
3	360.00	33.1 QP	46.00	-12.90	1.24 H	7	17.30	15.80
4	375.05	39.8 QP	46.00	-6.20	1.05 H	297	23.40	16.40
5	450.00	35.8 QP	46.00	-10.20	1.00 H	347	17.70	18.20
6	500.05	36.8 QP	46.00	-9.20	1.00 H	262	17.30	19.50
7	540.00	30.9 QP	46.00	-15.10	1.05 H	324	10.50	20.50
8	630.02	33.6 QP	46.00	-12.40	1.05 H	282	11.50	22.10
9	720.02	31.7 QP	46.00	-14.30	1.08 H	291	8.50	23.30
10	810.01	37.2 QP	46.00	-8.80	1.06 H	164	13.20	24.10

ANTENNA POLARITY & TEST DISTANCE: VERTICAL AT 3 M								
No.	Freq. (MHz)	Emission Level (dBuV/m)	Limit (dBuV/m)	Margin (dB)	Antenna Height (m)	Table Angle (Degree)	Raw Value (dBuV)	Correction Factor (dB/m)
1	250.03	39.0 QP	46.00	-7.00	1.16 V	146	26.50	12.50
2	270.02	38.5 QP	46.00	-7.50	1.00 V	3	24.70	13.70
3	350.03	35.0 QP	46.00	-11.00	1.10 V	150	19.60	15.40
4	375.06	39.6 QP	46.00	-6.40	1.20 V	148	23.20	16.40
5	450.00	40.8 QP	46.00	-5.20	1.23 V	194	22.70	18.20
6	500.03	37.7 QP	46.00	-8.30	1.30 V	267	18.20	19.50
7	540.02	36.4 QP	46.00	-9.60	1.17 V	335	15.90	20.50
8	630.00	37.9 QP	46.00	-8.10	1.16 V	309	15.80	22.10
9	720.00	33.8 QP	46.00	-12.20	1.00 V	316	10.60	23.30
10	810.00	34.8 QP	46.00	-11.20	1.00 V	280	10.70	24.10

- REMARKS:**
1. Emission level(dBuV/m)=Raw Value(dBuV) + Correction Factor(dB/m)
 2. Correction Factor(dB/m) = Antenna Factor (dB/m) + Cable Factor (dB)
 3. The other emission levels were very low against the limit.
 4. Margin value = Emission level – Limit value.



EUT	2.4GHz 54Mbps Wireless Router	MODEL	GL2454RT-QA
CHANNEL	Channel 1	FREQUENCY RANGE	Above 1000MHz
MODE	CCK		
INPUT POWER (SYSTEM)	120Vac, 60 Hz	DETECTOR FUNCTION	Peak(PK) Average (AV)
ENVIRONMENTAL CONDITIONS	30deg. C, 60%RH, 991hPa	TESTED BY: Jamison Chan	

ANTENNA POLARITY & TEST DISTANCE: HORIZONTAL AT 3 M

No.	Freq. (MHz)	Emission Level (dBuV/m)	Limit (dBuV/m)	Margin (dB)	Antenna Height (m)	Table Angle (Degree)	Raw Value (dBuV)	Correction Factor (dB/m)
1	2390.00	54.4 PK	74.00	-17.60	1.34 H	213	20.80	33.60
1	2390.00	50.1 AV	54.00	-3.90	1.34 H	213	16.60	33.60
2	*2412.00	108.3 PK			1.34 H	213	74.70	33.70
2	*2412.00	103.8 AV			1.34 H	213	70.20	33.70
3	2688.00	52.0 PK	74.00	-22.00	1.34 H	213	17.30	34.70
3	2688.00	47.5 AV	54.00	-6.50	1.34 H	213	12.80	34.70
4	4824.00	54.9 PK	74.00	-19.10	1.28 H	305	13.70	41.10
4	4824.00	45.0 AV	54.00	-9.00	1.28 H	305	3.90	41.10

ANTENNA POLARITY & TEST DISTANCE: VERTICAL AT 3 M

No.	Freq. (MHz)	Emission Level (dBuV/m)	Limit (dBuV/m)	Margin (dB)	Antenna Height (m)	Table Angle (Degree)	Raw Value (dBuV)	Correction Factor (dB/m)
1	2320.00	55.0 PK	74.00	-19.00	1.25 V	195	21.80	33.20
1	2320.00	51.0 AV	54.00	-3.00	1.25 V	195	17.80	33.20
2	*2412.00	109.3 PK			1.25 V	195	75.70	33.70
2	*2412.00	105.3 AV			1.25 V	195	71.70	33.70
3	2688.00	55.5 PK	74.00	-18.50	1.25 V	195	20.80	34.70
3	2688.00	51.5 AV	54.00	-2.50	1.25 V	195	55.50	34.70
4	4824.00	55.4 PK	74.00	-18.60	1.25 V	208	14.20	41.10
4	4824.00	50.2 AV	54.00	-3.80	1.25 V	208	9.10	41.10
5	7236.00	60.1 PK	74.00	-13.90	1.28 V	46	15.30	44.80
5	7236.00	47.8 AV	54.00	-6.20	1.28 V	46	3.00	44.80
6	9648.00	60.7 PK	74.00	-13.30	1.25 V	161	13.20	47.50
6	9648.00	48.2 AV	54.00	-5.80	1.25 V	161	0.70	47.50

- REMARKS:**
1. Emission level(dBuV/m)=Raw Value(dBuV) + Correction Factor(dB)
 2. Correction Factor(dB/m) = Antenna Factor (dB/m) + Cable Factor (dB)
 3. The other emission levels were very low against the limit.
 4. Margin value = Emission level – Limit value.
 5. “ * “ : Fundamental frequency.



EUT	2.4GHz 54Mbps Wireless Router	MODEL	GL2454RT-QA
CHANNEL	Channel 6	FREQUENCY RANGE	Above 1000MHz
MODE	CCK		
INPUT POWER (SYSTEM)	120Vac, 60 Hz	DETECTOR FUNCTION	Peak(PK) Average (AV)
ENVIRONMENTAL CONDITIONS	30deg. C, 60%RH, 991hPa	TESTED BY: Jamison Chan	

ANTENNA POLARITY & TEST DISTANCE: HORIZONTAL AT 3M								
No.	Freq. (MHz)	Emission Level (dBuV/m)	Limit (dBuV/m)	Margin (dB)	Antenna Height (m)	Table Angle (Degree)	Raw Value (dBuV)	Correction Factor (dB/m)
1	*2437.00	109.6 PK			1.35 H	217	75.90	33.80
1	*2437.00	104.7 AV			1.35 H	217	71.00	33.80
2	4874.00	57.1 PK	74.00	-16.90	1.37 H	297	15.90	41.30
2	4874.00	48.9 AV	54.00	-5.10	1.37 H	297	7.70	41.30

ANTENNA POLARITY & TEST DISTANCE: VERTICAL AT 3M								
No.	Freq. (MHz)	Emission Level (dBuV/m)	Limit (dBuV/m)	Margin (dB)	Antenna Height (m)	Table Angle (Degree)	Raw Value (dBuV)	Correction Factor (dB/m)
1	*2437.00	108.1 PK			1.36 V	112	74.40	33.80
1	*2437.00	98.6 AV			1.36 V	112	64.80	33.80
2	4874.00	55.8 PK	74.00	-18.20	1.38 V	137	14.50	41.30
2	4874.00	46.8 AV	54.00	-7.20	1.38 V	137	5.50	41.30

- REMARKS:**
1. Emission level(dBuV/m)=Raw Value(dBuV) + Correction Factor(dB)
 2. Correction Factor(dB/m) = Antenna Factor (dB/m) + Cable Factor (dB)
 3. The other emission levels were very low against the limit.
 4. Margin value = Emission level – Limit value.
 5. “ * “ : Fundamental frequency.



EUT	2.4GHz 54Mbps Wireless Router	MODEL	GL2454RT-QA
CHANNEL	Channel 11	FREQUENCY RANGE	Above 1000MHz
MODE	CCK		
INPUT POWER (SYSTEM)	120Vac, 60 Hz	DETECTOR FUNCTION	Peak(PK) Average (AV)
ENVIRONMENTAL CONDITIONS	30deg. C, 60%RH, 991hPa	TESTED BY: Jamison Chan	

ANTENNA POLARITY & TEST DISTANCE: HORIZONTAL AT 3M

No.	Freq. (MHz)	Emission Level (dBuV/m)	Limit (dBuV/m)	Margin (dB)	Antenna Height (m)	Table Angle (Degree)	Raw Value (dBuV)	Correction Factor (dB/m)
1	*2462.00	108.4 PK			1.32 H	207	74.50	33.90
1	*2462.00	103.6 AV			1.32 H	207	69.70	33.90
2	2483.50	56.5 PK	74.00	-17.50	1.32 H	207	22.60	33.90
2	2483.50	51.8 AV	54.00	-2.20	1.32 H	207	17.80	33.90
3	2688.00	51.7 PK	74.00	-22.30	1.32 H	207	17.00	34.70
3	2688.00	46.9 AV	54.00	-7.10	1.32 H	207	12.20	34.70
4	4924.00	55.4 PK	74.00	-18.60	1.24 H	248	14.00	41.40
4	4924.00	42.4 AV	54.00	-11.60	1.24 H	248	1.00	41.40

ANTENNA POLARITY & TEST DISTANCE: VERTICAL AT 3M

No.	Freq. (MHz)	Emission Level (dBuV/m)	Limit (dBuV/m)	Margin (dB)	Antenna Height (m)	Table Angle (Degree)	Raw Value (dBuV)	Correction Factor (dB/m)
1	*2462.00	107.0 PK			1.23 V	132	73.20	33.90
1	*2462.00	103.0 AV			1.23 V	132	69.20	33.90
2	2483.50	52.9 PK	74.00	-21.10	1.23 V	132	19.00	33.90
2	2483.50	48.9 AV	54.00	-5.10	1.23 V	132	15.00	33.90
3	2688.00	53.1 PK	74.00	-20.90	1.23 V	132	11.20	34.70
3	2688.00	41.9 AV	54.00	-12.10	1.23 V	132	7.20	34.70
4	4924.00	64.8 PK	74.00	-9.20	1.15 V	311	23.40	41.40
4	4924.00	49.9 AV	54.00	-4.10	1.15 V	311	8.50	41.40
5	7386.00	60.5 PK	74.00	-13.50	1.14 V	283	15.30	45.20
5	7386.00	48.8 AV	54.00	-5.20	1.14 V	283	3.60	45.20
6	9848.00	58.3 PK	74.00	-15.70	1.03 V	226	13.40	44.80
6	9848.00	44.6 AV	54.00	-9.40	1.03 V	226	-0.20	44.80

- REMARKS:**
1. Emission level(dBuV/m)=Raw Value(dBuV) + Correction Factor(dB)
 2. Correction Factor(dB/m) = Antenna Factor (dB/m) + Cable Factor (dB)
 3. The other emission levels were very low against the limit.
 4. Margin value = Emission level – Limit value.
 5. “ * “ : Fundamental frequency.



EUT	2.4GHz 54Mbps Wireless Router	MODEL	GL2454RT-QA
CHANNEL	Channel 1	FREQUENCY RANGE	Above 1000MHz
MODE	OFDM		
INPUT POWER (SYSTEM)	120Vac, 60 Hz	DETECTOR FUNCTION	Peak(PK) Average (AV)
ENVIRONMENTAL CONDITIONS	30deg. C, 60%RH, 991hPa	TESTED BY: Jamison Chan	

ANTENNA POLARITY & TEST DISTANCE: HORIZONTAL AT 3 M

No.	Freq. (MHz)	Emission Level (dBuV/m)	Limit (dBuV/m)	Margin (dB)	Antenna Height (m)	Table Angle (Degree)	Raw Value (dBuV)	Correction Factor (dB/m)
1	2360.00	53.7 PK	74.00	-20.30	1.15 H	162	20.30	33.40
1	2360.00	44.0 AV	54.00	-10.00	1.15 H	162	10.60	33.40
2	*2412.00	101.0 PK			1.15 H	162	67.30	33.70
2	*2412.00	91.3 AV			1.15 H	162	57.70	33.70
3	2688.00	50.0 PK	74.00	-24.00	1.15 H	162	15.30	34.70
3	2688.00	40.3 AV	54.00	-13.70	1.15 H	162	5.60	34.70

ANTENNA POLARITY & TEST DISTANCE: VERTICAL AT 3 M

No.	Freq. (MHz)	Emission Level (dBuV/m)	Limit (dBuV/m)	Margin (dB)	Antenna Height (m)	Table Angle (Degree)	Raw Value (dBuV)	Correction Factor (dB/m)
1	2360.00	55.2 PK	74.00	-18.80	1.17 V	184	21.80	33.40
1	2360.00	50.8 AV	54.00	-3.20	1.17 V	184	17.40	33.40
2	*2412.00	103.7 PK			1.17 V	184	70.00	33.70
2	*2412.00	99.3 AV			1.17 V	184	65.60	33.70
3	2688.00	46.1 PK	74.00	-27.90	1.17 V	184	11.40	34.70
3	2688.00	41.7 AV	54.00	-12.30	1.17 V	184	7.00	34.70
4	4824.00	55.2 PK	74.00	-18.80	1.14 V	198	14.10	41.10
4	4824.00	41.9 AV	54.00	-12.10	1.14 V	198	0.70	41.10

- REMARKS:**
1. Emission level(dBuV/m)=Raw Value(dBuV) + Correction Factor(dB)
 2. Correction Factor(dB/m) = Antenna Factor (dB/m) + Cable Factor (dB)
 3. The other emission levels were very low against the limit.
 4. Margin value = Emission level – Limit value.
 5. “ * “ : Fundamental frequency.



EUT	2.4GHz 54Mbps Wireless Router	MODEL	GL2454RT-QA
CHANNEL	Channel 6	FREQUENCY RANGE	Above 1000MHz
MODE	OFDM		
INPUT POWER (SYSTEM)	120Vac, 60 Hz	DETECTOR FUNCTION	Peak(PK) Average (AV)
ENVIRONMENTAL CONDITIONS	30deg. C, 60%RH, 991hPa	TESTED BY: Jamison Chan	

ANTENNA POLARITY & TEST DISTANCE: HORIZONTAL AT 3M								
No.	Freq. (MHz)	Emission Level (dBuV/m)	Limit (dBuV/m)	Margin (dB)	Antenna Height (m)	Table Angle (Degree)	Raw Value (dBuV)	Correction Factor (dB/m)
1	*2437.00	110.5 PK			1.35 H	213	76.70	33.80
1	*2437.00	99.8 AV			1.35 H	213	66.00	33.80
2	4874.00	53.8 PK	74.00	-20.20	1.32 H	177	12.50	41.30
2	4874.00	41.5 AV	54.00	-12.50	1.32 H	177	0.20	41.30

ANTENNA POLARITY & TEST DISTANCE: VERTICAL AT 3M								
No.	Freq. (MHz)	Emission Level (dBuV/m)	Limit (dBuV/m)	Margin (dB)	Antenna Height (m)	Table Angle (Degree)	Raw Value (dBuV)	Correction Factor (dB/m)
1	*2437.00	110.8 PK			1.06 V	115	77.00	33.80
1	*2437.00	100.1 AV			1.06 V	115	66.30	33.80
2	4874.00	55.0 PK	74.00	-19.00	1.05 V	274	13.70	41.30
2	4874.00	42.5 AV	54.00	-11.50	1.05 V	274	1.20	41.30

- REMARKS:**
1. Emission level(dBuV/m)=Raw Value(dBuV) + Correction Factor(dB)
 2. Correction Factor(dB/m) = Antenna Factor (dB/m) + Cable Factor (dB)
 3. The other emission levels were very low against the limit.
 4. Margin value = Emission level – Limit value.
 5. “ * “ : Fundamental frequency.



EUT	2.4GHz 54Mbps Wireless Router	MODEL	GL2454RT-QA
CHANNEL	Channel 11	FREQUENCY RANGE	Above 1000MHz
MODE	OFDM		
INPUT POWER (SYSTEM)	120Vac, 60 Hz	DETECTOR FUNCTION	Peak(PK) Average (AV)
ENVIRONMENTAL CONDITIONS	30deg. C, 60%RH, 991hPa	TESTED BY: Jamison Chan	

ANTENNA POLARITY & TEST DISTANCE: HORIZONTAL AT 3M

No.	Freq. (MHz)	Emission Level (dBuV/m)	Limit (dBuV/m)	Margin (dB)	Antenna Height (m)	Table Angle (Degree)	Raw Value (dBuV)	Correction Factor (dB/m)
1	*2462.00	102.9 PK			1.43 H	158	69.00	33.90
1	*2462.00	92.2 AV			1.43 H	158	58.30	33.90
2	2483.50	55.9 PK	74.00	-18.10	1.43 H	158	22.00	33.90
2	2483.50	45.2 AV	54.00	-8.80	1.43 H	158	11.30	33.90
3	2688.00	50.4 PK	74.00	-23.60	1.43 H	158	15.70	34.70
3	2688.00	39.7 AV	54.00	-14.30	1.43 H	158	5.00	34.70

ANTENNA POLARITY & TEST DISTANCE: VERTICAL AT 3M

No.	Freq. (MHz)	Emission Level (dBuV/m)	Limit (dBuV/m)	Margin (dB)	Antenna Height (m)	Table Angle (Degree)	Raw Value (dBuV)	Correction Factor (dB/m)
1	*2462.00	111.4 PK			1.15 V	129	77.50	33.90
1	*2462.00	100.5 AV			1.15 V	129	66.70	33.90
2	2483.50	62.0 PK	74.00	-12.00	1.15 V	129	28.10	33.90
2	2483.50	51.2 AV	54.00	-2.80	1.15 V	129	17.20	33.90
3	2688.00	53.6 PK	74.00	-20.40	1.15 V	129	18.90	34.70
3	2688.00	42.7 AV	54.00	-11.30	1.15 V	129	8.00	34.70
4	4924.00	52.8 PK	74.00	-21.20	1.37 V	258	11.40	41.40
4	4924.00	40.6 AV	54.00	-13.40	1.37 V	258	-0.80	41.40
5	7384.00	59.8 PK	74.00	-14.20	1.39 V	291	14.60	45.20
5	7384.00	46.3 AV	54.00	-7.70	1.39 V	291	1.10	45.20

- REMARKS:**
1. Emission level(dBuV/m)=Raw Value(dBuV) + Correction Factor(dB)
 2. Correction Factor(dB/m) = Antenna Factor (dB/m) + Cable Factor (dB)
 3. The other emission levels were very low against the limit.
 4. Margin value = Emission level – Limit value.
 5. “ * “ : Fundamental frequency.



4.2.8 TEST RESULTS (B)

EUT	AT&T Plug&Share 54Mbps Wireless Router	MODEL	6800G
CHANNEL	Channel 11	FREQUENCY RANGE	Below 1000MHz
INPUT POWER (SYSTEM)	120Vac, 60 Hz	DETECTOR FUNCTION	Quasi-Peak
ENVIRONMENTAL CONDITIONS	30deg. C, 60%RH, 991hPa	TESTED BY: Jamison Chan	

ANTENNA POLARITY & TEST DISTANCE: HORIZONTAL AT 3 M

No.	Freq. (MHz)	Emission Level (dBuV/m)	Limit (dBuV/m)	Margin (dB)	Antenna Height (m)	Table Angle (Degree)	Raw Value (dBuV)	Correction Factor (dB/m)
1	250.00	41.6 QP	46.00	-4.40	0.80 H	0	27.68	13.92
2	270.00	37.4 QP	46.00	-8.60	0.80 H	0	22.21	15.19
3	350.06	32.9 QP	46.00	-13.10	0.80 H	0	15.63	17.27
4	375.00	37.6 QP	46.00	-8.40	0.80 H	0	19.26	18.34
5	400.00	32.4 QP	46.00	-13.60	0.80 H	0	12.98	19.42
6	450.00	37.6 QP	46.00	-8.40	0.80 H	0	17.23	20.37
7	500.00	38.5 QP	46.00	-7.50	0.80 H	0	16.60	21.90
8	540.00	37.1 QP	46.00	-8.90	0.80 H	0	14.06	23.04
9	630.00	39.9 QP	46.00	-6.10	0.80 H	0	14.74	25.16
10	720.00	36.2 QP	46.00	-9.80	0.80 H	0	9.68	29.53
11	810.00	39.9 QP	46.00	-6.10	0.80 H	0	12.30	27.60

ANTENNA POLARITY & TEST DISTANCE: VERTICAL AT 3 M

No.	Freq. (MHz)	Emission Level (dBuV/m)	Limit (dBuV/m)	Margin (dB)	Antenna Height (m)	Table Angle (Degree)	Raw Value (dBuV)	Correction Factor (dB/m)
1	250.11	39.8 QP	46.00	-4.40	0.80 H	0	25.86	13.94
2	350.04	35.5 QP	46.00	-8.60	0.80 H	0	18.23	17.27
3	375.05	41.5 QP	46.00	-13.10	0.80 H	0	23.15	18.35
4	400.03	34.7 QP	46.00	-8.40	0.80 H	0	15.28	19.42
5	450.00	40.8 QP	46.00	-13.60	0.80 H	0	20.43	20.37
6	500.05	41.5 QP	46.00	-8.40	0.80 H	0	19.60	21.90
7	540.01	35.8 QP	46.00	-7.50	0.80 H	0	12.76	23.04
8	630.01	35.7 QP	46.00	-8.90	0.80 H	0	10.54	25.16
9	720.01	34.7 QP	46.00	-6.10	0.80 H	0	8.18	26.52
10	810.01	37.4 QP	46.00	-9.80	0.80 H	0	9.80	27.60

- REMARKS:**
1. Emission level(dBuV/m)=Raw Value(dBuV) + Correction Factor(dB/m)
 2. Correction Factor(dB/m) = Antenna Factor (dB/m) + Cable Factor (dB)
 3. The other emission levels were very low against the limit.
 4. Margin value = Emission level – Limit value.



EUT	AT&T Plug&Share 54Mbps Wireless Router	MODEL	6800G
CHANNEL	Channel 1	FREQUENCY RANGE	Above 1000MHz
MODE	CCK		
INPUT POWER (SYSTEM)	120Vac, 60 Hz	DETECTOR FUNCTION	Peak(PK) Average (AV)
ENVIRONMENTAL CONDITIONS	30deg. C, 60%RH, 991hPa	TESTED BY: Jamison Chan	

ANTENNA POLARITY & TEST DISTANCE: HORIZONTAL AT 3 M

No.	Freq. (MHz)	Emission Level (dBuV/m)	Limit (dBuV/m)	Margin (dB)	Antenna Height (m)	Table Angle (Degree)	Raw Value (dBuV)	Correction Factor (dB/m)
1	2360.00	51.0 PK	74.00	-23.00	1.03 H	248	17.60	33.40
1	2360.00	43.2 AV	54.00	-10.80	1.03 H	248	9.80	33.40
2	*2412.00	107.0 PK			1.03 H	248	73.30	33.70
2	*2412.00	99.2 AV			1.03 H	248	65.50	33.70
3	4824.00	48.4 PK	74.00	-25.60	1.00 H	332	7.20	41.10
3	4824.00	36.7 AV	54.00	-17.30	1.00 H	332	-4.40	41.10
4	7236.00	53.3 PK	74.00	-20.70	1.00 H	326	8.50	44.80
4	7236.00	40.8 AV	54.00	-13.20	1.00 H	326	-4.00	44.80

ANTENNA POLARITY & TEST DISTANCE: VERTICAL AT 3 M

No.	Freq. (MHz)	Emission Level (dBuV/m)	Limit (dBuV/m)	Margin (dB)	Antenna Height (m)	Table Angle (Degree)	Raw Value (dBuV)	Correction Factor (dB/m)
1	2360.00	57.6 PK	74.00	-16.40	1.00 V	360	24.20	33.40
1	2360.00	49.5 AV	54.00	-4.50	1.00 V	360	16.10	33.40
2	*2412.00	110.3 PK			1.00 V	360	76.70	33.70
2	*2412.00	102.2 AV			1.00 V	360	68.50	33.70
3	4824.00	52.4 PK	74.00	-21.60	1.00 V	247	11.20	41.10
3	4824.00	39.4 AV	54.00	-14.60	1.00 V	247	-1.80	41.10
4	7236.00	54.8 PK	74.00	-19.20	1.00 V	300	10.00	44.80
4	7236.00	42.1 AV	54.00	-11.90	1.00 V	300	-2.70	44.80

- REMARKS:**
1. Emission level(dBuV/m)=Raw Value(dBuV) + Correction Factor(dB)
 2. Correction Factor(dB/m) = Antenna Factor (dB/m) + Cable Factor (dB)
 3. The other emission levels were very low against the limit.
 4. Margin value = Emission level – Limit value.
 5. “ * “ : Fundamental frequency.



EUT	AT&T Plug&Share 54Mbps Wireless Router	MODEL	6800G
CHANNEL	Channel 6	FREQUENCY RANGE	Above 1000MHz
MODE	CCK		
INPUT POWER (SYSTEM)	120Vac, 60 Hz	DETECTOR FUNCTION	Peak(PK) Average (AV)
ENVIRONMENTAL CONDITIONS	30deg. C, 60%RH, 991hPa	TESTED BY: Jamison Chan	

ANTENNA POLARITY & TEST DISTANCE: HORIZONTAL AT 3M								
No.	Freq. (MHz)	Emission Level (dBuV/m)	Limit (dBuV/m)	Margin (dB)	Antenna Height (m)	Table Angle (Degree)	Raw Value (dBuV)	Correction Factor (dB/m)
1	*2437.00	106.9 PK			1.07 H	255	73.20	33.80
1	*2437.00	98.9 AV			1.07 H	255	65.20	33.80
2	4874.00	47.8 PK	74.00	-26.20	1.00 H	89	6.50	41.30
2	4874.00	37.3 AV	54.00	-16.70	1.00 H	89	-4.00	41.30

ANTENNA POLARITY & TEST DISTANCE: VERTICAL AT 3M								
No.	Freq. (MHz)	Emission Level (dBuV/m)	Limit (dBuV/m)	Margin (dB)	Antenna Height (m)	Table Angle (Degree)	Raw Value (dBuV)	Correction Factor (dB/m)
1	*2437.00	111.1 PK			1.00 V	247	77.30	33.80
1	*2437.00	102.6 AV			1.00 V	247	68.80	33.80
2	4874.00	52.5 PK	74.00	-21.50	1.00 V	247	11.20	41.30
2	4874.00	39.0 AV	54.00	-15.00	1.00 V	247	-2.30	41.30
3	7311.00	55.7 PK	74.00	-18.30	1.00 V	298	10.40	45.30
3	7311.00	43.5 AV	54.00	-10.50	1.00 V	298	-1.70	45.30

- REMARKS:**
1. Emission level(dBuV/m)=Raw Value(dBuV) + Correction Factor(dB)
 2. Correction Factor(dB/m) = Antenna Factor (dB/m) + Cable Factor (dB)
 3. The other emission levels were very low against the limit.
 4. Margin value = Emission level – Limit value.
 5. “ * “ : Fundamental frequency.



EUT	AT&T Plug&Share 54Mbps Wireless Router	MODEL	6800G
CHANNEL	Channel 11	FREQUENCY RANGE	Above 1000MHz
MODE	CCK		
INPUT POWER (SYSTEM)	120Vac, 60 Hz	DETECTOR FUNCTION	Peak(PK) Average (AV)
ENVIRONMENTAL CONDITIONS	30deg. C, 60%RH, 991hPa	TESTED BY: Jamison Chan	

ANTENNA POLARITY & TEST DISTANCE: HORIZONTAL AT 3M								
No.	Freq. (MHz)	Emission Level (dBuV/m)	Limit (dBuV/m)	Margin (dB)	Antenna Height (m)	Table Angle (Degree)	Raw Value (dBuV)	Correction Factor (dB/m)
1	*2462.00	107.4 PK			1.09 H	263	73.50	33.90
1	*2462.00	99.0 AV			1.09 H	263	65.20	33.90
2	2483.50	48.9 PK	74.00	-25.10	1.09 H	263	15.00	33.90
2	2483.50	40.5 AV	54.00	-13.50	1.09 H	263	6.60	33.90
3	4924.00	50.6 PK	74.00	-23.40	1.08 H	252	9.20	41.40
3	4924.00	37.4 AV	54.00	-16.60	1.08 H	252	-4.00	41.40

ANTENNA POLARITY & TEST DISTANCE: VERTICAL AT 3M								
No.	Freq. (MHz)	Emission Level (dBuV/m)	Limit (dBuV/m)	Margin (dB)	Antenna Height (m)	Table Angle (Degree)	Raw Value (dBuV)	Correction Factor (dB/m)
1	*2462.00	111.0 PK			1.08 V	213	77.20	33.90
1	*2462.00	102.7 AV			1.08 V	213	68.80	33.90
2	2483.50	53.8 PK	74.00	-20.20	1.08 V	213	19.90	33.90
2	2483.50	45.5 AV	54.00	-8.50	1.08 V	213	11.60	33.90
3	4924.00	53.8 PK	74.00	-20.20	1.08 V	278	12.40	41.40
3	4924.00	39.4 AV	54.00	-14.60	1.08 V	278	-2.00	41.40
4	7386.00	54.3 PK	74.00	-19.70	1.05 V	298	9.10	45.20
4	7386.00	42.0 AV	54.00	-12.00	1.05 V	298	-3.20	45.20

- REMARKS:**
1. Emission level(dBuV/m)=Raw Value(dBuV) + Correction Factor(dB)
 2. Correction Factor(dB/m) = Antenna Factor (dB/m) + Cable Factor (dB)
 3. The other emission levels were very low against the limit.
 4. Margin value = Emission level – Limit value.
 5. “ * “ : Fundamental frequency.



EUT	AT&T Plug&Share 54Mbps Wireless Router	MODEL	6800G
CHANNEL	Channel 1	FREQUENCY RANGE	Above 1000MHz
MODE	OFDM		
INPUT POWER (SYSTEM)	120Vac, 60 Hz	DETECTOR FUNCTION	Peak(PK) Average (AV)
ENVIRONMENTAL CONDITIONS	30deg. C, 55%RH, 991hPa	TESTED BY: Steven Lu	

ANTENNA POLARITY & TEST DISTANCE: HORIZONTAL AT 3 M

No.	Freq. (MHz)	Emission Level (dBuV/m)	Limit (dBuV/m)	Margin (dB)	Antenna Height (m)	Table Angle (Degree)	Raw Value (dBuV)	Correction Factor (dB/m)
1	2390.00	58.7 PK	74.00	-15.30	1.33 H	258	25.10	33.60
1	2390.00	49.4 AV	54.00	-4.60	1.33 H	258	15.80	33.60
2	*2412.00	107.5 PK			1.33 H	258	73.80	33.70
2	*2412.00	98.2 AV			1.33 H	258	64.50	33.70
3	7236.00	53.0 PK	74.00	-21.00	1.06 H	82	8.20	44.80
3	7236.00	42.1 AV	54.00	-11.90	1.06 H	82	-2.70	44.80

ANTENNA POLARITY & TEST DISTANCE: VERTICAL AT 3 M

No.	Freq. (MHz)	Emission Level (dBuV/m)	Limit (dBuV/m)	Margin (dB)	Antenna Height (m)	Table Angle (Degree)	Raw Value (dBuV)	Correction Factor (dB/m)
1	2390.00	59.2 PK	74.00	-14.80	1.00 V	257	25.60	33.60
1	2390.00	51.5 AV	54.00	-2.50	1.00 V	257	17.90	33.60
2	*2412.00	108.0 PK			1.00 V	257	74.30	33.70
2	*2412.00	100.3 AV			1.00 V	257	66.60	33.70
3	7236.00	54.1 PK	74.00	-19.90	1.24 V	298	9.30	44.80
3	7236.00	43.7 AV	54.00	-10.30	1.24 V	298	-1.10	44.80

- REMARKS:**
1. Emission level(dBuV/m)=Raw Value(dBuV) + Correction Factor(dB)
 2. Correction Factor(dB/m) = Antenna Factor (dB/m) + Cable Factor (dB)
 3. The other emission levels were very low against the limit.
 4. Margin value = Emission level – Limit value.
 5. “ * “ : Fundamental frequency.



EUT	AT&T Plug&Share 54Mbps Wireless Router	MODEL	6800G
CHANNEL	Channel 6	FREQUENCY RANGE	Above 1000MHz
MODE	OFDM		
INPUT POWER (SYSTEM)	120Vac, 60 Hz	DETECTOR FUNCTION	Peak(PK) Average (AV)
ENVIRONMENTAL CONDITIONS	30deg. C, 55%RH, 991hPa	TESTED BY: Steven Lu	

ANTENNA POLARITY & TEST DISTANCE: HORIZONTAL AT 3M

No.	Freq. (MHz)	Emission Level (dBuV/m)	Limit (dBuV/m)	Margin (dB)	Antenna Height (m)	Table Angle (Degree)	Raw Value (dBuV)	Correction Factor (dB/m)
1	*2437.00	107.6 PK			1.52 H	287	73.80	33.80
1	*2437.00	98.0 AV			1.52 H	287	64.20	33.80
2	7311.00	53.7 PK	74.00	-20.30	1.14 H	189	8.50	45.30
2	7311.00	42.5 AV	54.00	-11.50	1.14 H	189	-2.70	45.30

ANTENNA POLARITY & TEST DISTANCE: VERTICAL AT 3M

No.	Freq. (MHz)	Emission Level (dBuV/m)	Limit (dBuV/m)	Margin (dB)	Antenna Height (m)	Table Angle (Degree)	Raw Value (dBuV)	Correction Factor (dB/m)
1	*2437.00	110.0 PK			1.21 V	292	76.20	33.80
1	*2437.00	100.6 AV			1.21 V	292	66.80	33.80
2	7311.00	54.7 PK	74.00	-19.30	1.03 V	83	9.50	45.30
2	7311.00	44.1 AV	54.00	-9.90	1.03 V	83	-1.10	45.30

- REMARKS:**
1. Emission level(dBuV/m)=Raw Value(dBuV) + Correction Factor(dB)
 2. Correction Factor(dB/m) = Antenna Factor (dB/m) + Cable Factor (dB)
 3. The other emission levels were very low against the limit.
 4. Margin value = Emission level – Limit value.
 5. “ * “ : Fundamental frequency.



EUT	AT&T Plug&Share 54Mbps Wireless Router	MODEL	6800G
CHANNEL	Channel 11	FREQUENCY RANGE	Above 1000MHz
MODE	OFDM		
INPUT POWER (SYSTEM)	120Vac, 60 Hz	DETECTOR FUNCTION	Peak(PK) Average (AV)
ENVIRONMENTAL CONDITIONS	30deg. C, 55%RH, 991hPa	TESTED BY: Steven Lu	

ANTENNA POLARITY & TEST DISTANCE: HORIZONTAL AT 3M

No.	Freq. (MHz)	Emission Level (dBuV/m)	Limit (dBuV/m)	Margin (dB)	Antenna Height (m)	Table Angle (Degree)	Raw Value (dBuV)	Correction Factor (dB/m)
1	*2462.00	107.5 PK			1.35 H	258	73.70	33.90
1	*2462.00	98.2 AV			1.35 H	258	64.30	33.90
2	2483.50	56.3 PK	74.00	-17.70	1.35 H	258	22.40	33.90
2	2483.50	47.0 AV	54.00	-7.00	1.35 H	258	13.10	33.90
3	7382.80	53.1 PK	74.00	-20.90	1.00 H	63	7.90	45.20
3	7382.80	41.5 AV	54.00	-12.50	1.00 H	63	-3.70	45.20

ANTENNA POLARITY & TEST DISTANCE: VERTICAL AT 3M

No.	Freq. (MHz)	Emission Level (dBuV/m)	Limit (dBuV/m)	Margin (dB)	Antenna Height (m)	Table Angle (Degree)	Raw Value (dBuV)	Correction Factor (dB/m)
1	*2462.00	111.7 PK			1.11 V	130	77.80	33.90
1	*2462.00	101.4 AV			1.11 V	130	67.60	33.90
2	2483.50	60.5 PK	74.00	-13.50	1.11 V	130	26.60	33.90
2	2483.50	50.2 AV	54.00	-3.80	1.11 V	130	16.30	33.90
3	7382.80	54.2 PK	74.00	-19.80	1.32 V	50	9.00	45.20
3	7382.80	43.0 AV	54.00	-11.00	1.32 V	50	-2.20	45.20

- REMARKS:**
1. Emission level(dBuV/m)=Raw Value(dBuV) + Correction Factor(dB)
 2. Correction Factor(dB/m) = Antenna Factor (dB/m) + Cable Factor (dB)
 3. The other emission levels were very low against the limit.
 4. Margin value = Emission level – Limit value.
 5. " * " : Fundamental frequency.



4.3 6dB BANDWIDTH MEASUREMENT

4.3.1 LIMITS OF 6dB BANDWIDTH MEASUREMENT

The minimum of 6dB Bandwidth Measurement is 0.5 MHz.

4.3.2 TEST INSTRUMENTS

Description & Manufacturer	Model No.	Serial No.	Calibrated Until
R&S SPECTRUM ANALYZER	FSEK30	100049	Aug. 12, 2004

NOTE: The calibration interval of the above test instruments is 12 months and the calibrations are traceable to NML/ROC and NIST/USA.

4.3.3 TEST PROCEDURE

The transmitter output was connected to the spectrum analyzer through an attenuator. The bandwidth of the fundamental frequency was measured by spectrum analyzer with 100kHz RBW and 100kHz VBW. The 6dB bandwidth is defined as the total spectrum the power of which is higher than peak power minus 6dB.

4.3.4 DEVIATION FROM TEST STANDARD

No deviation

4.3.5 TEST SETUP

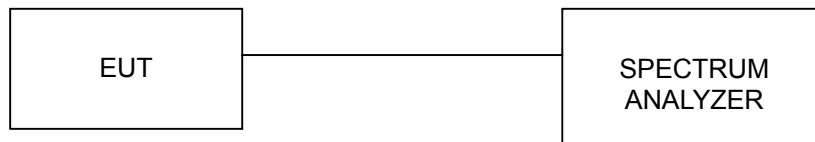

For the actual test configuration, please refer to the related Item – Photographs of the Test Configuration.

4.3.6 EUT OPERATING CONDITIONS

The software provided by client to enable the EUT under transmission condition continuously at lowest, middle and highest channel frequencies individually.



4.3.7 TEST RESULTS (A)

EUT	2.4GHz 54Mbps Wireless Router	MODEL	GL2454RT-QA
MODE	CCK	INPUT POWER (SYSTEM)	120Vac, 60 Hz
ENVIRONMENTAL CONDITIONS	26deg. C, 65%RH, 991hPa	TESTED BY	Steven Lu

CHANNEL	CHANNEL FREQUENCY (MHz)	6dB BANDWIDTH (MHz)	MINIMUM LIMIT (MHz)	PASS/FAIL
1	2412	11.32	0.5	PASS
6	2437	11.96	0.5	PASS
11	2462	11.32	0.5	PASS



CH1

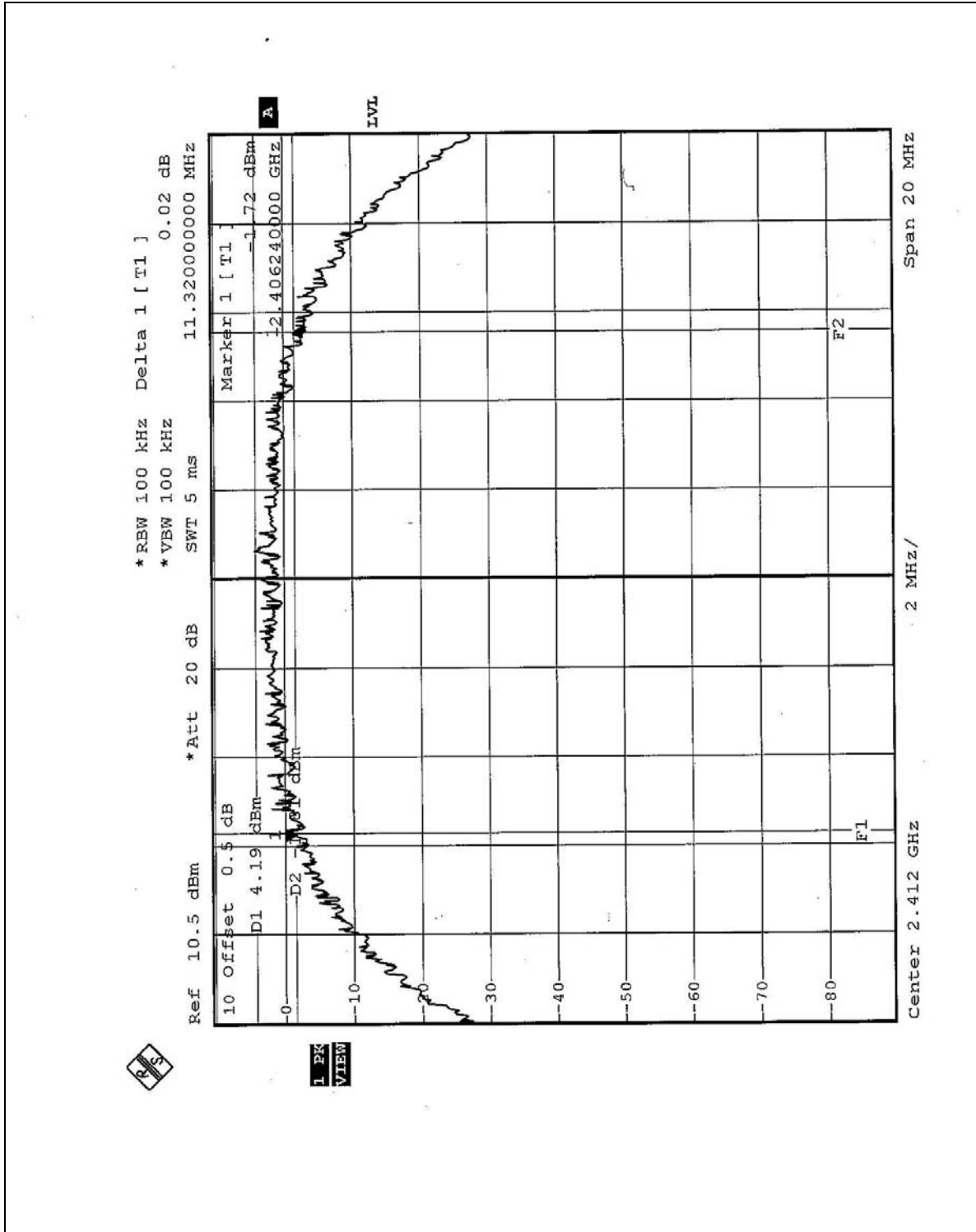



CH6

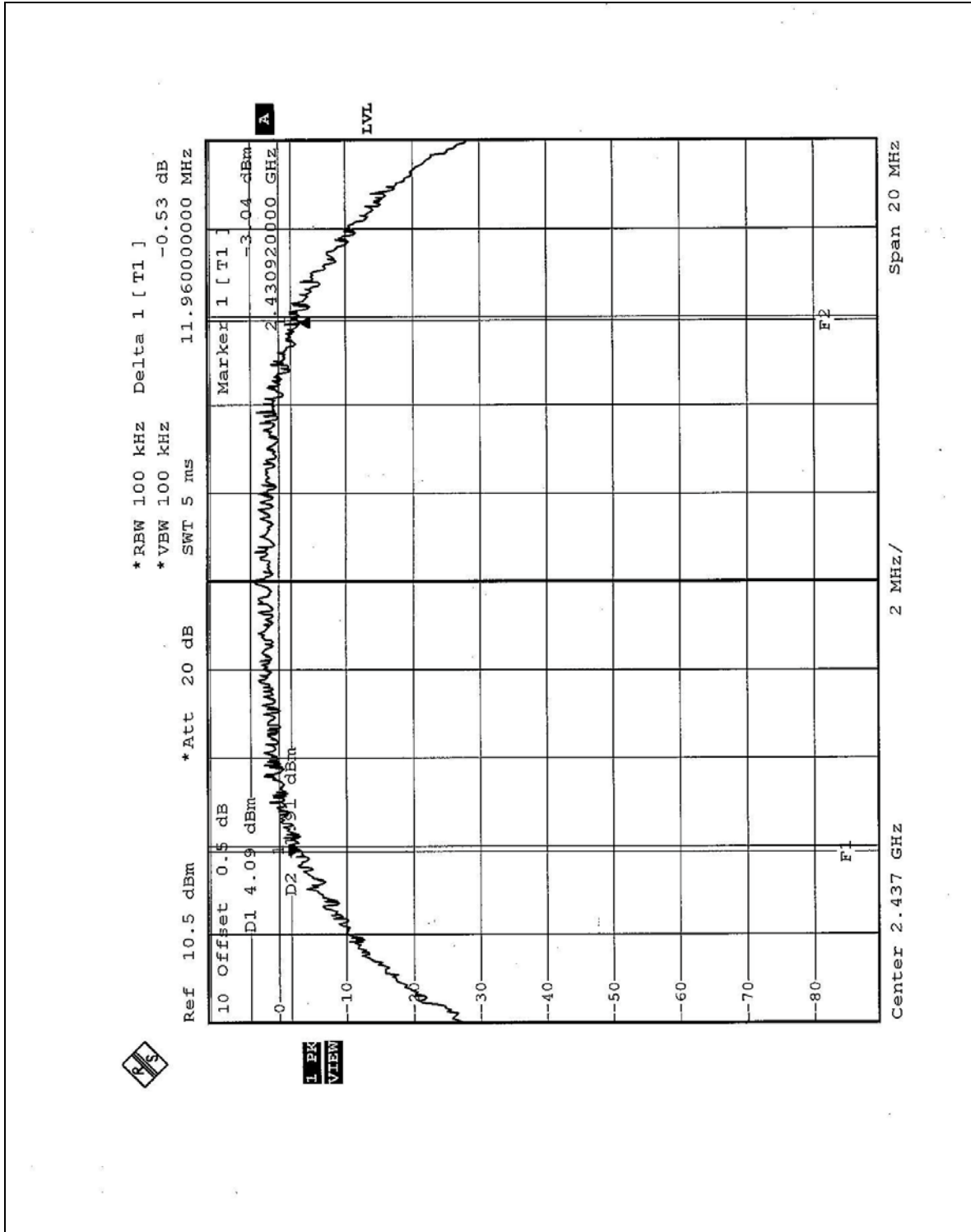



CH11

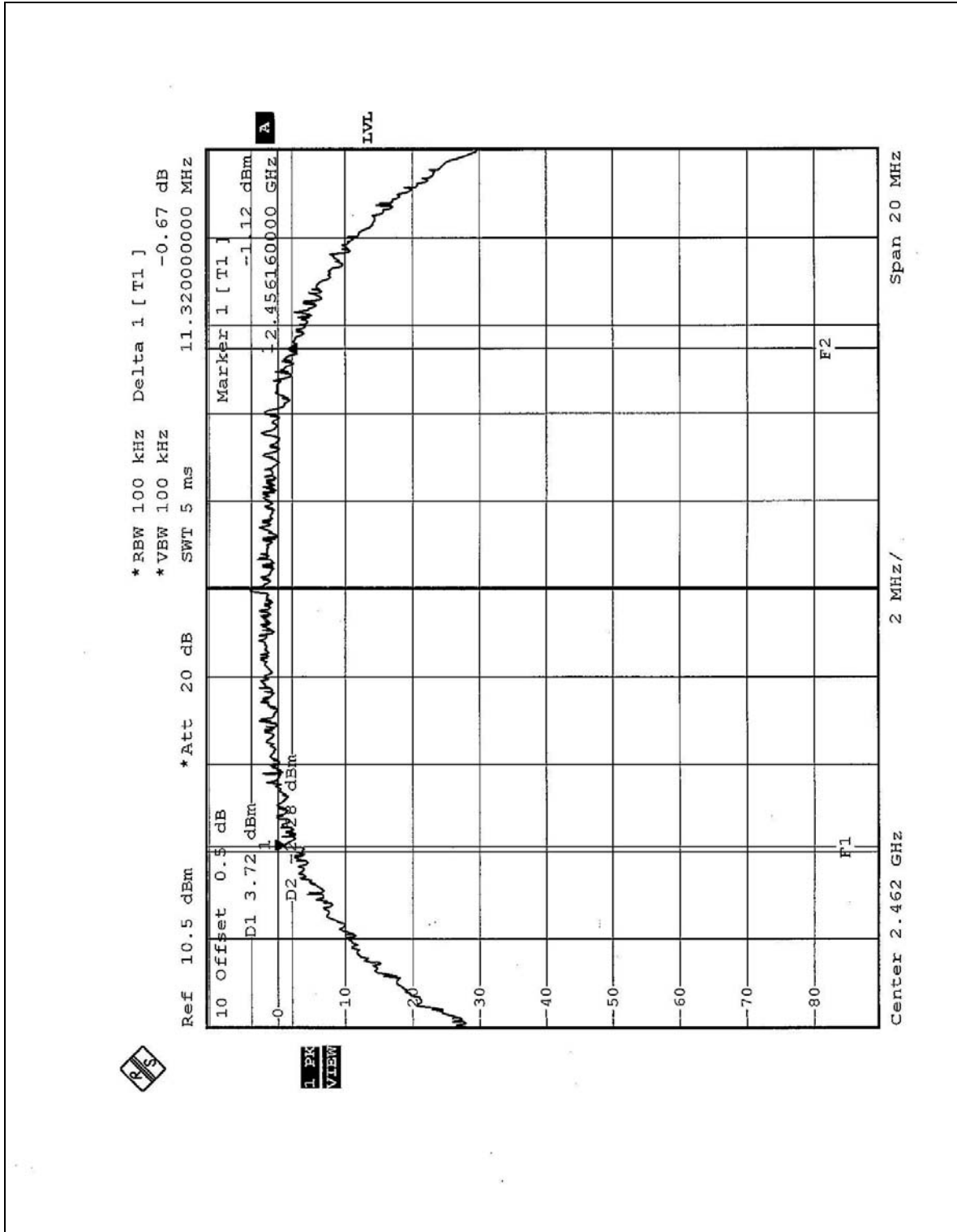



EUT	2.4GHz 54Mbps Wireless Router	MODEL	GL2454RT-QA
MODE	OFDM	INPUT POWER (SYSTEM)	120Vac, 60 Hz
ENVIRONMENTAL CONDITIONS	26deg. C, 65%RH, 991hPa	TESTED BY	Steven Lu

CHANNEL	CHANNEL FREQUENCY (MHz)	6dB BANDWIDTH (MHz)	MINIMUM LIMIT (MHz)	PASS/FAIL
1	2412	16.48	0.5	PASS
6	2437	16.48	0.5	PASS
11	2462	16.40	0.5	PASS



CH1

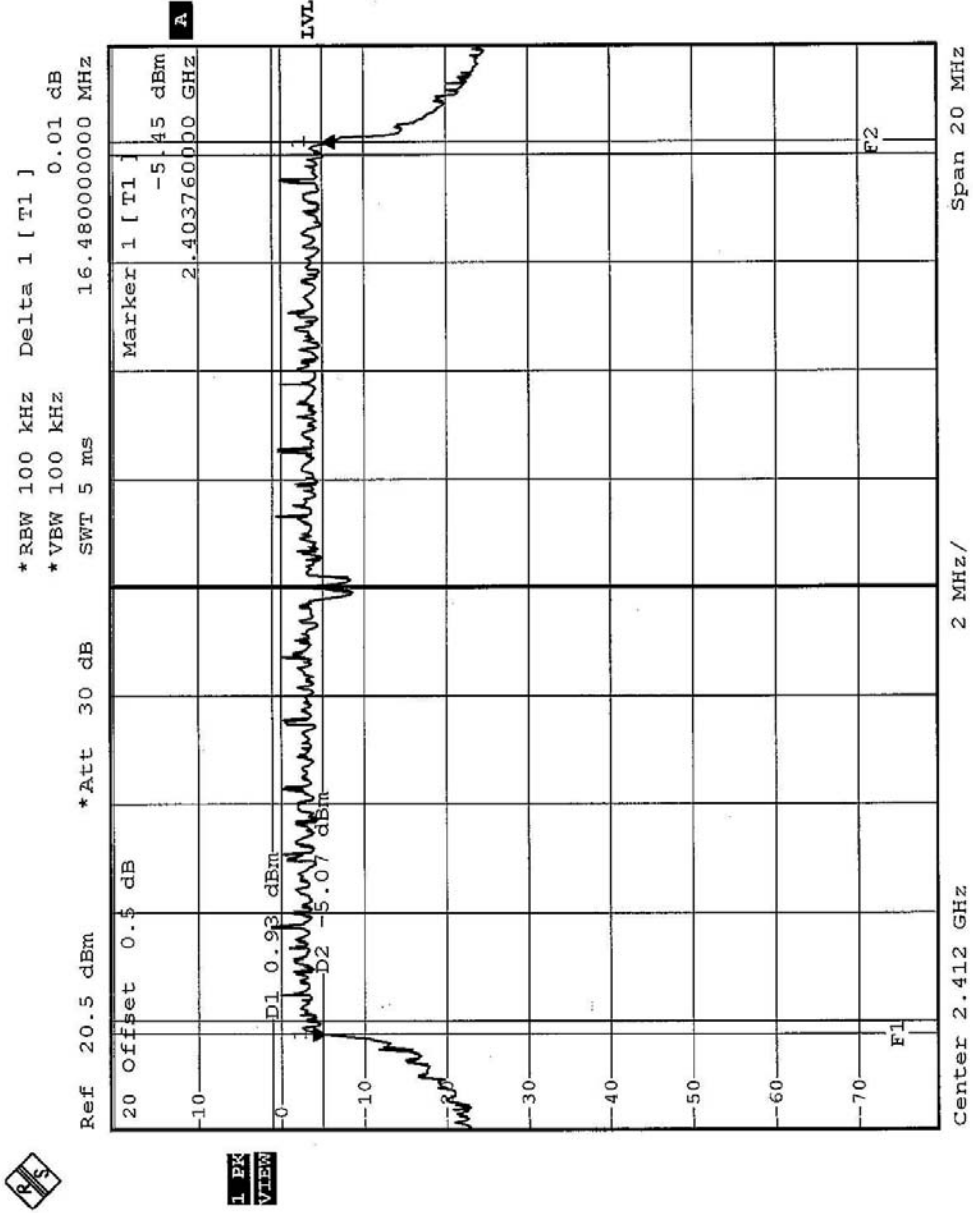

L PK VIEW





CH6

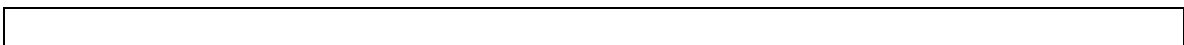
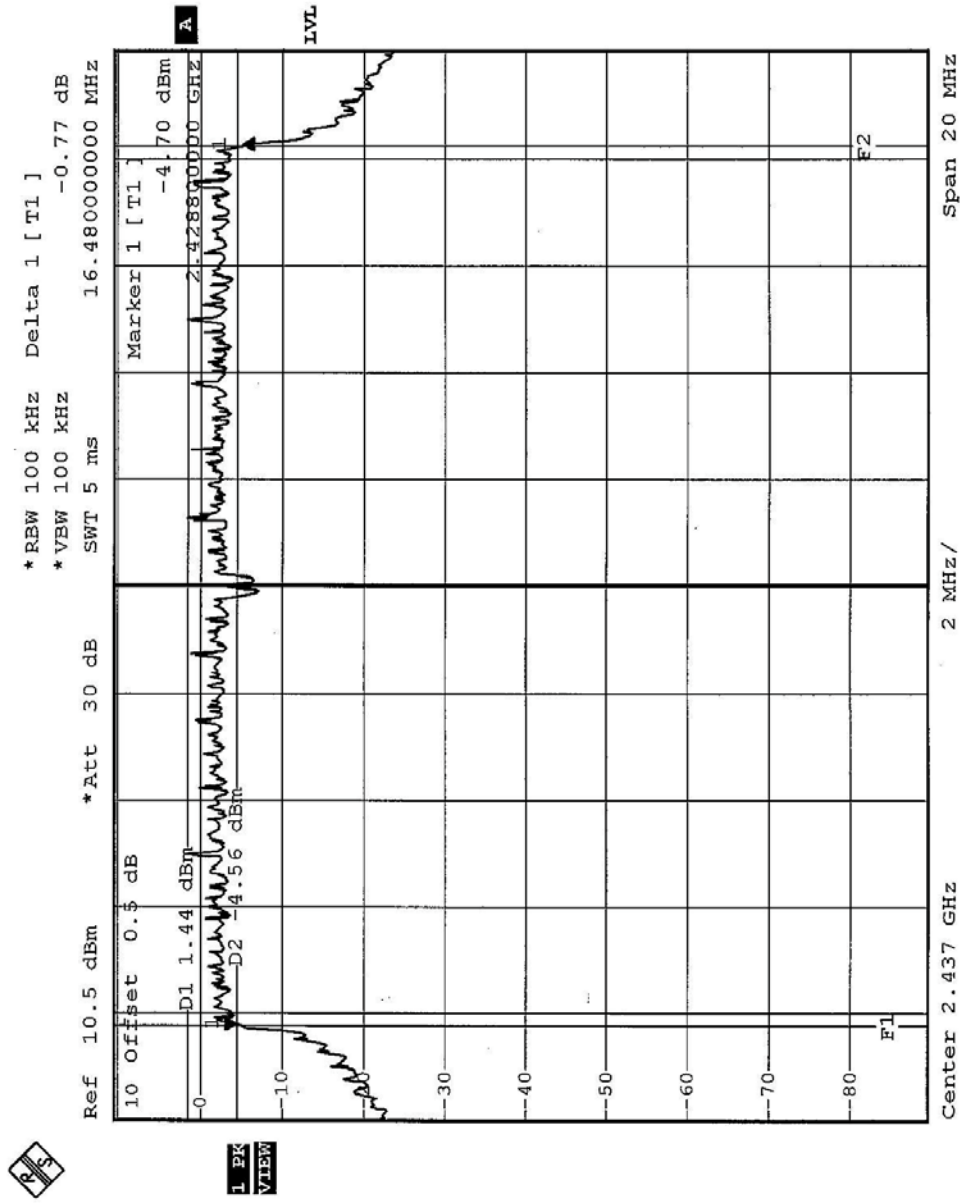



CH11

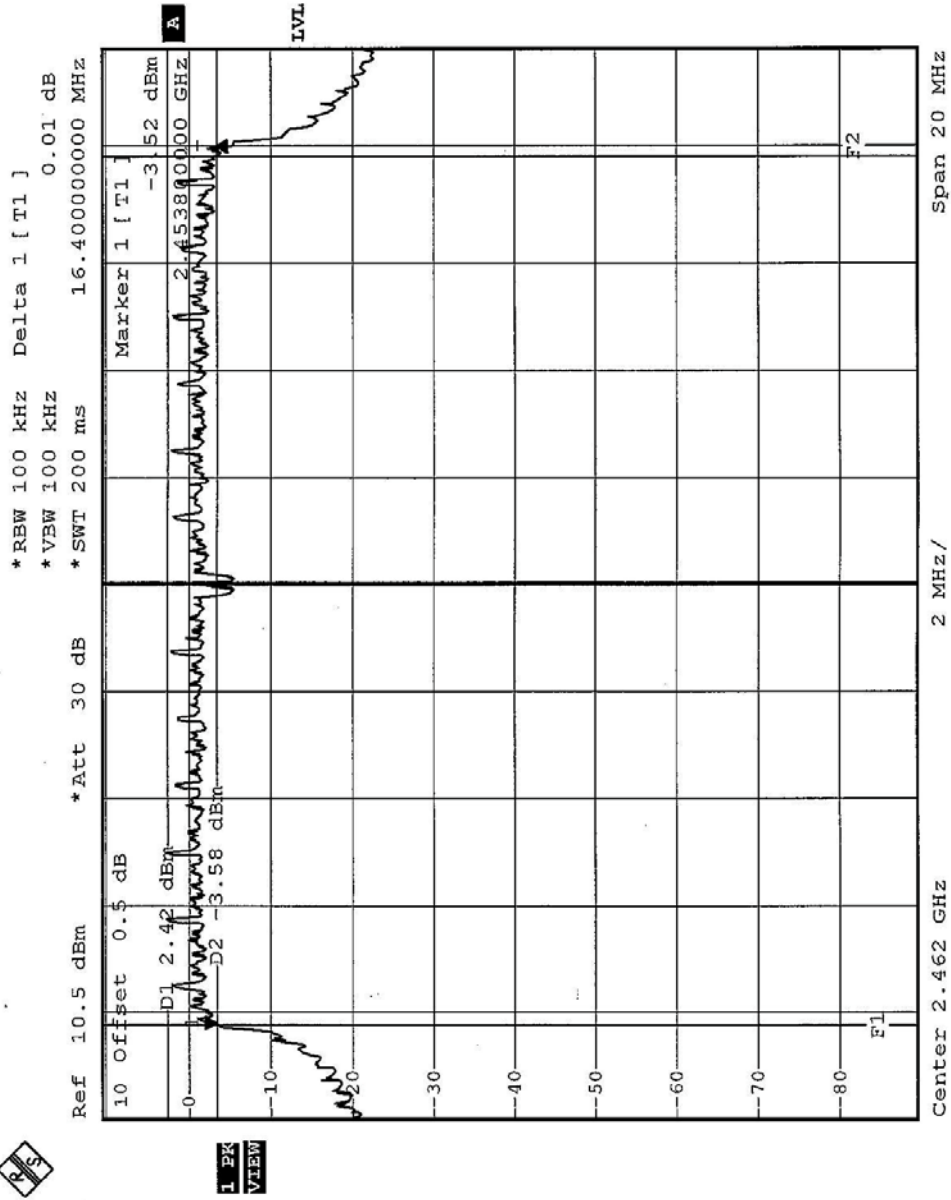



4.3.8 TEST RESULTS (B)

EUT	AT&T Plug&Share 54Mbps Wireless Router	MODEL	6800G
MODE	CCK	INPUT POWER (SYSTEM)	120Vac, 60 Hz
ENVIRONMENTAL CONDITIONS	26deg. C, 65%RH, 991hPa	TESTED BY	Jamison Chan

CHANNEL	CHANNEL FREQUENCY (MHz)	6dB BANDWIDTH (MHz)	MINIMUM LIMIT (MHz)	PASS/FAIL
1	2412	12.48	0.5	PASS
6	2437	12.72	0.5	PASS
11	2462	12.36	0.5	PASS



CH1

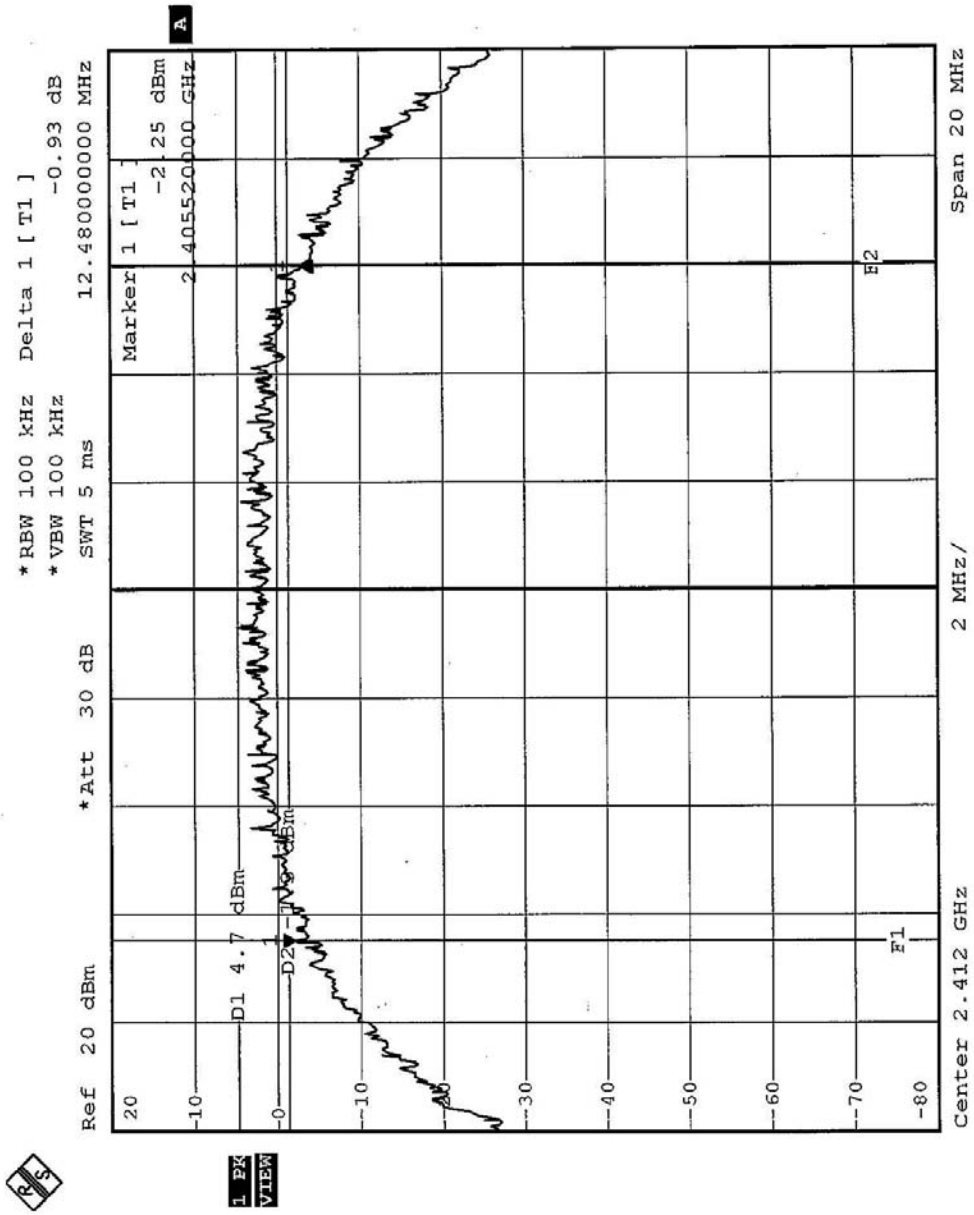



CH6

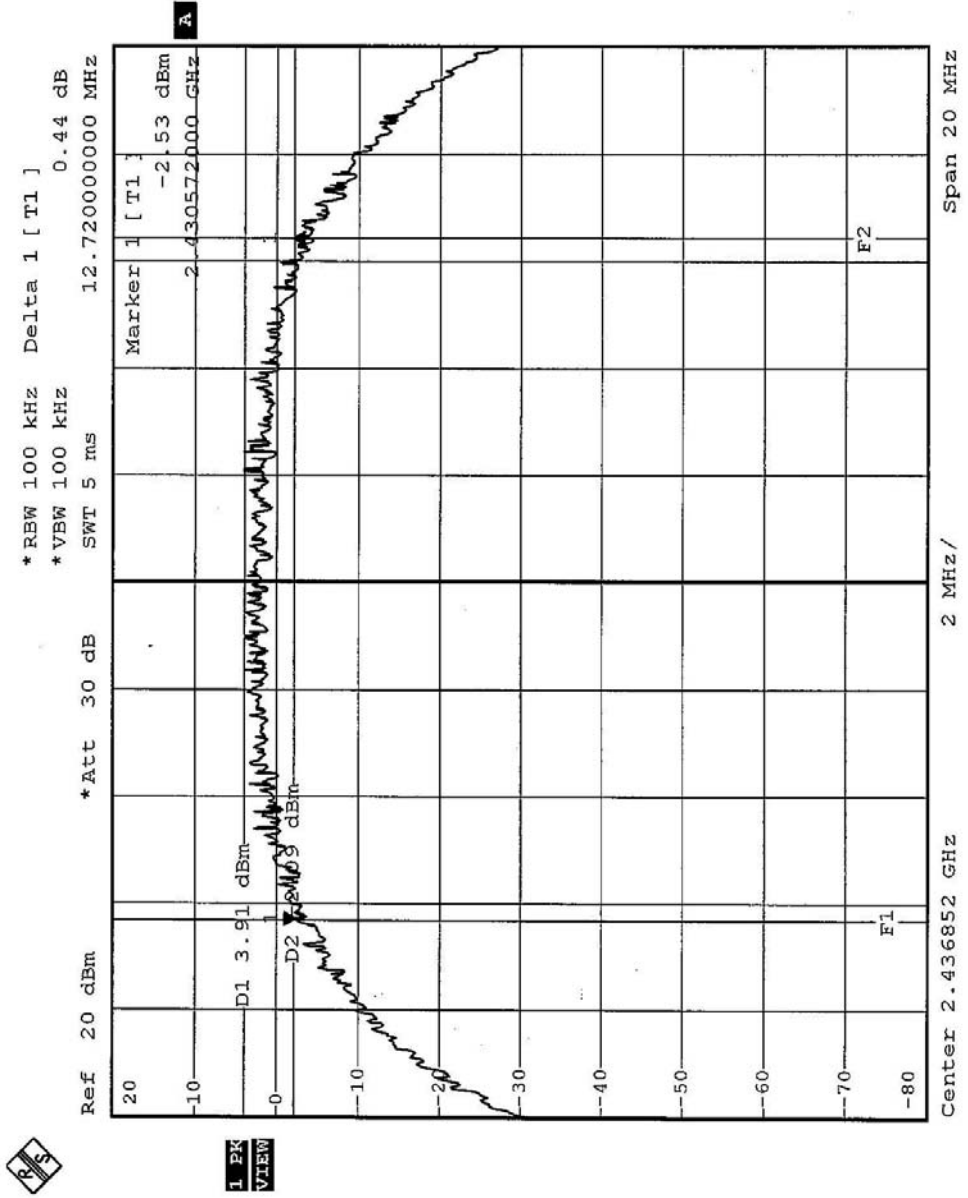



CH11

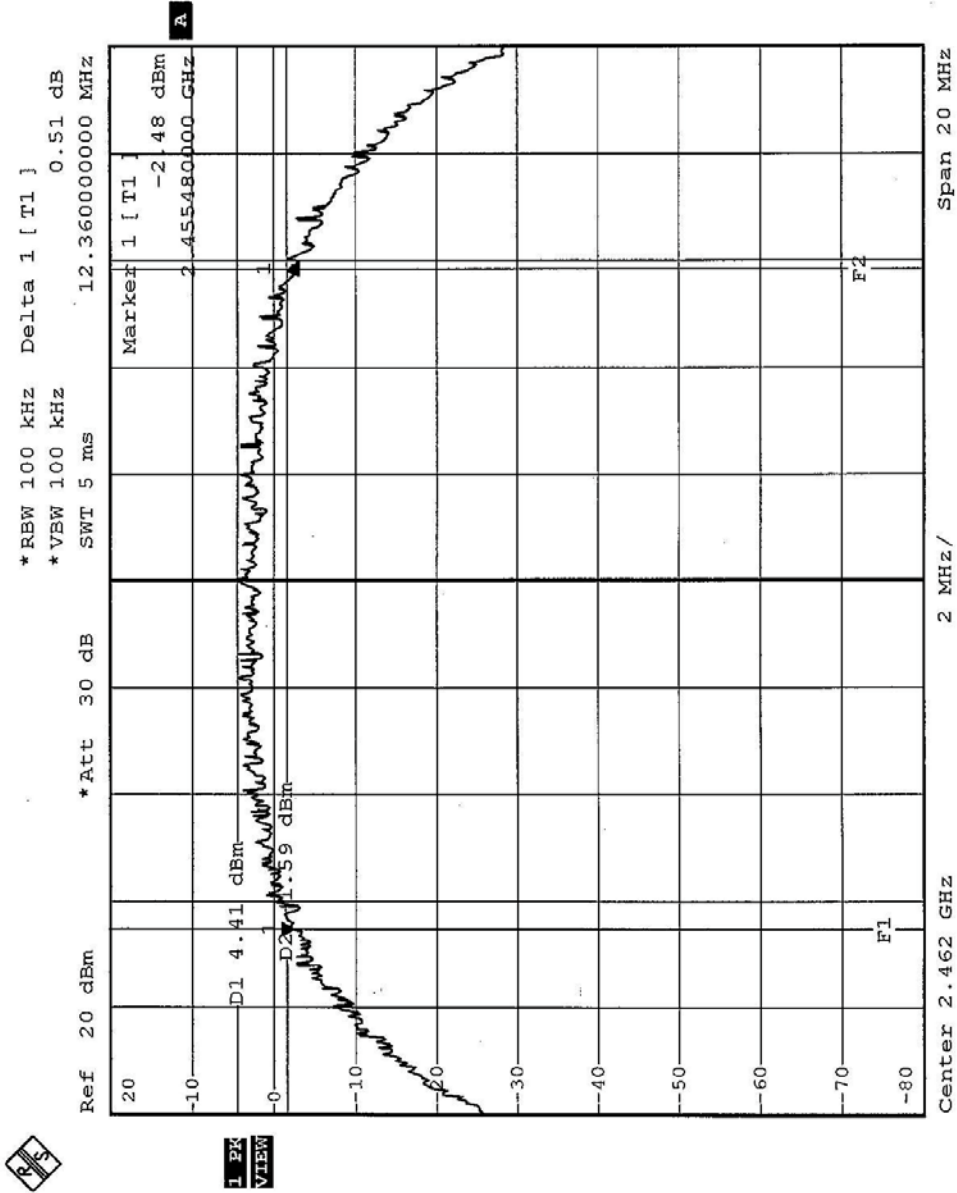



EUT	AT&T Plug&Share 54Mbps Wireless Router	MODEL	6800G
MODE	OFDM	INPUT POWER (SYSTEM)	120Vac, 60 Hz
ENVIRONMENTAL CONDITIONS	26deg. C, 65%RH, 991hPa	TESTED BY	Jamison Chan

CHANNEL	CHANNEL FREQUENCY (MHz)	6dB BANDWIDTH (MHz)	MINIMUM LIMIT (MHz)	PASS/FAIL
1	2412	16.40	0.5	PASS
6	2437	16.40	0.5	PASS
11	2462	16.44	0.5	PASS



CH1

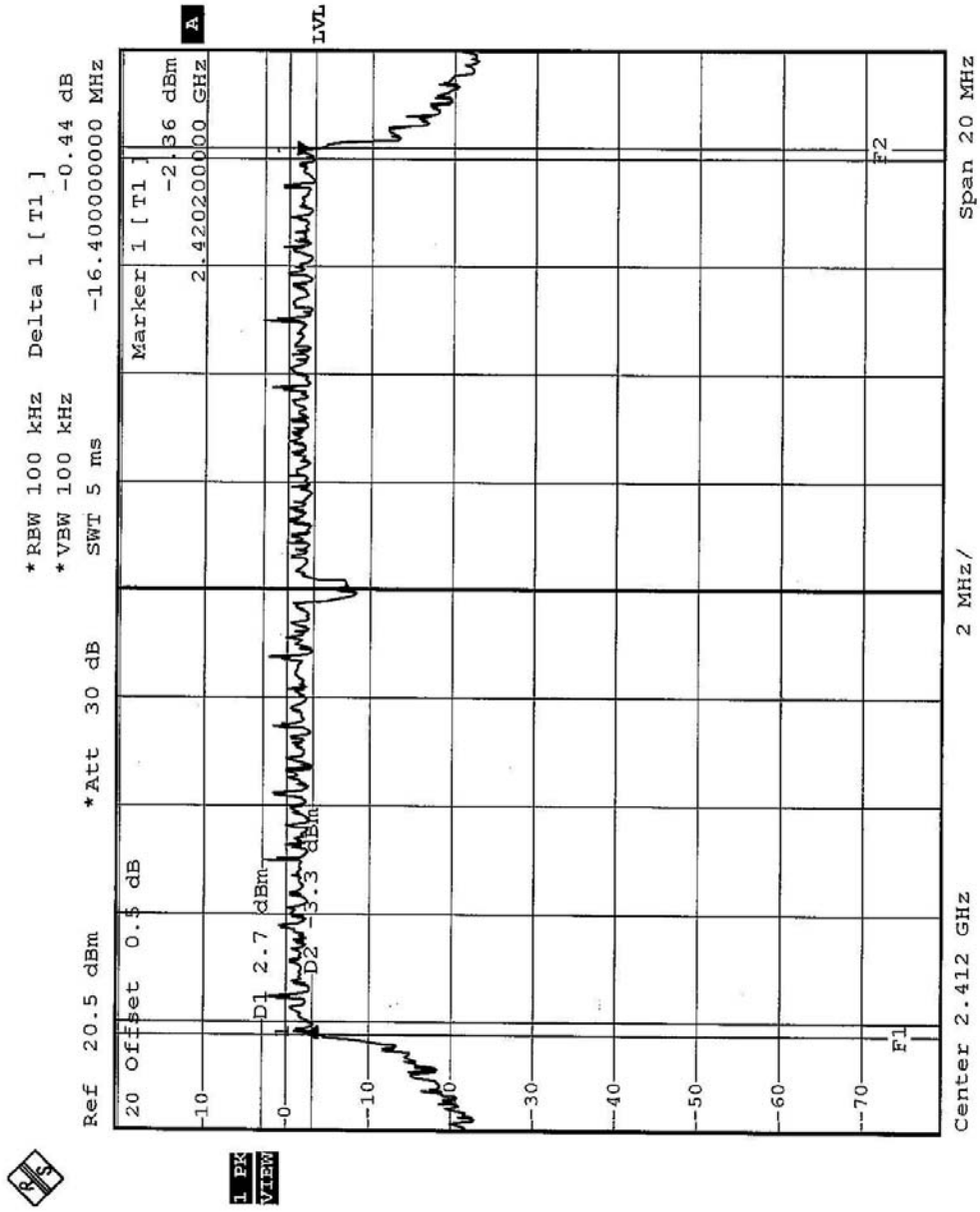



CH6

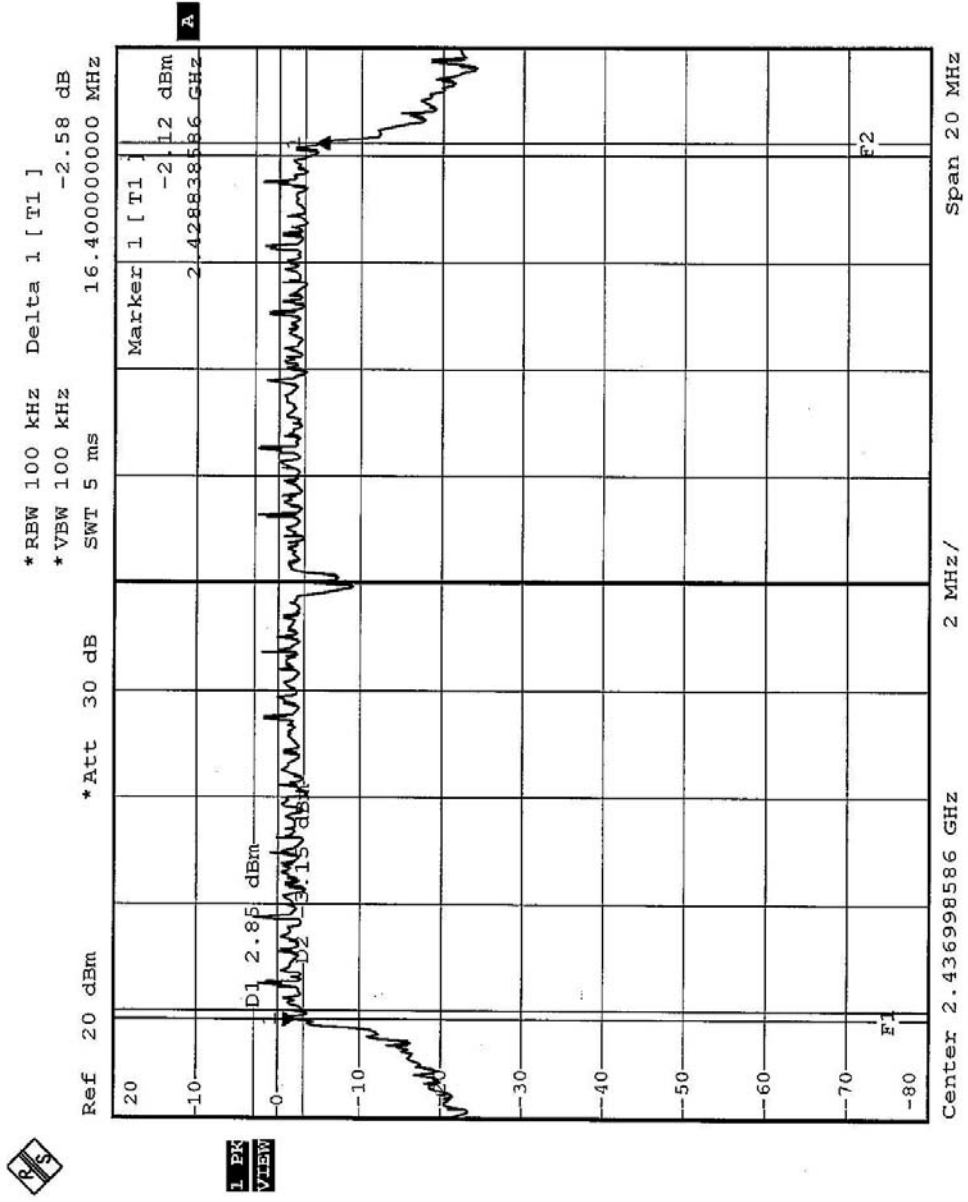

1 PK
VIEW



CH11

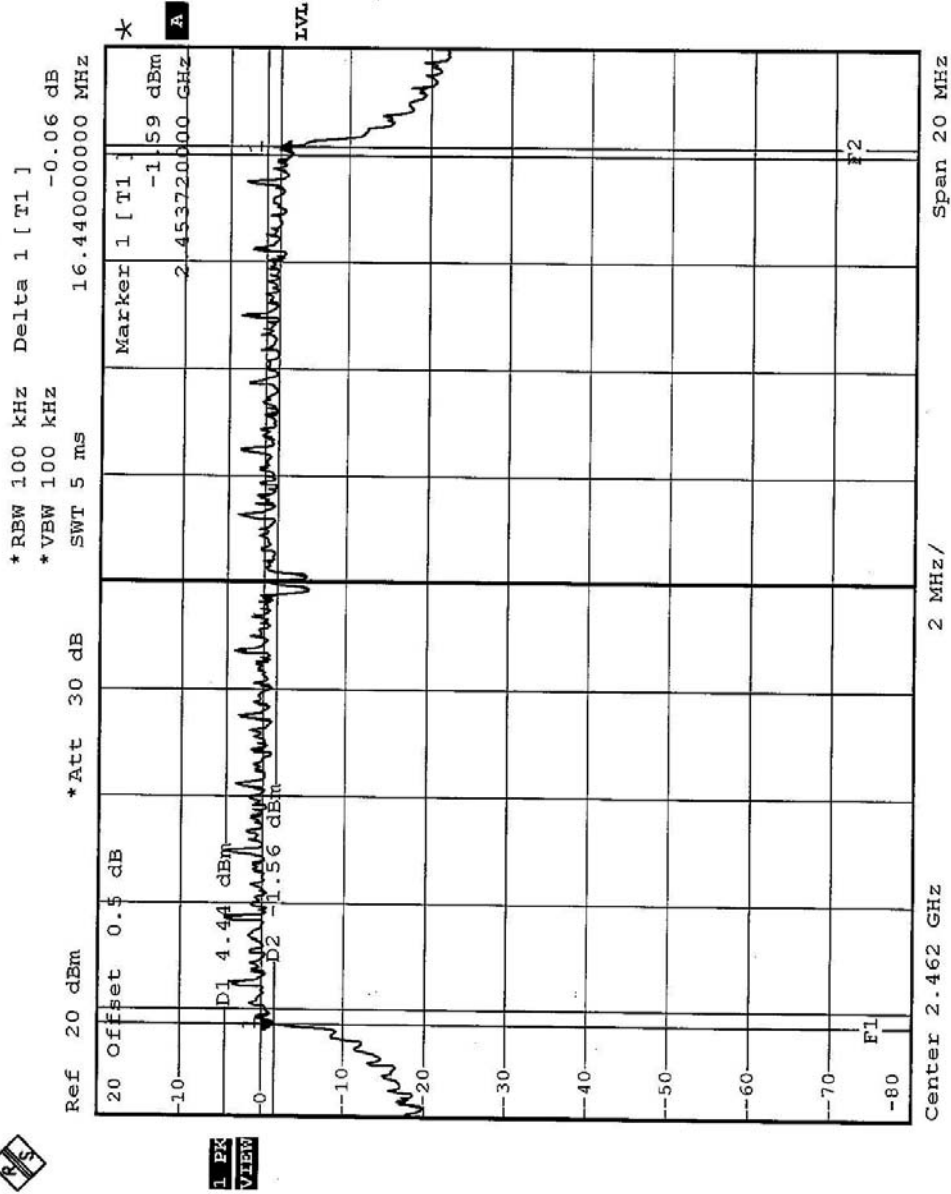



4.4 MAXIMUM PEAK OUTPUT POWER

4.4.1 LIMITS OF MAXIMUM PEAK OUTPUT POWER MEASUREMENT

The Maximum Peak Output Power Measurement is 30dBm.

4.4.2 TEST INSTRUMENTS

Description & Manufacturer	Model No.	Serial No.	Calibrated Until
R&S SPECTRUM ANALYZER	FSEK30	100049	Aug. 12, 2004
R&S SIGNAL GENERATOR	SMP04	100011	May 28, 2004
TEKTRONIX OSCILLOSCOPE	TDS 220	B048470	Mar. 05, 2004
NARDA DETECTOR	4503A	FSCM99899	NA

NOTE: The calibration interval of the above test instruments is 12 months and the calibrations are traceable to NML/ROC and NIST/USA..



4.4.3 TEST PROCEDURES

1. A detector was used on the output port of the EUT. An oscilloscope was used to read the response of the detector.
2. Replaced the EUT by the signal generator. The center frequency of the S.G was adjusted to the center frequency of the measured channel.
3. Adjusted the power to have the same reading on oscilloscope. Record the power level.

4.4.4 DEVIATION FROM TEST STANDARD

No deviation

4.4.5 TEST SETUP



4.4.6 EUT OPERATING CONDITIONS

Same as Item 4.3.6.



4.4.7 TEST RESULTS (A)

EUT	2.4GHz 54Mbps Wireless Router	MODEL	GL2454RT-QA
MODE	CCK	INPUT POWER (SYSTEM)	120Vac, 60 Hz
ENVIRONMENTAL CONDITIONS	26deg. C, 65%RH, 991hPa	TESTED BY	Steven Lu

CHANNEL	CHANNEL FREQUENCY (MHz)	PEAK POWER OUTPUT (dBm)	PEAK POWER LIMIT (dBm)	PASS/FAIL
1	2412	17.49	30	PASS
6	2437	17.54	30	PASS
11	2462	17.62	30	PASS

EUT	2.4GHz 54Mbps Wireless Router	MODEL	GL2454RT-QA
MODE	OFDM	INPUT POWER (SYSTEM)	120Vac, 60 Hz
ENVIRONMENTAL CONDITIONS	26deg. C, 65%RH, 991hPa	TESTED BY	Steven Lu

CHANNEL	CHANNEL FREQUENCY (MHz)	PEAK POWER OUTPUT (dBm)	PEAK POWER LIMIT (dBm)	PASS/FAIL
1	2412	16.56	30	PASS
6	2437	16.78	30	PASS
11	2462	16.82	30	PASS



4.4.7 TEST RESULTS (8)

EUT	AT&T Plug&Share 54Mbps Wireless Router	MODEL	6800G
MODE	CCK	INPUT POWER (SYSTEM)	120Vac, 60 Hz
ENVIRONMENTAL CONDITIONS	26deg. C, 65%RH, 991hPa	TESTED BY	Jamison Chan

CHANNEL	CHANNEL FREQUENCY (MHz)	PEAK POWER OUTPUT (dBm)	PEAK POWER LIMIT (dBm)	PASS/FAIL
1	2412	17.14	30	PASS
6	2437	17.15	30	PASS
11	2462	17.10	30	PASS

EUT	AT&T Plug&Share 54Mbps Wireless Router	MODEL	6800G
MODE	OFDM	INPUT POWER (SYSTEM)	120Vac, 60 Hz
ENVIRONMENTAL CONDITIONS	26deg. C, 65%RH, 991hPa	TESTED BY	Jamison Chan

CHANNEL	CHANNEL FREQUENCY (MHz)	PEAK POWER OUTPUT (dBm)	PEAK POWER LIMIT (dBm)	PASS/FAIL
1	2412	17.03	30	PASS
6	2437	17.00	30	PASS
11	2462	16.97	30	PASS



4.5 POWER SPECTRAL DENSITY MEASUREMENT

4.5.1 LIMITS OF POWER SPECTRAL DENSITY MEASUREMENT

The Maximum of Power Spectral Density Measurement is 8dBm.

4.5.2 TEST INSTRUMENTS

Description & Manufacturer	Model No.	Serial No.	Calibrated Until
R&S SPECTRUM ANALYZER	FSEK30	100049	Aug. 12, 2004

NOTE: The calibration interval of the above test instruments is 12 months and the calibrations are traceable to NML/ROC and NIST/USA.

4.5.3 TEST PROCEDURE

The transmitter output was connected to the spectrum analyzer through an attenuator, the bandwidth of the fundamental frequency was measured with the spectrum analyzer using 3kHz RBW and 30kHz VBW, set sweep time=span/3kHz. The power spectral density was measured and recorded. The sweep time is allowed to be longer than span/3KHz for a full response of the mixer in the spectrum analyzer.

4.5.4 DEVIATION FROM TEST STANDARD

No deviation

4.5.5 TEST SETUP

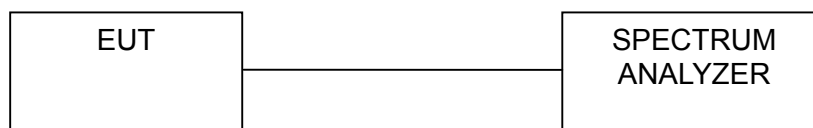

4.5.6 EUT OPERATING CONDITIONS

Same as 4.3.6



4.5.7 TEST RESULTS (A)

EUT	2.4GHz 54Mbps Wireless Router	MODEL	GL2454RT-QA
MODE	CCK	INPUT POWER (SYSTEM)	120Vac, 60 Hz
ENVIRONMENTAL CONDITIONS	26deg. C, 65%RH, 991hPa	TESTED BY	Steven Lu

CHANNEL	CHANNEL FREQUENCY (MHz)	RF POWER LEVEL IN 3 kHz BW (dBm)	MAXIMUM LIMIT (dBm)	PASS/FAIL
1	2412	-4.17	8	PASS
6	2437	-4.36	8	PASS
11	2462	-4.66	8	PASS



CH1

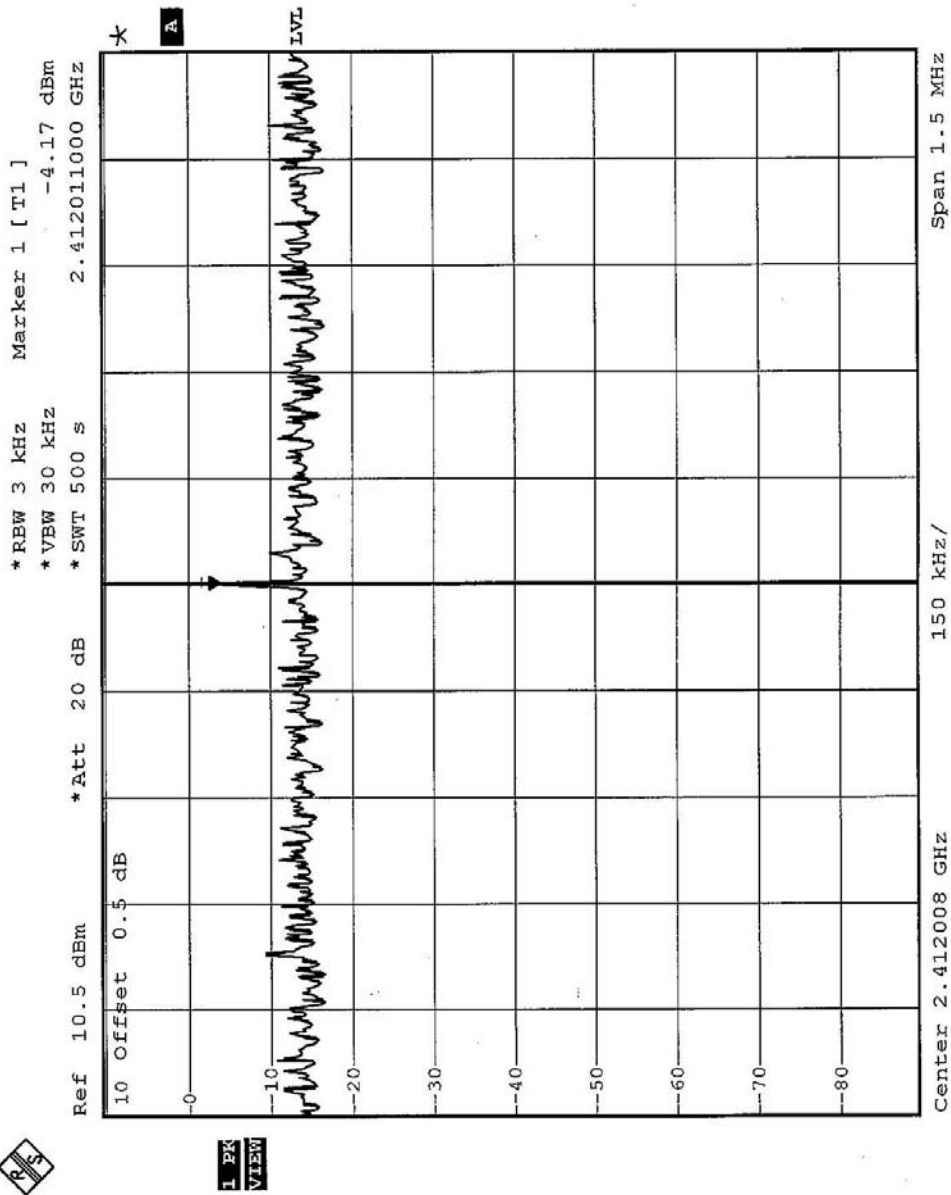



CH6

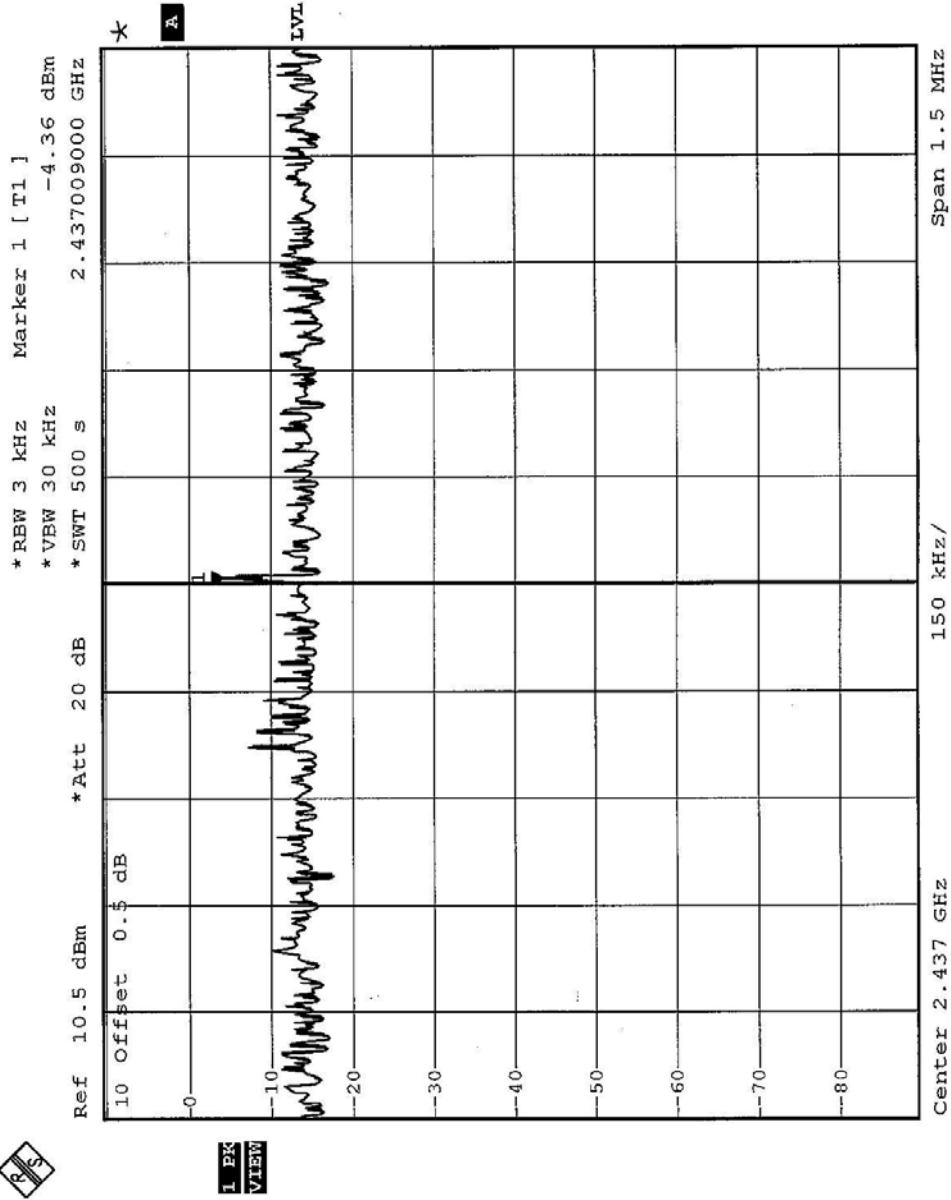



CH11

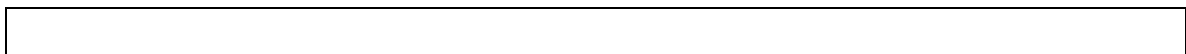
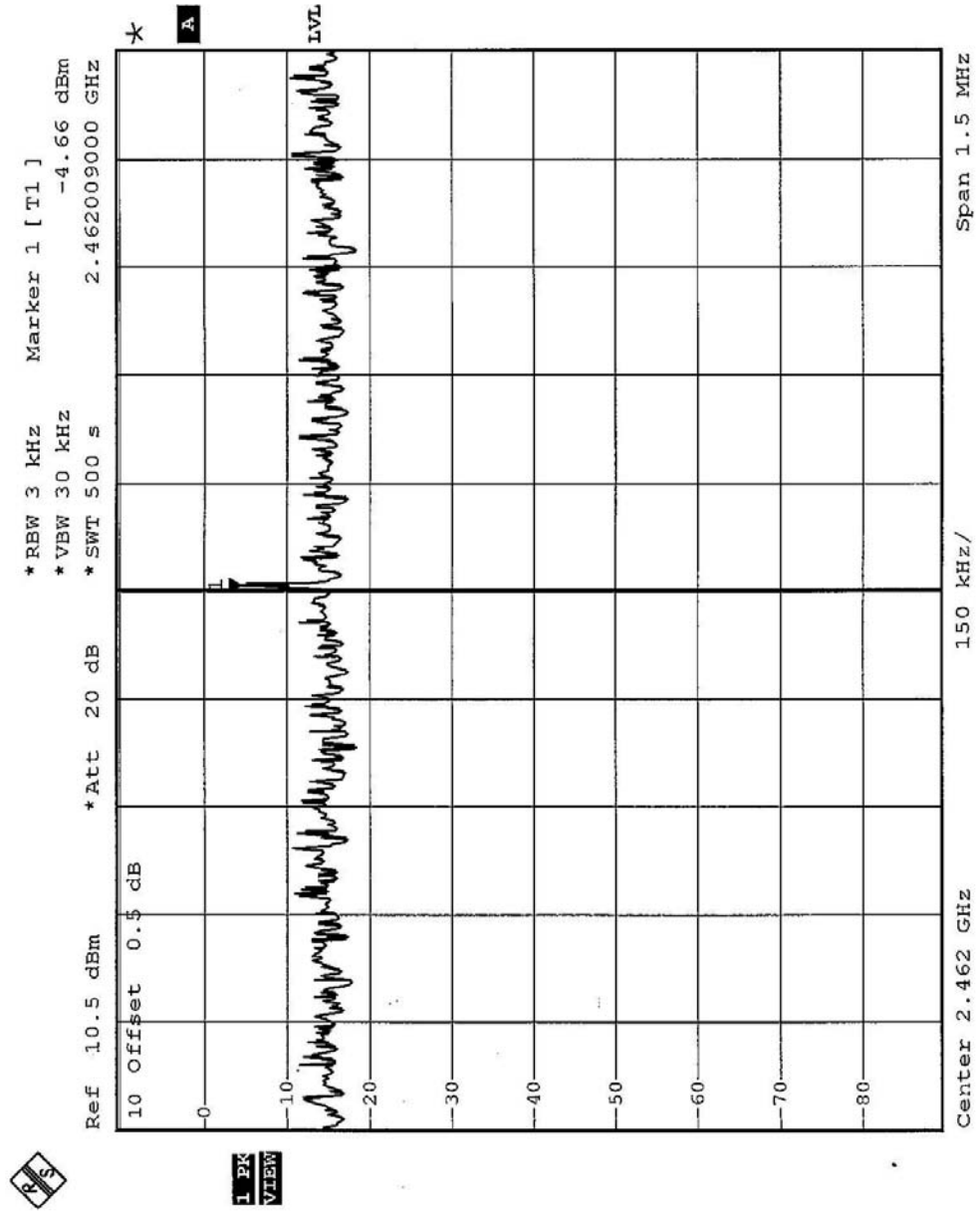



EUT	2.4GHz 54Mbps Wireless Router	MODEL	GL2454RT-QA
MODE	OFDM	INPUT POWER (SYSTEM)	120Vac, 60 Hz
ENVIRONMENTAL CONDITIONS	26deg. C, 65%RH, 991hPa	TESTED BY	Steven Lu

CHANNEL	CHANNEL FREQUENCY (MHz)	RF POWER LEVEL IN 3 kHz BW (dBm)	MAXIMUM LIMIT (dBm)	PASS/FAIL
1	2412	-7.23	8	PASS
6	2437	-6.40	8	PASS
11	2462	-5.63	8	PASS



CH1

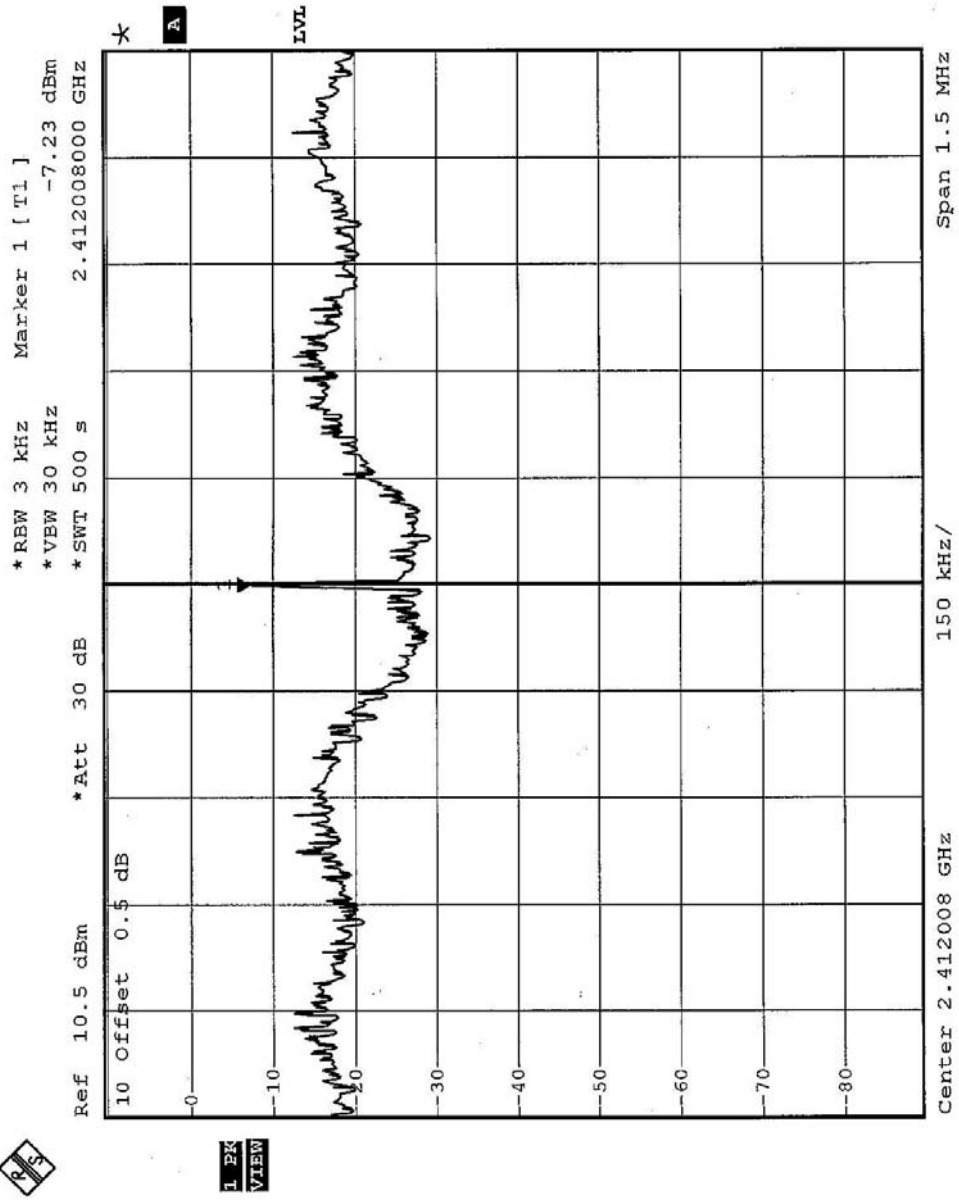



CH6

