



# FCC TEST REPORT

**REPORT NO.:** RF921114R03A  
**MODEL NO.:** GL2454RT-NM (for Brand: GLOBAL SUN)  
**OEM MODEL NO.:** WLL-3810M (for Brand: ORIGO)  
WRT-411 (for Brand: PLANET)  
**RECEIVED:** NA  
**TESTED:** Nov. 13 ~ Nov. 25, 2003

**APPLICANT:** GLOBAL SUN TECHNOLOGY INC.

**ADDRESS:** NO.13 Tung Yuan Rd., Jung Li Industrial Park  
Jung Li City, Tao Yuan Hsien, Taiwan

**ISSUED BY:** Advance Data Technology Corporation

**LAB LOCATION:** 47 14th Lin, Chiapau Tsun, Linko, Taipei,  
Taiwan, R.O.C.

This test report consists of 64 pages in total. It may be duplicated completely for legal use with the approval of the applicant. It should not be reproduced except in full, without the written approval of our laboratory. The client should not use it to claim product endorsement by CNLA, NVLAP or any government agencies. The test results in the report only apply to the tested sample.



0528  
ILAC MRA



Lab Code: 200102-0



## Table of Contents

|       |   |    |
|-------|---|----|
| 1     | CERTIFICATION .....                                   | 4  |
| 2     | SUMMARY OF TEST RESULTS .....                         | 5  |
| 3     | GENERAL INFORMATION .....                             | 6  |
| 3.1   | GENERAL DESCRIPTION OF EUT .....                      | 6  |
| 3.2   | DESCRIPTION OF TEST MODES .....                       | 7  |
| 3.3   | GENERAL DESCRIPTION OF APPLIED STANDARDS .....        | 7  |
| 3.4   | DESCRIPTION OF SUPPORT UNITS .....                    | 8  |
| 3.5   | CONFIGURATION OF SYSTEM UNDER TEST .....              | 9  |
| 4     | TEST TYPES AND RESULTS .....                          | 10 |
| 4.1   | CONDUCTED EMISSION MEASUREMENT .....                  | 10 |
| 4.1.1 | LIMITS OF CONDUCTED EMISSION MEASUREMENT .....        | 10 |
| 4.1.2 | TEST INSTRUMENTS .....                                | 10 |
| 4.1.3 | TEST PROCEDURES .....                                 | 11 |
| 4.1.4 | DEVIATION FROM TEST STANDARD .....                    | 11 |
| 4.1.5 | TEST SETUP .....                                      | 12 |
| 4.1.6 | EUT OPERATING CONDITIONS .....                        | 13 |
| 4.1.7 | TEST RESULTS .....                                    | 14 |
| 4.2   | RADIATED EMISSION MEASUREMENT .....                   | 20 |
| 4.2.1 | LIMITS OF RADIATED EMISSION MEASUREMENT .....         | 20 |
| 4.2.2 | TEST INSTRUMENTS .....                                | 21 |
| 4.2.3 | TEST PROCEDURES .....                                 | 22 |
| 4.2.4 | DEVIATION FROM TEST STANDARD .....                    | 22 |
| 4.2.5 | TEST SETUP .....                                      | 23 |
| 4.2.6 | EUT OPERATING CONDITIONS .....                        | 23 |
| 4.2.7 | TEST RESULTS .....                                    | 24 |
| 4.3   | 6dB BANDWIDTH MEASUREMENT .....                       | 32 |
| 4.3.1 | LIMITS OF 6dB BANDWIDTH MEASUREMENT .....             | 32 |
| 4.3.2 | TEST INSTRUMENTS .....                                | 32 |
| 4.3.3 | TEST PROCEDURE .....                                  | 32 |
| 4.3.4 | DEVIATION FROM TEST STANDARD .....                    | 32 |
| 4.3.5 | TEST SETUP .....                                      | 33 |
| 4.3.6 | EUT OPERATING CONDITIONS .....                        | 33 |
| 4.3.7 | TEST RESULTS .....                                    | 34 |
| 4.4   | MAXIMUM PEAK OUTPUT POWER .....                       | 42 |
| 4.4.1 | LIMITS OF MAXIMUM PEAK OUTPUT POWER MEASUREMENT ..... | 42 |
| 4.4.2 | TEST INSTRUMENTS .....                                | 42 |
| 4.4.3 | TEST PROCEDURES .....                                 | 43 |
| 4.4.4 | DEVIATION FROM TEST STANDARD .....                    | 43 |



|       |  |    |
|-------|--|----|
| 4.4.5 | TEST SETUP .....                                   | 43 |
| 4.4.6 | EUT OPERATING CONDITIONS .....                     | 43 |
| 4.4.7 | TEST RESULTS .....                                 | 44 |
| 4.5   | POWER SPECTRAL DENSITY MEASUREMENT .....           | 45 |
| 4.5.1 | LIMITS OF POWER SPECTRAL DENSITY MEASUREMENT ..... | 45 |
| 4.5.2 | TEST INSTRUMENTS .....                             | 45 |
| 4.5.3 | TEST PROCEDURE .....                               | 46 |
| 4.5.4 | DEVIATION FROM TEST STANDARD .....                 | 46 |
| 4.5.5 | TEST SETUP .....                                   | 46 |
| 4.5.6 | EUT OPERATING CONDITIONS .....                     | 46 |
| 4.5.7 | TEST RESULTS .....                                 | 47 |
| 4.6   | BAND EDGES MEASUREMENT .....                       | 55 |
| 4.6.1 | LIMITS OF BAND EDGES MEASUREMENT .....             | 55 |
| 4.6.2 | TEST INSTRUMENTS .....                             | 55 |
| 4.6.3 | TEST PROCEDURE .....                               | 55 |
| 4.6.4 | DEVIATION FROM TEST STANDARD .....                 | 55 |
| 4.6.5 | EUT OPERATING CONDITION .....                      | 56 |
| 4.6.6 | TEST RESULTS .....                                 | 56 |
| 4.7   | ANTENNA REQUIREMENT .....                          | 61 |
| 4.7.1 | STANDARD APPLICABLE .....                          | 61 |
| 4.7.2 | ANTENNA CONNECTED CONSTRUCTION .....               | 61 |
| 5     | PHOTOGRAPHS OF THE TEST CONFIGURATION .....        | 62 |
| 6     | INFORMATION ON THE TESTING LABORATORIES .....      | 64 |



# 1 CERTIFICATION

**PRODUCT NAME :** 802.11g Wireless Lan Router  
**MODEL NO.:** GL2454RT-NM (for Brand: GLOBAL SUN)  
**OEM MODEL NO.:** WLL-3810M (for Brand: ORIGO)  
WRT-411 (for Brand: PLANET)  
**APPLICANT :** GLOBAL SUN TECHNOLOGY INC.  
**TEST ITEM :** ENGINEERING SAMPLE  
**STANDARDS :** 47 CFR Part 15, Subpart C (Section 15.247),  
ANSI C63.4-1992

We, **Advance Data Technology Corporation**, hereby certify that one sample of the designation have been tested in our facility from Nov. 13 to Nov. 25, 2003. The test record, data evaluation and Equipment Under Test (EUT) configurations represented herein are true and accurate accounts of the measurements of the sample's EMC characteristics under the conditions herein specified.

**PREPARED BY:** Windy Chou , **DATE:** Nov. 27, 2003

**APPROVED BY:** Ellis Wu , **DATE:** Nov. 27, 2003  
Ellis Wu, Manager



## 2 SUMMARY OF TEST RESULTS

The EUT has been tested according to the following specifications:

| APPLIED STANDARD: 47 CFR Part 15, Subpart C |   |        |  |
|---|---|--------|--|
| Standard Section                            | Test Type and Limit   | Result | REMARK   |
| 15.207                                      | AC Power Conducted Emission   | PASS   | Meet the requirement of limit<br>Minimum passing margin is -21.81dB at 0.267MHz  |
| 15.247(a)(2)                                | Spectrum Bandwidth of a Direct Sequence Spread Spectrum System. Limit: min. 500kHz  | PASS   | Meet the requirement of limit  |
| 15.247(b)                                   | Maximum Peak Output Power Limit: max. 30dBm   | PASS   | Meet the requirement of limit  |
| 15.247(c)                                   | Transmitter Radiated Emissions Limit: Table 15.209                                  | PASS   | Meet the requirement of limit<br>Minimum passing margin is -1.30dB at 2560.00MHz |
| 15.247(d)                                   | Power Spectral Density Limit: max. 8dBm   | PASS   | Meet the requirement of limit  |
| 15.247(c)                                   | Band Edge Measurement Limit: 20dB less than the peak value of fundamental frequency | PASS   | Meet the requirement of limit  |

**Note:** The information of measurement uncertainty is available upon the customer's request.



### 3 GENERAL INFORMATION

#### 3.1 GENERAL DESCRIPTION OF EUT

|                           |   |
|---------------------------|---|
| <b>PRODUCT NAME</b>       | 802.11g Wireless Lan Router                                 |
| <b>MODEL NO.:</b>         | GL2454RT-NM (for Brand: GLOBAL SUN)                         |
| <b>OEM MODEL NO.:</b>     | WLL-3810M (for Brand: ORIGO)<br>WRT-411 (for Brand: PLANET) |
| <b>POWER SUPPLY</b>       | 5VDC from power adapter                                     |
| <b>MODULATION TYPE</b>    | BPSK, QPSK, CCK, 16QAM, 64QAM                               |
| <b>RADIO TECHNOLOGY</b>   | DSSS, OFDM  |
| <b>TRANSFER RATE</b>      | 1/2/5.5/6/9/11/12/18/24/36/48/54Mbps                        |
| <b>FREQUENCY RANGE</b>    | 2412MHz ~ 2462MHz   |
| <b>NUMBER OF CHANNEL</b>  | 11  |
| <b>OUTPUT POWER</b>       | 19.42dBm  |
| <b>ANTENNA TYPE</b>       | Dipole antenna with 2dBi gain                               |
| <b>DATA CABLE</b>         | NA  |
| <b>I/O PORTS</b>          | RJ45  |
| <b>ASSOCIATED DEVICES</b> | NA  |

**NOTE:**

1. The EUT was tested with the following adapter:

|                 |                           |
|-----------------|---------------------------|
| <b>BRAND :</b>  | FAIRWAY                   |
| <b>MODEL :</b>  | WN10A-050U                |
| <b>INPUT :</b>  | 100-240V-1.0A MAX 50-60Hz |
| <b>OUTPUT :</b> | +5.0V--2.5A               |

2. This is a duplicate report of RF921114R03, the only difference are the model no., brand name and enclosure shape.
3. The EUT operates in the 2.4GHz frequency spectrum and compatible with the draft 802.11g standard to provide a wireless data rate of up to 54Mbps.
4. For more detailed features description, please refer to the manufacturer's specifications or User's Manual.



### 3.2 DESCRIPTION OF TEST MODES

Eleven channels are provided to this EUT.

| Channel | Frequency | Channel | Frequency |
|---------|-----------|---------|-----------|
| 1       | 2412 MHz  | 7       | 2442 MHz  |
| 2       | 2417 MHz  | 8       | 2447 MHz  |
| 3       | 2422 MHz  | 9       | 2452 MHz  |
| 4       | 2427 MHz  | 10      | 2457 MHz  |
| 5       | 2432 MHz  | 11      | 2462 MHz  |
| 6       | 2437 MHz  |         |           |

**NOTE:**

1. Below 1GHz, the channel 1, 6, and 11 were pre-tested in chamber. The channel 11, the worst case, was chosen for final test.
2. Above 1GHz, the channel 1, 6, and 11 were tested individually.
3. Transfer rate at 11Mbps with CCK technique and 6Mbps with OFDM technique, worst cases, were chosen for final test.

### 3.3 GENERAL DESCRIPTION OF APPLIED STANDARDS

The EUT is a 802.11g Wireless Lan Router. According to the specifications of the manufacturer, it must comply with the requirements of the following standards:

**FCC 47 CFR Part 15, Subpart C. (15.247)**  
**ANSI C63.4: 2001**

All test items have been performed and recorded as per the above standards.

**NOTE:** The EUT is also considered as a kind of computer peripheral, because the connection to computer is necessary for typical use. It has been verified to comply with the requirements of FCC Part 15, Subpart B, Class B (DoC). The test report has been issued separately.



### 3.4 DESCRIPTION OF SUPPORT UNITS

The EUT has been tested as an independent unit together with other necessary accessories or support units. The following support units or accessories were used to form a representative test configuration during the tests.

| NO. | PRODUCT  | BRAND  | MODEL NO. | SERIAL NO.               | FCC ID           |
|-----|----------|--------|-----------|--------------------------|------------------|
| 1   | Notebook | Dell   | PP01L     | TW-09C748-12800-16M-5064 | FCC DoC Approved |
| 2   | MODEM    | ACEEX  | 1414      | 980020503                | IFAXDM1414       |
| 3   | PRINTER  | EPSON  | LQ-300+   | DCGY017096               | FCC DoC Approved |
| 4   | Notebook | Compaq | N800C     | 470048-515               | FCC DoC Approved |

| NO. | SIGNAL CABLE DESCRIPTION OF THE ABOVE SUPPORT UNITS   |
|-----|---|
| 1   | NA  |
| 2   | 1.2 m braid shielded wire, terminated with DB25 and DB9 connector via metallic frame, w/o core.       |
| 3   | 1.2m braid shielded wire, terminated with DB25 and Centronics connector via metallic frame, w/o core. |
| 4   | NA  |

**NOTE:** All power cords of the above support units are non shielded (1.8m).





### 3.5 CONFIGURATION OF SYSTEM UNDER TEST

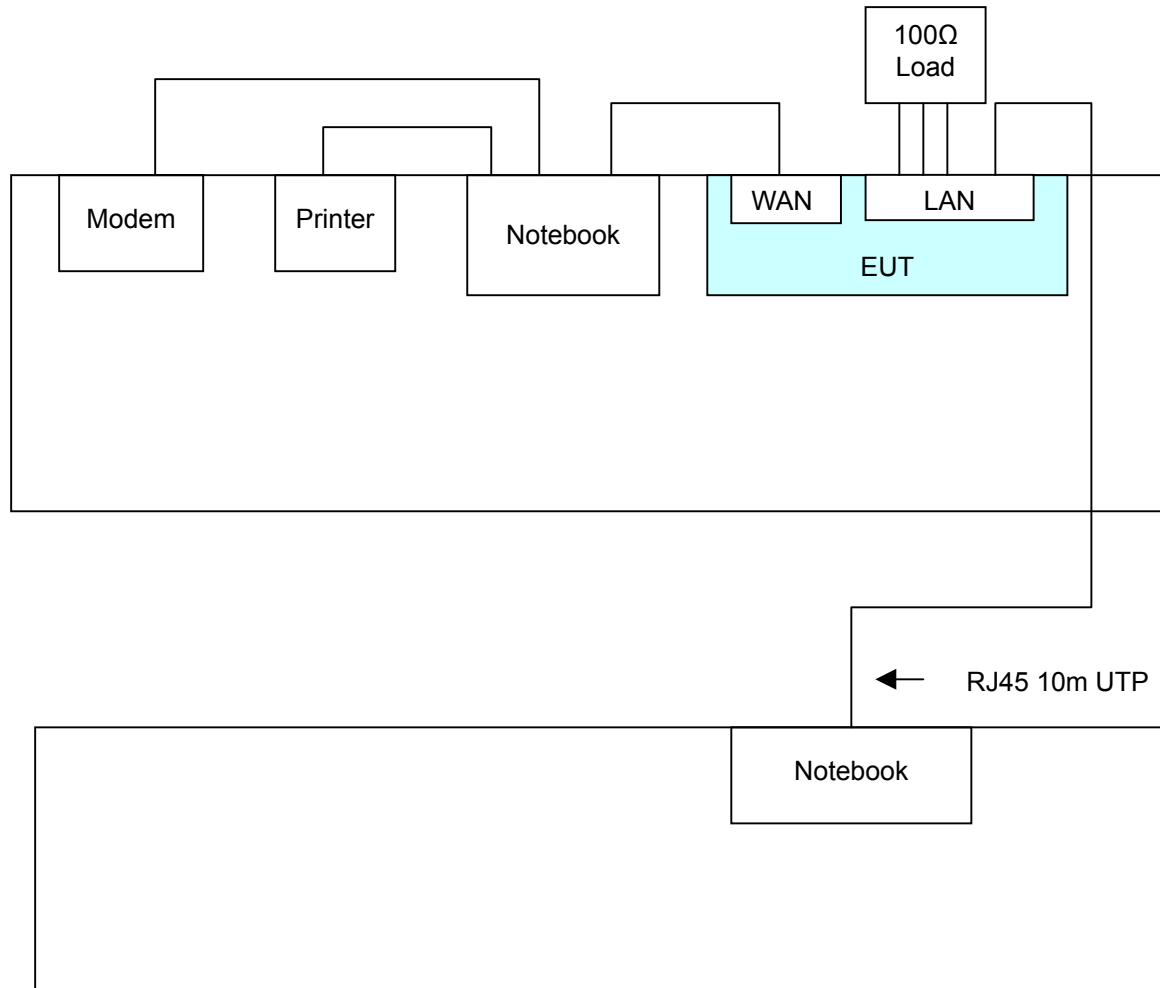



## 4 TEST TYPES AND RESULTS

### 4.1 CONDUCTED EMISSION MEASUREMENT

#### 4.1.1 LIMITS OF CONDUCTED EMISSION MEASUREMENT

| FREQUENCY OF EMISSION (MHz) | CONDUCTED LIMIT (dB $\mu$ V) |          |
|-----------------------------|------------------------------|----------|
|                             | Quasi-peak                   | Average  |
| 0.15-0.5                    | 66 to 56                     | 56 to 46 |
| 0.5-5                       | 56                           | 46       |
| 5-30                        | 60                           | 50       |

- NOTE:**
1. The lower limit shall apply at the transition frequencies.
  2. The limit decreases in line with the logarithm of the frequency in the range of 0.15 to 0.50 MHz.
  3. All emanations from a class A/B digital device or system, including any network of conductors and apparatus connected thereto, shall not exceed the level of field strengths specified above.

#### 4.1.2 TEST INSTRUMENTS

| DESCRIPTION & MANUFACTURER                                 | MODEL NO.  | SERIAL NO.   | CALIBRATED UNTIL |
|--|------------|--------------|------------------|
| ROHDE & SCHWARZ Test Receiver                              | ESCS 30    | 838251/021   | Jan. 20, 2004    |
| ROHDE & SCHWARZ Artificial Mains Network (for EUT)         | ESH3-Z5    | 100218       | Dec. 18, 2003    |
| ROHDE & SCHWARZ Artificial Mains Network (for peripherals) | ESH3-Z5    | 100219       | Dec. 18, 2003    |
| ROHDE & SCHWARZ Artificial Mains Network (for peripherals) | ESH3-Z5    | 100220       | Dec. 18, 2003    |
| *ROHDE & SCHWARZ 4-wire ISN                                | ENY41      | 837032/016   | Nov. 29 2003     |
| *ROHDE & SCHWARZ 2-wire ISN                                | ENY22      | 837497/016   | Nov. 29 2003     |
| Software   | Cond-V2M3  | NA           | NA               |
| RF cable (JYEBAO)  | 5D-FB      | Cable-C10.01 | May 01, 2004     |
| SUHNTER Terminator (For ROHDE & SCHWARZ LISN)              | 65BNC-5001 | E1-010770    | Mar. 24, 2004    |
| SUHNTER Terminator (For ROHDE & SCHWARZ LISN)              | 65BNC-5001 | E1-010773    | Apr. 06, 2004    |

- NOTE:**
1. The calibration interval of the above test instruments is 12 months and the calibrations are traceable to NML/ROC and NIST/USA.
  2. "\*": These equipment are used for conducted telecom port test only (if tested).
  3. The test was performed in ADT Shielded Room No. 10.
  4. The VCCI Site Registration No. is C-1312.



#### 4.1.3 TEST PROCEDURES

- a. The EUT was placed 0.4 meters from the conducting wall of the shielded room with EUT being connected to the power mains through a line impedance stabilization network (LISN). Other support units were connected to the power mains through another LISN. The two LISNs provide 50 ohm/ 50uH of coupling impedance for the measuring instrument.
- b. Both lines of the power mains connected to the EUT were checked for maximum conducted interference.
- c. The frequency range from 150kHz to 30MHz was searched. Emission levels over 10dB under the prescribed limits could not be reported

#### 4.1.4 DEVIATION FROM TEST STANDARD

No deviation

4.1.5 TEST SETUP

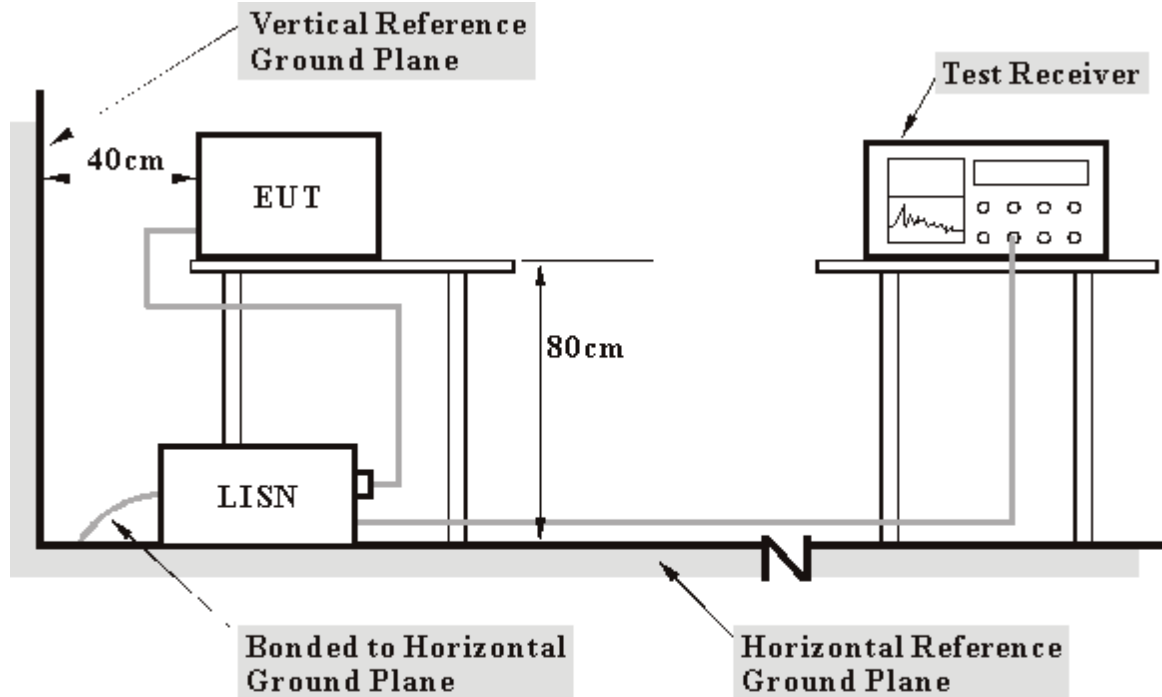

- Note:** 1. Support units were connected to second LISN.  
 2. Both of LISNs (AMN) 80 cm from EUT and at the least 80 cm from other units and other metal planes support units.

For the actual test configuration, please refer to the related item – Photographs of the Test Configuration.



#### 4.1.6 EUT OPERATING CONDITIONS

- a. Placed the EUT on the testing table.
- b. The computer system sent data to EUT by command "PING" via RJ45 cable.
- c. The computer system sent "H" messages to Color Monitor and Monitor displayed "H" patterns on its screen.
- d. The computer system sent "H" messages to modem.
- e. The computer system sent "H" messages to the printer, and the printer prints them on paper.
- f. Prepared another computer system to act as a communication partner and placed it outside of testing area.
- g. The communication partner ran a test program to enable EUT under transmission/receiving condition continuously at specific channel frequency via RJ45 cable.
- h. The communication partner sent data to EUT by command "PING".



4.1.7 TEST RESULTS

|                                 |                             |                             |             |
|---------------------------------|-----------------------------|-----------------------------|-------------|
| <b>EUT</b>                      | 802.11g Wireless Lan Router | <b>MODEL</b>                | GL2454RT-NM |
| <b>CHANNEL</b>                  | Channel 1                   | <b>6dB BANDWIDTH</b>        | 9kHz        |
| <b>INPUT POWER (SYSTEM)</b>     | 120Vac, 60 Hz               | <b>PHASE</b>                | Line (L)    |
| <b>ENVIRONMENTAL CONDITIONS</b> | 23deg.C, 62%RH, 991hPa      | <b>TESTED BY:</b> Steven Lu |             |

| No | Freq.<br>[MHz] | Corr.<br>Factor<br>(dB) | Reading Value |     | Emission Level |     | Limit     |       | Margin |     |
|----|----------------|-------------------------|---------------|-----|----------------|-----|-----------|-------|--------|-----|
|    |                |                         | [dB (uV)]     |     | [dB (uV)]      |     | [dB (uV)] |       | (dB)   |     |
|    |                |                         | Q.P.          | AV. | Q.P.           | AV. | Q.P.      | AV.   | Q.P.   | AV. |
| 1  | 0.271          | 0.06                    | 37.01         | -   | 37.07          | -   | 61.08     | 51.08 | -24.01 | -   |
| 2  | 0.939          | 0.15                    | 29.06         | -   | 29.21          | -   | 56.00     | 46.00 | -26.79 | -   |
| 3  | 1.621          | 0.17                    | 31.31         | -   | 31.48          | -   | 56.00     | 46.00 | -24.52 | -   |
| 4  | 1.869          | 0.18                    | 29.72         | -   | 29.90          | -   | 56.00     | 46.00 | -26.10 | -   |
| 5  | 16.227         | 0.58                    | 35.54         | -   | 36.12          | -   | 60.00     | 50.00 | -23.88 | -   |
| 6  | 19.707         | 0.64                    | 34.57         | -   | 35.21          | -   | 60.00     | 50.00 | -24.79 | -   |

- REMARKS:**
1. Q.P. and AV. are abbreviations of quasi-peak and average individually.
  2. "-": The Quasi-peak reading value also meets average limit and measurement with the average detector is unnecessary.
  3. The emission levels of other frequencies were very low against the limit.
  4. Margin value = Emission level - Limit value
  5. Correction factor = Insertion loss + Cable loss
  6. Emission Level = Correction Factor + Reading Value.

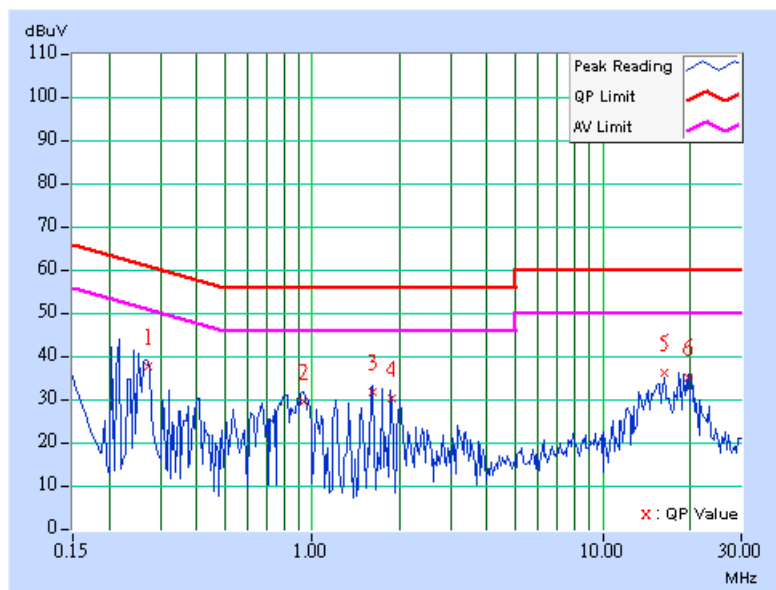



|                                 |                             |                             |             |
|---------------------------------|-----------------------------|-----------------------------|-------------|
| <b>EUT</b>                      | 802.11g Wireless Lan Router | <b>MODEL</b>                | GL2454RT-NM |
| <b>CHANNEL</b>                  | Channel 1                   | <b>6dB BANDWIDTH</b>        | 9kHz        |
| <b>INPUT POWER (SYSTEM)</b>     | 120Vac, 60 Hz               | <b>PHASE</b>                | Neutral (N) |
| <b>ENVIRONMENTAL CONDITIONS</b> | 23deg.C, 62%RH, 991hPa      | <b>TESTED BY:</b> Steven Lu |             |

| No | Freq.<br>[MHz] | Corr.<br>Factor<br>(dB) | Reading Value |     | Emission Level |     | Limit     |       | Margin |     |
|----|----------------|-------------------------|---------------|-----|----------------|-----|-----------|-------|--------|-----|
|    |                |                         | [dB (uV)]     |     | [dB (uV)]      |     | [dB (uV)] |       | (dB)   |     |
|    |                |                         | Q.P.          | AV. | Q.P.           | AV. | Q.P.      | AV.   | Q.P.   | AV. |
| 1  | 0.263          | 0.05                    | 39.07         | -   | 39.12          | -   | 61.32     | 51.32 | -22.20 | -   |
| 2  | 0.935          | 0.15                    | 30.70         | -   | 30.85          | -   | 56.00     | 46.00 | -25.15 | -   |
| 3  | 1.332          | 0.17                    | 32.25         | -   | 32.42          | -   | 56.00     | 46.00 | -23.58 | -   |
| 4  | 2.012          | 0.18                    | 26.34         | -   | 26.52          | -   | 56.00     | 46.00 | -29.48 | -   |
| 5  | 16.227         | 0.49                    | 35.30         | -   | 35.79          | -   | 60.00     | 50.00 | -24.21 | -   |
| 6  | 19.707         | 0.51                    | 34.54         | -   | 35.05          | -   | 60.00     | 50.00 | -24.95 | -   |

- REMARKS:**
1. Q.P. and AV. are abbreviations of quasi-peak and average individually.
  2. "-": The Quasi-peak reading value also meets average limit and measurement with the average detector is unnecessary.
  3. The emission levels of other frequencies were very low against the limit.
  4. Margin value = Emission level - Limit value
  5. Correction factor = Insertion loss + Cable loss
  6. Emission Level = Correction Factor + Reading Value.

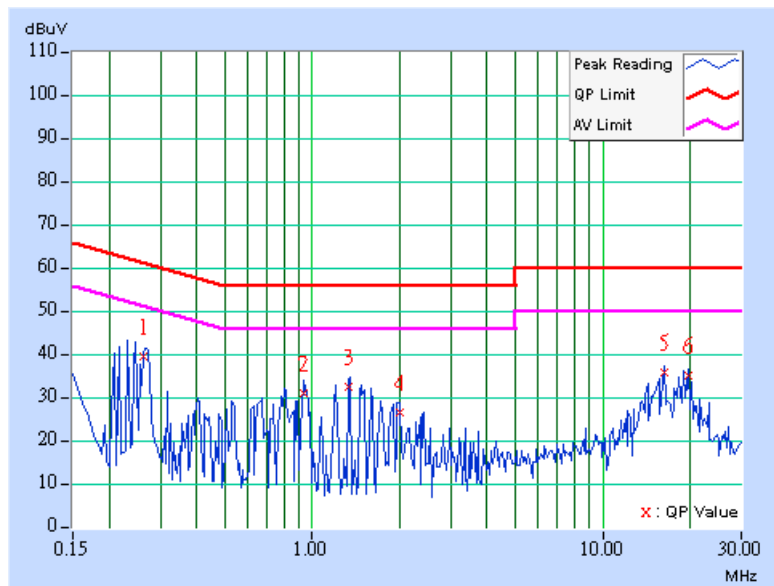



|                                 |                             |                             |             |
|---------------------------------|-----------------------------|-----------------------------|-------------|
| <b>EUT</b>                      | 802.11g Wireless Lan Router | <b>MODEL</b>                | GL2454RT-NM |
| <b>CHANNEL</b>                  | Channel 6                   | <b>6dB BANDWIDTH</b>        | 9kHz        |
| <b>INPUT POWER (SYSTEM)</b>     | 120Vac, 60 Hz               | <b>PHASE</b>                | Line (L)    |
| <b>ENVIRONMENTAL CONDITIONS</b> | 23deg.C, 62%RH, 991hPa      | <b>TESTED BY:</b> Steven Lu |             |

| No | Freq.<br>[MHz] | Corr.<br>Factor<br>(dB) | Reading Value |     | Emission Level |     | Limit     |       | Margin |     |
|----|----------------|-------------------------|---------------|-----|----------------|-----|-----------|-------|--------|-----|
|    |                |                         | [dB (uV)]     |     | [dB (uV)]      |     | [dB (uV)] |       | (dB)   |     |
|    |                |                         | Q.P.          | AV. | Q.P.           | AV. | Q.P.      | AV.   | Q.P.   | AV. |
| 1  | 0.267          | 0.06                    | 37.25         | -   | 37.31          | -   | 61.20     | 51.20 | -23.89 | -   |
| 2  | 0.404          | 0.06                    | 24.62         | -   | 24.68          | -   | 57.77     | 47.77 | -33.09 | -   |
| 3  | 0.939          | 0.15                    | 29.97         | -   | 30.12          | -   | 56.00     | 46.00 | -25.88 | -   |
| 4  | 1.605          | 0.17                    | 30.10         | -   | 30.27          | -   | 56.00     | 46.00 | -25.73 | -   |
| 5  | 16.227         | 0.58                    | 35.17         | -   | 35.75          | -   | 60.00     | 50.00 | -24.25 | -   |
| 6  | 19.707         | 0.64                    | 34.46         | -   | 35.10          | -   | 60.00     | 50.00 | -24.90 | -   |

- REMARKS:**
1. Q.P. and AV. are abbreviations of quasi-peak and average individually.
  2. "-": The Quasi-peak reading value also meets average limit and measurement with the average detector is unnecessary.
  3. The emission levels of other frequencies were very low against the limit.
  4. Margin value = Emission level - Limit value
  5. Correction factor = Insertion loss + Cable loss
  6. Emission Level = Correction Factor + Reading Value.

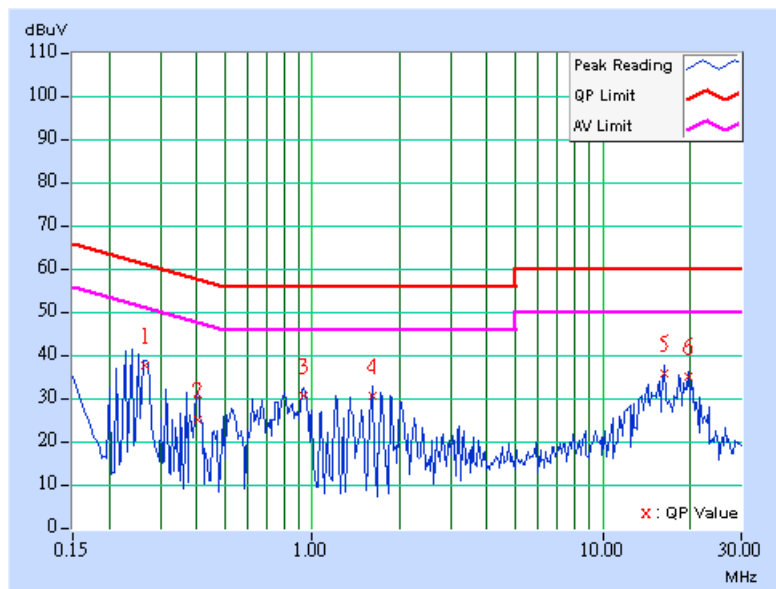





|                                 |                             |                             |             |
|---------------------------------|-----------------------------|-----------------------------|-------------|
| <b>EUT</b>                      | 802.11g Wireless Lan Router | <b>MODEL</b>                | GL2454RT-NM |
| <b>CHANNEL</b>                  | Channel 6                   | <b>6dB BANDWIDTH</b>        | 9kHz        |
| <b>INPUT POWER (SYSTEM)</b>     | 120Vac, 60 Hz               | <b>PHASE</b>                | Neutral (N) |
| <b>ENVIRONMENTAL CONDITIONS</b> | 23deg.C, 62%RH, 991hPa      | <b>TESTED BY:</b> Steven Lu |             |

| No | Freq.<br>[MHz] | Corr.<br>Factor<br>(dB) | Reading Value |     | Emission Level |     | Limit     |       | Margin |     |
|----|----------------|-------------------------|---------------|-----|----------------|-----|-----------|-------|--------|-----|
|    |                |                         | [dB (uV)]     |     | [dB (uV)]      |     | [dB (uV)] |       | (dB)   |     |
|    |                |                         | Q.P.          | AV. | Q.P.           | AV. | Q.P.      | AV.   | Q.P.   | AV. |
| 1  | 0.267          | 0.05                    | 39.35         | -   | 39.40          | -   | 61.21     | 51.21 | -21.81 | -   |
| 2  | 0.404          | 0.05                    | 23.80         | -   | 23.85          | -   | 57.77     | 47.77 | -33.92 | -   |
| 3  | 0.931          | 0.15                    | 31.63         | -   | 31.78          | -   | 56.00     | 46.00 | -24.22 | -   |
| 4  | 1.336          | 0.17                    | 33.07         | -   | 33.24          | -   | 56.00     | 46.00 | -22.76 | -   |
| 5  | 16.227         | 0.49                    | 35.52         | -   | 36.01          | -   | 60.00     | 50.00 | -23.99 | -   |
| 6  | 19.707         | 0.51                    | 34.59         | -   | 35.10          | -   | 60.00     | 50.00 | -24.90 | -   |

- REMARKS:**
1. Q.P. and AV. are abbreviations of quasi-peak and average individually.
  2. "-": The Quasi-peak reading value also meets average limit and measurement with the average detector is unnecessary.
  3. The emission levels of other frequencies were very low against the limit.
  4. Margin value = Emission level - Limit value
  5. Correction factor = Insertion loss + Cable loss
  6. Emission Level = Correction Factor + Reading Value.

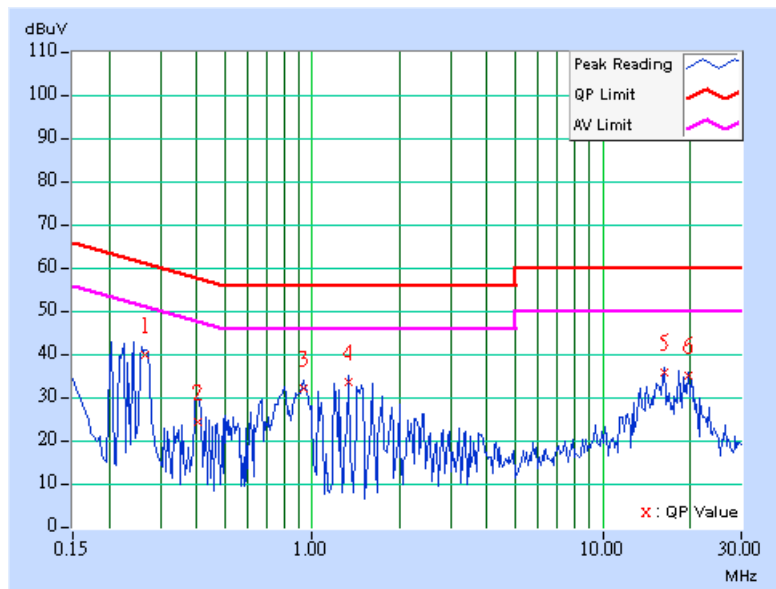



|                                 |                             |                             |             |
|---------------------------------|-----------------------------|-----------------------------|-------------|
| <b>EUT</b>                      | 802.11g Wireless Lan Router | <b>MODEL</b>                | GL2454RT-NM |
| <b>CHANNEL</b>                  | Channel 11                  | <b>6dB BANDWIDTH</b>        | 9kHz        |
| <b>INPUT POWER (SYSTEM)</b>     | 120Vac, 60 Hz               | <b>PHASE</b>                | Line (L)    |
| <b>ENVIRONMENTAL CONDITIONS</b> | 23deg.C, 62%RH, 991hPa      | <b>TESTED BY:</b> Steven Lu |             |

| No | Freq.<br>[MHz] | Corr.<br>Factor<br>(dB) | Reading Value |     | Emission Level |     | Limit     |       | Margin |     |
|----|----------------|-------------------------|---------------|-----|----------------|-----|-----------|-------|--------|-----|
|    |                |                         | [dB (uV)]     |     | [dB (uV)]      |     | [dB (uV)] |       | (dB)   |     |
|    |                |                         | Q.P.          | AV. | Q.P.           | AV. | Q.P.      | AV.   | Q.P.   | AV. |
| 1  | 0.263          | 0.06                    | 33.94         | -   | 34.00          | -   | 61.33     | 51.33 | -27.33 | -   |
| 2  | 0.404          | 0.06                    | 24.72         | -   | 24.78          | -   | 57.77     | 47.77 | -32.99 | -   |
| 3  | 0.931          | 0.15                    | 29.42         | -   | 29.57          | -   | 56.00     | 46.00 | -26.43 | -   |
| 4  | 1.617          | 0.17                    | 30.22         | -   | 30.39          | -   | 56.00     | 46.00 | -25.61 | -   |
| 5  | 16.227         | 0.58                    | 35.17         | -   | 35.75          | -   | 60.00     | 50.00 | -24.25 | -   |
| 6  | 19.707         | 0.64                    | 34.36         | -   | 35.00          | -   | 60.00     | 50.00 | -25.00 | -   |

- REMARKS:**
1. Q.P. and AV. are abbreviations of quasi-peak and average individually.
  2. "-": The Quasi-peak reading value also meets average limit and measurement with the average detector is unnecessary.
  3. The emission levels of other frequencies were very low against the limit.
  4. Margin value = Emission level - Limit value
  5. Correction factor = Insertion loss + Cable loss
  6. Emission Level = Correction Factor + Reading Value.

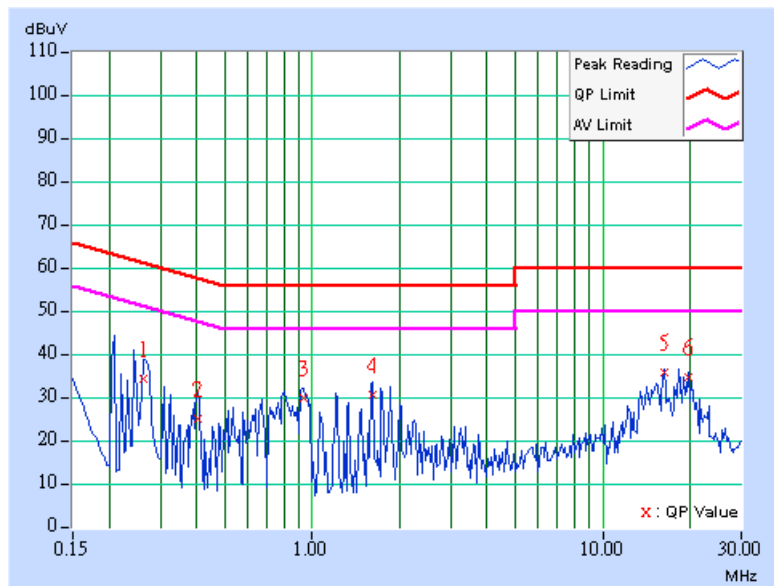



|                                 |                             |                             |             |
|---------------------------------|-----------------------------|-----------------------------|-------------|
| <b>EUT</b>                      | 802.11g Wireless Lan Router | <b>MODEL</b>                | GL2454RT-NM |
| <b>CHANNEL</b>                  | Channel 11                  | <b>6dB BANDWIDTH</b>        | 9kHz        |
| <b>INPUT POWER (SYSTEM)</b>     | 120Vac, 60 Hz               | <b>PHASE</b>                | Neutral (N) |
| <b>ENVIRONMENTAL CONDITIONS</b> | 23deg.C, 62%RH, 991hPa      | <b>TESTED BY:</b> Steven Lu |             |

| No | Freq.<br>[MHz] | Corr.<br>Factor<br>(dB) | Reading Value |     | Emission Level |     | Limit     |       | Margin |     |
|----|----------------|-------------------------|---------------|-----|----------------|-----|-----------|-------|--------|-----|
|    |                |                         | [dB (uV)]     |     | [dB (uV)]      |     | [dB (uV)] |       | (dB)   |     |
|    |                |                         | Q.P.          | AV. | Q.P.           | AV. | Q.P.      | AV.   | Q.P.   | AV. |
| 1  | 0.271          | 0.05                    | 38.71         | -   | 38.76          | -   | 61.08     | 51.08 | -22.32 | -   |
| 2  | 0.408          | 0.05                    | 22.41         | -   | 22.46          | -   | 57.69     | 47.69 | -35.23 | -   |
| 3  | 0.935          | 0.15                    | 31.93         | -   | 32.08          | -   | 56.00     | 46.00 | -23.92 | -   |
| 4  | 1.332          | 0.17                    | 32.57         | -   | 32.74          | -   | 56.00     | 46.00 | -23.26 | -   |
| 5  | 16.227         | 0.49                    | 35.22         | -   | 35.71          | -   | 60.00     | 50.00 | -24.29 | -   |
| 6  | 19.707         | 0.51                    | 34.40         | -   | 34.91          | -   | 60.00     | 50.00 | -25.09 | -   |

- REMARKS:**
1. Q.P. and AV. are abbreviations of quasi-peak and average individually.
  2. "-": The Quasi-peak reading value also meets average limit and measurement with the average detector is unnecessary.
  3. The emission levels of other frequencies were very low against the limit.
  4. Margin value = Emission level - Limit value
  5. Correction factor = Insertion loss + Cable loss
  6. Emission Level = Correction Factor + Reading Value.

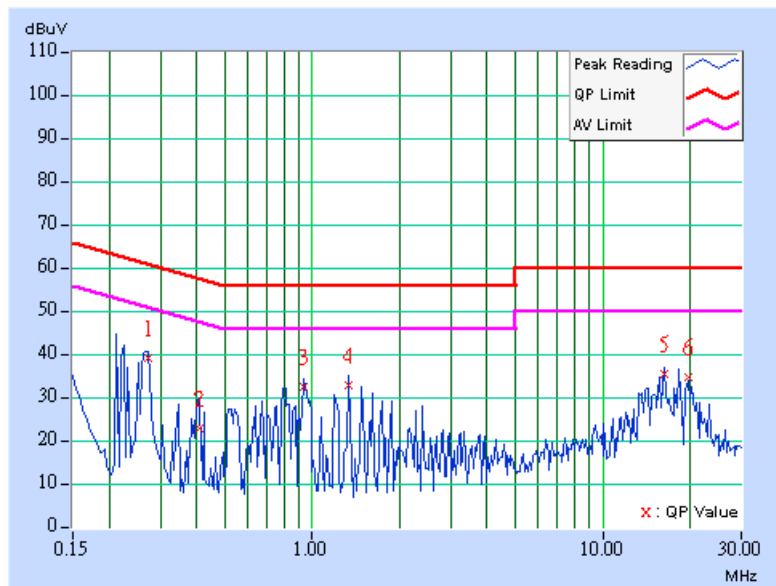



## 4.2 RADIATED EMISSION MEASUREMENT

### 4.2.1 LIMITS OF RADIATED EMISSION MEASUREMENT

Emissions radiated outside of the specified bands, shall be according to the general radiated limits in 15.209 as following:

| Frequencies (MHz) | Field strength (microvolts/meter) | Measurement distance (meters) |
|-------------------|-----------------------------------|-------------------------------|
| 0.009-0.490       | 2400/F(kHz)                       | 300                           |
| 0.490-1.705       | 24000/F(kHz)                      | 30                            |
| 1.705-30.0        | 30                                | 30                            |
| 30-88             | 100                               | 3                             |
| 88-216            | 150                               | 3                             |
| 216-960           | 200                               | 3                             |
| Above 960         | 500                               | 3                             |

**NOTE:**

1. The lower limit shall apply at the transition frequencies.
2. Emission level (dBuV/m) = 20 log Emission level (uV/m).
3. As shown in 15.35(b), for frequencies above 1000MHz, the field strength limits are based on average detector, however, the peak field strength of any emission shall not exceed the maximum permitted average limits, specified above by more than 20dB under any condition of modulation.



## 4.2.2 TEST INSTRUMENTS

| DESCRIPTION & MANUFACTURER         | MODEL NO.              | SERIAL NO.               | CALIBRATED UNTIL |
|------------------------------------|------------------------|--------------------------|------------------|
| * HP Spectrum Analyzer             | 8594E                  | 3911A07465               | July 07, 2004    |
| * HP Preamplifier                  | 8447D                  | 2432A03504               | June 10, 2004    |
| HP Preamplifier                    | 8449B                  | 3008A01201               | Dec. 11, 2004    |
| * HP Preamplifier                  | 8449B                  | 3008A01292               | Aug. 11, 2004    |
| SCHAFFNER Tunable Dipole Antenna   | VHBA 9123              | 459                      | Jun. 26, 2004    |
| SCHWARZBECK Tunable Dipole Antenna | UHA 9105               | 977                      |                  |
| * ROHDE & SCHWARZ TEST RECEIVER    | ESMI                   | 839013/007<br>839379/002 | Feb. 13, 2004    |
| *Schwarzbeck Antenna               | VULB9168               | 137                      | Apr. 03, 2004    |
| * SCHWARZBECK Horn Antenna         | BBHA9120-D1            | D130                     | June 30, 2004    |
| *ADT. Turn Table                   | TT100                  | 0306                     | NA               |
| *ADT. Tower                        | AT100                  | 0306                     | NA               |
| *Software                          | ADT_Radiated_V<br>5.14 | NA                       | NA               |
| *TIMES RF cable                    | LL142                  | CABLE-CH6-01             | Apr. 30, 2004    |

- NOTE:**
1. The calibration interval of the above test instruments is 12 months. And the calibrations are traceable to NML/ROC and NIST/USA.
  2. "\*" = These equipment are used for the final measurement.
  3. The horn antenna and HP preamplifier (model: 8449B) are used only for the measurement of emission frequency above 1GHz if tested.
  4. The test was performed in ADT Chamber No. 6.



#### 4.2.3 TEST PROCEDURES

- a. The EUT was placed on the top of a rotating table 0.8 meters above the ground at a 10 meter open area test site. The table was rotated 360 degrees to determine the position of the highest radiation.
- b. The EUT was set 3 meters away from the interference-receiving antenna, which was mounted on the top of a variable-height antenna tower.
- c. The antenna is a broadband antenna, and its height is varied from one meter to four meters above the ground to determine the maximum value of the field strength. Both horizontal and vertical polarizations of the antenna are set to make the measurement.
- d. For each suspected emission, the EUT was arranged to its worst case and then the antenna was tuned to heights from 1 meter to 4 meters and the rotatable table was turned from 0 degrees to 360 degrees to find the maximum reading.
- e. The test-receiver system was set to Peak Detect Function and Specified Bandwidth with Maximum Hold Mode.
- f. If the emission level of the EUT in peak mode was 10 dB lower than the limit specified, then testing could be stopped and the peak values of the EUT would be reported. Otherwise the emissions that did not have 10 dB margin would be re-tested one by one using peak, quasi-peak or average method as specified and then reported in a data sheet.

**NOTE:**

1. The resolution bandwidth and video bandwidth of test receiver/spectrum analyzer is 120kHz for Peak detection (PK) and Quasi-peak detection (QP) at frequency below 1GHz.
2. The resolution bandwidth and video bandwidth of test receiver/spectrum analyzer is 1 MHz for Peak detection at frequency above 1GHz.
3. The resolution bandwidth of test receiver/spectrum analyzer is 1 MHz and the video bandwidth is 10 Hz for Average detection (AV) at frequency above 1GHz.

#### 4.2.4 DEVIATION FROM TEST STANDARD

No deviation

#### 4.2.5 TEST SETUP

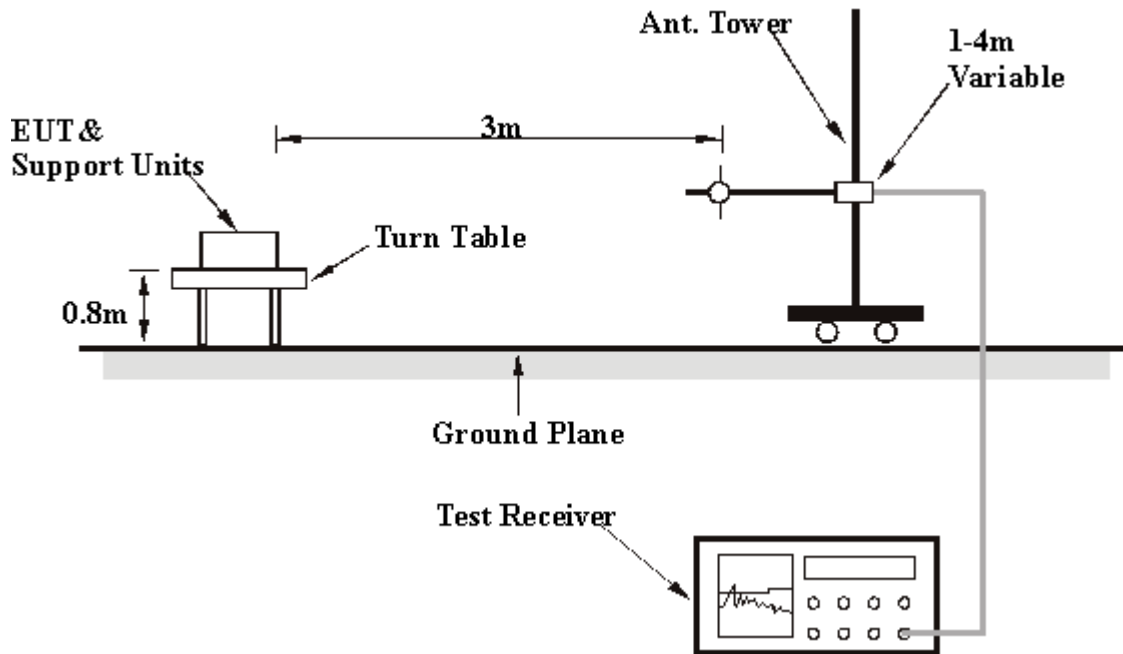

For the actual test configuration, please refer to the related item – Photographs of the Test Configuration.

#### 4.2.6 EUT OPERATING CONDITIONS

Same as 4.1.6



## 4.2.7 TEST RESULTS

|                                 |                             |                             |               |
|---------------------------------|-----------------------------|-----------------------------|---------------|
| <b>EUT</b>                      | 802.11g Wireless Lan Router | <b>MODEL</b>                | GL2454RT-NM   |
| <b>CHANNEL</b>                  | Channel 11                  | <b>FREQUENCY RANGE</b>      | Below 1000MHz |
| <b>INPUT POWER (SYSTEM)</b>     | 120Vac, 60 Hz               | <b>DETECTOR FUNCTION</b>    | Quasi-Peak    |
| <b>ENVIRONMENTAL CONDITIONS</b> | 22deg. C, 55%RH, 991hPa     | <b>TESTED BY:</b> Steven Lu |               |

**ANTENNA POLARITY & TEST DISTANCE: HORIZONTAL AT 3 M**

| No. | Freq. (MHz) | Emission Level (dBuV/m) | Limit (dBuV/m) | Margin (dB) | Antenna Height (m) | Table Angle (Degree) | Raw Value (dBuV) | Correction Factor (dB/m) |
|-----|-------------|-------------------------|----------------|-------------|--------------------|----------------------|------------------|--------------------------|
| 1   | 101.13      | 30.72 QP                | 43.50          | -12.78      | 2.14 H             | 4                    | 20.31            | 10.41                    |
| 2   | 160.41      | 36.87 QP                | 43.50          | -6.63       | 1.50 H             | 70                   | 22.62            | 14.24                    |
| 3   | 250.94      | 42.35 QP                | 46.00          | -3.65       | 1.00 H             | 94                   | 28.95            | 13.40                    |
| 4   | 300.52      | 40.37 QP                | 46.00          | -5.63       | 1.00 H             | 52                   | 25.26            | 15.10                    |
| 5   | 321.00      | 40.91 QP                | 46.00          | -5.09       | 1.00 H             | 46                   | 25.26            | 15.65                    |
| 6   | 481.59      | 40.59 QP                | 46.00          | -5.41       | 1.50 H             | 316                  | 20.85            | 19.75                    |
| 7   | 551.64      | 39.86 QP                | 46.00          | -6.14       | 1.50 H             | 58                   | 18.69            | 21.17                    |
| 8   | 601.22      | 40.57 QP                | 46.00          | -5.43       | 1.50 H             | 46                   | 17.95            | 22.62                    |
| 9   | 641.10      | 41.92 QP                | 46.00          | -4.08       | 1.00 H             | 22                   | 18.79            | 23.13                    |
| 10  | 720.86      | 37.47 QP                | 46.00          | -8.53       | 1.50 H             | 34                   | 12.92            | 24.55                    |
| 11  | 751.03      | 38.76 QP                | 46.00          | -7.24       | 1.00 H             | 64                   | 13.41            | 25.36                    |
| 12  | 800.00      | 43.04 QP                | 46.00          | -2.96       | 1.00 H             | 154                  | 17.42            | 25.62                    |
| 13  | 913.78      | 37.73 QP                | 46.00          | -8.27       | 4.00 H             | 136                  | 10.43            | 27.30                    |
| 14  | 961.20      | 44.87 QP                | 54.00          | -9.13       | 1.00 H             | 124                  | 17.11            | 27.76                    |

- REMARKS:**
1. Emission level(dBuV/m)=Raw Value(dBuV) + Correction Factor(dB/m)
  2. Correction Factor(dB/m) = Antenna Factor (dB/m) + Cable Factor (dB)
  3. The other emission levels were very low against the limit.
  4. Margin value = Emission level – Limit value.





|                                 |                             |                             |               |
|---------------------------------|-----------------------------|-----------------------------|---------------|
| <b>EUT</b>                      | 802.11g Wireless Lan Router | <b>MODEL</b>                | GL2454RT-NM   |
| <b>CHANNEL</b>                  | Channel 11                  | <b>FREQUENCY RANGE</b>      | Below 1000MHz |
| <b>INPUT POWER (SYSTEM)</b>     | 120Vac, 60 Hz               | <b>DETECTOR FUNCTION</b>    | Quasi-Peak    |
| <b>ENVIRONMENTAL CONDITIONS</b> | 22deg. C, 55%RH, 991hPa     | <b>TESTED BY:</b> Steven Lu |               |

### ANTENNA POLARITY & TEST DISTANCE: VERTICAL AT 3 M

| No. | Freq. (MHz) | Emission Level (dBuV/m) | Limit (dBuV/m) | Margin (dB) | Antenna Height (m) | Table Angle (Degree) | Raw Value (dBuV) | Correction Factor (dB/m) |
|-----|-------------|-------------------------|----------------|-------------|--------------------|----------------------|------------------|--------------------------|
| 1   | 100.00      | 32.63 QP                | 43.50          | -10.87      | 1.25 V             | 200                  | 22.34            | 10.29                    |
| 2   | 160.41      | 39.71 QP                | 43.50          | -3.79       | 1.00 V             | 88                   | 25.47            | 14.24                    |
| 3   | 250.94      | 38.95 QP                | 46.00          | -7.05       | 1.00 V             | 190                  | 25.54            | 13.40                    |
| 4   | 300.52      | 34.53 QP                | 46.00          | -11.47      | 1.50 V             | 316                  | 19.42            | 15.10                    |
| 5   | 321.00      | 33.78 QP                | 46.00          | -12.22      | 1.00 V             | 190                  | 18.13            | 15.65                    |
| 6   | 481.59      | 40.29 QP                | 46.00          | -5.71       | 2.00 V             | 82                   | 20.54            | 19.75                    |
| 7   | 551.64      | 37.88 QP                | 46.00          | -8.12       | 1.00 V             | 358                  | 16.71            | 21.17                    |
| 8   | 601.22      | 36.38 QP                | 46.00          | -9.62       | 1.00 V             | 10                   | 13.76            | 22.62                    |
| 9   | 641.10      | 40.93 QP                | 46.00          | -5.07       | 1.50 V             | 160                  | 17.80            | 23.13                    |
| 10  | 751.03      | 36.88 QP                | 46.00          | -9.12       | 1.00 V             | 310                  | 11.53            | 25.36                    |
| 11  | 800.00      | 44.26 QP                | 46.00          | -1.74       | 1.00 V             | 10                   | 18.64            | 25.62                    |
| 12  | 961.20      | 42.84 QP                | 54.00          | -11.16      | 1.50 V             | 154                  | 15.08            | 27.76                    |

- REMARKS:**
1. Emission level(dBuV/m)=Raw Value(dBuV) + Correction Factor(dB/m)
  2. Correction Factor(dB/m) = Antenna Factor (dB/m) + Cable Factor (dB)
  3. The other emission levels were very low against the limit.
  4. Margin value = Emission level – Limit value.



|                                 |                             |                              |                          |
|---------------------------------|-----------------------------|------------------------------|--------------------------|
| <b>EUT</b>                      | 802.11g Wireless Lan Router | <b>MODEL</b>                 | GL2454RT-NM              |
| <b>CHANNEL</b>                  | Channel 1                   | <b>FREQUENCY RANGE</b>       | Above 1000MHz            |
| <b>MODE</b>                     | CCK                         |                              |                          |
| <b>INPUT POWER (SYSTEM)</b>     | 120Vac, 60 Hz               | <b>DETECTOR FUNCTION</b>     | Peak(PK)<br>Average (AV) |
| <b>ENVIRONMENTAL CONDITIONS</b> | 25deg. C, 60%RH,<br>991hPa  | <b>TESTED BY:</b> Gray Chang |                          |

**ANTENNA POLARITY & TEST DISTANCE: HORIZONTAL AT 3 M**

| No. | Freq. (MHz) | Emission Level (dBuV/m) | Limit (dBuV/m) | Margin (dB) | Antenna Height (m) | Table Angle (Degree) | Raw Value (dBuV) | Correction Factor (dB/m) |
|-----|-------------|-------------------------|----------------|-------------|--------------------|----------------------|------------------|--------------------------|
| 1   | 2038.00     | 64.39 PK                | 89.76          | -25.37      | 1.19 H             | 138                  | 31.70            | 32.69                    |
| 1   | 2038.00     | 59.94 AV                | 81.41          | -21.47      | 1.19 H             | 138                  | 27.25            | 32.69                    |
| 2   | 2319.00     | 52.10 PK                | 74.00          | -21.90      | 1.19 H             | 138                  | 18.74            | 33.36                    |
| 2   | 2319.00     | 44.20 AV                | 54.00          | -9.80       | 1.19 H             | 138                  | 10.84            | 33.36                    |
| 3   | *2412.00    | 109.76 PK               |                |             | 1.19 H             | 138                  | 76.32            | 33.44                    |
| 3   | *2412.00    | 101.41 AV               |                |             | 1.19 H             | 138                  | 67.97            | 33.44                    |
| 4   | 4076.00     | 48.26 PK                | 74.00          | -25.74      | 1.35 H             | 14                   | 9.13             | 39.13                    |
| 5   | 4824.00     | 55.62 PK                | 74.00          | -18.38      | 1.69 H             | 31                   | 14.98            | 40.64                    |
| 5   | 4824.00     | 42.26 AV                | 54.00          | -11.74      | 1.69 H             | 31                   | 1.62             | 40.64                    |
| 6   | 7236.00     | 56.86 PK                | 74.00          | -17.14      | 1.18 H             | 274                  | 11.39            | 45.47                    |
| 6   | 7236.00     | 46.16 AV                | 54.00          | -7.84       | 1.18 H             | 274                  | 0.69             | 45.47                    |

**ANTENNA POLARITY & TEST DISTANCE: VERTICAL AT 3 M**

| No. | Freq. (MHz) | Emission Level (dBuV/m) | Limit (dBuV/m) | Margin (dB) | Antenna Height (m) | Table Angle (Degree) | Raw Value (dBuV) | Correction Factor (dB/m) |
|-----|-------------|-------------------------|----------------|-------------|--------------------|----------------------|------------------|--------------------------|
| 1   | 2038.00     | 67.39 PK                | 95.57          | -28.18      | 1.00 V             | 160                  | 34.70            | 32.69                    |
| 1   | 2038.00     | 65.28 AV                | 87.16          | -21.88      | 1.00 V             | 160                  | 32.59            | 32.69                    |
| 2   | 2319.00     | 58.64 PK                | 74.00          | -15.36      | 1.18 V             | 160                  | 25.28            | 33.36                    |
| 2   | 2319.00     | 50.67 AV                | 54.00          | -3.33       | 1.18 V             | 160                  | 17.31            | 33.36                    |
| 3   | *2412.00    | 115.57 PK               |                |             | 1.18 V             | 160                  | 82.13            | 33.44                    |
| 3   | *2412.00    | 107.16 AV               |                |             | 1.18 V             | 160                  | 73.72            | 33.44                    |
| 4   | 4076.00     | 49.06 PK                | 74.00          | -24.94      | 1.14 V             | 34                   | 9.93             | 39.13                    |
| 5   | 4824.00     | 62.28 PK                | 74.00          | -11.72      | 1.06 V             | 352                  | 21.64            | 40.64                    |
| 5   | 4824.00     | 49.12 AV                | 54.00          | -4.88       | 1.06 V             | 352                  | 8.48             | 40.64                    |
| 6   | 7234.00     | 60.63 PK                | 74.00          | -13.37      | 1.71 V             | 137                  | 15.17            | 45.46                    |
| 6   | 7234.00     | 49.54 AV                | 54.00          | -4.46       | 1.71 V             | 137                  | 4.08             | 45.46                    |

- REMARKS:**
1. Emission level(dBuV/m)=Raw Value(dBuV) + Correction Factor(dB)
  2. Correction Factor(dB/m) = Antenna Factor (dB/m) + Cable Factor (dB)
  3. The other emission levels were very low against the limit.
  4. Margin value = Emission level – Limit value.
  5. “ \* “ : Fundamental frequency.



|                                 |                             |                              |                          |
|---------------------------------|-----------------------------|------------------------------|--------------------------|
| <b>EUT</b>                      | 802.11g Wireless Lan Router | <b>MODEL</b>                 | GL2454RT-NM              |
| <b>CHANNEL</b>                  | Channel 6                   | <b>FREQUENCY RANGE</b>       | Above 1000MHz            |
| <b>MODE</b>                     | CCK                         |                              |                          |
| <b>INPUT POWER (SYSTEM)</b>     | 120Vac, 60 Hz               | <b>DETECTOR FUNCTION</b>     | Peak(PK)<br>Average (AV) |
| <b>ENVIRONMENTAL CONDITIONS</b> | 25deg. C, 60%RH,<br>991hPa  | <b>TESTED BY:</b> Gray Chang |                          |

**ANTENNA POLARITY & TEST DISTANCE: HORIZONTAL AT 3 M**

| No. | Freq. (MHz) | Emission Level (dBuV/m) | Limit (dBuV/m) | Margin (dB) | Antenna Height (m) | Table Angle (Degree) | Raw Value (dBuV) | Correction Factor (dB/m) |
|-----|-------------|-------------------------|----------------|-------------|--------------------|----------------------|------------------|--------------------------|
| 1   | 2063.00     | 63.20 PK                | 87.87          | -24.67      | 1.40 H             | 324                  | 30.50            | 32.70                    |
| 1   | 2063.00     | 60.50 AV                | 79.62          | -19.12      | 1.40 H             | 324                  | 27.80            | 32.70                    |
| 2   | 2437.00     | 107.87 PK               |                |             | 1.40 H             | 324                  | 74.38            | 33.49                    |
| 2   | 2437.00     | 99.62 AV                |                |             | 1.40 H             | 324                  | 66.13            | 33.49                    |
| 3   | 4126.00     | 49.27 PK                | 74.00          | -24.73      | 1.22 H             | 341                  | 10.13            | 39.15                    |
| 4   | 4874.00     | 54.26 PK                | 74.00          | -19.74      | 1.16 H             | 34                   | 13.61            | 40.65                    |
| 4   | 4874.00     | 42.36 AV                | 54.00          | -11.64      | 1.16 H             | 34                   | 1.71             | 40.65                    |
| 5   | 7311.00     | 58.89 PK                | 74.00          | -15.11      | 2.06 H             | 360                  | 13.27            | 45.63                    |
| 5   | 7311.00     | 45.69 AV                | 54.00          | -8.31       | 2.06 H             | 360                  | 0.07             | 45.63                    |

**ANTENNA POLARITY & TEST DISTANCE: VERTICAL AT 3 M**

| No. | Freq. (MHz) | Emission Level (dBuV/m) | Limit (dBuV/m) | Margin (Db) | Antenna Height (m) | Table Angle (Degree) | Raw Value (dBuV) | Correction Factor (Db/m) |
|-----|-------------|-------------------------|----------------|-------------|--------------------|----------------------|------------------|--------------------------|
| 1   | 2063.00     | 62.00 PK                | 96.00          | -34.00      | 1.15 V             | 43                   | 29.30            | 32.70                    |
| 1   | 2063.00     | 60.40 AV                | 88.49          | -28.09      | 1.15 V             | 43                   | 27.70            | 32.70                    |
| 2   | *2437.00    | 116.00 PK               |                |             | 1.00 V             | 235                  | 82.51            | 33.49                    |
| 2   | *2437.00    | 108.49 AV               |                |             | 1.00 V             | 235                  | 75.00            | 33.49                    |
| 3   | 4126.00     | 49.17 PK                | 74.00          | -24.83      | 1.40 V             | 274                  | 10.03            | 39.15                    |
| 4   | 4874.00     | 57.57 PK                | 74.00          | -16.43      | 1.26 V             | 241                  | 16.92            | 40.65                    |
| 4   | 4874.00     | 44.00 AV                | 54.00          | -10.00      | 1.26 V             | 241                  | 3.35             | 40.65                    |
| 5   | 7314.00     | 59.87 PK                | 74.00          | -14.13      | 1.84 V             | 114                  | 14.24            | 45.63                    |
| 5   | 7314.00     | 46.40 AV                | 54.00          | -7.60       | 1.84 V             | 114                  | 0.77             | 45.63                    |

**REMARKS:** 1. Emission level(dBuV/m)=Raw Value(dBuV) + Correction Factor(Db)  
 2. Correction Factor(Db/m) = Antenna Factor (Db/m) + Cable Factor (Db)

- 4. The other emission levels were very low against the limit.
- 5. Margin value = Emission level – Limit value.
- 6. “ \* “ : Fundamental frequency.



|                                 |                             |                              |                          |
|---------------------------------|-----------------------------|------------------------------|--------------------------|
| <b>EUT</b>                      | 802.11g Wireless Lan Router | <b>MODEL</b>                 | GL2454RT-NM              |
| <b>CHANNEL</b>                  | Channel 11                  | <b>FREQUENCY RANGE</b>       | Above 1000MHz            |
| <b>MODE</b>                     | CCK                         |                              |                          |
| <b>INPUT POWER (SYSTEM)</b>     | 120Vac, 60 Hz               | <b>DETECTOR FUNCTION</b>     | Peak(PK)<br>Average (AV) |
| <b>ENVIRONMENTAL CONDITIONS</b> | 25deg. C, 60%RH,<br>991hPa  | <b>TESTED BY:</b> Gray Chang |                          |

| ANTENNA POLARITY & TEST DISTANCE: HORIZONTAL AT 3 M |             |                         |                |             |                    |                      |                  |                          |
|---|-------------|-------------------------|----------------|-------------|--------------------|----------------------|------------------|--------------------------|
| No.   | Freq. (MHz) | Emission Level (dBuV/m) | Limit (dBuV/m) | Margin (Db) | Antenna Height (m) | Table Angle (Degree) | Raw Value (dBuV) | Correction Factor (Db/m) |
| 1   | 2088.00     | 66.30 PK                | 91.37          | -25.07      | 1.17 H             | 345                  | 33.58            | 32.72                    |
| 1   | 2088.00     | 63.70 AV                | 82.70          | -19.00      | 1.17 H             | 345                  | 30.98            | 32.72                    |
| 2   | *2462.00    | 111.37 PK               |                |             | 1.00 H             | 74                   | 77.82            | 33.55                    |
| 2   | *2462.00    | 102.70 AV               |                |             | 1.00 H             | 74                   | 69.15            | 33.55                    |
| 3   | 2486.50     | 55.70 PK                | 74.00          | -18.30      | 1.17 H             | 345                  | 22.10            | 33.60                    |
| 3   | 2486.50     | 47.50 AV                | 54.00          | -6.50       | 1.17 H             | 345                  | 13.90            | 33.60                    |
| 4   | 4924.00     | 55.82 PK                | 74.00          | -18.18      | 1.41 H             | 2                    | 15.11            | 40.71                    |
| 4   | 4924.00     | 44.02 AV                | 54.00          | -9.98       | 1.41 H             | 2                    | 3.31             | 40.71                    |
| 5   | 7386.00     | 58.12 PK                | 74.00          | -15.88      | 1.19 H             | 174                  | 12.44            | 45.68                    |
| 5   | 7386.00     | 46.52 AV                | 54.00          | -7.48       | 1.19 H             | 174                  | 0.84             | 45.68                    |

| ANTENNA POLARITY & TEST DISTANCE: VERTICAL AT 3 M |                |                         |                |              |                    |                      |                  |                          |
|---|----------------|-------------------------|----------------|--------------|--------------------|----------------------|------------------|--------------------------|
| No.   | Freq. (MHz)    | Emission Level (dBuV/m) | Limit (dBuV/m) | Margin (dB)  | Antenna Height (m) | Table Angle (Degree) | Raw Value (dBuV) | Correction Factor (dB/m) |
| 1   | 2088.00        | 68.00 PK                | 96.90          | -28.90       | 1.52 V             | 45                   | 35.28            | 32.72                    |
| 1   | 2088.00        | 66.00 AV                | 88.90          | 22.90        | 1.52 V             | 45                   | 33.28            | 32.72                    |
| 2   | 2386.00        | 62.00 PK                | 74.00          | -12.00       | 1.19 V             | 151                  | 28.60            | 33.40                    |
| 2   | 2386.00        | 48.10 AV                | 54.00          | -5.90        | 1.19 V             | 151                  | 14.70            | 33.40                    |
| 3   | *2462.00       | 116.90 PK               |                |              | 1.19 V             | 151                  | 83.35            | 33.55                    |
| 3   | *2462.00       | 108.90 AV               |                |              | 1.19 V             | 151                  | 75.35            | 33.55                    |
| 4   | 2560.00        | 61.24 PK                | 74.00          | -12.76       | 1.14 V             | 186                  | 27.29            | 33.95                    |
| <b>4</b>  | <b>2560.00</b> | <b>52.70 AV</b>         | <b>54.00</b>   | <b>-1.30</b> | <b>1.14 V</b>      | <b>186</b>           | <b>18.75</b>     | <b>33.95</b>             |
| 5   | 4176.00        | 48.67 PK                | 74.00          | -25.33       | 1.54 V             | 117                  | 9.63             | 39.04                    |
| 6   | 4924.00        | 62.48 PK                | 74.00          | -11.52       | 1.71 V             | 24                   | 21.77            | 40.71                    |
| 6   | 4924.00        | 49.19 AV                | 54.00          | -4.81        | 1.71 V             | 24                   | 8.48             | 40.71                    |
| 7   | 7386.00        | 62.94 PK                | 74.00          | -11.06       | 1.34 V             | 345                  | 17.26            | 45.68                    |
| 7   | 7386.00        | 48.99 AV                | 54.00          | -5.01        | 1.34 V             | 345                  | 3.31             | 45.68                    |

- REMARKS:**
1. Emission level(dBuV/m)=Raw Value(dBuV) + Correction Factor(dB)
  2. Correction Factor(dB/m) = Antenna Factor (dB/m) + Cable Factor (dB)
  3. The other emission levels were very low against the limit.
  4. Margin value = Emission level – Limit value.
  5. “ \* “ : Fundamental frequency.



|                                 |                             |                              |                          |
|---------------------------------|-----------------------------|------------------------------|--------------------------|
| <b>EUT</b>                      | 802.11g Wireless Lan Router | <b>MODEL</b>                 | GL2454RT-NM              |
| <b>CHANNEL</b>                  | Channel 1                   | <b>FREQUENCY RANGE</b>       | Above 1000MHz            |
| <b>MODE</b>                     | OFDM                        |                              |                          |
| <b>INPUT POWER (SYSTEM)</b>     | 120Vac, 60 Hz               | <b>DETECTOR FUNCTION</b>     | Peak(PK)<br>Average (AV) |
| <b>ENVIRONMENTAL CONDITIONS</b> | 25deg. C, 60%RH,<br>991hPa  | <b>TESTED BY:</b> Gray Chang |                          |

**ANTENNA POLARITY & TEST DISTANCE: HORIZONTAL AT 3 M**

| No. | Freq. (MHz) | Emission Level (dBuV/m) | Limit (dBuV/m) | Margin (dB) | Antenna Height (m) | Table Angle (Degree) | Raw Value (dBuV) | Correction Factor (dB/m) |
|-----|-------------|-------------------------|----------------|-------------|--------------------|----------------------|------------------|--------------------------|
| 1   | 2038.00     | 60.10 PK                | 79.40          | -19.30      | 1.40 H             | 230                  | 27.41            | 32.69                    |
| 1   | 2038.00     | 56.30 AV                | 69.70          | -13.40      | 1.40 H             | 230                  | 23.61            | 32.69                    |
| 2   | 2390.00     | 49.20 PK                | 74.00          | -24.80      | 1.46 H             | 230                  | 15.80            | 33.40                    |
| 3   | *2412.00    | 99.40 PK                |                |             | 1.46 H             | 230                  | 65.96            | 33.44                    |
| 3   | *2412.00    | 89.70 AV                |                |             | 1.46 H             | 230                  | 56.26            | 33.44                    |
| 4   | 4824.00     | 52.65 PK                | 74.00          | -21.35      | 1.38 H             | 34                   | 12.01            | 40.64                    |
| 4   | 4824.00     | 41.35 AV                | 54.00          | -12.65      | 1.38 H             | 34                   | 0.71             | 40.64                    |
| 5   | 7236.00     | 57.76 PK                | 74.00          | -16.24      | 1.17 H             | 34                   | 12.29            | 45.47                    |
| 5   | 7236.00     | 46.26 AV                | 54.00          | -7.74       | 1.17 H             | 34                   | 0.79             | 45.47                    |

**ANTENNA POLARITY & TEST DISTANCE: VERTICAL AT 3 M**

| No. | Freq. (MHz) | Emission Level (dBuV/m) | Limit (dBuV/m) | Margin (dB) | Antenna Height (m) | Table Angle (Degree) | Raw Value (dBuV) | Correction Factor (dB/m) |
|-----|-------------|-------------------------|----------------|-------------|--------------------|----------------------|------------------|--------------------------|
| 1   | 2038.00     | 66.50 PK                | 88.30          | -21.80      | 1.04 V             | 34                   | 33.81            | 32.69                    |
| 1   | 2038.00     | 64.10 AV                | 78.40          | -14.30      | 1.04 V             | 34                   | 31.41            | 32.69                    |
| 2   | 2390.00     | 60.10 PK                | 74.00          | -13.90      | 1.20 V             | 187                  | 26.70            | 33.40                    |
| 2   | 2390.00     | 50.00 AV                | 54.00          | -4.00       | 1.20 V             | 187                  | 16.60            | 33.40                    |
| 3   | *2412.00    | 108.30 PK               |                |             | 1.20 V             | 187                  | 74.86            | 33.44                    |
| 3   | *2412.00    | 98.40 AV                |                |             | 1.20 V             | 187                  | 64.96            | 33.44                    |
| 4   | 4824.00     | 52.05 PK                | 74.00          | -21.95      | 1.54 V             | 130                  | 11.41            | 40.64                    |
| 4   | 4824.00     | 41.75 AV                | 54.00          | -12.25      | 1.54 V             | 130                  | 1.11             | 40.64                    |
| 5   | 7236.00     | 57.95 PK                | 74.00          | -16.05      | 1.20 V             | 214                  | 12.48            | 45.47                    |
| 5   | 7236.00     | 46.36 AV                | 54.00          | -7.64       | 1.20 V             | 214                  | 0.89             | 45.47                    |

- REMARKS:**
1. Emission level(dBuV/m)=Raw Value(dBuV) + Correction Factor(dB)
  2. Correction Factor(dB/m) = Antenna Factor (dB/m) + Cable Factor (dB)
  3. The other emission levels were very low against the limit.
  4. Margin value = Emission level – Limit value.
  5. “ \* “ : Fundamental frequency.



|                                 |                             |                              |                          |
|---------------------------------|-----------------------------|------------------------------|--------------------------|
| <b>EUT</b>                      | 802.11g Wireless Lan Router | <b>MODEL</b>                 | GL2454RT-NM              |
| <b>CHANNEL</b>                  | Channel 6                   | <b>FREQUENCY RANGE</b>       | Above 1000MHz            |
| <b>MODE</b>                     | OFDM                        |                              |                          |
| <b>INPUT POWER (SYSTEM)</b>     | 120Vac, 60 Hz               | <b>DETECTOR FUNCTION</b>     | Peak(PK)<br>Average (AV) |
| <b>ENVIRONMENTAL CONDITIONS</b> | 25deg. C, 60%RH,<br>991hPa  | <b>TESTED BY:</b> Gray Chang |                          |

**ANTENNA POLARITY & TEST DISTANCE: HORIZONTAL AT 3 M**

| No. | Freq. (MHz) | Emission Level (dBuV/m) | Limit (dBuV/m) | Margin (dB) | Antenna Height (m) | Table Angle (Degree) | Raw Value (dBuV) | Correction Factor (dB/m) |
|-----|-------------|-------------------------|----------------|-------------|--------------------|----------------------|------------------|--------------------------|
| 1   | 2063.00     | 63.86 PK                | 80.90          | -17.01      | 1.24 H             | 241                  | 31.16            | 32.70                    |
| 1   | 2063.00     | 60.10 AV                | 70.90          | 10.80       | 1.24 H             | 241                  | 27.40            | 32.70                    |
| 2   | *2437.00    | 100.90 PK               |                |             | 1.35 H             | 324                  | 67.41            | 33.49                    |
| 2   | *2437.00    | 90.90 AV                |                |             | 1.35 H             | 324                  | 57.41            | 33.49                    |
| 3   | 4874.00     | 53.36 PK                | 74.00          | -20.64      | 1.01 H             | 341                  | 12.71            | 40.65                    |
| 3   | 4874.00     | 41.66 AV                | 54.00          | -12.34      | 1.01 H             | 341                  | 1.01             | 40.65                    |
| 4   | 7311.00     | 57.39 PK                | 74.00          | -16.61      | 1.54 H             | 275                  | 11.77            | 45.63                    |
| 4   | 7311.00     | 46.29 AV                | 54.00          | -7.71       | 1.54 H             | 275                  | 0.67             | 45.63                    |

**ANTENNA POLARITY & TEST DISTANCE: VERTICAL AT 3 M**

| No. | Freq. (MHz) | Emission Level (dBuV/m) | Limit (dBuV/m) | Margin (dB) | Antenna Height (m) | Table Angle (Degree) | Raw Value (dBuV) | Correction Factor (dB/m) |
|-----|-------------|-------------------------|----------------|-------------|--------------------|----------------------|------------------|--------------------------|
| 1   | 2063.00     | 65.80 PK                | 87.85          | -22.05      | 1.36 V             | 345                  | 33.10            | 32.70                    |
| 1   | 2063.00     | 62.70 AV                | 77.90          | -15.20      | 1.36 V             | 345                  | 30.00            | 32.70                    |
| 2   | *2437.00    | 107.85 PK               |                |             | 1.00 V             | 195                  | 74.36            | 33.49                    |
| 2   | *2437.00    | 97.90 AV                |                |             | 1.00 V             | 195                  | 64.41            | 33.49                    |
| 3   | 4874.00     | 54.06 PK                | 74.00          | -19.94      | 1.17 V             | 112                  | 13.41            | 40.65                    |
| 3   | 4874.00     | 42.56 AV                | 54.00          | -11.44      | 1.17 V             | 112                  | 1.91             | 40.65                    |
| 4   | 7311.00     | 57.18 PK                | 74.00          | -16.82      | 1.54 V             | 119                  | 11.56            | 45.63                    |
| 4   | 7311.00     | 46.39 AV                | 54.00          | -7.61       | 1.54 V             | 119                  | 0.77             | 45.63                    |

- REMARKS:**
1. Emission level(dBuV/m)=Raw Value(dBuV) + Correction Factor(dB)
  2. Correction Factor(dB/m) = Antenna Factor (dB/m) + Cable Factor (dB)
  3. The other emission levels were very low against the limit.
  4. Margin value = Emission level – Limit value.
  5. “ \* “ : Fundamental frequency.



|                                 |                             |                              |                          |
|---------------------------------|-----------------------------|------------------------------|--------------------------|
| <b>EUT</b>                      | 802.11g Wireless Lan Router | <b>MODEL</b>                 | GL2454RT-NM              |
| <b>CHANNEL</b>                  | Channel 11                  | <b>FREQUENCY RANGE</b>       | Above 1000MHz            |
| <b>MODE</b>                     | OFDM                        |                              |                          |
| <b>INPUT POWER (SYSTEM)</b>     | 120Vac, 60 Hz               | <b>DETECTOR FUNCTION</b>     | Peak(PK)<br>Average (AV) |
| <b>ENVIRONMENTAL CONDITIONS</b> | 25deg. C, 60%RH,<br>991hPa  | <b>TESTED BY:</b> Gray Chang |                          |

**ANTENNA POLARITY & TEST DISTANCE: HORIZONTAL AT 3 M**

| No. | Freq. (MHz) | Emission Level (dBuV/m) | Limit (dBuV/m) | Margin (dB) | Antenna Height (m) | Table Angle (Degree) | Raw Value (dBuV) | Correction Factor (dB/m) |
|-----|-------------|-------------------------|----------------|-------------|--------------------|----------------------|------------------|--------------------------|
| 1   | 2088.00     | 66.30 PK                | 77.24          | -10.94      | 1.00 H             | 82                   | 33.58            | 32.72                    |
| 1   | 2088.00     | 64.10 AV                | 67.80          | -3.70       | 1.00 H             | 82                   | 31.38            | 32.72                    |
| 2   | *2462.00    | 97.24 PK                |                |             | 1.46 H             | 40                   | 63.69            | 33.55                    |
| 2   | *2462.00    | 87.80 AV                |                |             | 1.46 H             | 40                   | 54.25            | 33.55                    |
| 3   | 2485.00     | 50.20 PK                | 74.00          | -23.80      | 1.46 H             | 40                   | 16.60            | 33.60                    |
| 4   | 4924.00     | 53.12 PK                | 74.00          | -20.88      | 1.26 H             | 174                  | 12.41            | 40.71                    |
| 4   | 4924.00     | 42.72 AV                | 54.00          | -11.28      | 1.26 H             | 174                  | 2.01             | 40.71                    |
| 5   | 7386.00     | 58.92 PK                | 74.00          | -15.08      | 1.24 H             | 341                  | 13.24            | 45.68                    |
| 5   | 7386.00     | 46.62 AV                | 54.00          | -7.38       | 1.24 H             | 341                  | 0.94             | 45.68                    |

**ANTENNA POLARITY & TEST DISTANCE: VERTICAL AT 3 M**

| No. | Freq. (MHz) | Emission Level (dBuV/m) | Limit (dBuV/m) | Margin (dB) | Antenna Height (m) | Table Angle (Degree) | Raw Value (dBuV) | Correction Factor (dB/m) |
|-----|-------------|-------------------------|----------------|-------------|--------------------|----------------------|------------------|--------------------------|
| 1   | 2088.00     | 66.50 PK                | 87.50          | -21.00      | 1.06 V             | 45                   | 33.78            | 32.72                    |
| 1   | 2088.00     | 64.80 AV                | 77.86          | -13.06      | 1.06 V             | 45                   | 32.08            | 32.72                    |
| 2   | *2462.00    | 107.50 PK               |                |             | 1.00 V             | 230                  | 73.95            | 33.55                    |
| 2   | *2462.00    | 97.86 AV                |                |             | 1.00 V             | 230                  | 64.31            | 33.55                    |
| 3   | 2485.90     | 59.80 PK                | 74.00          | -14.20      | 1.00 V             | 230                  | 26.20            | 33.60                    |
| 3   | 2485.90     | 48.90 AV                | 54.00          | -5.10       | 1.00 V             | 230                  | 15.30            | 33.60                    |
| 4   | 4924.00     | 52.79 PK                | 74.00          | -21.21      | 1.58 V             | 147                  | 12.08            | 40.71                    |
| 4   | 4924.00     | 42.02 AV                | 54.00          | -11.98      | 1.58 V             | 147                  | 1.31             | 40.71                    |
| 5   | 7386.00     | 57.32 PK                | 74.00          | -16.68      | 1.13 V             | 34                   | 11.64            | 45.68                    |
| 5   | 7386.00     | 45.92 AV                | 54.00          | -8.08       | 1.13 V             | 34                   | 0.24             | 45.68                    |

- REMARKS:**
1. Emission level(dBuV/m)=Raw Value(dBuV) + Correction Factor(dB)
  2. Correction Factor(dB/m) = Antenna Factor (dB/m) + Cable Factor (dB)
  3. The other emission levels were very low against the limit.
  4. Margin value = Emission level – Limit value.
  5. “ \* “ : Fundamental frequency.



### 4.3 6dB BANDWIDTH MEASUREMENT

#### 4.3.1 LIMITS OF 6dB BANDWIDTH MEASUREMENT

The minimum of 6dB Bandwidth Measurement is 0.5 MHz.

#### 4.3.2 TEST INSTRUMENTS

| Description & Manufacturer | Model No. | Serial No. | Calibrated Until |
|----------------------------|-----------|------------|------------------|
| R&S SPECTRUM ANALYZER      | FSEK30    | 100049     | Aug. 12, 2004    |

**NOTE:** The calibration interval of the above test instruments is 12 months and the calibrations are traceable to NML/ROC and NIST/USA.

#### 4.3.3 TEST PROCEDURE

The transmitter output was connected to the spectrum analyzer through an attenuator. The bandwidth of the fundamental frequency was measured by spectrum analyzer with 100kHz RBW and 100kHz VBW. The 6dB bandwidth is defined as the total spectrum the power of which is higher than peak power minus 6dB.

#### 4.3.4 DEVIATION FROM TEST STANDARD

No deviation



#### 4.3.5 TEST SETUP

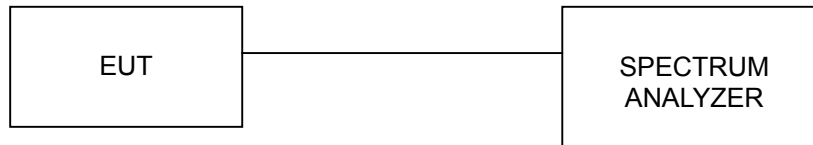

For the actual test configuration, please refer to the related Item – Photographs of the Test Configuration.

#### 4.3.6 EUT OPERATING CONDITIONS

The software provided by client to enable the EUT under transmission condition continuously at lowest, middle and highest channel frequencies individually.



## 4.3.7 TEST RESULTS

|                                 |                             |                             |               |
|---------------------------------|-----------------------------|-----------------------------|---------------|
| <b>EUT</b>                      | 802.11g Wireless Lan Router | <b>MODEL</b>                | GL2454RT-NM   |
| <b>MODE</b>                     | CCK                         | <b>INPUT POWER (SYSTEM)</b> | 120Vac, 60 Hz |
| <b>ENVIRONMENTAL CONDITIONS</b> | 23deg. C, 65%RH, 991hPa     | <b>TESTED BY</b>            | Steven Lu     |

| <b>CHANNEL</b> | <b>CHANNEL FREQUENCY (MHz)</b> | <b>6dB BANDWIDTH (MHz)</b> | <b>MINIMUM LIMIT (MHz)</b> | <b>PASS/FAIL</b> |
|----------------|--------------------------------|----------------------------|----------------------------|------------------|
| 1              | 2412                           | 9.52                       | 0.5                        | PASS             |
| 6              | 2437                           | 9.48                       | 0.5                        | PASS             |
| 11             | 2462                           | 9.48                       | 0.5                        | PASS             |



CH1

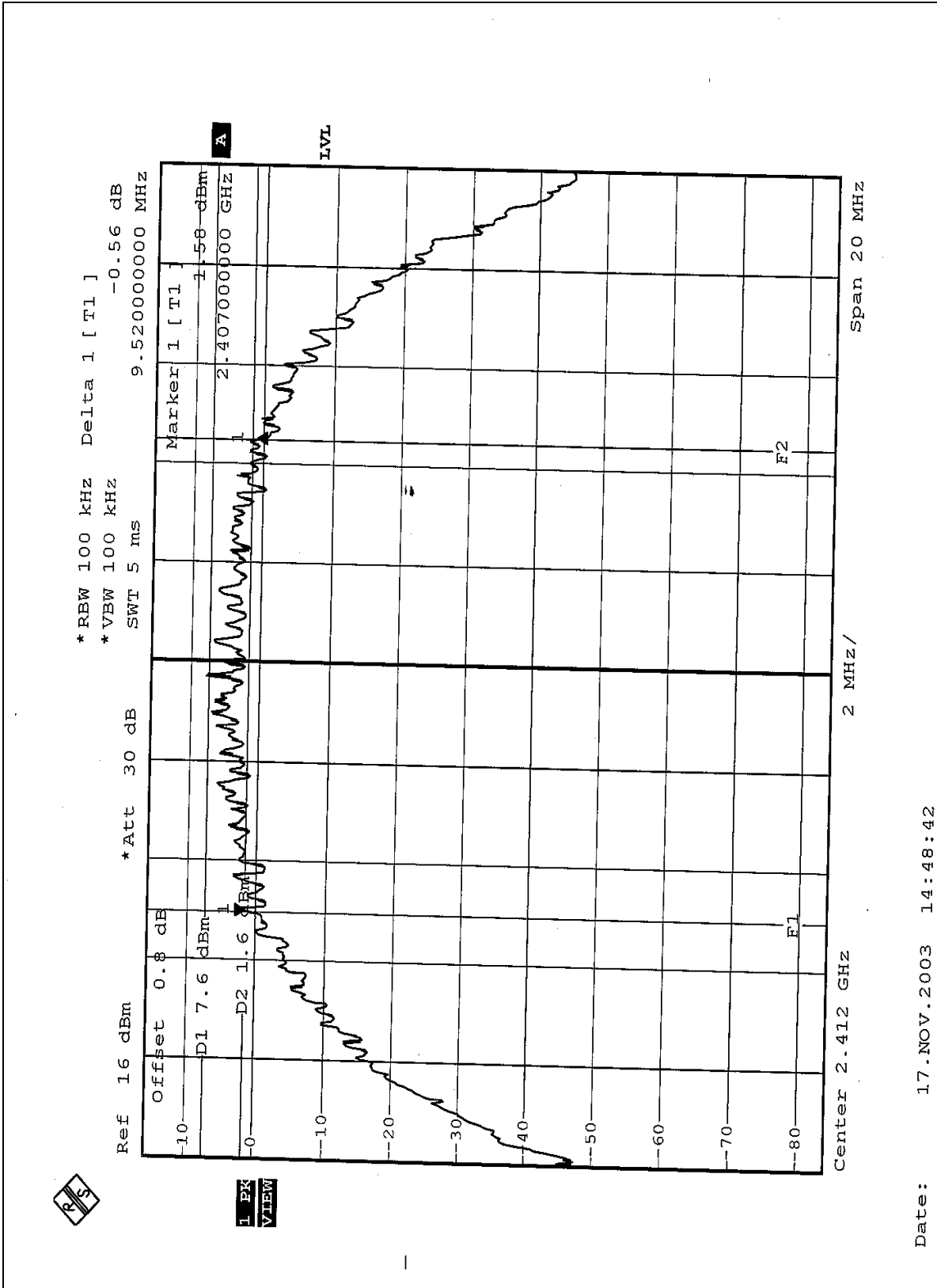

Date: 17.NOV.2003 14:48:42



CH6

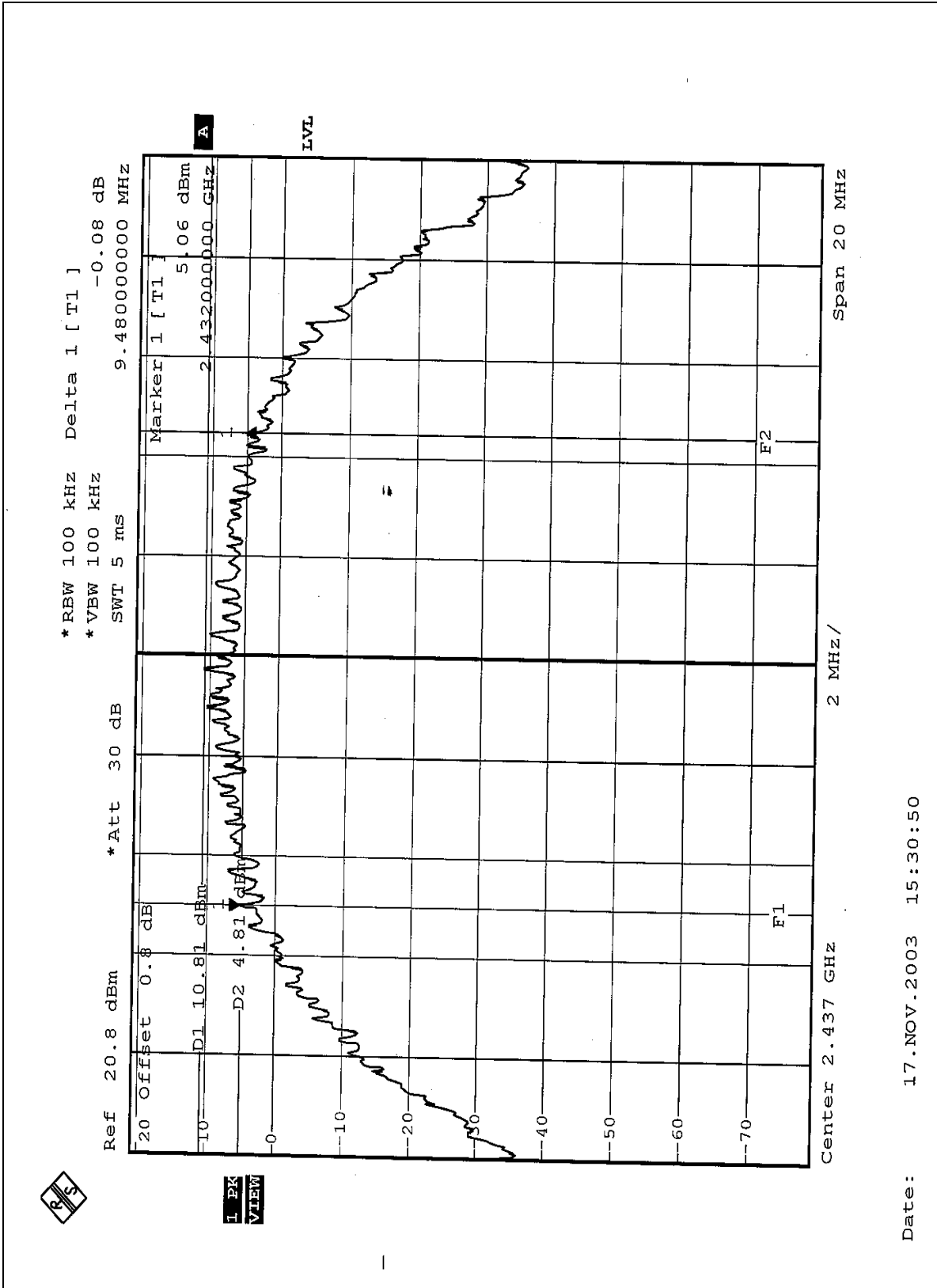

Date: 17.NOV.2003 15:30:50



CH11

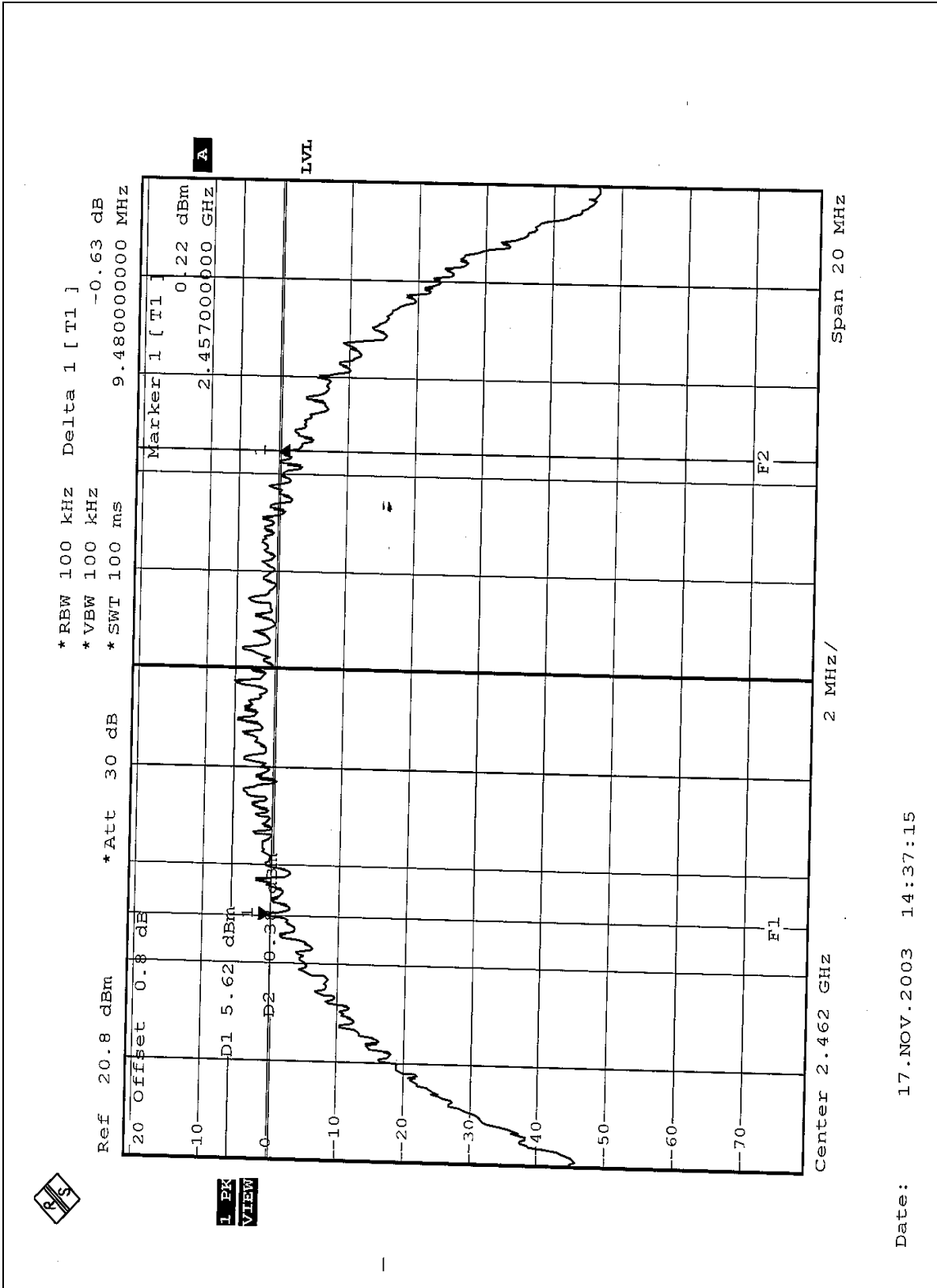

Date: 17.NOV.2003 14:37:15



|                                 |                             |                             |               |
|---------------------------------|-----------------------------|-----------------------------|---------------|
| <b>EUT</b>                      | 802.11g Wireless Lan Router | <b>MODEL</b>                | GL2454RT-NM   |
| <b>MODE</b>                     | OFDM                        | <b>INPUT POWER (SYSTEM)</b> | 120Vac, 60 Hz |
| <b>ENVIRONMENTAL CONDITIONS</b> | 23deg. C, 65%RH, 991hPa     | <b>TESTED BY</b>            | Steven Lu     |

| <b>CHANNEL</b> | <b>CHANNEL FREQUENCY (MHz)</b> | <b>6dB BANDWIDTH (MHz)</b> | <b>MINIMUM LIMIT (MHz)</b> | <b>PASS/FAIL</b> |
|----------------|--------------------------------|----------------------------|----------------------------|------------------|
| 1              | 2412                           | 16.36                      | 0.5                        | PASS             |
| 6              | 2437                           | 16.08                      | 0.5                        | PASS             |
| 11             | 2462                           | 16.04                      | 0.5                        | PASS             |



CH1

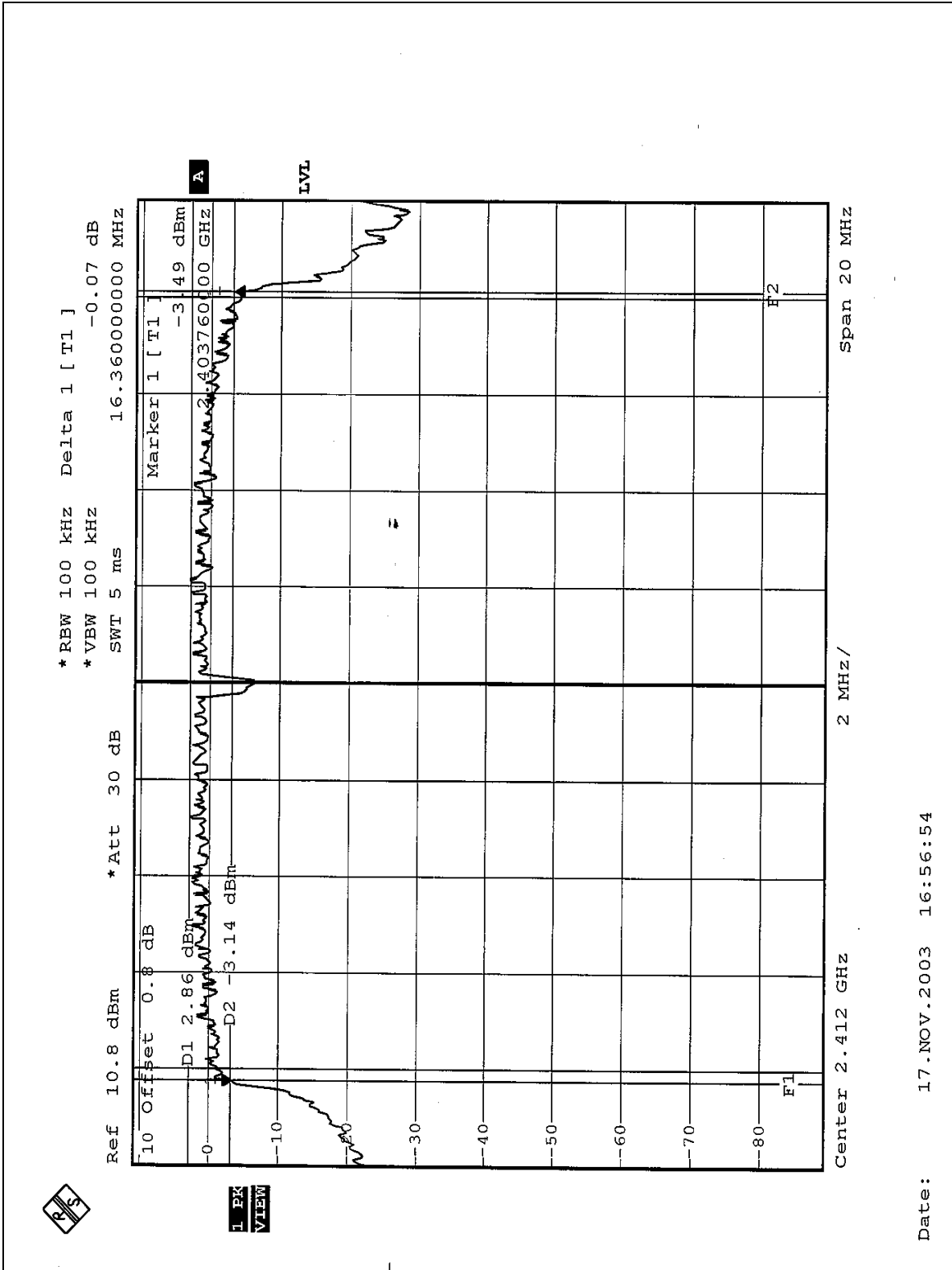



CH6

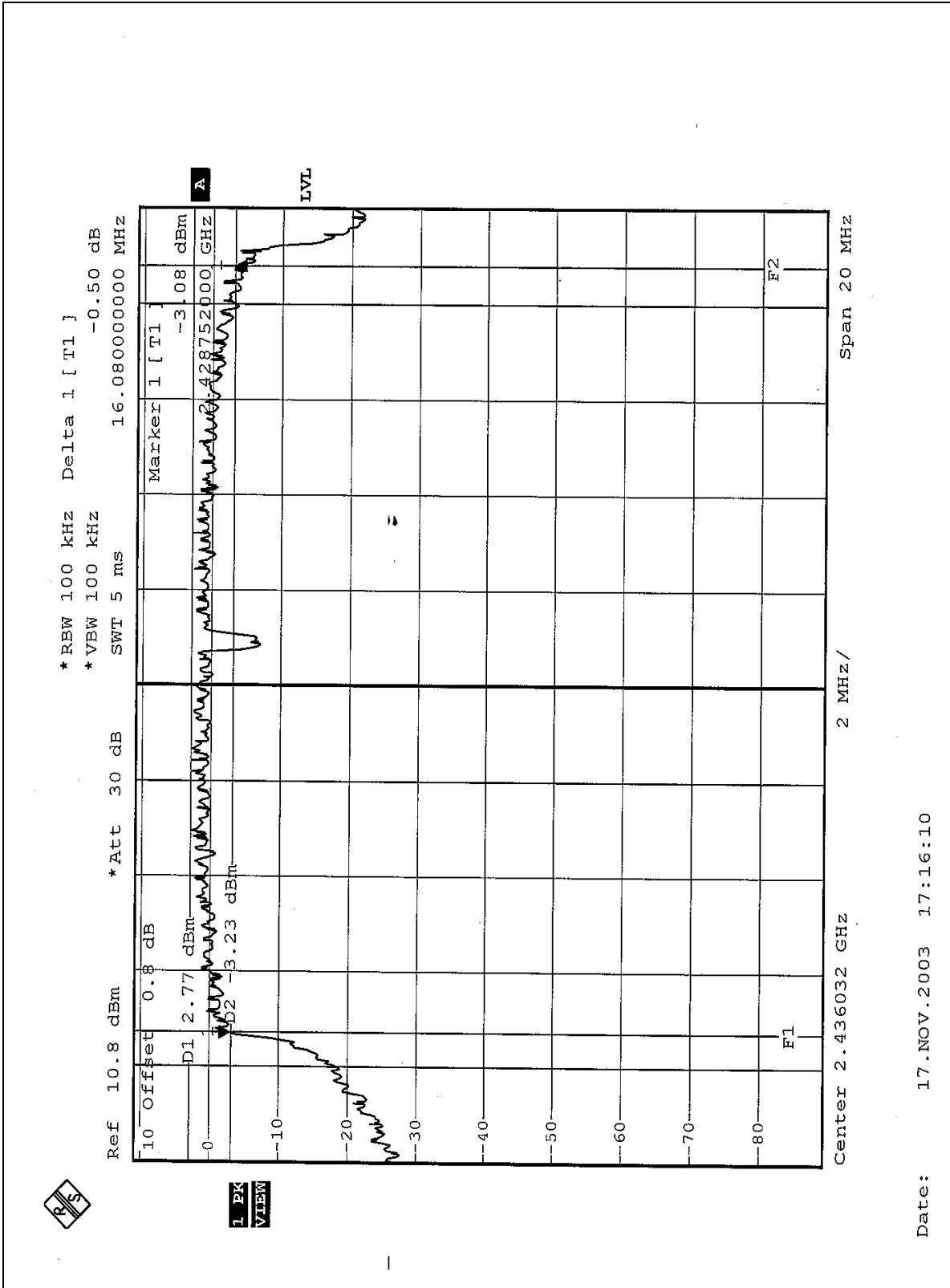





CH11

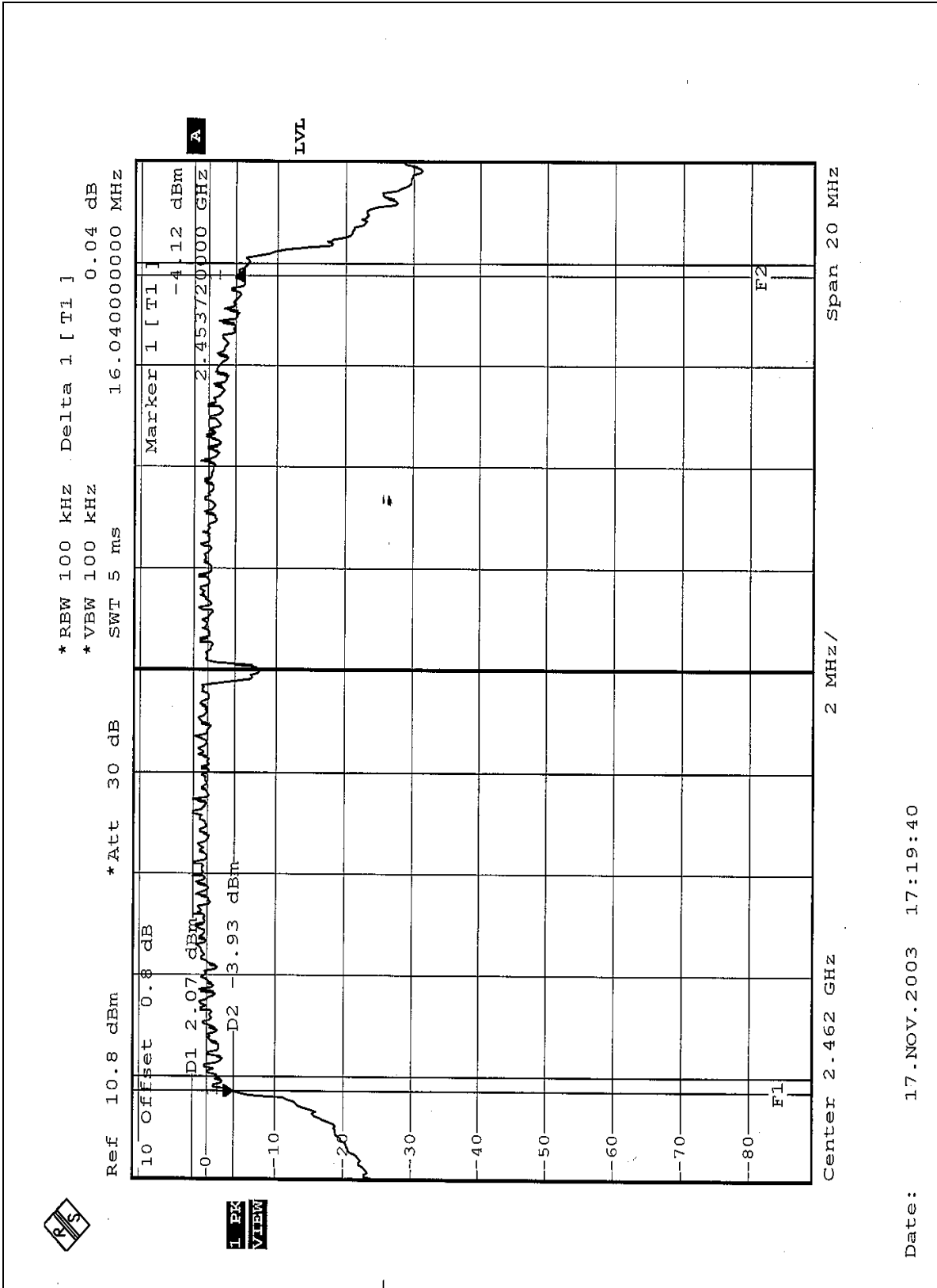

Date: 17.NOV.2003 17:19:40



#### 4.4 MAXIMUM PEAK OUTPUT POWER

##### 4.4.1 LIMITS OF MAXIMUM PEAK OUTPUT POWER MEASUREMENT

The Maximum Peak Output Power Measurement is 30dBm.

##### 4.4.2 TEST INSTRUMENTS

| Description & Manufacturer | Model No. | Serial No. | Calibrated Until |
|----------------------------|-----------|------------|------------------|
| R&S SPECTRUM ANALYZER      | FSEK30    | 100049     | Aug. 12, 2004    |
| R&S SIGNAL GENERATOR       | SMP04     | 100011     | May 28, 2004     |
| TEKTRONIX OSCILLOSCOPE     | TDS 220   | B048470    | Mar. 05, 2004    |
| NARDA DETECTOR             | 4503A     | FSCM99899  | NA               |

**NOTE:** The calibration interval of the above test instruments is 12 months and the calibrations are traceable to NML/ROC and NIST/USA..



#### 4.4.3 TEST PROCEDURES

1. A detector was used on the output port of the EUT. An oscilloscope was used to read the response of the detector.
2. Replaced the EUT by the signal generator. The center frequency of the S.G was adjusted to the center frequency of the measured channel.
3. Adjusted the power to have the same reading on oscilloscope. Record the power level.

#### 4.4.4 DEVIATION FROM TEST STANDARD

No deviation

#### 4.4.5 TEST SETUP



#### 4.4.6 EUT OPERATING CONDITIONS

Same as Item 4.3.6.



## 4.4.7 TEST RESULTS

|                                 |                             |                             |               |
|---------------------------------|-----------------------------|-----------------------------|---------------|
| <b>EUT</b>                      | 802.11g Wireless Lan Router | <b>MODEL</b>                | GL2454RT-NM   |
| <b>MODE</b>                     | CCK                         | <b>INPUT POWER (SYSTEM)</b> | 120Vac, 60 Hz |
| <b>ENVIRONMENTAL CONDITIONS</b> | 23deg. C, 65%RH, 991hPa     | <b>TESTED BY</b>            | Steven Lu     |

| <b>CHANNEL</b> | <b>CHANNEL FREQUENCY (MHz)</b> | <b>PEAK POWER OUTPUT (dBm)</b> | <b>PEAK POWER LIMIT (dBm)</b> | <b>PASS/FAIL</b> |
|----------------|--------------------------------|--------------------------------|-------------------------------|------------------|
| 1              | 2412                           | 19.17                          | 30                            | PASS             |
| 6              | 2437                           | 19.23                          | 30                            | PASS             |
| 11             | 2462                           | 19.42                          | 30                            | PASS             |

|                                 |                             |                             |               |
|---------------------------------|-----------------------------|-----------------------------|---------------|
| <b>EUT</b>                      | 802.11g Wireless Lan Router | <b>MODEL</b>                | GL2454RT-NM   |
| <b>MODE</b>                     | OFDM                        | <b>INPUT POWER (SYSTEM)</b> | 120Vac, 60 Hz |
| <b>ENVIRONMENTAL CONDITIONS</b> | 23deg. C, 65%RH, 991hPa     | <b>TESTED BY</b>            | Steven Lu     |

| <b>CHANNEL</b> | <b>CHANNEL FREQUENCY (MHz)</b> | <b>PEAK POWER OUTPUT (dBm)</b> | <b>PEAK POWER LIMIT (dBm)</b> | <b>PASS/FAIL</b> |
|----------------|--------------------------------|--------------------------------|-------------------------------|------------------|
| 1              | 2412                           | 18.21                          | 30                            | PASS             |
| 6              | 2437                           | 18.90                          | 30                            | PASS             |
| 11             | 2462                           | 19.05                          | 30                            | PASS             |



## 4.5 POWER SPECTRAL DENSITY MEASUREMENT

### 4.5.1 LIMITS OF POWER SPECTRAL DENSITY MEASUREMENT

The Maximum of Power Spectral Density Measurement is 8dBm.

### 4.5.2 TEST INSTRUMENTS

| Description & Manufacturer | Model No. | Serial No. | Calibrated Until |
|----------------------------|-----------|------------|------------------|
| R&S SPECTRUM ANALYZER      | FSEK30    | 100049     | Aug. 12, 2004    |

**NOTE:** The calibration interval of the above test instruments is 12 months and the calibrations are traceable to NML/ROC and NIST/USA.

#### 4.5.3 TEST PROCEDURE

The transmitter output was connected to the spectrum analyzer through an attenuator, the bandwidth of the fundamental frequency was measured with the spectrum analyzer using 3kHz RBW and 30kHz VBW, set sweep time=span/3kHz. The power spectral density was measured and recorded. The sweep time is allowed to be longer than span/3KHz for a full response of the mixer in the spectrum analyzer.

#### 4.5.4 DEVIATION FROM TEST STANDARD

No deviation

#### 4.5.5 TEST SETUP

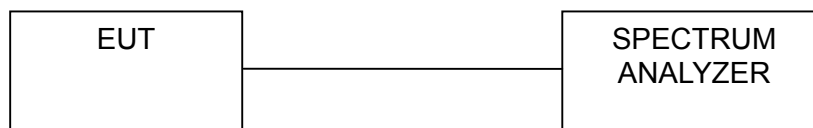

#### 4.5.6 EUT OPERATING CONDITIONS

Same as 4.3.6



## 4.5.7 TEST RESULTS

|                                 |                             |                             |               |
|---------------------------------|-----------------------------|-----------------------------|---------------|
| <b>EUT</b>                      | 802.11g Wireless Lan Router | <b>MODEL</b>                | GL2454RT-NM   |
| <b>MODE</b>                     | CCK                         | <b>INPUT POWER (SYSTEM)</b> | 120Vac, 60 Hz |
| <b>ENVIRONMENTAL CONDITIONS</b> | 23deg. C, 65%RH, 991hPa     | <b>TESTED BY</b>            | Steven Lu     |

| <b>CHANNEL</b> | <b>CHANNEL FREQUENCY (MHz )</b> | <b>RF POWER LEVEL IN 3kHz BW (dBm)</b> | <b>MAXIMUM LIMIT (dBm)</b> | <b>PASS/FAIL</b> |
|----------------|---------------------------------|--|----------------------------|------------------|
| 1              | 2412                            | -5.92                                  | 8                          | PASS             |
| 6              | 2437                            | -4.57                                  | 8                          | PASS             |
| 11             | 2462                            | -5.59                                  | 8                          | PASS             |



CH1

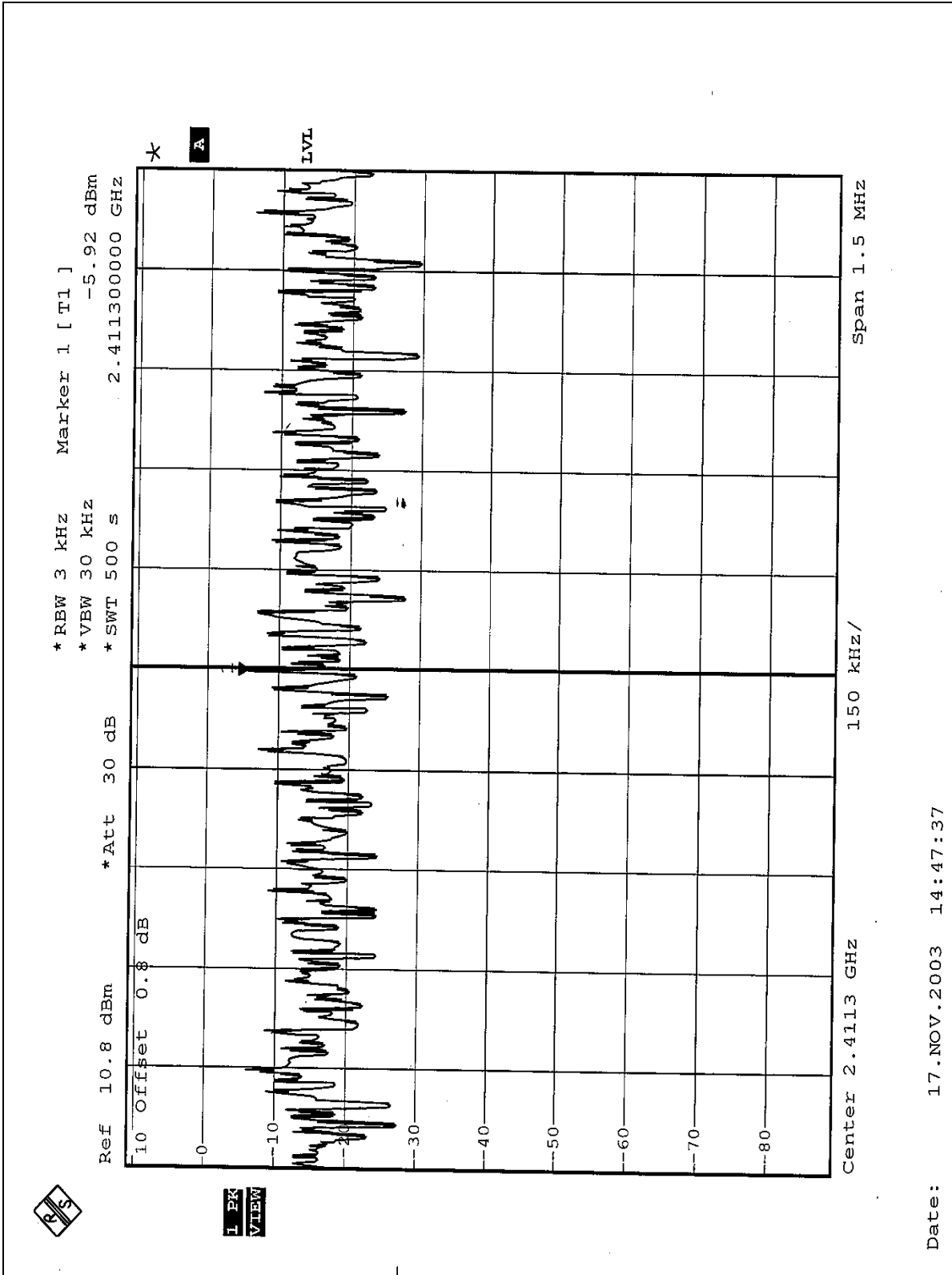

Date: 17.NOV.2003 14:47:37





CH6

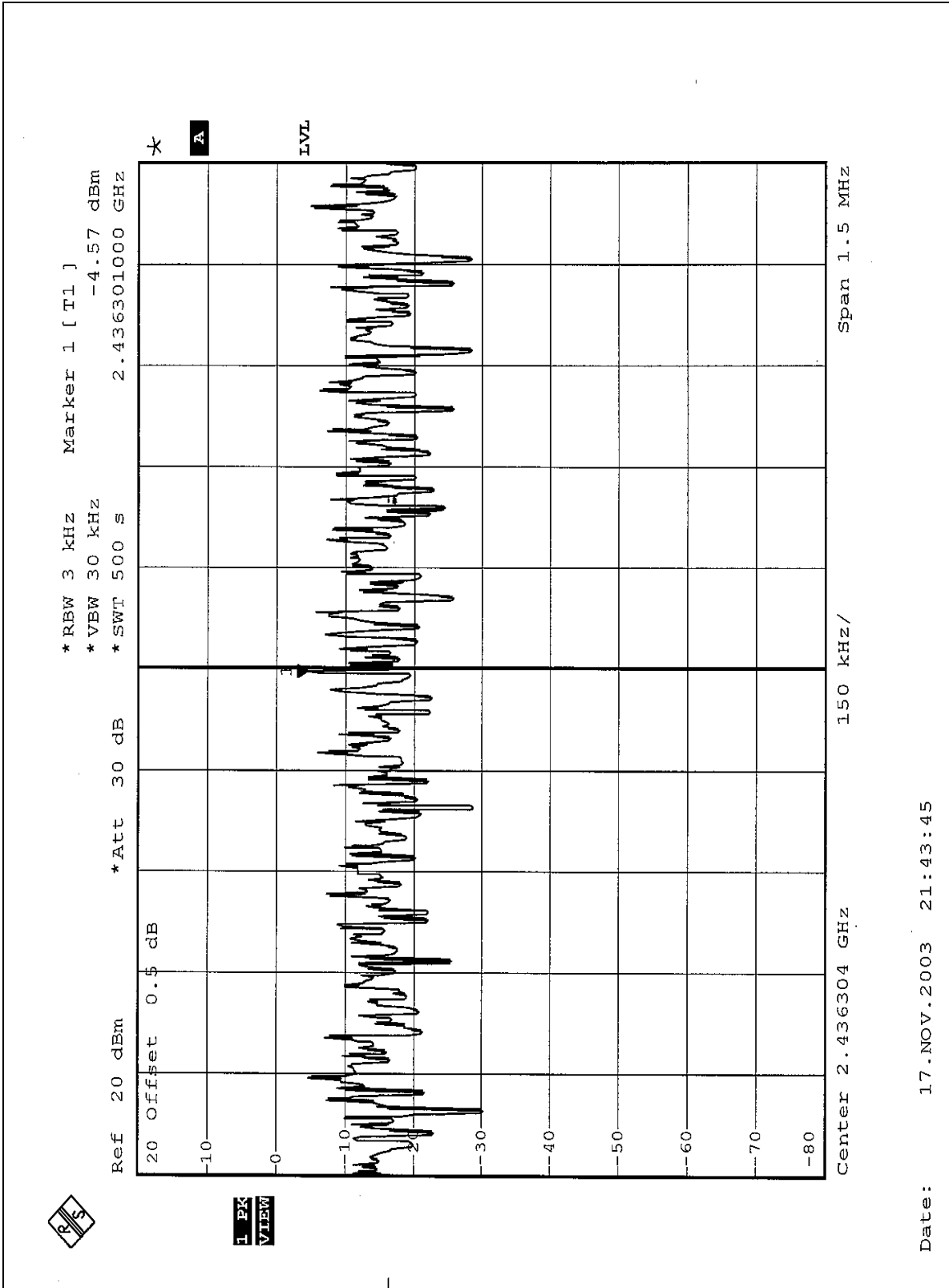



CH11

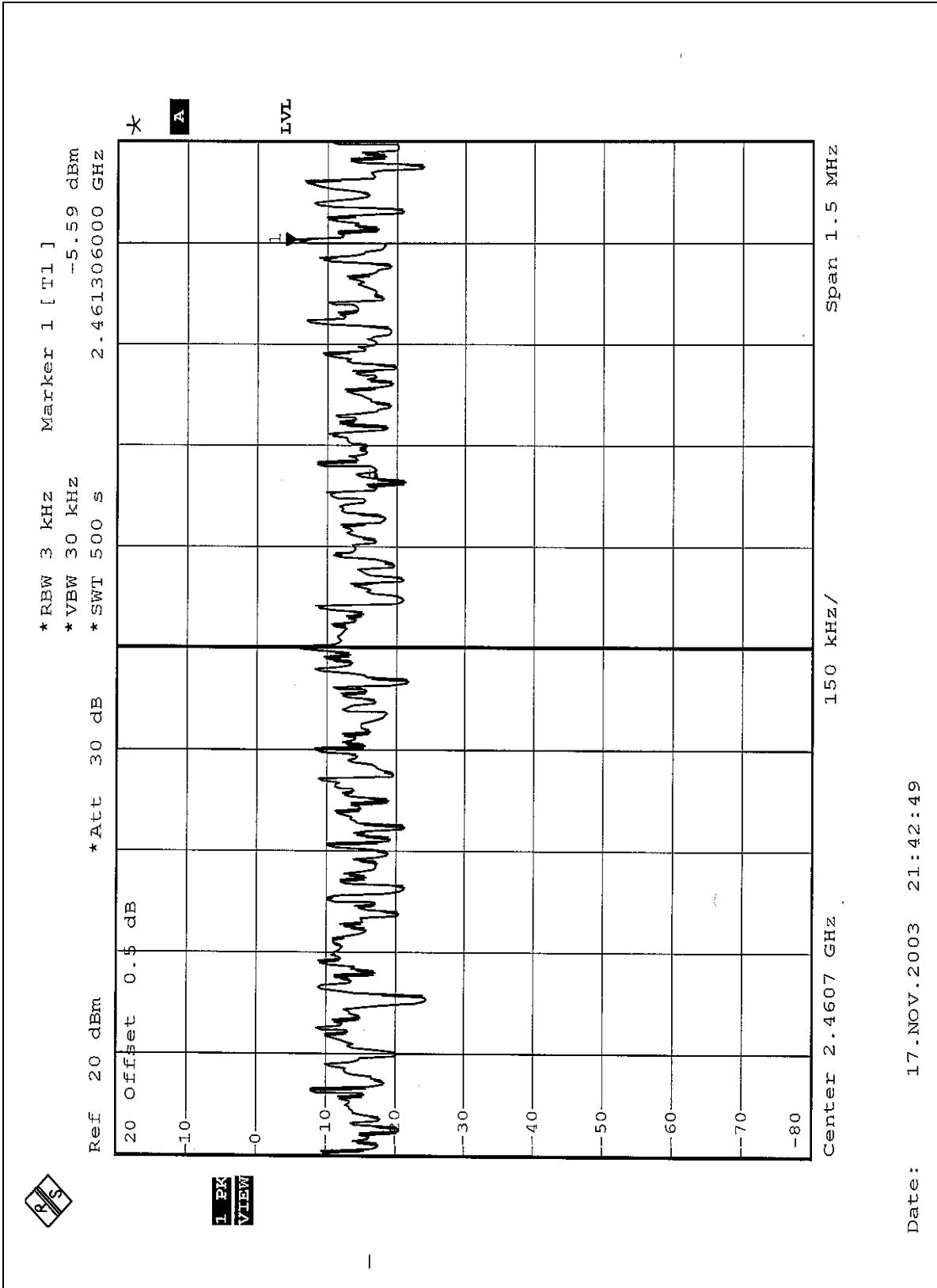

Date: 17.NOV.2003 21:42:49



|                                 |                             |                             |               |
|---------------------------------|-----------------------------|-----------------------------|---------------|
| <b>EUT</b>                      | 802.11g Wireless Lan Router | <b>MODEL</b>                | GL2454RT-NM   |
| <b>MODE</b>                     | OFDM                        | <b>INPUT POWER (SYSTEM)</b> | 120Vac, 60 Hz |
| <b>ENVIRONMENTAL CONDITIONS</b> | 23deg. C, 65%RH, 991hPa     | <b>TESTED BY</b>            | Steven Lu     |

| <b>CHANNEL</b> | <b>CHANNEL FREQUENCY (MHz )</b> | <b>RF POWER LEVEL IN 3kHz BW (dBm)</b> | <b>MAXIMUM LIMIT (dBm)</b> | <b>PASS/FAIL</b> |
|----------------|---------------------------------|--|----------------------------|------------------|
| 1              | 2412                            | -12.17                                 | 8                          | PASS             |
| 6              | 2437                            | -10.94                                 | 8                          | PASS             |
| 11             | 2462                            | -12.64                                 | 8                          | PASS             |



CH1

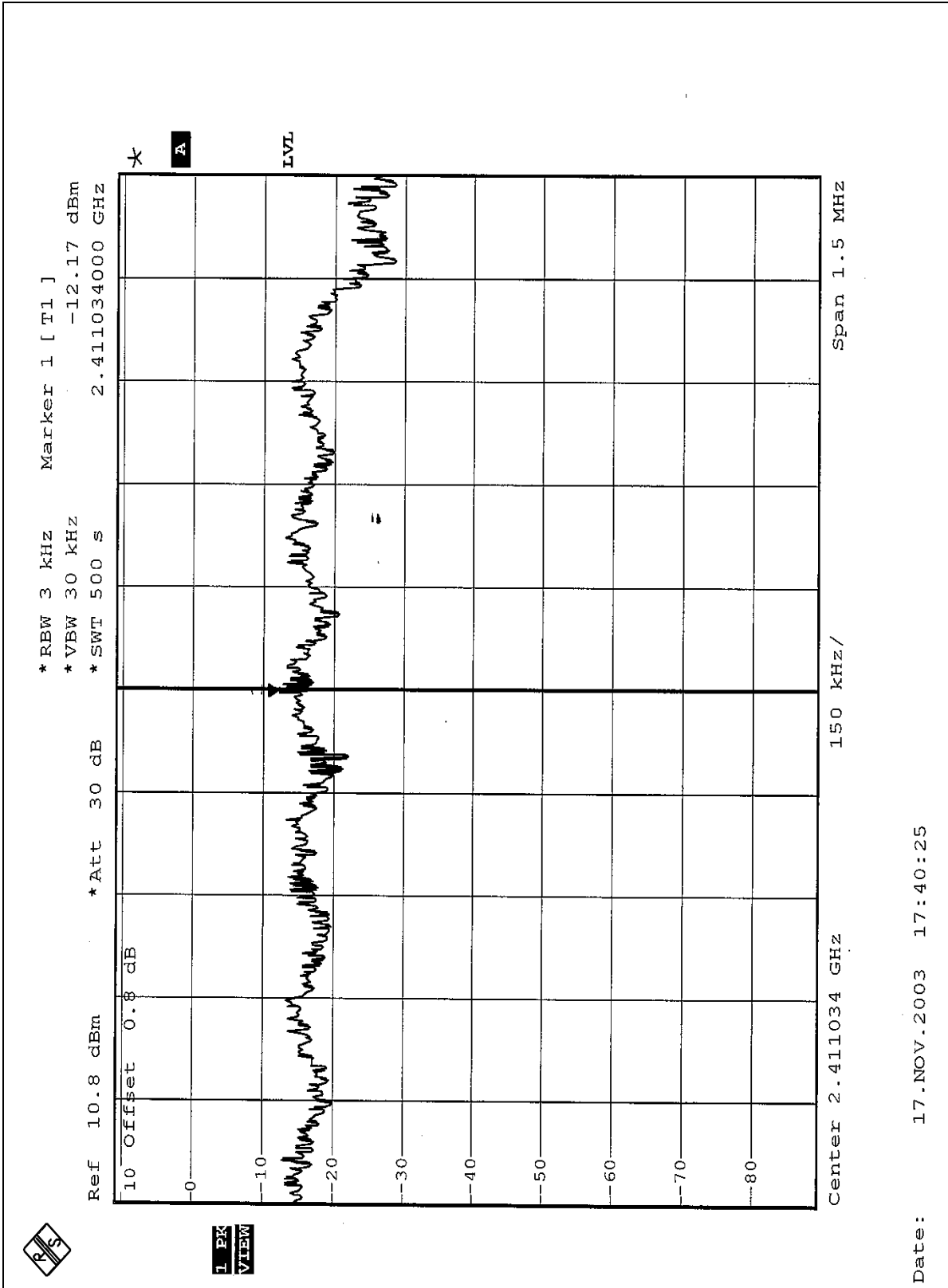

Date: 17.NOV.2003 17:40:25



CH6

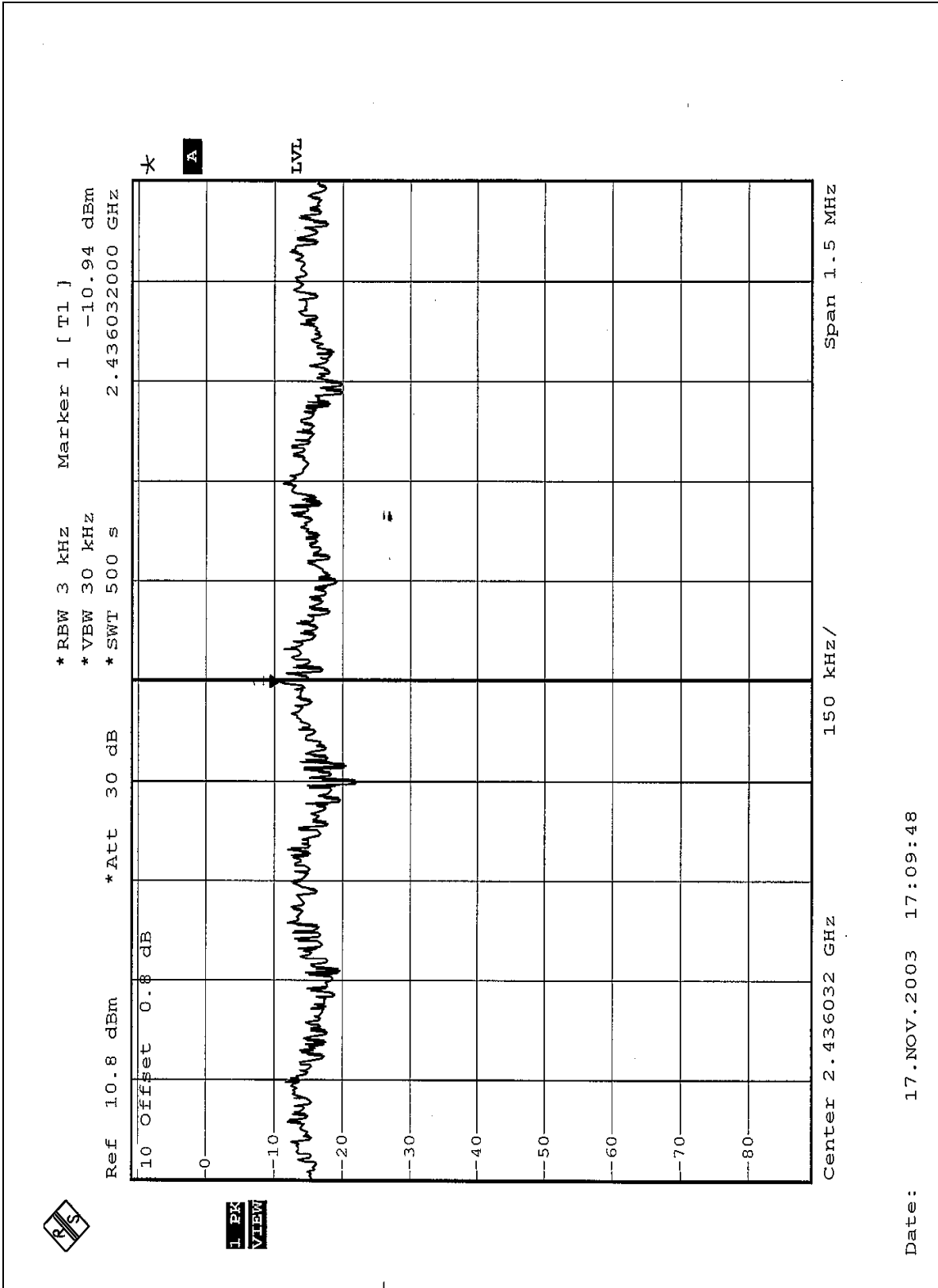



CH11

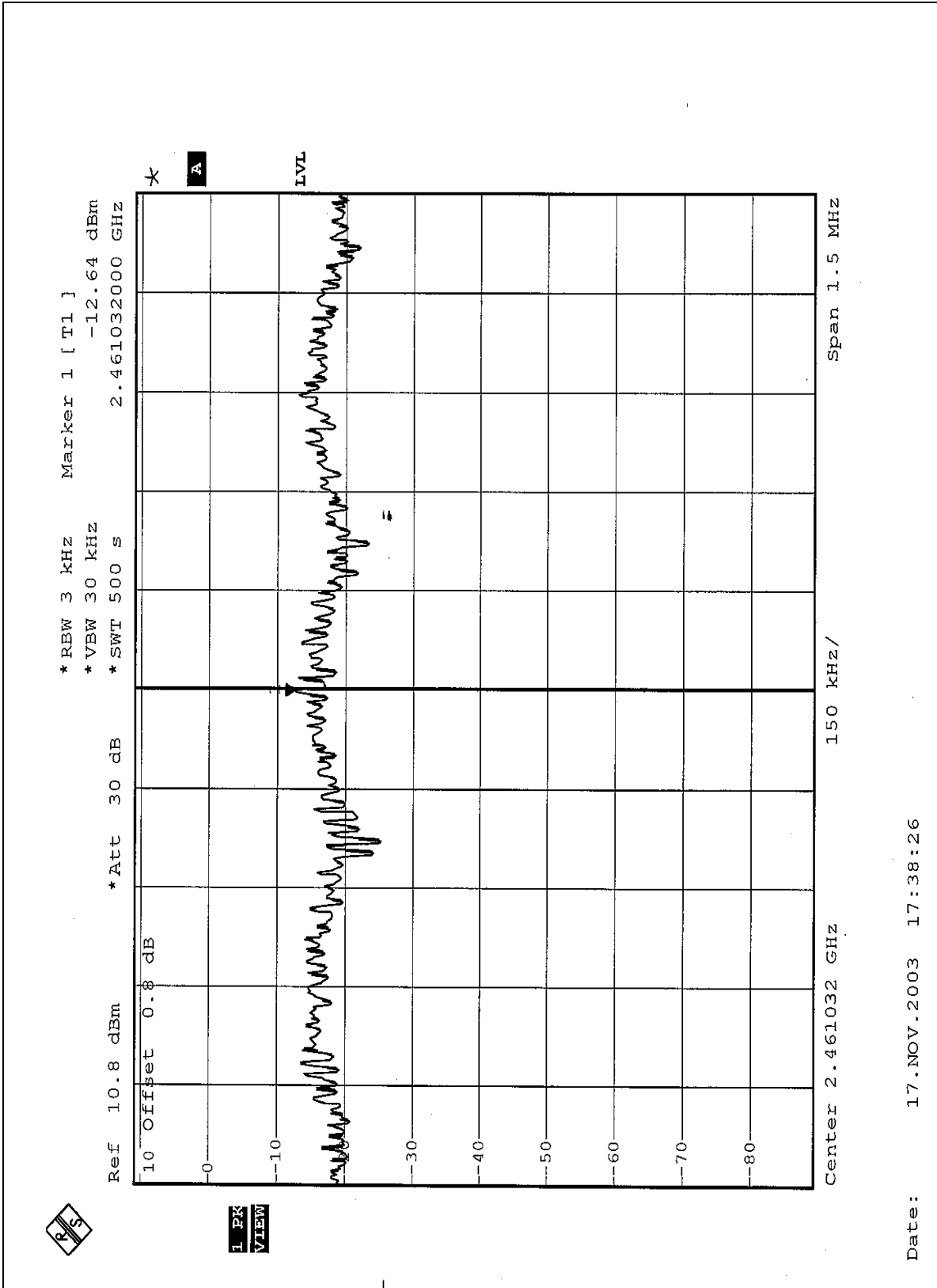

Date: 17.NOV.2003 17:38:26



## 4.6 BAND EDGES MEASUREMENT

### 4.6.1 LIMITS OF BAND EDGES MEASUREMENT

Below  $-20\text{dB}$  of the highest emission level of operating band (in 100KHz Resolution Bandwidth).

### 4.6.2 TEST INSTRUMENTS

| Description & Manufacturer | Model No. | Serial No. | Calibrated Until |
|----------------------------|-----------|------------|------------------|
| R&S SPECTRUM ANALYZER      | FSEK30    | 100049     | Aug. 12, 2004    |

**NOTE:** The calibration interval of the above test instruments is 12 months and the calibrations are traceable to NML/ROC and NIST/USA.

### 4.6.3 TEST PROCEDURE

The transmitter output was connected to the spectrum analyzer via a low lose cable. Set both RBW and VBW of spectrum analyzer to 100 kHz with suitable frequency span including 100 MHz bandwidth from band edge. The band edges was measured and recorded.

### 4.6.4 DEVIATION FROM TEST STANDARD

No deviation



#### 4.6.5 EUT OPERATING CONDITION

Same as Item 4.3.6

#### 4.6.6 TEST RESULTS

The spectrum plots are attached on the following 4 pages. D2 line indicates the highest level, D1 line indicates the 20dB offset below D2. It shows compliance with the requirement in part 15.247(C).

##### **NOTE 1:**

The band edge emission plot of the CCK technique on the following first pages show 57.42dB delta between carrier maximum power and local maximum emission in restrict band (2.3320GHz). The emission of carrier strength list in the test result of channel 1 at the item 4.2.7 is 107.16dBuV/m, so the maximum field strength in restrict band is  $107.16 - 57.42 = 49.74$ dBuV/m which is under 54dBuV/m limit.

The band edge emission plot of the CCK technique on the following second pages show 59.10dB delta between carrier maximum power and local maximum emission in restrict band (2.4859GHz). The emission of carrier strength list in the test result of channel 11 at the item 4.2.7 is 108.90dBuV/m, so the maximum field strength in restrict band is  $108.90 - 59.10 = 49.80$ dBuV/m which is under 54dBuV/m limit.

##### **NOTE 2:**

The band edge emission plot of the OFDM technique on the following third pages show 53.19dB delta between carrier maximum power and local maximum emission in restrict band (2.3900GHz). The emission of carrier strength list in the test result of channel 1 at the item 4.2.7 is 98.40dBuV/m, so the maximum field strength in restrict band is  $98.40 - 53.19 = 45.21$ dBuV/m which is under 54dBuV/m limit.

The band edge emission plot of the OFDM technique on the following fourth pages show 54.63dB delta between carrier maximum power and local maximum emission in restrict band (2.4859GHz). The emission of carrier strength list in the test result of channel 11 at the item 4.2.7 is 97.86dBuV/m, so the maximum field strength in restrict band is  $97.86 - 54.63 = 43.23$ dBuV/m which is under 54dBuV/m limit.



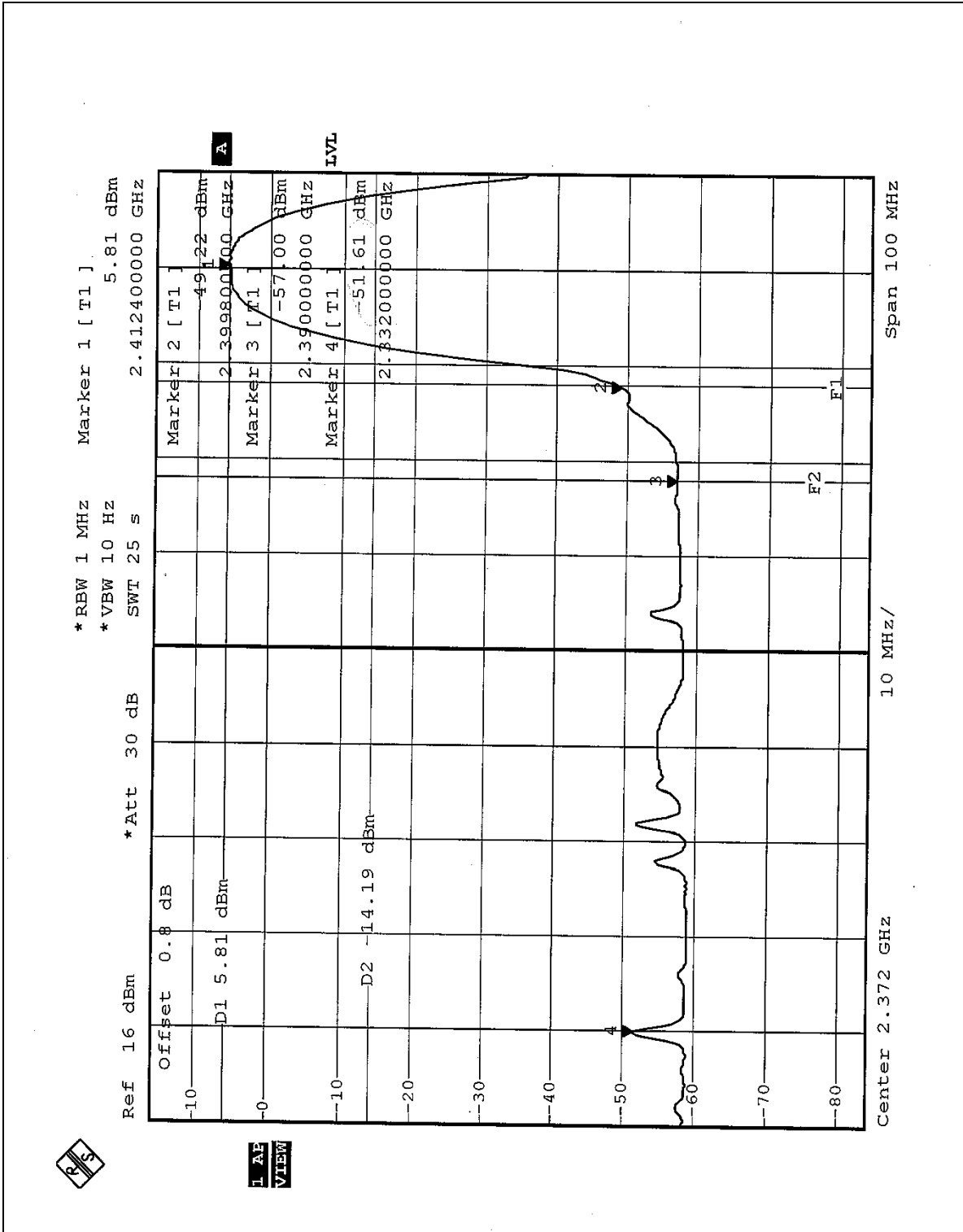

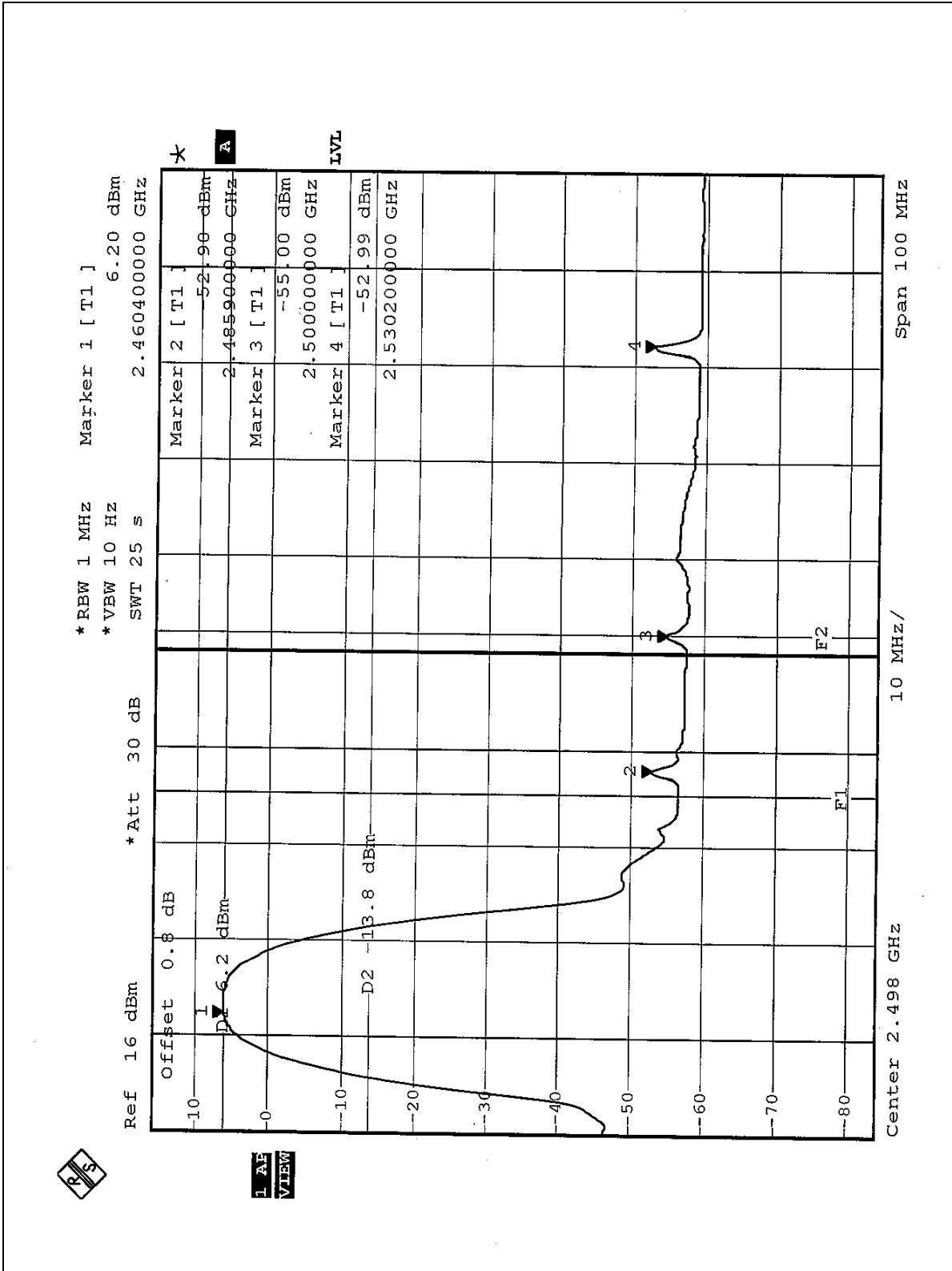

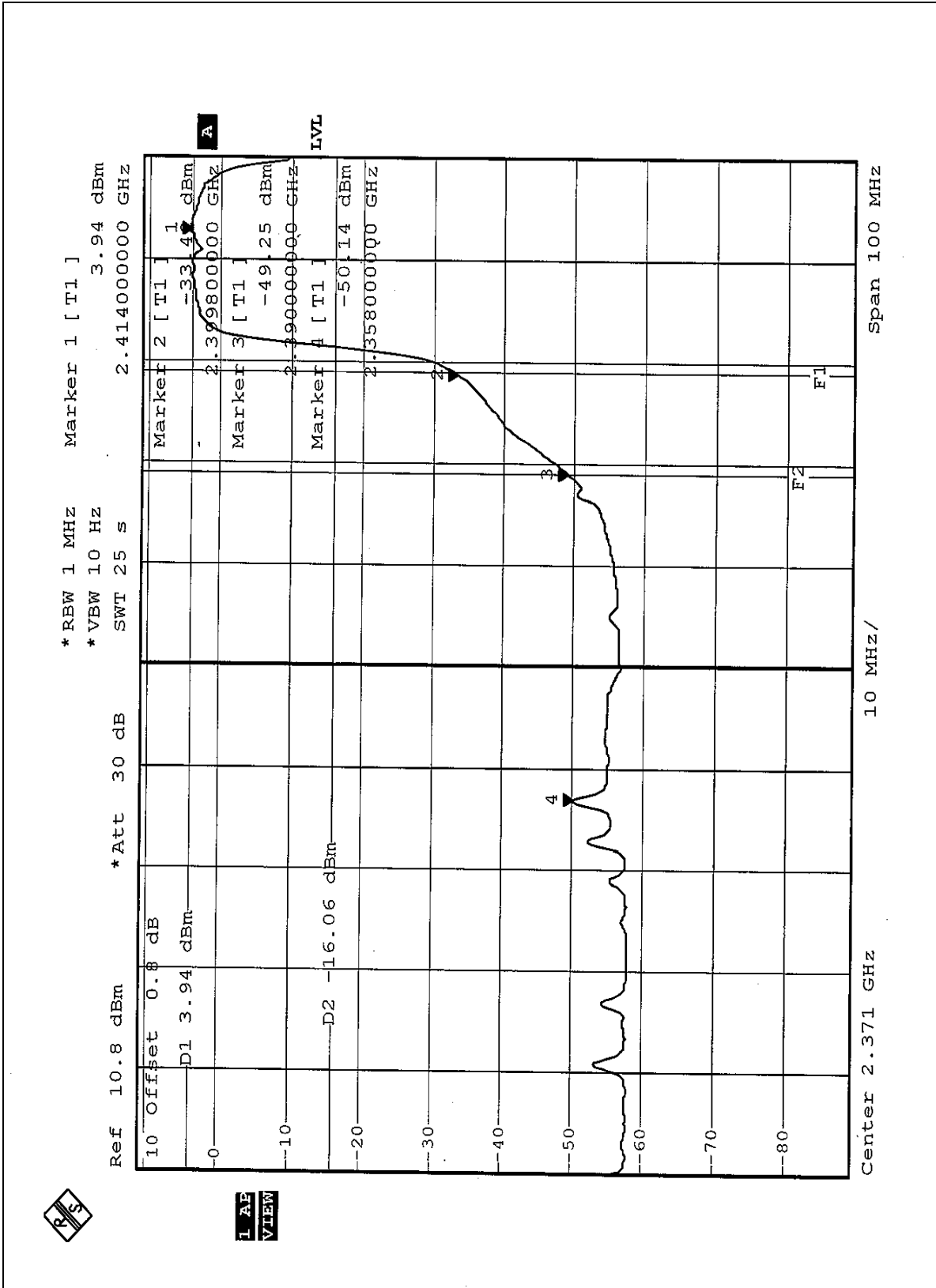

1. AF VIEW

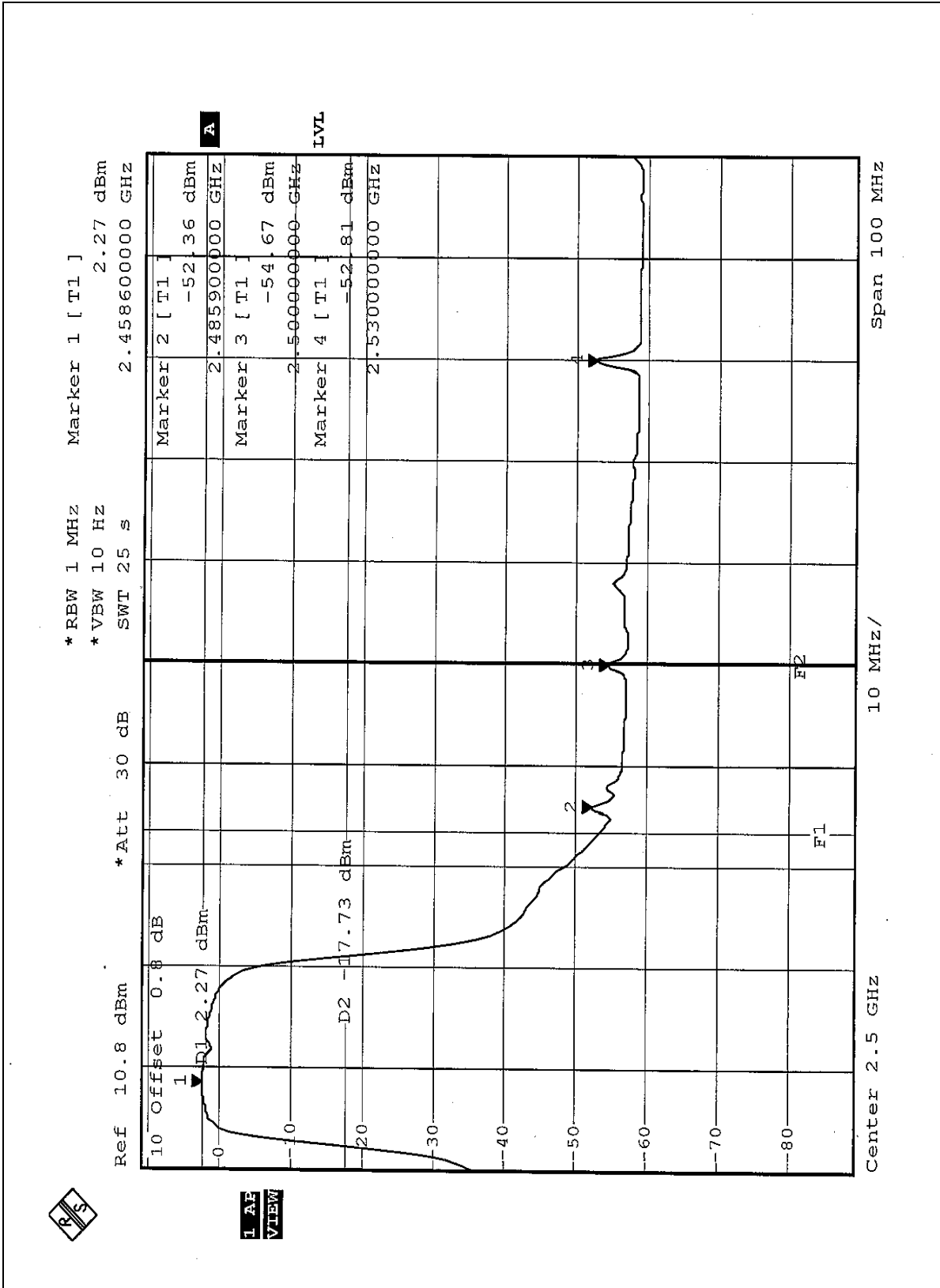



## **4.7 ANTENNA REQUIREMENT**

### **4.7.1 STANDARD APPLICABLE**

For intentional device, according to FCC 47 CFR Section 15.203, an intentional radiator shall be designed to ensure that no antenna other than that furnished by the responsible party shall be used with the device.

And according to FCC 47 CFR Section 15.247 (b), if transmitting antennas of directional gain greater than 6dBi are used, the power shall be reduced by the amount in dB that the directional gain of the antenna exceeds 6dBi.

### **4.7.2 ANTENNA CONNECTED CONSTRUCTION**

The antenna type used in this product is Dipole Antenna with Reverse SMA antenna connector. The maximum Gain of this antenna is only 2dBi.

## 5 PHOTOGRAPHS OF THE TEST CONFIGURATION

### CONDUCTED EMISSION TEST



### RADIATED EMISSION TEST





## 6 INFORMATION ON THE TESTING LABORATORIES

We, ADT Corp., were founded in 1988 to provide our best service in EMC and Safety consultation. Our laboratories are accredited and approved by the following approval agencies according to ISO/IEC 17025, Guide 25 or EN 45001:

|                    |                 |
|--------------------|-----------------|
| <b>USA</b>         | FCC, NVLAP      |
| <b>Germany</b>     | TUV Rheinland   |
| <b>Japan</b>       | VCCI            |
| <b>New Zealand</b> | MoC             |
| <b>Norway</b>      | NEMKO           |
| <b>R.O.C.</b>      | BSMI, DGT, CNLA |

Copies of accreditation certificates of our laboratories obtained from approval agencies can be downloaded from our web site:

[www.adt.com.tw/index.5/phtml](http://www.adt.com.tw/index.5/phtml).

If you have any comments, please feel free to contact us at the following:

**Lin Kou EMC Lab:**

Tel: 886-2-26052180

Fax: 886-2-26052943

**Hsin Chu EMC Lab:**

Tel: 886-35-935343

Fax: 886-35-935342

**Lin Kou Safety Lab:**

Tel: 886-2-26093195

Fax: 886-2-26093184

**Lin Kou RF&Telecom Lab**

Tel: 886-3-3270910

Fax: 886-3-3270892

**Email:** [service@mail.adt.com.tw](mailto:service@mail.adt.com.tw)

**Web Site:** [www.adt.com.tw](http://www.adt.com.tw)

The address and road map of all our labs can be found in our web site also.