

Airgain™



Coverage.
Performance.
Smart.

**Profile Series
N24X2H2YW**

**Airgain
Embedded
Antenna
Preliminary
Engineering
Data Sheet**

3611 Valley Centre Drive, Suite 150
San Diego, CA 92130 USA
Tel: +1 760 579 0200
Fax: +1 760 579 0892
Information: info@airgain.com
Sales: sales@airgain.com
Support: support@airgain.com

Revision History (Required)

Revision	Date	Note
915-02-00-001-1 Rev. 1.0	7/September/2016	Preliminary Datasheet 1.0
915-02-00-001-1 Rev. 1.1	10/November/2016	Update Radiation Patterns

Preliminary

Contents

1. Airgain N24X2H2YW Embedded Antenna.....	4
2. Features.....	4
3. Specifications and Interface.....	5
4. Radiation Patterns.....	5
5. Dimensions.....	8
6. ROHS.....	8
7. Feature and Options Information.....	8
7.1 Part Number Conventions.....	9
7.2 Part Number Example.....	9
8. Cable Data Sheet.....	10

Figures

Figure 1: Model N24X2H2YW Embedded Antenna.....	4
Figure 2: Model N24X2H2YW Measurement axes.....	5
Figure 3: Model N24X2H2YW Measured Radiation Patterns at 2.44 GHz.....	6
Figure 4: Model N24X2H2YW Measured Radiation Patterns at 2.44 GHz.....	6
Figure 5: Model N24X2H2YW Measured Radiation Patterns at 2.44 GHz.....	7
Figure 6: Model N24X2H2YW Embedded Antenna Dimensions.....	8
Figure 7: N24X2H2YW with connector or stripped cable.....	9

1. Airgain N24X2H2YW Embedded Antenna.

The Model N24X2H2YW Embedded Antenna provides a high efficiency, 2.4GHz single band embedded antenna solution for Wi-Fi and ISM band applications, such as WLAN products. As embedded antenna solutions become the focus of next generation wireless product design, the Model N24X2H2YW provides the flexibility of an embedded antenna with top performance. The Model N24X2H2YW Embedded Antenna was designed to accommodate most WLAN access point applications, such as routers and gateways. The product can be easily integrated onto a board or into an ID package design.

2. Features

The Model N24X2H2YW Embedded Antenna is defined by the following features:

- IEEE 802.11 b/g/n standards
- Single 2.4GHz Band operation
- Case mount
- 1.02 dBi @ 2.40 GHz; 1.15 dBi @ 2.44 GHz; 1.02 dBi @ 2.49 GHz peak gain
- High efficiency
- Quick integration

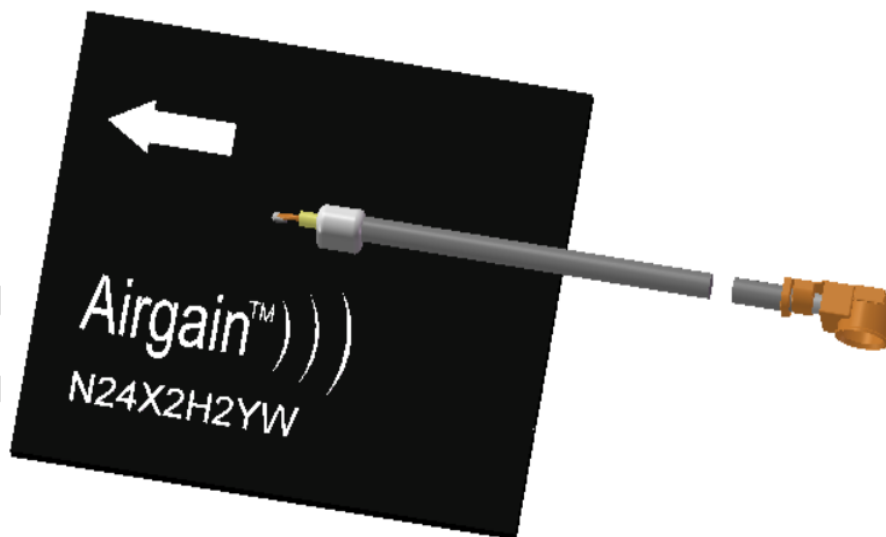

Figure 1: Model N24X2H2YW Embedded Antenna

3. Specifications and Interface

Standard	IEEE 802.11 b/g/n
Frequency range	2.4 to 2.49 GHz
Peak gain	1.02 dBi @ 2.40 GHz; 1.15 dBi @ 2.44 GHz; 1.02 dBi @ 2.49 GHz
VSWR	< 2:1
Feed impedance	50 ohms
Power handling	30 dBm
Interface	50 ohms, 1.13 mm diameter, micro coax cable (available with optional U.FL-compatible cable connector and/or cable-mounted EMI ferrites)
Antenna dimensions	24.6 x 20.5 x 0.8 (mm)
Weight	0.89g (0.031oz)
Temperature range	Operating: -40° C to +75° C (-40° F to +167° F) Storage: -40° C to +85° C (-40° F to +185° F)
Humidity range	0% to 95% non-condensing

4. Radiation Patterns

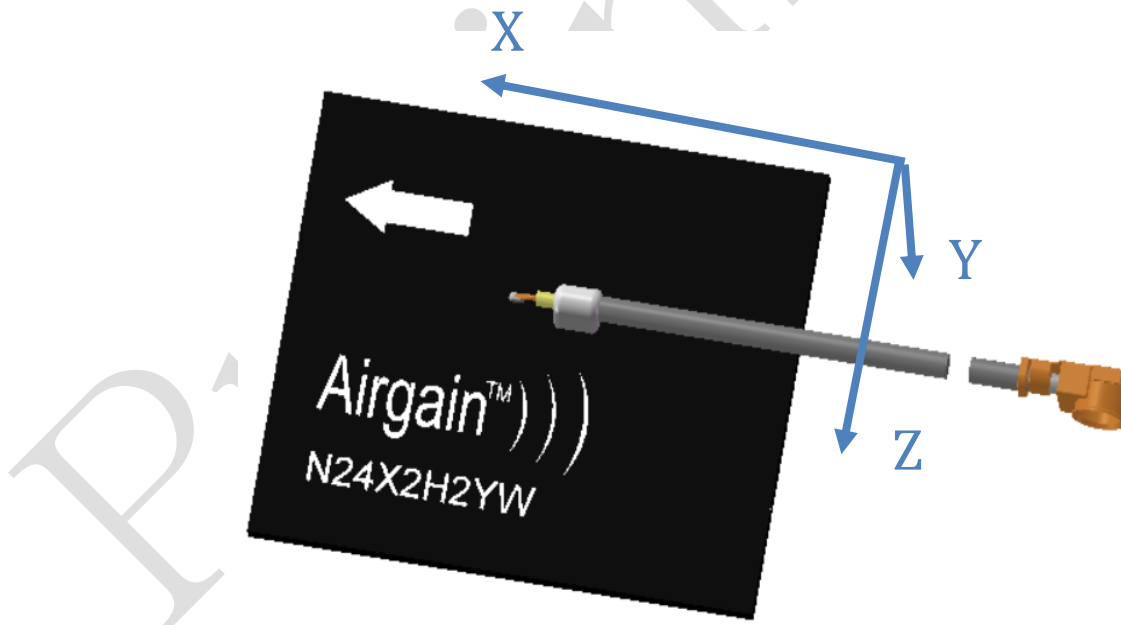

Figure 2: Model N24X2H2YW Measurement axes

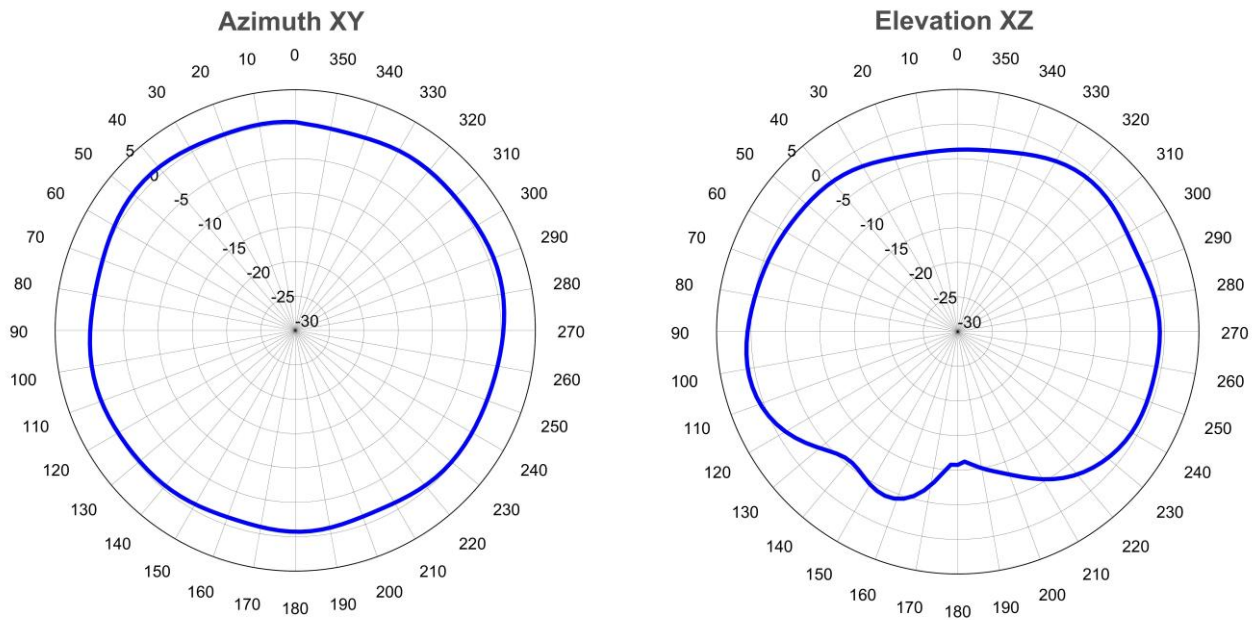

Figure 3: Model N24X2H2YW Measured Radiation Patterns at 2.44 GHz

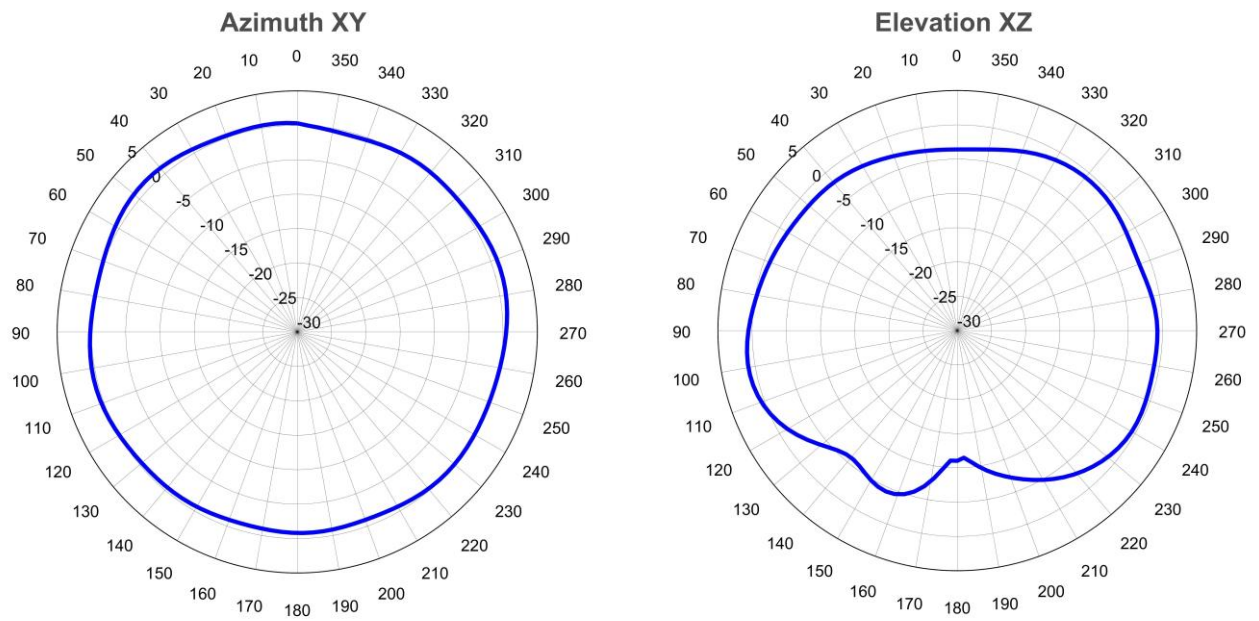

Figure 4: Model N24X2H2YW Measured Radiation Patterns at 2.44 GHz

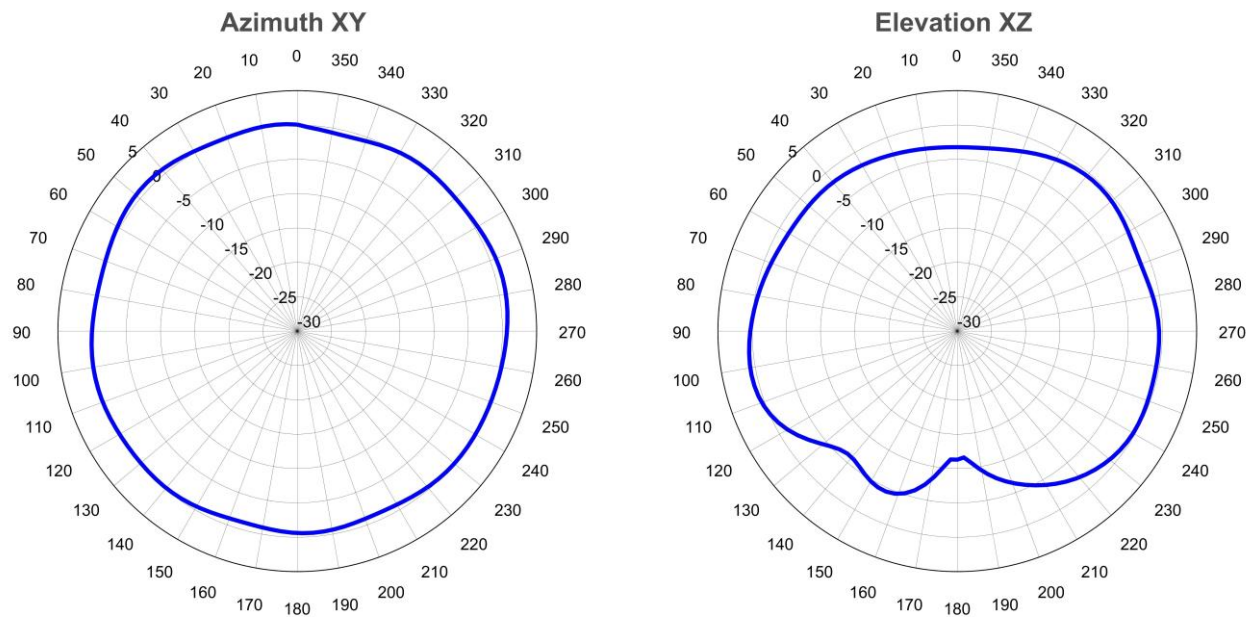
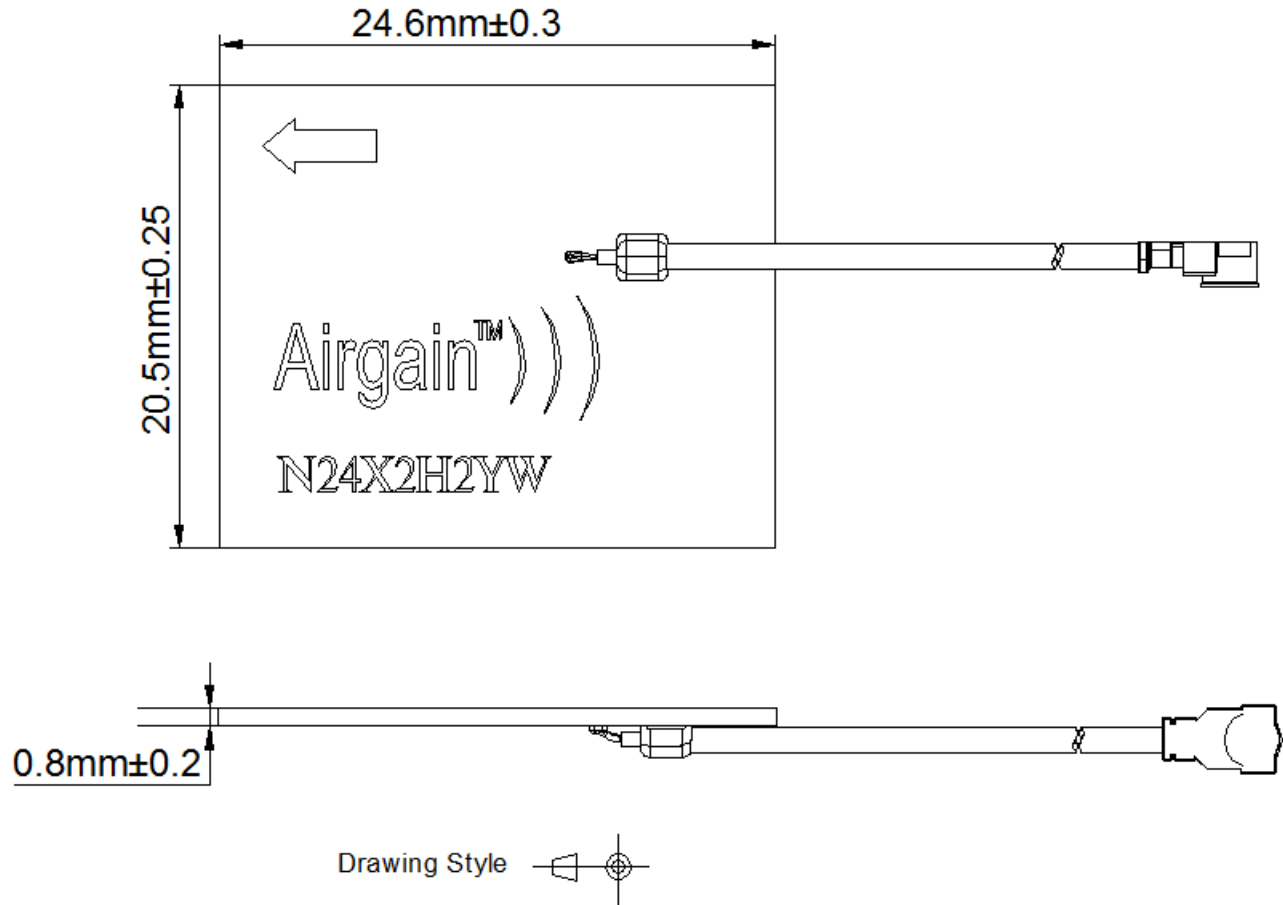

Figure 5: Model N24X2H2YW Measured Radiation Patterns at 2.44 GHz

Preliminary

5. Dimensions



Unless otherwise specified tolerances are $\pm 0.2\text{mm}$

Figure 6: Model N24X2H2YW Embedded Antenna Dimensions

6. ROHS

Airgain N24X2H2YW embedded antennas are RoHS compliant.

7. Feature and Options Information

Airgain N24X2H2YW antennas are equipped with an RF cable I/O interface. Optional cable termination such as U.FL-compatible micro coax connectors and cable mounted EMI ferrite cores are available. To aid mounting the N24X2H2YW, pre-applied, double-sided adhesive tape is available on the N24X2H2YW-T Series.

7.1 Part Number Conventions

Airgain uses a six-staged standard number system for our part numbers, which serially define the antenna type, tape type, packaging type, cable type/length, and connector type/interface, as described below:

Antenna #	Tape type -XX (if required)	Packaging type -XX	Cable Assembly Type -xxxxxx		
			Cable color-X	Cable length XXX	Connector type XX (if required)
N24X2H2YW	Blank = No tape T = Tape on bottom of element	Blank= parts shipped in panels of 20 pieces PK1= singulated (individual) antennas	G = Grey (Standard) B = Black (Non Standard) W =White (Non Standard) A = Blue(Non Standard)	Cable length in millimeters (mm) Commonly used Lengths*: 65, 100, 130, 150, 190, 230, 250, 300,400, etc.	Blank = Stripped Cable U = U.FL connector C = U.FL connector plus Ferrite Core, core size: 3.5mm * 9.0mm * 1.5mm CS = stripped cable plus Ferrite Core, core size: 3.5mm * 9.0mm * 1.5mm

* Standard cable lengths listed in RF Cable Datasheet

7.2 Part Number Example

N24X2H2YW-T-G100U – N24X2H2YW antenna with 1.6-mm double-sided adhesive tape, 100-mm cable, and U.FL-compatible connector.

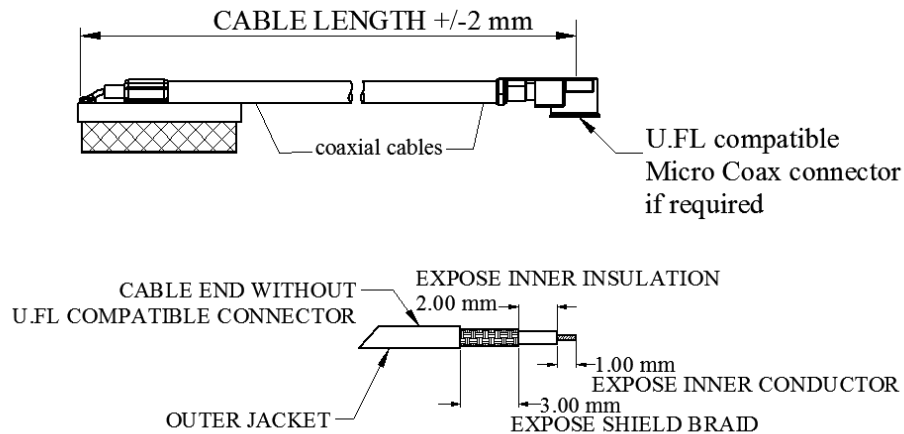
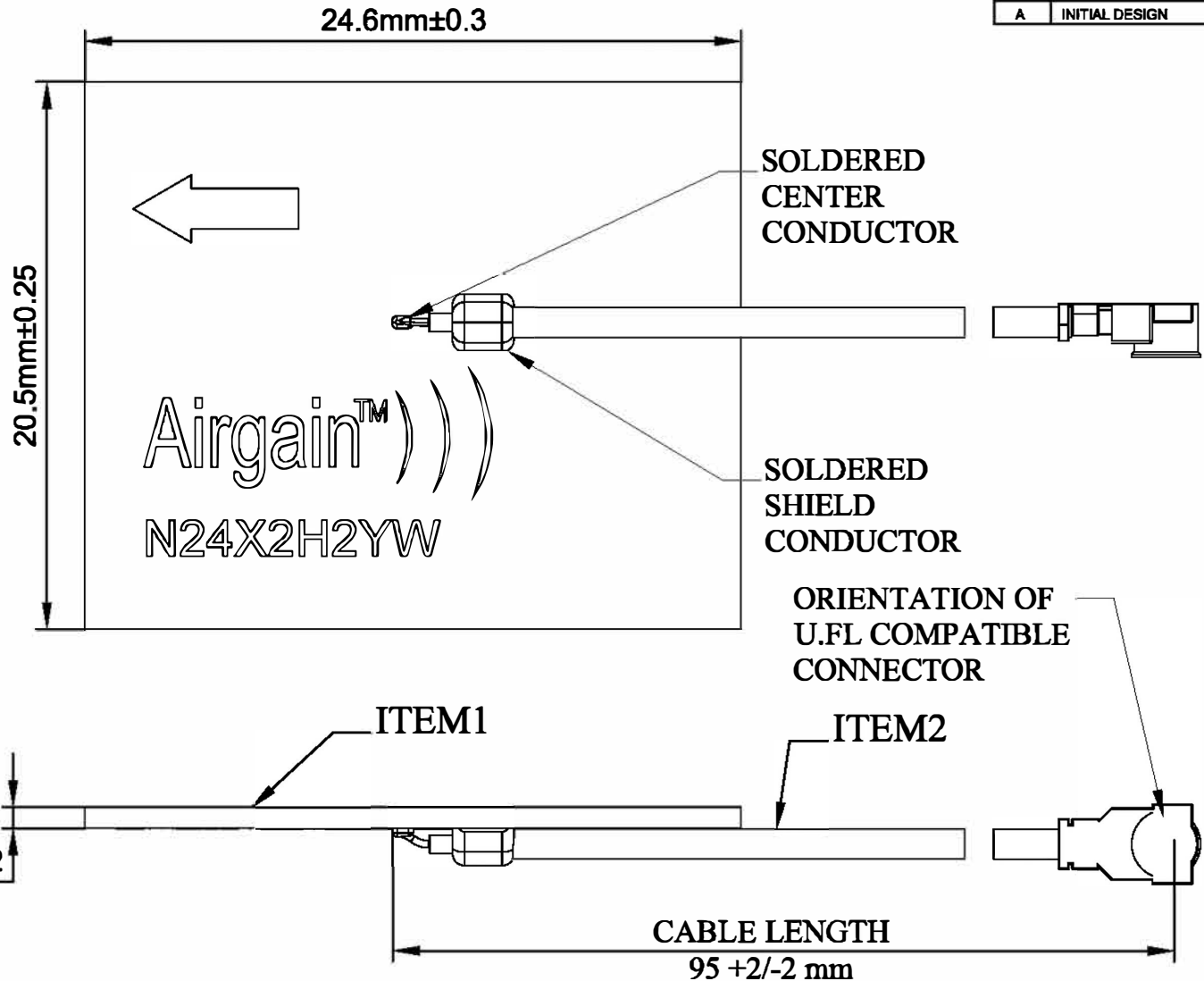

Figure 7: N24X2H2YW with connector or stripped cable

8. Cable Data Sheet

Item	Specification	
Cable type	OD1.13	
Impedance	50 ± 3 ohms	
Inner conductor	Material	Tin-coated copper
	Conductor numbers	7
	Conductor size	0.08 mm
	Outer diameter	0.24 ± 0.02 mm
Dielectric layer	Material	FEP
	Color	Clear
	Average thickness	0.22 mm
	Diameter	0.7 ± 0.03 mm
Braid (shielding)	Material	Tin-coated copper
	Conductor size: total / O.D. of every wire(mm)	16*4/0.05 mm
	Coverage	90%± 5%
	Diameter	0.92 ± 0.05 mm
Outer cover	Material	FEP
	Color	Black / white / grey
	Average thickness	0.10 mm
	Diameter	1.13 ± 0.05 mm
VSWR testing	< 1.3@0-6GHz	
Attenuation (dB/1meter)	1GHz	≤2.2
	2GHz	≤3.1
	3GHz	≤3.8
	4GHz	≤4.4
	5GHz	≤4.9
	6GHz	≤5.4
Operating temperature	-55°C~+150°C	

REV	DESCRIPTION	BY	DATE
A	INITIAL DESIGN	BWJ	7/NOV/2016



- Notes:**
 The processes used to assemble this antenna shall comply with the following specifications, unless otherwise specified.
 1. Solder: use lead free solder if applies for lead free soldering process to assemble the antenna, unless otherwise specified.
 2. Bom: use the bom file for assembling the antenna. this table is provided for reference only.
 3. Unless otherwise specified dimension, tolerances are +/-0.2mm
 4. Packaging type: parts shipped in panels of 25 pieces

ITEM#	DESIGNATOR	QUANTITY	NOTE
1	Antenna	1	
2	Coax Cable Assmby	1	Cable color is Black

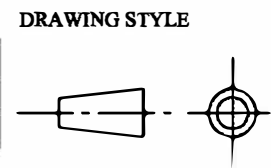

BOM No. 915-06-00-001-1	3611 Valley Centre Drive, Suite 150 San Diego, CA 92130 USA		Airgain™))
PCB No. 915-12-00-001-1	Project PROFILE EMBEDDED ANTENNA		
Drawn by BWJ	Date 7/November/2016	Title N24X2H2YW-B95U	
Checked by	Date	Size B	Number 915-14-00-001-3
Approved by	Date	Layer	Scale
		File	Sheet 1 of 1